

TCL

S55H

2.1 Channel Dolby Atmos Sound Bar with Wireless Subwoofer Quick Start Guide



1

Register Your Product

Register your TCL Sound Bar to receive the latest news on product releases, promotional offers, and more!*

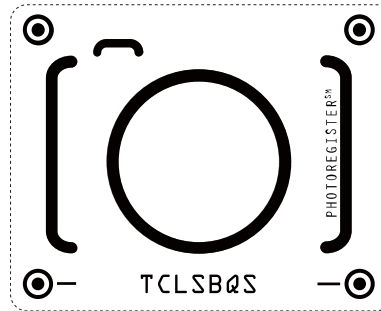

TEXT TO REGISTER

Text a photo of the camera icon to 71403

Or register online at register.tcl.com

Need help? Visit photoregister.com/help or text HELP to 71403

Enjoy exclusive benefits with registration:



Expedited support and service



Insider tips on your soundbar



Exclusive offers and promotions



Verification of ownership

*Only Available to U.S. Customers

2

What's in the box

Make sure you read all the safety information before you use this product.

User Manual can be found at www.tcl.com/us on the specific product page in the "Download" section.



Warning:
To avoid the danger of suffocation, keep plastic packaging away from pets, babies, and children. Do not use packaging bags in cribs, beds, carriages, or playpens.

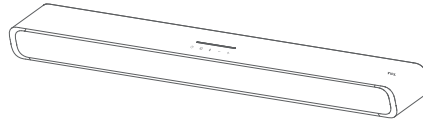

Sound Bar



Subwoofer

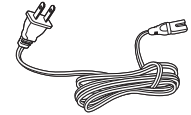

Power cord x 2
(Cable length: 4 ft. 11")



HDMI cable
(Cable length: 4 ft. 11")



Remote control



AAA battery x 2



Wall mount bracket x 2



Wall anchor x 2



Wall mounting screw x 2



Quick Start Guide

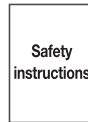

Safety leaflet



Warranty card

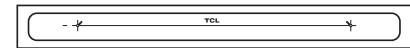

Wall mount template

Sound Bar

- ❶ AC input power connector
- ❷ AUX input connector
- ❸ HDMI eARC connector
- ❹ Optical input connector
- ❺ USB Type A connector

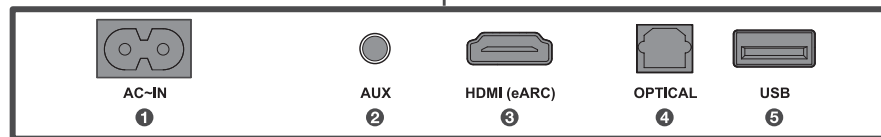
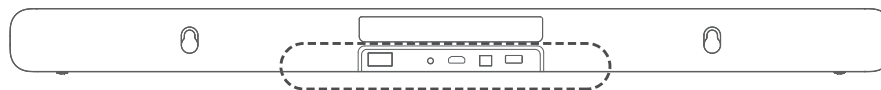

Source button:

Short press: Switch input sources

(HDMI eARC/Optical/AUX/USB/Bluetooth)

Long press: Enter subwoofer pairing

(If subwoofer disconnected)

Volume buttons:

Press to increase or decrease the volume level



Power button:

Short Press: Power On/Sleep

Long Press: Power Off

Bluetooth button:

Short Press: Select Bluetooth mode

Long press: Bluetooth Pairing

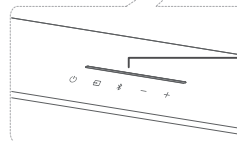
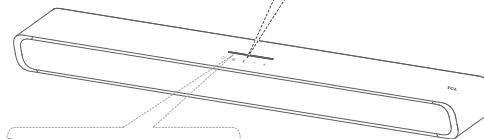

Input Source LED Indicator:

HDMI-eARC: Magenta

Optical: Yellow

AUX: Green

USB: Cyan



Bluetooth: Blue

3b

Overview

Wireless subwoofer

The subwoofer will pair automatically with sound bar upon the first use. In case of a problem, take the following steps to manually pair:

1. Press and hold the  button on the subwoofer for 2 seconds until an amber light begins flashing above the pair button.
2. Press and hold the  button on the sound bar for 5 seconds until a green LED indicator flashes on the sound bar. After a short while, the subwoofer LED will turn solid.
3. The subwoofer is now connected to the sound bar.

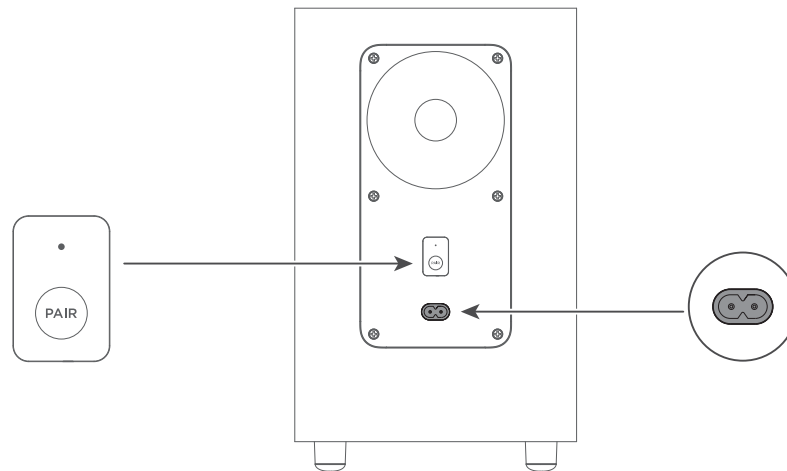

4

Sound Bar LED Display

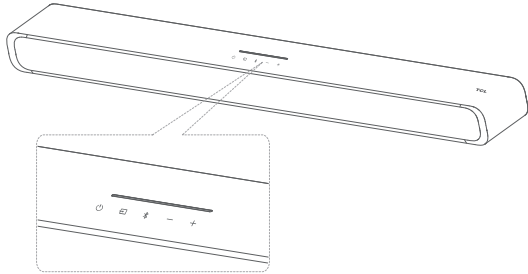

The LED display on the Sound Bar gives you information about the LED Behavior on Sound Bar.

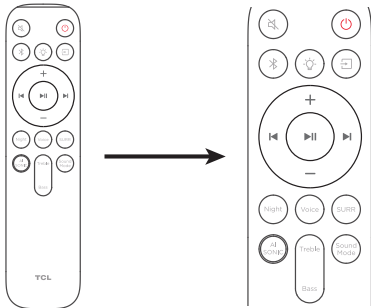

Remote Control	Soundbar Action	LED Behavior on Soundbar
	Power off/Sleep Power On	Power Off: All LEDs light turn on and turn off from the sides to the center. Power On: LEDs will turn on from the center to the sides.
	Mute sound	Mute On: Center LED will flash several times. Mute Off: Current Volume Level will be shown.
	Source	Input Source LED Indicator: HDMI eARC: Magenta Optical: Yellow Aux: Green USB: Cyan Bluetooth: Blue
	TBD	TBD
	Bluetooth Pairing	Blue LED will flash rapidly
	Volume up/down	Volume Up: LEDs will gradually turn on from the center to the sides Volume Down: LEDs will gradually turn off from the sides to the center
	Skip/Previous	Skip: LEDs move from the left to the right Previous: LEDs move from the right to the left
	TBD	TBD
	Voice Enhance	Long Press: Enter Voice Announcement Volume adjustment Use UP/DOWN keys to adjust three different levels: Mute/Default/High Short Press: Preset the current Voice Enhance level Use UP/DOWN keys to adjust four different levels.
	TBD	TBD
	Sound Mode	Press to switch sound mode in following order: Standard / Voice / Music / Movie / Game / Sports
	Treble Adjustment	Short Press: Show current Treble level. Increase/Decrease using UP/DOWN keys to adjust thirteen different levels.
	Bass Adjustment	Short Press: Show current Bass level. Increase/Decrease using UP/DOWN keys to adjust thirteen different levels.
	Sonic Default/1/2/3	Sonic1/Sonic2/Sonic3: LED light turn on from the side and move to the center Default: LED light turn off from the center to the sides

5a

Place your Sound Bar and Subwoofer

The ideal place to position the Sound Bar is centered underneath your TV.

 Note: Do not place your sound bar in a location exposed to direct sunlight, heat, fire, or moisture.

Top View

Sound Bar on the table

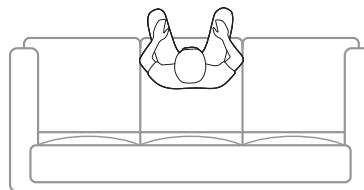

5b

Wall mount your Sound Bar

Required tools:

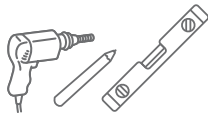

- 1 Place the supplied wall mount template on the wall. Make sure the wall mount template is at least 2 inches below the center of the TV.
- 2 Use a level to make sure the wall mount template is positioned accurately
- 3 Use the tape to stick the wall mount template firmly on the wall.
- 4 Mark on the wall using each marking on the template through the mounting holes.
- 5 Take away the wall mount template.
- 6 Drill a screw hole at each marking on the wall.

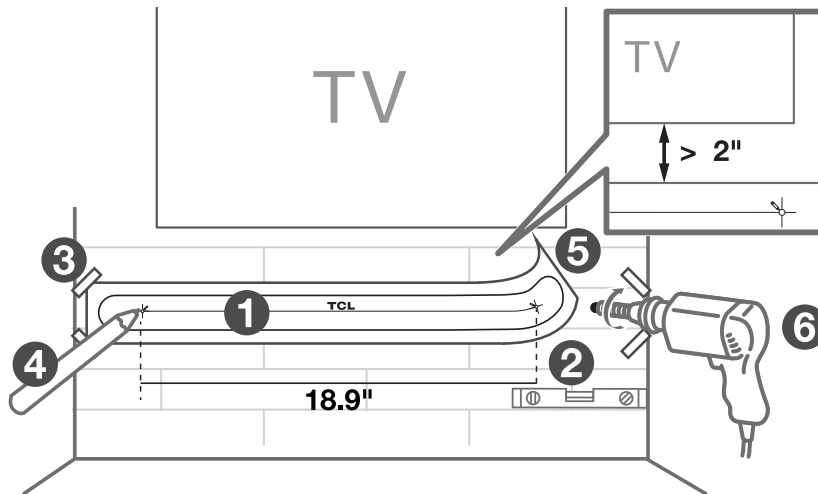

5c

Wall mount your Sound Bar

Required tools:



- 7 Insert the wall anchors in the holes on the wall.
- 8 Insert the supplied screws with the wall brackets into the hole of the wall anchors.
- 9 Fix and tighten the wall bracket screws on the wall. (keep space between the screw cap and the brackets)
- 10 Pick up the sound bar and attach it to the wall screws, similar to how you would hang a picture. Make sure everything is tight.



Note:

Do not place your sound bar in a location exposed to direct sunlight, heat, fire, or moisture. Only suitable for mounting at heights: < 6 ft. 6.7 in.

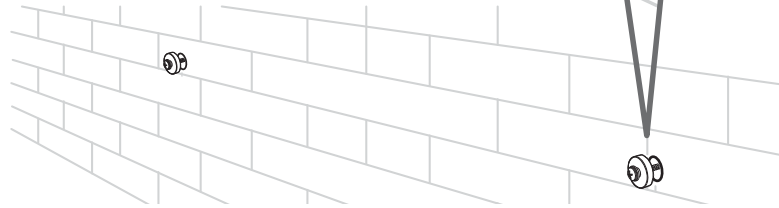
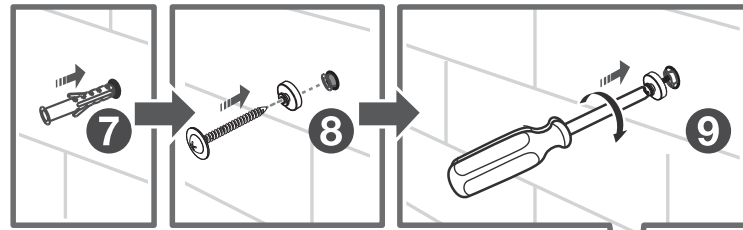

10

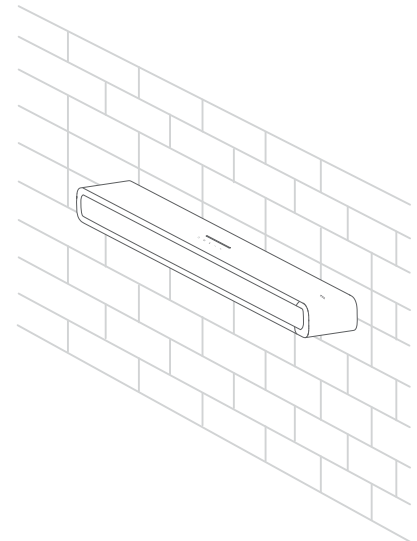
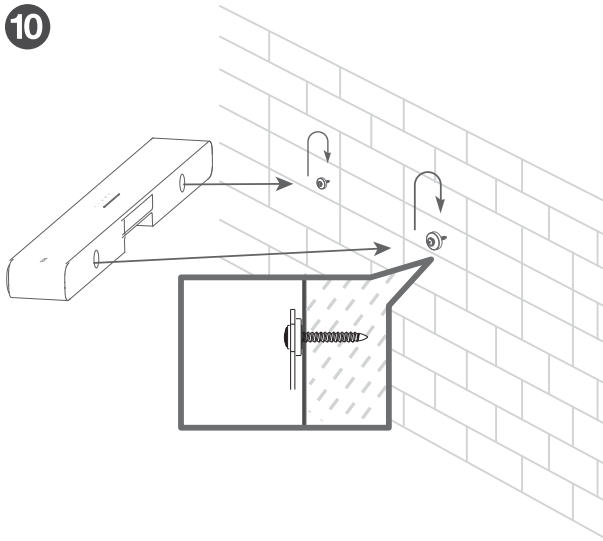

6a

Install or replace the remote batteries

Battery type: 1.5V AAA battery x 2

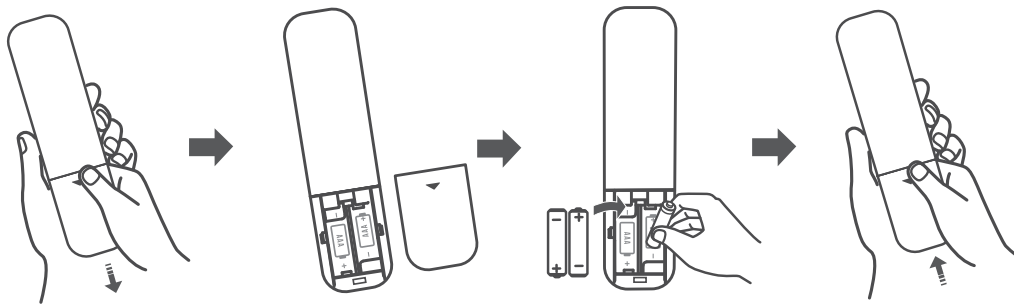

6b

Use the Remote



Warning: Do not expose batteries to excessive heat such as sunshine, fire, or the like. Keep new and used batteries away from children. For disposal or recycling information, please contact your local authorities.



CAUTION: Danger of explosion if the battery is incorrectly replaced. Replace only with the same or equivalent type.

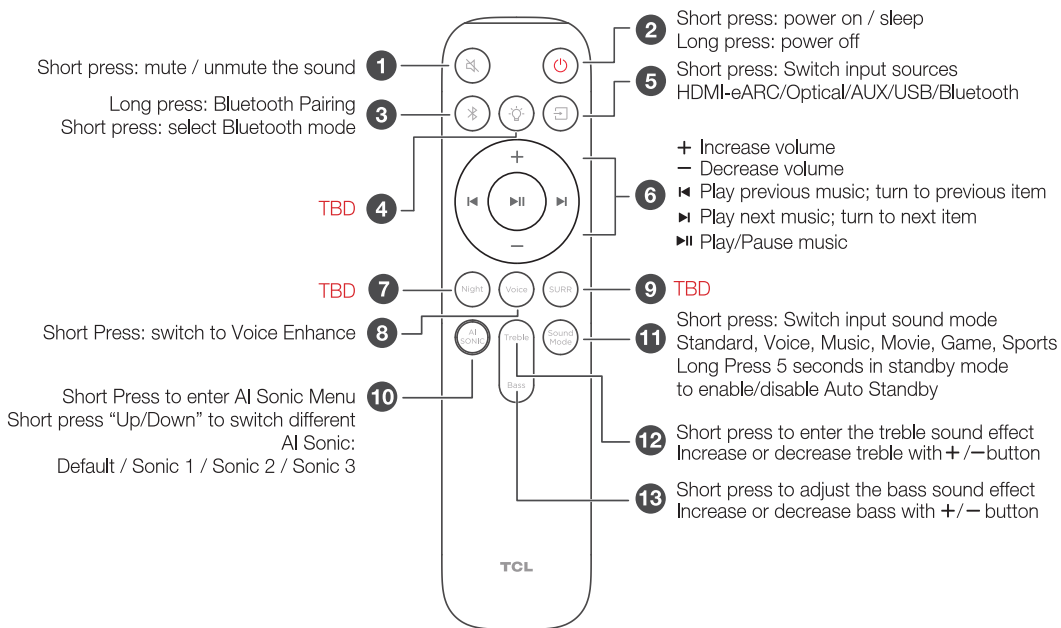

7

Connect to your TV

There are 2 ways to connect your sound bar to the TV (listed in order that we recommend): HDMI eARC (refer to 7a), and Optical (refer to 7b).

If you have a TCL/Roku TV™, simply plug in the HDMI cable to the ARC ports and follow the Roku TV Ready™ on-screen instructions.



This function is available in some TCL TVs and some TCL models.



- ✓ Simple setup
- ✓ One remote
- ✓ Quick settings

7a

HDMI (eARC)

Connect the Sound Bar to your TV with the included HDMI cable.

Connect the Sound Bar to the power outlet with the included power cord.

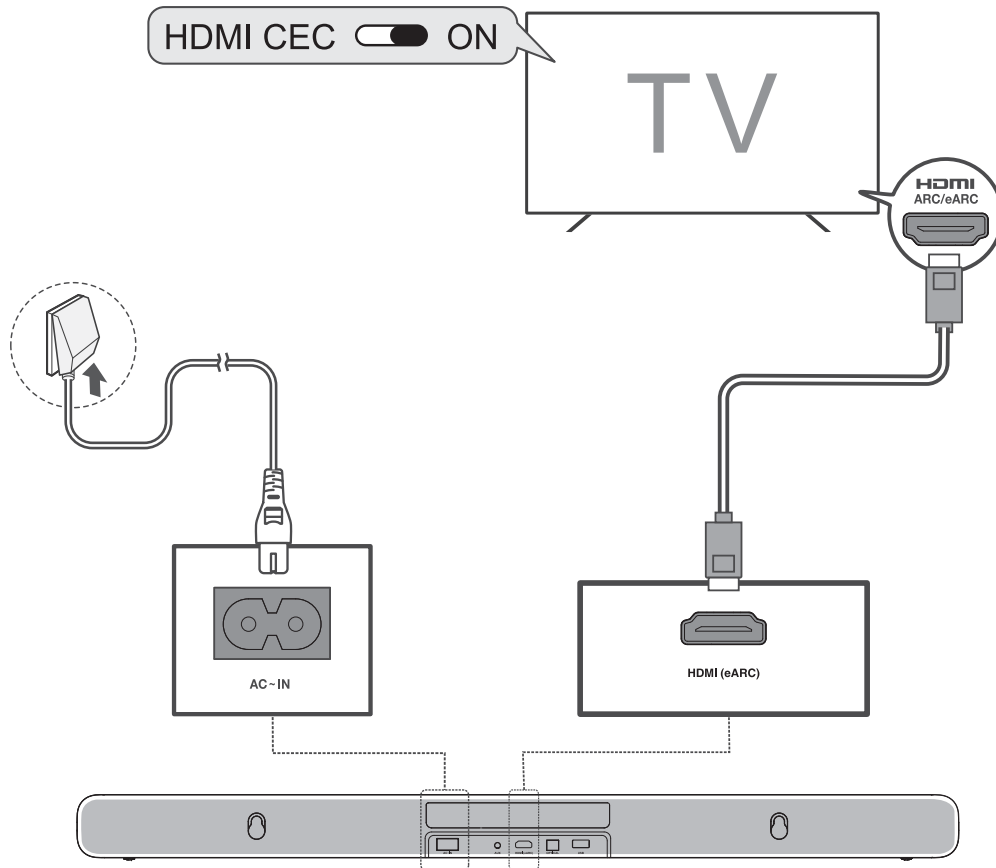

7a HDMI (eARC)

Enable CEC function on TCL TV.

- 1 Connect HDMI cable from the HDMI (eARC) interface on the sound bar to the HDMI (ARC/eARC) interface on the TV.
- 2 Enable the CEC function in the settings of the TCL TV.
(See TV User Manual for instructions)

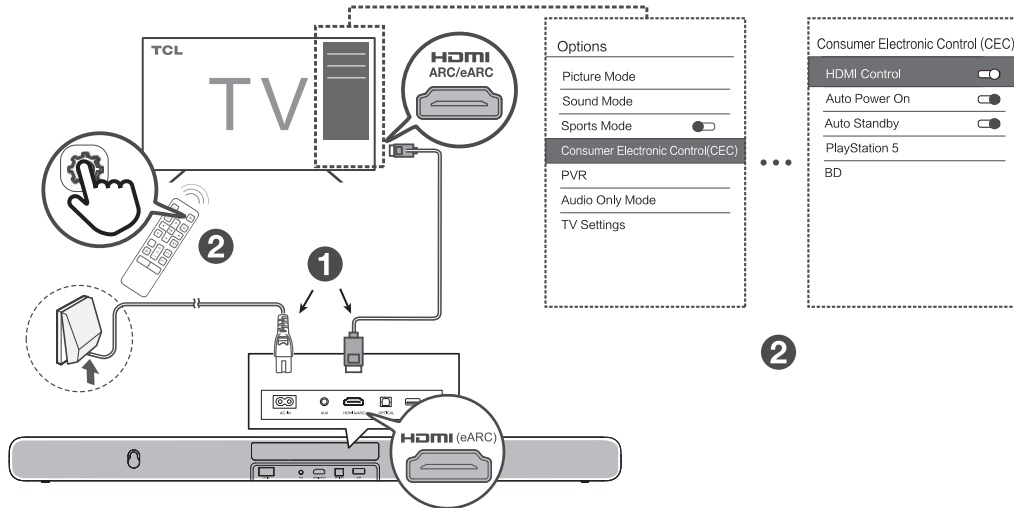

Enable CEC function on other brand TV.

- 1 Connect HDMI cable from the HDMI (eARC) interface on the sound bar to the HDMI (ARC/eARC) interface on the TV.
- 2 Enable the CEC function in the settings of the TV.



Note:
CEC (Consumer Electronic Control) function naming may differ by TV manufacturer. This feature may be called CEC, Anynet+, SimpLink, BRAVIA Link, EasyLink or VIERA Link. Please see your TV's user manual for more information.

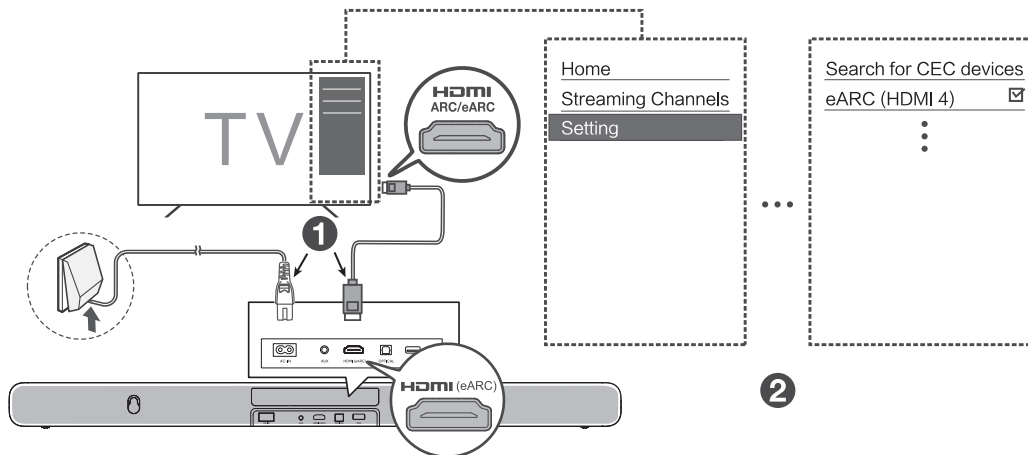

7b

Optical

Connect the Sound Bar to the TV with an Optical cable.

Connect the Sound Bar to the power supply with the included power cord.





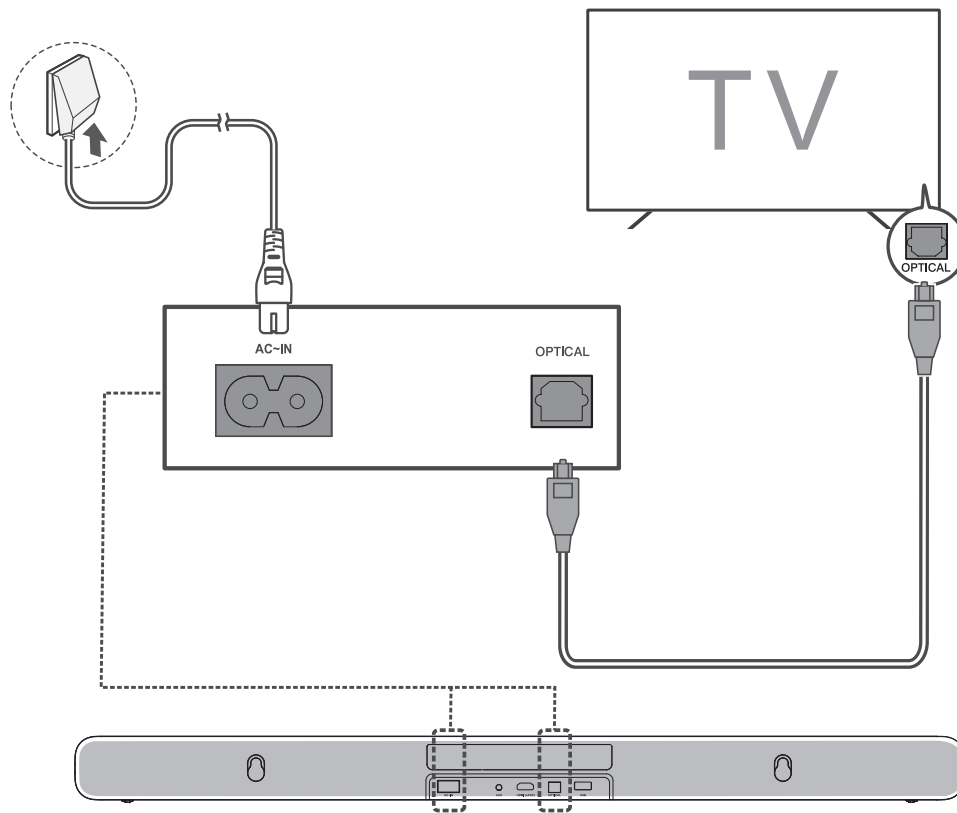

Warning:
Do not bend or kink the optical cable (SPDIF) as it is fragile and can easily get damaged and broken.



8

Pair with your Bluetooth device

You can stream music from your mobile device via Bluetooth.

1. Press .
2. Press .
3. Press and hold  on the remote control or press and hold  on your sound bar.
 - > You will see blue lights cycle from left to right.
 - > The Sound Bar is ready to pair.
4. Power on your Bluetooth device and activate its Bluetooth function.
 - > You will see the blue light on for 5 seconds.
 - > Pairing is successful.
6. If you want to pair another device, please repeat step 3.

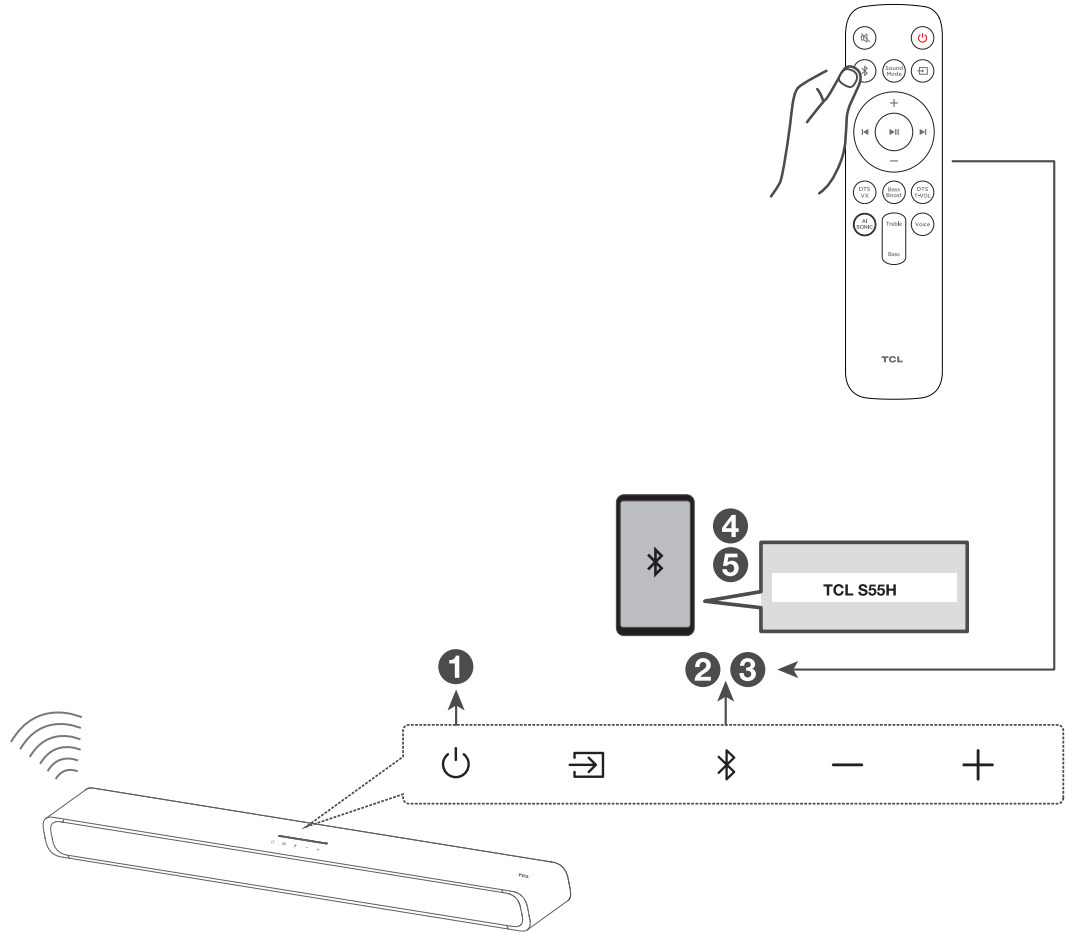

9a Other connections - USB

Supported audio files: MP3, WMA, WAV, FLAC.

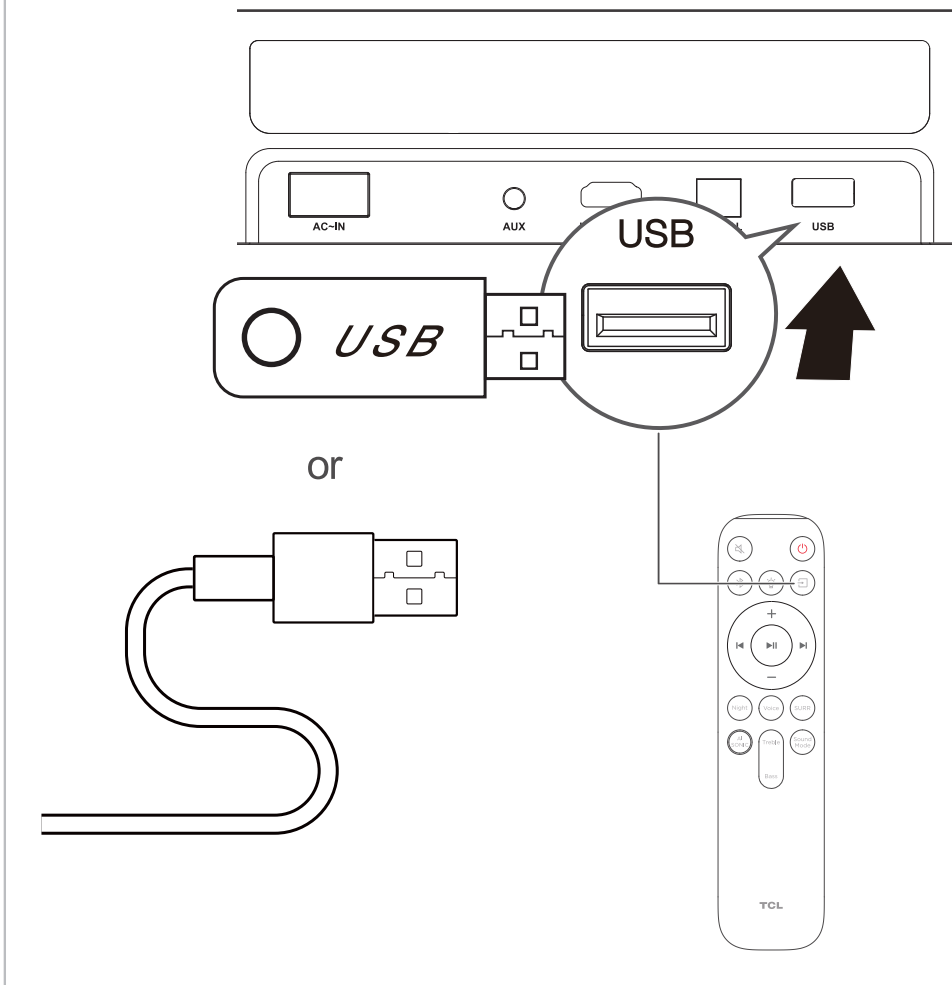

9b

Other connections - AUX



or



Cables are not included.

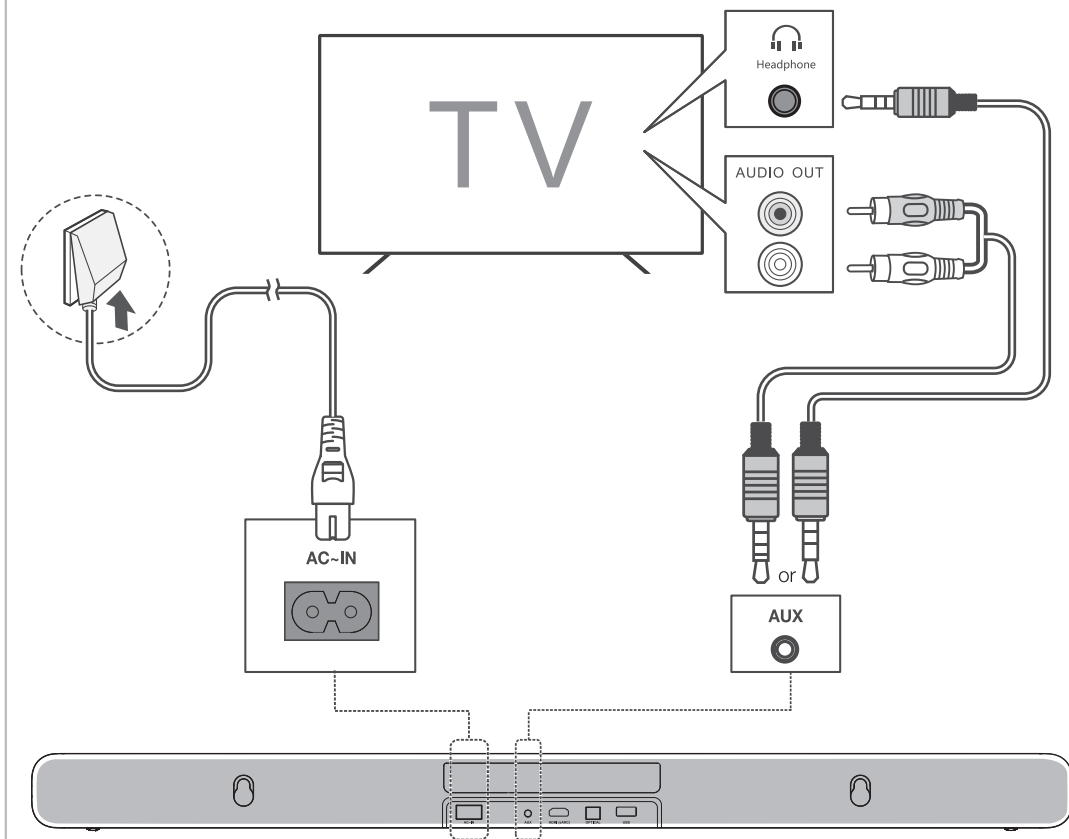

When the Soundbar is connected, "TV+Soundbar" menu appears on the TV.

Settings → **Display & Sound** → **Audio Output** → **Internal Speaker+Soundbar(HDMI)**



Note:

The message displayed may differ with the TV model.
This function is compatible with some TCL TVs.
The operation methods for different televisions may vary.

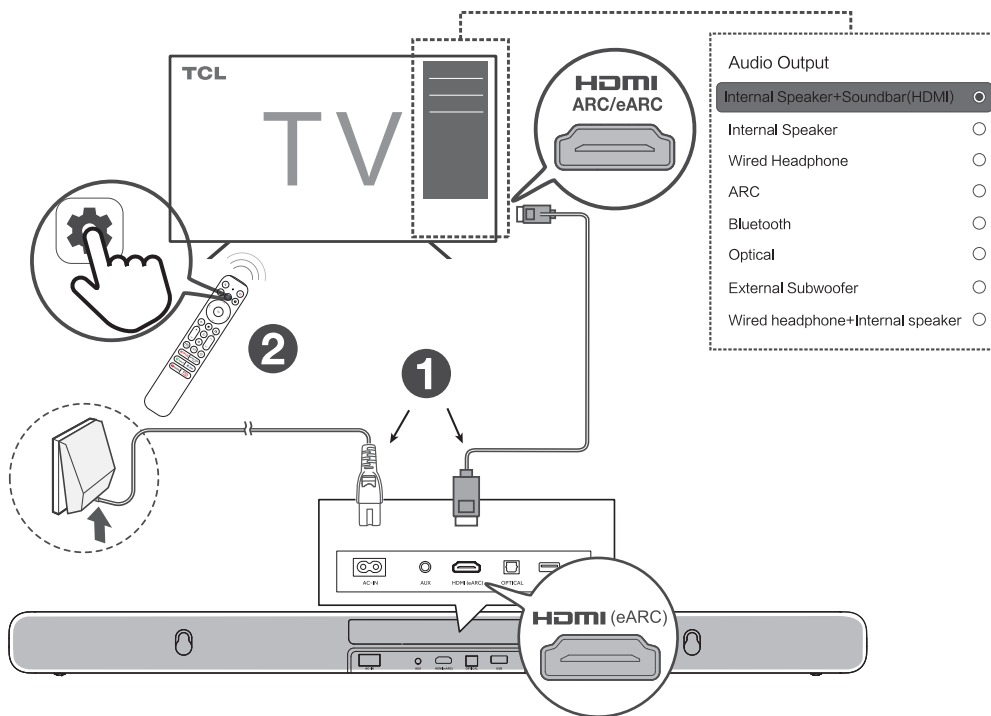

11

AI Sonic

12

Download TCL-HOME App

This S-Series sound bar can be fully controlled via the TCL Home App, including power, volume, input switching, effects, AI Sonic and more. Use the TCL Home App to explore additional smart features.

Please download the latest version from the app stores.



TCL Home App
Your TCL Smart Hub.
Download Now!

What is AI Sonic?

AI Sonic is a Room Calibration Technology developed by TCL Audio Lab. To use this function, you need to download TCL Home App and follow the instructions.

Before AI Sonic

Speaker distance, sound pressure level, and frequency response are all uneven. Based on your sitting area and room field.

After AI Sonic

Speaker distance, sound pressure level, and frequency response are all equalized. Based on your sitting area and room field.

How It Works?

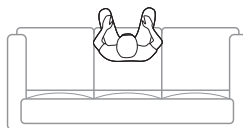
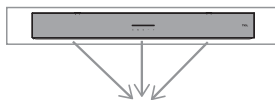

The sound field will be measured by cellphone and microphone.

Calibration

Follow the on-screen instructions in the TCL Home App.

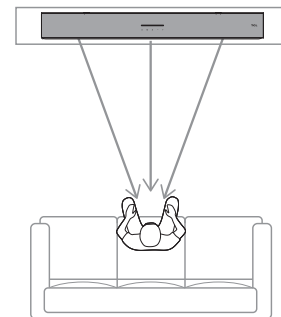

13

Online Firmware Update

Follow the instructions on the right side to update the firmware on TCL-HOME app.



Note:
The message displayed may differ.
Do not exit the TCL-HOME app during the update process.

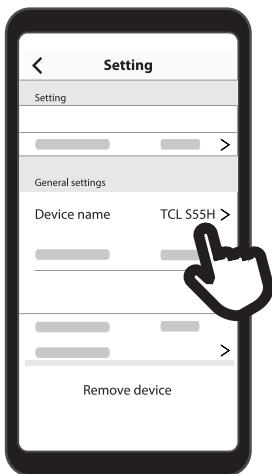

1

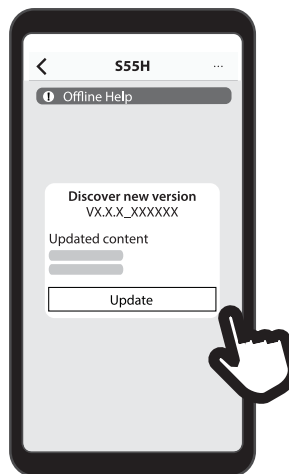

2

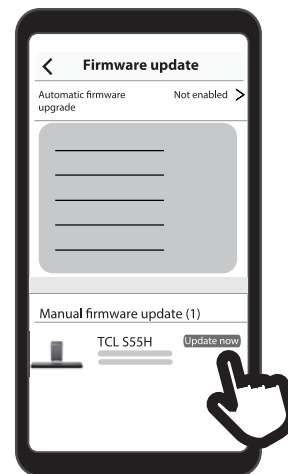

3

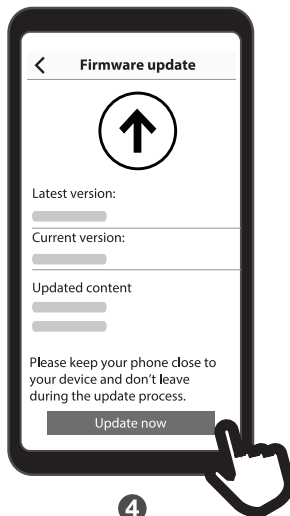

4

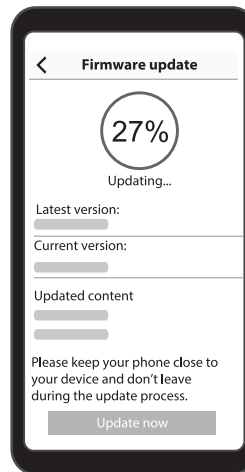

5

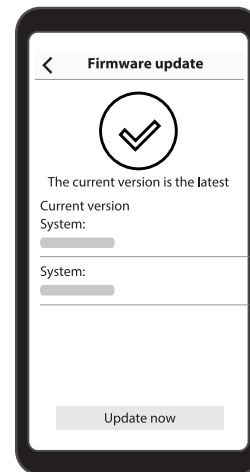

Trademarks



Roku, the Roku logo, Roku TV, Roku TV Ready, and the Roku TV Ready logo are trademarks and/or registered trademarks of Roku, Inc. This product is Roku TV Ready-supported in the United States and Canada. Countries are subject to change. For the most current list of countries in which this product is Roku TV Ready-supported, please email rokutvready@roku.com.



Dolby, Dolby Atmos, and the double-D symbol are registered trademarks of Dolby Laboratories Licensing Corporation. Manufactured under license from Dolby Laboratories. Confidential unpublished works. Copyright © 2012-2024 Dolby Laboratories. All rights reserved.



The Bluetooth® word mark and logos are registered trademarks owned by Bluetooth SIG, Inc. and any use of such marks by TTE Corporation is under license. Other trademarks and trade names are those of their respective owners.



For DTS patents, see <http://patents.dts.com>. Manufactured under license from DTS, Inc. DTS, Digital Surround, Virtual:X, and the DTS logo are registered trademarks or trademarks of DTS, Inc. in the United States and other countries.

© 2024 DTS, Inc. ALL RIGHTS RESERVED



“The terms HDMI, HDMI High-Definition Multimedia Interface, HDMI trade dress and the HDMI Logos are trademarks or registered trademarks of HDMI Licensing Administrator, Inc.”

DO NOT RETURN TO STORE

**WE ARE
READY TO
HELP** contact us first
with any questions



TCL SUPPORT:
support.tcl.com
1-877-300-9223



**TAKE CARE WHEN
REMOVING THE SOUND BAR**

Important safety instructions

Make sure you read all the safety information before you use this product.

TCL North America bears no responsibility for accidents or damages caused by unauthorized changes, modifications or improper use of the product.

User Manual can be found at www.tcl.com/cn on the specific product page in the "Download" section.

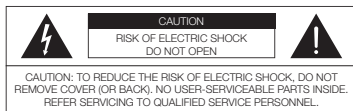

The lightning flash with arrowhead symbol, within an equilateral triangle is intended to alert the user to the presence of uninsulated dangerous voltage within the product's enclosure that may be of sufficient magnitude to constitute a risk of electric shock.



The exclamation point within an equilateral triangle is intended to alert the user to the presence of important operating and maintenance (servicing) instructions in the literature accompanying the product.



This symbol indicates that this product incorporates double insulation between hazardous main voltage and user accessible parts. When servicing, use only identical replacement parts.

Warnings

- To reduce the risk of fire or electric shock, do not expose this product to rain or moisture. This product should not be exposed to dripping or splashing. No objects filled with liquids, such as vases, should be placed on or near the product.
- The product is unstable if it is not properly placed or mounted to the wall. Be sure to follow the wall mounting instructions provided in the user manual to ensure your safety.
- Do not expose batteries to excessive heat such as sunshine, fire, and so forth.
- To avoid the danger of suffocation, keep plastic packaging away from pets, babies, and children.
- Do not use packaging bags in cribs, beds, carriages, or playpens.
- Shielded cables must be used with this unit to ensure compliance with the Class B FCC limits.

Safety

- **Read these instructions** - Read all the safety and operating instructions before operating the product.
- **Retain these instructions** - Retain the safety and operating instructions for future reference.
- **Heed all warnings** - Adhere to all warnings on the product and in the operating instructions.
- **Follow all instructions** - Follow all operating and use instructions.
- **Do not use this apparatus near water** - The appliance should not be used near water or moisture - for example, in a wet basement or near a swimming pool and the like.
- **Clean only with a dry cloth.**
- **Do not block any ventilation openings.** Install in accordance with the manufacturer's instructions.
- **Do not install near any heat sources** such as radiators, heat registers, stoves, or other apparatus (including amplifiers) that produce heat.
- **Do not defeat the safety purpose** of the polarized or grounding-type plug. A polarized plug has two blades with one wider than the other. A grounding type plug has two blades and a third grounding prong. The wide blade or the third prong are provided for your safety. If the provided plug does not fit into your outlet, consult an electrician for replacement of the obsolete outlet.
- **Protect the power cord** from being walked on or pinched particularly at plugs, convenience receptacles, and the point where it exits from the product. If the cord set is damaged, it must be replaced by a special cord set available from the manufacturer or its service agent.
- **Use only attachments/accessories** specified by the manufacturer.
- **Use only with the cart,** stand, tripod, bracket, or table specified by the manufacturer, or sold with the apparatus. When a cart is used, use caution when moving the cart/apparatus combination to avoid injury from tip-over.



- **Unplug this apparatus** during lightning storms or when unused for long periods of time.
- **Refer all servicing** to qualified service personnel. Servicing is required when the apparatus has been damaged in any way, such as power-supply cord or plug damaged, liquid has been spilled or objects have fallen into the apparatus, the apparatus has been exposed to rain or moisture, does not operate normally, or has been dropped.
- **The user must maintain** a minimum distance of 20 cm from the device at all time.
- **This appliance is not intended** for use by young children or infirm persons without supervision. Young children should be supervised to ensure that they do not play with the appliance.

Cautions

- To prevent electric shock, match wide blade of plug to wide slot, fully insert.
- Do not place any sources of danger on the product (for example: liquid filled objects, lighted candles).
- Disconnect the power cord to shut off when find trouble or not in use. The power cord shall be readily operable.
- Use of controls or adjustments or performance of procedures other than those described herein, may result in hazardous radiation exposure or other unsafe operation.
- The power cord/appliance coupler is used as the disconnect device, the disconnect device must remain readily operable.
- The rating label is located at the bottom or back of the product.
- The use of apparatus in tropical and moderate climates.

Battery precautions

- Do not mix batteries (old and new or carbon and alkaline).
- Do not dispose of batteries in fire or water.
- Do not recycle or dispose of batteries as per state and local guidelines.
- Danger of explosion if battery is incorrectly replaced. Replace only with the same or equivalent type.
- When the remote control is not to be used for a long time (more than a month), remove the battery from the remote control to prevent it from leaking.
- If the batteries leak, wipe away the leakage inside the battery compartment and replace the batteries with new ones.
- Keep away the batteries from heat or moisture.
- Do not carry or store batteries with other metallic objects. Doing so could cause batteries to short circuit, leak or explode.
- Never recharge a battery unless it is confirmed to be a rechargeable type.
- If the battery compartment does not close securely, stop using the product and keep it away from children.

Disposal of your old product and battery

Your product is designed and manufactured with high quality materials and components, which can be recycled and reused.

This product may contain lead and mercury. Disposal of these materials may be regulated due to environmental considerations. For disposal or recycling information, please contact your local authorities.

This product contains batteries:

- Do not incinerate. Batteries may explode if overheated.
- For disposal or recycling information, please contact your local authorities.

CAUTION: Risk of explosion if the battery is replaced by an incorrect type.

CAUTION: Replacement of a battery with an incorrect type that can defeat a safeguard.

CAUTION: Disposal of a battery into fire or a hot oven, or mechanically crushing or cutting of a battery, that can result in an explosion.

CAUTION: Leaving a battery in an extremely high temperature surrounding environment that can result in an explosion or the leakage of flammable liquid or gas.

CAUTION: A battery subjected to extremely low air pressure that may result in an explosion or the leakage of flammable liquid or gas.

Compliance notice

Notice for US

FCC Information

Warning

Changes or modifications to this unit not expressly approved by the party responsible for compliance could void the user's authority to operate the equipment.

Notice

This equipment has been tested and found to comply with the limits for a Class B digital device, pursuant to Part 15 of the FCC Rules. These limits are designed to provide reasonable protection against harmful interference in a residential installation. This equipment generates, uses and can radiate radio frequency energy and, if not installed and used in accordance with the instructions, may cause harmful interference to radio communications. However, there is no guarantee that interference will not occur in a particular installation.

If this equipment does cause harmful interference to radio or television reception, which can be determined by turning the equipment off and on, the user is encouraged to try to correct the interference by one or more of the following measures:

- Reorient or relocate the receiving antenna.
- Increase the separation between the equipment and receiver.
- Connect the equipment into an outlet on a circuit different from that to which the receiver is connected.
- Consult the dealer or an experienced radio / TV technician for help.

This device complies with Part 15 of the FCC Rules. Operation is subject to the following two conditions:

- (1) This device may not cause harmful interference, and
- (2) This device must accept any interference received, including interference that may cause undesired operation.

FCC Radiation Exposure Statement: This equipment complies with FCC radiation exposure limits set forth for an uncontrolled environment. This equipment should be installed and operated with a minimum distance of 20cm between the radiator and your body. This transmitter must not be co-located or operated in conjunction with any other antenna or transmitter.

Notice for Canada

Class B Clause

This Class B digital apparatus complies with Canadian ICES-003

This device contains licence-exempt transmitter(s)/receiver(s) that comply with Innovation, Science and Economic Development Canada's licence-exempt RSS(s). Operation is subject to the following two conditions: 1. This device may not cause interference. 2. This device must accept any interference, including interference that may cause undesired operation of the device.

IC Radiation Exposure Statement

This equipment complies with ICSED RSS-102 radiation exposure limits set forth for an uncontrolled environment. This equipment should be installed and operated with a minimum distance of 20cm between the radiator and any part of your body.

Warning: The user is cautioned that changes or modifications not expressly approved by the party responsible for compliance could void the user's authority to operate the equipment.

Consignes de sécurité importantes

Assurez-vous de lire toutes les informations de sécurité avant d'utiliser ce produit.

TCL North America décline toute responsabilité en cas d'accidents ou de dommages causés par des changements non autorisés, des modifications ou une utilisation incorrecte du produit.

Le manuel de l'utilisateur est disponible à l'adresse www.tcl.com/ca, sur la page du produit connecté, dans la section « Téléchargement ».



Le symbole de l'éclair en forme de foudre, situé dans un triangle équilatéral, a pour but d'alerter l'utilisateur de la présence d'une tension dangereuse non isolée à l'intérieur du boîtier du produit pouvant être suffisamment importante pour constituer un risque d'électrocution.



Le point d'exclamation dans un triangle équilatéral est destiné à alerter l'utilisateur de la présence de consignes importantes d'utilisation et de maintenance (entretien) dans la documentation accompagnant le produit.



Ce symbole indique que ce produit comporte une double isolation entre la tension principale dangereuse et les pièces accessibles à l'utilisateur. Lors du l'entretien, utilisez uniquement des pièces de rechange identiques.

Avertissements

- Pour réduire les risques d'incendie ou d'électrocution, n'exposez pas ce produit à la pluie ou à l'humidité. Ce produit ne doit pas être exposé à des gouttes ou des éclaboussures. Aucun objet rempli de liquide, tel qu'un vase, ne doit être placé au-dessus ou à proximité du produit.
- Le produit est instable s'il n'est pas correctement placé ou fixé au mur. Veuillez suivre les instructions de montage mural fournies dans ce manuel d'utilisation pour assurer votre sécurité.
- N'exposez pas les piles à une source de chaleur excessive telle que le soleil, le feu, etc.
- Pour éviter tout risque de suffocation, gardez les emballages en plastique hors de portée des animaux domestiques, des bébés et des enfants.
- N'utilisez pas les sacs d'emballage dans les berceaux, les lits, les charosses ou les parcs pour enfants.
- Des câbles blindés doivent être utilisés avec cet appareil pour garantir la conformité aux limites de la classe B de la FCC.

Sécurité

- **Lisez ces consignes** – Lisez toutes les consignes de sécurité et d'utilisation avant d'utiliser le produit.
- **Conservez ces consignes** – Conservez les consignes de sécurité et d'utilisation pour une consultation ultérieure.
- **Respectez tous les avertissements** – Respectez tous les avertissements sur le produit et dans le mode d'emploi.
- **Observez toutes les consignes** – Observez le mode d'emploi et toutes les consignes d'utilisation.
- **N'utilisez pas cet appareil à proximité d'eau** – Cet appareil ne doit pas être utilisé à proximité d'eau ou d'humidité – par exemple, dans un sous-sol humide ou près d'une piscine, etc.
- **Nettoyez uniquement avec un chiffon sec.**
- **Ne bloquez aucune bouche d'aération.** Installez conformément aux instructions du fabricant.
- **Ne l'installez pas près de sources de chaleur** telles que les radiateurs, les bouches de chaleur, les poêles ou autres appareils (y compris les amplificateurs) produisant de la chaleur.
- **N'utilisez pas la fiche polarisée** de la fiche polarisée ou mise à la terre. Une fiche polarisée a deux lames avec une plus large que l'autre. Une fiche de type mise à la terre a deux broches et une troisième broche de mise à la terre. La lame large ou la troisième broche sont fournies pour votre sécurité. Si la fiche fournie ne rentre pas dans votre prise, consultez un électricien pour remplacer la prise obsolète.
- **Protégez le cordon d'alimentation** des piétinements et des pincements, en particulier au niveau des fiches, des prises de courant et du point de sortie du produit. Si l'ensemble de câble est endommagé, il faut le remplacer par un câble spécial disponible auprès du fabricant ou de son agent de service.
- **N'utilisez que les pièces jointes / accessoires spécifiés** par le fabricant.
- **N'utilisez que le chariot.** Le support, le trépied, la console ou la table spécifiés par le fabricant ou vendus avec l'appareil. En cas d'utilisation d'un chariot, soyez prudent lorsque vous déplacez l'ensemble chariot-appareil afin d'éviter tout risque de basculement ou de blessures.



- **Débranchez cet appareil** en cas d'orage ou lorsqu'il n'est pas utilisé pendant de longues périodes.
- **Confiez l'entretien de l'appareil** à un personnel qualifié. Une réparation est nécessaire lorsque l'appareil a été endommagé de quelque manière que ce soit, par exemple si le cordon d'alimentation ou la fiche sont endommagés, si un liquide a été renversé ou si des objets sont tombés dans l'appareil, si l'appareil a été exposé à la pluie ou à l'humidité, s'il ne fonctionne pas normalement ou s'il est tombé.
- **L'utilisateur doit se tenir** à une distance minimale de 20 cm de l'appareil à tout moment.
- **Cet appareil n'est pas destiné** à être utilisé par de jeunes enfants ou des personnes infirmes sans surveillance. Il faut surveiller les jeunes enfants pour s'assurer qu'ils ne jouent pas avec l'appareil.

Mises en garde

- Pour éviter les électrocutions, faites correspondre la lame large de la fiche à la fente large et insérez-la complètement.
- Ne placez aucune source de danger sur le produit (par exemple, objets remplis de liquide, bougies allumées).
- Débranchez le cordon d'alimentation pour l'entretien en cas de problème ou si vous ne l'utilisez pas. Le cordon d'alimentation doit être facilement utilisable.
- L'utilisation de commandes ou de réglages ou l'exécution de procédures autres que celles décrites dans le présent document peuvent entraîner une exposition à des radiations dangereuses ou d'autres opérations dangereuses.
- Si le raccord d'alimentation avec l'appareil est utilisé pour le débranchement, celui doit rester facilement utilisable.
- L'étiquette d'identification se trouve au bas ou à l'arrière du produit.
- L'appareil peut être utilisé dans des climats tropicaux et modérés.

Précautions concernant les piles

- Ne mélangez pas les piles (anciennes et nouvelles) ou carbone et alcalines).
- Ne jetez pas les piles au feu ou dans l'eau.
- Recyclez et jetez les piles conformément aux directives nationales et locales.
- Danger d'explosion si la pile est remplacée de manière incorrecte. Remplacez uniquement par le même type ou un type équivalent.
- Lorsque vous n'utilisez pas la télécommande pendant une longue période (plus d'un mois), retirez la pile de la télécommande pour éviter qu'elle ne fuie.
- Si les piles fuient, essayez la fuite à l'intérieur du compartiment et remplacez les piles par des neuves.
- Gardez les piles à l'écart de la chaleur ou de l'humidité.
- Ne transportez pas et ne stockez pas les piles avec d'autres objets métalliques. Cela pourrait provoquer un court-circuit, un déchauffement ou une explosion des piles.
- Ne rechargez jamais une pile sauf s'il est prouvé qu'elle est rechargeable.
- Si le compartiment à piles ne ferme pas correctement, cessez d'utiliser le produit et gardez-le hors de portée des enfants.

Mise au rebut d'un appareil désuet et des piles

Votre appareil est conçu et fabriqué avec des composants et des matériaux de haute qualité, pouvant être recyclés et réutilisés.

Ce produit peut contenir du plomb et du mercure. L'élimination de ces matériaux peut être réglementée pour des raisons environnementales. Pour plus d'informations sur la mise au rebut ou le recyclage, contactez les autorités locales.

Ce produit contient des piles:

- Ne pas incinérer. Les piles peuvent exploser en cas de surchauffe.
- Pour plus d'informations sur la mise au rebut ou le recyclage, contactez les autorités locales.

ATTENTION: Risque d'incendie ou d'explosion si la batterie est remplacée par un type incorrect.

ATTENTION: Le remplacement d'une pile par un type incorrect est susceptible de neutraliser une mesure de protection.

ATTENTION: L'élimination d'une pile dans un feu ou dans un four chaud, par écrasement ou le découpage mécanique peut entraîner une explosion.

ATTENTION: Laisser une pile dans un environnement où la température est extrêmement élevée peut entraîner une explosion ou une fuite de liquide ou de gaz inflammable.

ATTENTION: Une pile soumise à une pression d'air extrêmement basse peut entraîner une explosion ou une fuite de liquide ou de gaz inflammable.

Avis de conformité

Avis pour les États-Unis

Informations sur la FCC

Avertissement

Les changements ou les modifications sur cet appareil non expressément approuvés par la partie responsable de la conformité pourraient invalider l'autorité de l'appareil pour manipuler l'équipement.

Remarque

Cet équipement a été testé et déclaré conforme aux limites imposées aux appareils numériques de classe B, conformément à la section 15 du règlement de la FCC. Ces limites sont conçues pour fournir une protection suffisante contre les interférences préjudiciables dans une installation résidentielle. Cet équipement génère, utilise et peut émettre de l'énergie radioélectrique et, s'il n'est pas installé et utilisé conformément aux instructions fournies, peut produire des interférences affectant les communications radio. Cependant, rien ne garantit que des interférences ne se produiront pas dans certaines installations.

Si cet équipement génère des interférences préjudiciables à la réception de signaux radio ou de télévision (ce qui peut être constaté en éteignant puis en rallumant l'appareil), nous conseillons à l'utilisateur d'essayer une ou plusieurs des mesures suivantes pour tenter de corriger le problème :

- Réorienter ou déplacer l'antenne de réception.
- Eloigner davantage le récepteur de l'équipement.
- Brancher l'équipement sur une prise de circuit différente de celle sur laquelle le récepteur est branché.
- Consulter le revendeur ou un technicien qualifié spécialisé en équipements radio/télévision.

Cet appareil est conforme à la section 15 de la réglementation de la FCC. Le fonctionnement est soumis aux deux conditions suivantes:

- (1) cet appareil ne doit pas causer d'interférences nuisibles, et
- (2) cet appareil doit accepter toutes les interférences reçues, y compris celles susceptibles de provoquer un fonctionnement indésirable.

Déclaration de la FCC sur l'exposition aux rayonnements : Cet appareil est conforme aux limites de la FCC sur l'exposition aux rayonnements définies pour un environnement non contrôlé. Cet équipement doit être installé et utilisé avec une distance minimale de 20 cm entre le radiateur et votre corps. Cet émetteur ne doit pas être installé ou utilisé en conjonction avec une autre antenne ou un autre émetteur.

Avis pour le Canada

Clause de classe B

Cet appareil numérique de classe B est conforme à la norme canadienne ICES-003.

Cet appareil contient des émetteurs ou des récepteurs exemptés de licence qui se conforment au CNR exempté/é licence du ministère de l'Innovation, des Sciences et du Développement économique du Canada. L'exploitation est autorisée aux deux conditions suivantes :

1. cet appareil ne doit pas causer d'interférences
2. cet appareil doit accepter toute interférence, y compris les interférences susceptibles de provoquer un fonctionnement indésirable de l'appareil.

Déclaration IC relative à l'exposition aux rayonnements

Cet équipement est conforme aux limites d'exposition aux radiations ISDE CNR-102 établies pour un environnement non contrôlé. Cet équipement doit être installé et utilisé en respectant une distance minimale de 20 cm entre le radiateur et toute partie du corps.

Avertissement : L'utilisateur est averti que les changements ou modifications non expressément approuvés par la partie responsable de la conformité peuvent annuler l'autorité de l'utilisateur à faire fonctionner l'équipement.