

Name:	PCB Antenna
Antenna Type:	PCB Antenna
Frequency range:	2400-2500MHz
Manufacturer:	Shenzhen Oukai Automotive Technology Co., Ltd
Address:	216, Building B, Tea Tree Industrial Zone, Xiaweyuan New Village, Gushu Community, Xixiang Street, Bao'an District, Shenzhen
Antenna Gain Max:	-0.27dBi

Antenna size

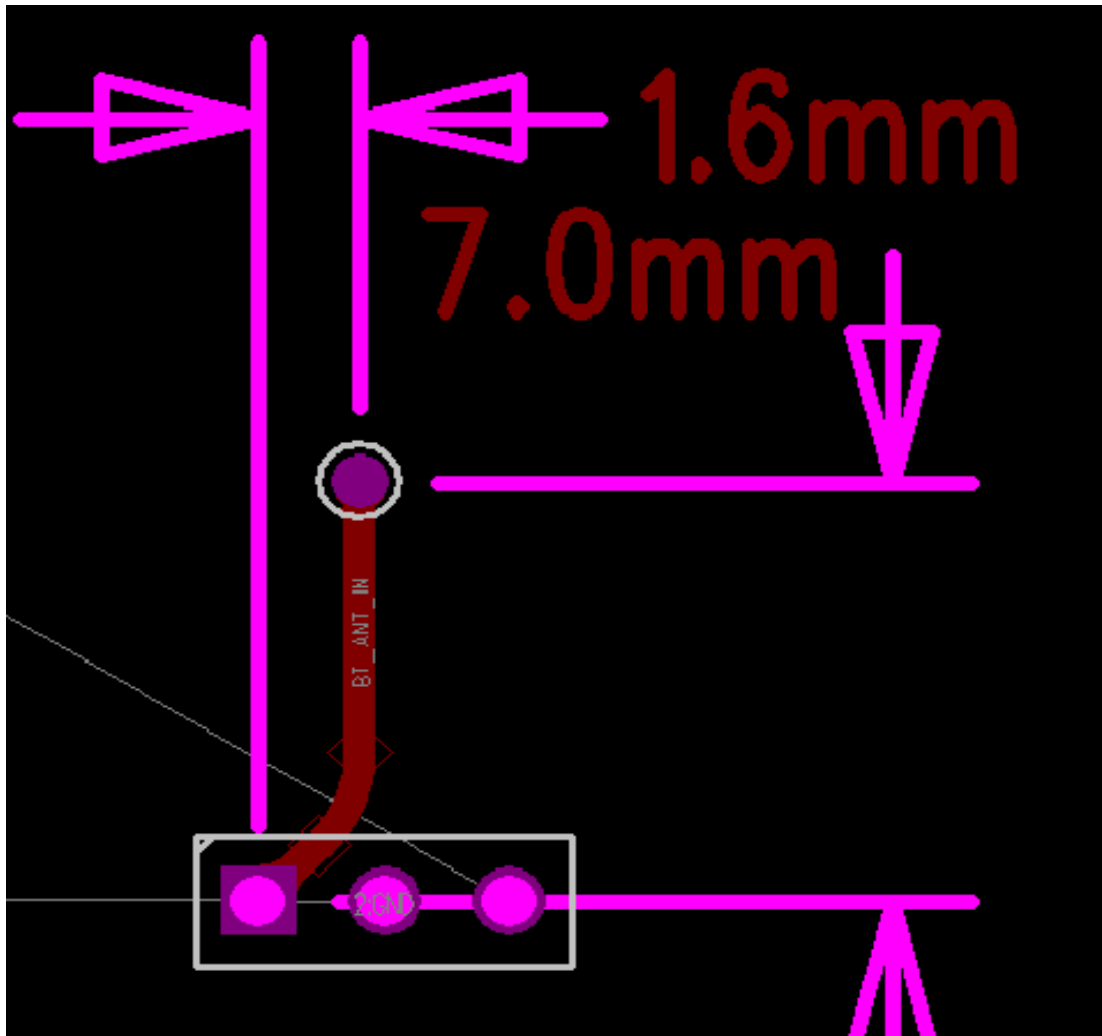

Passive Test For 2.4g

Freq (MHz)	Effi (%)	Effi (dB)	Gain (dBi)	Gain (dBd)	UHS (%)	DHS (%)	Max (dB)	Min (dB)	Attenut Hor	Attenut Ver
2400	20.2	-6.95	-2.95	-5.1	8.904	11.298	-2.95	-16.68	51.43	51.57
2410	21.26	-6.72	-2.65	-4.8	9.784	11.48	-2.65	-15.46	51.47	51.52
2420	23.94	-6.21	-2.04	-4.19	11.139	12.805	-2.04	-14.64	51.49	51.69
2430	25.1	-6	-1.99	-4.14	11.685	13.415	-1.99	-14.85	51.57	51.63
2440	25.61	-5.92	-1.84	-3.99	11.701	13.912	-1.84	-15.77	51.71	51.7
2450	26.76	-5.73	-1.32	-3.47	12.125	14.632	-1.32	-17.8	51.83	51.78
2460	29.95	-5.24	-0.51	-2.66	13.432	16.514	-0.51	-17.29	51.98	51.88
2470	30.48	-5.16	-0.42	-2.57	13.712	16.771	-0.42	-15.2	52	51.93
2480	31.17	-5.06	-0.27	-2.42	14.12	17.055	-0.27	-14.48	52	52.05
2490	31.63	-5	-0.36	-2.51	14.44	17.186	-0.36	-13.71	51.92	51.83
2500	34.01	-4.68	-0.28	-2.43	15.654	18.361	-0.28	-13.29	51.79	51.78

2400.00MHz - 2500.00MHz Gain

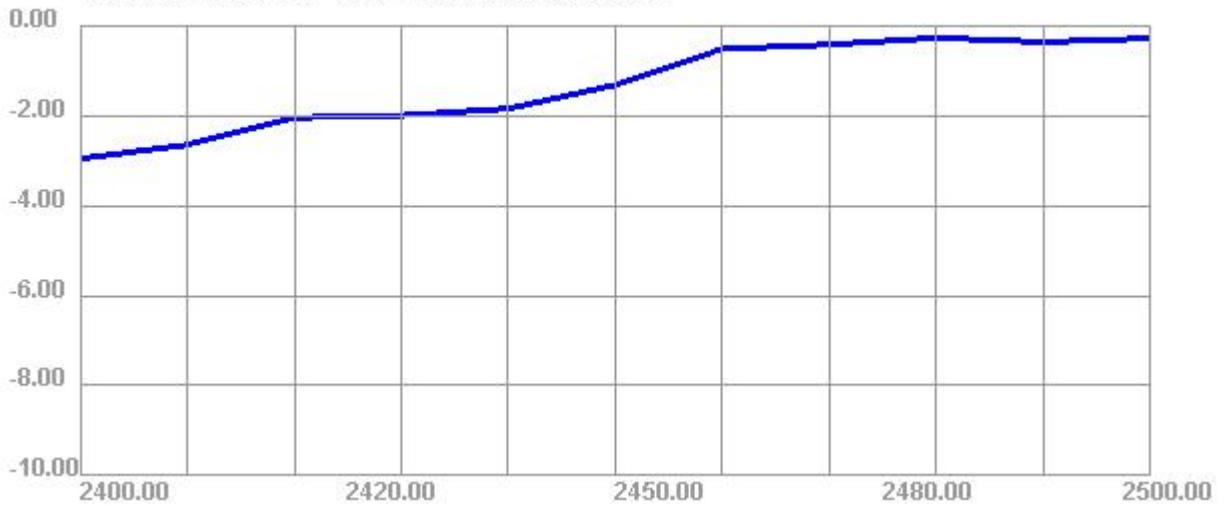

2400.00MHz - 2500.00MHz Efficiency



2400.000MHz

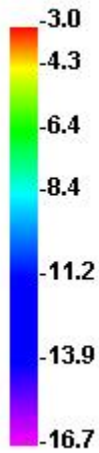
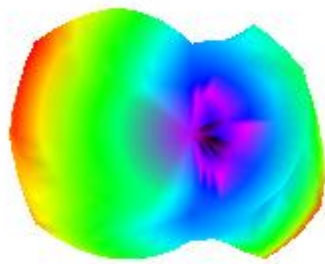

2400.000MHz H

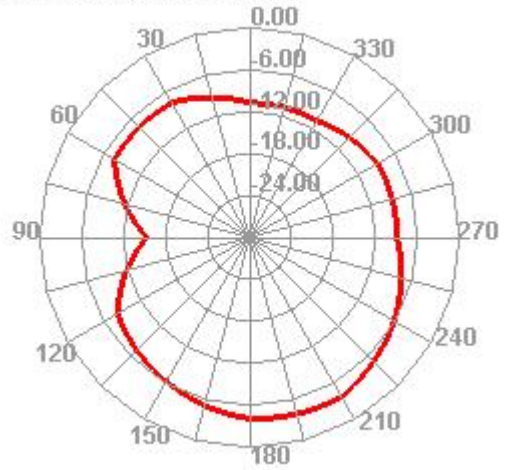

2400.000MHz E1

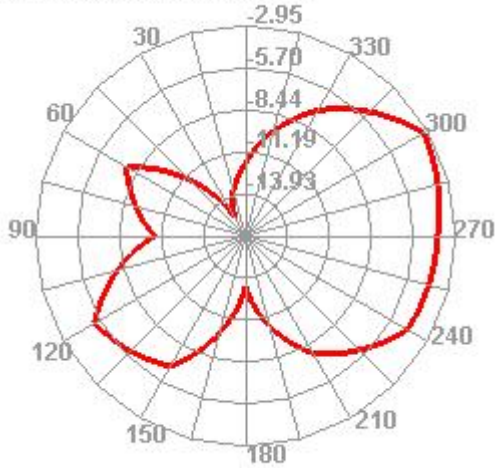

2400.000MHz E2

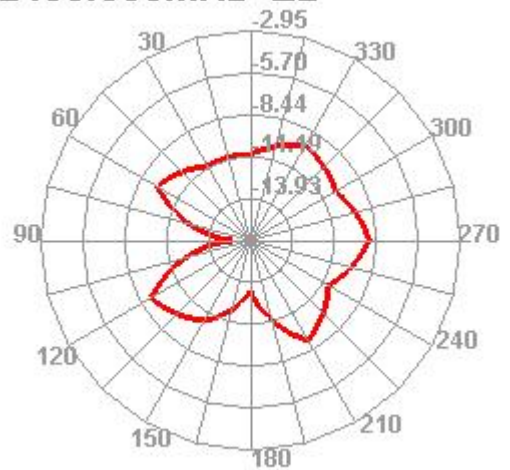

2410.000MHz

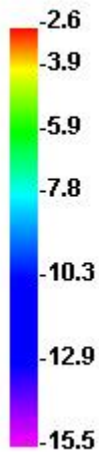
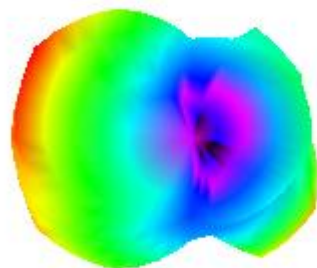

2410.000MHz H

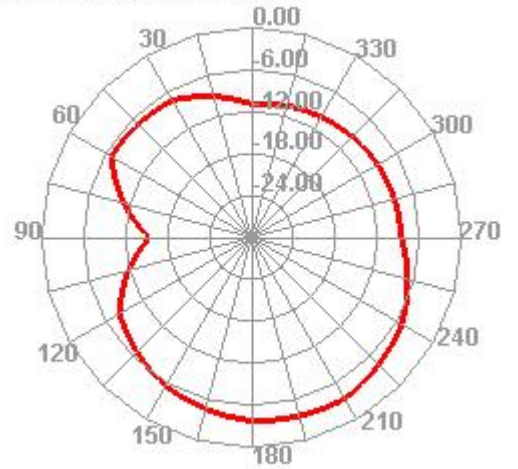

2410.000MHz E1

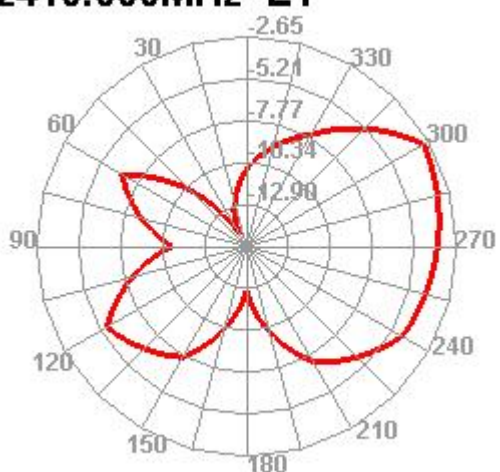

2410.000MHz E2

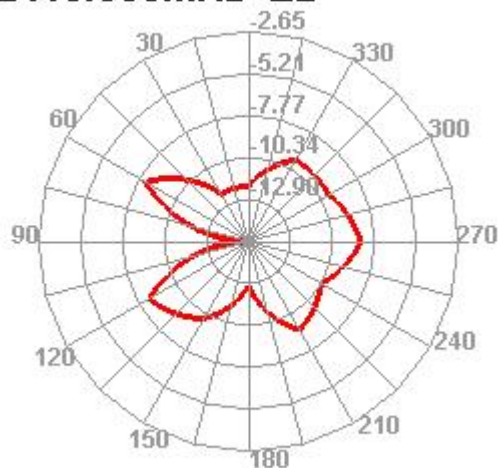

2450.000MHz

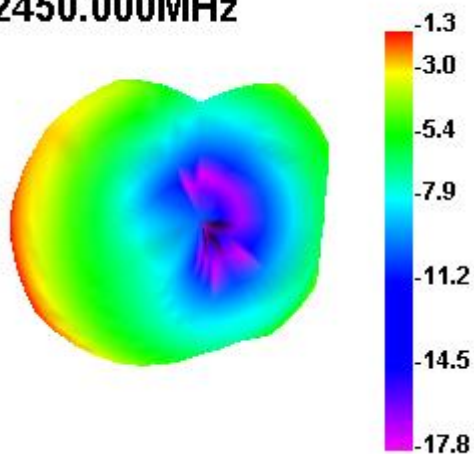

2450.000MHz H

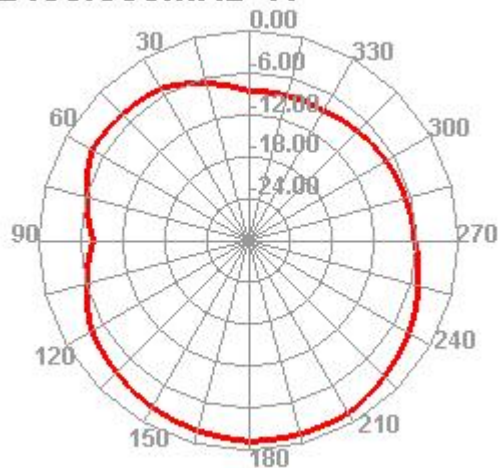

2450.000MHz E1

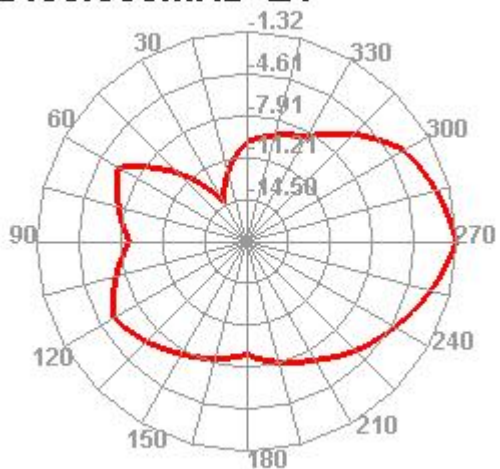

2450.000MHz E2

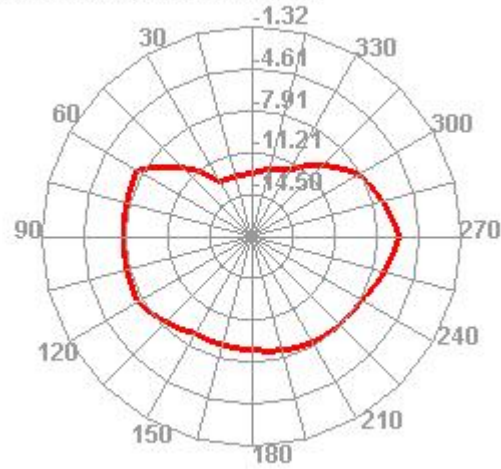

2500.000MHz

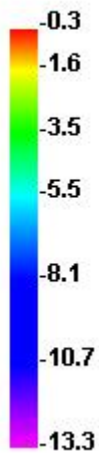
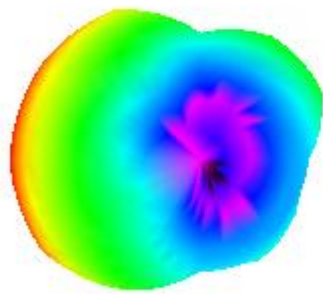

2500.000MHz H

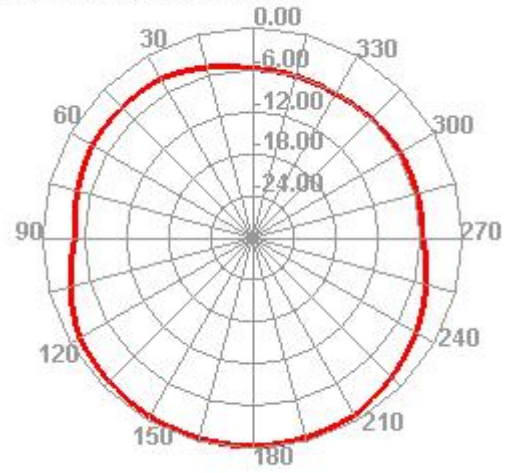

2500.000MHz E1

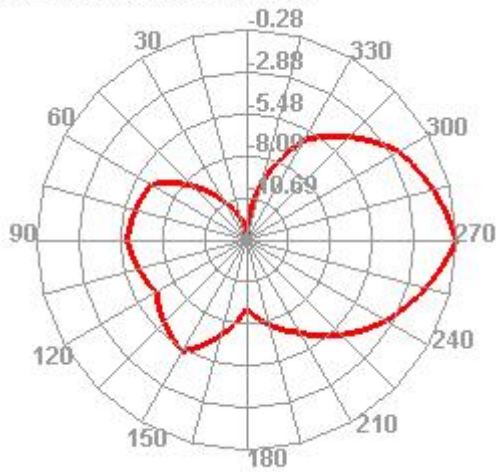

2500.000MHz E2

