



**Shenzhen Global Test Service Co.,Ltd.**

No.7-101 and 8A-104, Building 7 and 8, DCC Cultural and Creative Garden, No.98, Pingxin North Road, Shangmugu Community, Pinghu Street, Longgang District, Shenzhen, Guangdong

## FCC PART 15 SUBPART C TEST REPORT

### FCC PART 15.247

**Report Reference No.....: GTS20240118008-1-21**

**FCC ID..... : 2BEBP-OS03**

Compiled by

( position+printed name+signature) .: File administrators Peter Xiao

Supervised by

( position+printed name+signature) .: Test Engineer Evan Ouyang

Approved by

( position+printed name+signature) .: Manager Jason Hu

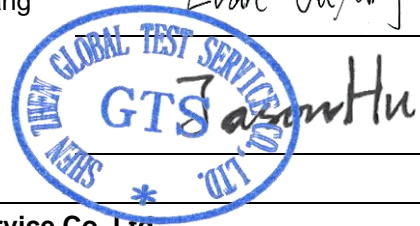

Date of issue .....: Mar. 18, 2024

**Representative Laboratory Name.: Shenzhen Global Test Service Co.,Ltd.**

Address .....: No.7-101 and 8A-104, Building 7 and 8, DCC Cultural and Creative Garden, No.98, Pingxin North Road, Shangmugu Community, Pinghu Street, Longgang District, Shenzhen, Guangdong,China

**Applicant's name.....: Beijing Netac Innovation Technology Development Co.Ltd**

Address .....: 138-1-3 NO.20 YONG AN ROAD MEN TOU GOU DISTRICT BEIJING CHINA

**Test specification .....**

Standard.....: **FCC Part 15.247**

TRF Originator.....: Shenzhen Global Test Service Co.,Ltd.

Master TRF .....: Dated 2014-12

**Shenzhen Global Test Service Co.,Ltd. All rights reserved.**

This publication may be reproduced in whole or in part for non-commercial purposes as long as the Shenzhen Global Test Service Co.,Ltd. is acknowledged as copyright owner and source of the material. Shenzhen Global Test Service Co.,Ltd. takes no responsibility for and will not assume liability for damages resulting from the reader's interpretation of the reproduced material due to its placement and context.

**Test item description .....** **Ture Wireless Open Earphones**

Trade Mark.....: Netac

Manufacturer.....: Beijing Netac Innovation Technology Development Co.Ltd

Model/Type reference.....: OS03

Listed Models.....: OS05, OS07

Modulation Type.....: GFSK

Operation Frequency.....: From 2402MHz to 2480MHz

Hardware Version.....: N/A

Software Version.....: N/A

Rating.....: DC 3.7V by battery

Recharged by DC 5.0V

Result.....: **PASS**

**TEST REPORT**

<b>Test Report No. :</b>	<b>GTS20240118008-1-21</b>	Mar. 18, 2024
		Date of issue

Equipment under Test : Ture Wireless Open Earphones

Model /Type : OS03

Listed model : OS05, OS07

**Applicant** : **Beijing Netac Innovation Technology Development Co.Ltd**

Address : 138-1-3 NO.20 YONG AN ROAD MEN TOU GOU DISTRICT BEIJING CHINA

**Manufacturer** : **Beijing Netac Innovation Technology Development Co.Ltd**

Address : 138-1-3 NO.20 YONG AN ROAD MEN TOU GOU DISTRICT BEIJING CHINA

<b>Test Result:</b>	<b>PASS</b>
---------------------	-------------

The test report merely corresponds to the test sample.  
It is not permitted to copy extracts of these test result without the written permission of the test laboratory.

## Contents

<b>1. TEST STANDARDS .....</b>	<b>4</b>
<b>2. SUMMARY .....</b>	<b>5</b>
2.1. General Remarks .....	5
2.2. Product Description .....	5
2.3. Equipment Under Test .....	5
2.4. Short description of the Equipment under Test (EUT) .....	6
2.5. EUT operation mode .....	6
2.6. Block Diagram of Test Setup .....	7
2.7. EUT Exercise Software .....	7
2.8. Special Accessories .....	7
2.9. External I/O Cable .....	7
2.10. Related Submittal(s) / Grant (s) .....	7
2.11. Modifications .....	7
<b>3. TEST ENVIRONMENT .....</b>	<b>8</b>
3.1. Address of the test laboratory .....	8
3.2. Test Facility .....	8
3.3. Environmental conditions .....	8
3.4. Statement of the measurement uncertainty .....	8
3.5. Test Description .....	9
3.6. Equipments Used during the Test.....	10
<b>4. TEST CONDITIONS AND RESULTS .....</b>	<b>11</b>
4.1. AC Power Conducted Emission .....	11
4.2. Radiated Emission .....	14
4.3. Maximum Peak Output Power .....	20
4.4. Power Spectral Density .....	21
4.5. 99% and 6dB Bandwidth .....	22
4.6. Conducted Spurious Emissions and Band Edge Compliance of RF Emission.....	23
4.7. Antenna Requirement .....	25
<b>5. TEST SETUP PHOTOS OF THE EUT .....</b>	<b>26</b>
<b>6. EXTERNAL AND INTERNAL PHOTOS OF THE EUT .....</b>	<b>26</b>

## 1. TEST STANDARDS

The tests were performed according to following standards:

[FCC Rules Part 15.247](#): Frequency Hopping, Direct Spread Spectrum and Hybrid Systems that are in operation within the bands of 902-928 MHz, 2400-2483.5 MHz, and 5725-5850 MHz.

[ANSI C63.10-2020](#): American National Standard for Testing Unlicensed Wireless Devices

[KDB 558074 D01 DTS Meas Guidance](#): Guidance for Performing Compliance Measurements on Digital Transmission Systems (DTS) Operating Under §15.247.

## 2. SUMMARY

### 2.1. General Remarks

Date of receipt of test sample	:	Feb. 26, 2024
Testing commenced on	:	Feb. 26, 2024
Testing concluded on	:	Mar. 17, 2024

### 2.2. Product Description

Product Name:	Ture Wireless Open Earphones
Trade Mark:	Netac
Model/Type reference:	OS03
List Model:	OS05, OS07
Model Declaration	PCB board, structure and internal of these model(s) are the same, Only the model name different, So no additional models were tested.
Power supply:	DC 3.7V by battery Recharged by DC 5.0V
Hardware Version	N/A
Software Version	N/A
Sample ID	GTS20240118008-1-S0001-3#& GTS20240118008-1-S0001-4#
Bluetooth	
Frequency Range	2402MHz ~ 2480MHz
Channel Number	79 channels for Bluetooth (DSS) 40 channels for Bluetooth (DTS)
Channel Spacing	1MHz for Bluetooth (DSS) 2MHz for Bluetooth (DTS)
Modulation Type	GFSK, $\pi/4$ -DQPSK for Bluetooth (DSS) GFSK for Bluetooth (DTS)
Antenna Description	Internal Antenna, 1.95 dBi

### 2.3. Equipment Under Test

#### Power supply system utilised

Power supply voltage	:	<input type="radio"/> 230V / 50 Hz	<input type="radio"/> 120V / 60Hz
		<input type="radio"/> 12 V DC	<input type="radio"/> 24 V DC
		<input checked="" type="radio"/> Other (specified in blank below)	

DC 3.7V

### 2.4. Short description of the Equipment under Test (EUT)

This is a Ture Wireless Open Earphones.  
For more details, refer to the user’s manual of the EUT.

### 2.5. EUT operation mode

The Applicant provides communication tools software to control the EUT for staying in continuous transmitting (Duty Cycle more than 98%) and receiving mode for testing .There are 40 channels provided to the EUT. Channel 00/19/39 was selected to test.

Mode of Operations	Frequency Range (MHz)	Data Rate (Mbps)
(BLE)	2402	1
	2440	1
	2480	1
For Conducted Emission		
Test Mode		TX Mode
For Radiated Emission		
Test Mode		TX Mode

Channel	Frequency(MHz)	Channel	Frequency(MHz)
0	2402	20	2442
1	2404	21	2444
2	2406	22	2446
--	--	--	--
--	--	--	--
18	2438	38	2478
19	2440	39	2480

The EUT has been tested under operating condition.

This test was performed with EUT in X, Y, Z position and the worst case was found when EUT in X position. AC conducted emission pre-test at both at AC 120V/60Hz and AC 240V/50Hz modes, recorded worst case(AC 120V/60Hz).

Worst-case mode and channel used for 150 KHz-30 MHz power line conducted emissions was the mode and channel with the highest output power, which was determined to be BT LE mode (MCH).

Worst-case mode and channel used for 9 KHz-1000 MHz radiated emissions was the mode and channel with the highest output power, that was determined to be BT LE mode(MCH).

## 2.6. Block Diagram of Test Setup

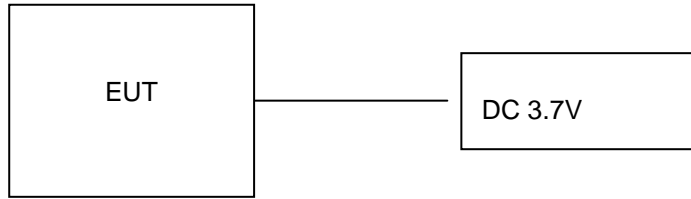

## 2.7. EUT Exercise Software

The system was configured for testing in a continuous transmits condition and change test channels by software (FCC\_assist\_1.0.2.2.exe) provided by application.

## 2.8. Special Accessories

Manufacturer	Description	Model	Serial Number	Certificate
SHENZHEN XIONGZHENGFA (TECH) CO.,LTD	Adapter	XY48-501000D	--	SDOC

Note: The Adapter is only used for auxiliary testing.

## 2.9. External I/O Cable

I/O Port Description	Quantity	Cable
DC IN Port	1	1.0M, Unscreened Cable

## 2.10. Related Submittal(s) / Grant (s)

This submittal(s) (test report) is intended for **FCC ID: 2BEBP-OS03** filing to comply with Section 15.247 of the FCC Part 15, Subpart C Rules.

## 2.11. Modifications

No modifications were implemented to meet testing criteria.

### 3. TEST ENVIRONMENT

#### 3.1. Address of the test laboratory

##### Shenzhen Global Test Service Co.,Ltd.

No.7-101 and 8A-104, Building 7 and 8, DCC Cultural and Creative Garden, No.98, Pingxin North Road, Shangmugu Community, Pinghu Street, Longgang District, Shenzhen, Guangdong,China.

#### 3.2. Test Facility

The test facility is recognized, certified, or accredited by the following organizations:

CNAS (No. CNAS L8169)

Shenzhen Global Test Service Co., Ltd. has been assessed and proved to be in compliance with CNAS-CL01 Accreditation Criteria for Testing and Calibration Laboratories (identical to ISO/IEC 17025: 2019 General Requirements) for the Competence of Testing and Calibration Laboratories.

A2LA (Certificate No. 4758.01)

Shenzhen Global Test Service Co., Ltd. has been assessed by the American Association for Laboratory Accreditation (A2LA). Certificate No. 4758.01.

Industry Canada Registration Number. is 24189.

FCC Designation Number is CN1234.

FCC Registered Test Site Number is165725.

#### 3.3. Environmental conditions

During the measurement the environmental conditions were within the listed ranges:

Temperature:	15-35 ° C
Humidity:	30-60 %
Atmospheric pressure:	950-1050mbar

#### 3.4. Statement of the measurement uncertainty

The data and results referenced in this document are true and accurate. The reader is cautioned that there may be errors within the calibration limits of the equipment and facilities. The measurement uncertainty was calculated for all measurements listed in this test report acc. to CISPR 16 - 4 „Specification for radio disturbance and immunity measuring apparatus and methods – Part 4: Uncertainty in EMC Measurements“ and is documented in the Shenzhen Global Test Service Co.,Ltd. quality system acc. to DIN EN ISO/IEC 17025. Furthermore, component and process variability of devices similar to that tested may result in additional deviation. The manufacturer has the sole responsibility of continued compliance of the device.

Hereafter the best measurement capability for Shenzhen GTS laboratory is reported:

Test	Range	Measurement Uncertainty	Notes
Radiated Emission	30~1000MHz	4.10 dB	(1)
Radiated Emission	1~18GHz	4.32 dB	(1)
Radiated Emission	18-40GHz	5.54 dB	(1)
Conducted Disturbance	0.15~30MHz	3.12 dB	(1)

This uncertainty represents an expanded uncertainty expressed at approximately the 95% confidence level using a coverage factor of k=2.



### 3.5. Test Description

Applied Standard: FCC Part 15 Subpart C				
FCC Rules	Description of Test	Test Sample	Result	Remark
/	On Time and Duty Cycle	GTS20240118008-1-S0001-3#	/	/
§15.247(b)	Maximum Conducted Output Power	GTS20240118008-1-S0001-3#	Compliant	Appendix B
§15.247(e)	Power Spectral Density	GTS20240118008-1-S0001-3#	Compliant	Appendix B
§15.247(a)(2)	6dB Bandwidth	GTS20240118008-1-S0001-3#	Compliant	Appendix B
§2.1047	99% Occupied Bandwidth	GTS20240118008-1-S0001-3#	Compliant	Appendix B
§15.209, §15.247(d)	Conducted Spurious Emissions and Band Edges Test	GTS20240118008-1-S0001-3#	Compliant	Appendix B
§15.209, §15.247(d)	Radiated Spurious Emissions	GTS20240118008-1-S0001-3# GTS20240118008-1-S0001-4#	Compliant	Note 1
§15.205	Emissions at Restricted Band	GTS20240118008-1-S0001-3#	Compliant	Appendix B
§15.207(a)	AC Conducted Emissions	GTS20240118008-1-S0001-4#	Compliant	Note 1
§15.203 §15.247(c)	Antenna Requirements	GTS20240118008-1-S0001-3#	Compliant	Note 1
§15.247(i)§2.1093	RF Exposure	/	Compliant	Note 2

Remark:

1. The measurement uncertainty is not included in the test result.
2. NA = Not Applicable; NP = Not Performed
3. Note 1 – Test results inside test report;
4. Note 2 – Test results in other test report (MPE Report).
5. We tested all test mode and recorded worst case in report

### 3.6. Equipments Used during the Test

Test Equipment	Manufacturer	Model No.	Serial No.	Calibration Date	Calibration Due Date
LISN	CYBERTEK	EM5040A	E1850400105	2023/07/13	2024/07/12
LISN	R&S	ESH2-Z5	893606/008	2023/07/13	2024/07/12
EMI Test Receiver	R&S	ESPI3	101841-cd	2023/07/14	2024/07/13
EMI Test Receiver	R&S	ESCI7	101102	2023/07/13	2024/07/12
Spectrum Analyzer	Agilent	N9020A	MY48010425	2023/08/28	2024/08/27
Spectrum Analyzer	R&S	FSV40	100019	2023/07/13	2024/07/12
Vector Signal generator	Agilent	N5181A	MY49060502	2023/07/13	2024/07/12
Signal generator	Agilent	N5182A	3610AO1069	2023/07/13	2024/07/12
Climate Chamber	ESPEC	EL-10KA	A20120523	2023/07/13	2024/07/12
Controller	EM Electronics	Controller EM 1000	N/A	N/A	N/A
Horn Antenna	Schwarzbeck	BBHA 9120D	01622	2023/07/13	2024/07/12
Active Loop Antenna	Beijing Da Ze Technology Co.,Ltd.	ZN30900C	15006	2023/07/13	2024/07/12
Bilog Antenna	Schwarzbeck	VULB9163	000976	2023/07/13	2024/07/12
Broadband Horn Antenna	SCHWARZBECK	BBHA 9170	791	2023/07/13	2024/07/12
Antenna Tower	Suzhou Keletuo electronic Technology Co., LTD	BK-*AT-BS	N/A	N/A	N/A
Amplifier	Schwarzbeck	BBV 9743	#202	2023/07/14	2024/07/13
Amplifier	Schwarzbeck	BBV9179	9719-025	2023/07/14	2024/07/13
Amplifier	EMCI	EMC051845B	980355	2023/07/14	2024/07/13
Temperature/Humidity Meter	Gangxing	CTH-608	02	2023/07/13	2024/07/12
High-Pass Filter	K&L	9SH10-2700/X12750-O/O	KL142031	2023/08/30	2024/08/29
High-Pass Filter	K&L	41H10-1375/U12750-O/O	KL142032	2023/08/30	2024/08/29
RF Cable(below 1GHz)	HUBER+SUHNER	RG214	RE01	2023/07/13	2024/07/12
RF Cable(above 1GHz)	HUBER+SUHNER	RG214	RE02	2023/07/13	2024/07/12
Data acquisition card	Agilent	U2531A	TW53323507	2023/07/13	2024/07/12
Power Sensor	Agilent	U2021XA	MY5365004	2023/07/13	2024/07/12
Test Control Unit	Tonscend	JS0806-1	178060067	2023/07/13	2024/07/12
Automated filter bank	Tonscend	JS0806-F	19F8060177	2023/07/13	2024/07/12
EMI Test Software	Tonscend	JS1120-1	Ver 2.6.8.0518	/	/
EMI Test Software	Tonscend	JS1120-3	Ver 2.5.77.0418	/	/
EMI Test Software	Tonscend	JS32-CE	Ver 2.5	/	/
EMI Test Software	Tonscend	JS32-RE	Ver 2.5.1.8	/	/

Note: 1. The Cal.Interval was one year.

## 4. TEST CONDITIONS AND RESULTS

### 4.1. AC Power Conducted Emission

#### TEST CONFIGURATION

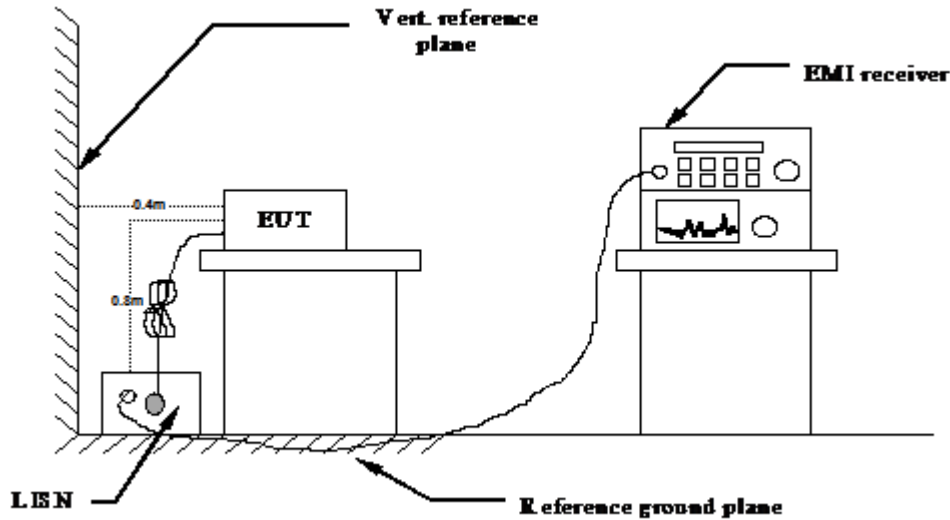

#### TEST PROCEDURE

- 1 The equipment was set up as per the test configuration to simulate typical actual usage per the user's manual. The EUT is a tabletop system, a wooden table with a height of 0.8 meters is used and is placed on the ground plane as per ANSI C63.10-2020.
- 2 Support equipment, if needed, was placed as per ANSI C63.10-2020
- 3 All I/O cables were positioned to simulate typical actual usage as per ANSI C63.10-2020
- 4 The EUT received DC 5V power, the adapter received AC120V/60Hz or AC 240V/50Hz power through a Line Impedance Stabilization Network (LISN) which supplied power source and was grounded to the ground plane.
- 5 All support equipments received AC power from a second LISN, if any.
- 6 The EUT test program was started. Emissions were measured on each current carrying line of the EUT using a spectrum Analyzer / Receiver connected to the LISN powering the EUT. The LISN has two monitoring points: Line 1 (Hot Side) and Line 2 (Neutral Side). Two scans were taken: one with Line 1 connected to Analyzer / Receiver and Line 2 connected to a 50 ohm load; the second scan had Line 1 connected to a 50 ohm load and Line 2 connected to the Analyzer / Receiver.
- 7 Analyzer / Receiver scanned from 150 KHz to 30MHz for emissions in each of the test modes.
- 8 During the above scans, the emissions were maximized by cable manipulation.

#### AC Power Conducted Emission Limit

For intentional device, according to § 15.207(a) AC Power Conducted Emission Limits is as following :

Frequency range (MHz)	Limit (dBuV)	
	Quasi-peak	Average
0.15-0.5	66 to 56*	56 to 46*
0.5-5	56	46
5-30	60	50

\* Decreases with the logarithm of the frequency.

#### DISTURBANCE Calculation

The AC mains conducted disturbance is calculated by adding the 10dB Pulse Limiter and Cable Factor and Duty Cycle Correction Factor (if any) from the measured reading. The basic equation with a sample calculation is as follows:

$$CD \text{ (dBuV)} = RA \text{ (dBuV)} + PL \text{ (dB)} + CL \text{ (dB)}$$

Where CD = Conducted Disturbance	CL = Cable Attenuation Factor (Cable Loss)
RA = Reading Amplitude	PL = 10 dB Pulse Limiter Factor

**TEST RESULTS**

Remark: We measured Conducted Emission at GFSK mode from 150 KHz to 30MHz in AC120V and the worst case was recorded.

Temperature	25°C	Humidity	60%
Test Engineer	Evan Ouyang	Configurations	BT

Power supply:	AC 120V/60Hz	Polarization	L
---------------	--------------	--------------	---

**Test Graph**

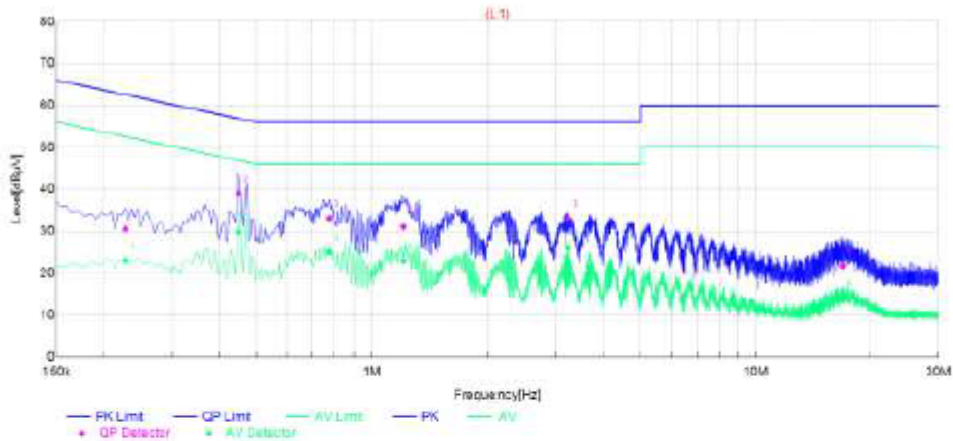

Final Data List												
NO.	Frequency	QP Reading	AVG. Reading	Factor	QP Result	AVG. Result	QP Limit	AVG. Limit	QP Margin	AVG. Margin	Line	Remark
1	0.2269	20.39	12.84	10.14	30.53	22.98	62.56	52.56	32.03	29.58	L1	PASS
2	0.4479	28.85	19.54	10.21	39.06	29.75	56.91	46.91	17.85	17.16	L1	PASS
3	0.7740	22.81	14.82	10.25	33.06	25.07	56.00	46.00	22.94	20.93	L1	PASS
4	1.2081	20.86	12.65	10.21	31.07	22.86	56.00	46.00	24.93	23.14	L1	PASS
5	3.2280	22.68	15.72	10.35	33.03	26.07	56.00	46.00	22.97	19.93	L1	PASS
6	16.8531	10.41	2.99	11.21	21.62	14.20	60.00	50.00	38.38	35.80	L1	PASS

Note:1. Result (dBµV) = Reading (dBµV) + Factor (dB).

2. Factor (dB) = Cable loss (dB) + LISN Factor (dB).

Power supply:	AC 120V/60Hz	Polarization	N
---------------	--------------	--------------	---

**Test Graph**

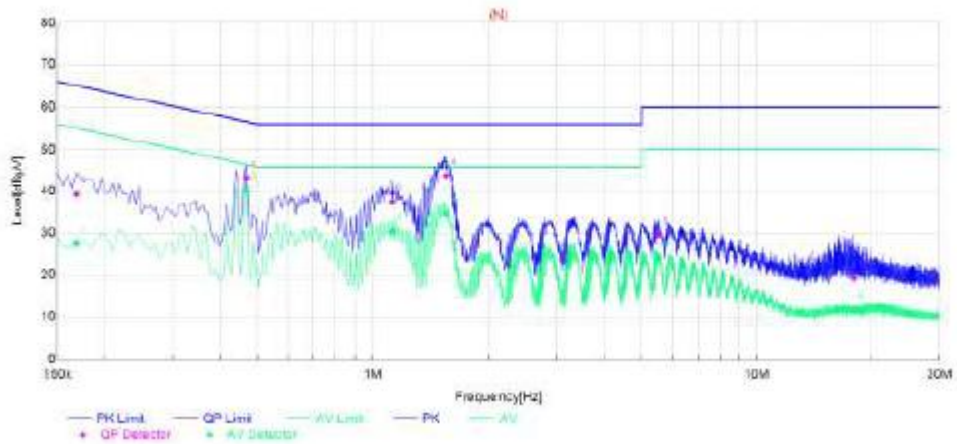

Final Data List												
NO.	Frequency	QP Reading	AVG. Reading	Factor	QP Result	AVG. Result	QP Limit	AVG. Limit	QP Margin	AVG. Margin	Line	Remark
1	0.1677	29.05	17.16	10.27	39.32	27.43	65.07	55.07	25.75	27.64	N	PASS
2	0.4670	32.96	29.97	10.23	43.19	40.20	56.57	46.57	13.38	6.37	N	PASS
3	1.1230	27.26	20.17	10.21	37.47	30.38	56.00	46.00	18.53	15.62	N	PASS
4	1.5551	33.46	24.21	10.24	43.70	34.45	56.00	46.00	12.30	11.55	N	PASS
5	5.5242	19.06	13.50	10.42	29.48	23.92	60.00	50.00	30.52	26.08	N	PASS
6	17.9190	7.92	0.36	11.26	19.18	11.62	60.00	50.00	40.82	38.38	N	PASS

Note:1. Result (dBµV) = Reading (dBµV) + Factor (dB).

2. Factor (dB) = Cable loss (dB) + LISN Factor (dB).

## 4.2. Radiated Emission

### TEST CONFIGURATION

Frequency range 9 KHz – 30MHz

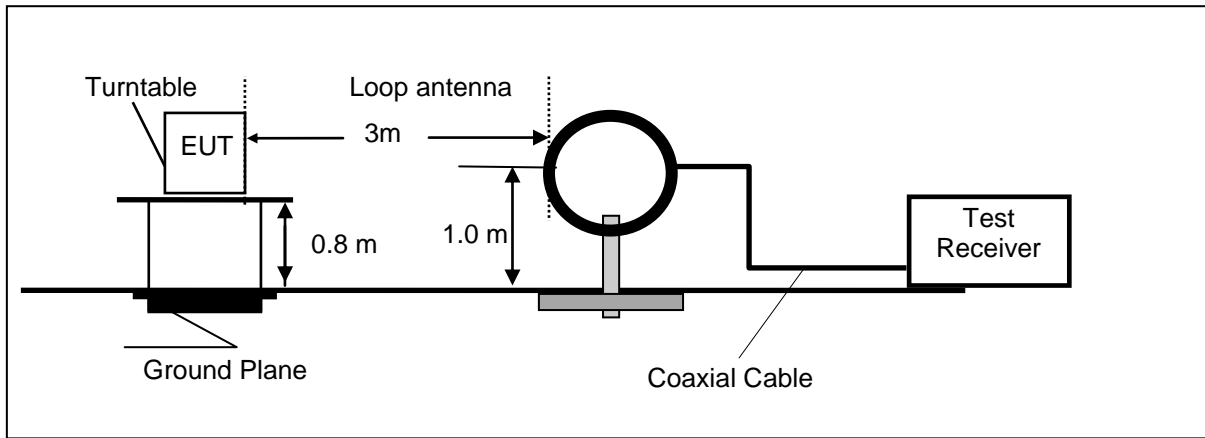

Frequency range 30MHz – 1000MHz

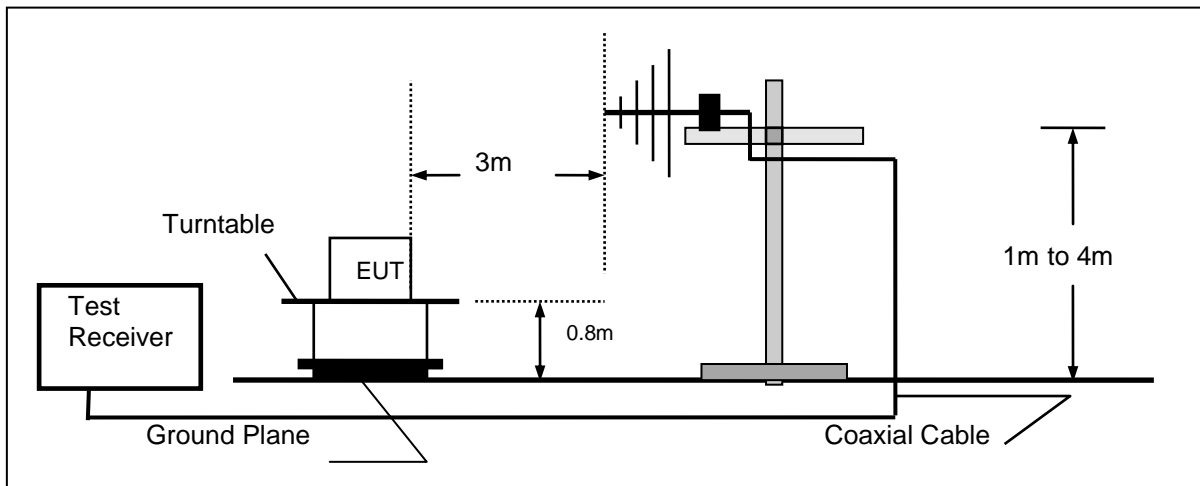

Frequency range above 1GHz-25GHz

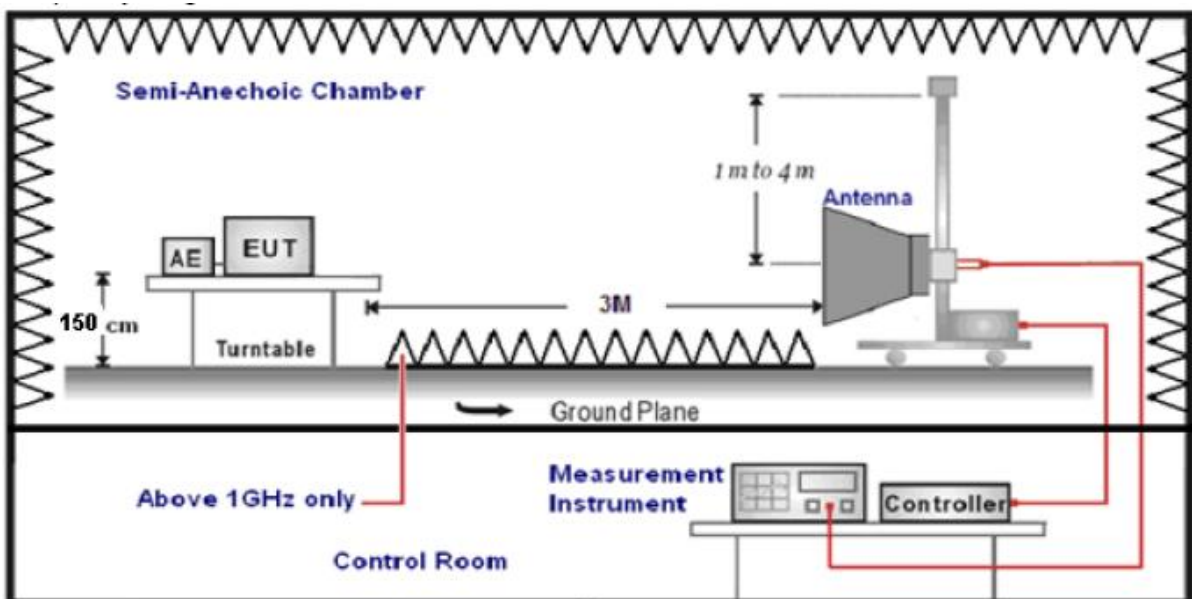

**TEST PROCEDURE**

1. The EUT was placed on a turn table which is 0.8m above ground plane when testing frequency range 9 KHz –1GHz;the EUT was placed on a turn table which is 1.5m above ground plane when testing frequency range 1GHz – 25GHz.
2. Maximum procedure was performed by raising the receiving antenna from 1m to 4m and rotating the turn table from 0° to 360° to acquire the highest emissions from EUT.
3. And also, each emission was to be maximized by changing the polarization of receiving antenna both horizontal and vertical.
4. Repeat above procedures until all frequency measurements have been completed.
5. Radiated emission test frequency band from 30MHz to 25GHz.
6. The distance between test antenna and EUT as following table states:

Test Frequency range	Test Antenna Type	Test Distance
9KHz-30MHz	Active Loop Antenna	3
30MHz-1GHz	Ultra-Broadband Antenna	3
1GHz-18GHz	Double Ridged Horn Antenna	3
18GHz-25GHz	Horn Antenna	1

7. Setting test receiver/spectrum as following table states:

Test Frequency range	Test Receiver/Spectrum Setting	Detector
9KHz-150KHz	RBW=200Hz/VBW=3KHz, Sweep time=Auto	QP
150KHz-30MHz	RBW=9KHz/VBW=100KHz, Sweep time=Auto	QP
30MHz-1GHz	RBW=120KHz/VBW=1000KHz, Sweep time=Auto	QP
1GHz-40GHz	Peak Value: RBW=1MHz/VBW=3MHz, Sweep time=Auto Average Value: RBW=1MHz/VBW=10Hz, Sweep time=Auto	Peak

**Field Strength Calculation**

The field strength is calculated by adding the Antenna Factor and Cable Factor and subtracting the Amplifier Gain and Duty Cycle Correction Factor(if any) from the measured reading. The basic equation with a sample calculation is as follows:

**FS = RA + AF + CL - AG**

Where FS = Field Strength	CL = Cable Attenuation Factor (Cable Loss)
RA = Reading Amplitude	AG = Amplifier Gain
AF = Antenna Factor	

Transd=AF +CL-AG

**RADIATION LIMIT**

For intentional device, according to § 15.209(a), the general requirement of field strength of radiated emission from intentional radiators at a distance of 3 meters shall not exceed the following table. According to § 15.247(d), in any 100kHz bandwidth outside the frequency band in which the EUT is operating, the radio frequency power that is produced by the intentional radiator shall be at least 20dB below that in the 100kHz bandwidth within the band that contains the highest level of desired power.

The pre-test have done for the EUT in three axes and found the worst emission at position shown in test setup photos.

Frequency (MHz)	Distance (Meters)	Radiated (dB $\mu$ V/m)	Radiated ( $\mu$ V/m)
0.009-0.49	3	$20\log(2400/F(\text{KHz}))+40\log(300/3)$	2400/F(KHz)
0.49-1.705	3	$20\log(24000/F(\text{KHz}))+40\log(30/3)$	24000/F(KHz)
1.705-30	3	$20\log(30)+40\log(30/3)$	30
30-88	3	40.0	100
88-216	3	43.5	150
216-960	3	46.0	200
Above 960	3	54.0	500

**TEST RESULTS**

Remark: We measured Radiated Emission at GFSK mode from 9KHz to 25GHz in AC120V and the worst case was recorded.

Temperature	25°C	Humidity	55%
Test Engineer	Evan Ouyang	Configurations	BT

**For 9 KHz~30MHz**

Freq. (MHz)	Level (dB $\mu$ V)	Over Limit (dB)	Over Limit (dB $\mu$ V)	Remark
-	-	-	-	See Note

**Note:**

The amplitude of spurious emissions which are attenuated by more than 20 dB below the permissible value has no need to be reported.

Distance extrapolation factor =  $40 \log(\text{specific distance} / \text{test distance})$  (dB);

Limit line = specific limits (dB $\mu$ V) + distance extrapolation factor.



For 30MHz to 1000MHz

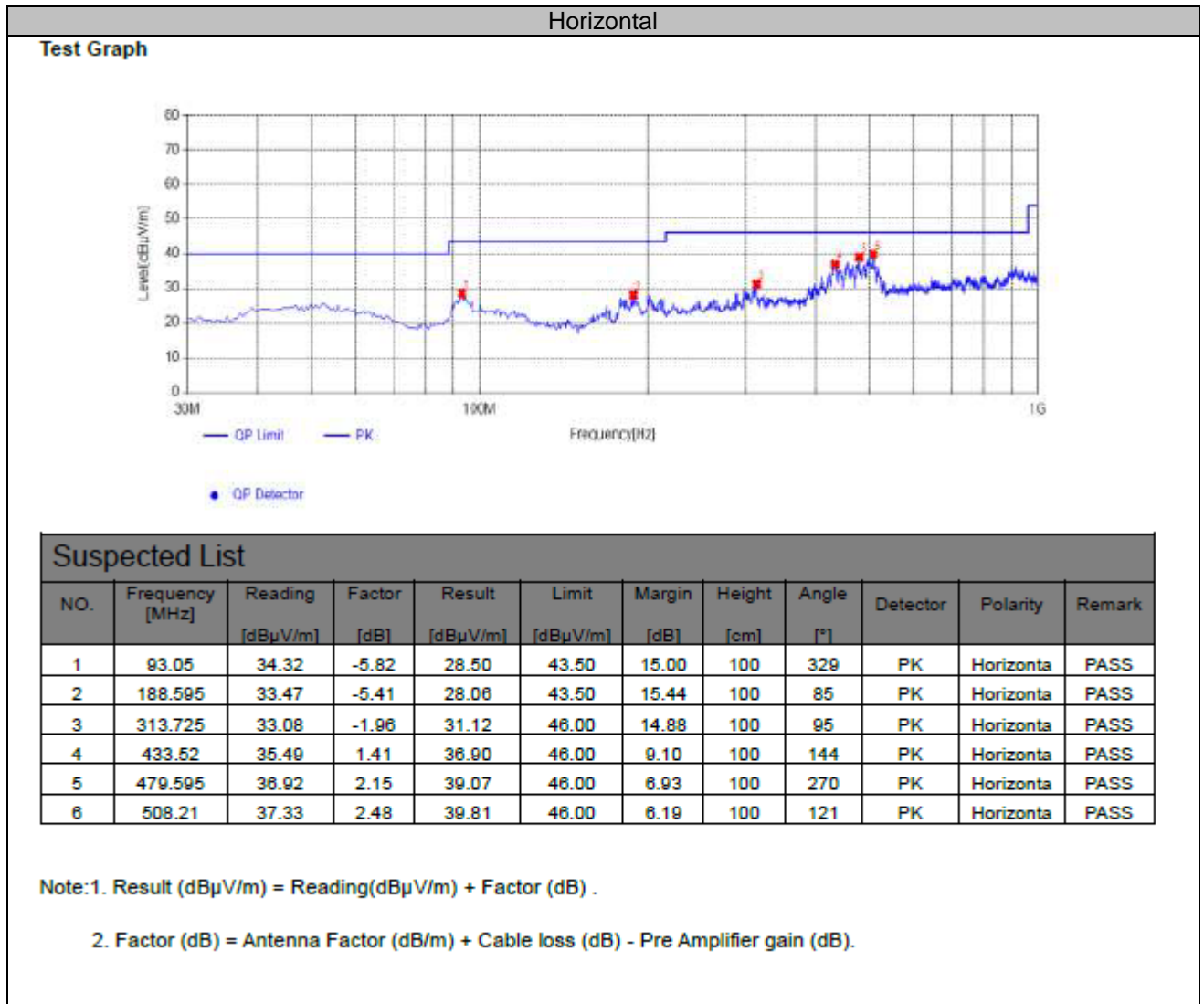

Vertical

Test Graph

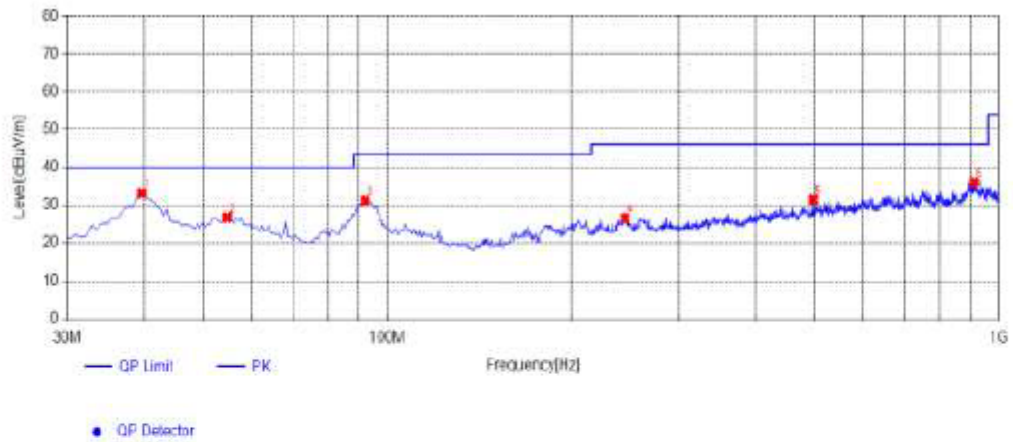

Suspected List

NO.	Frequency [MHz]	Reading [dBµV/m]	Factor [dB]	Result [dBµV/m]	Limit [dBµV/m]	Margin [dB]	Height [cm]	Angle [°]	Detector	Polarity	Remark
1	39.7	37.80	-4.60	33.20	40.00	6.80	100	310	PK	Vertical	PASS
2	54.735	30.58	-3.81	26.77	40.00	13.23	100	59	PK	Vertical	PASS
3	92.08	37.33	-6.17	31.16	43.50	12.34	100	327	PK	Vertical	PASS
4	244.855	30.05	-3.37	26.68	46.00	19.32	100	10	PK	Vertical	PASS
5	497.055	29.05	2.39	31.44	46.00	14.56	100	217	PK	Vertical	PASS
6	911.245	27.84	8.28	36.12	46.00	9.88	100	138	PK	Vertical	PASS

Note:1. Result (dBµV/m) = Reading(dBµV/m) + Factor (dB) .

2. Factor (dB) = Antenna Factor (dB/m) + Cable loss (dB) - Pre Amplifier gain (dB).

## For 1GHz to 25GHz

BT LE

Channel 0 / 2402 MHz

Freq. MHz	Reading dBuV	Ant. Fac. dB/m	Pre. Fac. dB	Cab. Loss dB	Measured dBuV/m	Limit dBuV/m	Margin dB	Remark	Pol.
4804.00	50.85	32.44	30.25	7.95	60.99	74.00	-13.01	Peak	Horizontal
4804.00	35.85	32.44	30.25	7.95	45.99	54.00	-8.01	Average	Horizontal
4804.00	52.87	32.44	30.25	7.95	63.01	74.00	-10.99	Peak	Vertical
4804.00	36.22	32.44	30.25	7.95	46.36	54.00	-7.64	Average	Vertical

Channel 19 / 2440 MHz

Freq. MHz	Reading dBuV	Ant. Fac. dB/m	Pre. Fac. dB	Cab. Loss dB	Measured dBuV/m	Limit dBuV/m	Margin dB	Remark	Pol.
4880.00	50.65	32.52	30.31	8.12	60.98	74.00	-13.02	Peak	Horizontal
4880.00	37.99	32.52	30.31	8.12	48.32	54.00	-5.68	Average	Horizontal
4880.00	51.47	32.52	30.31	8.12	61.80	74.00	-12.20	Peak	Vertical
4880.00	36.27	32.52	30.31	8.12	46.60	54.00	-7.40	Average	Vertical

Channel 39 / 2480 MHz

Freq. MHz	Reading dBuV	Ant. Fac. dB/m	Pre. Fac. dB	Cab. Loss dB	Measured dBuV/m	Limit dBuV/m	Margin dB	Remark	Pol.
4960.00	50.08	32.68	30.27	7.88	60.37	74.00	-13.63	Peak	Horizontal
4960.00	35.40	32.68	30.27	7.88	45.69	54.00	-8.31	Average	Horizontal
4960.00	49.21	32.68	30.27	7.88	59.50	74.00	-14.50	Peak	Vertical
4960.00	32.41	32.68	30.27	7.88	42.70	54.00	-11.30	Average	Vertical

## Notes:

- 1). Measuring frequencies from 9 KHz~10<sup>th</sup> harmonic or 26.5GHz (which is less), No emission found between lowest internal used/generated frequency to 30MHz.
- 2). Radiated emissions measured in frequency range from 9 KHz~10<sup>th</sup> harmonic or 26.5GHz (which is less) were made with an instrument using Peak detector mode.
- 3). Data of measurement within this frequency range shown " --- " in the table above means the reading of emissions are attenuated more than 20dB below the permissible limits or the field strength is too small to be measured.
- 4). Measured= Reading- Pre. Fac.+ Ant. Fac.+ Cab. Loss
- 5). Margin = Measured- Limit

### 4.3. Maximum Peak Output Power

#### TEST CONFIGURATION

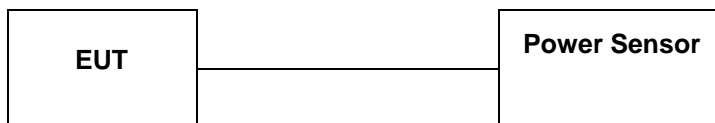

#### TEST PROCEDURE

According to KDB 558074 D01 15.247 Measurement Guidance v05r02 Section 8.3.1 Maximum peak conducted output power, 8.3.1.3 The maximum peak conducted output power may be measured using a broadband peak RF power meter. The power meter shall have a video bandwidth that is greater than or equal to the DTS bandwidth and shall utilize a fast-responding diode detector.

#### LIMIT

The Maximum Peak Output Power Measurement is 30dBm.

#### TEST RESULTS

For reporting purpose only.

Please refer to Appendix B.3.

#### 4.4. Power Spectral Density

##### TEST CONFIGURATION

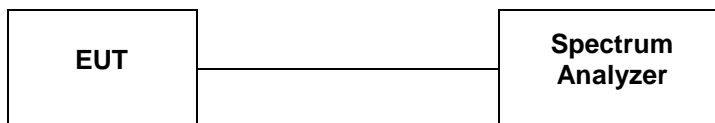

##### TEST PROCEDURE

1. Use this procedure when the maximum peak conducted output power in the fundamental emission is used to demonstrate compliance.
2. Set the RBW = 3 kHz.
3. Set the VBW = 10 KHz.
4. Set the span to 1.5 times the DTS channel bandwidth.
5. Detector = peak.
6. Sweep time = auto couple.
7. Trace mode = max hold.
8. Allow trace to fully stabilize.
9. Use the peak marker function to determine the maximum power level.
10. If measured value exceeds limit, reduce RBW (no less than 3 kHz) and repeat.
11. The resulting peak PSD level must be 8 dBm.

##### LIMIT

For digitally modulated systems, the power spectral density conducted from the intentional radiator to the antenna shall not be greater than 8 dBm in any 3 kHz band during any time interval of continuous transmission.

##### TEST RESULTS

For reporting purpose only.

Please refer to Appendix B.4.

## 4.5. 99% and 6dB Bandwidth

### TEST CONFIGURATION

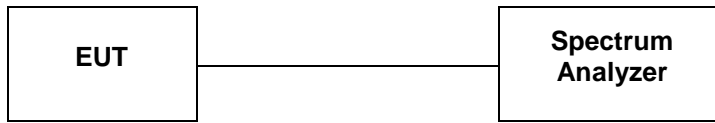

### TEST PROCEDURE

The transmitter output was connected to the spectrum analyzer through an attenuator. The bandwidth of the fundamental frequency was measured by spectrum analyzer with RBW=100 KHz and VBW=300KHz. The 6dB bandwidth is defined as the total spectrum the power of which is higher than peak power minus 6dB. According to KDB 558074 D01 DTS Meas Guidance v05r02 for one of the following procedures may be used to determine the modulated DTS device signal bandwidth.

1. Set RBW = 100 kHz.
2. Set the video bandwidth (VBW)  $\geq 3$  RBW.
3. Detector = Peak.
4. Trace mode = max hold.
5. Sweep = auto couple.
6. Allow the trace to stabilize.
7. Measure the maximum width of the emission that is constrained by the frequencies associated with the two outermost amplitude points (upper and lower frequencies) that are attenuated by 6 dB relative to the maximum level measured in the fundamental emission.

### LIMIT

For digital modulation systems, the minimum 6 dB bandwidth shall be at least 500 kHz

### TEST RESULTS

For reporting purpose only.

Please refer to Appendix B.1.

Please refer to Appendix B.2.

### 4.6. Conducted Spurious Emissions and Band Edge Compliance of RF Emission

#### TEST REQUIREMENT

In any 100 kHz bandwidth outside the frequency band in which the spread spectrum or digitally modulated intentional radiator is operating, the radio frequency power that is produced by the intentional radiator shall be at least 20 dB below that in the 100 kHz bandwidth within the band that contains the highest level of the desired power, based on either an RF conducted or a radiated measurement, provided the transmitter demonstrates compliance with the peak conducted power limits. If the transmitter complies with the conducted power limits based on the use of RMS averaging over a time interval, as permitted under paragraph (b)(3) of this section, the attenuation required under this paragraph shall be 30 dB instead of 20 dB. Attenuation below the general limits specified in §15.209(a) is not required. In addition, radiated emissions which fall in the restricted bands, as defined in §15.205(a), must also comply with the radiated emission limits specified in §15.209(a) (see §15.205(c)).

#### TEST CONFIGURATION

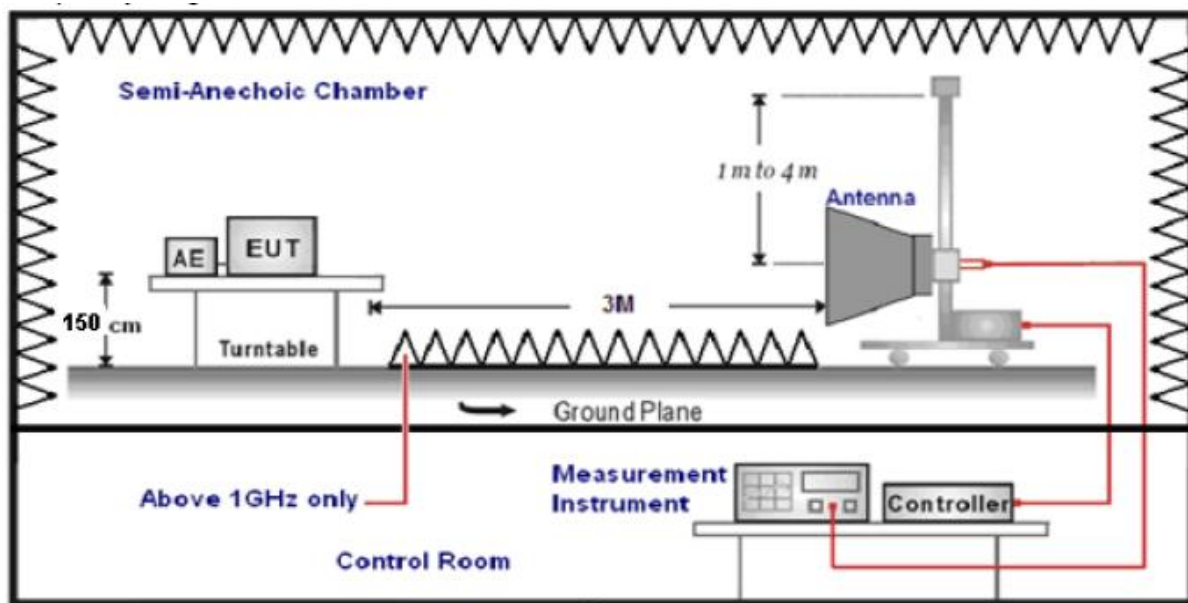

#### TEST PROCEDURE

1. The EUT was placed on a turn table which is 1.5m above ground plane.
2. Maximum procedure was performed by raising the receiving antenna from 1m to 4m and rotating the turn table from 0° to 360° to acquire the highest emissions from EUT.
3. And also, each emission was to be maximized by changing the polarization of receiving antenna both horizontal and vertical.
4. Repeat above procedures until all frequency measurements have been completed..
5. The distance between test antenna and EUT was 3 meter:
6. Setting test receiver/spectrum as following table states:

Test Frequency range	Test Receiver/Spectrum Setting	Detector
1GHz-40GHz	Peak Value: RBW=1MHz/VBW=3MHz, Sweep time=Auto Average Value: RBW=1MHz/VBW=10Hz, Sweep time=Auto	Peak

#### LIMIT

Below -20dB of the highest emission level in operating band.  
Radiated emissions which fall in the restricted bands, as defined in § 15.205(a), must also comply with the radiated emission limits specified in § 15.209(a)

**TEST RESULTS**

**4.6.1 For Conducted at Restricted Band Measurement**

For reporting purpose only.

Please refer to Appendix B.7.

**4.6.2 For Conducted Bandedge Measurement**

For reporting purpose only.

Please refer to Appendix B.5.

**4.6.3 For Conducted Spurious Emissions Measurement**

For reporting purpose only.

Please refer to Appendix B.6.



## 4.7. Antenna Requirement

### Standard Applicable

For intentional device, according to FCC 47 CFR Section 15.203, an intentional radiator shall be designed to ensure that no antenna other than that furnished by the responsible party shall be used with the device.

And according to FCC 47 CFR Section 15.247 (c), if transmitting antennas of directional gain greater than 6dBi are used, the power shall be reduced by the amount in dB that the directional gain of the antenna exceeds 6dBi.

### Test Result

The antenna used for this product is Internal Antenna and that no antenna other than that furnished by the responsible party shall be used with the device, the maximum peak gain of the transmit antenna is only 1.95 dBi.

Reference to the Test Report: **GTS20240118008-1-20**.

**5. TEST SETUP PHOTOS OF THE EUT**

Reference to the Test Report: GTS20240118008-1-20.

**6. EXTERNAL AND INTERNAL PHOTOS OF THE EUT**

Reference to the Test Report: GTS20240118008-1-20.

.....**End of Report**.....