

2.4GHz 2012 Chip Antenna: RANT2012F245C05



Application:

WLAN, 802.11b/g, Bluetooth, WLAN, etc...

Features

SMD, high reliability, ultra Impact, Omni-directional...



Part number Information

RANT 2012 F 245 C 05
(A) (B) (C) (D) (E) (F)

| | |
|------------------|-----------------------|
| (A)Product Type | Chip Antenna |
| (B) Size Code | 2.0x1.2mm(+0.2mm) |
| (C) Material | High K material |
| (D) Frequency | 2.4 ~ 2.5GHz |
| (E) Feeding mode | PIFA & Single Feeding |
| (F) Antenna type | Type=05 |

Electrical Specification

| | |
|-------------------------------|--------------------|
| Working Frequency Range | 2400 ~2484 MHz |
| Bandwidth | 84 (Min.) |
| Peak Gain | 1.95dBi |
| Impedance | 50 Ohm |
| Return loss | 10 dB (Min) |
| Polarization | Linear |
| Azimuth Beamwidth | Omni-directional |
| Operation Temperature(°C) | -40 ~85°C |
| Resistance to Soldering Heats | 10sec. (@ 280°C) |
| Termination | Ni / Au (Leadless) |

The specification is defined on EVB.

Dimension and Terminal Configuration

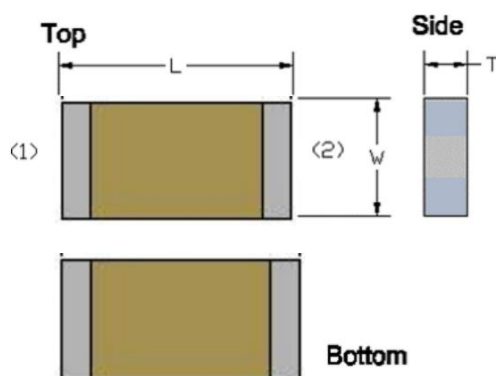

| Dimension (mm) | |
|----------------|-----------|
| L | 2.05±0.15 |
| W | 1.20±0.15 |
| T | 0.85±0.10 |

| No. | Terminal Name |
|-----|---------------|
| 1 | Feeding/GNG |
| 2 | GND |

咏成國際科技有限公司

RAIN International Technology Co., Ltd.

Address: Room 709, Building F, Yuxing Science and Technology
Industrial Park, Nanchang Third Industrial Zone,
Nanchang Community, Xixiang Street, Bao'an District,
Shenzhen, China

電話: 13530576606
TEL: 13530576606



Evaluation Board Reference

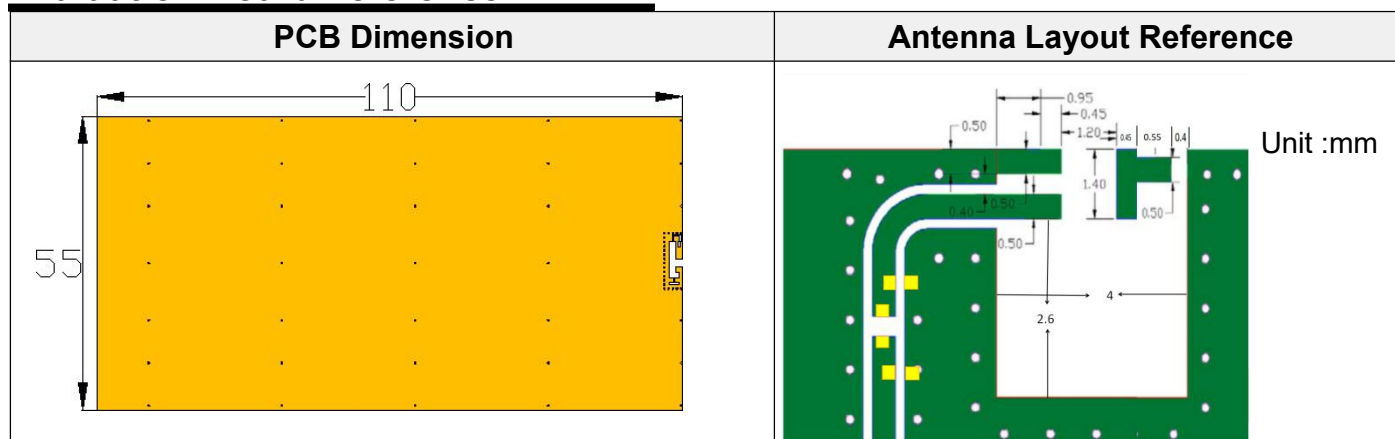

Electrical Characteristics

Return Loss & Radiation

Return Loss

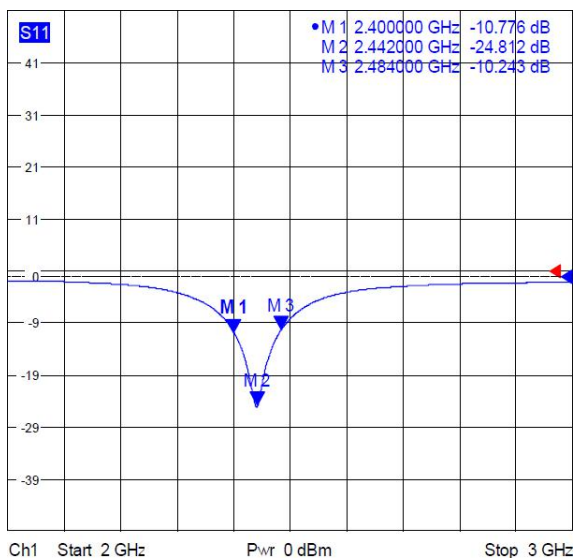

| Frequency(MHz) | S11 (dB) |
|----------------|----------|
| 2400 | -10.77 |
| 2450 | -24.81 |
| 2484 | -10.243 |

Radiation

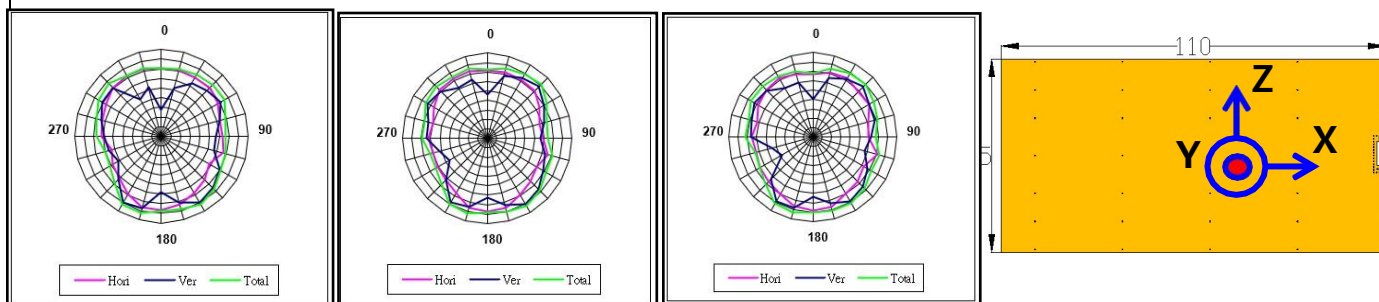

| | 2400MHz | 2450MHz | 2500MHz |
|-------------|----------|----------|----------|
| Efficiency | 70.56% | 75.25% | 71.01% |
| Peak Gain | 1.72 dBi | 1.95 dBi | 1.69 dBi |
| Directivity | 2.26 dBi | 2.69 dBi | 2.11 dBi |

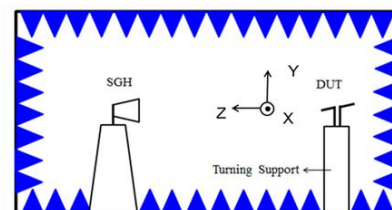

Taping Specifications

Reel and Taping Specification

Reel Specification

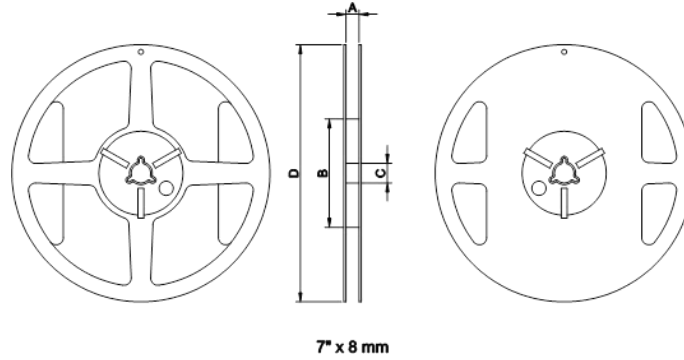

| TYPE | SIZE | | A | B | C | D |
|------|------|---------|---------|------|----------|-------|
| 2012 | 7" | 5K/Reel | 9.0±0.5 | 60±2 | 13.5±0.5 | 178±2 |

Tapping Specification

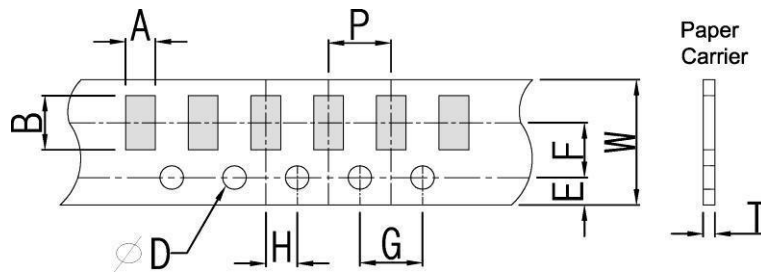

| Packaging | Type | A | B | W | E | F | G | H | T | D | P |
|------------|------|-----------|-----------|----------|-----------|----------|----------|----------|-----------|-----------|---------|
| Paper Type | 2012 | 1.50±0.20 | 2.30±0.20 | 8.0±0.20 | 1.75±0.10 | 3.5±0.05 | 4.0±0.10 | 2.0±0.05 | 0.75±0.10 | 1.57±0.10 | 4.0±0.1 |

Reliability Table

| Test Item | Procedure | Requirements Ceramic Type | Remark (Reference) |
|--|---|---|---------------------------|
| Electrical Characterization | | Fulfill the electrical specification | User Spec. |
| Thermal Shock | 1. Preconditioning: $50 \pm 10^\circ\text{C}$ / 1 hr , then keep for 24 ± 1 hrs at room temp. 2. Initial measure: Spec: refer Initial spec. 3. Rapid change of temperature test: -30°C to $+85^\circ\text{C}$; 100 cycles; 15 minutes at Lower category temperature; 15 minutes at Upper category temperature. | No Visible Damage. Fulfill the electrical specification. | MIL-STD-202 107 |
| Temperature Cycling | 1. Initial measure: Spec: refer Initial spec. 2. 100 Cycles (-30°C to $+85^\circ\text{C}$), Soak Mode=1 (2 Cycle/hours). 3. Measurement at 24 ± 2 Hours after test condition. | No Visible Damage. Fulfill the electrical specification. | JESD22 JA104 |
| High Temperature Exposure | 1. Initial measure: Spec: refer Initial spec. 2. Unpowered; 500hours @ $T=+85^\circ\text{C}$. 3. Measurement at 24 ± 2 hours after test. | No Visible Damage. Fulfill the electrical specification. | MIL-STD-202 108 |
| Low Temperature Storage | 1. Initial measure: Spec: refer Initial spec. 2. Unpowered: 500hours @ $T=-30^\circ\text{C}$. 3. Measurement at 24 ± 2 hours after test. | No Visible Damage. Fulfill the electrical specification. | MIL-STD-202 108 |
| Solderability (SMD Bottom Side) | Dipping method: a. Temperature: $235 \pm 5^\circ\text{C}$ b. Dipping time: $3 \pm 0.5\text{s}$ | The solder should cover over 95% of the critical area of bottom side. | IEC 60384-21/22 4.10 |
| Soldering Heat Resistance (RSH) | Preheating temperature: $150 \pm 10^\circ\text{C}$. Preheating time: 1~2 min. Solder temperature: $260 \pm 5^\circ\text{C}$. Dipping time: $5 \pm 0.5\text{s}$ | No Visible Damage. | IEC 60384-21/22 4.10 |
| Vibration | 5g's for 20 min., 12 cycles each of 3 orientations Note: Use 8"X5" PCB .031" thick 7 secure points on, one long side and 2 secure points at corners of opposite sides. Parts mounted within 2" from any secure point. Test from 10-2000 Hz. | No Visible Damage. | MIL-STD-202 Method 204 |
| Mechanical Shock | Three shocks in each direction shall be applied along the three mutually perpendicular axes of the test specimen (18 shocks) Peak value: 1,500g's Duration: 0.5ms Velocity change: 15.4 ft/s Waveform: Half-sine | No Visible Damage. | MIL-STD-202 Method 213 |
| Humidity Bias | 1. Humidity: 85% R.H., Temperature: $85 \pm 2^\circ\text{C}$. 2. Time: 500 ± 24 hours. 3. Measurement at 24 ± 2 hrs after testcondition. | No Visible Damage. Fulfill the electrical specification. | MIL-STD-202 Method 106 |

2.4GHz 2012 Chip Antenna: RANT2012F245C05

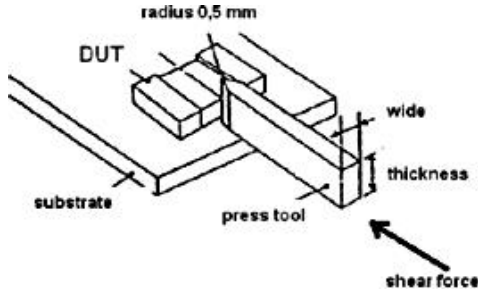
| | | | |
|---------------------------|---|--|---------------------|
| Board Flex (SMD) | <p>1. Mounting method: IR-Reflow. PCB Size (L:100 × W:40 × T:1.6mm)</p> <p>2. Apply the load in direction of the arrow until bending reaches 2 mm.</p> | <p>No Visible Damage.</p> | <p>AEC-Q200 005</p> |
| Adhesion | <p>Force of 1.8Kg for 60 seconds.</p>  | <p>No Visible Damage Magnification of 20X or greater may be employed for inspection of the mechanical integrity of the device body terminals and body/terminal junction.</p> | <p>AEC-Q200 006</p> |
| Physical Dimension | <p>Any applicable method using x10 magnification, micrometers, calipers, gauges, contour projectors, or other measuring equipment, capable of determining the actual specimen dimensions.</p> | <p>In accordance with specification.</p> | <p>JESD22 JB100</p> |

Revision History

| Revision | Date | Content |
|----------|------------|---------------|
| 1 | 2020/10/15 | New Datasheet |