

天线规格书

Antenna specification

1、天线类型：板载天线

Antenna type: On-board antenna

2、天线厂家：深圳汇影科技有限公司

Antenna manufacturer: Yanshan Xingao Electronic Technology Co., Ltd.

3、实物照片，图纸。

Antenna photo and drawings:

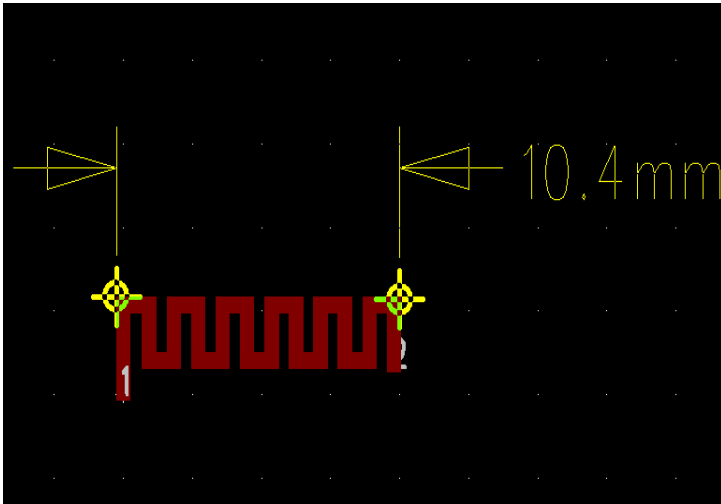

4、天线频率，效率，增益。

Antenna efficiency, frequency, and gain

Frequency	Efficiency / %	Gain/ dBi
2400MHz	43.45	0.31
2410MHz	48.98	1.06
2420MHz	42.66	0.65
2430MHz	46.13	0.74
2440MHz	39.45	0.16
2450MHz	49.09	1.24
2460MHz	43.75	0.99
2470MHz	45.71	1.28
2480MHz	41.98	1.5
2490MHz	45.81	2.08
2500MHz	44.67	1.99

5、天线 2D 3D 图 Antenna 2D3D drawings

Phi 0 2D 图

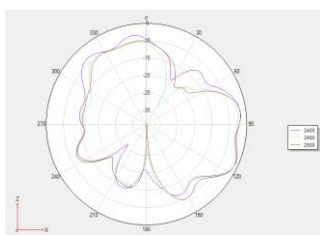

Phi 90 2D 图

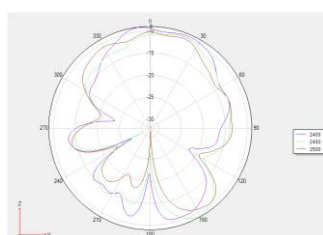

Theta 90 2D 图

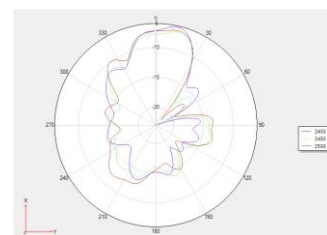

2400

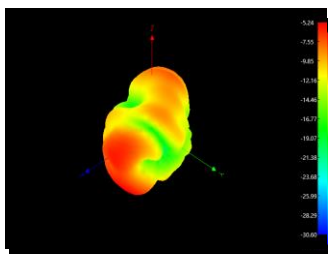

2450

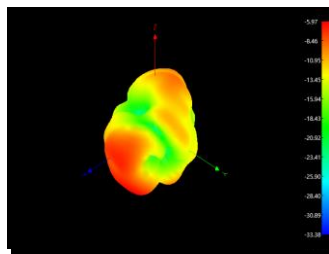

2500

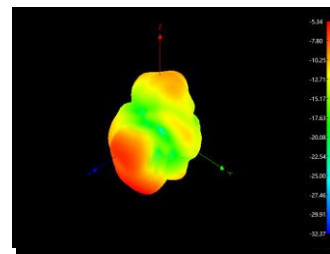

6、天线驻波比 antenna standing wave ratio

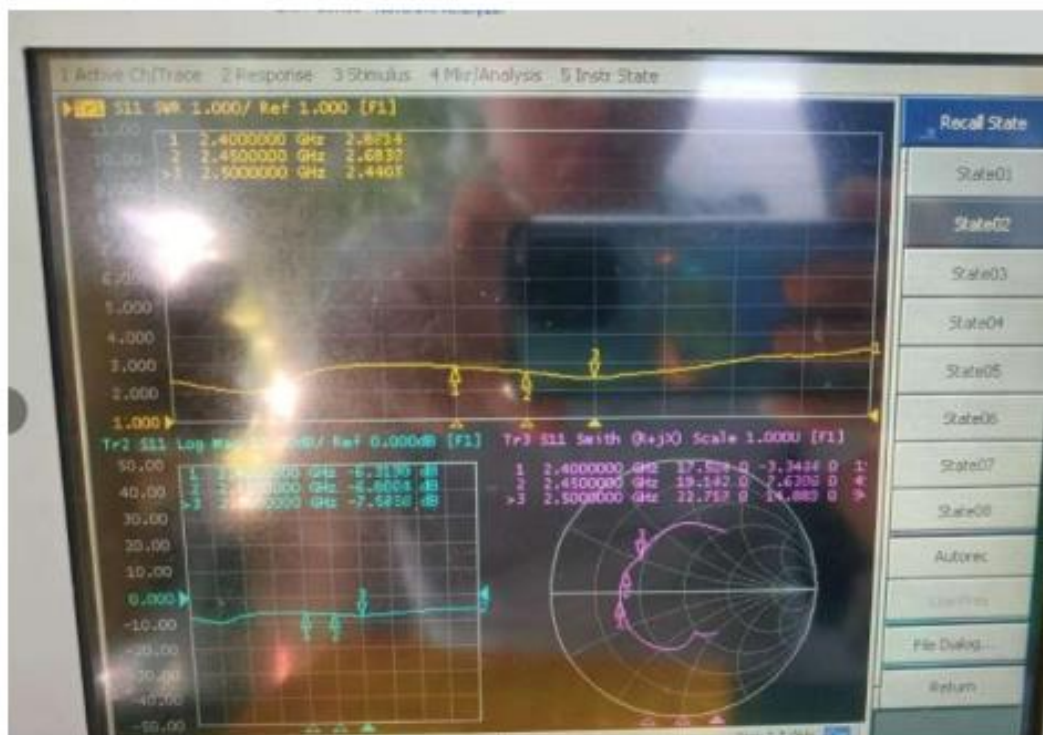

7、天线匹配电路 Corresponding circuit drawings

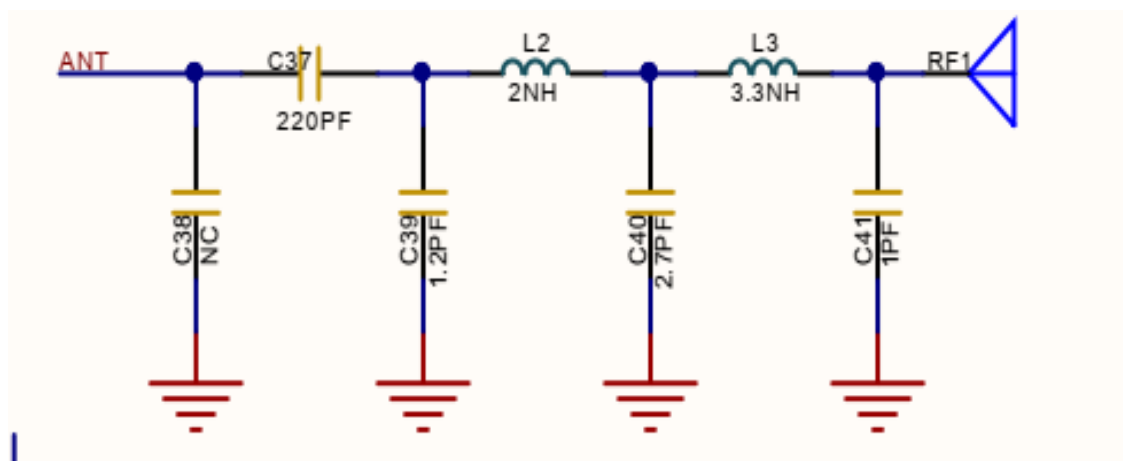

8、测试环境 Testing environment

