

# User Manual

LD2K

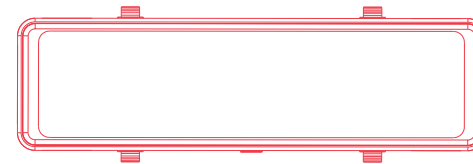

 [service@lingdu.us](mailto:service@lingdu.us)  
Response in just 12 hours

**Product** | Dash Cam  
**Manufacturer** | Dongguan Lingdu Electronic Technology Co., Ltd  
**Address** | 1 Longcheng Street, Qingxi Town, Dongguan City,  
Guangdong Province, China  
**Product Warranty** | One-Year Limited Warranty  
**Customer Support** | [service@lingdu.us](mailto:service@lingdu.us)

[www.lingdu.us](http://www.lingdu.us)



FCC ID: 2BEAP-LD2K

V20240407

LD2K

**LINGDU**

[www.lingdu.us](http://www.lingdu.us)

---

**• INDEX**

---

CUSTOMER SERVICE .....	02
NOTICE .....	03
SPECIFICATION .....	04
PACKING LIST .....	05
PRODUCT DIAGRAM .....	06
INSTALLATION .....	08
GET STARTED .....	13
BUTTON FUNCTION .....	15
FUNCTION .....	17
PLAYBACK RECORDED VIDEOS .....	24
GPS PLAYER SOFTWARE INSTALLATION (PC/MAC ONLY) .....	27
PLAYING VIDEO FILES USING YOUR SMARTPHONE .....	29
UPDATING FIRMWARE .....	38
FAQ .....	39
DISCLAIMER .....	41
WARNINGS .....	42
NOTICE .....	43

---

## •» CUSTOMER SERVICE

---

- 🗣️ **Defective or damaged item?**
- Inaccurate description?**
- Missing parts or accessories?**
- Performance or quality not adequate?**
- Wrong item was sent?**

 [service@lingdu.us](mailto:service@lingdu.us)

Contact us before returning the item.  
We will help you resolve any issue asap.  
Response in just 12 hours

EN-02

---

## •» NOTICE

---

Thank you for purchasing this LINGDU dashcam.  
This instruction manual contains information on how to operate your dashcam. Before using your dashcam, we recommend that you read through this manual to ensure correct usage.  
To improve the performance of the product, the contents of this manual are subject to change without prior notice.

 **Note:**

1. **A U3 type microSD card (Not included)** is required to use this Dash Cam. Be sure to format your microSD card with your dash cam for the first time use.
2. Please ALWAYS connect with power when using.
3. The Dash Cam has one Automatic Start / Stop Technology. It will automatically power on and record automatically once power is available. It will power on once the ignition has been turned on in most vehicles. When power is cut off, the Dash Cam will perform an automatic shutdown process.

EN-03

•» SPECIFICATION

Model	LD2K
Mic/Speaker	Built In
Photo Format	JPG
Video Format	MP4
Video Resolution	Front:1440P;1080P Rear:1080P
Memory Card	Class 10 or above high-speed Micro SD card (Not included)
Car Inverter DC	5V/2.5A
Relative Humidity	10%-70%
Battery	500mAh lithium battery
WiFi	Yes
GPS Track	Support, (Not included GPS Module)
Loop Recording	Support
Parking Monitor	Support, 24 hours Parking Monitor need to connect Mini 3-lead hard-wire kit

EN-04

•» PACKING LIST



 **Note**

• To improve the performance of the product, the contents of this manual are subject to change without prior notice.

EN-05

» **PRODUCT DIAGRAM**

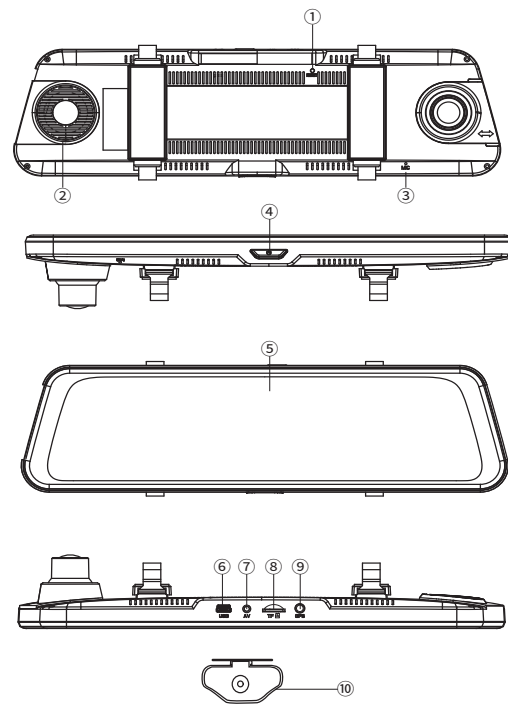

EN-06

#	Component	Description
1	Reset	Insert a pin to 'RESET' hole to reboot when device is Not Responding
2	Speaker	Built in speaker
3	Microphone	Records audio
4	Power Key	-Press once to turn on device -Press and hold 3 seconds to turn off device -Short press to turn off/on screen when recording
5	Screen	Touching Screen
6	Mini USB Port	Connect to MINI USB cable & charge battery
7	AV-IN	Connect to rear camera
8	Micro SD Card Slot	Support Micro SD, Class 10 or above, U3 high-speed
9	GPS	Check your route when you playback the videos Via LINGDU Player
10	Rear Camera	Records rear side

EN-07

## •» INSTALLATION

### Install Micro SD Card (Not included)

1. Make sure the dash cam is turned OFF.
2. Insert the Micro-SD Card half way in ( GOLD Contacts - Facing the Back/Lens Side)
3. Now gently push the card in until it clicks & looks in place.
4. Must use only Brand Name, Class-10, U3 or higher speed Micro-SD Card.

### Remove Micro SD Card

-To remove the Micro SD card, gently push its top edge inward until it clicks, and then pops out, then simply pull it out of the slot.

#### MOST IMPORTANT about Memory CARD

1. Do not remove or insert Micro SD card when the camera is powered on which may damage the memory card.
2. Every time you insert a Micro SD card, please format it in the camera to ensure that the microSD card is compatible with the camera.

### Front Camera Installation

1. Turn off the car's engine. Insert a Micro SD card into the Micro SD slot of the dash cam.

EN-08

2. Loop the rubber fasteners over the top fastener clips (There are 2 types of fasteners; please use which ever suits your car; Put the mirror dash cam in position on the front face of your existing rear view mirror ensuring the camera lens clears the edge of your rear view mirror. Loop the bottom rubber fasteners over the mirror and attached to the bottom fastener clip.

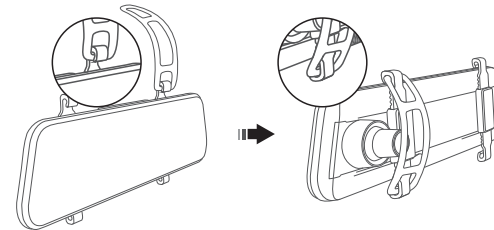

3. Connect one end of Car Charger cable to the USB Input port on the topside of Mirror Dash Camera. Plug the other end of the Car Charger cable to the Cigarette Lighter Receptacle in the vehicle. Run the cable along your vehicles console.
4. Connect the GPS module to the dash cam, tear off the sticker of GPS module and place it on the car dashboard.

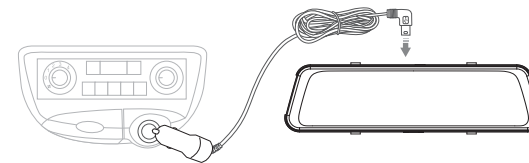

EN-09

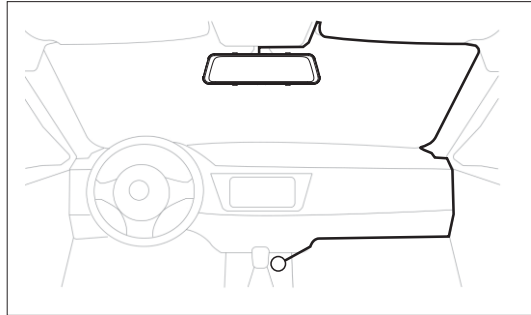

### Rear Camera Installation

The rear camera equipped with a 6-meter cable is to connect to the dash-cam via AV IN port. Before installation, please check if the provided cable is long enough to reach the rear cam in your car.

1. There are two locations for mounting the rear camera: rear windshield / above the number plate.

Position 1: Install the rear camera on the rear windshield.

Position 1 is designed for live stream rear view only, not for reversing guide.

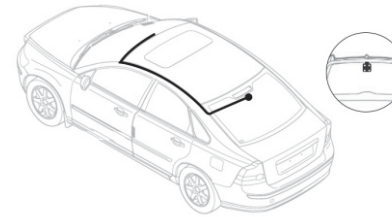

Position 2 (Recommended): Install the rear camera near the license plate. Feed the camera wire through to the interior of the vehicle either by drilling a new hole; or using the existing hole for the number plate light if possible. The two included screws and double-sided tape will hold the camera in place. The rear camera image is crisp and clear for both rear viewing and reversing guide.

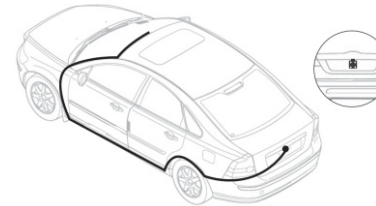

To use the reversing function, install the rear camera in position 2, then connect the red cable of the rear camera extension cable to the anode of the car reversing lamp by using a test light or multimeter to determine which wire is positive.

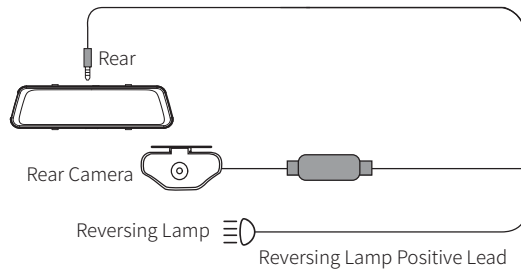

2. Once all of the plugs are connected and power connections are made. Switch on the ignition. Shift the gear into reverse, and if all is wired correctly; the rear camera image will appear in your mirror.

#### Note

- ① Please clean the position to ensure the adhesive quality before install the rear camera.
- ② Please clean the rear windshield regularly to ensure the image quality if choose the position 1.
- ③ If choose the position 2, you can install the rear camera with the included adhesive sticker or screws.
- ④ Please fasten the screws to adjust the desired camera view angle.

## » GET STARTED



### Power On/Off

Option 1: Start the engine to automatically power on the Mirror Dash Camera; stop the engine to automatically power it off.  
 Option 2: Press once to turn on device; Press and hold 3 seconds to turn off device.

### Screen On/Off

Simply press the Power Button once to switch the screen off (But can still recording) when the mirror dash cam is ON; Press it again or tap the touch screen to wake up the camera.

### FORMATTING MEMORY CARD

1. Touch  to enter the Settings Menu.
2. Touch  and touch "Format".
4. Touch "OK".

#### Note

1. Do not remove or insert Micro SD card when the camera is powered on which may damage the memory card.
2. Every time you insert a Micro SD card, please format it in the camera to ensure that the microSD card is compatible with the camera.



### SETTING TIMEZONE AND DATE/TIME

- ① Please connect GPS module (Not included GPS Module).
- ② Set the GMT value first.

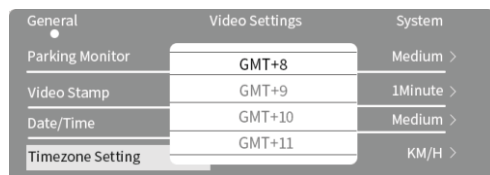

- ③ Set the Date/Time: Year-Month-Day-Hour-Minute

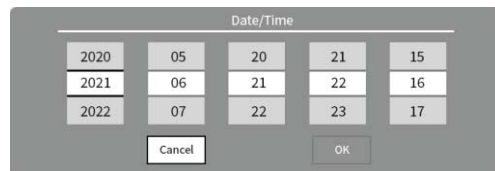

The dash camera will updated the date and time based on the GMT value selection automatically when it receives the GPS signal .







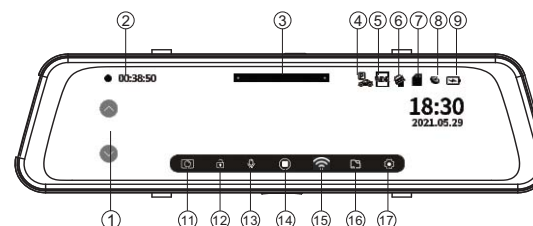

	British Winter Time	British Summer Time
<b>UK Time Zones</b>	GMT/UTC +1	GMT/UTC ±0

Go to <https://www.timeanddate.com/time/map/> to find out your Correct GMT (Greenwich Mean Time) value based on your location.

### •» BUTTON FUNCTION



#	Description	Feature
1	Adjust View Angle	Tap ●● to adjust view angle, can't work when dual camera display
2	Recording timer	Shows the elapsed recording time
3	Screen Brightness Control	Slide the brightness bar to increase or decrease the screen brightness
4	Parking Monitor	Shows the parking mode status
5	WDR	Shows the WDR status
6	G-sensor	Show the G-sensor status

7	MicroSDCard	Show the Micro SDCard status
8	GPS	Show the GPS status (Not included GPS)
9	Battery	Shows the status of Battery
10	Date/Time	Shows the date and time
11	Photo Shooting	Tap  to capture a photo and save it to the memory card.
12	Emergency Lock	Tap  to manually lock the current video that is recording to make sure it will NOT be overwritten or deleted; Tap  to start recording again
13	Audio	Tap  to mute/unmute the microphone
14	Recording	Tap  to end & save the recording into the memory card
15	WiFi	Tap  to open or close the mirror dash cam's Wi-Fi
16	Playback	Tap  to enter playback menu and check all videos or photos saved
17	System Setting	Tap  to enter system setting menu

## » FUNCTION

### General

#### Parking Monitor — On/Off(Default)

If connected to cigarette lighter to supply power, with "Parking Monitor" function enabled, dash cam automatically starts recording a video for around 60s and lock it when any collision/ impact detected. Dash cam use its internal battery(500mAh) to detect any knock or bump so supports limited times of recording a 60-second video. This mode greatly saves energy and protects your car battery.

#### G-sensor — Off/ High/ Medium(Default)/ Off

G-Sensor is a 3-axis impact gravitational accelerometer which is designed to detect physical and gravitational forces on the camera. While Video is Being Recorded: In the event when G-Sensor is triggered due to physical or gravitational impact force on the camera, the current loop cycle length of video file will be locked so it will NOT be deleted by loop cycle function.

#### Video Stamp — On(Default)/Off

This stamps menu allows you to choose your choice of stamps for the bottom of the video. Date & Time, speed, GPS Coordinates, LINGDU Logo and model.

**Screen Saver — 1(Default)/3/5 minutes/ Off**

1/3/5 minutes: The dash cam LCD screen will turn off after 1/3/5 minutes, but still recording.

Off: The dash cam LCD screen will always on.

**Timezone**

From GMT-12 to GMT+12 timezone.

**Button Sound — Off/ Low/ Medium(Default)/High**

This feature allows you to turn ON/OFF camera button's beep sound & any voice confirmation.

**Time/Date Setting**

To set the date & time.

**Speed Unit— KM/H(Default)/MPH**

You can choose desired speed option stamp to be displayed and recorded on video stamp based on your selection.  
(Not included GPS Module)

**Frequency — 50HZ/ 60HZ(Default)**

Here you should choose the frequency accordingly to your power supply specification used in your country based on your geographical location.

60 Hz (USA – North America)

50 Hz (Europe – Most Asian Countries)

**Format Remind — Off/ 15days/ 30days(Default)/ 60days**

This feature allows you to set a FORMAT REMINDER to format your memory card. Once set, the camera will remind you to format your memory card at a set interval.

**Parking Guide Line — On(Default)/Off**

On: The function is activated when the reverse gear is selected. The camera image is shown on the dash cam screen with assistance line.

Off: The function is activated when the reverse gear is selected. The camera image is shown on the dash cam screen but NO assistance line.

**Rear Video Mirror — On(Default)/Off**

On: The image on the dash cam screen matches that of your rear-view mirror.

**Vertical Flip Rear Camera — On/Off(Default)**

On: When activated, the dash cam screen will display a rotated image for the Rear camera.

### **Time Lapse Parking Mode — On/Off(Default)**

This menu will be shown when ONLY connected to Mini 3-lead hardwire kit.

Time Lapse Parking Mode ON: Dash cam will capture photos at 1 frame per 1s, and stitches them into a video which greatly optimizes the use of memory card.

### **How to set 24-hours Parking Mode**

If you connect to Mini 3-lead hard wire kit, here are two 24-hours Parking Modes that you can select from:

1. When function “Parking Mode” ON / “Time Lapse Parking Mode” OFF: Dash cam will record unlimited times of a 60-seconds video then power off whenever detecting collision/impact.

This mode is ideal if you: Parked in a quiet area or want audio in all circumstances

① When you turn OFF the car’s engine. Then the camera will also power off.

② Dash cam automatically starts recording a video for around 60s and lock it when any collision/impact detected

③ When you start your car for the next time, the camera will power on and goes into normal video - Loop Recording Mode automatically.

2. When “Parking Mode” OFF / “Time Lapse Parking Mode” ON: Dash cam will capture photos at 1 frame per 1s, and stitches

them into a video which greatly optimizes the use of memory card.

This mode is ideal if you :

-Parked in a busy area with lots of vehicle and foot traffic (ie. mall parking lot)

-Want to have a quick overview of everything that happens around your parked car.

① When you turn OFF the car’s engine. Then the camera will STOP the Loop Recording and it will go into the Time Lapse Parking Mode automatically.

② While this Time Lapse Parking Mode is being recorded, If someone hits your car, then the camera will lock the video file, then saved in LOCK folder of Micro SD card > then go on Time Lapse Parking Mode recording.

③ When you start your car for the next time, the camera will automatically STOP the Time Lapse Parking Mode. Then it will go into normal video - Loop Recording Mode automatically.

### **NOTE:**

-The Time Lapse Mode video files plays at faster speed and NO audio when playback.

-If function “Parking Mode” and “Time Lapse Parking Mode” are ON simultaneously, the Time Lapse Parking Mode will be the priority

## Video Settings

### **Video Resolution — 1440P+1080P(Default)/1080P+1080P**

Allow to choose the desired video resolution. Higher resolution and fps videos result in smoother videos, but also take more storage space.

### **Loop Recording — 1min/ 3mins(Default)/ 5mins**

Allow the dash-cam to continuously record. Please notice: the dash-cam will keep deleting the oldest files automatically when memory card gets full so that it can keep recording over and over. Here select the length of video file for the loop recording.

### **WDR — On(Default)/Off**

Wide Dynamic Range (WDR) improves the exposure by taking the combinations of over exposed and under exposed image into one robust wide range of lighting with higher depth image.

### **Time-lapse Record — On/Off(Default)**

Time Lapse recording mode allows you to capture specific images per second at a much lower rate. So when you combine and play those images at the normal 30fps rate, everything seems to be moving faster in time lapse.

## System

### **Language — Multilingual, default English.**

Allow to choose your desired language for dash-cam system.

### **GPS Info**

Show the satellite numbers, Date/Time, Longitude, Latitude, Speed, Direction (Not included GPS Module)

### **Format**

This feature will allow you to format inserted memory card, all the data will be deleted.

We recommend that you format the memory card every 3 months to keep it clean for smooth operation.

Please note that memory cards have their self life span, after so many uses of writing data over and over, eventually they will become inoperable. When that happens, please replace your memory card.

### **Reset Settings**

Here you can restore all the settings to factory default settings.

### **Version**

Here you can check the current firmware version installed on

your camera. You will need this information in the future to check if newer version of firmware is available.

Please visit: [www.lingdu.us](http://www.lingdu.us) > **Support** > **Downloads** for latest firmware upgrade instructions.

## •» PLAYBACK RECORDED VIDEOS

There are 2 different way you can access your videos.

### A. On Dash Camera

Tap  to enter Playback Menu, you will see six folders.



Front emergency video : emergency videos recorded captured by front camera but can't be overwritten

Rear emergency video : emergency videos recorded captured by rear camera but can't be overwritten

Front normal video : videos recorded captured by front camera



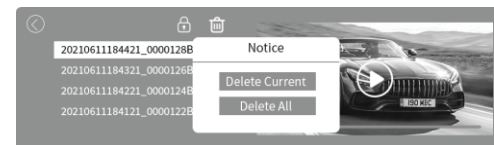
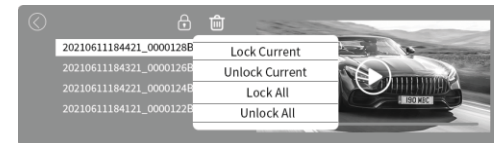

Rear normal video : videos recorded captured by rear camera

Front photo : photos captured by front camera

Rear photo : photos captured by rear camera



### Tips

1. Tap  to return to the previous interface
2. Tap  to play/pause the video file.
3. Tap  to manually lock/unlock the current video that is recording to make sure it will or NOT being overwritten or deleted. recording to make sure it will or NOT being overwritten or deleted.
4. Tap  to delete the selected file or ALL files.

**Note:**The photo file can NOT be locked.

### B. On Computer

1. Please remove the Micro SD card from camera and insert it directly in your laptop if you have a Micro SD Card slot (otherwise please using a Micro SD Card reader).

- You should be able to see drive "D" or "E" or other name depending on the pre-installed hard drives. Once you find the added flash drive, double click in it, then you will see the file folders- Movie / LOCK / Photo
- Movie: The loop recording video files that can be overwritten.
- LOCK: The video file will be locked so it will NOT be deleted by loop recording function.
- Photo: The pictures
- Then simply double click on the video to play them.

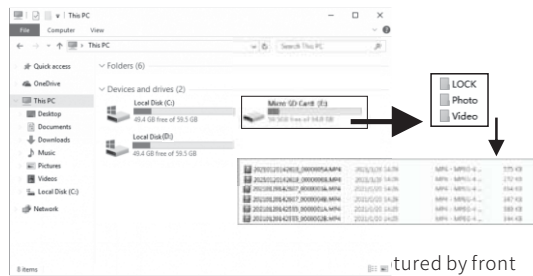

File named \*\*\*\*\*B=videos or photo captured by rear camera

### » GPS PLAYER SOFTWARE INSTALLATION (PC/MAC ONLY)

- Remove the microSD card from the dashcam.
- Insert the card into the microSD card reader and connect it to a computer.

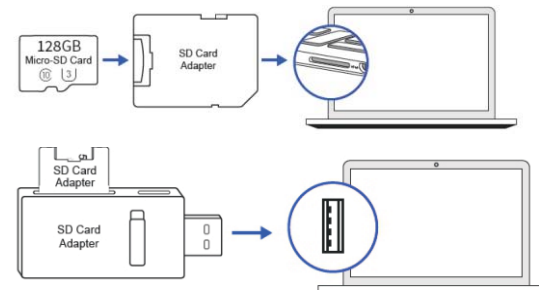

- Download LINGDU GPS Player from [www.lingdu.us](http://www.lingdu.us) > **Support > Downloads** and install it on your computer.
- Install the LINGDU GPS Player on your computer. (Note: Please close or ignore the prompt of the anti-virus software, we confirm that it will not bring any security impact to your computer.)
- You can click the 'Open Files' button to browse and select the Normal or Event folder of the microSD card on the LINGDU GPS Player. It will show all files in the Normal or Event or Parking folder. Or you can also drag the video files directly to the launcher screen.

5. There are two ways to play video.

A, Click File-Open icon to choose the folder which you want to play, click to start play.

(Note that you can ONLY select one folder to play and see no video files)

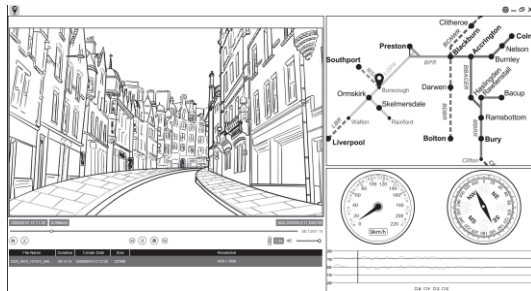

## » Playing Video Files Using Your Smartphone

### 8.1 Check real-time video using your smartphone

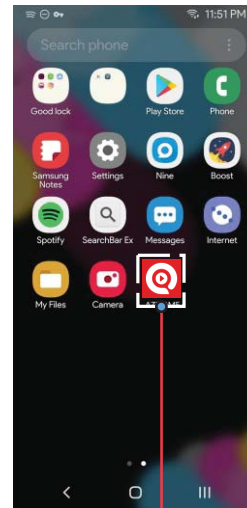

Scan QR code to  
download LINGDU APP

1 Search for the LINGDU app in the Google Play Store or Apple App Store and install it on your smartphone.



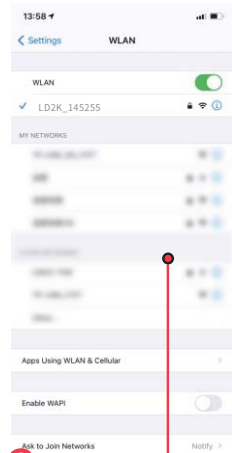

**2** Go to Phone's Settings > WiFi > Select WiFi of the dash cam. After it's connected to the WiFi, it will say 'No Internet Connection' which was normal. Because dash cam WiFi is ONLY for video/photo transfer function, NOT made to broadcast footage over the cloud or internet, please ignore the prompt.  
**WiFi Name SSID: LD2K\_\*\*\*\*\***  
**Default PASSWORD: 12345678**

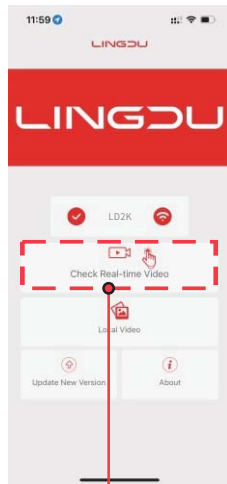

**3** There will show dash cam model LD2K when connect successfully. Press "Check Real-time Video" to live video preview interface.

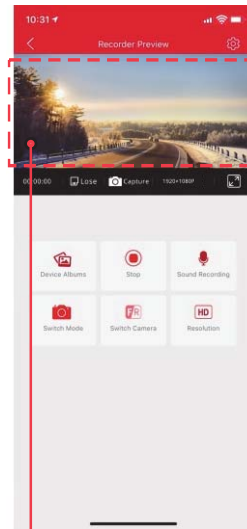

**4** Now you can view the video currently being recorded real-time by connecting your smartphone to the dashcam via Wi-Fi Direct.

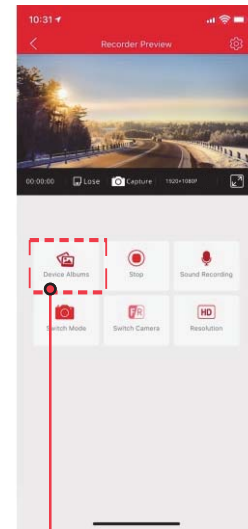

**5** Please STOP recording first, then press the 'Device Albums' to get Photo, Video, Emergency files.

## 8.2 Download the video files into your smartphone

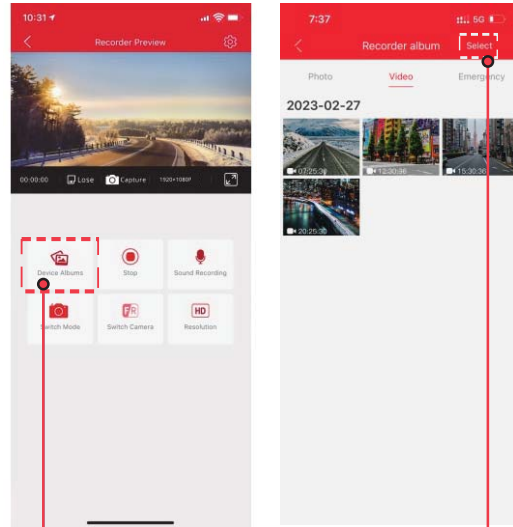

**1** Go to Dashcam Preview interface. Please STOP recording first, then press the 'Device Album' to get Photo, Video, Emergency files.

**2** Select the video files to download into your smartphone.

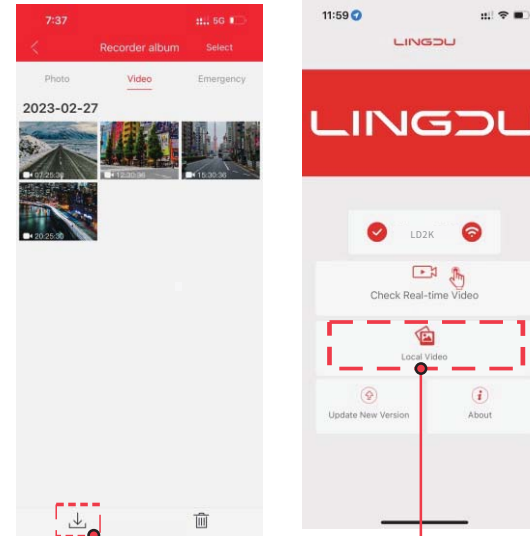

**3** Press the icon to download the video files. However, it will take a bit of time to download one video file.

**4** Then you can find these downloaded video files in APP original interface menu named 'Local Video'.

### The app won't show the live video on your phone. It only shows a picture of the beach?

The cellular data will cause the live video not to be viewed. If the APP won't show the live video, please disable the 'LINGDU' cellular data of your phone. Sure that the Local Network of the 'LINGDU' is turned on.

1. For Latest iOS System: Setting→LINGDU→Click 'Wireless Data' →Select 'WLAN' .
2. For Older iOS System: Setting→LINGDU→Disable the 'Cellular Data' .



### Note:

1. WiFi Direct lets you directly connect your smartphone to your dash cam via WiFi within a range of 10FT.
2. Once it is connected to the LINGDU APP it will automatically update the date/time.
3. The LINGDU is available for devices running Android 5.0 and higher, or iOS 9.0 and higher.

### What is a WiFi Feature?

The WiFi feature has been designed so you can pair your dash camera wirelessly with your smartphone and access your recording instantly from the dash cam. Here you can view, download and share your videos easily with your friends and family. Just like how you would connect your Bluetooth speaker to your smartphone for wireless music play, the same way dash cameras use WiFi signal (instead of a Bluetooth) to pair your smartphone with LINGDU LD2K.

### Can I watch the videos around my car remotely?

NO. LINGDU LD2K dash cam is NOT made to broadcast footage over the cloud or internet. It is NOT a cloud or an IP camera and it is NOT meant to do that. You can get live video and footage on LINGDU dash cam's APP as long as you stay within the 10FT range from the dashcam.

### What is the WiFi Range?

The WiFi signal range is about 10FT when there are NO obstructions in the middle. Please NOTE that just like your home WiFi network, you don't have WiFi signal outside your home, the same way, WiFi range is 10FT from this small device.

### For Android phones:

When installing the LINGDU APP, it will have two pop-up prompts, select 'While using the APP' to allow LINGDU to access this device's location, and select 'Allow' to allow LINGDU to access photos and media on your device. There is one extra step you will have to take for the first time. Once you connect to the WiFi of LD2K, it will say 'No Internet'. Which is fine. Wait about 10-15 seconds until you see the below pop up or notification. You just have to tap on the pop up notification that will show up in few seconds to select that you still want to stay connected even though there is NO Internet. Once you select this OK, you are set to go.

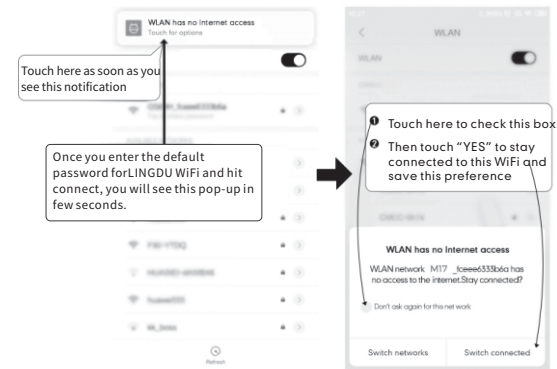

### For iPhone:

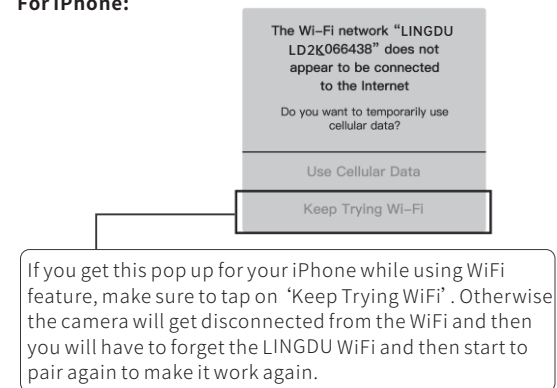

---

## •» UPDATING FIRMWARE

---

The firmware will be updated regularly to introduce new functions and improve the general performance. When the camera doesn't respond to your operation and the resetting doesn't help, it's useful to update to the latest firmware. Please follow these steps to update the firmware:

1. Use a memory card and backup the important videos/photos files.
2. Download firmware in LINGDU official website  
[www.lingdu.us](http://www.lingdu.us) > **Support** > **Downloads**
3. Save the downloaded firmware file (FW96565A.bin) into your Micro-SD card. Turn off the dash cam, insert the SD card into the dash cam.
4. Connect to power supply and power on the dash cam, the dash cam screen will go black for about 40 seconds, then dash cam will power on automatically when the updating is successful.
5. Please MUST format SD card in the dash cam otherwise the dash cam will update again when next power on.

---

## •» FAQ

---

### **Q1:Why the rear cam image is converse on the screen?**

According to your habit, please use the function called "Backup Cam Mirror Image" .

### **Q2:Poor image quality of rear cam**

The most likely cause is simply a dirty lens. Since many cameras are mounted low on the back of the car, they're subject to being obscured by mud, snow, dirt or other debris. Luckily, the fix is easy: Clean the lens with a soft cloth (to prevent scratching the lens).

### **Q3:Dash cam will be hot**

Yep! A dash cam of this caliber is a pretty high-tech piece of equipment. When you think about it from an engineering perspective, capturing high quality full HD video takes a large amount of computer processing power. Heat is the by-product of all that data processing that is going on. But not to worry.The case of the Dash cam itself is actually used as a heat-sink (notice the nice vents), so that's why you may notice it is warm or hot to the touch. Don't worry, this is normal, and your LINGDU is operating as designed.

**Q4:My Video playback on PC is lagging.**

You are viewing high-bit rate version of video files. General computer configuration may have problem with faster data processing. Please record videos at lower resolution and try again. Contact us if problem still exists.

**Q5:Why dash cam can't get the GPS signal?  
(Not included GPS Module)**

1. Depending on the vehicle and the location of the GPS signal can be blocked due to strong radio interference of other electronic devices in the car, the cloudy/rainy weather or mountains, tunnels, tall buildings on both sides of road etc.
2. Please check if GPS works by taking the GPS Module from the car to outside. If it works then there must be a heavy interference in the car, for example thick car Explosion-proof membrane, metal item and etc.

---

**»» DISCLAIMER**

---

LINGDU Streaming Mirror Dash Camera is designed to be use as a driver' s assistant, it dose NOT remove the responsibility of driving the vehicle from the driver. The legal responsibility and safe driving practice always remains with the driver. You agree to use this product and under-stand that this is to be use as aid only. We highly recommend that you have this product professionally installed to ensure that it will provide the function it is set out to perform. In case of you change your mind or return of this product, company is NOT responsible in anyway for the holes or installation modifications made to your vehicle.

---

## » WARNINGS

---

- Do not expose this product to rain, moisture or water under any circumstances or it will result in external or internal damage.
- Do not put the unit in a damp environment. This device is not designed to be damp proof.
- Do not try to open the cover or try to repair it yourself. If the accessories for this device have any problem, please contact the seller for assistance.
- Do not expose this device to an excessive heat, dust or use any chemical substance or cleaning solvent to clean this device.
- Do not operate or install the camera while driving, or attempt to change any setting etc. Pull off the road first and only do so when it is safe.
- Do not drop, puncture or disassemble this product or dispose it on fire. It contains Battery and can explode if improperly handled.
- Do not use the charger if the cord is broken or damaged. Keep out of reach of children.
- Do not leave the camera in the direct sunlight for a long period of time or where temperature could go above 140°F (60°C).
- Removing the camera from the vehicle when not in use is recommended. This prevents likelihood of theft or exposure to excessive heat to prevent damage to unit.

---

## » NOTICE

---

**CE** This product complies with the radio interface requirements of the European Community.

 This symbol means the product must not be discarded as household waste, and should be delivered to an appropriate and recycling helps protect natural resources, human health and the environment. For more information on disposal and recycling of this product, contact your local municipality, disposal service, or the shop where you bought this product.

**FCC** Changes or modifications not expressly approved by the party responsible for compliance could void the user's authority to operate the equipment. This equipment has been tested and found to comply with the limits for a Class B digital device, pursuant to Part 15 of the FCC Rules. These limits are designed to provide reasonable protection against harmful interference in a residential installation. This equipment generates, uses and can radiate radio frequency energy and, if not installed and used in accordance with the instructions, may cause harmful interference to radio communications. However, there is no guarantee that interference will not occur in a particular installation.

If this equipment does cause harmful interference to radio or television reception, which can be determined by turning the equipment off and on, the user is encouraged to try to correct the interference by one or more of the following measures:

- Reorient or relocate the receiving antenna.
- Increase the separation between the equipment and receiver.
- Connect the equipment into an outlet on a circuit different from that to which the receiver is connected.
- Consult the dealer or an experienced radio/TV technician for help.

This device complies with part 15 of the FCC Rules. Operation is subject to the following two conditions: (1) This device may not cause harmful interference, and (2) this device must accept any interference received, including interference that may cause undesired operation.

FCC RF exposure statement:

The equipment complies with FCC radiation exposure limits set forth for an uncontrolled environment. This equipment should be installed and operated with minimum distance between the radiator and your body.