

D601

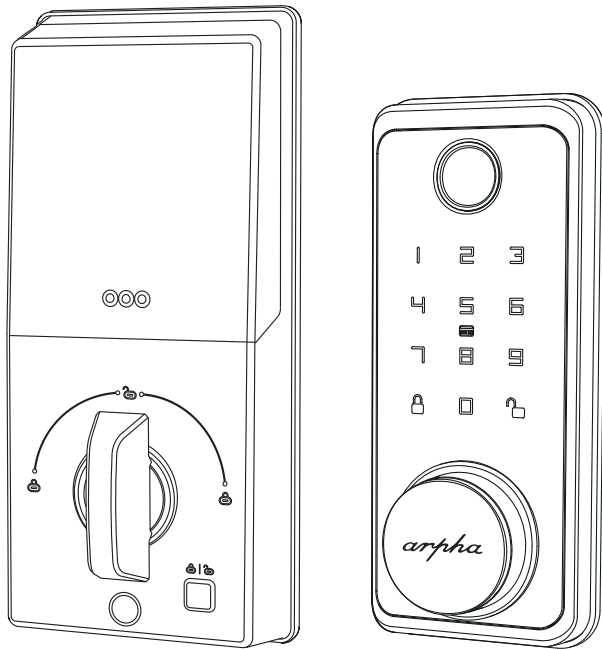

Operating Manual of American-standard Lock

Please read and understand the Operating Manual before use.

Caution: Please take along an emergency key or put it in a safe place outside.

Intelligent Share · Relieved Life



You can save your time by scanning the QR code to watch a video on how to install and program and reset the lock.

■ Instructions For Use

screwdriver and a drilling machine before installation.

- Registered Administrator (Unregistered Administrator)
- Press the reset button (within 2 seconds), prompt "add administrator, please enter a new password", enter the same 6-10-digit password twice, the system prompts that the registration is successful
- Add an administrator (an administrator password has been registered)
- Press the reset button (within 2S), prompt "add user, verify administrator" after successful verification prompt "add administrator please enter fingerprint or password" fingerprint needs to be pressed 5 times, enter the password to be registered twice, press the confirmation key to end, register the second administrator successfully
- Add administrator (two administrator passwords have been registered)
- Press the reset button (within 2S), prompt "add user, verify administrator" after successful verification prompt "add administrator please enter fingerprint or password" fingerprint needs to be pressed 5 times, enter the password to be registered twice, press the confirmation key to end, register the third administrator successfully.
- Adding users (registered 1-3 administrators)
- Press the reset button (within 2S), prompt "add user, verify administrator" after successful verification prompt "add user please enter fingerprint or password" fingerprint needs to be pressed 5 times, enter the password to be registered twice, press the confirmation key to end, that is, the registered user.

■ Packing List

S/N	Content	Quantity
1	Front lock	1
2	Rear lock	1
3	Lock cylinder(Including key*2)	1
4	Specification	1
5	Installation accessories package	1
6	Opening drawing	1

■ Product functional Characteristics



Unlocking via keys



Unlock with password



Standard key cylinder



APP unlocking



Low voltage alarm



Virtual password



Automatic locking



Fingerprint unlock

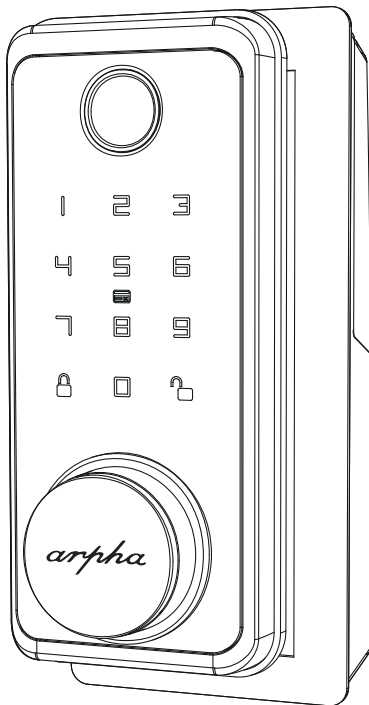

■ Schematic Diagram Of Product Breakdown

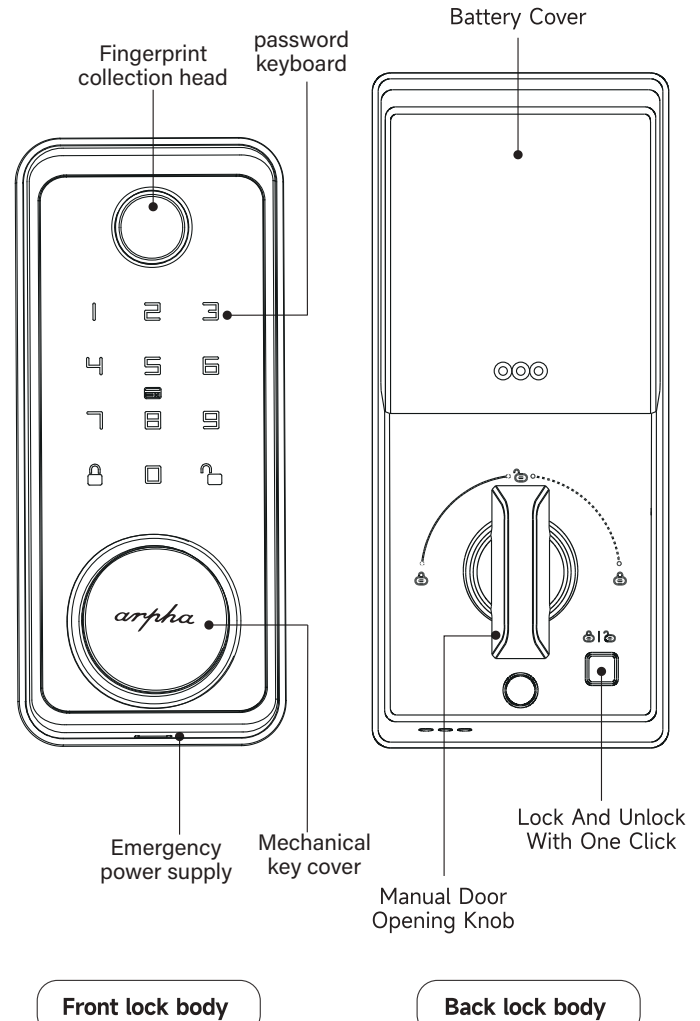

■ Product Specification And How To Operate The Menu

Name	Content
Key category	Password and mechanical keys
Password capacity	3 administrators and 47 general users
Power supply	4 AA alkaline batteries
Tips	Prompt of light and buzzer
Low voltage alarm	4.8V
Antistatic	Exposure+ / 8KV Air+ / 15KV
Standby current	<70uA
Dynamic power consumption	<200mA
Operating environment	-4°F/-20°C ~ +122°F/+50°C
Operating humidity	0%~95%
Applicable door thickness	1.38 IN/35 MM - 2.17 IN/55 MM

■ Key And Light Indication Functions

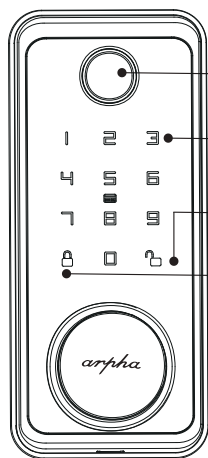

Front lock body

Fingerprint as status indicator
Indication light of red and green state:
Green light for success, red light for failure

Number Key
Backlight: white

Confirmation and unlock key

Cancel and lock key

Description of "buzzer" prompt note:

1. Short "beep" for once: Button sound;
2. Short "beep" for twice: Operation continues;
3. Short "Beep" for three times: Error reminder;
4. Long "Beep": Operation success reminder;
5. Short "Beep" for four times: Alarm sound.

■ Operating Process

Factory Settings

Press and hold the reset button for 5 seconds until it long "di" three times, and the factory settings are restored successfully.

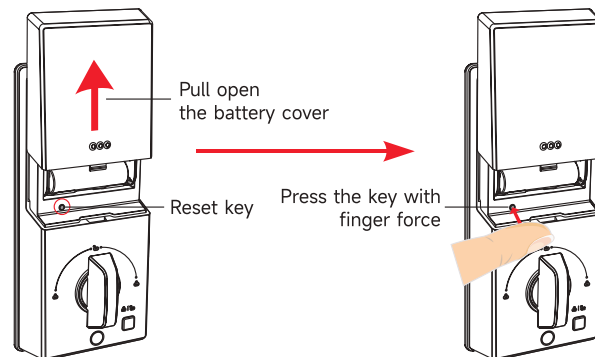

Setting Unlocking Direction

The system is in the factory state, the lock is initialized (no user entered), the direction is automatically set after the battery is installed, and the long beep prompts that the lock direction is set successfully.

When a user is registered, the lock cannot automatically recognize the direction of the door. So when installing the door lock, please be sure to reset the lock first!

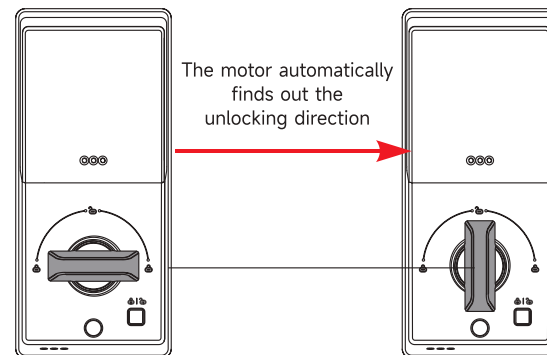

■ Installation

① Installation Overview

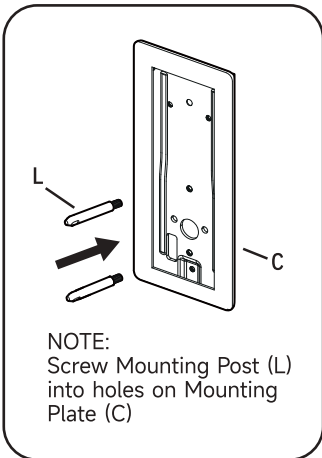
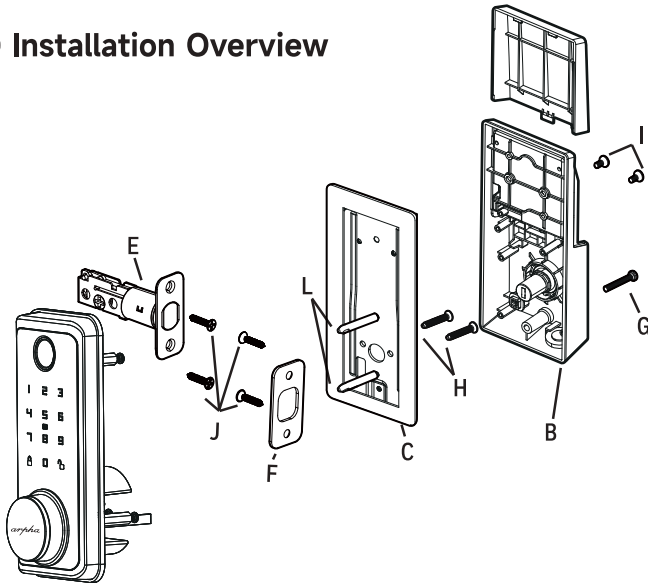

If your door thickness is
1.38in/35mm to 1.77in/45mm
door thickness, you should use
0.98in/25mm shorter screws

If your door thickness is 1.77
in/45mm to 2.17in/55mm door
thickness, you should use
1.38in/35mm longer screws.

② Preparing Door

NOTE: Skip this step if your door comes with pre-drilled holes.

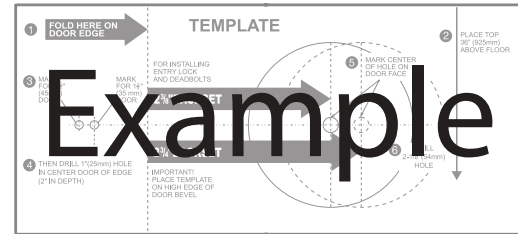

Refer to Template included for Door Prep Instructions

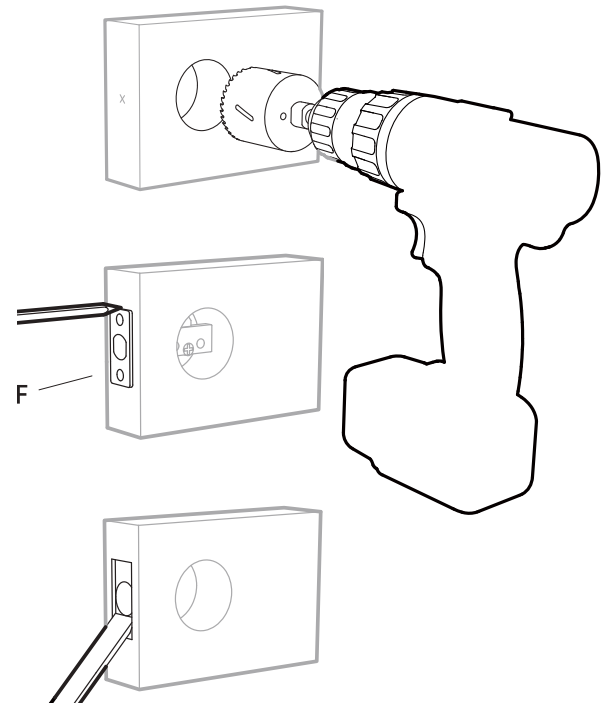

3 Install Enclosed Latch and Strike Plate

NOTE: Do not extend Cylindrical Cover past 2-3/4" (70mm)

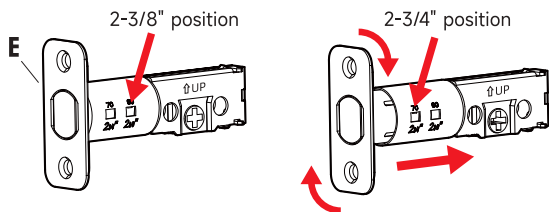

TO CONVERT FROM 2-3/8" (60mm) BACKSET
TO 2-3/4" (70mm) BACKSET

1. Hold latch with numbers facing forward and thumb pressing on the bolt.
2. Rotate the cylinder cover clockwise.
3. Pull and twist the extension plate all the way out.
4. Rotate the cylinder counter clockwise so that the marking aligns with the 2-3/4" position indicator.

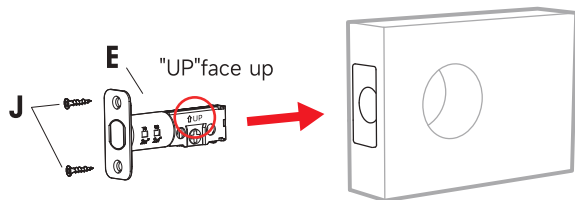

! Deadbolt Latch Must Be Retracted During Installation

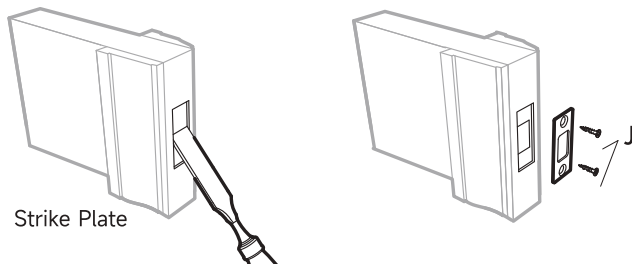

! Do Not Over Tighten

4 Install Exterior Assembly

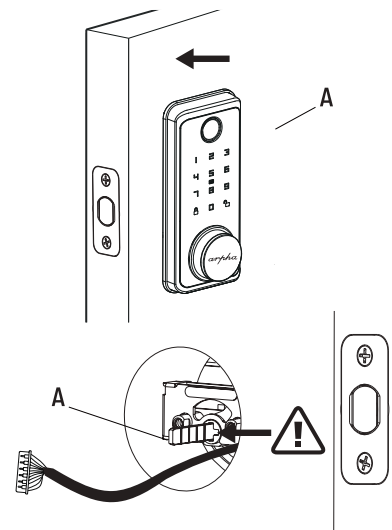

Check that the Rubber Gasket is secured on the Exterior Assembly. Insert the Exterior Assembly onto the door with the tailpiece going through the Deadbolt Latch Set in the VERTICAL POSITION. Route the Control Wire through the door under the Deadbolt Latch Set.

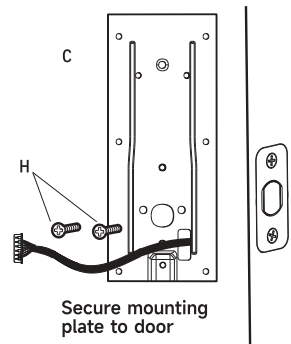

Secure mounting plate to door

5 Install Interior Assembly

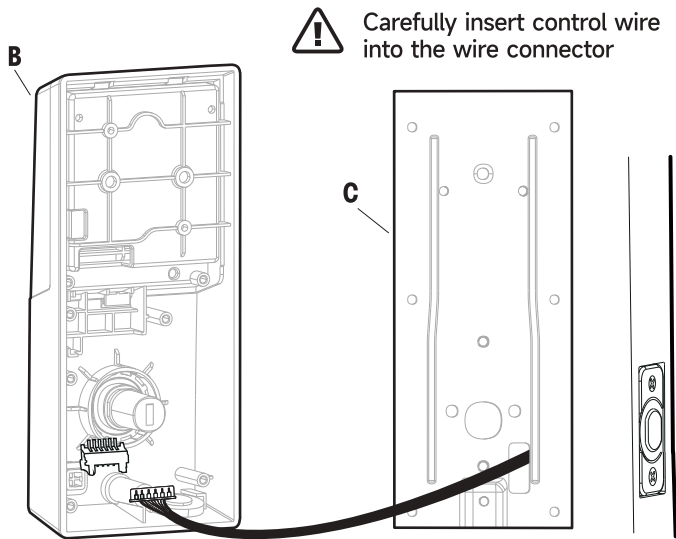

Carefully insert control wire into the wire connector



Work with the door open

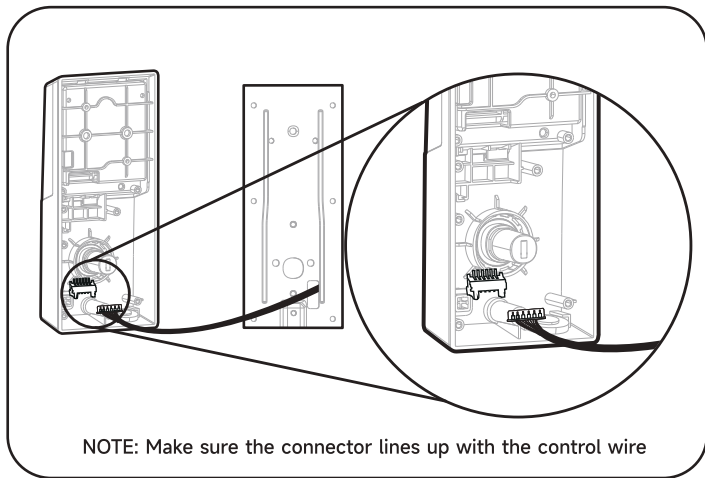

NOTE: Make sure the connector lines up with the control wire

6 Install Interior Assembly

NOTE: Make sure the Knob is in the correct position. Be careful not to pinch the control wire when assembling.

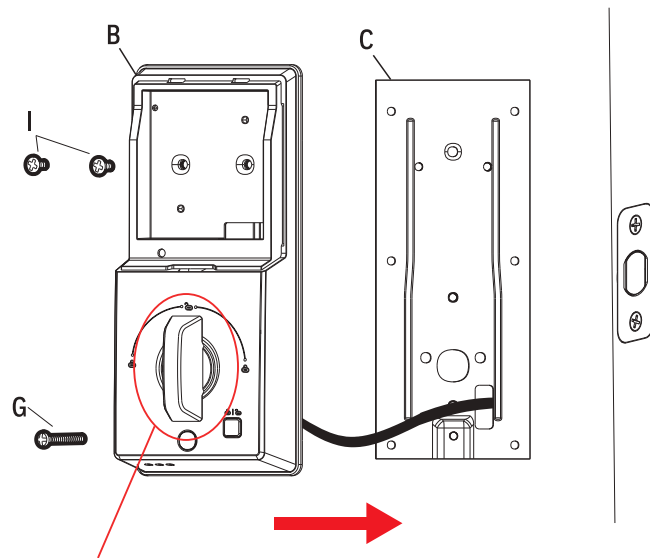

The knob must be twisted to the vertical state

7 Install Batteries and Cover

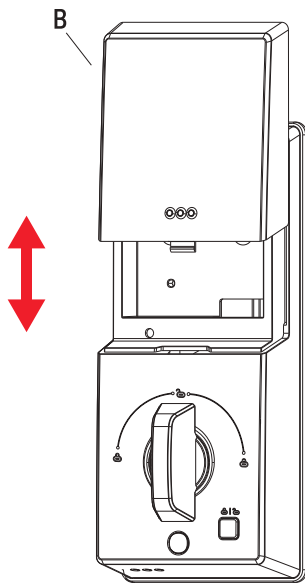

This Electronic lock requires (4) High Quality AA Alkaline batteries. When all 4 batteries are installed in the correct position, you should hear 2 beeps and the keypad will illuminate.

The deadbolt extends, retracts, extends, and automatically recognizes the direction of the door. (left or right handed door)

NOTE: Make sure the lock is reset before installing the battery! Otherwise the lock cannot automatically identify the direction. Do not use rechargeable batteries or non-alkaline batteries.



If you think the installation is complicated, you can directly scan the QR code to watch the video!

8 Testing Operation

Test the lock button with door open



Test unlocking

Press 1-2-3-4-5-6-

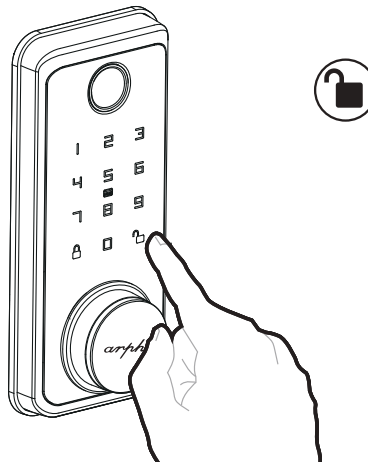

Before Opening Door Let Motor Complete Cycle

■ Tuya Smart APP Instructions

① Download the App

Download tuya App from the App Store (iOS devices) or Google Play (Android devices)

② Sign up the account

Create your account and follow the set up instructions in the tuya app



③ Add the device to your APP

1. Before connecting to the APP, the door lock must be set with at least one password.
2. Start setting the password
 - a. Short press the reset button on the rear panel for 1 second, there will be 2 short beeps
 - b. Enter the new administrator password + \uparrow
 - c. Enter the new administrator password + \uparrow again
 - d. The green light means that the addition is successful. If there are 3 short beeps and the red light is on, it means that the addition has failed.
3. Start the APP to connect the door lock
 - a. Press 3+ \uparrow , the door lock beeps twice
 - b. Enter the administrator password + \uparrow
 - c. The green light flashes, and there is a long beep
 - d. Now take out the mobile phone and start connecting the door lock (it needs to be connected within two minutes, otherwise it will time out. If the time exceeds 2 minutes, you need to start from step 3.)

Note:

1. After successfully pairing, Tuya App on your phone becomes Administrator of the lock.
2. If you do not find the lock on App when pairing, please reset the lock first.
3. Once you pair the lock with your App account, the lock will not be able to link to other accounts, unless you remove the lock from your App.

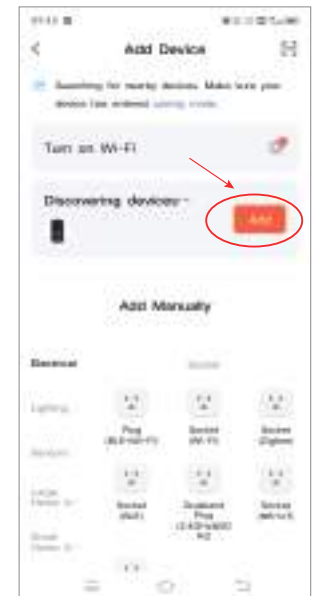



Manually add devices

Path: + in the upper right corner of the mobile phone - Add Device - Camera & Lock - Lock (BLE)



④ APP unlock

Open the APP and the following interface appears, press and hold the unlock button below to unlock.



⑤ APP add password

Open the APP and the following interface appears, add the lock password.

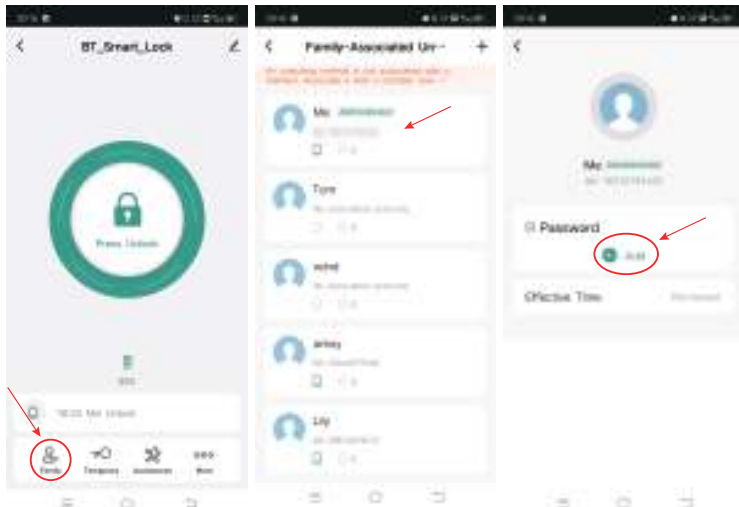

⑥ APP generates a temporary password

Open the APP and the following interface will appear, and a temporary password will be generated to share with the user (the password will only be valid within 5 minutes each time).

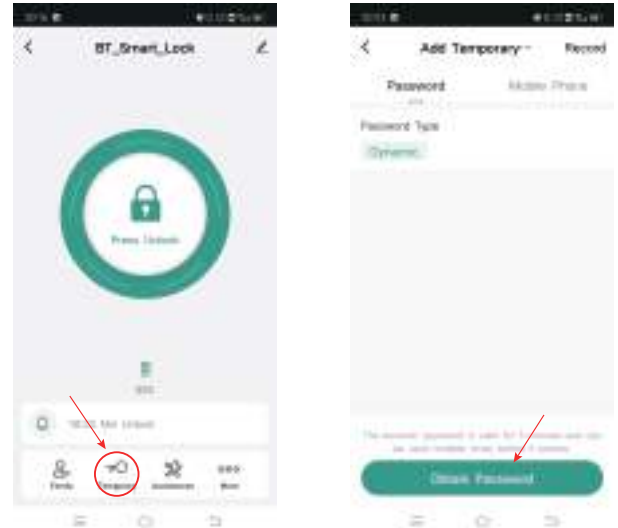

7 APP check unlock record

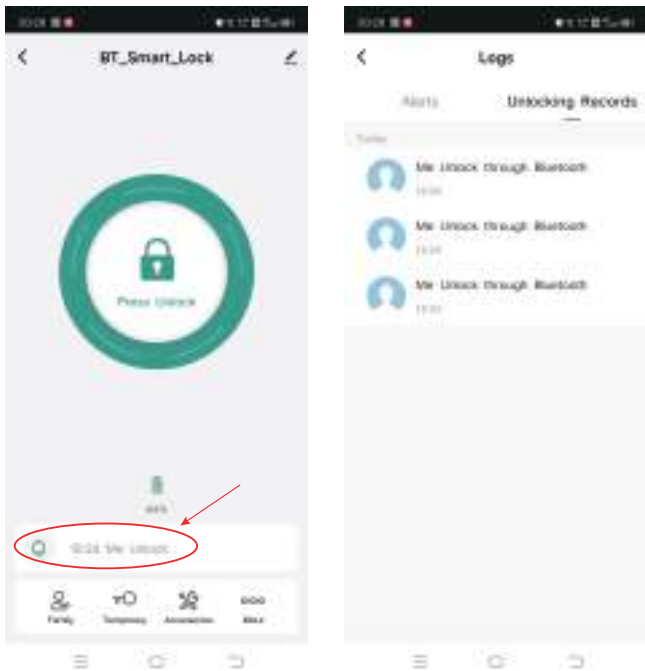

If you think the APP operation is complicated, you can directly scan the QR code to watch the video!

Operating Process

Registered users

1. Register administrator password

- If there is no administrator password, short press the reset button on the rear panel, and there will be 2 short beeps
 - Enter the new administrator password +
 - Enter the new administrator password + again
- The green light means that the addition is successful. If there are 3 short beeps and the red light is on, it means that the addition has failed.

2. Registered user password

- When the administrator password has been registered, short press the reset button on the rear panel, and there will be 2 short beeps
 - Enter the registered administrator password +
 - After a long beep and a green light, the administrator verification is successful
 - Enter the new password +
 - Enter the new password + again
- The green light means that the addition is successful. If there are 3 short beeps and the red light is on, it means that the addition has failed.



If you think the password setting is complicated, you can directly scan the QR code to watch the video!

Other operations

1. Error Tips

The red light is on for 2 seconds, and at the same time, the voice sends out three "di-di-di".

2. Success Tips

The green light is on for 2 seconds, and the voice emits a long beep at the same time.

3. Double alarm

Anti-theft alarm



When the password is wrongly entered five times, there will be a voice prompt of "beep" after you enter any key.

Note: the system will be locked for 1 minute, when the system is locked, you need to wait for 1 minutes before entering the password again to unlock.

Battery Dead Alarm

There will be a "beep" sound for 4 times when unlocking; the keyboard light will flash, at this time, please change the battery in a timely manner. (and the door can still be opened for 200 times.)

4. Bluetooth connection settings

- Add administrator password
- Press 3+ , the door lock beeps twice
- Enter the administrator password + 
- The green light flashes, and there is a long beep
- Now take out the mobile phone and start connecting the door lock (it needs to be connected within two minutes, otherwise it will time out. If the time exceeds 2 minutes, you need to start from step a.)

5. Normally-opened functions (the lock is in unlocked status)

Setting of normally-opened functions.

Within 5 seconds after unlocking with the password, press the "7", "8" and  to open the normally open setting, and you will hear a long "di" sound, indicating that the normally open mode is set successfully.

Cancel the normally-opened mode.



Opening the door with the password or people are inside the door to unlock.



If you think the setting of the normally open function is complicated, you can directly scan the QR code to watch the video!

6. Automatic lock switch

When an administrator password is set

- Press 777 + 
- Enter the administrator password + 
- A long beep and the setting is successful

If the automatic lock back is turned off before, the automatic lock back is turned on.

If the automatic lock back is turned on before, the automatic lock back is turned off.



If you think the Auto Lock settings is complicated, you can directly scan the QR code to watch the video!

7. Volume setting

Adjust the beep volume, press "333+" to set the volume, there are 3 levels of volume: "small-medium-large" cycle setting.



If you think the volume settings is complicated, you can directly scan the QR code to watch the video!

8. Emergency power supply

Emergency power supply interface type c equipped on the front bottom side of the smart lock: to unlock the door temporarily by connecting to the emergency power supply interface with the power bank. After unlocking, please replace the battery inside the lock immediately.

■ Operating process

Opening and closing the door inside

One-click opening and locking inside

If you are inside the door and want to get out, or lock the door inside speedily, press the door opening and closing key inside, and turn the opening and locking lock with motor.

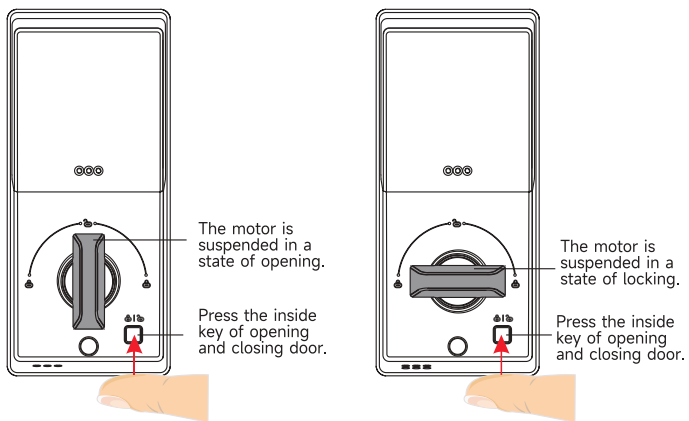

Manual locking inside

When the system is in a state as delivered, the initialized setting is carried out for the lock (No users entered), the direction will be automatically set after being power on, long "beep" sound refers to successful setting of the lock direction.

Note: when the users are entered, the unlocking direction of lock cannot be automatically set.

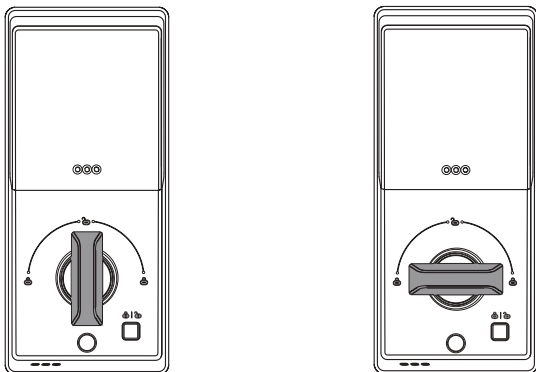

■ Precautions

1. Prohibit any disassembly at will

The product is composed of precise and complex components, please do not disassemble any structures inside to avoid operation abnormalities of the product or other use danger resulting from this. If you need to disassemble, again, please contact a professional.

2. Choose cleaning method carefully

Please clean the product with dry cloth, water is prohibited to clean the product to avoid power failure.

3. Measures to cope with battery running low or out of power

a. Prompt of battery running low

There will be a "beep" sound for 4 times when unlocking. The keyboard light will flash, at this time, please change the battery in a timely manner.

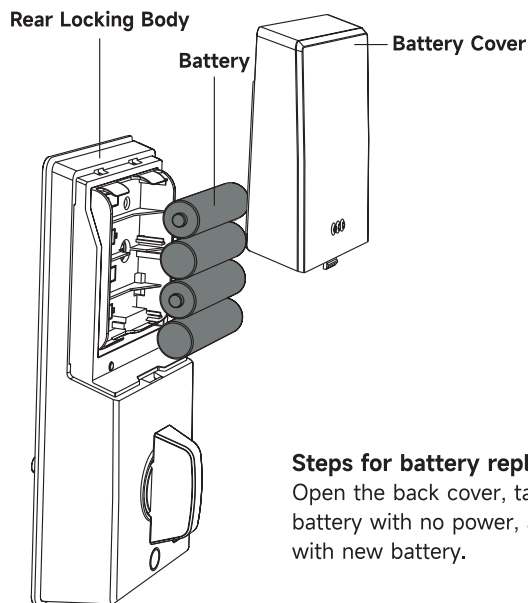

Steps for battery replacement:

Open the back cover, take out the battery with no power, and replace with new battery.

■ FCC Statement

This device complies with Part 15 of the FCC Rules. Operation is subject to the following two conditions: (1) this device may not cause harmful interference, and (2) this device must accept any interference received, including interference that may cause undesired operation.

● Warnings:

Changes or modifications to this unit not expressly approved by the party responsible for compliance could void the user's authority to operate the equipment.

● Note:

This equipment has been tested and found to comply with the limits for a Class B digital device, pursuant to Part 15 of the FCC Rules. These limits are designed to provide reasonable protection against harmful interference in a residential installation. This equipment generates uses and can radiate radio frequency energy and, if not installed and used in accordance with the instructions, may cause harmful interference to radio communications.

However, there is no guarantee that interference will not occur in a particular installation. If this equipment does cause harmful interference to radio or television reception, which can be determined by turning the equipment off and on, the user is encouraged to try to correct the interference by one or more of the following measures:

- (1) Reorient or relocate the receiving antenna.
- (2) Increase the separation at the equipment and receiver.
- (3) Connect the equipment into an outlet on a circuit different from that to which the receiver is connected.
- (4) Consult the dealer or an experienced radio/TV technician for help.

■ Warranty

- We provide 30 days worry-free money back and one year limited warranty.
- Any problem, please feel free to contact us.
E-mail us at: support@arpha.com

D601说明书

材质:105g铜版纸 四色印刷 骑马订

成品尺寸:178*108mm