

TEST REPORT

Product Name : R105 Industrial Router
Model Number : VT-M2M-R105, VT-M2M-R105-F4NA,
VT-M2M-R105-F4NA-C
FCC ID : 2BEA6M2MR105

Prepared for : Vantron Technology, Inc
Address : 48434 Milmont Drive Fremont, CA 94538-7324, USA

Prepared by : EMTEK (SHENZHEN) CO., LTD.
Address : Building 69, Majialong Industry Zone, Nanshan District,
Shenzhen, Guangdong, China

Tel: (0755) 26954280
Fax: (0755) 26954282

Report Number : ENS2310300217W00201R
Date(s) of Tests : October 31, 2023 to November 17, 2023
Date of issue : November 20, 2023

TABLE OF CONTENTS

1	TEST RESULT CERTIFICATION	3
2	EUT TECHNICAL DESCRIPTION	5
3	SUMMARY OF TEST RESULT	5
4	TEST METHODOLOGY	7
4.1	GENERAL DESCRIPTION OF APPLIED STANDARDS	7
4.2	MEASUREMENT EQUIPMENT USED	7
4.3	DESCRIPTION OF TEST MODES	8
5	FACILITIES AND ACCREDITATIONS	9
5.1	FACILITIES	9
5.2	EQUIPMENT	9
5.3	LABORATORY ACCREDITATIONS AND LISTINGS	9
6	TEST SYSTEM UNCERTAINTY	10
7	SETUP OF EQUIPMENT UNDER TEST	11
7.1	RADIO FREQUENCY TEST SETUP 1	11
7.2	RADIO FREQUENCY TEST SETUP 2	11
7.3	CONDUCTED EMISSION TEST SETUP	14
7.4	BLOCK DIAGRAM CONFIGURATION OF TEST SYSTEM	15
7.5	SUPPORT EQUIPMENT	15
8	TEST REQUIREMENTS	16
8.1	DTS 6DB BANDWIDTH	16
8.2	DTS 99% BANDWIDTH	26
8.3	MAXIMUM PEAK CONDUCTED OUTPUT POWER	36
8.4	MAXIMUM POWER SPECTRAL DENSITY	58
8.5	UNWANTED EMISSIONS IN NON-RESTRICTED FREQUENCY BANDS	68
8.6	RADIATED SPURIOUS EMISSION	107
8.7	CONDUCTED EMISSION TEST	119
8.8	ANTENNA APPLICATION	122

1 TEST RESULT CERTIFICATION

Applicant : Vantron Technology, Inc
 Address : 48434 Milmont Drive Fremont, CA 94538-7324, USA
 Manufacturer : Vantron Technology, Inc
 Address : 48434 Milmont Drive Fremont, CA 94538-7324, USA
 EUT : R105 Industrial Router
 Model Name : VT-M2M-R105, VT-M2M-R105-F4NA, VT-M2M-R105-F4NA-C
 Trademark : Vantron

Measurement Procedure Used:

APPLICABLE STANDARDS	
STANDARD	TEST RESULT
FCC 47 CFR Part 2, Subpart J FCC 47 CFR Part 15, Subpart C	PASS
IC RSS-GEN, Issue 5(04-2018)+A1(03-2019)+A2(02-2021) IC RSS-247 Issue 2(02-2017)	PASS

The above equipment was tested by EMTEK(SHENZHEN) CO., LTD. The test data, data evaluation, test procedures, and equipment configurations shown in this report were made in accordance with the procedures given in ANSI C63.10 (2013) and the energy emitted by the sample EUT tested as described in this report is in compliance with the requirements of FCC Rules Part 2, Part 15.247, IC RSS-247 Issue 2 and IC RSS-GEN, Issue 5.

The test results of this report relate only to the tested sample identified in this report.

Date of Test : October 31, 2023 to November 17, 2023

Prepared by : *Luo Pei Ye*
 Luo peiye /Editor

Reviewer : *Joe Xia*
 Joe Xia /Supervisor

Approve & Authorized Signer : *[Signature]*
 Lisa Wang/Manager



Modified History

Version	Report No.	Revision Date	Summary
Ver.1.0	ENS2310300217W00201R	/	Original Report



2 EUT TECHNICAL DESCRIPTION

Characteristics	Description
Product:	R105 Industrial Router
Model Number:	VT-M2M-R105, VT-M2M-R105-F4NA, VT-M2M-R105-F4NA-C (These models are identical in circuitry and electrical, mechanical and physical construction; Only the appearance is different)
Sample Number:	2#
IEEE 802.11 WLAN Mode Supported:	802.11b 802.11g 802.11n(20MHz channel bandwidth) 802.11ax(20MHz channel bandwidth)
Modulation:	DSSS with DBPSK/DQPSK/CCK for 802.11b; OFDM with BPSK/QPSK/16QAM/64QAM for 802.11g/n; OFDM with BPSK/QPSK/16QAM/64QAM/256QAM/1024QAM for 802.11ax;
Operating Frequency Range:	2412-2462MHz for 802.11b/g/n(HT20)/ax(HE20);
Number of Channels:	11 channels for 802.11b/g/n(HT20)/ax(HE20);
Transmit Power Max:	15.17 dBm
Antenna Port:	<input checked="" type="checkbox"/> Antenna port 1, <input checked="" type="checkbox"/> Antenna port 2
Antenna Type:	<input checked="" type="checkbox"/> ANT 1: External Antenna <input checked="" type="checkbox"/> ANT 2: External Antenna
Antenna Gain:	<input checked="" type="checkbox"/> ANT 1: 1.78 dBi <input checked="" type="checkbox"/> ANT 2: 1.78 dBi
Power Supply:	DC 12V
Adapter 1#:	MODEL NO.:GST25A12 INPUT:100-240VAC, 50/60Hz, 0.6A OUTPUT:12V, 2.08A, 25W MAX.
Adapter 2#:	MODEL:KS39DU-1200200 INPUT:100-240VAC, 50/60Hz, 2A OUTPUT:12V, 2A.
Test Voltage:	AC 120V/60Hz
Date of Received	October 30, 2023
Temperature Range	-20°C ~ +60°C
<i>Note: For more details, please refer to the User's manual of the EUT.</i>	

3 SUMMARY OF TEST RESULT

FCC PartClause	IC Part Clause	Test Parameter	Verdict	Remark
15.247(a)(2)	RSS-247, 5.2(a) RSS-Gen6.7	Emission Bandwidth	PASS	
15.247(b)(3)	RSS-247, 5.4(d) RSS-Gen6.12	Maximum Peak Conducted Output Power	PASS	
15.247(e)	RSS-247, 5.2(b) RSS-Gen6.12	Maximum Power Spectral Density Level	PASS	
15.247(d)	RSS-247, 5.5	Unwanted Emission Into Non-Restricted Frequency Bands	PASS	
15.247(d)	RSS-247, 5.5	Unwanted Emission Into Restricted Frequency Bands (conducted)	PASS	
15.247(d) 15.209 15.205	RSS-Gen 8.9 RSS-Gen 8.10 RSS-Gen 6.13 RSS-247, 3.3 RSS-247, 5.5	Radiated Spurious Emission	PASS	
15.207	RSS-Gen 8.8	Conducted EmissionTest	PASS	
15.203 15.247(b)	RSS-Gen 6.8 RSS-247, 5.4	Antenna Application	PASS	
NOTE1:N/A (Not Applicable)				
NOTE2:According to FCC OET KDB 558074, the report use radiated measurements in the restricted frequency bands. In addition, the radiated test is also performed to ensure the emissions emanating from the device cabinet also comply with the applicable limits.				

RELATED SUBMITTAL(S) / GRANT(S):

This submittal(s) (test report) is intended for **FCC ID:2BEA6M2MR105** filing to comply with Section 15.247 of the FCC Part 15, Subpart C Rules.

4 TEST METHODOLOGY

4.1 GENERAL DESCRIPTION OF APPLIED STANDARDS

According to its specifications, the EUT must comply with the requirements of the following standards:

FCC 47 CFR Part 2, Subpart J

FCC 47 CFR Part 15, Subpart C

IC RSS-GEN, Issue 5(04-2018)+A1(03-2019)+A2(02-2021)

IC RSS-247 Issue 2(02-2017)

FCC KDB 558074 D01 15.247 Meas Guidance v05r02

FCC KDB 662911 D01 Multiple Transmitter Output v02r01

4.2 MEASUREMENT EQUIPMENT USED

Conducted Emission Test Equipment

Equipment	Manufacturer	Model No.	Serial No.	Last Cal.	Cal. Interval
EMI Test Receiver	Rohde & Schwarz	ESCI	101384	2023/5/13	1Year
AMN	Rohde & Schwarz	ENV216	101161	2023/5/13	1Year
AMN	Kyoritsu	KNW-407	8-1492-9	2023/5/11	1Year

For Spurious Emissions Test

Equipment	Manufacturer	Model No.	Serial No.	Last Cal.	Cal. Interval
Pre-Amplifier	Bonn	BLMA 011001N	2213967A	2023/10/23	1Year
EMI Test Receiver	Rohde & Schwarz	ESR7	102551	2023/10/23	1Year
Bilog Antenna	Schwarzbeck	VULB9163	9163142	2022/7/24	2 Year
Horn antenna	Schwarzbeck	BBHA9120D	9120D-1198	2023/6/2	2 Year
Pre-Amplifier	Bonn	BLMA 0118-5G	2213967B-01	2023/10/23	1Year
Spectrum Analyzer	Rohde & Schwarz	FSV3044	101290	2023/10/23	1Year
Horn antenna	Schwarzbeck	BBHA9170	9170-399	2023/5/12	2 Year
Pre-Amplifier	Lunar EM	LNA18G26-40	J101213101000 1	2023/5/10	2 Year
Pre-Amplifier	Lunar EM	LNA26G40-40	J101313102800 1	2023/5/10	1 Year
Loop Antenna	Schwarzbeck	FMZB1519	1519-012	2023/5/12	1 Year
Band reject Filter(50dB)	WI/DE	WRCGV-2400(2400-2485MHZ)	2	2023/5/13	1 Year

For other test items:

Equipment	Manufacturer	Model No.	Serial No.	Last Cal.	Cal. Interval
Signal Analyzer	Agilent	N9010A	MY53470879	2023/5/10	1Year
Vector Signal Generater	Agilent	N5182B	MY53050878	2023/5/10	1Year
Analog Signal Generator	Agilent	N5171B	MY53050553	2023/5/10	1Year
Power Meter	Agilent	PS-X10-100	\	2023/5/13	1Year
Switchgroup	THEDA	ETF-025(VASC6)	TW5451008	N/A	N/A
MIMO Matrix Switch	THEDA	4P5TM18	TW5451009	N/A	N/A
Temperature&Humidity Chamber	ESPEC	EL-02KA	12107166	2023/5/10	1 Year

4.3 DESCRIPTION OF TEST MODES

The EUT has been tested under its typical operating condition.

The EUT configuration for testing is installed on RF field strength measurement to meet the Commissions requirement and operating in a manner which intends to maximize its emission characteristics in a continuous normal application.

The Transmitter was operated in the normal operating mode. The TX frequency was fixed which was for the purpose of the measurements.

Test of channel included the lowest and middle and highest frequency to perform the test, then record on this report.

Those data rates (802.11b: 1 Mbps; 802.11g: 6 Mbps; 802.11n (HT20): MCS0; 802.11ax (HE20): MCS0;) were used for all test.

Pre-defined engineering program for regulatory testing used to control the EUT for staying in continuous transmitting and receiving mode is programmed.

Frequency and Channel list for 802.11 b/g/n(HT20)/ax(HE20):

Channel	Frequency (MHz)	Channel	Frequency (MHz)	Channel	Frequency (MHz)
1	2412	5	2432	9	2452
2	2417	6	2437	10	2457
3	2422	7	2442	11	2462
4	2427	8	2447		

Test Frequency and Channel for 802.11 b/g/n(HT20)/ax(HE20):

Lowest Frequency		Middle Frequency		Highest Frequency	
Channel	Frequency (MHz)	Channel	Frequency (MHz)	Channel	Frequency (MHz)
1	2412	6	2437	11	2462

The 2.4G WIFI has two antennas and support Multiple Outputs for 802.11n mode for this report; Antenna 1 Gain is 1.78 dBi; Antenna 2 Gain is 1.78 dBi; for this function is belong to Correlated Categorization equipment

According to KDB 662911, for equal antenna gains,

Directional gain = GANT + 10 log(NANT) dBi=4.3 dBi

5 FACILITIES AND ACCREDITATIONS

5.1 FACILITIES

All measurement facilities used to collect the measurement data are located at:

EMTEK (Shenzhen) Co., Ltd.

Building 69, Majialong Industry Zone District, Nanshan District, Shenzhen, China

The sites are constructed in conformance with the requirements of ANSI C63.7, ANSI C63.4 and CISPR Publication 22.

5.2 EQUIPMENT

Radiated emissions are measured with one or more of the following types of linearly polarized antennas: tuned dipole, biconical, log periodic, bi-log, and/or ridged waveguide, horn. Spectrum analyzers with preselectors and quasi-peak detectors are used to perform radiated measurements.

Conducted emissions are measured with Line Impedance Stabilization Networks and EMI Test Receivers.

Calibrated wideband preamplifiers, coaxial cables, and coaxial attenuators are also used for making measurements.

All receiving equipment conforms to CISPR Publication 16-1, "Radio Interference Measuring Apparatus and Measurement Methods."

5.3 LABORATORY ACCREDITATIONS AND LISTINGS

Site Description	
EMC Lab.	<p>: Accredited by CNAS The Certificate Registration Number is L2291. The Laboratory has been assessed and proved to be in compliance with CNAS-CL01 (identical to ISO/IEC 17025:2017)</p> <p>Accredited by FCC Designation Number: CN1204 Test Firm Registration Number: 882943</p> <p>Accredited by A2LA The Certificate Number is 4321.01.</p> <p>Accredited by Industry Canada The Conformity Assessment Body Identifier is CN0008</p>
Name of Firm	: EMTEK (SHENZHEN) CO., LTD.
Site Location	: Building 69, Majialong Industry Zone, Nanshan District, Shenzhen, Guangdong, China

6 TEST SYSTEM UNCERTAINTY

The following measurement uncertainty levels have been estimated for tests performed on the apparatus:

Test Parameter	Measurement Uncertainty
Frequency error	$\pm 20\text{Hz}$
Occupied Bandwidth	$\pm 0.5\text{KHz}$
Transmitter output power	$\pm 0.6\text{dB}$
Conducted spurious emissions	$\pm 3.2\text{dB}$
Radiated spurious emissions	$\pm 4.5\text{dB}$
Temperature	$\pm 1.2^\circ\text{C}$
Humidity	$\pm 3\%$
DC voltages	$\pm 0.25\text{V}$
Time	$\pm 1\%$

Measurement Uncertainty for a level of Confidence of 95%

7 SETUP OF EQUIPMENT UNDER TEST

7.1 RADIO FREQUENCY TEST SETUP 1

The WLAN component's antenna ports(s) of the EUT are connected to the measurement instrument per an appropriate attenuator. The EUT is controlled by PC/software to emit the specified signals for the purpose of measurements.

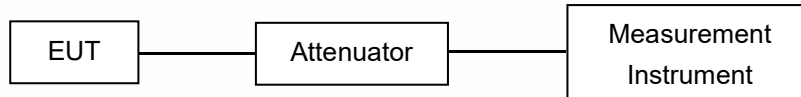

7.2 RADIO FREQUENCY TEST SETUP 2

The test site semi-anechoic chamber has met the requirement of NSA tolerance 4 dB according to the standards: ANSI C63.10. The test distance is 3m. The setup is according to the requirements in Section 13.1.4.1 of ANSI C63.10-2013 and CAN/CSA-CEI/IEC CISPR 22.

The maximal emission value is acquired by adjusting the antenna height, polarisation and turntable azimuth. Normally, the height range of antenna is 1 m to 4 m, the azimuth range of turntable is 0° to 360°, and the receive antenna has two polarizations Vertical (V) and Horizontal (H).

Below 30MHz:

The EUT is placed on a turntable 0.8 meters above the ground in the chamber, 3 meter away from the antenna (loop antenna). The Antenna should be positioned with its plane vertical at the specified distance from the EUT and rotated about its vertical axis for maximum response at each azimuth about the EUT. The center of the loop shall be 1 m above the ground. For certain applications, the loop antenna plane may also need to be positioned horizontally at the specified distance from the EUT.

Above 30MHz:

The EUT is placed on a turntable 0.8 meters above the ground in the chamber, 3 meter away from the antenna. The maximal emission value is acquired by adjusting the antenna height, polarisation and turntable azimuth. Normally, the height range of antenna is 1 m to 4 m, the azimuth range of turntable is 0° to 360°, and the receive antenna has two polarizations Vertical (V) and Horizontal (H).

Above 1GHz:

The EUT is placed on a turntable 1.5 meters above the ground in the chamber, 3 meter away from the antenna. The maximal emission value is acquired by adjusting the antenna height, polarisation and turntable azimuth. Normally, the height range of antenna is 1 m to 4 m, the azimuth range of turntable is 0° to 360°, and the receive antenna has two polarizations Vertical (V) and Horizontal (H).

Measurements shall be taken, using the following steps, at a test site that has been validated using the procedures of ANSI C63.4 or the latest CISPR 16-1-4 for measurements above 1 GHz, so as to simulate a near free-space environment (see RSS-Gen for applicable versions of ANSI and CISPR standards).

(1) Line the ground plane with absorbers between the transmitter and the receive antenna to minimize reflections. The absorbers used should have a minimum-rated attenuation of 20 dB through the measurement frequency range of interest. The absorbers shall be positioned to replicate the layout used when compliance with the applicable acceptability criterion was achieved, as set forth in the aforementioned standards on site validation.

(2) Set the height of the receive antenna to 1.5 m. The receive antenna must be one that was designed and fabricated to operate over the entire frequency range of interest, for example, an appropriate standard gain horn.

(3) The distance between the receive antenna and the radiating source shall be sufficient in order to ensure far-field conditions.

(4) Mount the transmitter at a height of 1.5 m.

(5) Configure the device under test (DUT) to produce the maximum power spectral density as measured while assessing compliance with Section 6.2.2 (i.e. channel frequency, modulation type and data rate). If the DUT is equipped with a detachable antenna and the antenna is intended for remote installation (i.e. tower-mounted), the DUT may be substituted with a suitable signal generator. The level and frequency settings on the generator shall be set so as to reproduce the maximum power spectral density, measured

within a 1 MHz bandwidth, obtained while assessing compliance to Section 6.2.2.

(6) Position the transmitter or the radiating antenna so that elevation pattern measurements can be taken.

(7) Find the 0° reference point in the horizontal plane.

(8) Care should be taken when positioning the receive antenna to avoid cross-polarization. Antennas of known mounting polarization should be assessed with the receive antenna oriented in the same polarity. If the polarization of the transmit antenna is unknown or the transmit antenna can be mounted in either polarization, e.i.r.p. measurements should be performed to find which mounting polarity provides the highest e.i.r.p. value. Testing shall be carried out with the receive antenna and the DUT mounted in each polarity.

(9) The emission shall be centred on the display of the spectrum analyzer with the following settings:

i. If the power spectral density of the DUT was assessed with a peak detector and the antenna cannot be detached from the DUT, the spectrum analyzer shall be set to a peak detector with a resolution bandwidth and video bandwidth of 1 MHz.

ii. If the power spectral density of the DUT was assessed using a sample detector with power averaging and the antenna cannot be detached from the DUT, the spectrum analyzer shall be set to a sample detector, configured to produce 100 power averages and set with a resolution bandwidth, as well as a video bandwidth of 1 MHz.

iii. If the antenna can be detached from the DUT, a continuous wave (CW) signal equal to that of the power spectral density measurement may be used, the spectrum analyzer shall be set to peak detector with a resolution bandwidth and video bandwidth of 1 MHz.

(10) Rotate the turntable 360° recording the field strength at each step. Throughout the main beam of the antenna, the step size shall be kept to a maximum of 1°.

Once outside the main beam of the antenna, the maximum step size shall be as follows, when compared to the requirements of Section 6.2.2:

i. Between 0° and 8°, maximum step size of 2°;

ii. Between 8° and 40°, maximum step size of 4°;

iii. Between 40° and 45°, maximum step size of 1°;

iv. Between 45° and 90°, maximum step size of 5°.

Once the mask reaches 90°, the mask will be inverted and the step size will follow in the same manner as above.

For the purpose of this procedure, the main beam of the antenna is defined as the 3 dB beamwidth.

(11) Convert the measured field strength values in terms of e.i.r.p. density (dBW/1 MHz) using the following equation:

$$\text{e.i.r.p. density (dBW/MHz)} = 10 \log((E \cdot r)^2 / 30)$$

E = field strength in V/m

r = measurement distance in metres

(12) Plot the results against the emission mask with reference to the horizontal plane.

(13) Using the plot, the 0° can be rotated to determine the worst-case installation tilt angle.

(14) Testing shall be performed using the highest gain antenna for every antenna type, if applicable.

(15) Antenna type(s), antenna model number(s), and worst-case tilt angle(s) necessary to remain compliant with the elevation mask requirement set forth in Section 6.2.2(3) of RSS-247 shall be clearly indicated in the user manual.

The following figure is an example of a polar elevation mask measured using the Method 1 reference to dB μ V/m at 3 m.

(a) Radiated Emission Test Set-Up, Frequency Below 30MHz

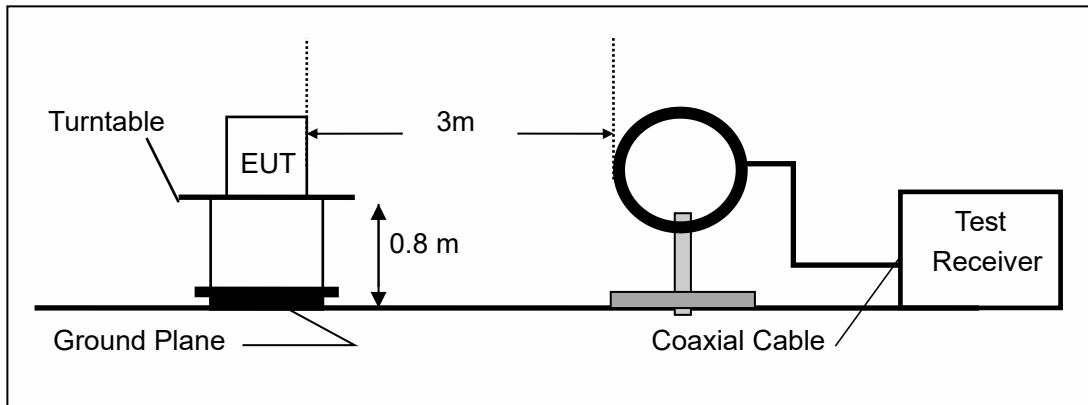

(b) Radiated Emission Test Set-Up, Frequency Below 1000MHz

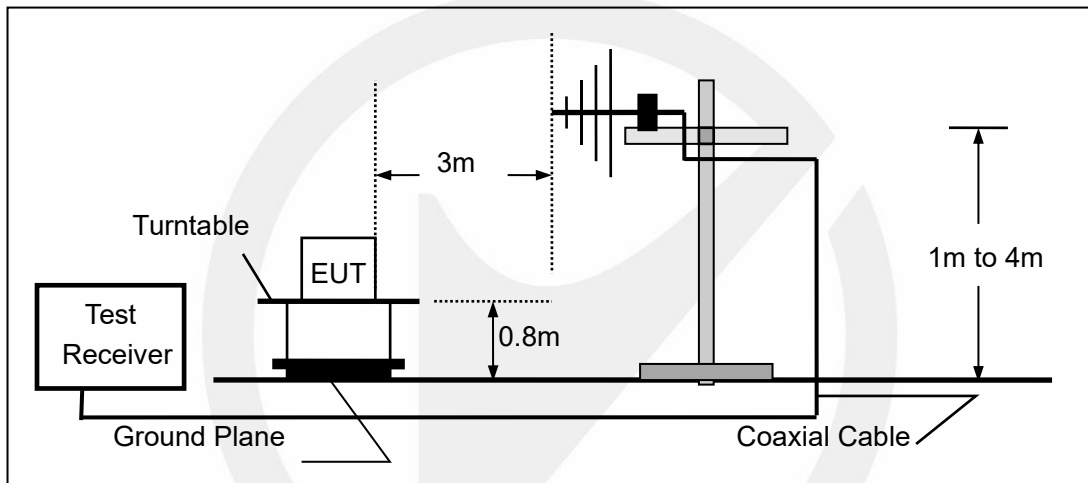

(c) Radiated Emission Test Set-Up, Frequency above 1000MHz

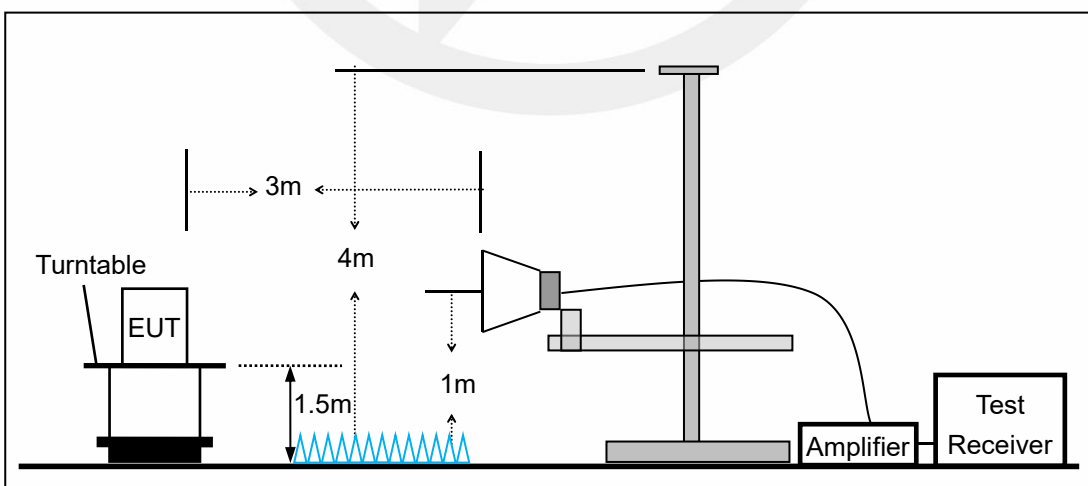

7.3 CONDUCTED EMISSION TEST SETUP

The mains cable of the EUT (maybe per AC/DC Adapter) must be connected to LISN. The LISN shall be placed 0.8 m from the boundary of EUT and bonded to a ground reference plane for LISN mounted on top of the ground reference plane. This distance is between the closest points of the LISN and the EUT. All other units of the EUT and associated equipment shall be at least 0.8m from the LISN.

Ground connections, where required for safety purposes, shall be connected to the reference ground point of the LISN and, where not otherwise provided or specified by the manufacturer, shall be of same length as the mains cable and run parallel to the mains connection at a separation distance of not more than 0.8 m.

According to the requirements in Section 13.1.4.1 of ANSI C63.10-2013 Conducted emissions from the EUT measured in the frequency range between 0.15 MHz and 30 MHz using CISPR Quasi-Peak and average detector mode.

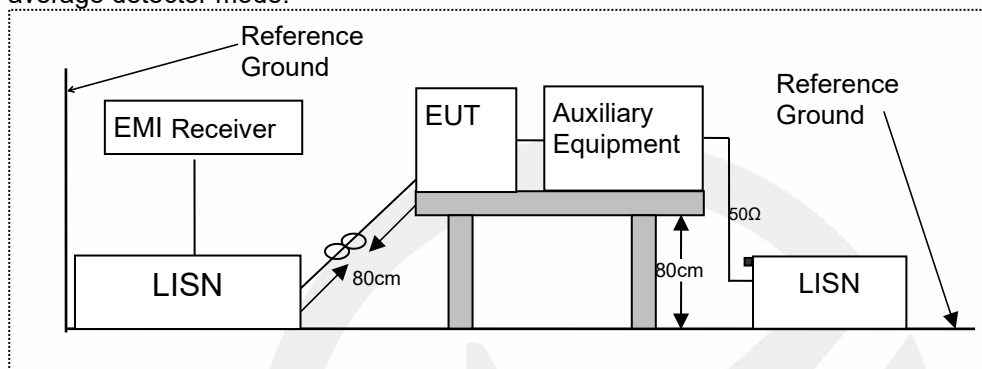

7.4 BLOCK DIAGRAM CONFIGURATION OF TEST SYSTEM

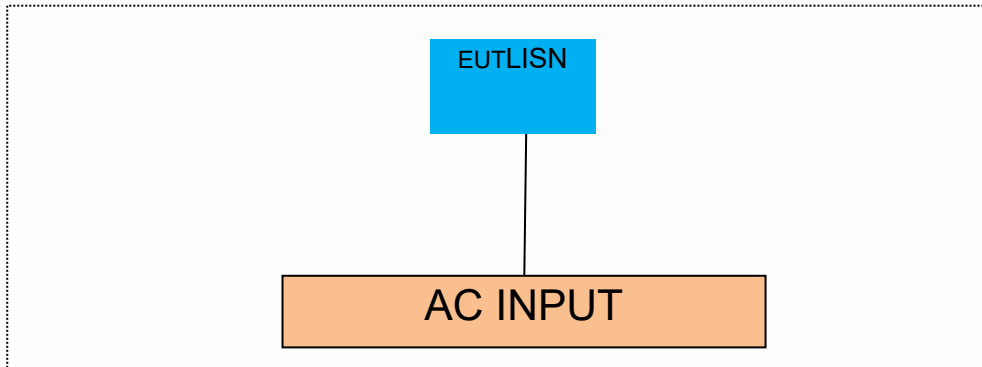

7.5 SUPPORT EQUIPMENT

EUT Cable List and Details			
Cable Description	Length (m)	Shielded/Unshielded	With / Without Ferrite
/	/	/	/

Auxiliary Cable List and Details			
Cable Description	Length (m)	Shielded/Unshielded	With / Without Ferrite
/	/	/	/

Auxiliary Equipment List and Details			
Description	Manufacturer	Model	Serial Number
Notebook	Lenovo	ThinkPad S2 Yoga 3rd Gen	R9-OR98VZ

Notes:

1. All the equipment/cables were placed in the worst-case configuration to maximize the emission during the test.
2. Grounding was established in accordance with the manufacturer's requirements and conditions for the intended use.

8 TEST REQUIREMENTS

8.1 DTS 6DB BANDWIDTH

8.1.1 Applicable Standard

According to FCC Part15.247 (a)(2) and KDB 558074 D01 15.247 Meas Guidance v05r02
According to RSS-247, 5.2(a)

8.1.2 Conformance Limit

The minimum -6 dB bandwidth shall be at least 500 kHz.

8.1.3 Test Configuration

Test according to clause 6.1 radio frequency test setup

8.1.4 Test Procedure

The EUT was operating in WIFI mode and controlled its channel. Printed out the test result from the spectrum by hard copy function.

The RF output of EUT was connected to the spectrum analyzer by RF cable and attenuator. The path loss was compensated to the results for each measurement.

Set to the maximum power setting and enable the EUT transmit continuously

Set RBW = 100 kHz.

Set the video bandwidth (VBW) =300kHz.

Set Span=2 times OBW

Set Detector = Peak.

Set Trace mode = max hold.

Set Sweep = auto couple.

Allow the trace to stabilize.

Measure the maximum width of the emission that is constrained by the frequencies associated with the two outermost amplitude points (upper and lower frequencies) that are attenuated by 6 dB relative to the maximum level measured in the fundamental emission.

Measure and record the results in the test report.

8.1.5 Test Results

Temperature:	25°C
Relative Humidity:	45%
ATM Pressure:	1011 mbar

Note: N/A

TestMode	Antenna	Frequency[MHz]	DTS BW [MHz]	FL[MHz]	FH[MHz]	Limit[MHz]	Verdict
11B	Ant1	2412	7.080	2408.440	2415.520	0.5	PASS
	Ant2	2412	8.040	2407.960	2416.000	0.5	PASS
	Ant1	2437	8.000	2433.000	2441.000	0.5	PASS
	Ant2	2437	7.560	2433.440	2441.000	0.5	PASS
	Ant1	2462	7.560	2458.440	2466.000	0.5	PASS
	Ant2	2462	8.000	2457.960	2465.960	0.5	PASS
11G	Ant1	2412	16.360	2403.800	2420.160	0.5	PASS
	Ant2	2412	16.360	2403.800	2420.160	0.5	PASS
	Ant1	2437	16.360	2428.800	2445.160	0.5	PASS
	Ant2	2437	16.360	2428.800	2445.160	0.5	PASS
	Ant1	2462	16.360	2453.800	2470.160	0.5	PASS
	Ant2	2462	16.360	2453.800	2470.160	0.5	PASS
11N20MIMO	Ant1	2412	17.600	2403.200	2420.800	0.5	PASS
	Ant2	2412	17.560	2403.200	2420.760	0.5	PASS
	Ant1	2437	17.560	2428.200	2445.760	0.5	PASS
	Ant2	2437	17.600	2428.200	2445.800	0.5	PASS
	Ant1	2462	17.560	2453.200	2470.760	0.5	PASS
	Ant2	2462	17.600	2453.200	2470.800	0.5	PASS
11AX20MIMO	Ant1	2412	18.560	2402.880	2421.440	0.5	PASS
	Ant2	2412	16.320	2403.200	2419.520	0.5	PASS
	Ant1	2437	18.640	2427.840	2446.480	0.5	PASS
	Ant2	2437	16.560	2429.440	2446.000	0.5	PASS
	Ant1	2462	17.480	2453.880	2471.360	0.5	PASS
	Ant2	2462	18.200	2453.120	2471.320	0.5	PASS

11B_Ant1_2412



11B_Ant2_2412



11B_Ant1_2437



11B_Ant2_2437



11B_Ant1_2462



11B_Ant2_2462



11G Ant1_2412



11G Ant2_2412

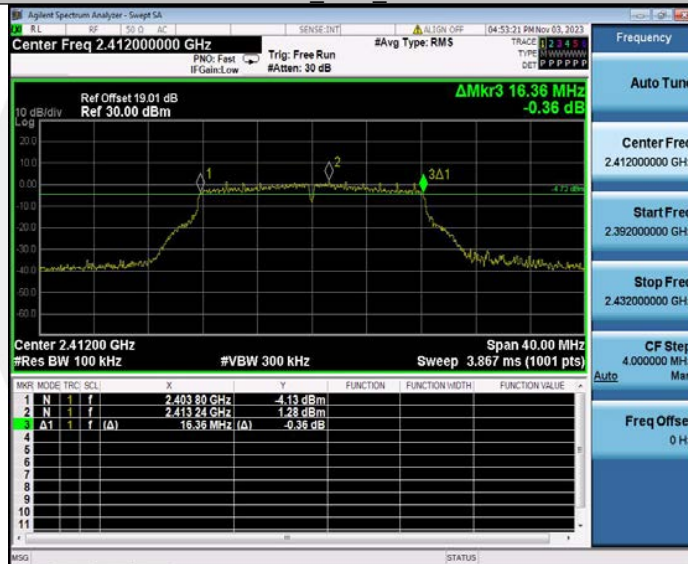

11G Ant1_2437



11G_Ant2_2437



11G_Ant1_2462



11G_Ant2_2462



11N20MIMO_Ant1_2412



11N20MIMO_Ant2_2412

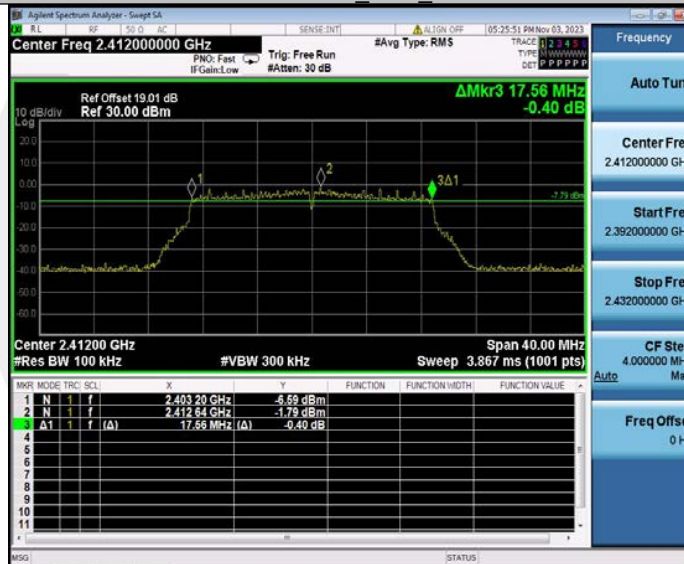

11N20MIMO_Ant1_2437



11N20MIMO_Ant2_2437



11N20MIMO_Ant1_2462

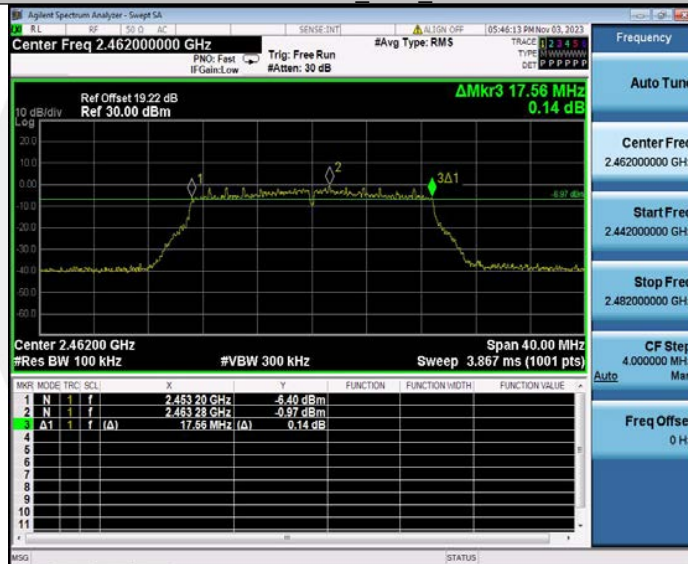

11N20MIMO_Ant2_2462



11AX20MIMO_Ant1_2412

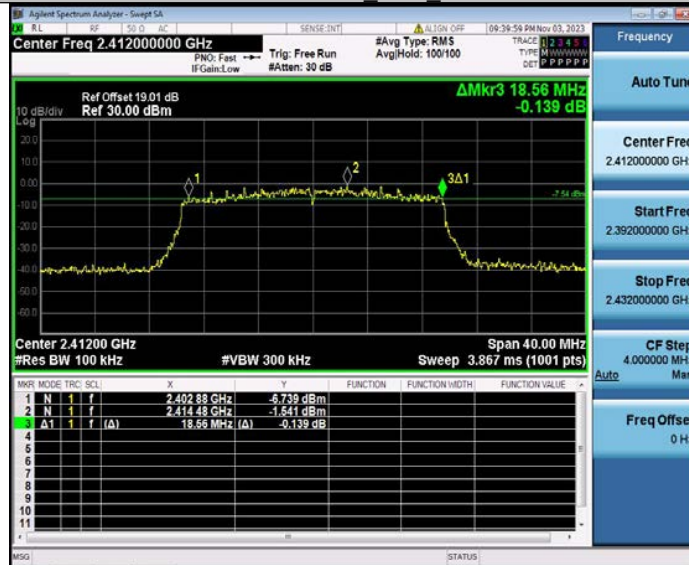

11AX20MIMO_Ant2_2412

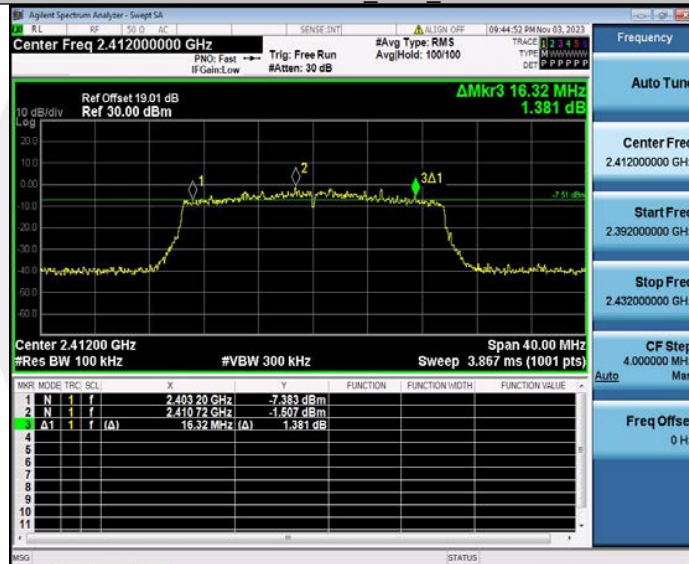

11AX20MIMO_Ant1_2437



11AX20MIMO_Ant2_2437



11AX20MIMO_Ant1_2462

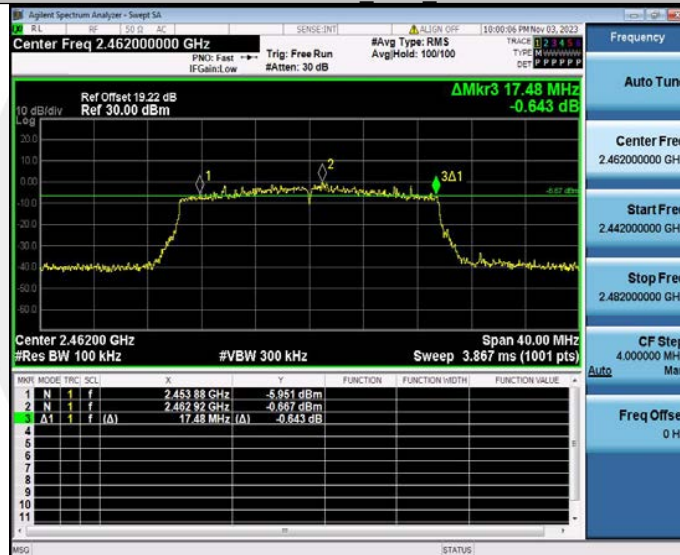

11AX20MIMO_Ant2_2462



8.2 DTS 99%BANDWIDTH

8.2.1 Applicable Standard

According to RSS-Gen6.7 and KDB 558074 D01 DTS Meas Guidance v05r02

8.2.2 Test Configuration

Test according to clause 7.1 radio frequency test setup 1

8.2.3 Test Procedure

The EUT was operating in Bluetooth mode and controlled its channel. Printed out the test result from the spectrum by hard copy function.

The RF output of EUT was connected to the spectrum analyzer by RF cable and attenuator. The path loss was compensated to the results for each measurement.

Set to the maximum power setting and enable the EUT transmit continuously

Set RBW = 1%-5% OBW.

Set the video bandwidth (VBW) $\geq 3 \times \text{RBW}$.

Set Span=approximately 2 to 3 times the 20 dB bandwidth.

Set Detector = Peak.

Set Trace mode = max hold.

Set Sweep = auto couple.

Allow the trace to stabilize.

Use the 99 % power bandwidth function of the instrument

Measure the maximum width of the emission.

If this value varies with different modes of operation (e.g., data rate, modulation format, etc.), repeat this test for each variation.

Measure and record the results in the test report.

8.2.4 Test Results

Temperature:	25°C
Relative Humidity:	45%
ATM Pressure:	1011 mbar

Note: N/A

TestMode	Antenna	Channel Frequency[MHz]	OCB [MHz]	FL[MHz]	FH[MHz]	Limit[MHz]	Verdict
11B	Ant1	2412	12.237	2405.9237	2418.1607	---	---
	Ant2	2412	12.300	2405.8294	2418.1294	---	---
	Ant1	2437	12.365	2430.8663	2443.2313	---	---
	Ant2	2437	12.190	2430.8979	2443.0879	---	---
	Ant1	2462	12.364	2455.8638	2468.2278	---	---
	Ant2	2462	12.128	2455.9429	2468.0709	---	---
11G	Ant1	2412	17.459	2403.3475	2420.8065	---	---
	Ant2	2412	17.380	2403.2720	2420.6520	---	---
	Ant1	2437	17.435	2428.3472	2445.7822	---	---
	Ant2	2437	17.389	2428.2847	2445.6737	---	---
	Ant1	2462	17.431	2453.3147	2470.7457	---	---
	Ant2	2462	17.441	2453.3069	2470.7479	---	---
11N20MIMO	Ant1	2412	18.438	2402.8461	2421.2841	---	---
	Ant2	2412	17.977	2402.9787	2420.9557	---	---
	Ant1	2437	18.348	2427.8744	2446.2224	---	---
	Ant2	2437	17.959	2428.0076	2445.9666	---	---
	Ant1	2462	18.491	2452.7543	2471.2453	---	---
	Ant2	2462	17.989	2453.0088	2470.9978	---	---
11AX20MIMO	Ant1	2412	18.947	2402.5809	2421.5279	---	---
	Ant2	2412	19.010	2402.5024	2421.5124	---	---
	Ant1	2437	18.962	2427.5584	2446.5204	---	---
	Ant2	2437	19.025	2427.5121	2446.5371	---	---
	Ant1	2462	18.964	2452.5285	2471.4925	---	---
	Ant2	2462	18.943	2452.5341	2471.4771	---	---





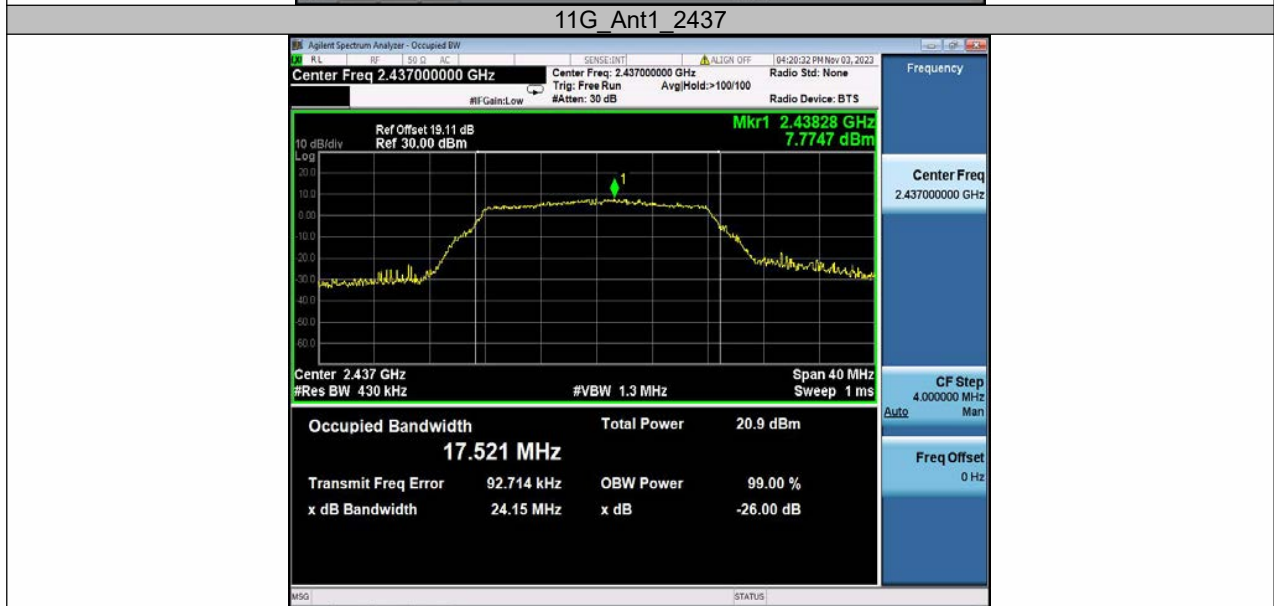
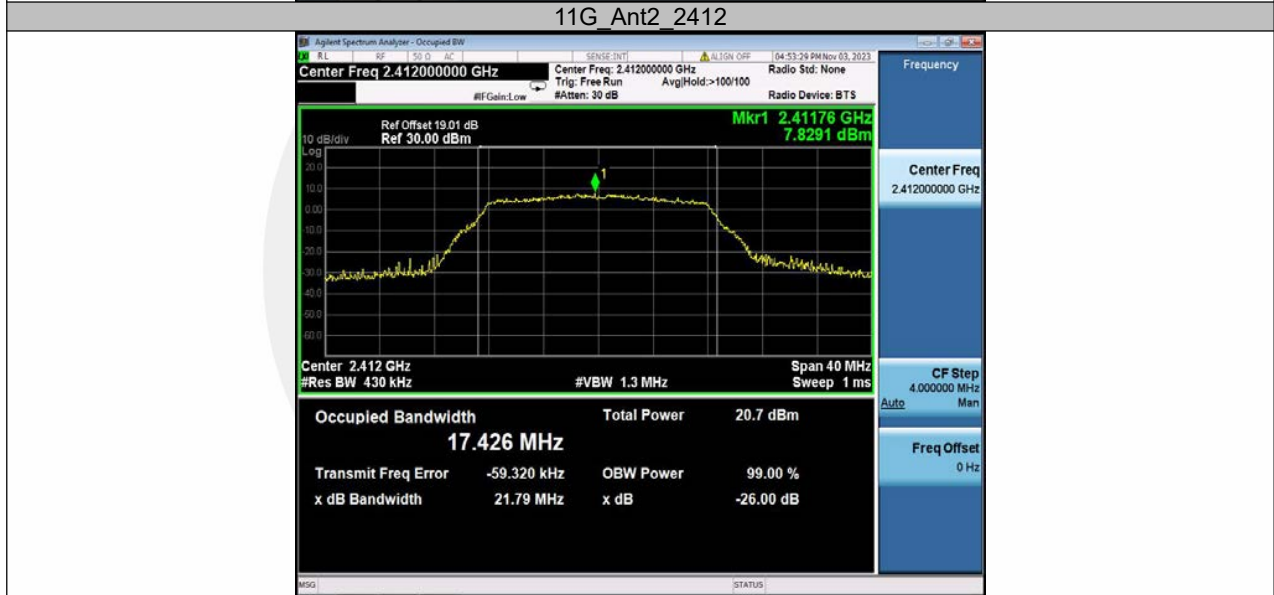
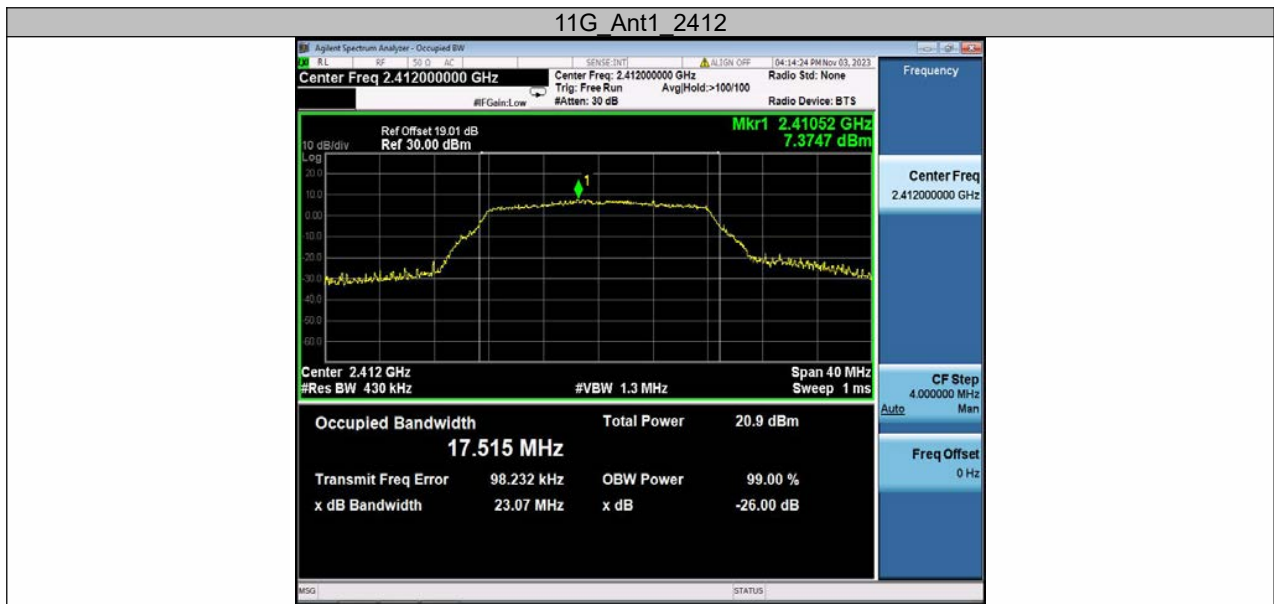



11N20MIMO_Ant1_2412

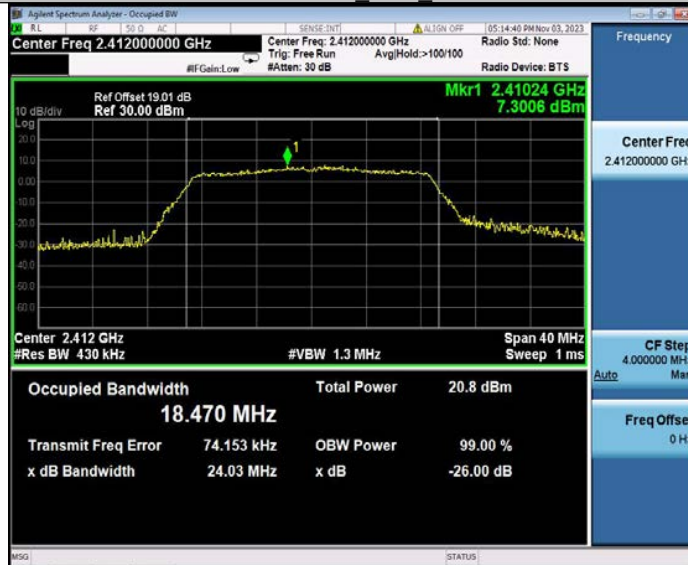

11N20MIMO_Ant2_2412



11N20MIMO_Ant1_2437

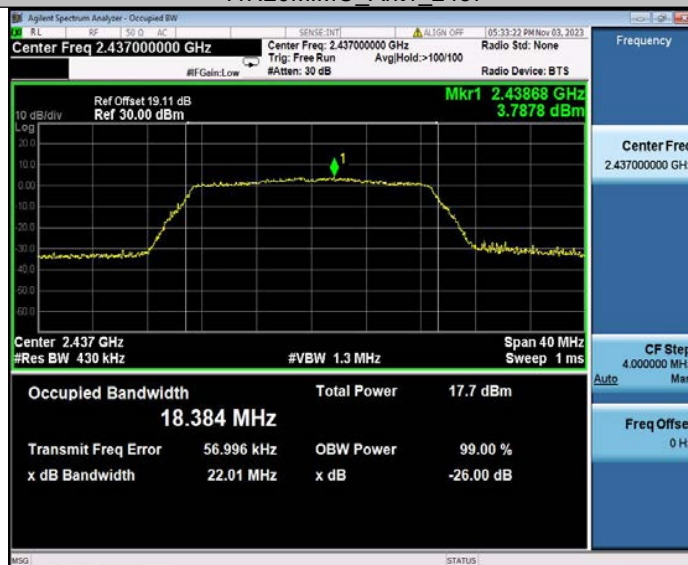

11N20MIMO_Ant2_2437



11N20MIMO_Ant1_2462



11N20MIMO_Ant2_2462



11AX20MIMO_Ant1_2412

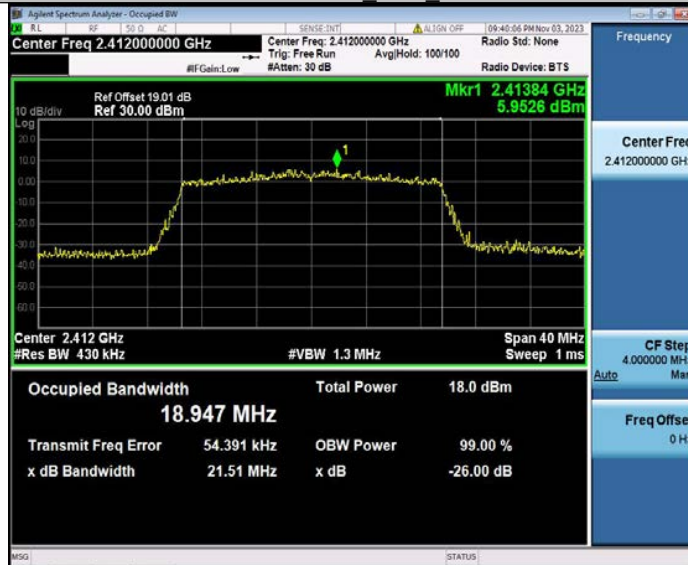

11AX20MIMO_Ant2_2412

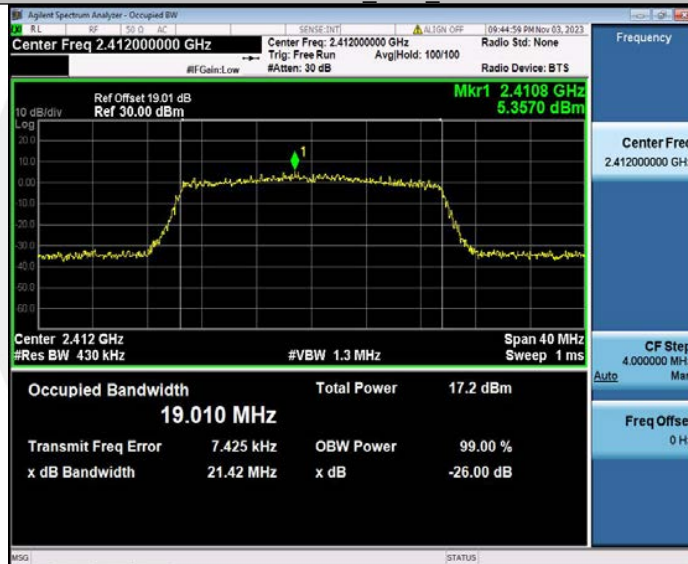

11AX20MIMO_Ant1_2437

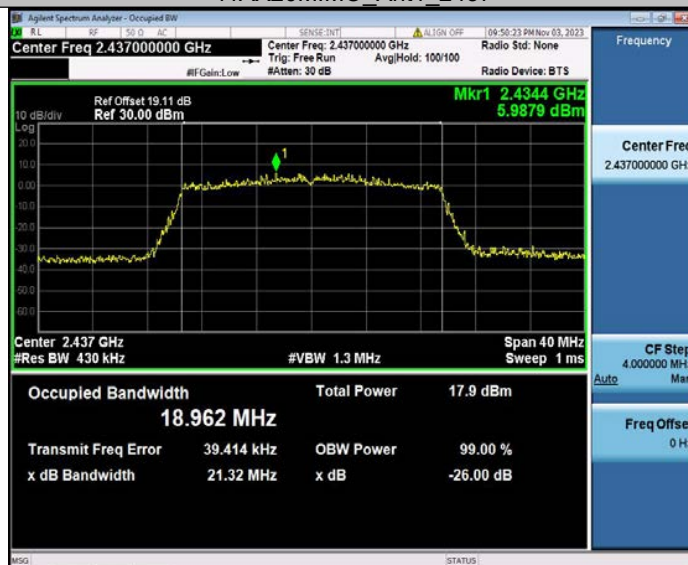

11AX20MIMO_Ant2_2437

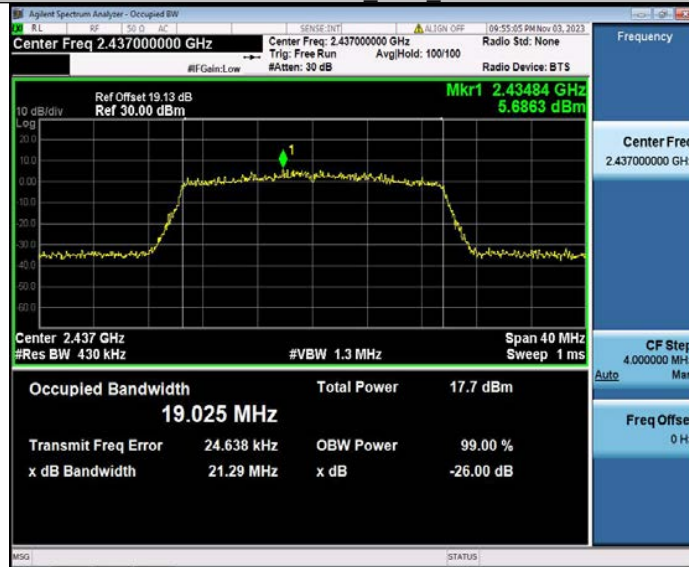

11AX20MIMO_Ant1_2462

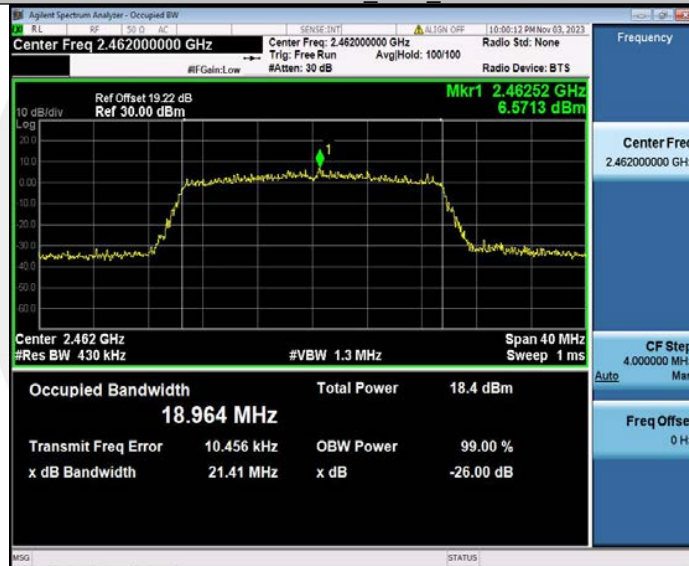

11AX20MIMO_Ant2_2462

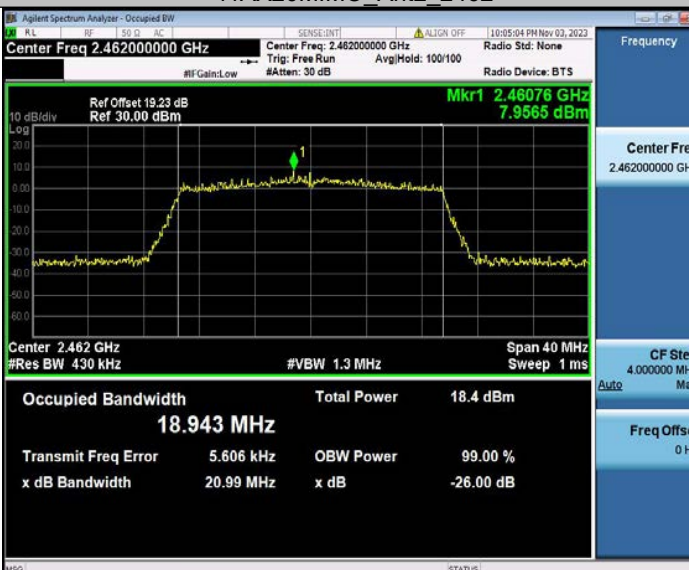

8.3 MAXIMUM PEAK CONDUCTED OUTPUT POWER

8.3.1 Applicable Standard

According to FCC Part15.247 (b)(3) and KDB 558074 D01 15.247 Meas Guidance v05r02
 According to RSS-247, 5.4(d) and RSS-Gen6.12

8.3.2 Conformance Limit

The maximum conducted output power of the intentional radiator for systems using digital modulation in the 2400 - 2483.5 MHz bands shall not exceed: 1 Watt (30dBm).

8.3.3 Test Configuration

Test according to clause 6.1 radio frequency test setup

8.3.4 Test Procedure

- a) Set span to at least 1.5 times the OBW.
- b) Set RBW = 1-5% of the OBW, not to exceed 1 MHz.
- c) Set VBW $\geq 3 \times$ RBW.
- d) Number of points in sweep $\geq 2 \times$ span / RBW. (This gives bin-to-bin spacing \leq RBW/2, so that narrowband signals are not lost between frequency bins.)
- e) Sweep time = auto.
- f) Detector = RMS (i.e., power averaging), if available. Otherwise, use sample detector mode.
- g) If transmit duty cycle < 98 %, use a sweep trigger with the level set to enable triggering only on full power pulses. The transmitter shall operate at maximum power control level for the entire duration of every sweep. If the EUT transmits continuously (i.e., with no off intervals) or at duty cycle ≥ 98 %, and if each transmission is entirely at the maximum power control level, then the trigger shall be set to “free run” .
- h) Trace average at least 100 traces in power averaging (i.e., RMS) mode.
- i) Compute power by integrating the spectrum across the OBW of the signal using the instrument’s band power measurement function, with band limits set equal to the OBW band edges. If the instrument does not have a band power function, sum the spectrum levels (in power units) at intervals equal to the RBW extending across the entire OBW of the spectrum.

■ According to FCC Part 15.247(b)(4):

Conducted output power limit specified in paragraph (b) of this section is based on the use of antennas with directional gains that do not exceed 6 dBi. If transmitting antennas of directional gain greater than 6 dBi are used, the conducted output power from the intentional radiator shall be reduced below the stated values in paragraphs (b)(3) of this section, as appropriate, by the amount in dB that the directional gain of the antenna exceeds 6 dBi.

Note: If antenna Gain exceeds 6 dBi, then Output power Limit=30-(Gain- 6)

8.3.5 Test Results

Temperature:	25 °C
Relative Humidity:	45%
ATM Pressure:	1011 mbar

Note: N/A

TestMode	Antenna	Frequency[MHz]	Transmission Duration [ms]	Transmission Period [ms]	Duty Cycle [%]	Factor
11B	Ant1	2412	19.00	19.00	100.00	0.00
	Ant2	2412	19.00	19.00	100.00	0.00
	Ant1	2437	19.00	19.00	100.00	0.00
	Ant2	2437	12.41	12.44	99.76	0.01
	Ant1	2462	17.00	17.00	100.00	0.00
	Ant2	2462	19.00	19.00	100.00	0.00
11G	Ant1	2412	2.07	2.10	98.57	0.06
	Ant2	2412	2.06	2.09	98.56	0.06
	Ant1	2437	2.06	2.09	98.56	0.06
	Ant2	2437	2.07	2.10	98.57	0.06
	Ant1	2462	2.07	2.10	98.57	0.06
	Ant2	2462	2.06	2.09	98.56	0.06
11N20MIMO	Ant1	2412	1.92	1.94	98.97	0.04
	Ant2	2412	1.92	1.94	98.97	0.04
	Ant1	2437	1.91	1.93	98.96	0.05
	Ant2	2437	1.92	1.94	98.97	0.04
	Ant1	2462	1.92	1.93	99.48	0.02
	Ant2	2462	1.92	1.94	98.97	0.04
11AX20MIMO	Ant1	2412	1.49	1.51	98.68	0.06
	Ant2	2412	1.48	1.50	98.67	0.06
	Ant1	2437	1.48	1.50	98.67	0.06
	Ant2	2437	1.49	1.51	98.68	0.06
	Ant1	2462	1.49	1.51	98.68	0.06
	Ant2	2462	1.49	1.51	98.68	0.06

11B_Ant1_2412

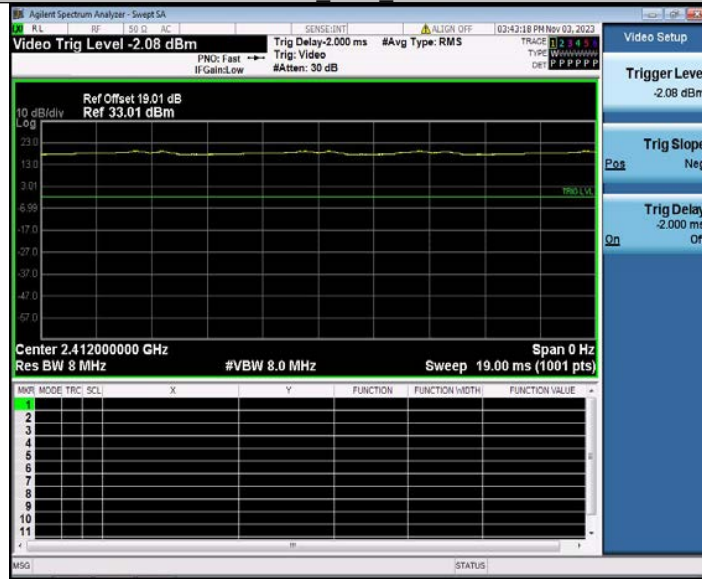

11B_Ant2_2412

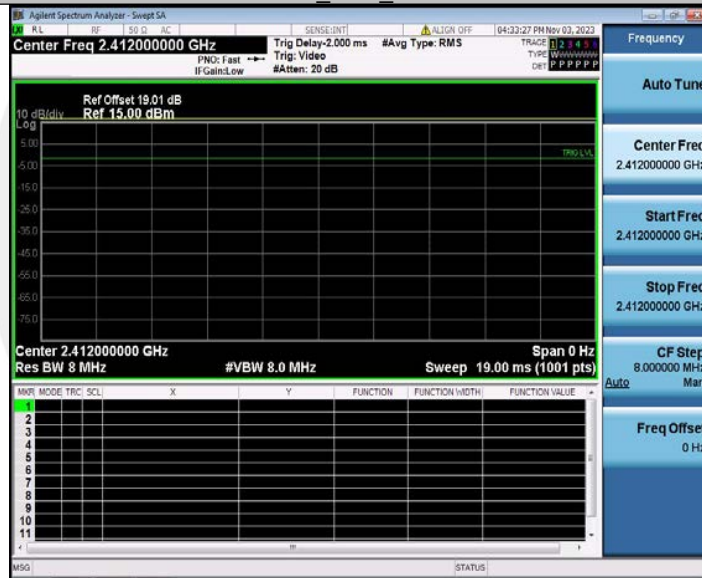

11B_Ant1_2437

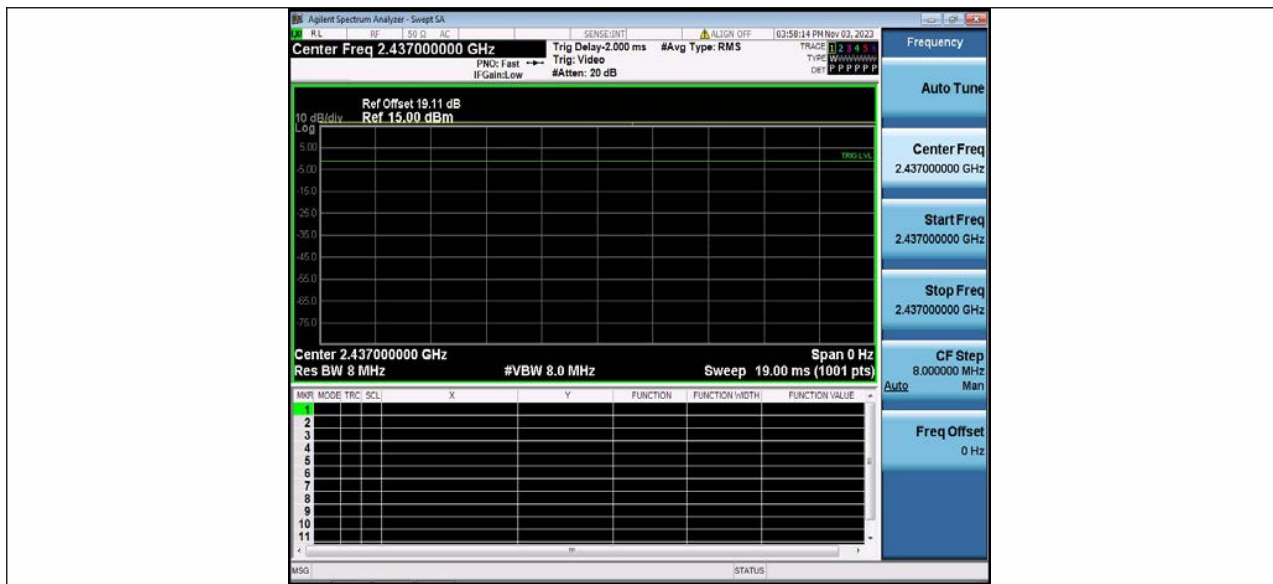

11B_Ant2_2437

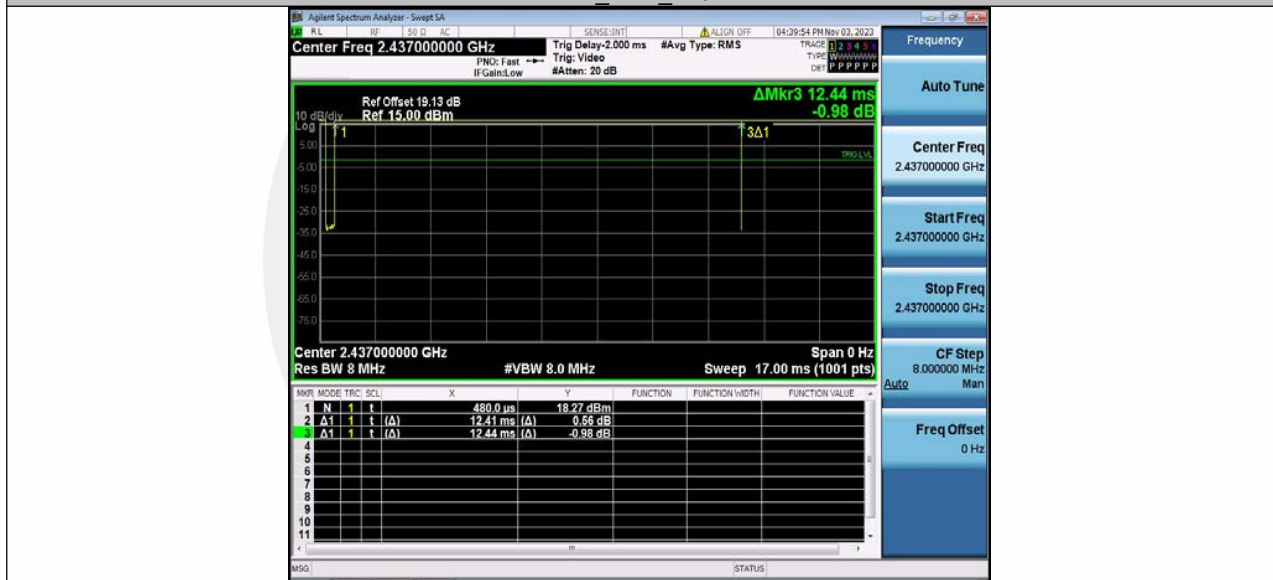

11B_Ant1_2462

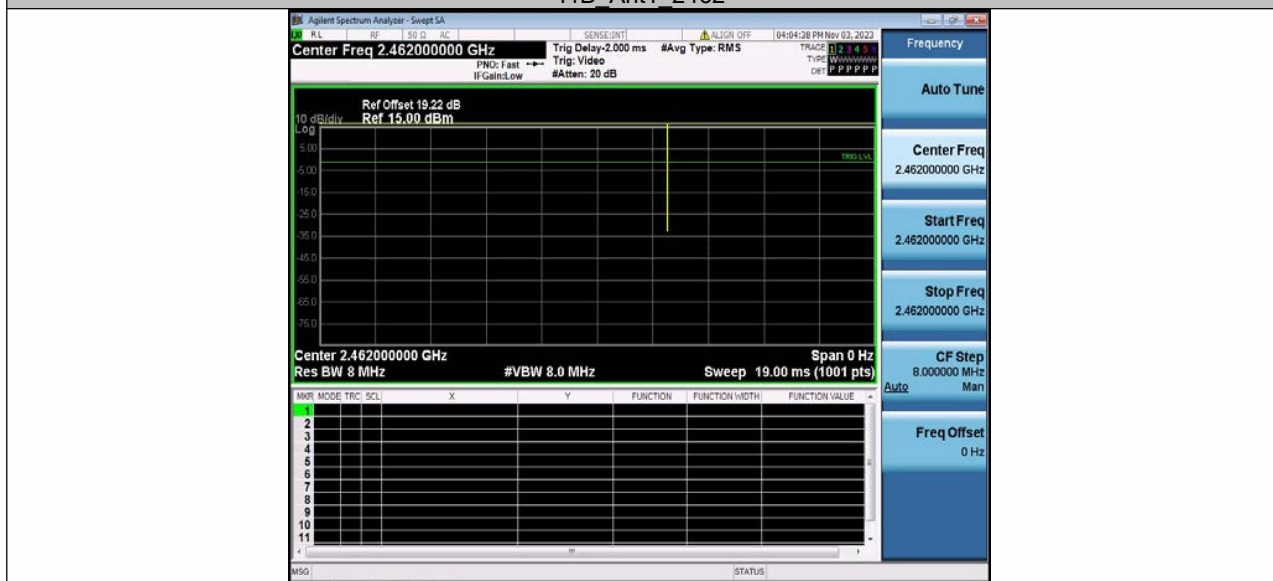

11B_Ant2_2462

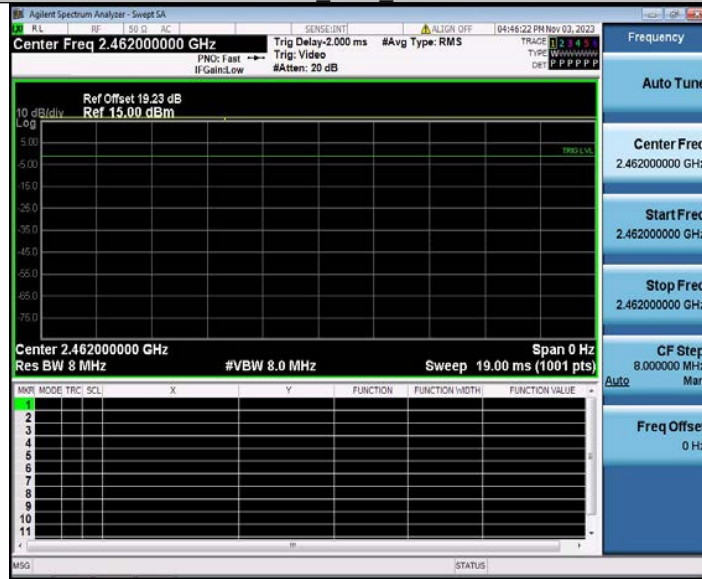

11G_Ant1_2412

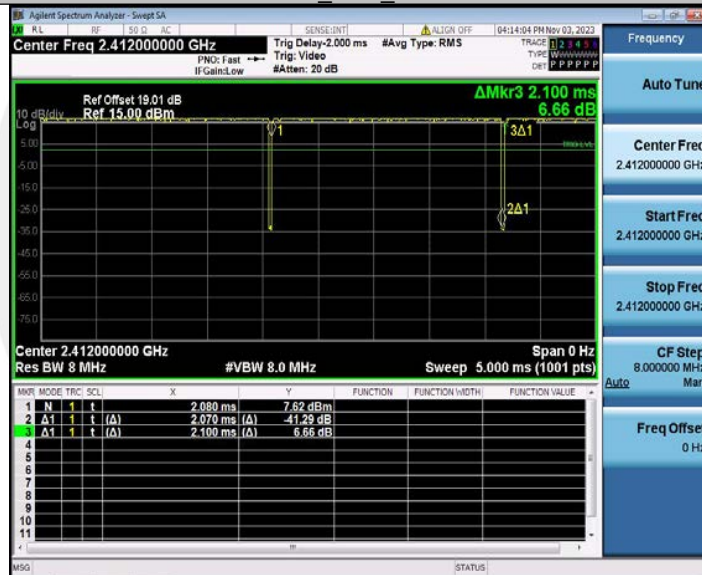

11G_Ant2_2412

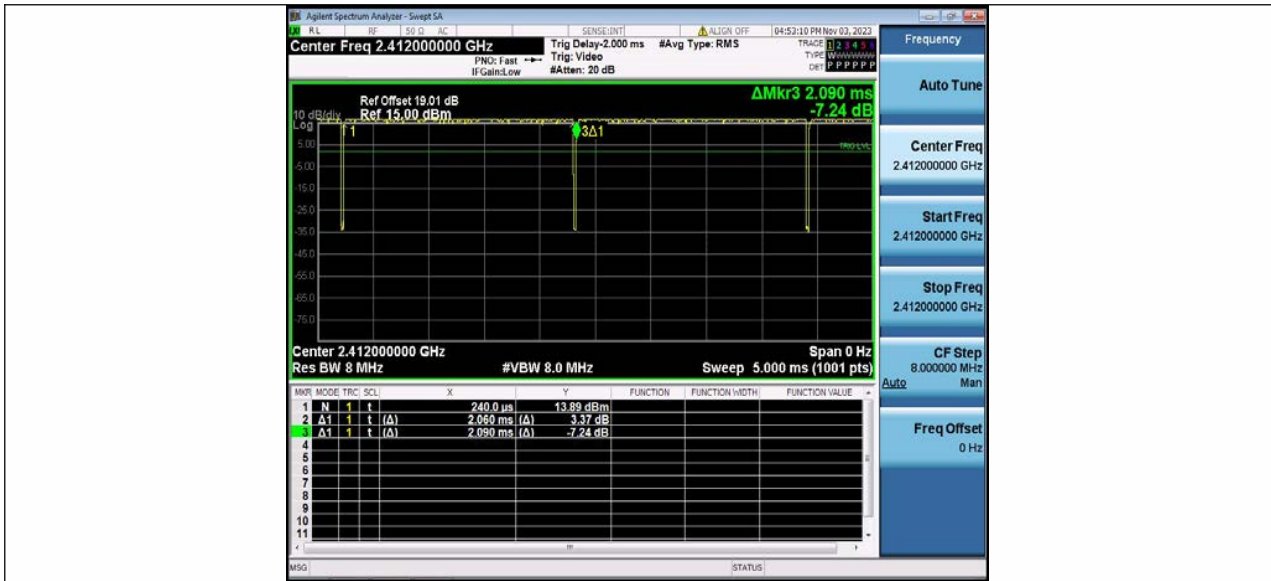

11G Ant1 2437

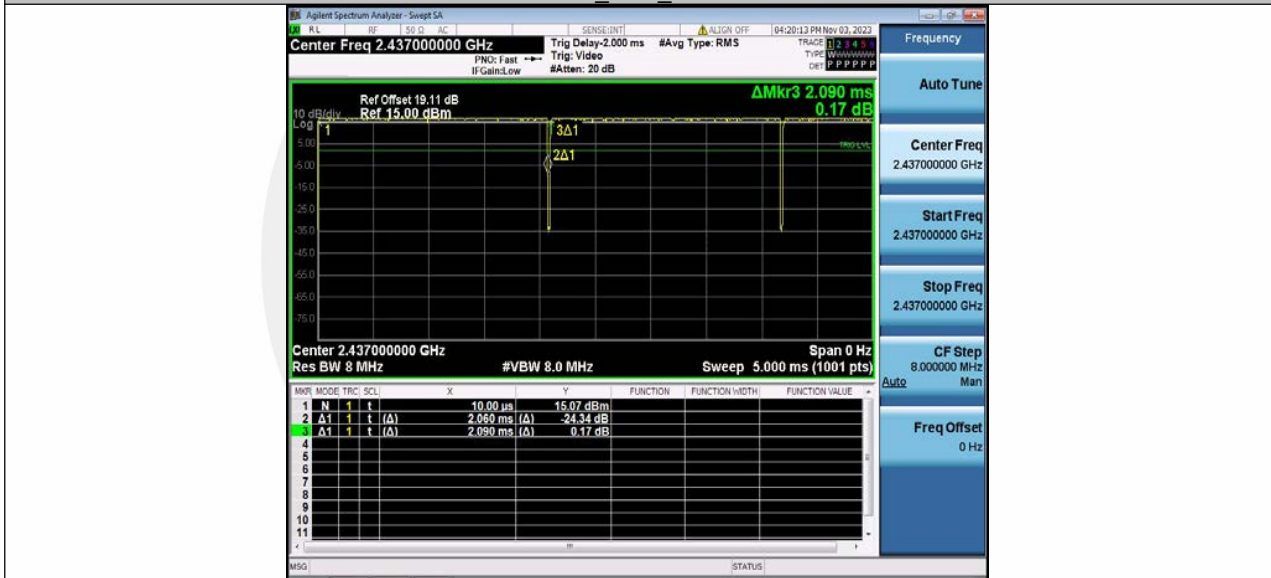

11G Ant2 2437

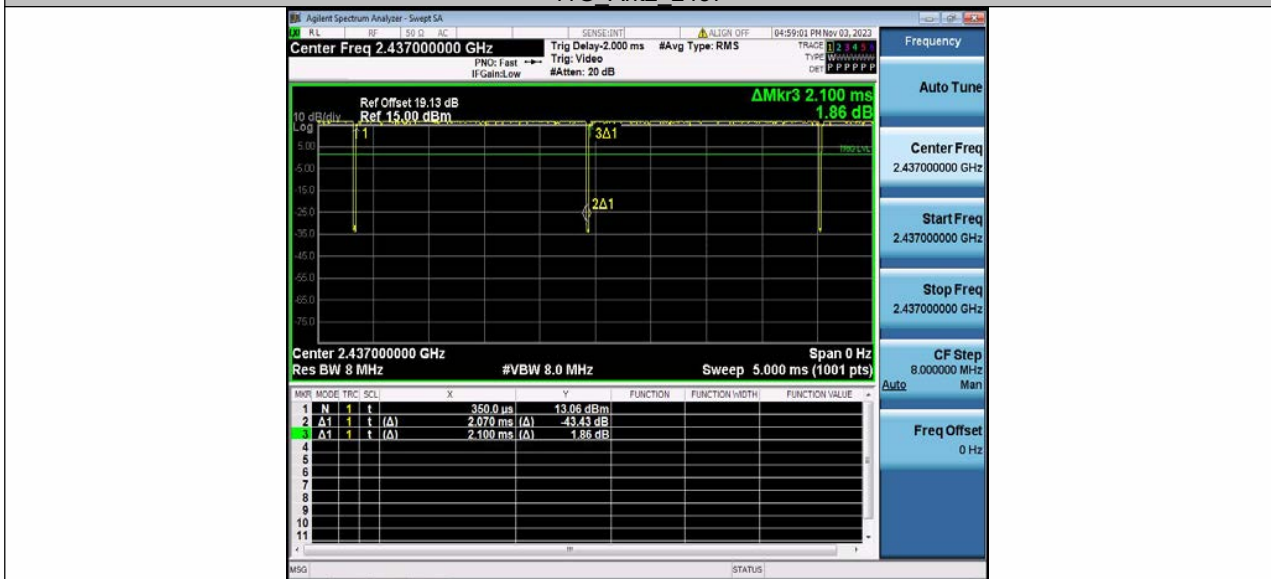

11G Ant1_2462

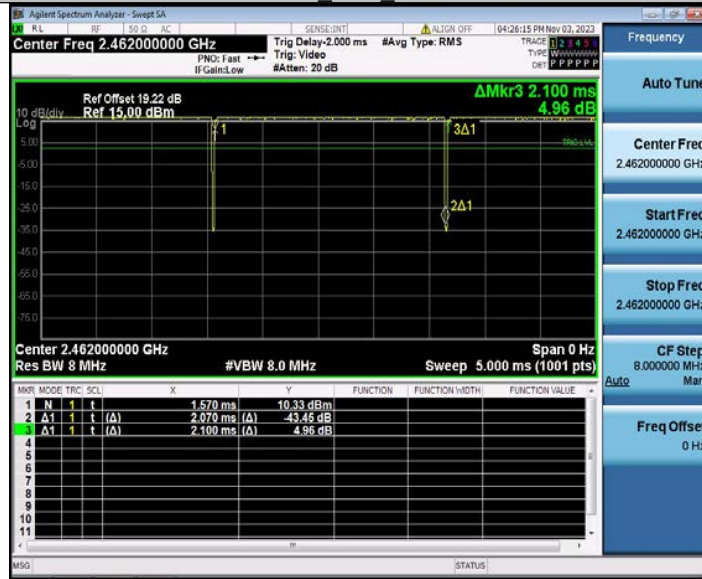

11G Ant2_2462

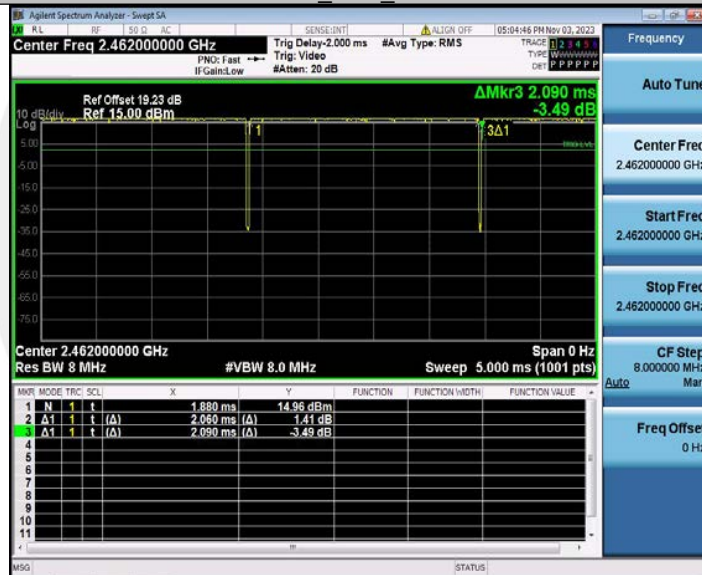

11N20MIMO Ant1_2412

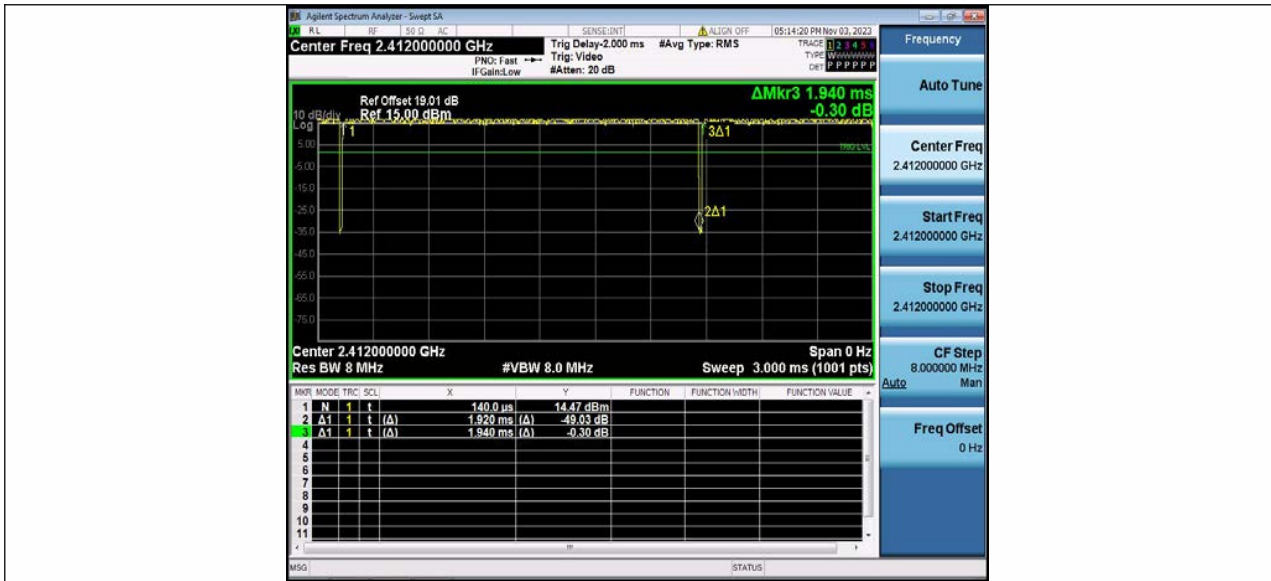

11N20MIMO_Ant2_2412

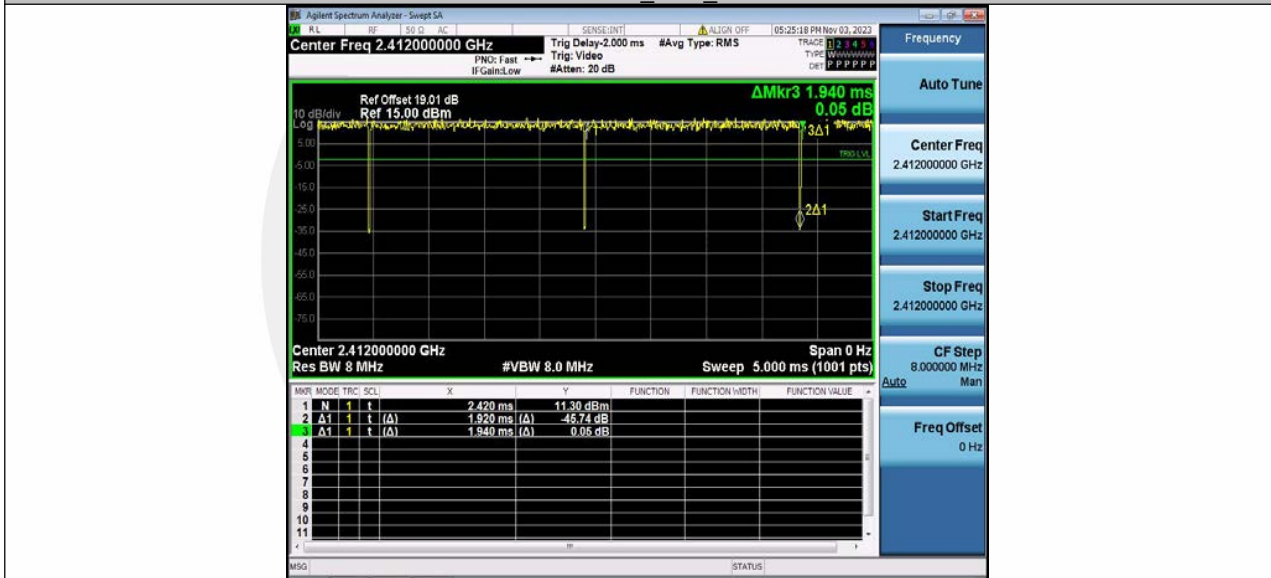

11N20MIMO_Ant1_2437

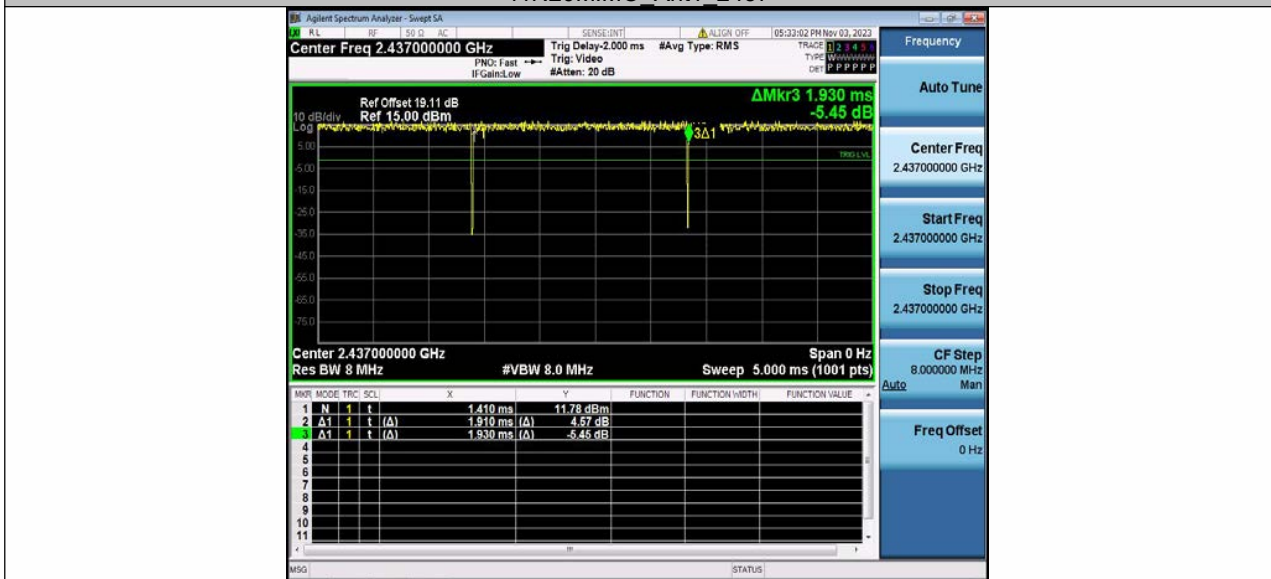

11N20MIMO_Ant2_2437

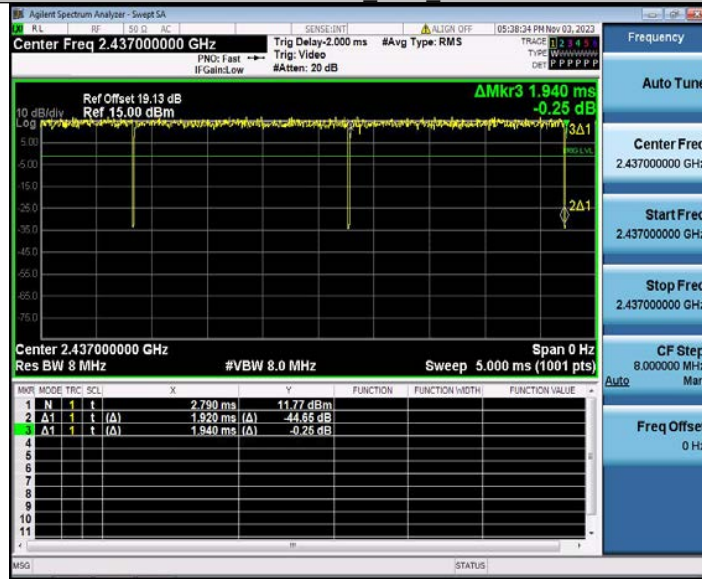

11N20MIMO_Ant1_2462

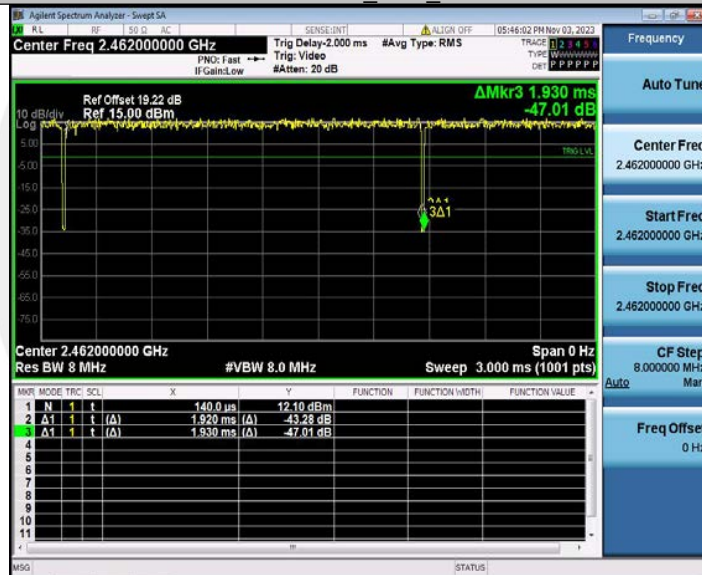

11N20MIMO_Ant2_2462

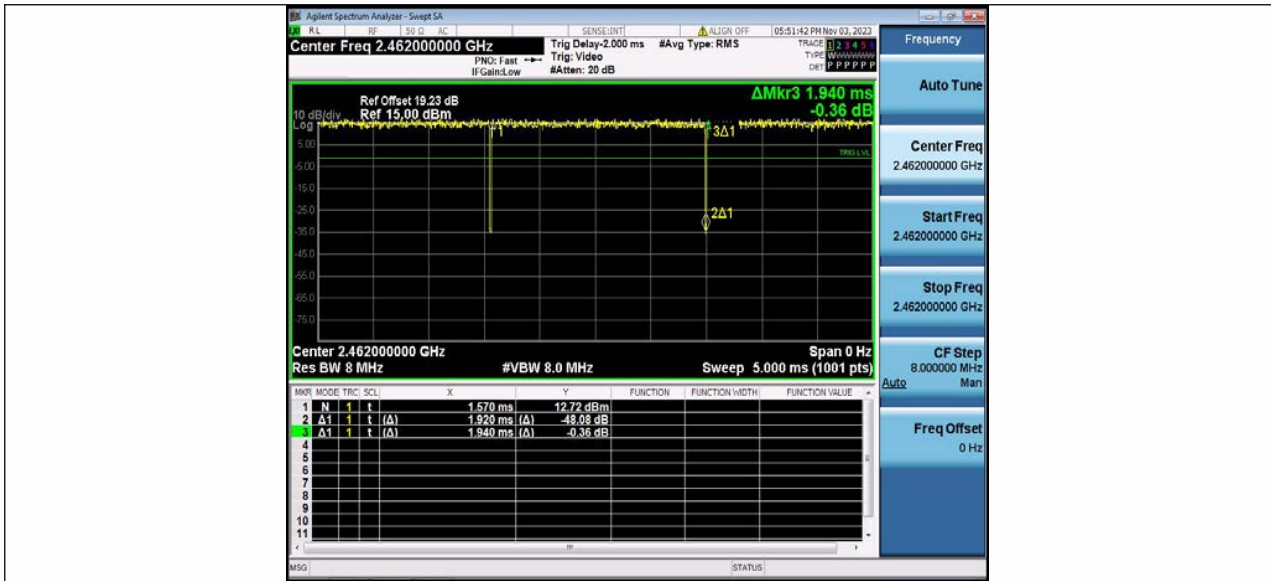

11AX20MIMO Ant1 2412

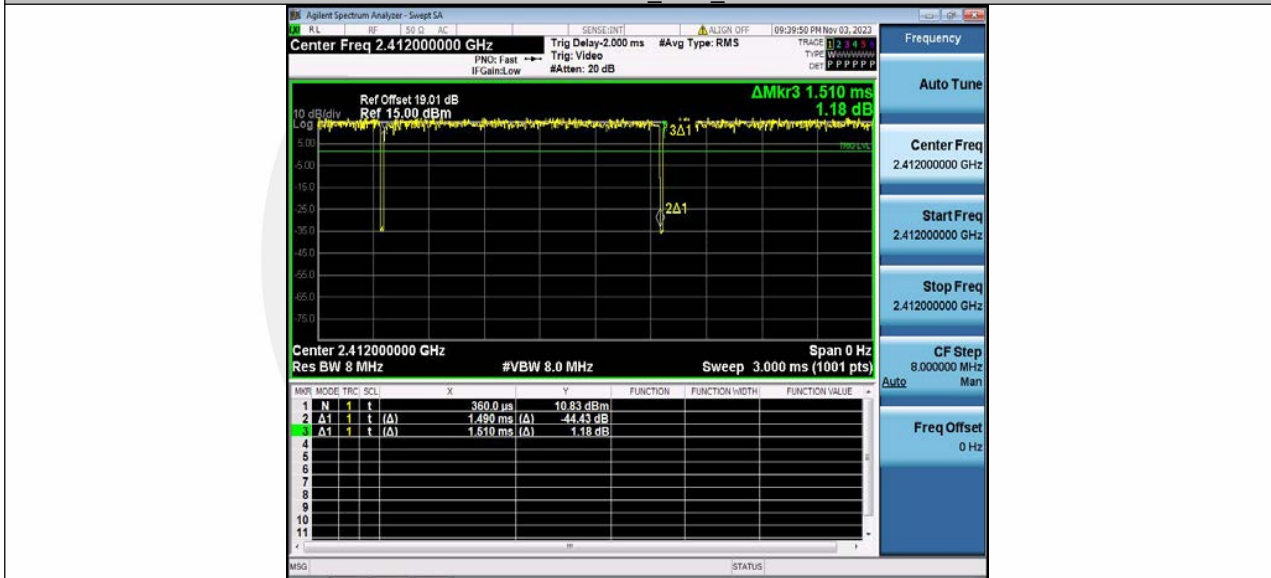

11AX20MIMO Ant2 2412

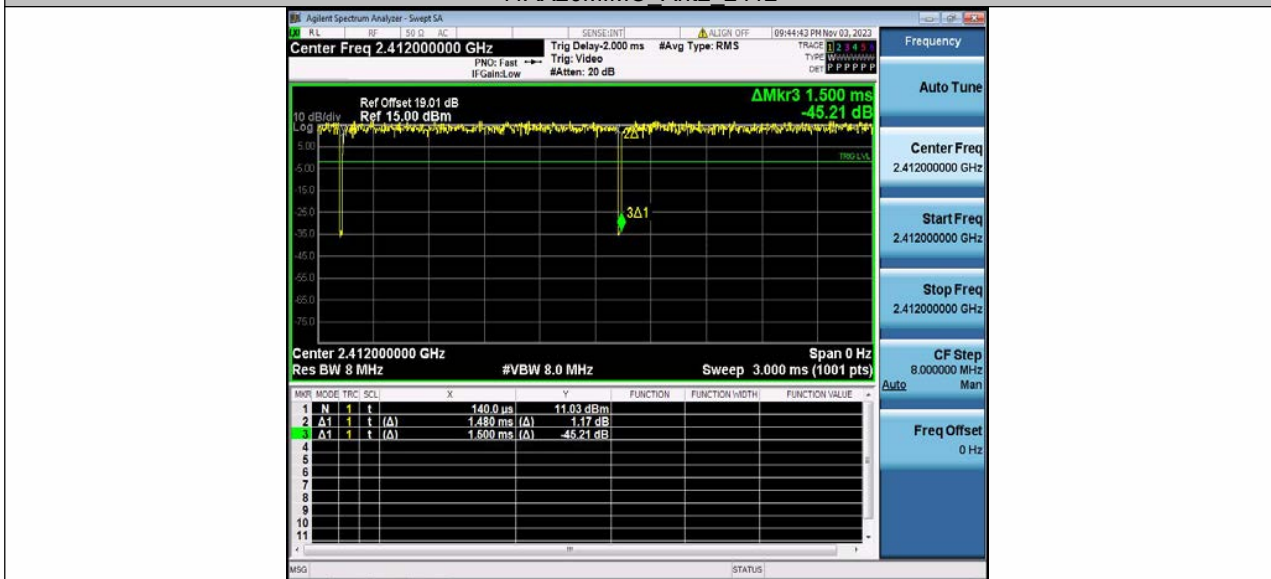

11AX20MIMO_Ant1_2437

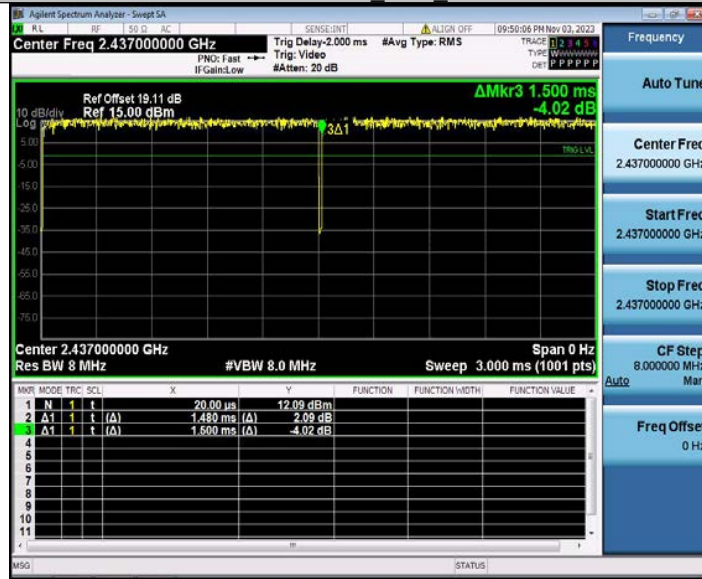

11AX20MIMO_Ant2_2437

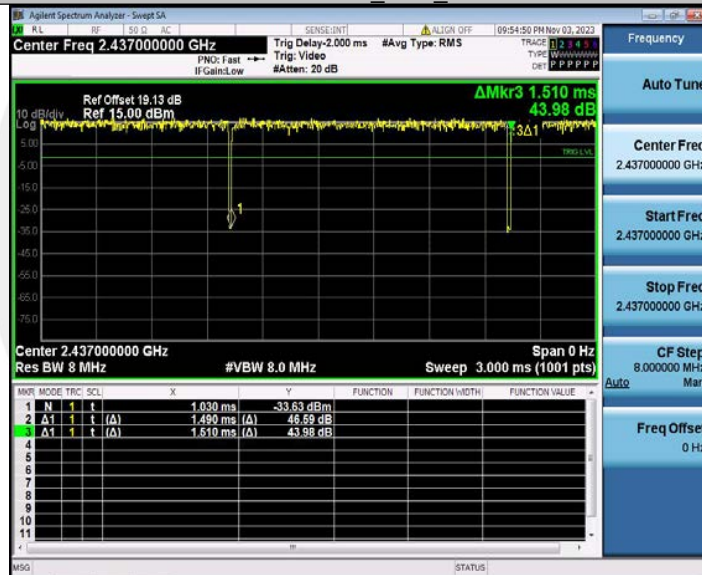

11AX20MIMO_Ant1_2462

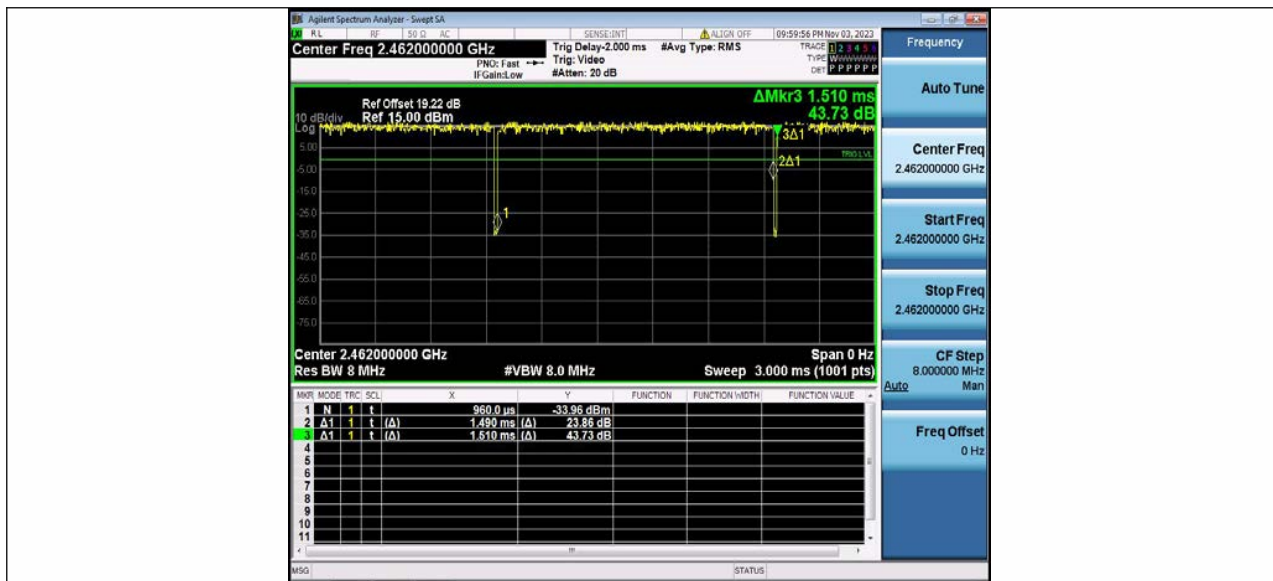

11AX20MIMO_Ant2_2462

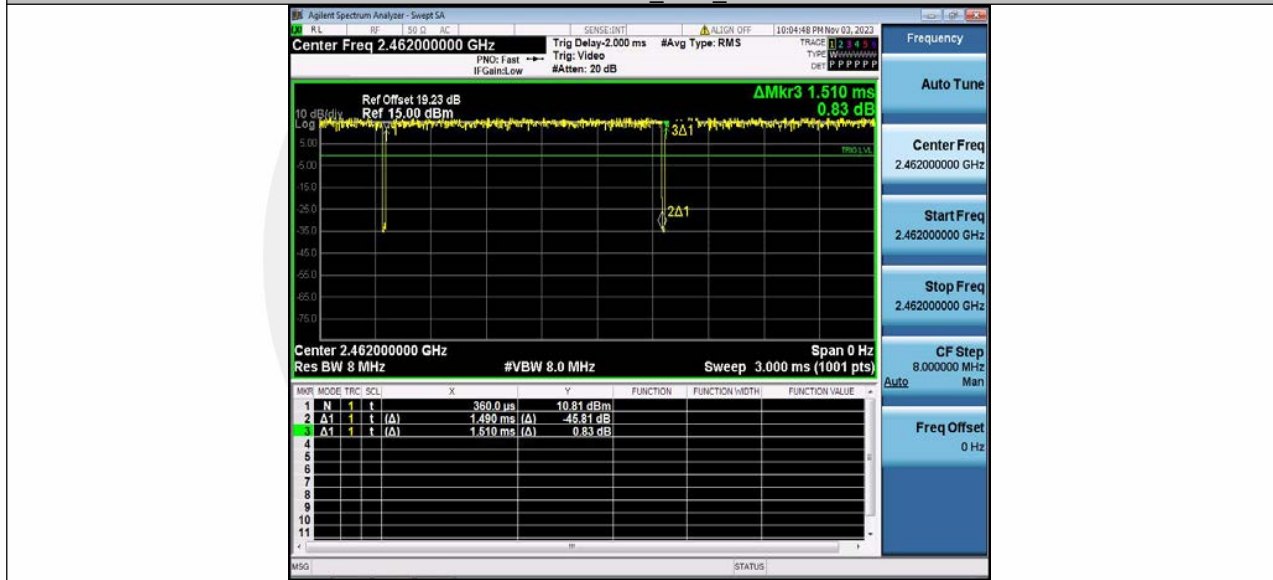

TestMode	Antenna	Frequency[MHz]	Average Power[dBm]	Conducted Limit[dBm]	Verdict
11B	Ant1	2412	14.48	≤30.00	PASS
	Ant2	2412	13.90	≤30.00	PASS
	Ant1	2437	14.73	≤30.00	PASS
	Ant2	2437	14.22	≤30.00	PASS
	Ant1	2462	15.17	≤30.00	PASS
	Ant2	2462	14.64	≤30.00	PASS
11G	Ant1	2412	13.65	≤30.00	PASS
	Ant2	2412	13.50	≤30.00	PASS
	Ant1	2437	13.70	≤30.00	PASS
	Ant2	2437	13.61	≤30.00	PASS
	Ant1	2462	13.98	≤30.00	PASS
	Ant2	2462	13.84	≤30.00	PASS
11N20MIMO	Ant1	2412	10.43	≤30.00	PASS
	Ant2	2412	9.91	≤30.00	PASS
	total	2412	13.19	≤30.00	PASS
	Ant1	2437	10.44	≤30.00	PASS
	Ant2	2437	10.24	≤30.00	PASS
	total	2437	13.35	≤30.00	PASS
	Ant1	2462	10.74	≤30.00	PASS
	Ant2	2462	10.74	≤30.00	PASS
	total	2462	13.75	≤30.00	PASS
11AX20MIMO	Ant1	2412	10.77	≤30.00	PASS
	Ant2	2412	10.16	≤30.00	PASS
	total	2412	13.49	≤30.00	PASS
	Ant1	2437	10.75	≤30.00	PASS
	Ant2	2437	10.55	≤30.00	PASS
	total	2437	13.66	≤30.00	PASS
	Ant1	2462	11.10	≤30.00	PASS
	Ant2	2462	11.05	≤30.00	PASS
	total	2462	14.09	≤30.00	PASS

11B_Ant1_2412

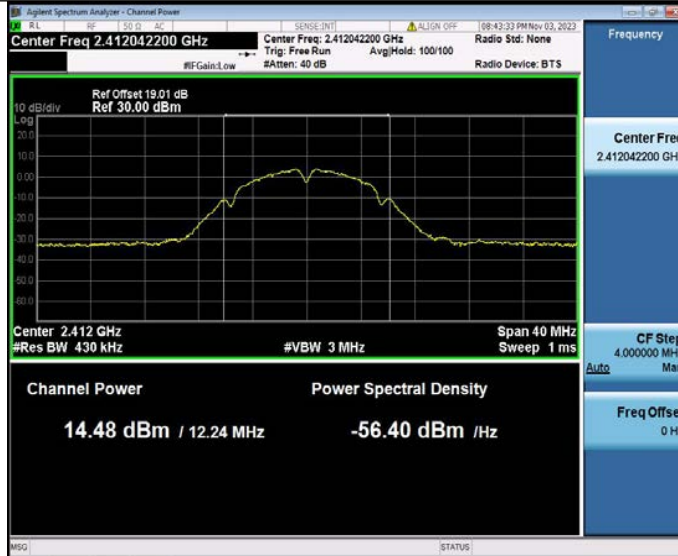

11B_Ant2_2412

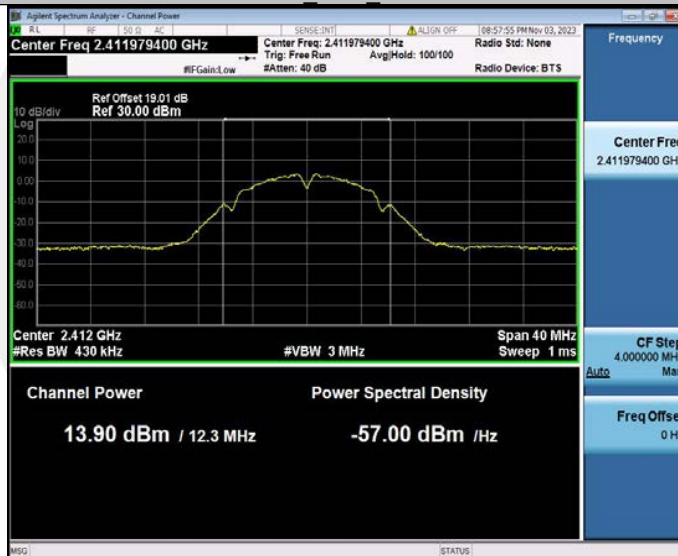

11B_Ant1_2437

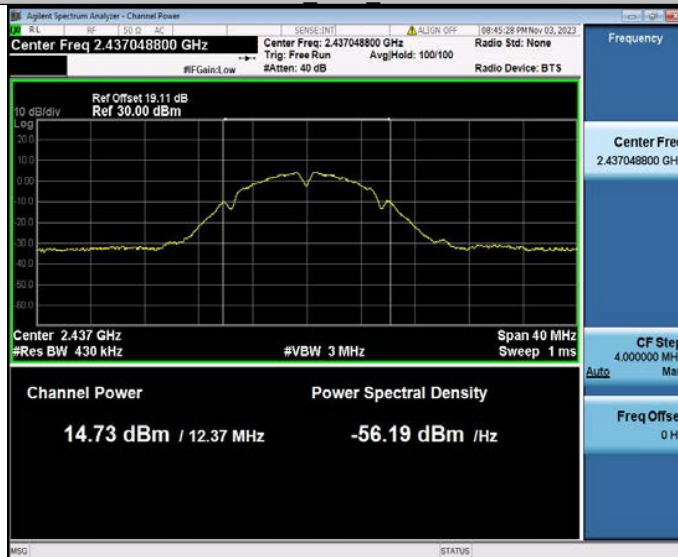

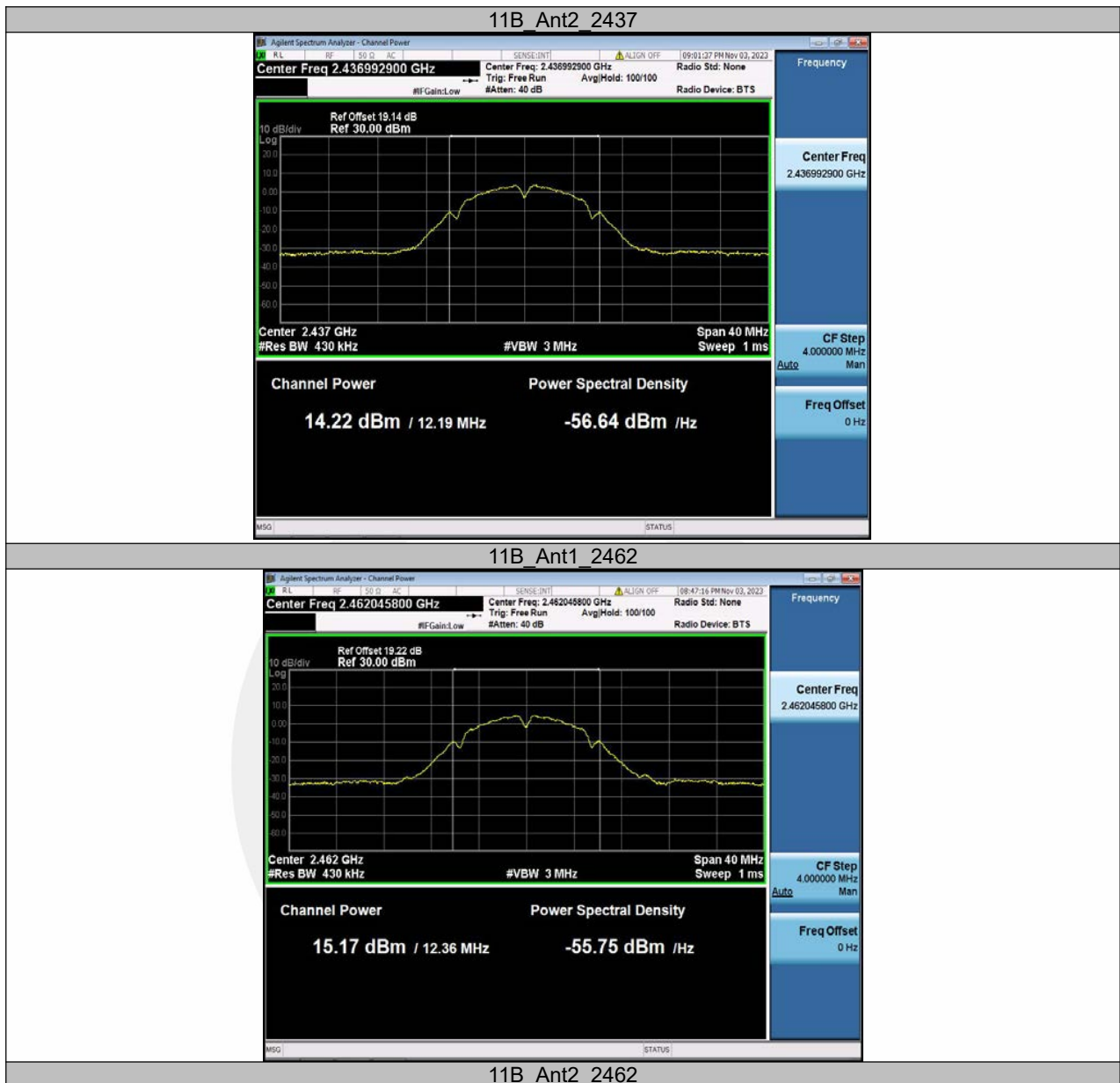

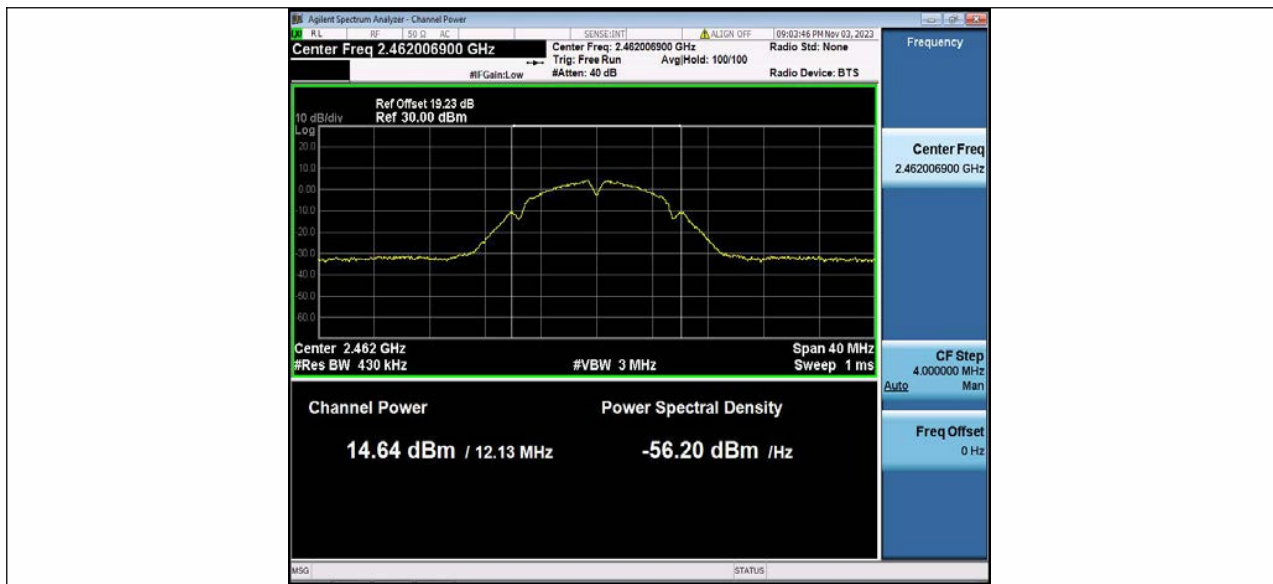

11G Ant1_2412

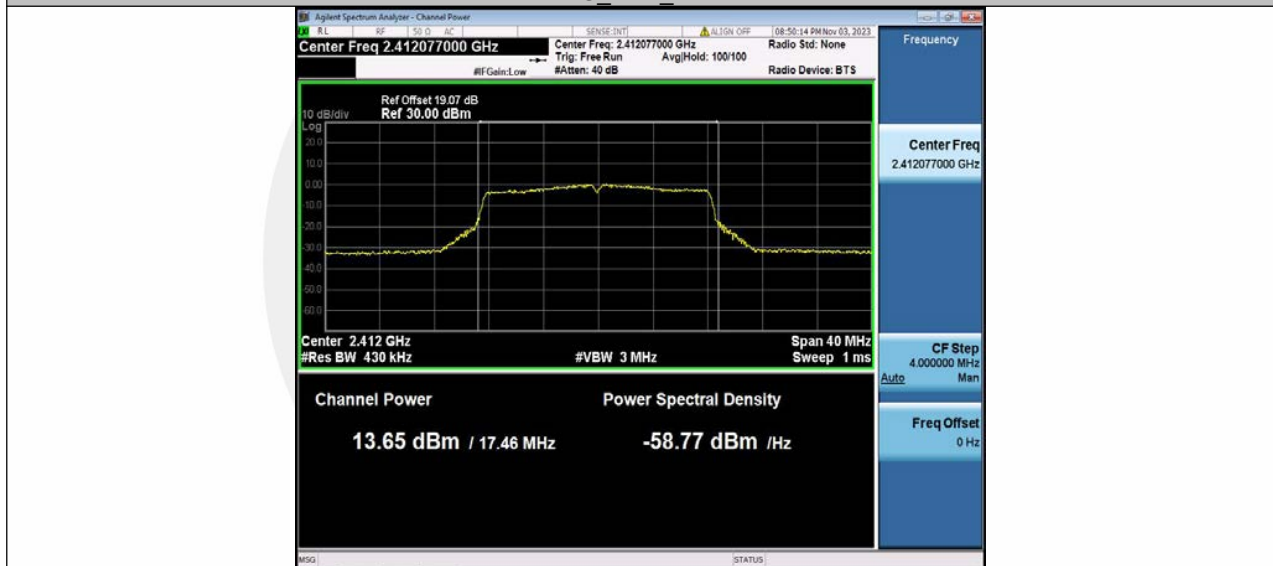

11G Ant2_2412



11G Ant1_2437

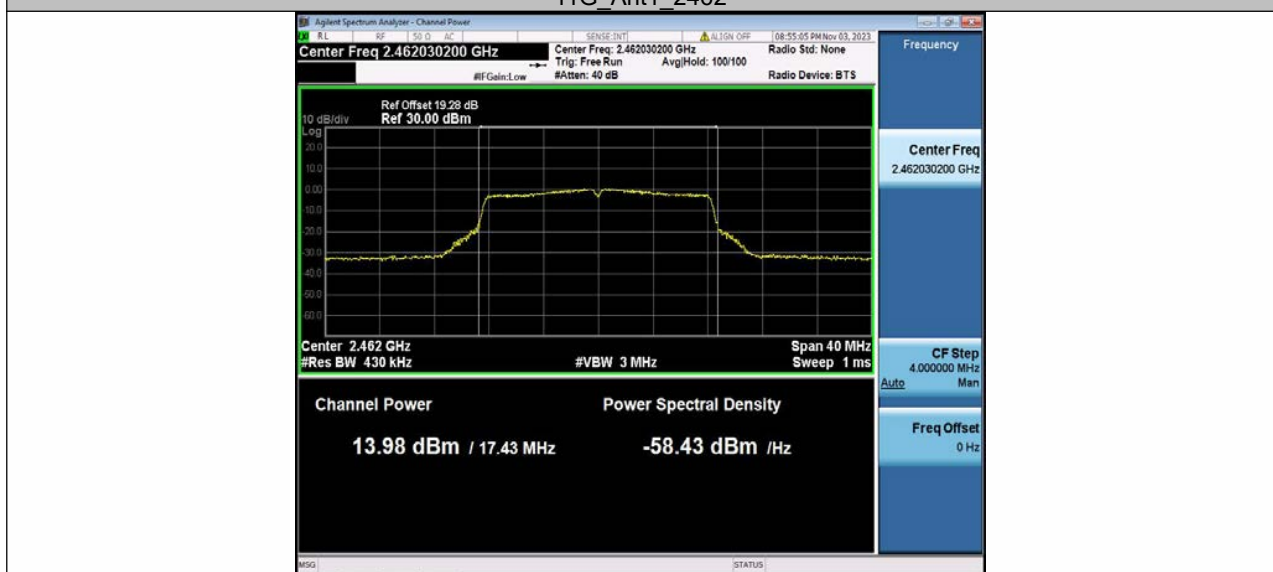

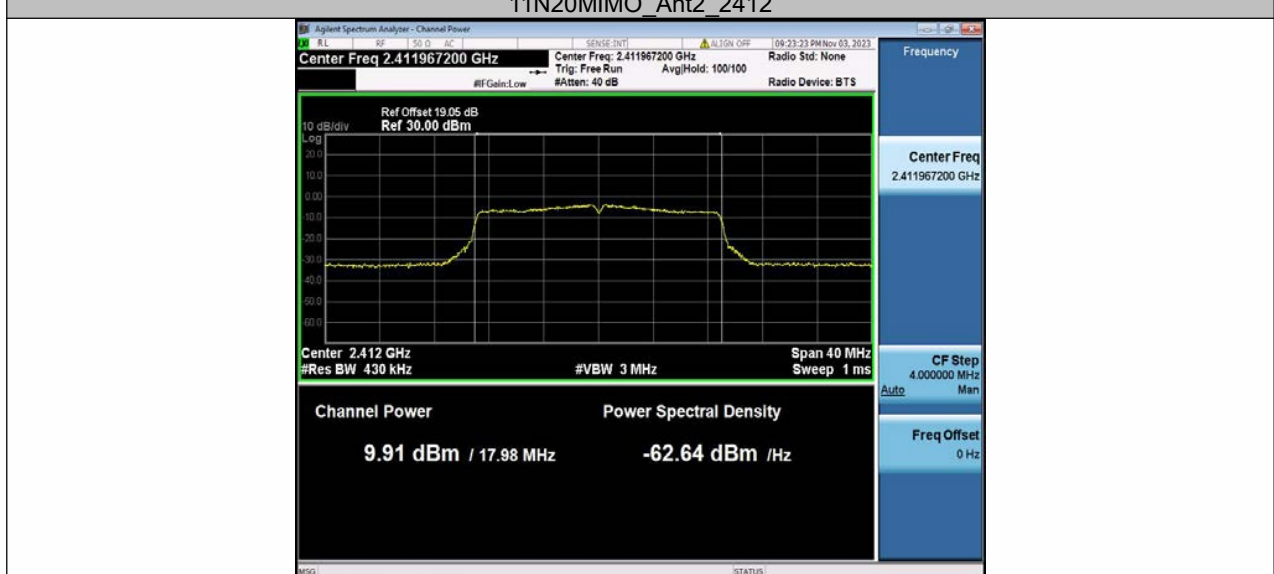
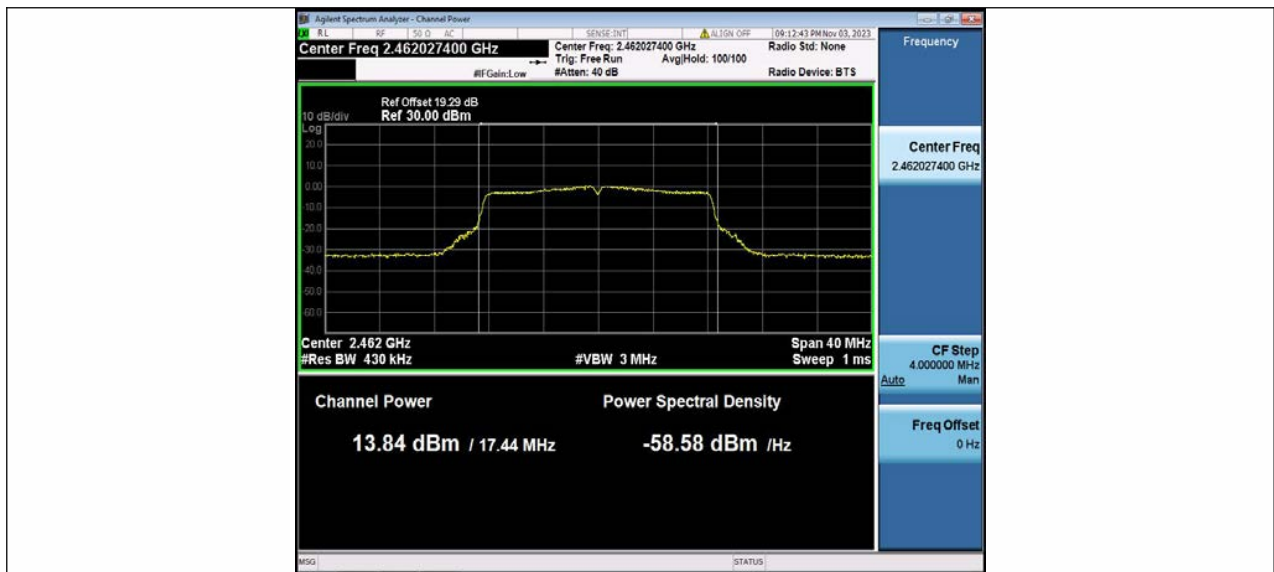

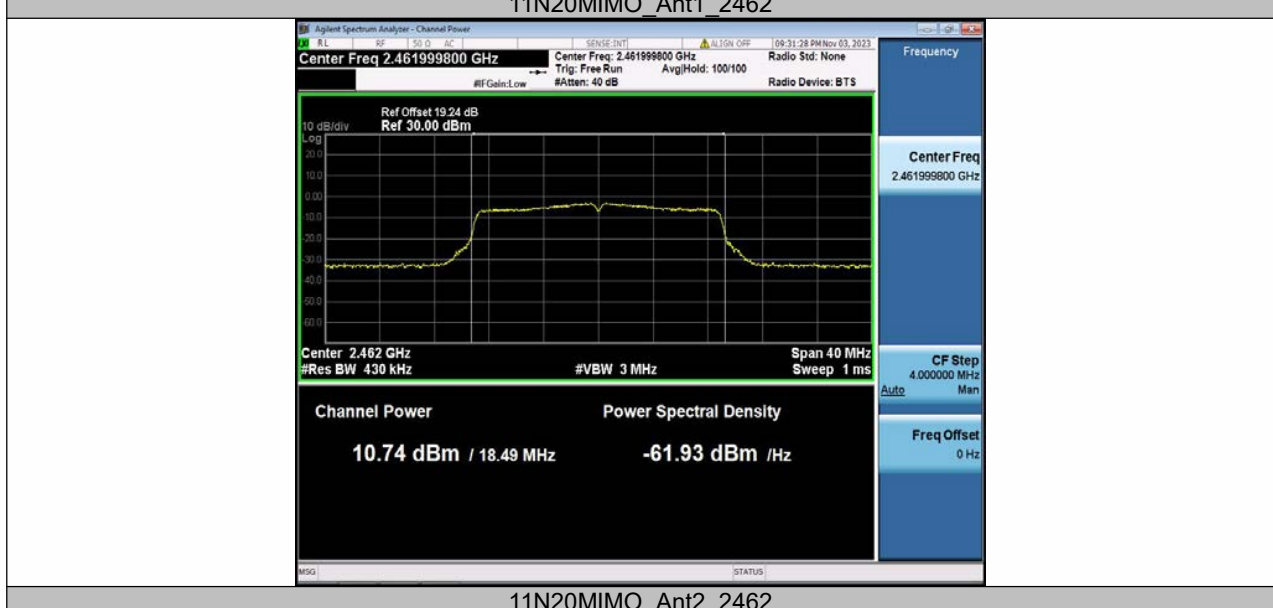
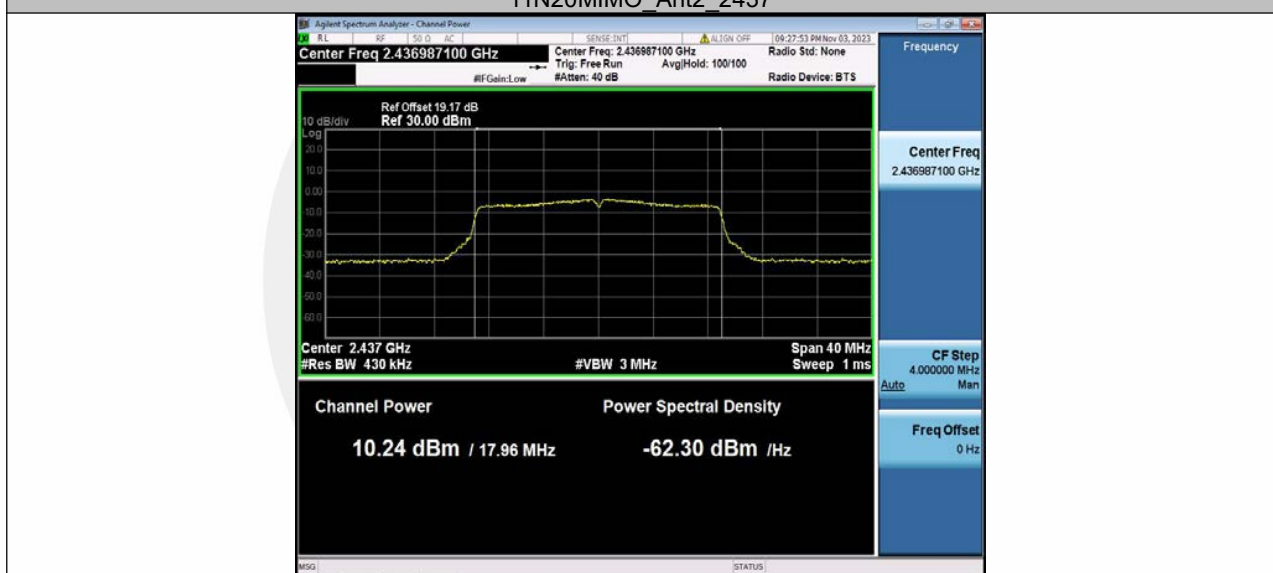

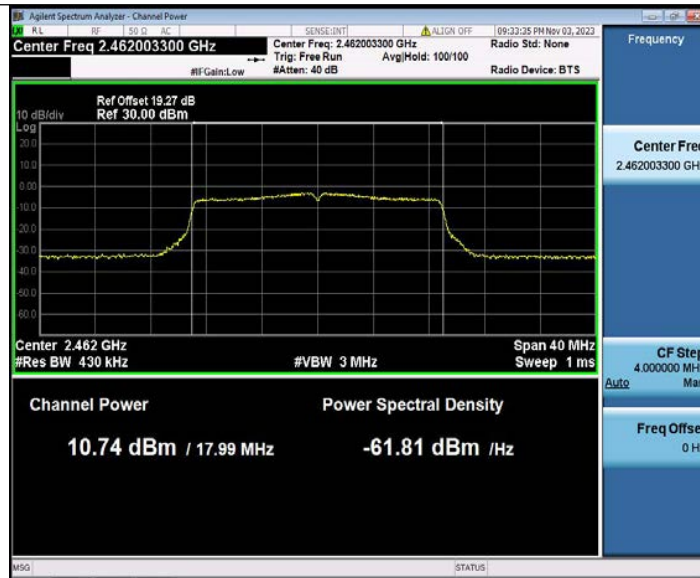

11AX20MIMO_Ant1_2412



11AX20MIMO_Ant2_2412

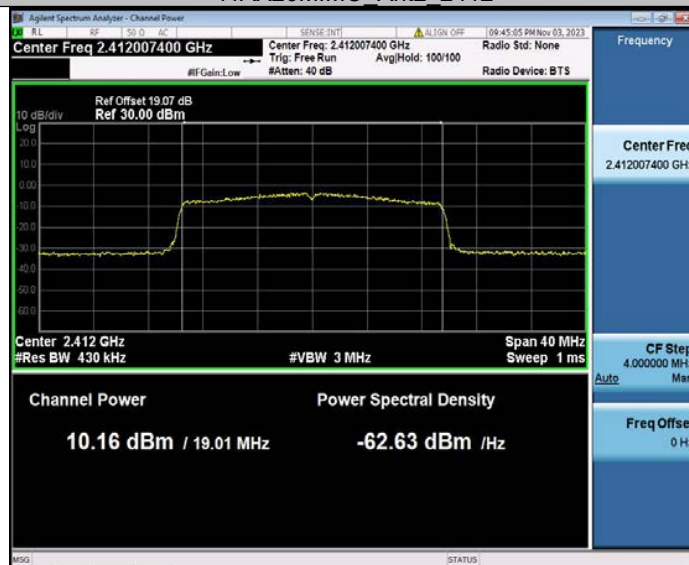

11AX20MIMO_Ant1_2437



11AX20MIMO_Ant2_2437



11AX20MIMO_Ant1_2462



11AX20MIMO_Ant2_2462



8.4 MAXIMUM POWER SPECTRAL DENSITY

8.4.1 Applicable Standard

According to FCC Part15.247(e) and KDB 558074 D01 15.247 Meas Guidance v05r02

According to RSS-247, 5.2(b) and RSS-Gen6.12

8.4.2 Conformance Limit

The transmitter power spectral density conducted from the transmitter to the antenna shall not be greater than 8 dBm in any 3 kHz band during any time interval of continuous transmission. This power spectral density shall be determined in accordance with the provisions of section 5.4(d), (i.e. the power spectral density shall be determined using the same method as is used to determine the conducted output power).

8.4.3 Test Configuration

Test according to clause 6.1 radio frequency test setup

8.4.4 Test Procedure

This procedure shall be used if maximum peak conducted output power was used to demonstrate compliance

The transmitter output (antenna port) was connected to the spectrum analyzer

Set analyzer center frequency to DTS channel center frequency.

Set the span to 1.5 times the DTS bandwidth.

Set the RBW to: 3 kHz

Set the VBW to: 10 kHz.

Set Detector = peak.

Set Sweep time = auto couple.

Set Trace mode = max hold.

Allow trace to fully stabilize.

Use the peak marker function to determine the maximum amplitude level within the RBW.

8.4.5 Test Results

Temperature:	25 °C
Relative Humidity:	45%
ATM Pressure:	1011 mbar

Note: N/A

TestMode	Antenna	Frequency[MHz]	Result[dBm/3-100kHz]	Limit[dBm/3kHz]	Verdict
11B	Ant1	2412	-15.05	≤8.00	PASS
	Ant2	2412	-15.22	≤8.00	PASS
	Ant1	2437	-14.73	≤8.00	PASS
	Ant2	2437	-15.46	≤8.00	PASS
	Ant1	2462	-14.42	≤8.00	PASS
	Ant2	2462	-14.68	≤8.00	PASS
11G	Ant1	2412	-17.79	≤8.00	PASS
	Ant2	2412	-18.43	≤8.00	PASS
	Ant1	2437	-17.94	≤8.00	PASS
	Ant2	2437	-18.16	≤8.00	PASS
	Ant1	2462	-17.62	≤8.00	PASS
	Ant2	2462	-18.15	≤8.00	PASS
11N20MIMO	Ant1	2412	-21.37	≤8.00	PASS
	Ant2	2412	-21.47	≤8.00	PASS
	total	2412	-18.41	≤8.00	PASS
	Ant1	2437	-22.08	≤8.00	PASS
	Ant2	2437	-21.76	≤8.00	PASS
	total	2437	-18.91	≤8.00	PASS
	Ant1	2462	-21.28	≤8.00	PASS
	Ant2	2462	-21.04	≤8.00	PASS
total	2462	-18.15	≤8.00	PASS	
11AX20MIMO	Ant1	2412	-21.54	≤8.00	PASS
	Ant2	2412	-22.13	≤8.00	PASS
	total	2412	-18.81	≤8.00	PASS
	Ant1	2437	-21.84	≤8.00	PASS
	Ant2	2437	-21.98	≤8.00	PASS
	total	2437	-18.90	≤8.00	PASS
	Ant1	2462	-21.89	≤8.00	PASS
	Ant2	2462	-21.70	≤8.00	PASS
total	2462	-18.78	≤8.00	PASS	

11B_Ant1_2412



11B_Ant2_2412



11B_Ant1_2437

