



东莞市一佳电子通讯科技有限公司

Dongguan YiJia Electronics Communication Technology Co.,Ltd.

规格承认书

SPECIFICATION FOR APPROVAL

日期 Date	2020/12/11
编号 File No	20121101
版本 Revision	1.0

客 户 成都万创
CUSTOMER: _____

客户料号
CUSTOMER NO: _____

品 名 2.4/5.8G Antenna
PART NAME: _____

供方料号 YJS01.042.011.102A
SUPPLIER NO: _____

送样日期Date: 送样数量Q “TY: _____

客户确认CUSTOMER APPROVED BY		
APPROVAL	CHIEF	SUPERVISOR

供方确认 SUPPLIER SIGNATURE		
APPROVAL	CHECK	DESIGN
ChenGuoqiang	WenXue	ChenXingcheng

YJ-RD-F04-A

add: 东莞市长安镇沙头社区木鱼路59号元富工业区 Tel:0769-82586086 Fax:0769-82586086

Remark:The device only support 2.4G WiFi



承认书项目表

NO	内容 (Contents)	页数 (Number of Page)	页码 (Page Code)
1	承认书封面 (Spec Cover)	1	1
2	承认书项目表 (Spec Item)	1	2
3	工程成品图 (Drawing)	1	3
4	天线规格 (Antenna Specification)	1	4
5	S参数测试 (S Parameter)	2	5 ~ 6
6	无源测试 (Passive Test)	3	7 ~ 9
7	材质证明 (Material Certificate)	18	10~ 27
8	RoHS报告 (RoHS Test Report)	**	**
9	N/A	N/A	N/A
10	-	-	-
11	-	-	-
12	-	-	-
13	-	-	-

add: 东莞市长安镇沙头社区木鱼路59号元富工业区 Tel:0769-82586086 Fax:0769-82586086

Remark:The device only support 2.4G WiFi

RoHS
Compatible

CUSTOMER	
PART NO	

REV.	DESCRIPTION	DATE
△	首次发行	2020.12.11

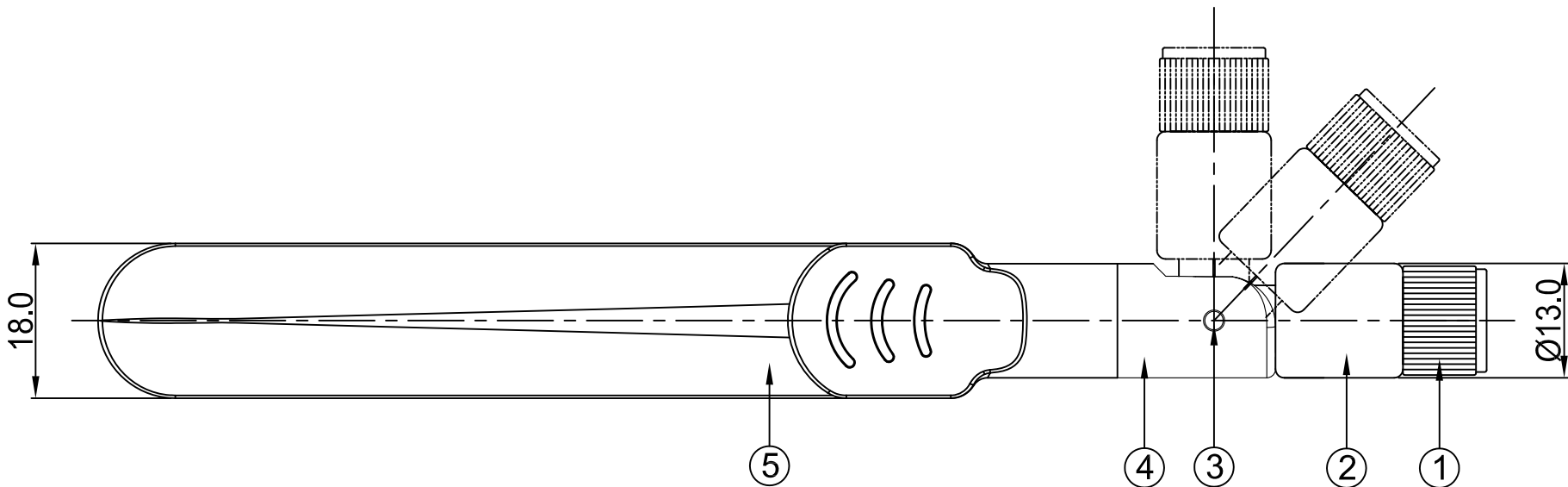
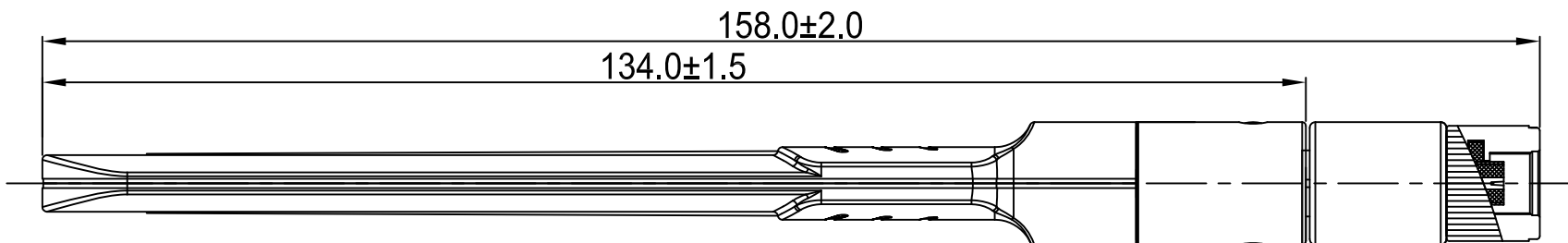

5	Antenna Cap	ABS,Color:Black	1
4	Upper Base	PC, Color:Black	1
3	Rivet	POM, Color:Black	2
2	Bottom Base	PC, Color:Black	1
1	SMA Male Reverse	Cu Black	1
NO	PART NAME	DESCRIPTION	Q.TY

东莞市一佳电子通讯科技有限公司
 Dongguan YiJia Electronics Communication Technology Co.,Ltd. Tel :0769-85535057 Fax:0769-81664308

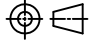
PART NAME: 2.4/5.8G Antenna			
PART NO.: YJS01.042.011.102A		DATE: 2020.12.11	
APPROVED BY	CHECKED BY	DESIGNED BY	 Tolerance X.X ±0.50 X.XX±0.15 X° ±3°
殷涛	陈昌	吕森桦	
UNITS: mm SCALE: 1/1 REVISION: A			



天线规格

Antenna Specification

Electrical Properties	
Frequency	2400~2484MHz 5720~5850MHz
Impedance	50 Ohm Nominal
V.S.W.R	2.0 Max
Return Loss	10 dB Max <small>Remark: The device only support 2.4G WiFi</small>
Radiation	Omni-directional
Gain (Peak)	1.8dBi@2400~2484MHz 3.5dBi@5720~5850MHz
Polarization	Linear
Connector	SMA Male Reverse
Physical Properties	
Antenna Material	PC /POM/ABS
Cable Type	None
Operating Temp.	-40 ~ +85 °C
Storage Temp.	25 ± 5 < 70%
Cable Color	None

add: 东莞市长安镇沙头社区木鱼路59号元富工业区 Tel:0769-82586086 Fax:0769-82586086

Remark: The device only support 2.4G WiFi



Antenna Performance Test

**Agilent
E5071B**

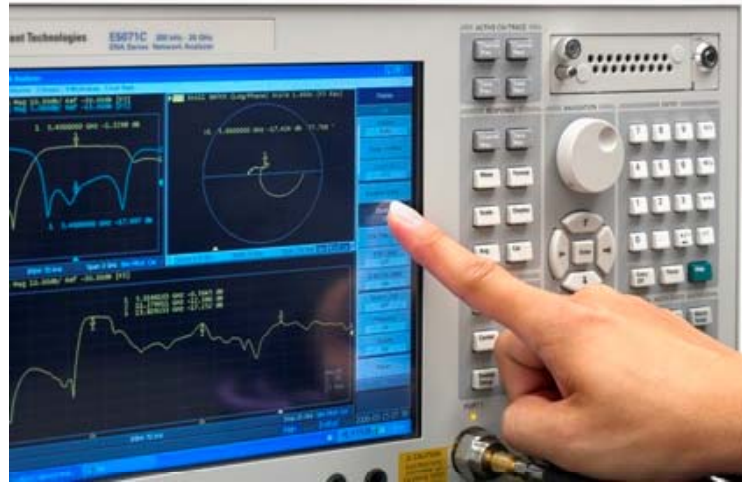

**SParameter
Test //
WIFI2.4G**

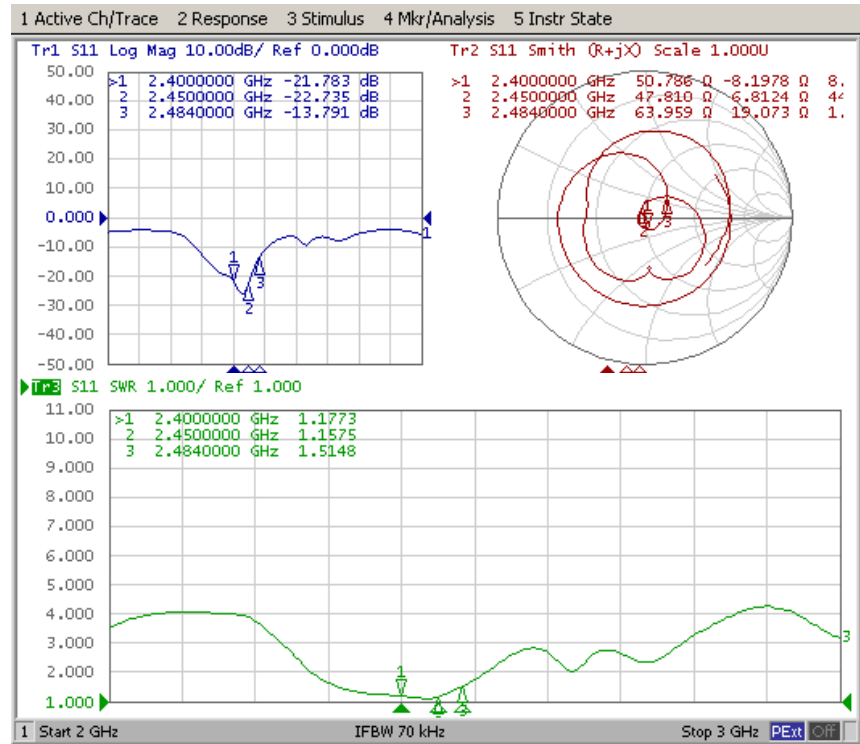

add: 东莞市长安镇沙头社区木鱼路59号元富工业区 Tel:0769-82586086 Fax:0769-82586086

Remark:The device only support 2.4G WiFi



Antenna Performance Test

**Agilent
E5071B**

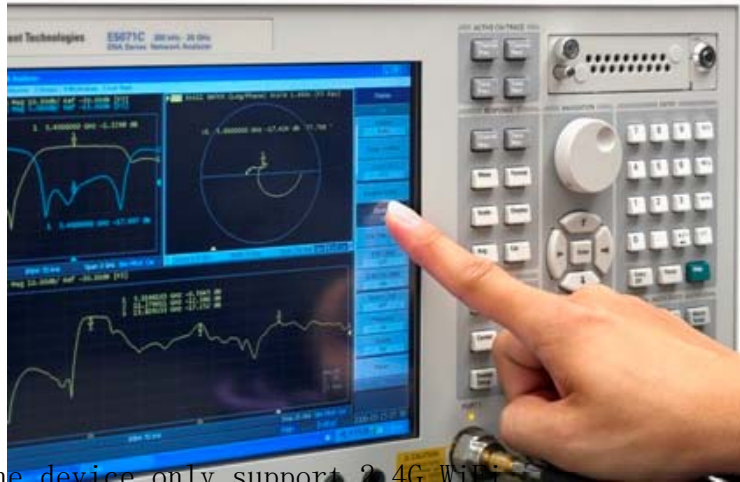

Remark: The device only support 2.4G WiFi

**S
Parameter
Test //
WiFi 5.8G**

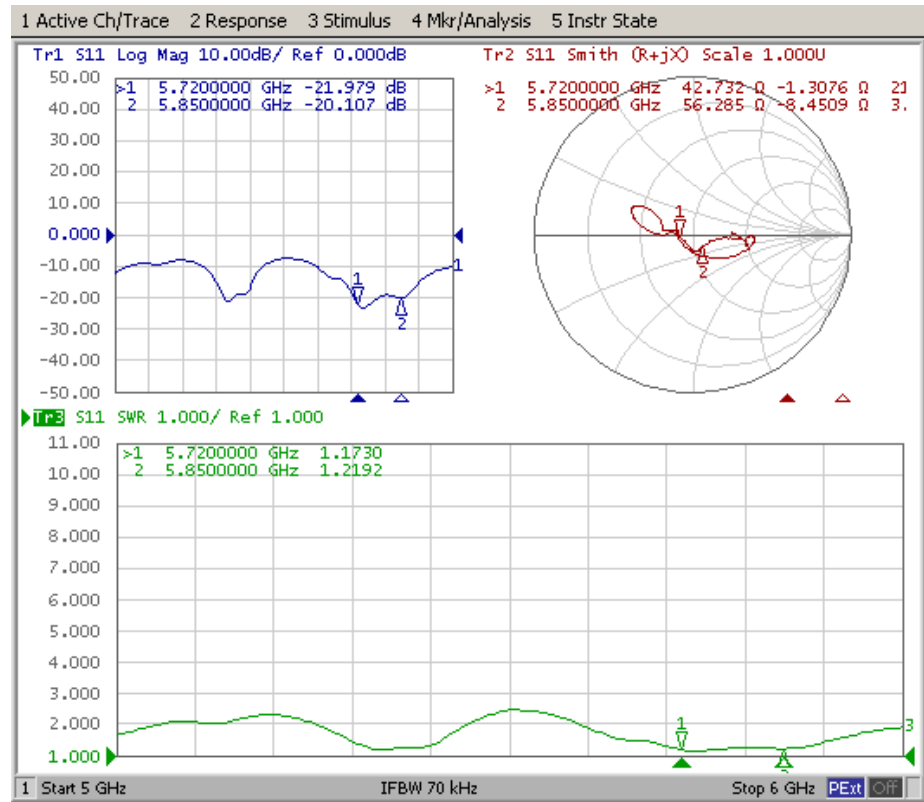

add: 东莞市长安镇沙头社区木鱼路59号元富工业区 Tel:0769-82586086 Fax:0769-82586086

Remark: The device only support 2.4G WiFi



Antenna Passive Test





Passive Test For WIFI2.4G

Freq (MHz)	Effi (%)	Effi (dB)	Gain (dBi)
2400	51.5	-2.9	1.0
2410	52.9	-2.8	1.2
2420	53.1	-2.8	1.3
2430	53.8	-2.7	1.5
2440	54.2	-2.7	1.7
2450	54.6	-2.6	1.8
2460	53.8	-2.7	1.8
2470	53.7	-2.7	1.7
2480	53.1	-2.8	1.7
2490	52.2	-2.8	1.6
2500	49.9	-3.0	1.5

add: 东莞市长安镇沙头社区木鱼路59号元富工业区 Tel:0769-82586086 Fax:0769-82586086

Remark:The device only support 2.4G WiFi



Passive Test For WIFI5.8G

Freq (MHz)	Effi (%)	Effi (dB)	Gain (dBi)
5700	41.7	-3.8	3.0
5720	41.3	-3.8	3.1
5740	44.5	-3.5	3.2
5760	46.5	-3.3	3.2
5780	43.2	-3.7	3.3
5800	53.7	-2.7	3.5
5820	53.5	-2.7	3.2
5840	51.7	-2.9	3.1
5860	54.5	-2.6	3.0
5880	55.4	-2.6	2.9
5900	62.1	-2.1	3.4

add: 东莞市长安镇沙头社区木鱼路59号元富工业区 Tel:0769-82586086 Fax:0769-82586086

Remark:The device only support 2.4G WiFi