



# Shenzhen CTA Testing Technology Co., Ltd.

Room 106, Building 1, Yibaolai Industrial Park, Qiaotou Community, Fuhai Street, Bao'an District, Shenzhen, China

## TEST REPORT

Report Reference No.....: **CTA24052000606**

FCC ID .....: **2BE8S-F24**

Compiled by  
( position+printed name+signature)..: File administrators Zoey Cao

Supervised by  
( position+printed name+signature)..: Project Engineer Amy Wen



Approved by  
( position+printed name+signature)..: RF Manager Eric Wang

Date of issue.....: May 28, 2024

Testing Laboratory Name .....: **Shenzhen CTA Testing Technology Co., Ltd.**

Address .....: Room 106, Building 1, Yibaolai Industrial Park, Qiaotou Community, Fuhai Street, Bao'an District, Shenzhen, China

Applicant's name .....: **Shenzhen kehuitong Technology Co., Ltd.**

Address .....: F3.830306G, 3rd Floor, Tianan Code City Tianjing Building, No.6 Tianan Road, Shatou Street, Futian District, Shenzhen China

Test specification .....

**IEC 62209-2:2010; IEEE 1528:2013; FCC 47 CFR Part 2.1093;**

Standard .....: **ANSI/IEEE C95.1:2005; Reference FCC KDB 447498; KDB 248227; KDB 941225; KDB 865664**

**Shenzhen CTA Testing Technology Co., Ltd. All rights reserved.**

This publication may be reproduced in whole or in part for non-commercial purposes as long as the Shenzhen CTA Testing Technology Co., Ltd. is acknowledged as copyright owner and source of the material. Shenzhen CTA Testing Technology Co., Ltd. takes no responsibility for and will not assume liability for damages resulting from the reader's interpretation of the reproduced material due to its placement and context.

Test item description.....: **mobile phone**

Trade Mark .....: Aidekunlin

Manufacturer .....: Shenzhen kehuitong Technology Co., Ltd.

Model/Type reference.....: F24

Listed Models .....: Refer to page 2

Rating .....: DC 3.85V From battery and DC 5.0V From external circuit

Result .....: **PASS**

# TEST REPORT

Equipment under Test : mobile phone

Model /Type : F24

Listed Models : F25,F26,F27,F28,F29,F30,F31,F32,F33,F34,F35,F70,F70U,F80,  
F80U,F90,F90U,F60,F12pro,F13pro,F14pro,F27pro,F100,F200,  
F300,F400,F500,F600,F700,M200,M210,M220,M230,M240,M250,  
M260,M270,M280,M290,M300,M70,M70U,M80,M80U,M90,M90U,  
M66,M66pro,M55,M55U,M58,

Applicant : Shenzhen kehuitong Technology Co., Ltd.

Address : F3.830306G, 3rd Floor, Tianan Code City Tianjing Building,No.6  
Tianan Road, Shatou Street,Futian District, Shenzhen China

Manufacturer : Shenzhen kehuitong Technology Co., Ltd.

Address : F3.830306G, 3rd Floor, Tianan Code City Tianjing Building,No.6  
Tianan Road, Shatou Street,Futian District, Shenzhen China

<b>Test Result:</b>	<b>PASS</b>
---------------------	-------------

The test report merely corresponds to the test sample.

It is not permitted to copy extracts of these test result without the written permission of the test laboratory.

# Contents

1	Statement of Compliance .....	6
2	General Information .....	7
2.1	General Remarks .....	7
2.2	Description of Equipment Under Test (EUT).....	7
2.3	Device Category and SAR Limits .....	8
2.4	Applied Standard .....	8
2.5	Test Facility.....	9
2.6	Environment of Test Site.....	9
2.7	Test Configuration.....	9
3	Specific Absorption Rate (SAR).....	10
3.1	Introduction.....	10
3.2	SAR Definition .....	10
4	SAR Measurement System.....	11
4.1	E-Field Probe.....	11
4.2	Data Acquisition Electronics (DAE).....	12
4.3	Robot.....	13
4.4	Measurement Server .....	13
4.5	Phantom .....	14
4.6	Device Holder.....	14
4.7	Data Storage and Evaluation.....	15
5	Test Equipment List .....	18
6	Tissue Simulating Liquids .....	19
7	System Verification Procedures .....	21
8	EUT Testing Position .....	23
8.1	Handset Reference Points.....	23
8.2	Positioning for Cheek / Touch .....	24
8.3	Positioning for Ear / 15° Tilt .....	24
8.4	Body Worn Accessory Configurations.....	25
8.5	Wireless Router (Hotspot) Configurations .....	25
9	Measurement Procedures.....	26
9.1	Spatial Peak SAR Evaluation .....	26
9.2	Power Reference Measurement.....	26
9.3	Area Scan Procedures .....	27
9.4	Zoom Scan Procedures.....	27
9.5	Volume Scan Procedures .....	29
9.6	Power Drift Monitoring.....	29
10	TEST CONDITIONS AND RESULTS .....	30
10.1	Conducted Power.....	30
10.2	Transmit Antennas and SAR Measurement Position .....	35
10.3	SAR Test Exclusion and Estimated SAR.....	36
10.4	SAR Test Results Summary .....	37

10.5	SAR Measurement Variability .....	42
10.6	Simultaneous Transmission Analysis.....	43
11	Measurement Uncertainty .....	45
Appendix A.	EUT Photos and Test Setup Photos .....	47
Appendix B.	Plots of SAR System Check.....	49
Appendix C.	Plots of SAR Test Data .....	53
Appendix D.	DASY System Calibration Certificate .....	65

### Version

Version No.	Date	Description
R00	May 29, 2024	Original

# 1 Statement of Compliance

## <Highest SAR Summary>

This device is in compliance with Specific Absorption Rate (SAR) for general population/uncontrolled exposure limits (1.6 W/kg) specified in FCC 47 CFR part 2 (2.1093) and ANSI/IEEE C95.1-2005, and had been tested in accordance with the measurement methods and procedures specified in IEEE 1528-2013. The maximum results of Specific Absorption Rate (SAR) found during testing are as follows.

Frequency Band	Highest Reported 1g-SAR(W/Kg)			Simultaneous Reported SAR (W/Kg)
	Head	Body-Worn (10mm)	Host pot (10mm)	
GSM 850	0.552	0.753	0.753	Head: 0.980 Body:1.290
PCS1900	0.396	0.712	0.712	
WCDMA Band II	0.232	0.693	0.693	
WCDMA Band VI	0.359	0.998	0.998	
WCDMA Band V	0.334	0.719	0.719	
WLAN2.4G	0.435	0.295	0.295	
<b>SAR Test Limit (W/Kg)</b>	<b>1.60</b>			
<b>Test Result</b>	<b>PASS</b>			

## 2 General Information

### 2.1 General Remarks

Date of receipt of test sample	:	May 20, 2024
Testing commenced on	:	May 21, 2024
Testing concluded on	:	May 24, 2024

### 2.2 Description of Equipment Under Test (EUT)

Product Name:	mobile phone
Model/Type reference:	Blade10 Pro
Power supply:	DC 3.87V from battery or DC 5V from adapter
Testing sample ID:	CTA240520006-1# (Engineer sample) CTA240520006-2# (Normal sample)
Hardware version:	V1.0
Software version:	V1.0
Tx Frequency:	SRD: BT:2402~2480MHz 2.4G WIFI: 2412~2462MHz GSM: GSM850 TX: 824.2~848.8MHz PCS1900 TX: 1850.2~1909.8MHz WCDMA: Band 2: TX: 1852.4~1907.6MHz Band 4: TX: 1712.4~1752.6MHz Band 5: TX: 826.40~846.60MHz
Type of Modulation:	BT: GFSK, $\pi/4$ DQPSK, 8DPSK 2.4G WIFI: BPSK, QPSK, 16QAM, 64QAM GSM: GMSK WCDMA: QPSK, 16QAM
Category of device:	Portable device
<b>Remark:</b>	The above DUT's information was declared by manufacturer. Please refer to the specifications or user's manual for more detailed description.

### 2.3 Device Category and SAR Limits

This device belongs to portable device category because its radiating structure is allowed to be used within 20 centimeters of the body of the user. Limit for General Population/Uncontrolled exposure should be applied for this device, it is 1.6 W/kg as averaged over any 1 gram of tissue.

### 2.4 Applied Standard

The Specific Absorption Rate (SAR) testing specification, method, and procedure for this device is in accordance with the following standards:

- FCC 47 CFR Part 2 (2.1093:2013)
- ANSI/IEEE C95.1:2005
- IEEE Std 1528:2013
- KDB 865664 D01 SAR Measurement 100 MHz to 6 GHz v01r04
- KDB 865664 D02 RF Exposure Reporting v01r02
- KDB 447498 D01 General RF Exposure Guidance v06
- KDB 248227 D01 802.11 Wi-Fi SAR v02r02
- KDB 941225 D01 3G SAR Procedures v03r01
- KDB 941225 D06 Hotspot SAR v02r01
- KDB 648474 D04 Handset SAR v01r03



## 2.5 Test Facility

**FCC-Registration No.: 517856      Designation Number: CN1318**

Shenzhen CTA Testing Technology Co., Ltd. has been listed on the US Federal Communications Commission list of test facilities recognized to perform electromagnetic emissions measurements.

**A2LA-Lab Cert. No.: 6534.01**

Shenzhen CTA Testing Technology Co., Ltd. has been listed by American Association for Laboratory Accreditation to perform electromagnetic emission measurement.

**ISED#: 27890      CAB identifier: CN0127**

Shenzhen CTA Testing Technology Co., Ltd. has been listed by Innovation, Science and Economic Development Canada to perform electromagnetic emission measurement.

The 3m-Semi anechoic test site fulfils CISPR 16-1-4 according to ANSI C63.10 and CISPR 16-1-4:2010.

## 2.6 Environment of Test Site

Items	Required	Actual
Temperature (°C)	18-25	22~23
Humidity (%RH)	30-70	55~65

## 2.7 Test Configuration

The device was controlled by using a base station emulator. Communication between the device and the emulator was established by air link. The distance between the EUT and the antenna of the emulator is larger than 50 cm and the output power radiated from the emulator antenna is at least 30 dB smaller than the output power of EUT. The EUT was set from the emulator to radiate maximum output power during all tests. For WLAN SAR testing, WLAN engineering testing software installed on the EUT can provide continuous transmitting RF signal.

### 3 Specific Absorption Rate (SAR)

#### 3.1 Introduction

SAR is related to the rate at which energy is absorbed per unit mass in an object exposed to a radio field. The SAR distribution in a biological body is complicated and is usually carried out by experimental techniques or numerical modeling. The standard recommends limits for two tiers of groups, occupational/controlled and general population/uncontrolled, based on a person's awareness and ability to exercise control over his or her exposure. In general, occupational/controlled exposure limits are higher than the limits for general population/uncontrolled.

#### 3.2 SAR Definition

The SAR definition is the time derivative (rate) of the incremental energy (dW) absorbed by (dissipated in) an incremental mass (dm) contained in a volume element (dv) of a given density (ρ). The equation description is as below:

$$\text{SAR} = \frac{d}{dt} \left( \frac{dW}{dm} \right) = \frac{d}{dt} \left( \frac{dW}{\rho dv} \right)$$

SAR is expressed in units of Watts per kilogram (W/kg)

SAR measurement can be either related to the temperature elevation in tissue by

$$\text{SAR} = c \left( \frac{\delta T}{\delta t} \right)$$

Where: C is the specific heat capacity, δT is the temperature rise and δt is the exposure duration, or related to the electrical field in the tissue by

$$\text{SAR} = \frac{\sigma |E|^2}{\rho}$$

Where: σ is the conductivity of the tissue, ρ is the mass density of the tissue and E is the RMS electrical field strength.

However, for evaluating SAR of low power transmitter, electrical field measurement is typically applied.

## 4 SAR Measurement System

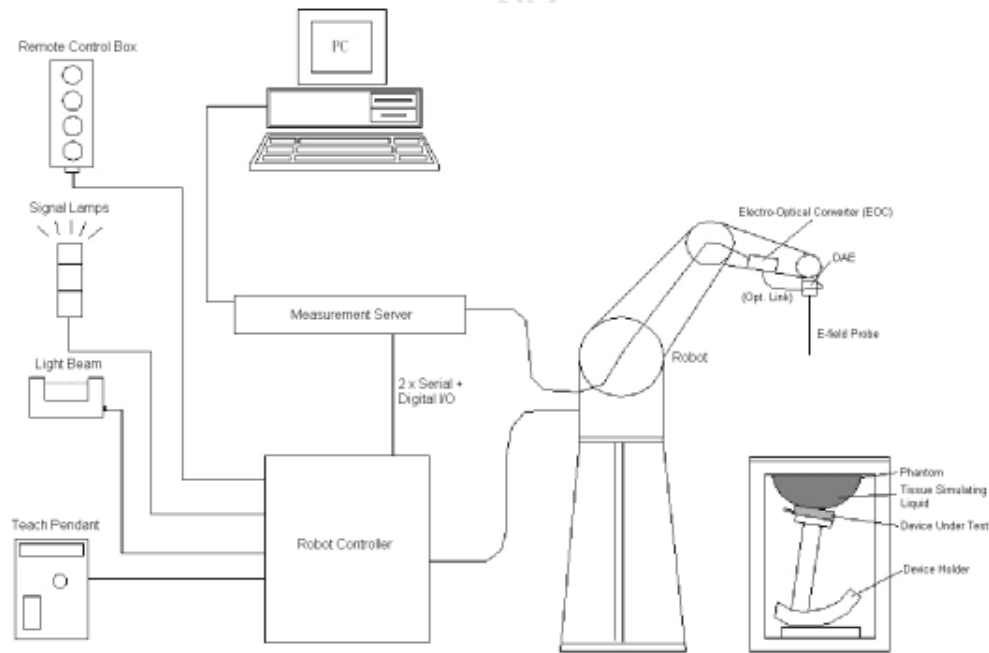

### DASY System Configurations

The DASY system for performance compliance tests is illustrated above graphically. This system consists of the following items:

- A standard high precision 6-axis robot with controller, a teach pendant and software
- A data acquisition electronic (DAE) attached to the robot arm extension
- A dosimetric probe equipped with an optical surface detector system
- The electro-optical converter (EOC) performs the conversion between optical and electrical signals
- A measurement server performs the time critical tasks such as signal filtering, control of the robot operation and fast movement interrupts.
- A probe alignment unit which improves the accuracy of the probe positioning
- A computer operating Windows XP
- DASY software
- Remote control with teach pendant and additional circuitry for robot safety such as warning lamps, etc.
- The SAM twin phantom
- A device holder
- Tissue simulating liquid
- Dipole for evaluating the proper functioning of the system

components are described in details in the following sub-sections.

#### 4.1 E-Field Probe

The SAR measurement is conducted with the dosimetric probe (manufactured by SPEAG). The probe is specially designed and calibrated for use in liquid with high permittivity. The dosimetric probe has special calibration in liquid at different frequency. This probe has a built in optical surface

detection system to prevent from collision with phantom.

### ➤ E-Field Probe Specification

#### <EX3DV4 Probe>

<b>Construction</b>	Symmetrical design with triangular core Built-in shielding against static charges PEEK enclosure material (resistant to organic solvents, e.g., DGBE)
<b>Frequency</b>	10 MHz to 6 GHz; Linearity: $\pm 0.2$ dB
<b>Directivity</b>	$\pm 0.3$ dB in HSL (rotation around probe axis) $\pm 0.5$ dB in tissue material (rotation normal to probe axis)
<b>Dynamic Range</b>	10 $\mu$ W/g to 100 W/kg; Linearity: $\pm 0.2$ dB (noise: typically < 1 $\mu$ W/g)
<b>Dimensions</b>	Overall length: 330 mm (Tip: 20 mm) Tip diameter: 2.5 mm (Body: 12 mm) Typical distance from probe tip to dipole centers: 1 mm



Photo of EX3DV4

### ➤ E-Field Probe Calibration

Each probe needs to be calibrated according to a dosimetric assessment procedure with accuracy better than  $\pm 10\%$ . The spherical isotropy shall be evaluated and within  $\pm 0.25$ dB. The sensitivity parameters (NormX, NormY, and NormZ), the diode compression parameter (DCP) and the conversion factor (ConvF) of the probe are tested. The calibration data can be referred to appendix C of this report.

## 4.2 Data Acquisition Electronics (DAE)

The data acquisition electronics (DAE) consists of a highly sensitive electrometer-grade preamplifier with auto-zeroing, a channel and gain-switching multiplexer, a fast 16 bit AD-converter and a command decoder and control logic unit. Transmission to the measurement server is accomplished through an optical downlink for data and status information as well as an optical uplink for commands and the clock.

The input impedance of the DAE is 200M $\Omega$ ; the inputs are symmetrical and floating. Common mode rejection is above 80dB.



Photo of DAE

### 4.3 Robot

The SPEAG DASY system uses the high precision robots (DASY5: TX60XL) type from Stäubli SA (France). For the 6-axis controllersystem, the robot controller version (DASY5: CS8c) from Stäubli is used. The Stäublirobot series have many features that are important for our application:

- High precision (repeatability  $\pm 0.035$  mm)
- High reliability (industrial design)
- Jerk-free straight movements
- Low ELF interference (the closed metallic construction shields against motor control fields)



**Photo of DASY5**

### 4.4 Measurement Server

The measurement server is based on a PC/104 CPU board with CPU (DASY5: 400 MHz, Intel Celeron), chipdisk (DASY5: 128 MB), RAM (DASY5: 128 MB). The necessary circuits for communication with the DAE electronic box, as well as the 16 bit AD converter system for optical detection and digital I/O interface are contained on the DASY I/O board, which is directly connected to the PC/104 bus of the CPU board.

The measurement server performs all the real-time data evaluation for field measurements and surface detection, controls robot movements and handles safety operations.

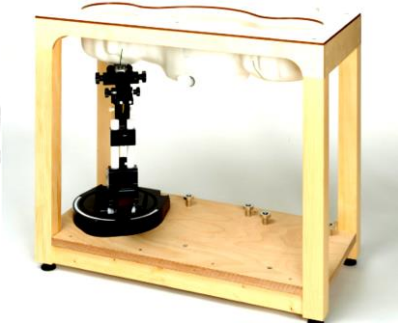

**Photo of Server for DASY5**



## 4.5 Phantom

### <SAM Twin Phantom>

<b>Shell Thickness</b>	2 ± 0.2 mm; Center ear point: 6 ± 0.2 mm	 <p><b>Photo of SAM Phantom</b></p>
<b>Filling Volume</b>	Approx. 25 liters	
<b>Dimensions</b>	Length: 1000 mm; Width: 500 mm; Height: adjustable feet	
<b>Measurement Areas</b>	Left Hand, Right Hand, Flat Phantom	

The bottom plate contains three pair of bolts for locking the device holder. The device holder positions are adjusted to the standard measurement positions in the three sections. A white cover is provided to tap the phantom during off-periods to prevent water evaporation and changes in the liquid parameters. On the phantom top, three reference markers are provided to identify the phantom position with respect to the robot.

### <ELI4 Phantom>

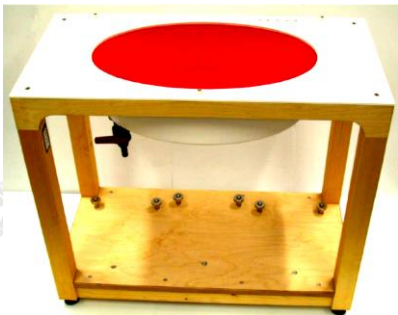
<b>Shell Thickness</b>	2 ± 0.2 mm (sagging: <1%)	 <p><b>Photo of ELI4 Phantom</b></p>
<b>Filling Volume</b>	Approx. 30 liters	
<b>Dimensions</b>	Major ellipse axis: 600 mm Minor axis: 400 mm	

The ELI4 phantom is intended for compliance testing of handheld and body-mounted wireless devices in the frequency range of 30 MHz to 6 GHz. ELI4 is fully compatible with standard and all known tissue simulating liquids.

## 4.6 Device Holder

The SAR in the phantom is approximately inversely proportional to the square of the distance between the source and the liquid surface. For a source at 5 mm distance, a positioning uncertainty of ±0.5mm would produce a SAR uncertainty of ± 20%. Accurate device positioning is therefore crucial for accurate and repeatable measurements. The positions in which the devices must be measured are defined by the standards.

The DASY device holder is designed to cope with different positions given in the standard. It has two scales for the device rotation (with respect to the body axis) and the device inclination (with respect to the line between the ear reference points). The rotation center for both scales is the ear reference point

(ERP). Thus the device needs no repositioning when changing the angles.

The DASY device holder is constructed of low-loss POM material having the following dielectric parameters: relative permittivity  $\epsilon = 3$  and loss tangent  $\delta = 0.02$ . The amount of dielectric material has been reduced in the closest vicinity of the device, since measurements have suggested that the influence of the clamp on the test results could thus be lowered.



**Device Holder**

#### 4.7 Data Storage and Evaluation

##### ➤ Data Storage

The DASY software stores the assessed data from the data acquisition electronics as raw data (in microvolt readings from the probe sensors), together with all the necessary software parameters for the data evaluation (probe calibration data, liquid parameters and device frequency and modulation data) in measurement files. The post-processing software evaluates the desired unit and format for output each time the data is visualized or exported. This allows verification of the complete software setup even after the measurement and allows correction of erroneous parameter settings. For example, if a measurement has been performed with an incorrect crest factor parameter in the device setup, the parameter can be corrected afterwards and the data can be reevaluated.

The measured data can be visualized or exported in different units or formats, depending on the selected probe type (e.g., [V/m], [A/m], [W/kg]). Some of these units are not available in certain situations or give meaningless results, e.g., a SAR-output in a non-lose media, will always be zero. Raw data can also be exported to perform the evaluation with other software packages.

##### ➤ Data Evaluation

The DASY post-processing software (SEMCAD) automatically executes the following procedures to calculate the field units from the microvolt readings at the probe connector. The parameters used in the evaluation are stored in the configuration modules of the software:

<b>Probe parameters:</b>	- Sensitivity	Norm <sub>i</sub> , a <sub>i0</sub> , a <sub>i1</sub> , a <sub>i2</sub>
	- Conversion factor	ConvF <sub>i</sub>
	- Diode compression point	dcp <sub>i</sub>
<b>Device parameters:</b>	- Frequency	f
	- Crest factor	cf
<b>Media parameters:</b>	- Conductivity	σ
	- Density	ρ

These parameters must be set correctly in the software. They can be found in the component documents or they can be imported into the software from the configuration files issued for the DASYS components. In the direct measuring mode of the multi-meter option, the parameters of the actual system setup are used. In the scan visualization and export modes, the parameters stored in the corresponding document files are used.

The first step of the evaluation is a linearization of the filtered input signal to account for the compression characteristics of the detector diode. The compensation depends on the input signal, the diode type and the DC-transmission factor from the diode to the evaluation electronics. If the exciting field is pulsed, the crest factor of the signal must be known to correctly compensate for peak power.

The formula for each channel can be given as:

$$V_i = U_i + U_i^2 \cdot \frac{cf}{dcp_i}$$

with  $V_i$  = compensated signal of channel  $i$ , ( $i = x, y, z$ )

$U_i$  = input signal of channel  $i$ , ( $i = x, y, z$ )

cf = crest factor of exciting field (DASY parameter)

dcp <sub>$i$</sub>  = diode compression point (DASY parameter)

From the compensated input signals, the primary field data for each channel can be evaluated:

$$\text{E-field Probes: } E_i = \sqrt{\frac{V_i}{\text{Norm}_i \cdot \text{ConvF}}}$$

$$\text{H-field Probes: } H_i = \sqrt{V_i} \cdot \frac{a_{i0} + a_{i1}f + a_{i2}f^2}{f}$$

with  $V_i$  = compensated signal of channel  $i$ , ( $i = x, y, z$ )

Norm <sub>$i$</sub>  = sensor sensitivity of channel  $i$ , ( $i = x, y, z$ ),  $\mu\text{V}/(\text{V/m})^2$  for E-field Probes

ConvF = sensitivity enhancement in solution

$a_{ij}$  = sensor sensitivity factors for H-field probes

f = carrier frequency [GHz]

$E_i$  = electric field strength of channel  $i$  in V/m

$H_i$  = magnetic field strength of channel  $i$  in A/m

The RSS value of the field components gives the total field strength (Hermitian magnitude):



$$E_{\text{tot}} = \sqrt{E_x^2 + E_y^2 + E_z^2}$$

The primary field data are used to calculate the derived field units.

$$\text{SAR} = E_{\text{tot}}^2 \cdot \frac{\sigma}{\rho \cdot 1000}$$

with SAR = local specific absorption rate in W/kg

$E_{\text{tot}}$  = total field strength in V/m

$\sigma$  = conductivity in [mho/m] or [Siemens/m]

$\rho$  = equivalent tissue density in g/cm<sup>3</sup>

Note that the density is set to 1, to account for actual head tissue density rather than the density of the tissue simulating liquid.

## 5 Test Equipment List

Manufacturer	Name of Equipment	Type/Model	Serial Number	Calibration	
				Last Cal.	Due Date
SPEAG	835MHz System Validation Kit	D835V2	484	Aug. 25,2023	Aug. 24,2026
SPEAG	1800MHz System Validation Kit	D1800V2	2d158	Dec. 17,2021	Dec. 16,2024
SPEAG	1900MHz System Validation Kit	D1900V2	5d002	Aug. 25,2023	Aug. 24,2026
SPEAG	2450MHz System Validation Kit	D2450V2	745	Aug. 28,2023	Aug. 27,2026
Rohde & Schwarz	UNIVERSAL RADIO COMMUNICATION TESTER	CMW500	1201.0002K50-104209-JC	Nov.05, 2023	Nov.04, 2024
SPEAG	Data Acquisition Electronics	DAE3	428	Aug.30,2023	Aug.29,2024
SPEAG	Dosimetric E-Field Probe	EX3DV4	7380	June 21,2023	June 20,2024
Agilent	ENA Series Network Analyzer	E5071C	MY46317418	Oct.25, 2023	Oct.24, 2024
SPEAG	DAK	DAK-3.5	1226	NCR	NCR
SPEAG	SAM Twin Phantom	QD000P40CD	1802	NCR	NCR
SPEAG	ELI Phantom	QDOVA004AA	2058	NCR	NCR
AR	Amplifier	ZHL-42W	QA1118004	NCR	NCR
Agilent	Power Meter	N1914A	MY50001102	Oct.25, 2023	Oct.24, 2024
Agilent	Power Sensor	N8481H	MY51240001	Oct.25, 2023	Oct.24, 2024
R&S	Spectrum Analyzer	N9020A	MY51170037	Oct.25, 2023	Oct.24, 2024
Agilent	Signal Generation	N5182A	MY48180656	Oct.25, 2023	Oct.24, 2024
Worken	Directional Coupler	0110A05601O-10	COM5BNW1A2	Oct.25, 2023	Oct.24, 2024

### Note:

1. The calibration certificate of DASY can be referred to appendix D of this report.
2. The dipole calibration interval can be extended to 3 years with justification. The dipoles are also not physically damaged, or repaired during the interval.
3. The Insertion Loss calibration of Dual Directional Coupler and Attenuator were characterized via the network analyzer and compensated during system check.
4. The dielectric probe kit was calibrated via the network analyzer, with the specified procedure (calibrated in pure water) and calibration kit (standard) short circuit, before the dielectric measurement. The specific procedure and calibration kit are provided by Agilent.
5. In system check we need to monitor the level on the power meter, and adjust the power amplifier level to have precise power level to the dipole; the measured SAR will be normalized to 1W input power according to the ratio of 1W to the input power to the dipole. For system check, the calibration of the power amplifier is deemed not critically required for correct measurement; the power meter is critical and we do have calibration for it

## 6 Tissue Simulating Liquids

For the measurement of the field distribution inside the SAM phantom with DASY, the phantom must be filled with around 25 liters of homogeneous body tissue simulating liquid. For head SAR testing, the liquid height from the ear reference point (ERP) of the phantom to the liquid top surface is larger than 15 cm, which is shown in Fig. 6.1. For body SAR testing, the liquid height from the center of the flat phantom to the liquid top surface is larger than 15 cm, which is shown as followed:



Photo of Liquid Height for Head SAR

Photo of Liquid Height for Body SAR

The following table gives the recipes for tissue simulating liquid.

Frequency (MHz)	Water (%)	Sugar (%)	Cellulose (%)	Salt (%)	Preventol (%)	DGBE (%)	Conductivity ( $\sigma$ )	Permittivity ( $\epsilon_r$ )
<b>For Head</b>								
835	40.3	57.9	0.2	1.4	0.2	0	0.90	41.5
1800,1900,2000	55.2	0	0	0.3	0	44.5	1.40	40.0
2450	55.0	0	0	0	0	45.0	1.80	39.2
2600	54.8	0	0	0.1	0	45.1	1.96	39.0
<b>For Body</b>								
835	50.8	48.2	0	0.9	0.1	0	0.97	55.2
1800,1900,2000	70.2	0	0	0.4	0	29.4	1.52	53.3
2450	68.6	0	0	0	0	31.4	1.95	52.7
2600	65.5	0	0	0	0	31.5	2.16	52.5

The following table shows the measuring results for simulating liquid.

Measured Frequency (MHz)	Target Tissue		Measured Tissue				Liquid Temp.	Test Data
	$\epsilon_r$	$\sigma$	$\epsilon_r$	Dev. (%)	$\sigma$	Dev. (%)		
835	41.5	0.90	43.081	3.81%	0.869	-3.43%	22.7	05/21/2024
1750	40.1	1.37	38.203	-4.73%	1.335	-2.52%	22.5	05/22/2024
1900	40.0	1.40	40.292	0.73%	1.449	3.52%	22.6	05/23/2024
2450	39.2	1.80	39.043	-0.40%	1.816	0.89%	22.8	05/24/2024

## 7 System Verification Procedures

Each DASY system is equipped with one or more system validation kits. These units, together with the predefined measurement procedures within the DASY software, enable the user to conduct the system performance check and system validation. System validation kit includes a dipole, tripod holder to fix it underneath the flat phantom and a corresponding distance holder.

### ➤ Purpose of System Performance check

The system performance check verifies that the system operates within its specifications. System and operator errors can be detected and corrected. It is recommended that the system performance check be performed prior to any usage of the system in order to guarantee reproducible results. The system performance check uses normal SAR measurements in a simplified setup with a well characterized source. This setup was selected to give a high sensitivity to all parameters that might fail or vary over time. The system check does not intend to replace the calibration of the components, but indicates situations where the system uncertainty is exceeded due to drift or failure.

### ➤ System Setup

In the simplified setup for system evaluation, the EUT is replaced by a calibrated dipole and the power source is replaced by a continuous wave that comes from a signal generator. The calibrated dipole must be placed beneath the flat phantom section of the SAM twin phantom with the correct distance holder. The distance holder should touch the phantom surface with a light pressure at the reference marking and be oriented parallel to the long side of the phantom. The equipment setup is shown below:

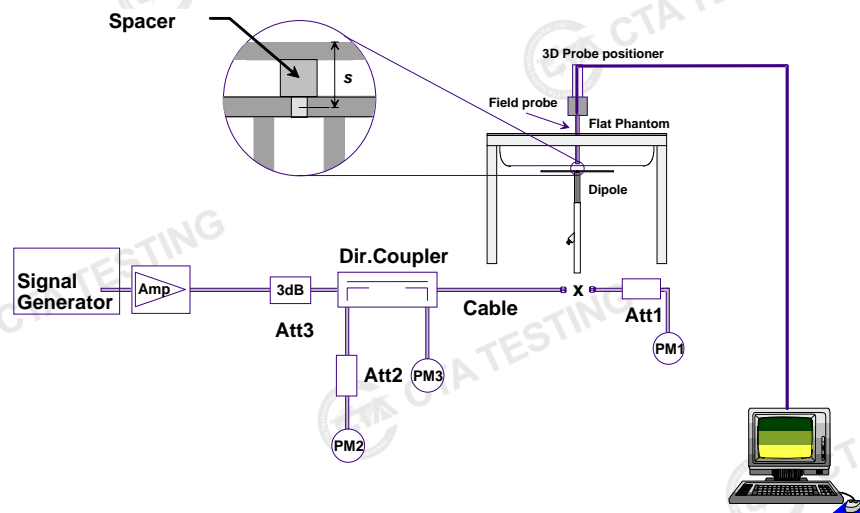

**System Setup for System Evaluation**



**Photo of Dipole Setup**

➤ **Validation Results**

Comparing to the original SAR value provided by SPEAG, the verification data should be within its specification of 10%. The table below shows the target SAR and measured SAR after normalized to 1W input power. It indicates that the system performance check can meet the variation criterion and the plots can be referred to Appendix B of this report.

Date	Frequency (MHz)	Power fed onto reference dipole (mW)	Targeted SAR 1g (W/kg)	Measured SAR1g (W/kg)	Normalized SAR (W/kg)	Deviation (%)
05/21/2024	835	250	9.68	2.37	9.48	-2.10%
05/22/2024	1750	250	39.2	9.32	37.28	-4.89%
05/23/2024	1900	250	40.1	10.38	41.52	3.56%
05/24/2024	2450	250	52.7	13.03	52.12	-1.07%



## 8 EUT Testing Position

### 8.1 Handset Reference Points

- The vertical centreline passes through two points on the front side of the handset – the midpoint of the width  $w_t$  of the handset at the level of the acoustic output, and the midpoint of the width  $w_b$  of the bottom of the handset.
- The horizontal line is perpendicular to the vertical centreline and passes the center of the acoustic output.
- The horizontal line is also tangential to the handset at point A.
- The two lines intersect at point A. Note that for many handsets, point A coincides with the center of the acoustic output; however, the acoustic output may be located elsewhere on the horizontal line. Also note that the vertical centreline is not necessarily parallel to the front face of the handset, especially for clamshell handsets, handsets with flip covers, and other irregularly shaped handsets.



Fig.8-1 Illustration for Front, Back and Side of SAM Phantom

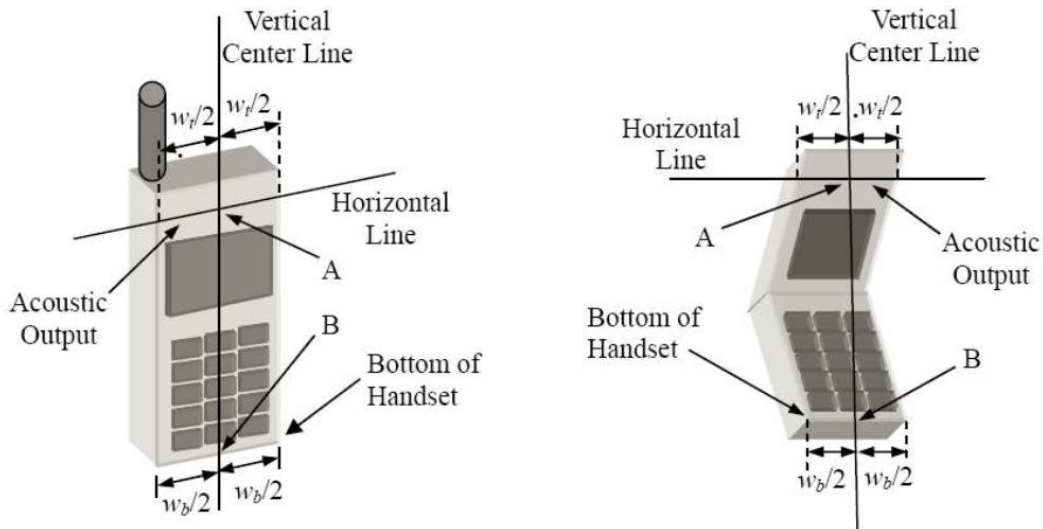

Fig.8-2 Illustration for Handset Vertical and Horizontal Reference Lines

## 8.2 Positioning for Cheek / Touch

- To position the device with the vertical center line of the body of the device and the horizontal line crossing the center piece in a plane parallel to the sagittal plane of the phantom. While maintaining the device in this plane, align the vertical center line with the reference plane containing the three ear and mouth reference point (M: Mouth, RE: Right Ear and LE: Left Ear) and align the center of the ear piece with the line RE-LE.
- To move the device towards the phantom with the ear piece aligned with the line LE-RE until the phone touched the ear. While maintaining the device in the reference plane and maintaining the phone contact with the ear, move the bottom of the phone until any point on the front side is in contact with the cheek of the phantom or until contact with the ear is lost (see below figure)



Fig.8-3 Illustration for Cheek Position

## 8.3 Positioning for Ear / 15° Tilt

- To position the device in the “cheek” position described above.
- While maintaining the device the reference plane described above and pivoting against the ear, moves it outward away from the mouth by an angle of 15 degrees or until contact with the ear is lost (see figure below).



Fig.8-4 Illustration for Tilted Position



## 8.4 Body Worn Accessory Configurations

- To position the device parallel to the phantom surface with either keypad up or down.
- To adjust the device parallel to the flat phantom
- To adjust the distance between the device surface and the flat phantom to 10 mm or holster surface and the flat phantom to 0 mm.

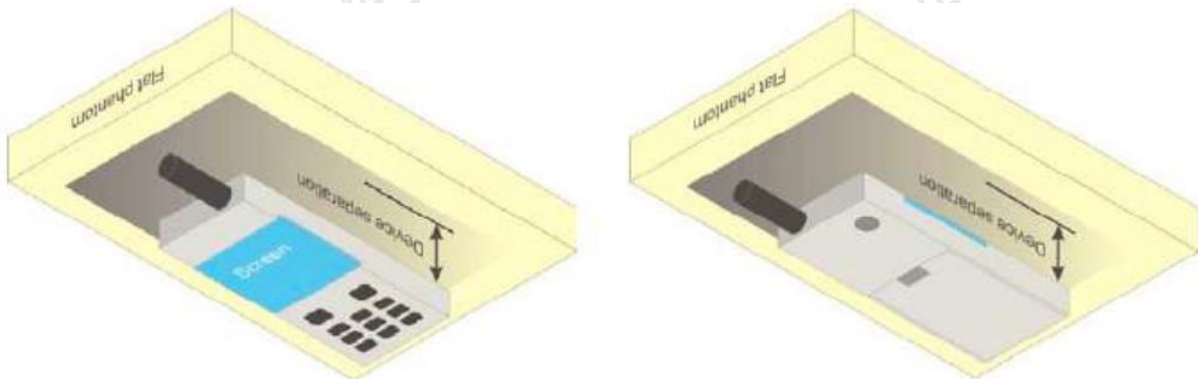

Fig.8-5 Illustration for Body Worn Position

## 8.5 Wireless Router (Hotspot) Configurations

Wireless Router (Hotspot) Configurations Some battery-operated handsets have the capability to transmit and receive internet connectivity through simultaneous transmission of WIFI in conjunction with a separate licensed transmitter. The FCC has provided guidance in KDB Publication 941225 D06 where SAR test considerations for handsets ( $L \times W \geq 9 \text{ cm} \times 5 \text{ cm}$ ) are based on a composite test separation distance of 10 mm from the front, back and edges of the device with antennas 2.5 cm or closer to the edge of the device, determined from general mixed use conditions for this type of devices. Since the hotspot SAR results may overlap with the body-worn accessory SAR requirements, the more conservative configurations can be considered, thus excluding some body-worn accessory SAR tests.

When the user enables the personal wireless router functions for the handset, actual operations include simultaneous transmission of both the WIFI transmitter and another licensed transmitter. Both transmitters often do not transmit at the same transmitting frequency and thus cannot be evaluated for SAR under actual use conditions. Therefore, SAR must be evaluated for each frequency transmission and mode separately and summed with the WIFI transmitter according to KDB 648474 publication procedures. The “Portable Hotspot” feature on the handset was NOT activated, to ensure the SAR measurements were evaluated for a single transmission frequency RF signal.

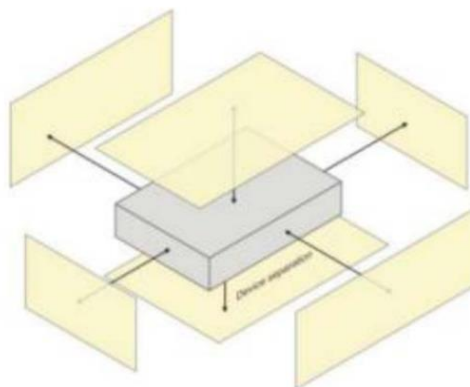

Fig.8-6 Illustration for Hotspot Position

## 9 Measurement Procedures

The measurement procedures are as follows:

- (a) Use base station simulator (if applicable) or engineering software to transmit RF power continuously (continuous Tx) in the middle channel.
- (b) Keep EUT to radiate maximum output power or 100% duty factor (if applicable)
- (c) Measure output power through RF cable and power meter.
- (d) Place the EUT in the positions as setup photos demonstrates.
- (e) Set scan area, grid size and other setting on the DASY software.
- (f) Measure SAR transmitting at the middle channel for all applicable exposure positions.
- (g) Identify the exposure position and device configuration resulting the highest SAR
- (h) Measure SAR at the lowest and highest channels at the worst exposure position and device configuration if applicable.

According to the test standard, the recommended procedure for assessing the peak spatial-average SAR value consists of the following steps:

- (a) Power reference measurement
- (b) Area scan
- (c) Zoom scan
- (d) Power drift measurement

### 9.1 Spatial Peak SAR Evaluation

The procedure for spatial peak SAR evaluation has been implemented according to the test standard. It can be conducted for 1g and 10g, as well as for user-specific masses. The DASY software includes all numerical procedures necessary to evaluate the spatial peak SAR value.

The base for the evaluation is a "cube" measurement. The measured volume must include the 1g and 10g cubes with the highest averaged SAR values. For that purpose, the center of the measured volume is aligned to the interpolated peak SAR value of a previously performed area scan.

The entire evaluation of the spatial peak values is performed within the post-processing engine (SEMCAD). The system always gives the maximum values for the 1g and 10g cubes. The algorithm to find the cube with highest averaged SAR is divided into the following stages:

- (a) Extraction of the measured data (grid and values) from the Zoom Scan
- (b) Calculation of the SAR value at every measurement point based on all stored data (A/D values and measurement parameters)
- (c) Generation of a high-resolution mesh within the measured volume
- (d) Interpolation of all measured values from the measurement grid to the high-resolution grid
- (e) Extrapolation of the entire 3-D field distribution to the phantom surface over the distance from sensor to surface
- (f) Calculation of the averaged SAR within masses of 1g and 10g

### 9.2 Power Reference Measurement

The Power Reference Measurement and Power Drift Measurements are for monitoring the power drift of the device under test in the batch process. The minimum distance of probe sensors to surface determines the closest measurement point to phantom surface. This distance cannot be smaller

than the distance of sensor calibration points to probe tip as defined in the probe properties.

### 9.3 Area Scan Procedures

The area scan is used as a fast scan in two dimensions to find the area of high field values, before doing a fine measurement around the hot spot. The sophisticated interpolation routines implemented in DASY software can find the maximum found in the scanned area, within a range of the global maximum. The range (in dB) is specified in the standards for compliance testing. For example, a 2 dB range is required in IEEE standard 1528 and IEC 62209 standards, whereby 3 dB is a requirement when compliance is assessed in accordance with the ARIB standard (Japan), if only one zoom scan follows the area scan, then only the absolute maximum will be taken as reference. For cases where multiple maximums are detected, the number of zoom scans has to be increased accordingly.

Area scan parameters extracted from FCC KDB 865664 D01 SAR measurement 100 MHz to 6 GHz.

	$\leq 3$ GHz	$> 3$ GHz
Maximum distance from closest measurement point (geometric center of probe sensors) to phantom surface	$5 \pm 1$ mm	$\frac{1}{2} \cdot \delta \cdot \ln(2) \pm 0.5$ mm
Maximum probe angle from probe axis to phantom surface normal at the measurement location	$30^\circ \pm 1^\circ$	$20^\circ \pm 1^\circ$
Maximum area scan spatial resolution: $\Delta x_{Area}$ , $\Delta y_{Area}$	$\leq 2$ GHz: $\leq 15$ mm 2 – 3 GHz: $\leq 12$ mm	3 – 4 GHz: $\leq 12$ mm 4 – 6 GHz: $\leq 10$ mm
	When the x or y dimension of the test device, in the measurement plane orientation, is smaller than the above, the measurement resolution must be $\leq$ the corresponding x or y dimension of the test device with at least one measurement point on the test device.	

### 9.4 Zoom Scan Procedures

Zoom scans are used to assess the peak spatial SAR values within a cubic averaging volume containing 1 gram and 10gram of simulated tissue. The zoom scan measures points (refer to table below) within a cube whose base faces are centered on the maxima found in a preceding area scan job within the same procedure. When the measurement is done, the zoom scan evaluates the averaged SAR for 1 gram and 10 gram and displays these values next to the job's label.

Zoom scan parameters extracted from FCC KDB 865664 D01 SAR measurement 100 MHz to 6 GHz.

		$\leq 3$ GHz	$> 3$ GHz	
Maximum distance from closest measurement point (geometric center of probe sensors) to phantom surface		$5 \text{ mm} \pm 1 \text{ mm}$	$\frac{1}{2} \cdot \delta \cdot \ln(2) \text{ mm} \pm 0.5 \text{ mm}$	
Maximum probe angle from probe axis to phantom surface normal at the measurement location		$30^\circ \pm 1^\circ$	$20^\circ \pm 1^\circ$	
Maximum area scan spatial resolution: $\Delta x_{\text{Area}}, \Delta y_{\text{Area}}$		$\leq 2$ GHz: $\leq 15 \text{ mm}$ 2 – 3 GHz: $\leq 12 \text{ mm}$	3 – 4 GHz: $\leq 12 \text{ mm}$ 4 – 6 GHz: $\leq 10 \text{ mm}$	
		When the x or y dimension of the test device, in the measurement plane orientation, is smaller than the above, the measurement resolution must be $\leq$ the corresponding x or y dimension of the test device with at least one measurement point on the test device.		
Maximum zoom scan spatial resolution: $\Delta x_{\text{Zoom}}, \Delta y_{\text{Zoom}}$		$\leq 2$ GHz: $\leq 8 \text{ mm}$ 2 – 3 GHz: $\leq 5 \text{ mm}^*$	3 – 4 GHz: $\leq 5 \text{ mm}^*$ 4 – 6 GHz: $\leq 4 \text{ mm}^*$	
Maximum zoom scan spatial resolution, normal to phantom surface	uniform grid: $\Delta z_{\text{Zoom}}(n)$	$\leq 5 \text{ mm}$	3 – 4 GHz: $\leq 4 \text{ mm}$ 4 – 5 GHz: $\leq 3 \text{ mm}$ 5 – 6 GHz: $\leq 2 \text{ mm}$	
	graded grid	$\Delta z_{\text{Zoom}}(1)$ : between 1 <sup>st</sup> two points closest to phantom surface	$\leq 4 \text{ mm}$	3 – 4 GHz: $\leq 3 \text{ mm}$ 4 – 5 GHz: $\leq 2.5 \text{ mm}$ 5 – 6 GHz: $\leq 2 \text{ mm}$
		$\Delta z_{\text{Zoom}}(n>1)$ : between subsequent points	$\leq 1.5 \cdot \Delta z_{\text{Zoom}}(n-1) \text{ mm}$	
Minimum zoom scan volume	x, y, z	$\geq 30 \text{ mm}$	3 – 4 GHz: $\geq 28 \text{ mm}$ 4 – 5 GHz: $\geq 25 \text{ mm}$ 5 – 6 GHz: $\geq 22 \text{ mm}$	
<p>Note: <math>\delta</math> is the penetration depth of a plane-wave at normal incidence to the tissue medium; see IEEE Std 1528-2013 for details.</p> <p>* When zoom scan is required and the <i>reported</i> SAR from the <i>area scan based 1-g SAR estimation</i> procedures of KDB Publication 447498 is <math>\leq 1.4 \text{ W/kg}</math>, <math>\leq 8 \text{ mm}</math>, <math>\leq 7 \text{ mm}</math> and <math>\leq 5 \text{ mm}</math> zoom scan resolution may be applied, respectively, for 2 GHz to 3 GHz, 3 GHz to 4 GHz and 4 GHz to 6 GHz.</p>				



## 9.5 Volume Scan Procedures

The volume scan is used for assess overlapping SAR distributions for antennas transmitting in different frequency bands. It is equivalent to an oversized zoom scan used in standalone measurements. The measurement volume will be used to enclose all the simultaneous transmitting antennas. For antennas transmitting simultaneously in different frequency bands, the volume scan is measured separately in each frequency band. In order to sum correctly to compute the 1g aggregate SAR, the EUT remain in the same test position for all measurements and all volume scan use the same spatial resolution and grid spacing. When all volume scan were completed, the software, SEMCAD postprocessor can combine and subsequently superpose these measurement data to calculating the multiband SAR.

## 9.6 Power Drift Monitoring

All SAR testing is under the EUT install full charged battery and transmit maximum output power. In DASY measurement software, the power reference measurement and power drift measurement procedures are used for monitoring the power drift of EUT during SAR test. Both these procedures measure the field at a specified reference position before and after the SAR testing. The software will calculate the field difference in dB. If the power drift more than 5%, the SAR will be retested.

## 10 TEST CONDITIONS AND RESULTS

### 10.1 Conducted Power

#### <GSM Conducted power>

Band GSM850	Burst Average Power (dBm)				Frame-Average Power (dBm)		
TX Channel	Tune-up limit (dBm)	128	190	251	128	190	251
Frequency (MHz)		824.2	836.6	848.8	824.2	836.6	848.6
<b>GSM</b>	33.00	32.59	31.94	32.13	23.56	22.91	23.10
<b>GPRS (GMSK, 1 Tx slot)</b>	33.00	32.68	32.51	32.27	23.65	23.48	23.24
<b>GPRS (GMSK, 2 Tx slots)</b>	30.00	28.88	29.24	29.78	22.86	23.22	23.76
<b>GPRS (GMSK, 3 Tx slots)</b>	28.00	27.30	27.72	27.38	23.04	23.46	23.12
<b>GPRS (GMSK, 4 Tx slots)</b>	27.00	26.77	26.81	26.12	23.76	<b>23.80</b>	23.11
Band PCS1900	Burst Average Power (dBm)				Frame-Average Power (dBm)		
TX Channel	Tune-up limit (dBm)	512	661	810	512	661	810
Frequency (MHz)		1850.2	1880.0	1909.8	1850.2	1880.0	1909.8
<b>GSM</b>	31.00	30.53	30.29	30.44	21.50	21.26	21.41
<b>GPRS (GMSK, 1 Tx slot)</b>	31.00	30.56	30.83	29.83	21.53	<b>21.80</b>	20.80
<b>GPRS (GMSK, 2 Tx slots)</b>	28.00	26.70	26.75	27.75	20.68	20.73	21.73
<b>GPRS (GMSK, 3 Tx slots)</b>	26.00	25.38	24.87	24.82	21.12	20.61	20.56
<b>GPRS (GMSK, 4 Tx slots)</b>	25.00	23.73	24.41	24.55	20.72	21.40	21.54

Remark: The frame-averaged power is linearly scaled the maximum burst averaged power over 8 time slots.  
The calculated method are shown as below:  
Frame-averaged power = Maximum burst averaged power (1 Tx Slot) – 9.03 dB  
Frame-averaged power = Maximum burst averaged power (2 Tx Slots) – 6.02 dB  
Frame-averaged power = Maximum burst averaged power (3 Tx Slots) - 4.26 dB  
Frame-averaged power = Maximum burst averaged power (4 Tx Slots) – 3.01 dB

#### Note:

1. Per KDB 447498 D01, the maximum output power channel is used for SAR testing and for further SAR test reduction
2. For Data mode SAR testing, GPRS should be evaluated, therefore the EUT was set in corresponding TX slots due to its highest frame-average power.

**<WCDMA Conducted Power>**

The following tests were conducted according to the test requirements outlines in 3GPP TS 34.121 specification. A summary of these settings is illustrated below:

**HSDPA Setup Configuration:**

- a. The EUT was connected to Base Station Agilent E5515C referred to the Setup Configuration.
- b. The RF path losses were compensated into the measurements.
- c. A call was established between EUT and Base Station with following setting:
  - i. Set Gain Factors ( $\beta_c$  and  $\beta_d$ ) and parameters were set according to each
  - ii. Specific sub-test in the following table, C10.1.4, quoted from the TS 34.121
  - iii. Set RMC 12.2Kbps + HSDPA mode.
  - iv. Set Cell Power = -86 dBm
  - v. Set HS-DSCH Configuration Type to FRC (H-set 1, QPSK)
  - vi. Select HSDPA Uplink Parameters
  - vii. Set Delta ACK, Delta NACK and Delta CQI = 8
  - viii. Set Ack-Nack Repetition Factor to 3
  - ix. Set CQI Feedback Cycle (k) to 4 ms
  - x. Set CQI Repetition Factor to 2
  - xi. Power Ctrl Mode = All Up bits
- d. The transmitted maximum output power was recorded.

**Table C.10.1.4:  $\beta$  values for transmitter characteristics tests with HS-DPCCH**

Sub-test	$\beta_c$	$\beta_d$	$\beta_d$ (SF)	$\beta_c/\beta_d$	$\beta_{hs}$ (Note 1, Note 2)	CM (dB) (Note 3)	MPR (dB) (Note 3)
1	2/15	15/15	64	2/15	4/15	0.0	0.0
2	12/15 (Note 4)	15/15 (Note 4)	64	12/15 (Note 4)	24/15	1.0	0.0
3	15/15	8/15	64	15/8	30/15	1.5	0.5
4	15/15	4/15	64	15/4	30/15	1.5	0.5

Note 1:  $\Delta_{ACK}$ ,  $\Delta_{NACK}$  and  $\Delta_{CQI} = 30/15$  with  $\beta_{hs} = 30/15 * \beta_c$ .

Note 2: For the HS-DPCCH power mask requirement test in clause 5.2C, 5.7A, and the Error Vector Magnitude (EVM) with HS-DPCCH test in clause 5.13.1A, and HSDPA EVM with phase discontinuity in clause 5.13.1AA,  $\Delta_{ACK}$  and  $\Delta_{NACK} = 30/15$  with  $\beta_{hs} = 30/15 * \beta_c$ , and  $\Delta_{CQI} = 24/15$  with  $\beta_{hs} = 24/15 * \beta_c$ .

Note 3: CM = 1 for  $\beta_c/\beta_d = 12/15$ ,  $\beta_{hs}/\beta_c = 24/15$ . For all other combinations of DPDCH, DPCCH and HS-DPCCH the MPR is based on the relative CM difference. This is applicable for only UEs that support HSDPA in release 6 and later releases.

Note 4: For subtest 2 the  $\beta_c/\beta_d$  ratio of 12/15 for the TFC during the measurement period (TF1, TF0) is achieved by setting the signalled gain factors for the reference TFC (TF1, TF1) to  $\beta_c = 11/15$  and  $\beta_d = 15/15$ .

**Setup Configuration**

**HSUPA Setup Configuration:**

- a. The EUT was connected to Base Station Agilent E5515C referred to the Setup Configuration.
- b. The RF path losses were compensated into the measurements.
- c. A call was established between EUT and Base Station with following setting \* :
  - i. Call Configs = 5.2B, 5.9B, 5.10B, and 5.13.2B with QPSK
  - ii. Set the Gain Factors ( $\beta_c$  and  $\beta_d$ ) and parameters (AG Index) were set according to each specific sub-test in the following table, C11.1.3, quoted from the TS 34.121
  - iii. Set Cell Power = -86 dBm
  - iv. Set Channel Type = 12.2k + HSPA
  - v. Set UE Target Power
  - vi. Power Ctrl Mode= Alternating bits
  - vii. Set and observe the E-TFCI
  - viii. Confirm that E-TFCI is equal to the target E-TFCI of 75 for sub-test 1, and other subtest's E-TFCI
- d. The transmitted maximum output power was recorded.

**Table C.11.1.3:  $\beta$  values for transmitter characteristics tests with HS-DPCCH and E-DCH**

Sub-test	$\beta_c$	$\beta_d$	$\beta_d$ (SF)	$\beta_c/\beta_d$	$\beta_{HS}$ (Note 1)	$\beta_{ec}$	$\beta_{ed}$ (Note 5) (Note 6)	$\beta_{ed}$ (SF)	$\beta_{ed}$ (Codes)	CM (dB) (Note 2)	MPR (dB) (Note 2)	AG Index (Note 6)	E-TFCI
1	11/15 (Note 3)	15/15 (Note 3)	64	11/15 (Note 3)	22/15	209/225	1309/225	4	1	1.0	0.0	20	75
2	6/15	15/15	64	6/15	12/15	12/15	94/75	4	1	3.0	2.0	12	67
3	15/15	9/15	64	15/9	30/15	30/15	$\beta_{ed1}: 47/15$ $\beta_{ed2}: 47/15$	4	2	2.0	1.0	15	92
4	2/15	15/15	64	2/15	4/15	2/15	56/75	4	1	3.0	2.0	17	71
5	15/15 (Note 4)	15/15 (Note 4)	64	15/15 (Note 4)	30/15	24/15	134/15	4	1	1.0	0.0	21	81

Note 1:  $\Delta_{ACK}, \Delta_{NACK}$  and  $\Delta_{CQI} = 30/15$  with  $\beta_{hs} = 30/15 * \beta_c$ .

Note 2: CM = 1 for  $\beta_c/\beta_d = 12/15, \beta_{hs}/\beta_c = 24/15$ . For all other combinations of DPDCH, DPCCH, HS-DPCCH, E-DPDCH and E-DPCCH the MPR is based on the relative CM difference.

Note 3: For subtest 1 the  $\beta_c/\beta_d$  ratio of 11/15 for the TFC during the measurement period (TF1, TF0) is achieved by setting the signalled gain factors for the reference TFC (TF1, TF1) to  $\beta_c = 10/15$  and  $\beta_d = 15/15$ .

Note 4: For subtest 5 the  $\beta_c/\beta_d$  ratio of 15/15 for the TFC during the measurement period (TF1, TF0) is achieved by setting the signalled gain factors for the reference TFC (TF1, TF1) to  $\beta_c = 14/15$  and  $\beta_d = 15/15$ .

Note 5: In case of testing by UE using E-DPDCH Physical Layer category 1, Sub-test 3 is omitted according to TS25.306 Table 5.1g.

Note 6:  $\beta_{ed}$  can not be set directly, it is set by Absolute Grant Value.

**Setup Configuration**



## &lt;WCDMA Conducted Power&gt;

WCDMA	Band II (dBm)			Band IV (dBm)			Band V (dBm)					
TX Channel	Tune-up	9262	9400	9538	Tune-up	1312	1412	1513	Tune-up	4132	4183	4233
Frequency (MHz)	limit (dBm)	1852.4	1880.0	1907.6	limit (dBm)	1712.4	1732.6	1752.6	limit (dBm)	826.4	836.6	846.6
RMC 12.2Kbps	24.00	22.91	23.46	23.05	24.00	23.04	23.09	23.10	24.00	23.32	23.55	23.44
RMC AMR	24.00	22.98	23.47	23.74	24.00	22.84	22.92	23.11	24.00	23.72	23.04	22.81
HSDPA Subtest-1	23.00	22.02	22.68	22.48	23.00	22.00	21.71	22.64	23.00	22.28	22.22	22.28
HSDPA Subtest-2	22.00	21.14	21.25	21.35	22.00	21.36	21.71	21.28	22.00	21.79	21.84	21.35
HSDPA Subtest-3	22.00	21.67	21.42	21.26	22.00	21.85	20.96	21.44	22.00	21.52	21.54	21.70
HSDPA Subtest-4	21.00	19.97	20.58	20.30	21.00	20.77	20.67	20.76	21.00	20.01	20.75	20.04
HSUPA Subtest-1	23.00	21.79	22.44	21.75	23.00	22.18	22.81	21.71	23.00	22.81	22.08	22.56
HSUPA Subtest-2	22.00	21.79	21.45	21.67	22.00	21.00	20.95	21.14	22.00	21.03	21.70	20.95
HSUPA Subtest-3	22.00	20.94	20.75	21.53	22.00	21.30	21.52	21.15	22.00	20.86	21.41	21.54
HSUPA Subtest-4	21.00	19.76	19.72	19.81	21.00	20.06	20.48	20.20	21.00	20.38	20.07	19.77
HSUPA Subtest-5	21.00	20.80	20.80	20.82	21.00	20.51	20.56	20.21	21.00	20.19	20.45	20.50

**General Note**

- Per KDB 941225 D01 v02, RMC 12.2kbps setting is used to evaluate SAR as primary mode. When the maximum output power and tune-up tolerance specified for production units in a secondary mode is  $\leq \frac{1}{4}$  dB higher than the primary mode or when the highest reported SAR of the primary mode is scaled by the ratio of specified maximum output power and tune-up tolerance of secondary to primary mode and the adjusted SAR is  $\leq 1.2$  W/kg, SAR measurement is not required for the secondary mode.
- It is expected by the manufacturer that MPR for some HSDPA/HSUPA subtests may differ from the specification of 3GPP, according to the chipset implementation in this model. The implementation and expected deviation are detailed in tune-up procedure exhibit.

## &lt;WLAN 2.4GHz Conducted Power&gt;

Mode	Channel	Frequency (MHz)	Conducted Peak Output Power(dBm)	Conducted Average Output Power(dBm)	Tune-up limit (dBm)
802.11b	1	2412	14.85	13.29	13.5
	6	2437	14.14	12.59	13.0
	11	2462	14.20	12.62	13.0
802.11g	1	2412	12.82	9.36	11.0
	6	2437	15.44	11.86	12.0
	11	2462	15.20	11.74	12.0
802.11n(HT20)	1	2412	13.02	9.17	11.0
	6	2437	15.36	11.69	12.0
	11	2462	15.17	11.62	12.0
802.11n(HT40)	3	2422	14.37	10.78	11.0
	6	2437	15.03	11.09	12.0
	9	2452	15.50	11.69	12.0

## &lt;Bluetooth Conducted Power&gt;

Mode	Channel	Frequency (MHz)	Conducted Peak Output Power(dBm)	Tune-up limit (dBm)
GFSK	0	2402	-0.54	1.0
	39	2441	-0.21	1.0
	78	2480	0.35	1.0
$\pi/4$ DQPSK	0	2402	-1.99	-1.0
	39	2441	-1.60	-1.0
	78	2480	-1.01	-1.0
8DPSK	0	2402	-1.38	-1.0
	39	2441	-1.07	-1.0
	78	2480	-0.41	-1.0
BLE 1M	0	2402	-3.08	-2.0
	19	2440	-2.63	-2.0
	39	2480	-2.05	-2.0

### 10.2 Transmit Antennas and SAR Measurement Position

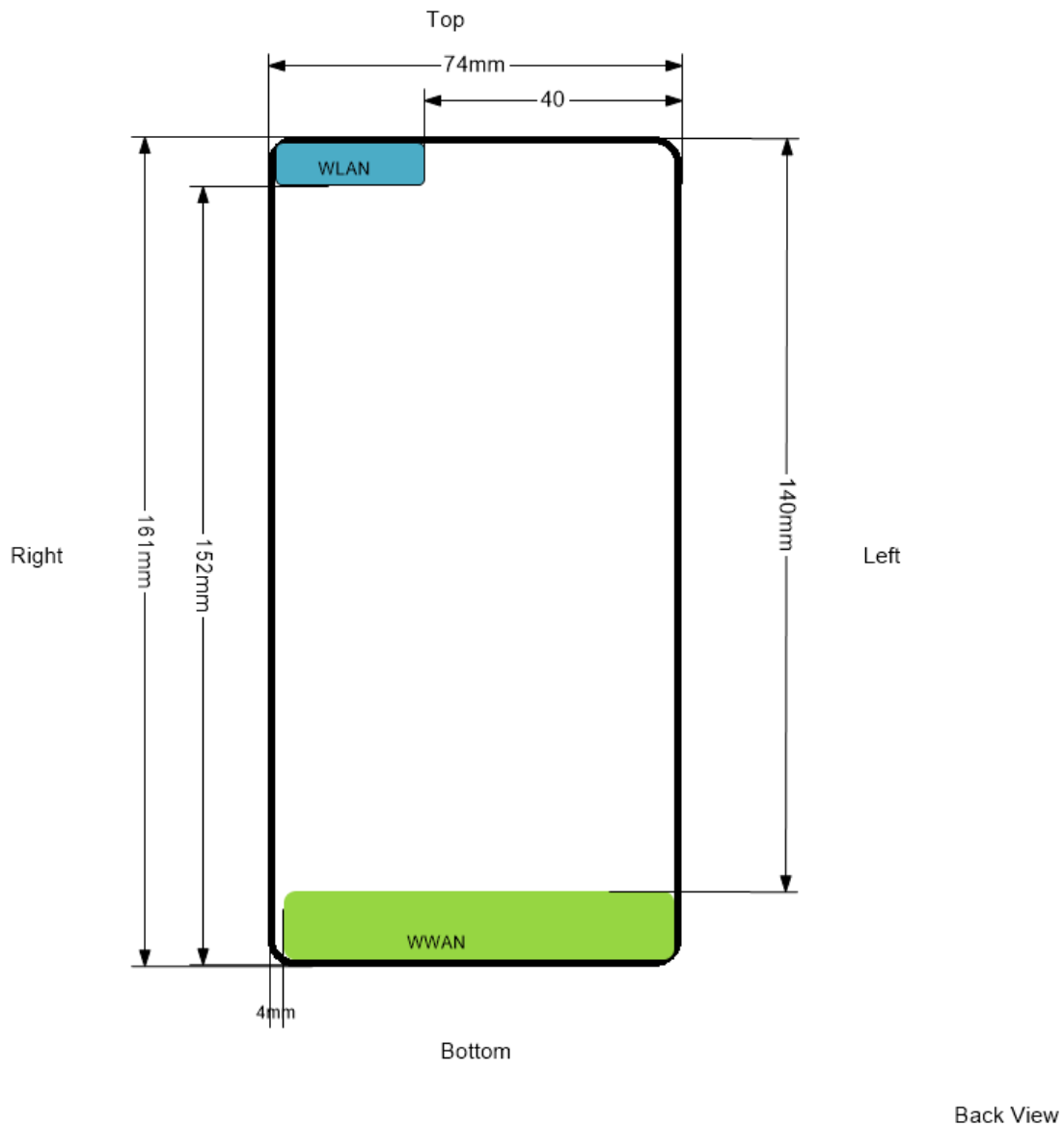

Distance of The Antenna to the EUT surface and edge						
Antennas	Front	Back	Top Side	Bottom Side	Left Side	Right Side
WWAN	<25mm	<25mm	140mm	0 mm	0 mm	4mm
WLAN	<25mm	<25mm	0mm	152mm	40mm	0mm

Positions for SAR tests; Hotspot mode						
Antennas	Front	Back	Top Side	Bottom Side	Left Side	Right Side
WWAN	Yes	Yes	No	Yes	Yes	Yes
WLAN	Yes	Yes	Yes	No	No	Yes

**Note:**

1). According to the KDB941225 D06 Hot Spot SAR v02, the edges with less than 2.5 cm distance to the antennas need to be tested for SAR.

### 10.3 SAR Test Exclusion and Estimated SAR

#### SAR Test Exclusion Considerations

Per KDB 447498 D01v06, the 1-g and 10-g SAR test exclusion thresholds for 100 MHz to 6 GHz at test separation distances  $\leq 50$  mm are determined by:

$[(\text{max. power of channel, including tune-up tolerance, mW}) / (\text{min. test separation distance, mm})] \cdot [\sqrt{f(\text{GHz})}] \leq 3.0$  for 1-g SAR and  $\leq 7.5$  for 10-g extremity SAR

- f(GHz) is the RF channel transmit frequency in GHz.
- Power and distance are rounded to the nearest mW and mm before calculation.
- The result is rounded to one decimal place for comparison.

Per KDB 447498 D01v06, at 100 MHz to 6 GHz and for test separation distances  $> 50$  mm, the SAR test exclusion threshold is determined according to the following:

- [Threshold at 50mm)+(test separation distance-50mm)\*(f(MHz)/150)]mW, at 100MHz to 1500MHz
- [Threshold at 50mm)+(test separation distance-50mm)\*10]mW at  $> 1500$ MHz and  $\leq 6$ GHz

#### Estimated SAR

Per KDB447498 requires when the standalone SAR test exclusion of section 4.3.1 is applied to an antenna that transmits simultaneously with other antennas, the standalone SAR must be estimated according to the following to determine simultaneous transmission SAR test exclusion;

- $(\text{max. power of channel, including tune-up tolerance, mW}) / (\text{min. test separation distance, mm}) \cdot [\sqrt{f(\text{GHz})/x}]$  W/kg for test separation distances  $\leq 50$  mm; where  $x = 7.5$  for 1-g SAR, and  $x = 18.75$  for 10-g SAR.
- 0.4 W/kg for 1-g SAR and 1.0 W/kg for 10-g SAR, when the test separation distances is  $> 50$  mm

The below table, exemption limits for routine evaluation based on frequency and separation distance was according to SAR-based Exemption – §1.1307(b)(3)(i)(B).

Standalone SAR Test Exclusion and Estimated SAR									
Wireless Interface	Frequency (MHz)	Configuration	Max. Power With tune-up		Distance (mm)	Calculation Result	SAR Exclusion Thresholds	Standalone SAR Exclusion	Estimated SAR (W/Kg)
			dBm	mW					
Bluetooth	2450	Head	1.0	1.259	5	0.3	3	Yes	0.053
Bluetooth	2450	Body& Hotspot	1.0	1.259	10	0.2	3	Yes	0.026

**Remark:**

1. Maximum average power including tune-up tolerance;
2. When the minimum test separation distance is  $< 5$  mm, a distance of 5 mm is applied to determine SAR test exclusion
3. when the distance is  $< 50$  mm exclusion threshold is "Ratio", when the distance is  $> 50$  mm exclusion threshold is "mW".

## 10.4 SAR Test Results Summary

### General Note:

- 1 Per KDB 447498 D01v06, the reported SAR is the measured SAR value adjusted for maximum tune-up tolerance.
  - c) Tune-up scaling Factor = tune-up limit power (mW) / EUT RF power (mW), where tune-up limit is the maximum rated power among all production units.
  - d) For SAR testing of WLAN signal with non-100% duty cycle, the measured SAR is scaled-up by the duty cycle scaling factor which is equal to "1/(duty cycle)"
  - e) For WLAN/Bluetooth: Reported SAR(W/kg)= Measured SAR(W/kg)\* Duty Cycle scaling factor \* Tune-up scaling factor
- 2 Per KDB 447498 D01v06, for each exposure position, testing of other required channels within the operating mode of a frequency band is not required when the reported 1-g or 10-g SAR for the mid-band or highest output power channel is:
  - $\leq 0.8$  W/kg or 2.0 W/kg, for 1-g or 10-g respectively, when the transmission band is  $\leq 100$  MHz
  - $\leq 0.6$  W/kg or 1.5 W/kg, for 1-g or 10-g respectively, when the transmission band is between 100 MHz and 200 MHz
  - $\leq 0.4$  W/kg or 1.0 W/kg, for 1-g or 10-g respectively, when the transmission band is  $\geq 200$  MHz
- 3 Per KDB 865664 D01v01r04, for each frequency band, repeated SAR measurement is required only when the measured SAR is  $\geq 0.8$ W/kg.

## SAR Results

## &lt;Head SAR&gt;

## SAR Values GSM

Plot No.	Mode	Test Position	Ch.	Freq. (MHz)	Average Power (dBm)	Tune-Up Limit (dBm)	Scaling Factor	Power Drift (dB)	Measured SAR <sub>1g</sub> (W/kg)	Reported SAR <sub>1g</sub> (W/kg)
<b>GSM 850</b>										
	GSM Voice	Left Cheek	128	824.2	32.59	33	1.099	0.06	0.492	0.541
	GSM Voice	Left Tilt	128	824.2	32.59	33	1.099	0.07	0.336	0.369
#1	GSM Voice	Right Cheek	128	824.2	32.59	33	1.099	0.06	<b>0.502</b>	<b>0.552</b>
	GSM Voice	Right Tilt	128	824.2	32.59	33	1.099	-0.09	0.401	0.441
<b>GSM 1900</b>										
	GSM Voice	Left Cheek	512	1850.2	30.53	31	1.114	-0.09	0.347	0.387
	GSM Voice	Left Tilt	512	1850.2	30.53	31	1.114	0.07	0.296	0.330
#2	GSM Voice	Right Cheek	512	1850.2	30.53	31	1.114	-0.03	<b>0.355</b>	<b>0.396</b>
	GSM Voice	Right Tilt	512	1850.2	30.53	31	1.114	0.13	0.311	0.347

## SAR Values for WCDMA

Plot No.	Mode	Test Position	Ch.	Freq. (MHz)	Average Power (dBm)	Tune-Up Limit (dBm)	Scaling Factor	Power Drift (dB)	Measured SAR <sub>1g</sub> (W/kg)	Reported SAR <sub>1g</sub> (W/kg)
<b>WCDMA Band II</b>										
	RMC 12.2Kbps	Left Cheek	9400	1880	23.46	24	1.132	-0.01	0.191	0.216
	RMC 12.2Kbps	Left Tilt	9400	1880	23.46	24	1.132	0.05	0.040	0.045
#3	RMC 12.2Kbps	Right Cheek	9400	1880	23.46	24	1.132	-0.04	<b>0.205</b>	<b>0.232</b>
	RMC 12.2Kbps	Right Tilt	9400	1880	23.46	24	1.132	-0.10	0.103	0.117
<b>WCDMA Band IV</b>										
	RMC 12.2Kbps	Left Cheek	1513	1752.6	23.10	24	1.230	0.09	0.284	0.349
	RMC 12.2Kbps	Left Tilt	1513	1752.6	23.10	24	1.230	0.10	0.129	0.159
#4	RMC 12.2Kbps	Right Cheek	1513	1752.6	23.10	24	1.230	-0.03	<b>0.292</b>	<b>0.359</b>
	RMC 12.2Kbps	Right Tilt	1513	1752.6	23.10	24	1.230	-0.13	0.190	0.234
<b>WCDMA Band V</b>										
	RMC 12.2Kbps	Left Cheek	4183	836.6	23.55	24	1.109	-0.11	0.295	0.327
	RMC 12.2Kbps	Left Tilt	4183	836.6	23.55	24	1.109	0.02	0.133	0.148
#5	RMC 12.2Kbps	Right Cheek	4183	836.6	23.55	24	1.109	0.11	<b>0.301</b>	<b>0.334</b>
	RMC 12.2Kbps	Right Tilt	4183	836.6	23.55	24	1.109	-0.11	0.203	0.225

## SAR Values for WIFI 2.4G

Plot No.	Mode	Test Position	Ch.	Freq. (MHz)	Average Power (dBm)	Tune-Up Limit (dBm)	Scaling Factor	Power Drift (dB)	Measured SAR <sub>1g</sub> (W/kg)	Reported SAR <sub>1g</sub> (W/kg)
#6	802.11b	Left Cheek	01	2412	13.29	13.5	1.050	-0.05	<b>0.414</b>	<b>0.435</b>
	802.11b	Left Tilt	01	2412	13.29	13.5	1.050	0.07	0.355	0.373
	802.11b	Right Cheek	01	2412	13.29	13.5	1.050	-0.13	0.408	0.428
	802.11b	Right Tilt	01	2412	13.29	13.5	1.050	0.05	0.346	0.363

Note: Per KDB 248227 D01v02r02, for 2.4GHz 802.11g/n SAR testing is not required when the highest reported SAR for DSSS is adjusted by the ratio of OFDM to DSSS specified maximum output power and the adjusted SAR is  $\leq 1.2$  W/kg.



## &lt;Body &amp; Hotspot SAR&gt;

## SAR Values [GSM 850]

Plot No.	Mode	Test Position	Ch.	Freq. (MHz)	Average Power (dBm)	Tune-Up Limit (dBm)	Scaling Factor	Power Drift (dB)	Measured SAR <sub>1g</sub> (W/kg)	Reported SAR <sub>1g</sub> (W/kg)
<b>Measured / Reported SAR numbers-Body&amp; hotspot open distance 10mm</b>										
	GPRS 4Tx slots	Front	190	836.6	26.81	27.00	1.045	-0.07	0.541	0.565
#7	GPRS 4Tx slots	Back	190	836.6	26.81	27.00	1.045	0.12	<b>0.721</b>	<b>0.753</b>
	GPRS 4Tx slots	Left Edge	190	836.6	26.81	27.00	1.045	0.05	0.605	0.632
	GPRS 4Tx slots	Right Edge	190	836.6	26.81	27.00	1.045	-0.10	0.512	0.535
	GPRS 4Tx slots	Bottom Edge	190	836.6	26.81	27.00	1.045	0.03	0.714	0.746

## SAR Values [PCS 1900]

Plot No.	Mode	Test Position	Ch.	Freq. (MHz)	Average Power (dBm)	Tune-Up Limit (dBm)	Scaling Factor	Power Drift (dB)	Measured SAR <sub>1g</sub> (W/kg)	Reported SAR <sub>1g</sub> (W/kg)
<b>Measured / Reported SAR numbers-Body&amp; hotspot open distance 10mm</b>										
	GPRS 1Tx slots	Front	661	1880.0	30.83	31.00	1.040	-0.10	0.501	0.521
	GPRS 1Tx slots	Back	661	1880.0	30.83	31.00	1.040	0.07	0.679	0.706
	GPRS 1Tx slots	Left Edge	661	1880.0	30.83	31.00	1.040	0.03	0.574	0.597
	GPRS 1Tx slots	Right Edge	661	1880.0	30.83	31.00	1.040	0.05	0.477	0.496
#8	GPRS 1Tx slots	Bottom Edge	661	1880.0	30.83	31.00	1.040	-0.02	<b>0.685</b>	<b>0.712</b>

## SAR Values [WCDMA II]

Plot No.	Mode	Test Position	Ch.	Freq. (MHz)	Average Power (dBm)	Tune-Up Limit (dBm)	Scaling Factor	Power Drift (dB)	Measured SAR <sub>1g</sub> (W/kg)	Reported SAR <sub>1g</sub> (W/kg)
<b>Measured / Reported SAR numbers-Body&amp; hotspot open distance 10mm</b>										
	RMC 12.2Kbps	Front	9400	1880	23.46	24	1.132	0.05	0.432	0.489
#9	RMC 12.2Kbps	Back	9400	1880	23.46	24	1.132	0.08	<b>0.612</b>	<b>0.693</b>
	RMC 12.2Kbps	Left Edge	9400	1880	23.46	24	1.132	-0.07	0.499	0.565
	RMC 12.2Kbps	Right Edge	9400	1880	23.46	24	1.132	0.11	0.406	0.460
	RMC 12.2Kbps	Bottom Edge	9400	1880	23.46	24	1.132	-0.09	0.603	0.683



## SAR Values [WCDMA IV]

Plot No.	Mode	Test Position	Ch.	Freq. (MHz)	Average Power (dBm)	Tune-Up Limit (dBm)	Scaling Factor	Power Drift (dB)	Measured SAR <sub>1g</sub> (W/kg)	Reported SAR <sub>1g</sub> (W/kg)
<b>Measured / Reported SAR numbers-Body&amp; hotspot open distance 10mm</b>										
	RMC 12.2Kbps	Front	1513	1752.6	23.10	24	1.230	0.04	0.632	0.778
	RMC 12.2Kbps	Back	1513	1752.6	23.10	24	1.230	0.05	0.809	0.995
	RMC 12.2Kbps	Left Edge	1513	1752.6	23.10	24	1.230	-0.06	0.698	0.859
	RMC 12.2Kbps	Right Edge	1513	1752.6	23.10	24	1.230	0.11	0.602	0.741
#10	RMC 12.2Kbps	Bottom Edge	1513	1752.6	23.10	24	1.230	0.03	<b>0.811</b>	<b>0.998</b>
	RMC 12.2Kbps	Back	1312	1712.4	23.04	24	1.247	-0.03	0.791	0.987
	RMC 12.2Kbps	Left Edge	1312	1712.4	23.04	24	1.247	0.05	0.688	0.858
	RMC 12.2Kbps	Bottom Edge	1312	1712.4	23.04	24	1.247	-0.06	0.795	0.992
	RMC 12.2Kbps	Back	1412	1732.6	23.09	24	1.233	0.07	0.801	0.988
	RMC 12.2Kbps	Left Edge	1412	1732.6	23.09	24	1.233	-0.11	0.694	0.856
	RMC 12.2Kbps	Bottom Edge	1412	1732.6	23.09	24	1.233	0.10	0.805	0.993

## SAR Values [WCDMA V]

Plot No.	Mode	Test Position	Ch.	Freq. (MHz)	Average Power (dBm)	Tune-Up Limit (dBm)	Scaling Factor	Power Drift (dB)	Measured SAR <sub>1g</sub> (W/kg)	Reported SAR <sub>1g</sub> (W/kg)
<b>Measured / Reported SAR numbers-Body&amp; hotspot open distance 10mm</b>										
	RMC 12.2Kbps	Front	4183	836.6	23.55	24	1.109	-0.03	0.463	0.514
#11	RMC 12.2Kbps	Back	4183	836.6	23.55	24	1.109	0.07	<b>0.648</b>	<b>0.719</b>
	RMC 12.2Kbps	Left Edge	4183	836.6	23.55	24	1.109	-0.06	0.528	0.586
	RMC 12.2Kbps	Right Edge	4183	836.6	23.55	24	1.109	-0.05	0.438	0.486
	RMC 12.2Kbps	Bottom Edge	4183	836.6	23.55	24	1.109	0.03	0.640	0.710

## SAR Values [WIFI 2.4G]

Plot No.	Mode	Test Position	Ch.	Freq. (MHz)	Average Power (dBm)	Tune-Up Limit (dBm)	Scaling Factor	Power Drift (dB)	Measured SAR <sub>1g</sub> (W/kg)	Reported SAR <sub>1g</sub> (W/kg)
<b>Measured / Reported SAR numbers-Body&amp; hotspot open distance 10mm</b>										
	802.11b	Front Side	01	2412	13.29	13.5	1.050	-0.11	0.102	0.107
#12	802.11b	Back Side	01	2412	13.29	13.5	1.050	-0.07	<b>0.281</b>	<b>0.295</b>
	802.11b	Right Edge	01	2412	13.29	13.5	1.050	0.09	0.183	0.192
	802.11b	Top Edge	01	2412	13.29	13.5	1.050	0.04	0.271	0.284

## 10.5 SAR Measurement Variability

SAR measurement variability must be assessed for each frequency band, which is determined by the SAR probe calibration point and tissue-equivalent medium used for the device measurements. When both head and body tissue-equivalent media are required for SAR measurements in a frequency band, the variability measurement procedures should be applied to the tissue medium with the highest measured SAR, using the highest measured SAR configuration for that tissue-equivalent medium. The following procedures are applied to determine if repeated measurements are required.

- 1 Repeated measurement is not required when the original highest measured SAR is  $< 0.80$  W/kg; steps 2) through 4) do not apply.
- 2 When the original highest measured SAR is  $\geq 0.80$  W/kg, repeat that measurement once.
- 3 Perform a second repeated measurement only if the ratio of largest to smallest SAR for the original and first repeated measurements is  $> 1.20$  or when the original or repeated measurement is  $\geq 1.45$  W/kg (~ 10% from the 1-g SAR limit).
- 4 Perform a third repeated measurement only if the original, first or second repeated measurement is  $\geq 1.5$  W/kg and the ratio of largest to smallest SAR for the original, first and second repeated measurements is  $> 1.20$ .

**SAR Measurement Variability**

Band	Mode	Test Position	Ch.	Spacing (mm)	Original SAR (W/kg)	First Repeated SAR (W/kg)	The Ratio	Second Repeated SAR (W/kg)
WCDMA IV	RMC 12.2Kbps	Back	1513	10	0.809	0.796	1.016	N/A
	RMC 12.2Kbps	Bottom Edge	1513	10	0.811	0.798	1.017	N/A
	RMC 12.2Kbps	Back	1412	10	0.801	0.772	1.037	N/A
	RMC 12.2Kbps	Bottom Edge	1412	10	0.801	0.805	1.005	N/A

## 10.6 Simultaneous Transmission Analysis

Per FCC KD B447498 D01, simultaneous transmission SAR test exclusion may be applied when the sum of the 1-g SAR for all the transmitting antenna in a specific a physical test configuration is  $\leq 1.6$  W/Kg. When the sum is greater than the SAR limit, SAR test exclusion is determined by the SAR to peak location separation ratio.

$$\text{Ratio} = \frac{(\text{SAR}_1 + \text{SAR}_2)^{1.5}}{(\text{peak location separation, mm})} < 0.04$$

The following procedures adopted from “FCC SAR Considerations for Cell Phones with Multiple Transmitters” are applicable to handsets with built-in unlicensed transmitters such as 802.11 a/b/g/n and Bluetooth devices which may simultaneously transmit with the licensed transmitter.

Application Simultaneous Transmission information:

No.	Simultaneous Transmission Configurations	Portable Handset		
		Head	Body-worn	Hotspot
1	WWAN (2/3G) + WLAN 2.4GHz	Yes	Yes	Yes
2	WWAN (2/3G) + Bluetooth	Yes	Yes	Yes

Note: WLAN2.4G and BT share the same antenna and cannot transmitting at the same time.

## 10.8.2 Evaluation of Simultaneous SAR

### Head Simultaneous transmission SAR for WLAN/BT and GSM/WCDMA

Exposure Position	1	2	3	1+2 Summed 1g SAR (W/kg)	1+3 Summed 1g SAR (W/kg)	SPLSR
	MAX. WWAN Reported SAR	MAX. WLAN2.4G Reported SAR	Bluetooth			
	1g SAR (W/kg)	1g SAR (W/kg)	1g SAR (W/kg)			
Left Cheek	0.541	0.435	0.053	0.976	0.594	N/A
Left Tilt	0.369	0.373	0.053	0.742	0.422	N/A
Right Cheek	0.552	0.428	0.053	0.980	0.605	N/A
Right Tilt	0.441	0.363	0.053	0.804	0.494	N/A

MAX.  $\Sigma \text{SAR}_{1g} = 0.980$  W/kg  $< 1.6$  W/kg, so the Simultaneous transmission SAR with volume scan are not required.

**Body-worn and hotspot Simultaneous transmission SAR for WLAN/BT and GSM/WCDMA**

Exposure Position	1	2	3	1+2 Summed 1g SAR (W/kg)	1+3 Summed 1g SAR (W/kg)	SPLSR
	MAX. WWAN Reported SAR	MAX. WLAN2.4G Reported SAR	Bluetooth			
	1g SAR (W/kg)	1g SAR (W/kg)	1g SAR (W/kg)			
Front Side	0.778	0.107	0.026	0.885	0.804	N/A
Rear Side	0.995	0.295	0.026	1.290	1.021	N/A
Left Edge	0.859	N/A	0.026	0.859	0.885	N/A
Right Edge	0.741	0.192	0.026	0.933	0.767	N/A
Top Side	N/A	0.284	0.026	0.284	0.026	N/A
Bottom Edge	0.998	N/A	0.026	0.998	1.024	N/A

MAX.  $\Sigma SAR_{1g} = 1.290$  W/kg < 1.6 W/kg, so the Simultaneous transmission SAR with volume scan are not required.

## 11 Measurement Uncertainty

NO	Source	Uncert. ai (%)	Prob. Dist.	Div. k	ci (1g)	ci (10g)	Stand.U ncert. ui (1g)	Stand.U ncert. ui (10g)	Veff
1	Repeat	0.4	N	1	1	1	0.4	0.4	9
<b>Instrument</b>									
2	Probe calibration	7	N	2	1	1	3.5	3.5	$\infty$
3	Axial isotropy	4.7	R	$\sqrt{3}$	0.7	0.7	1.9	1.9	$\infty$
4	Hemispherical isotropy	9.4	R	$\sqrt{3}$	0.7	0.7	3.9	3.9	$\infty$
5	Boundary effect	1.0	R	$\sqrt{3}$	1	1	0.6	0.6	$\infty$
6	Linearity	4.7	R	$\sqrt{3}$	1	1	2.7	2.7	$\infty$
7	Detection limits	1.0	R	$\sqrt{3}$	1	1	0.6	0.6	$\infty$
8	Readout electronics	0.3	N	1	1	1	0.3	0.3	$\infty$
9	Response time	0.8	R	$\sqrt{3}$	1	1	0.5	0.5	$\infty$
10	Integration time	2.6	R	$\sqrt{3}$	1	1	1.5	1.5	$\infty$
11	Ambient noise	3.0	R	$\sqrt{3}$	1	1	1.7	1.7	$\infty$
12	Ambient reflections	3.0	R	$\sqrt{3}$	1	1	1.7	1.7	$\infty$
13	Probe positioner mech. restrictions	0.4	R	$\sqrt{3}$	1	1	0.2	0.2	$\infty$
14	Probe positioning with respect to phantom shell	2.9	R	$\sqrt{3}$	1	1	1.7	1.7	$\infty$
15	Max.SAR evaluation	1.0	R	$\sqrt{3}$	1	1	0.6	0.6	$\infty$

Test sample related									
16	Device positioning	3.8	N	1	1	1	3.8	3.8	99
17	Device holder	5.1	N	1	1	1	5.1	5.1	5
18	Drift of output power	5.0	R	$\frac{1}{\sqrt{3}}$	1	1	2.9	2.9	$\infty$
Phantom and set-up									
19	Phantom uncertainty	4.0	R	$\frac{1}{\sqrt{3}}$	1	1	2.3	2.3	$\infty$
20	Liquid conductivity (target)	5.0	R	$\frac{1}{\sqrt{3}}$	0.64	0.43	1.8	1.2	$\infty$
21	Liquid conductivity (meas)	2.5	N	1	0.64	0.43	1.6	1.2	$\infty$
22	Liquid Permittivity (target)	5.0	R	$\frac{1}{\sqrt{3}}$	0.6	0.49	1.7	1.5	$\infty$
23	Liquid Permittivity (meas)	2.5	N	1	0.6	0.49	1.5	1.2	$\infty$
<b>Combined standard</b>			RSS	$u_c = \sqrt{\sum_{i=1}^n C_i^2 U_i^2}$			11.4%	11.3%	236
<b>Expanded uncertainty(P=95%)</b>		$U = k U_c$					<b>22.8%</b>	<b>22.6%</b>	



### Appendix A. EUT Photos and Test Setup Photos

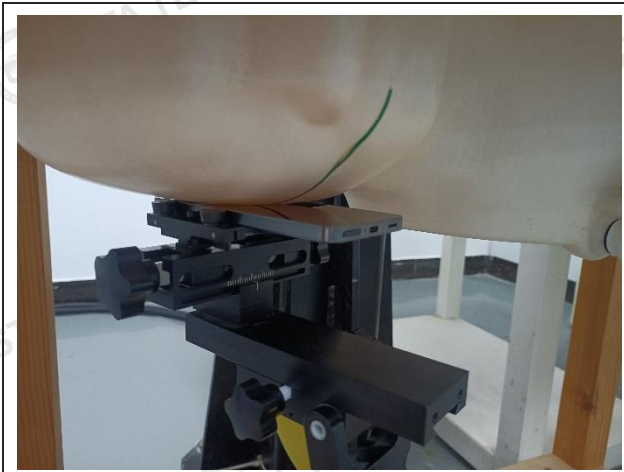

Right Head Cheek

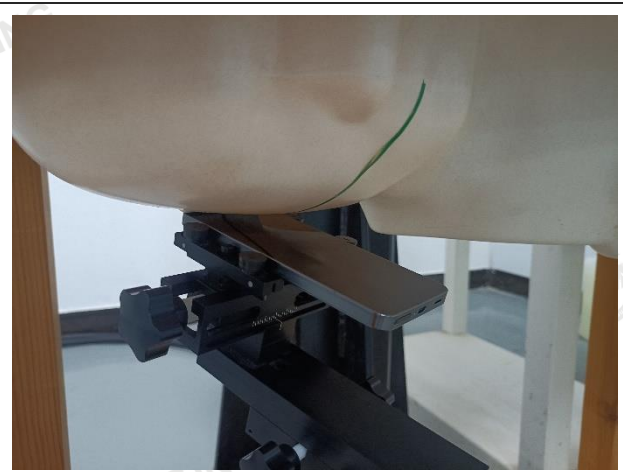

Right Head Tilted

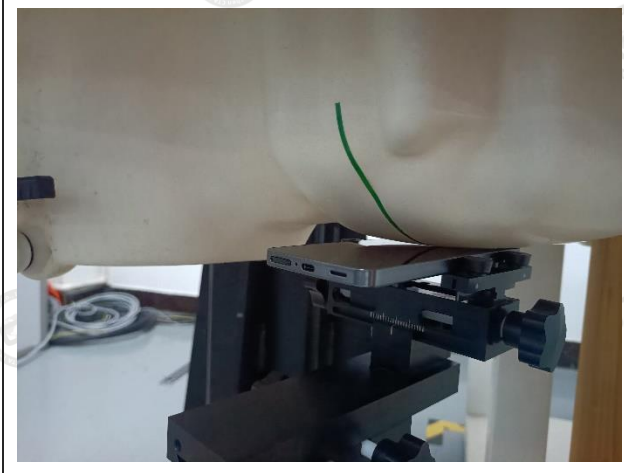

Left Head Cheek

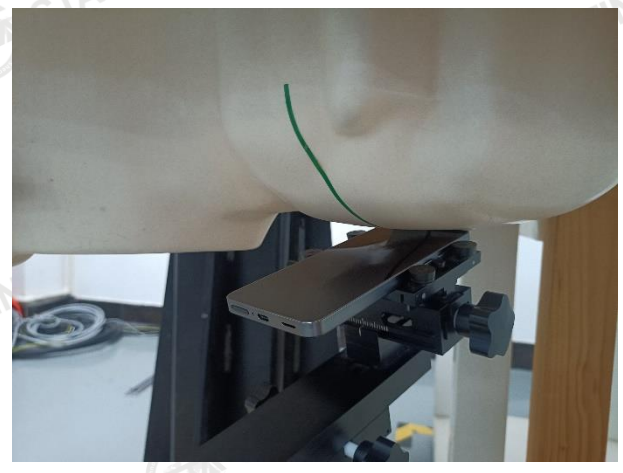

Left Head Tilted



Front Side (10mm)



Rear Side (10mm)



Left Side (10mm)



Right Side (10mm)



Top Side (10mm)



Bottom Side (10mm)

## Appendix B. Plots of SAR System Check

### 835MHz System Check

Date: 05/21/2024

**DUT: Dipole 835 MHz; Type: D835V2; Serial: 484**

Communication System: CW; Frequency: 835 MHz; Duty Cycle: 1:1

Medium parameters used (interpolated):  $f = 835 \text{ MHz}$ ;  $\sigma = 0.869 \text{ S/m}$ ;  $\epsilon_r = 43.081$ ;  $\rho = 1000 \text{ kg/m}^3$

Phantom section: Flat Section

#### DASY5 Configuration:

- Probe: EX3DV4 – SN7380; ConvF(9.62, 9.62, 9.62); Calibrated: June 21, 2023;
- Sensor-Surface: 3mm (Mechanical Surface Detection)
- Electronics: DAE3 Sn428; Calibrated: Aug.30,2023;
- Phantom: Twin-SAM V8.0 ; Type: QD 000 P41 AA; Serial: 1974;
- DASY52 52.10.2(1495); SEMCAD X 14.6.12(7450)

**Area Scan (61x61x1):** Interpolated grid:  $dx=1.500 \text{ mm}$ ,  $dy=1.500 \text{ mm}$

Maximum value of SAR (interpolated) = 3.47 W/kg

**Zoom Scan (5x5x7)/Cube 0:** Measurement grid:  $dx=8\text{mm}$ ,  $dy=8\text{mm}$ ,  $dz=5\text{mm}$

Reference Value = 61.23 V/m; Power Drift = 0.03 dB

Peak SAR (extrapolated) = 4.16 W/kg

**SAR(1 g) = 2.37 W/kg; SAR(10 g) = 1.89 W/kg**

Maximum value of SAR (measured) = 3.52 W/kg

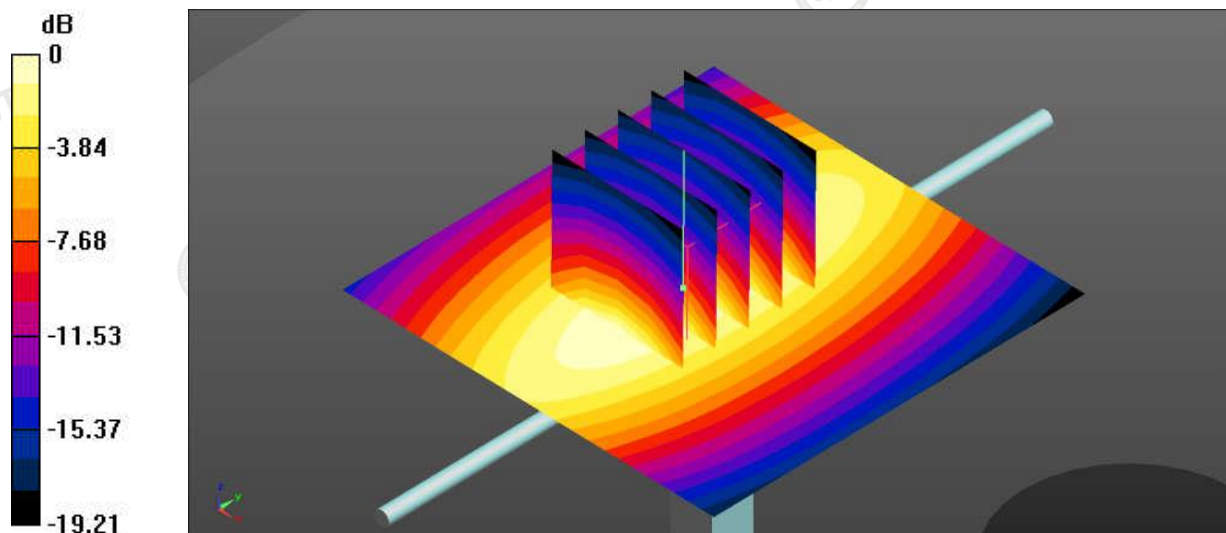

0 dB = 3.52 W/kg

System Performance Check 835MHz 250mW



**1750 MHz System Check**

Date: 05/22/2024

**DUT: Dipole 1800 MHz; Type: D1800V2; Serial: 2d158**

Communication System: CW; Frequency: 1750 MHz; Duty Cycle: 1:1

Medium parameters used (interpolated):  $f = 1750$  MHz;  $\sigma = 1.335$  S/m;  $\epsilon_r = 38.203$ ;  $\rho = 1000$  kg/m<sup>3</sup>

Phantom section: Flat Section

**DASY5 Configuration:**

- Probe: EX3DV4 – SN7380; ConvF(8.35, 8.35, 8.35); Calibrated: June 21, 2023;
- Sensor-Surface: 3mm (Mechanical Surface Detection)
- Electronics: DAE3 Sn428; Calibrated: Aug.30,2023;
- Phantom: Twin-SAM V8.0 ; Type: QD 000 P41 AA; Serial: 1974;
- DASY52 52.10.2(1495); SEMCAD X 14.6.12(7450)

**Area Scan (61x61x1):** Interpolated grid: dx=1.500 mm, dy=1.500 mm

Maximum value of SAR (interpolated) = 16.1 W/kg

**Zoom Scan (5x5x7)/Cube 0:** Measurement grid: dx=8mm, dy=8mm, dz=5mm

Reference Value = 90.23 V/m; Power Drift = -0.03 dB

Peak SAR (extrapolated) = 19.6 W/kg

**SAR(1 g) = 9.32 W/kg; SAR(10 g) = 5.08 W/kg**

Maximum value of SAR (measured) = 16.0 W/kg

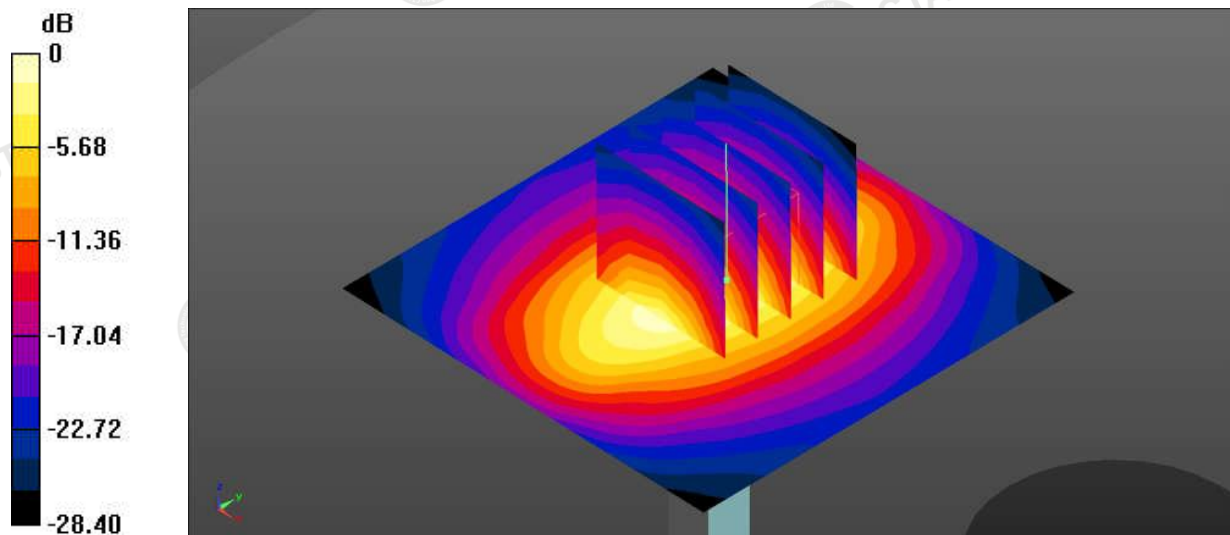

0 dB = 16.0 W/kg

System Performance Check 1750MHz 250mW

### 1900MHz System Check

Date: 05/23/2024

**DUT: Dipole 1900 MHz; Type: D1900V2; Serial: 5d002**

Communication System: CW; Frequency: 1900 MHz; Duty Cycle: 1:1

Medium parameters used (interpolated):  $f = 1900$  MHz;  $\sigma = 1.449$  S/m;  $\epsilon_r = 40.292$ ;  $\rho = 1000$  kg/m<sup>3</sup>

Phantom section: Flat Section

#### DASY5 Configuration:

- Probe: EX3DV4 – SN7380; ConvF(8.05, 8.05, 8.05); Calibrated: June 21, 2023;
- Sensor-Surface: 3mm (Mechanical Surface Detection)
- Electronics: DAE3 Sn428; Calibrated: Aug.30,2023;
- Phantom: Twin-SAM V8.0 ; Type: QD 000 P41 AA; Serial: 1974;
- DASY52 52.10.2(1495); SEMCAD X 14.6.12(7450)

**Area Scan (61x61x1):** Interpolated grid: dx=1.500 mm, dy=1.500 mm

Maximum value of SAR (interpolated) = 13.6 W/kg

**Zoom Scan (5x5x7)/Cube 0:** Measurement grid: dx=8mm, dy=8mm, dz=5mm

Reference Value = 82.74 V/m; Power Drift = -0.11 dB

Peak SAR (extrapolated) = 16.65 W/kg

**SAR(1 g) = 10.38 W/kg; SAR(10 g) = 5.15 W/kg**

Maximum value of SAR (measured) = 14.9 W/kg

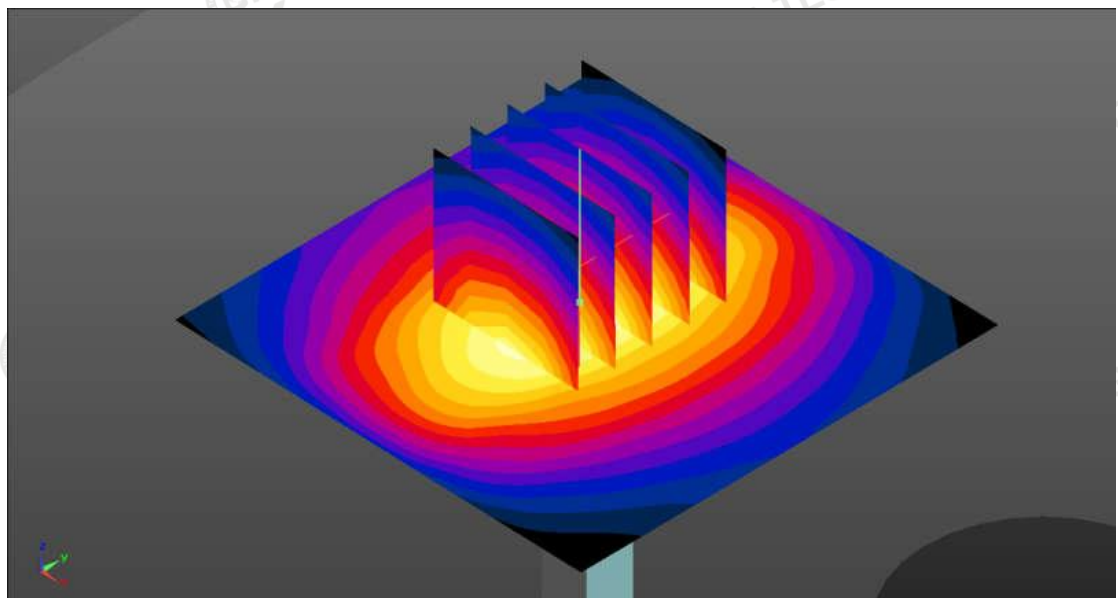
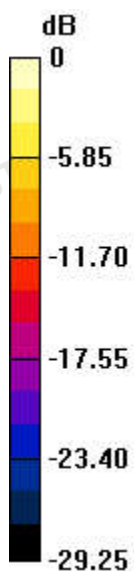

0 dB = 14.9 W/kg

System Performance Check 1900MHz 250mW

### 2450MHz System Check

Date: 05/24/2024

**DUT: Dipole 2450 MHz; Type: D2450V2; Serial: 745**

Communication System: CW; Frequency: 2450 MHz; Duty Cycle: 1:1

Medium parameters used (interpolated):  $f = 2450$  MHz;  $\sigma = 1.816$  S/m;  $\epsilon_r = 39.043$ ;  $\rho = 1000$  kg/m<sup>3</sup>

Phantom section: Flat Section

#### DASY5 Configuration:

- Probe: EX3DV4 – SN7380; ConvF(7.50, 7.50, 7.50); Calibrated: June 21, 2023;
- Sensor-Surface: 3mm (Mechanical Surface Detection)
- Electronics: DAE3 Sn428; Calibrated: Aug.30,2023;
- Phantom: Twin-SAM V8.0 ; Type: QD 000 P41 AA; Serial: 1974;
- DASY52 52.10.2(1495); SEMCAD X 14.6.12(7450)

**Area Scan (71x71x1):** Interpolated grid: dx=1.200 mm, dy=1.200 mm

Maximum value of SAR (interpolated) = 19.6 W/kg

**Zoom Scan (7x7x7)/Cube 0:** Measurement grid: dx=5mm, dy=5mm, dz=5mm

Reference Value = 100.26 V/m; Power Drift = 0.03 dB

Peak SAR (extrapolated) = 24.5 W/kg

**SAR(1 g) = 13.03 W/kg; SAR(10 g) = 6.18 W/kg**

Maximum value of SAR (measured) = 18.9 W/kg

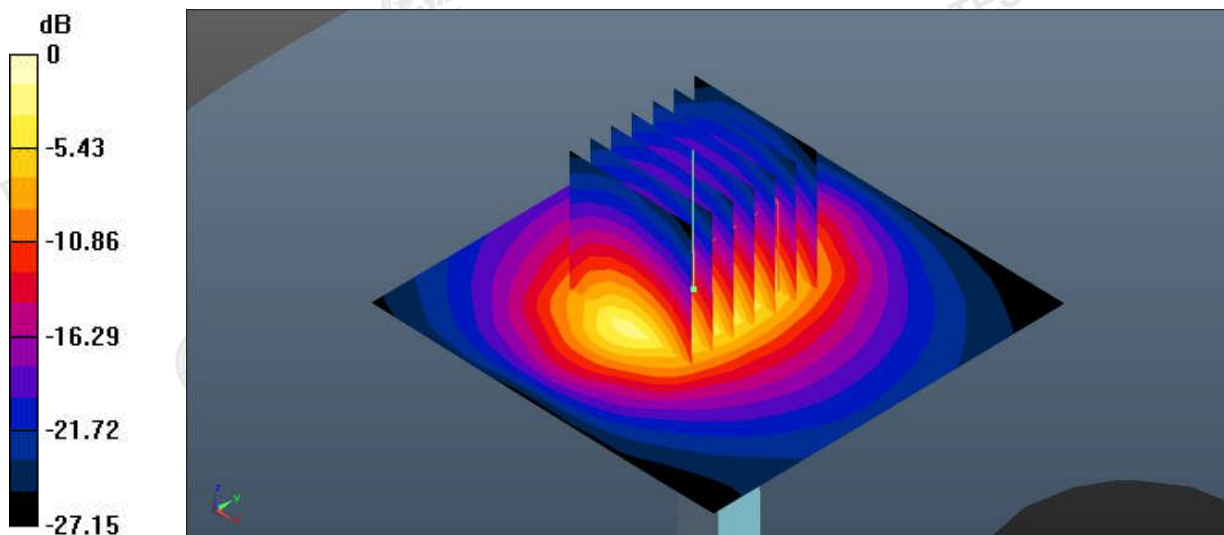

0 dB = 18.9 W/kg

System Performance Check 2450MHz 250mW



## Appendix C. Plots of SAR Test Data

### #1.

Date: 05/21/2024

#### GSM850\_GSM Voice\_Right Cheek\_0mm\_Ch128

Communication System: UID 0, GSM (0); Frequency: 824.2 MHz; Duty Cycle: 1:1

Medium parameters used (interpolated):  $f = 824.2$  MHz;  $\sigma = 0.895$  S/m;  $\epsilon_r = 41.636$ ;  $\rho = 1000$  kg/m<sup>3</sup>

Phantom section: Right Section

#### DASY5 Configuration:

- Probe: EX3DV4 - SN7380; ConvF(9.62, 9.62, 9.62); Calibrated: June 21, 2023;
- Sensor-Surface: 3mm (Mechanical Surface Detection)
- Electronics: DAE3 Sn428; Calibrated: Aug.30,2023;
- Phantom: Twin-SAM V8.0 ; Type: QD 000 P41 AA; Serial: 1974;
- DASY52 52.10.2(1495); SEMCAD X 14.6.12(7450)

**Area Scan (71x81x1):** Interpolated grid: dx=1.500 mm, dy=1.500 mm

Maximum value of SAR (interpolated) = 0.657 W/kg

**Zoom Scan (5x5x7)/Cube 0:** Measurement grid: dx=8mm, dy=8mm, dz=5mm

Reference Value = 4.256 V/m; Power Drift = 0.06 dB

Peak SAR (extrapolated) = 0.685 W/kg

**SAR(1 g) = 0.502 W/kg; SAR(10 g) = 0.384 W/kg**

Maximum value of SAR (measured) = 0.603 W/Kg

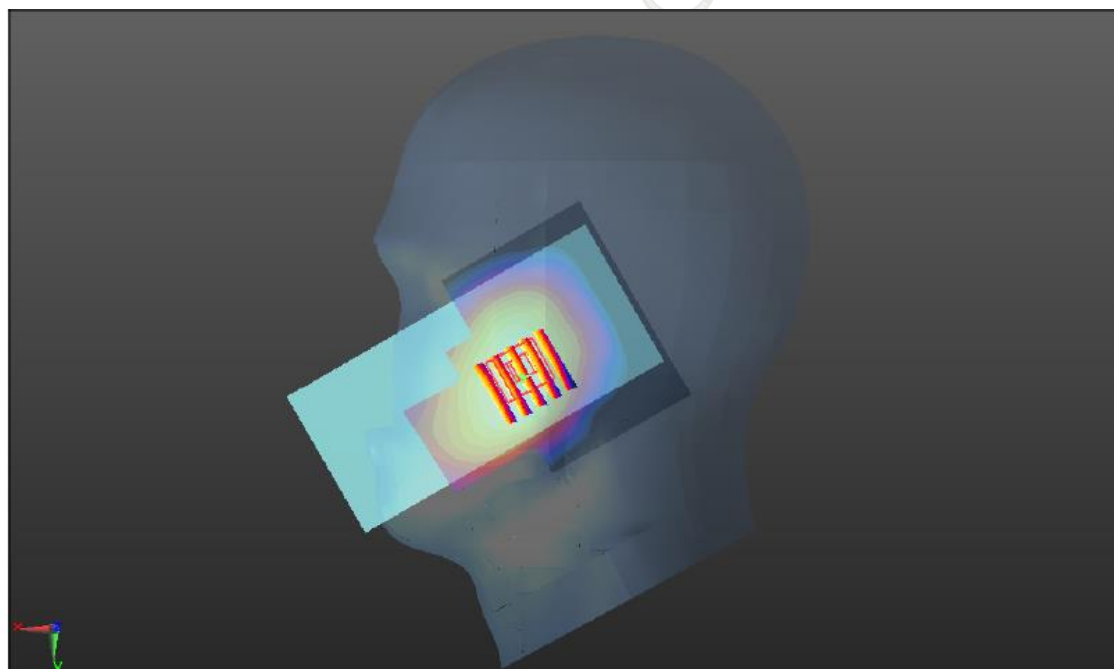
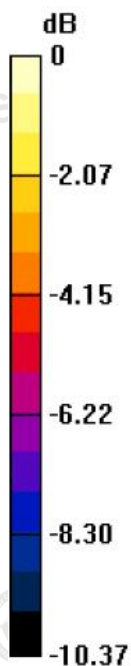

## #2.

Date: 05/23/2024

**GSM1900\_GSM Voice\_Right Cheek\_0mm\_Ch512**

Communication System: UID 0, GSM (0); Frequency: 1850.2 MHz; Duty Cycle: 1:1

Medium parameters used (interpolated):  $f = 1850.2$  MHz;  $\sigma = 1.407$  S/m;  $\epsilon_r = 39.320$ ;  $\rho = 1000$  kg/m<sup>3</sup>

Phantom section: Right Section

**DASY5 Configuration:**

- Probe: EX3DV4 - SN7380; ConvF(8.05, 8.05, 8.05); Calibrated: June 21, 2023;
- Sensor-Surface: 3mm (Mechanical Surface Detection)
- Electronics: DAE3 Sn428; Calibrated: Aug.30,2023;
- Phantom: Twin-SAM V8.0 ; Type: QD 000 P41 AA; Serial: 1974;
- DASY52 52.10.2(1495); SEMCAD X 14.6.12(7450)

**Area Scan (71x81x1):** Interpolated grid: dx=1.500 mm, dy=1.500 mm

Maximum value of SAR (interpolated) = 0.586 W/kg

**Zoom Scan (5x5x7)/Cube 0:** Measurement grid: dx=8mm, dy=8mm, dz=5mm

Reference Value = 4.685 V/m; Power Drift = -0.03 dB

Peak SAR (extrapolated) = 0.696 W/kg

**SAR(1 g) = 0.355 W/kg; SAR(10 g) = 0.247 W/kg**

Maximum value of SAR (measured) = 0.557 W/Kg

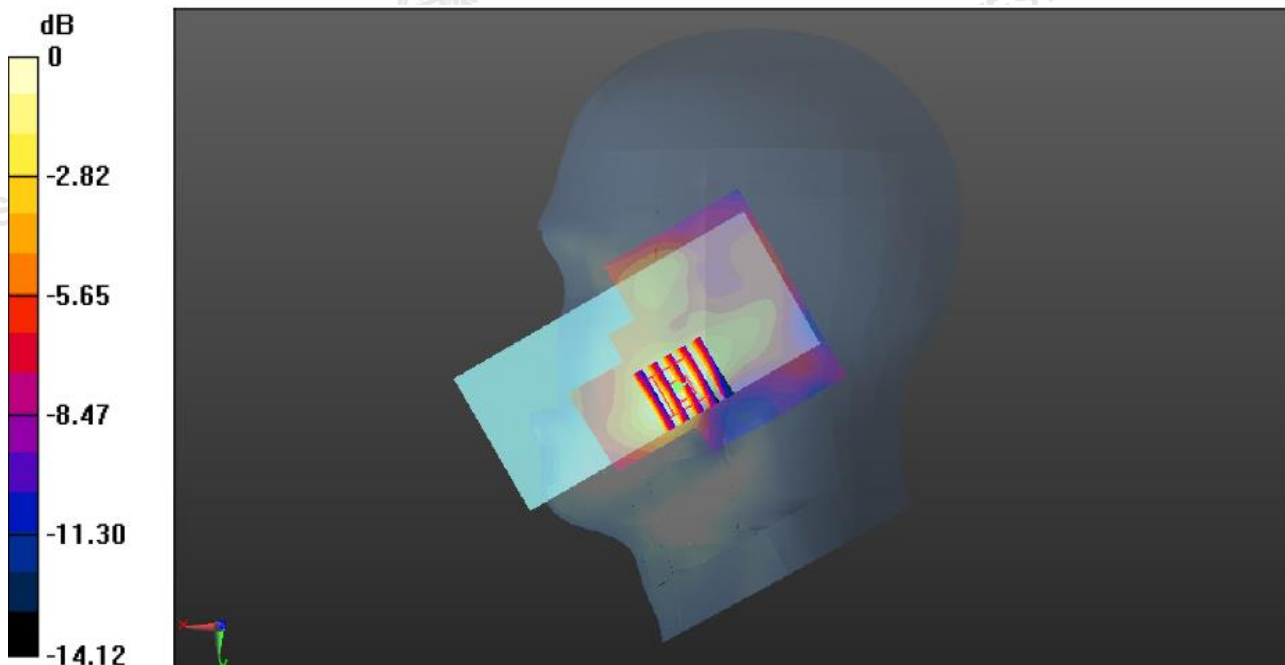

## #3.

Date: 05/23/2024

**WCDMA II\_RMC 12.2Kbps\_Right Cheek\_0mm\_Ch9400**

Communication System: UID 0, WCDMA (0); Frequency: 1880.0 MHz; Duty Cycle: 1:1

Medium parameters used (interpolated):  $f = 1880.0$  MHz;  $\sigma = 1.433$  S/m;  $\epsilon_r = 40.752$ ;  $\rho = 1000$  kg/m<sup>3</sup>

Phantom section: Right Section

**DASY5 Configuration:**

- Probe: EX3DV4 - SN7380; ConvF(8.05, 8.05, 8.05); Calibrated: June 21, 2023;
- Sensor-Surface: 3mm (Mechanical Surface Detection)
- Electronics: DAE3 Sn428; Calibrated: Aug.30,2023;
- Phantom: Twin-SAM V8.0 ; Type: QD 000 P41 AA; Serial: 1974;
- DASY52 52.10.2(1495); SEMCAD X 14.6.12(7450)

**Area Scan (71x81x1):** Interpolated grid: dx=1.500 mm, dy=1.500 mm

Maximum value of SAR (interpolated) = 0.325 W/kg

**Zoom Scan (5x5x7)/Cube 0:** Measurement grid: dx=8mm, dy=8mm, dz=5mm

Reference Value = 3.236 V/m; Power Drift = -0.04 dB

Peak SAR (extrapolated) = 0.375 W/kg

**SAR(1 g) = 0.205 W/kg; SAR(10 g) = 0.133 W/kg**

Maximum value of SAR (measured) = 0.355 W/Kg

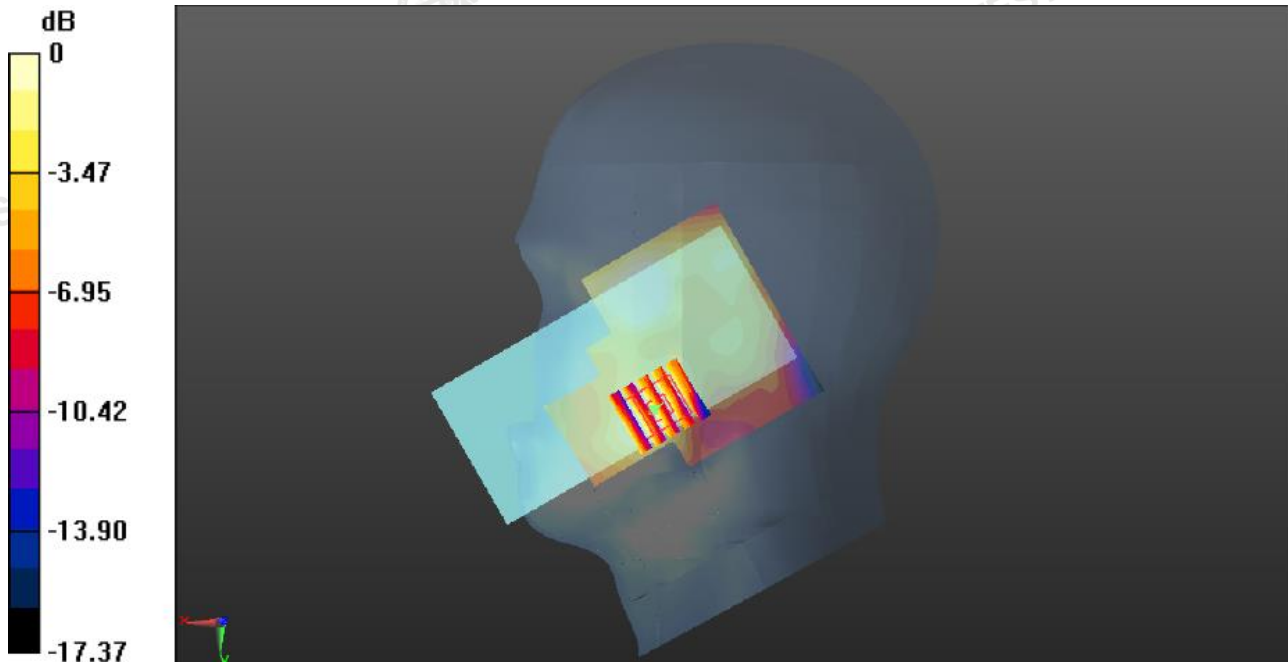

## #4.

Date: 05/22/2024

**WCDMA IV\_RMC 12.2Kbps\_Right Cheek\_0mm\_Ch1513**

Communication System: UID 0, WCDMA (0); Frequency: 1752.6 MHz; Duty Cycle: 1:1

Medium parameters used (interpolated):  $f = 1752.6$  MHz;  $\sigma = 1.334$  S/m;  $\epsilon_r = 40.974$ ;  $\rho = 1000$  kg/m<sup>3</sup>

Phantom section: Right Section

**DASY5 Configuration:**

- Probe: EX3DV4 - SN7380; ConvF(8.35, 8.35, 8.35); Calibrated: June 21, 2023;
- Sensor-Surface: 3mm (Mechanical Surface Detection)
- Electronics: DAE3 Sn428; Calibrated: Aug.30,2023;
- Phantom: Twin-SAM V8.0 ; Type: QD 000 P41 AA; Serial: 1974;
- DASY52 52.10.2(1495); SEMCAD X 14.6.12(7450)

**Area Scan (71x81x1):** Interpolated grid: dx=1.500 mm, dy=1.500 mm

Maximum value of SAR (interpolated) = 0.312 W/kg

**Zoom Scan (5x5x7)/Cube 0:** Measurement grid: dx=8mm, dy=8mm, dz=5mm

Reference Value = 3.721 V/m; Power Drift = -0.03 dB

Peak SAR (extrapolated) = 0.404 W/kg

**SAR(1 g) = 0.292 W/kg; SAR(10 g) = 0.178 W/kg**

Maximum value of SAR (measured) = 0.354 W/kg

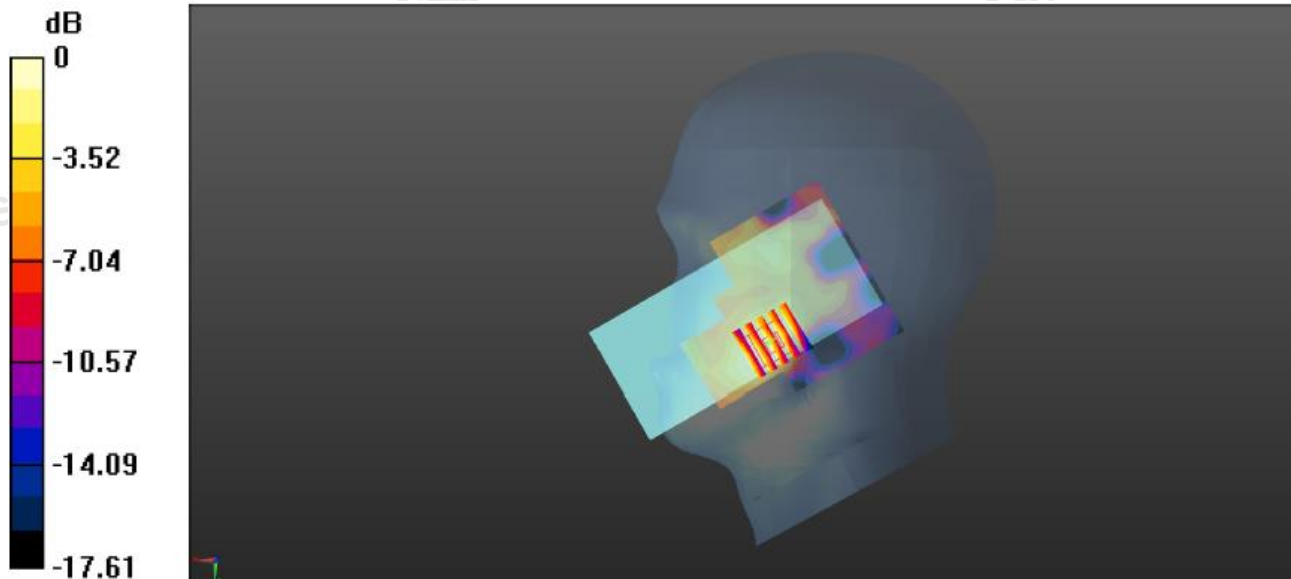

## #5.

Date: 05/21/2024

**WCDMA V\_RMC 12.2Kbps\_Right Cheek\_0mm\_Ch4183**

Communication System: UID 0, WCDMA (0); Frequency: 836.6 MHz; Duty Cycle: 1:1

Medium parameters used (interpolated):  $f = 836.6$  MHz;  $\sigma = 0.889$  S/m;  $\epsilon_r = 41.542$ ;  $\rho = 1000$  kg/m<sup>3</sup>

Phantom section: Right Section

**DASY5 Configuration:**

- Probe: EX3DV4 - SN7380; ConvF(9.62, 9.62, 9.62); Calibrated: June 21, 2023;
- Sensor-Surface: 3mm (Mechanical Surface Detection)
- Electronics: DAE3 Sn428; Calibrated: Aug.30,2023;
- Phantom: Twin-SAM V8.0 ; Type: QD 000 P41 AA; Serial: 1974;
- DASY52 52.10.2(1495); SEMCAD X 14.6.12(7450)

**Area Scan (71x81x1):** Interpolated grid: dx=1.500 mm, dy=1.500 mm

Maximum value of SAR (interpolated) = 0.401 W/kg

**Zoom Scan (5x5x7)/Cube 0:** Measurement grid: dx=8mm, dy=8mm, dz=5mm

Reference Value = 4.885 V/m; Power Drift = 0.11 dB

Peak SAR (extrapolated) = 0.425 W/kg

**SAR(1 g) = 0.301 W/kg; SAR(10 g) = 0.228 W/kg**

Maximum value of SAR (measured) = 0.352 W/Kg

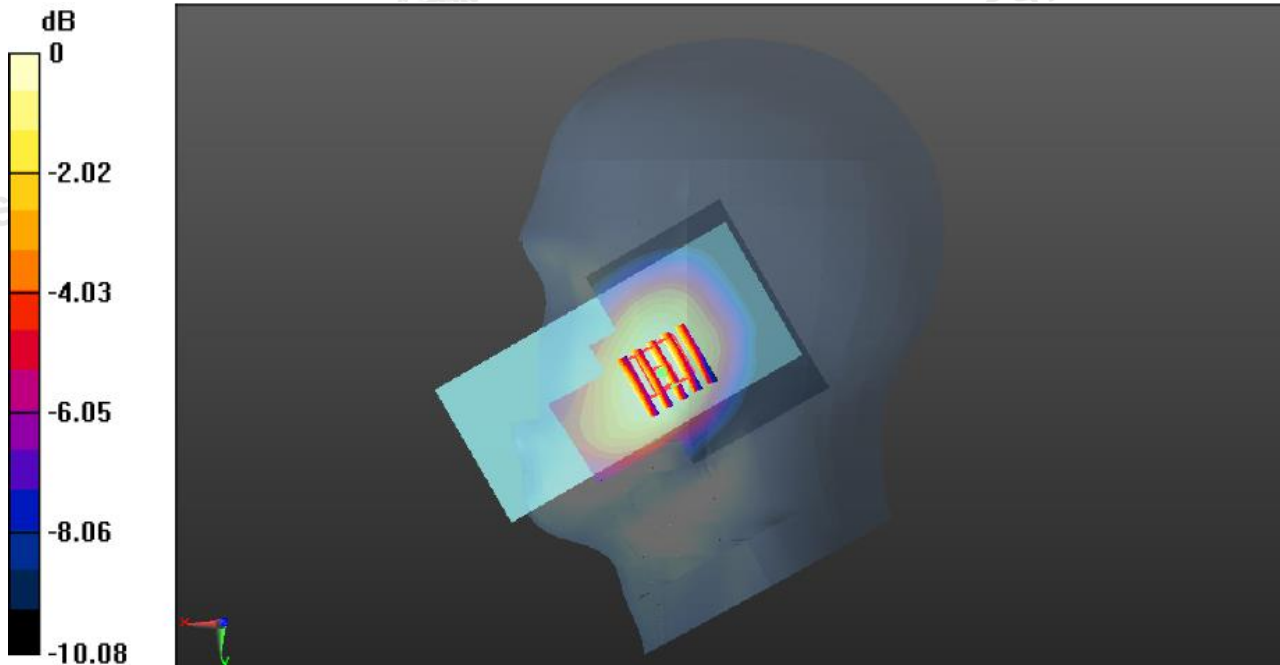

## #6.

Date: 05/24/2024

**WLAN2.4GHz\_802.11b 1Mbps\_Left Cheek\_0mm\_Ch01**

Communication System: UID 0, WIFI (0); Frequency: 2412.0 MHz; Duty Cycle: 1:1

Medium parameters used (interpolated):  $f = 2412.0$  MHz;  $\sigma = 1.841$  S/m;  $\epsilon_r = 38.435$ ;  $\rho = 1000$  kg/m<sup>3</sup>

Phantom section: Left Section

**DASY5 Configuration:**

- Probe: EX3DV4 - SN7380; ConvF(7.50, 7.50, 7.50); Calibrated: June 21, 2023
- Sensor-Surface: 2mm (Mechanical Surface Detection)
- Electronics: DAE3 Sn428; Calibrated: Aug.30,2023;
- Phantom: Twin-SAM V8.0 ; Type: QD 000 P41 AA; Serial: 1974;
- DASY52 52.10.2(1495); SEMCAD X 14.6.12(7450)

**Area Scan (81x91x1):** Interpolated grid: dx=1.200 mm, dy=1.200 mm

Maximum value of SAR (interpolated) = 0.624 W/kg

**Zoom Scan (7x7x7)/Cube 0:** Measurement grid: dx=5mm, dy=5mm, dz=5mm

Reference Value = 7.542 V/m; Power Drift = -0.05 dB

Peak SAR (extrapolated) = 0.799 W/kg

**SAR(1 g) = 0.414 W/kg; SAR(10 g) = 0.268 W/kg**

Maximum value of SAR (measured) = 0.612 W/Kg

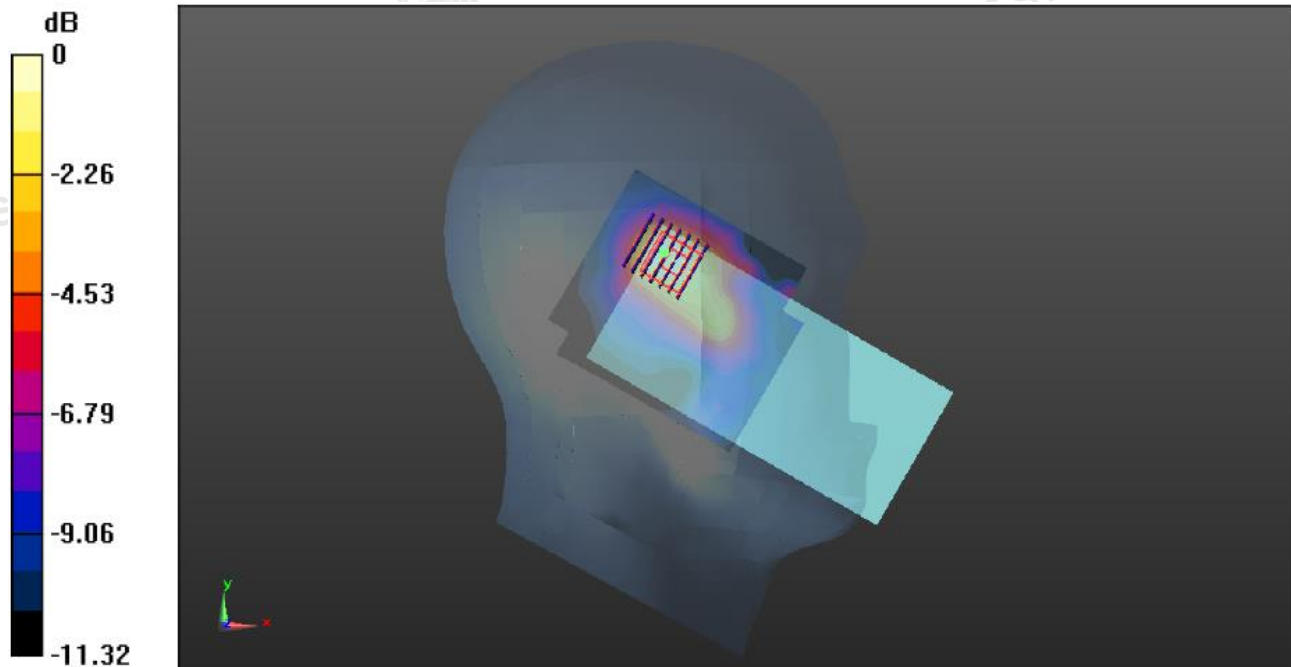



#7.

Date: 05/21/2024

**GPRS850\_4Tx slots\_Back\_10mm\_CH190**

Communication System: UID 0, GSM (0); Frequency: 836.6 MHz; Duty Cycle: 1:1

Medium parameters used (interpolated):  $f = 836.6$  MHz;  $\sigma = 0.911$  S/m;  $\epsilon_r = 42.121$ ;  $\rho = 1000$  kg/m<sup>3</sup>

Phantom section: Flat Section

**DASY5 Configuration:**

- Probe: EX3DV4 - SN7380; ConvF(9.62, 9.62, 9.62); Calibrated: June 21, 2023
- Sensor-Surface: 2mm (Mechanical Surface Detection)
- Electronics: DAE3 Sn428; Calibrated: Aug.30,2023;
- Phantom: Twin-SAM V8.0 ; Type: QD 000 P41 AA; Serial: 1974;
- DASY52 52.10.2(1495); SEMCAD X 14.6.12(7450)

**Area Scan (71x121x1):** Interpolated grid: dx=1.500 mm, dy=1.500 mm

Maximum value of SAR (interpolated) = 1.008 W/Kg

**Zoom Scan (6x5x7)/Cube 0:** Measurement grid: dx=8mm, dy=8mm, dz=5mm

Reference Value = 25.42 V/m; Power Drift = 0.12 dB

Peak SAR (extrapolated) = 1.334 W/kg

**SAR(1 g) = 0.721 W/Kg; SAR(10 g) = 0.416 W/Kg**

Maximum value of SAR (measured) = 0.769 W/Kg

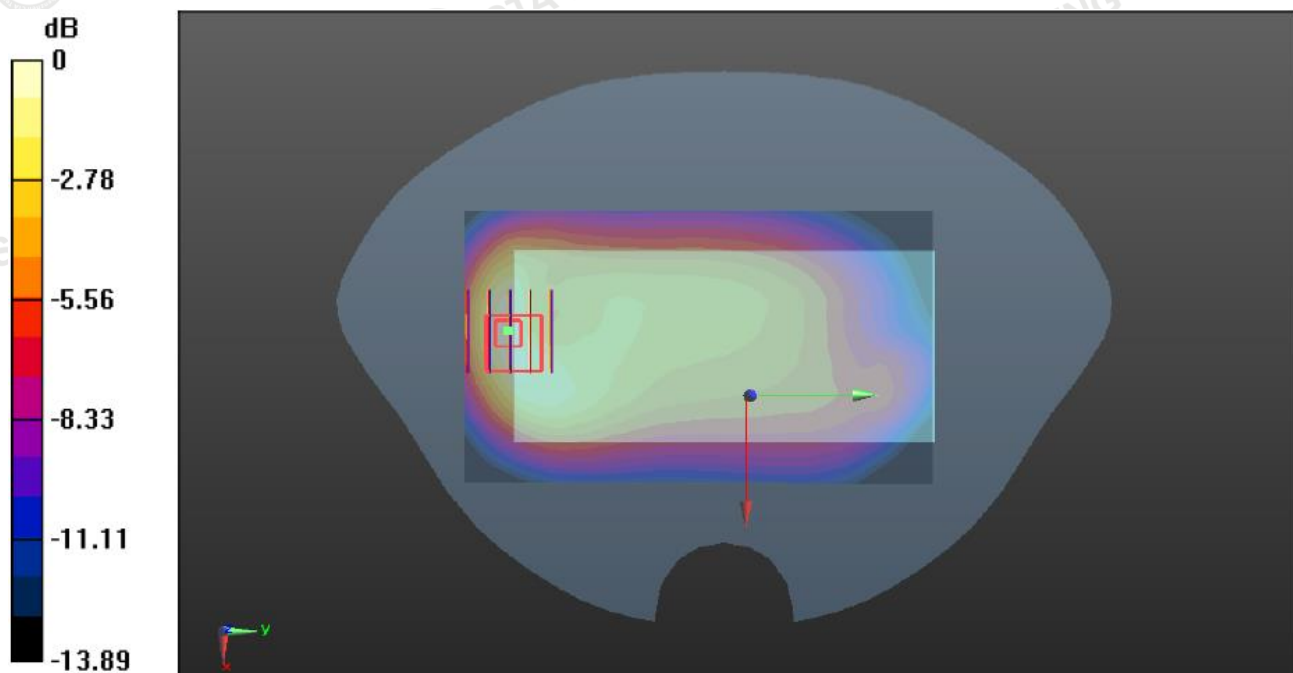

#8.

Date: 05/23/2024

**GPRS 1900\_1Tx slots\_Bottom\_10mm\_CH661**

Communication System: UID 0, GSM (0); Frequency: 1880.0 MHz; Duty Cycle: 1:1

Medium parameters used:  $f = 1880.0$  MHz;  $\sigma = 1.414$  S/m;  $\epsilon_r = 39.137$ ;  $\rho = 1000$  kg/m<sup>3</sup>

Phantom section: Flat Section

**DASY5 Configuration:**

- Probe: EX3DV4 - SN7380; ConvF(8.05, 8.05, 8.05); Calibrated: June 21, 2023
- Sensor-Surface: 2mm (Mechanical Surface Detection)
- Electronics: DAE3 Sn428; Calibrated: Aug.30,2023;
- Phantom: Twin-SAM V8.0 ; Type: QD 000 P41 AA; Serial: 1974;
- DASY52 52.10.2(1495); SEMCAD X 14.6.12(7450)

**Area Scan (51x71x1):** Interpolated grid: dx=1.500 mm, dy=1.500 mm

Maximum value of SAR (interpolated) = 1.01 W/Kg

**Zoom Scan (5x5x7)/Cube 0:** Measurement grid: dx=8mm, dy=8mm, dz=5mm

Reference Value = 20.36 V/m; Power Drift = -0.02 dB

Peak SAR (extrapolated) = 1.224 W/kg

**SAR(1 g) = 0.685 W/Kg; SAR(10 g) = 0.392 W/Kg**

Maximum value of SAR (measured) = 1.10 W/Kg

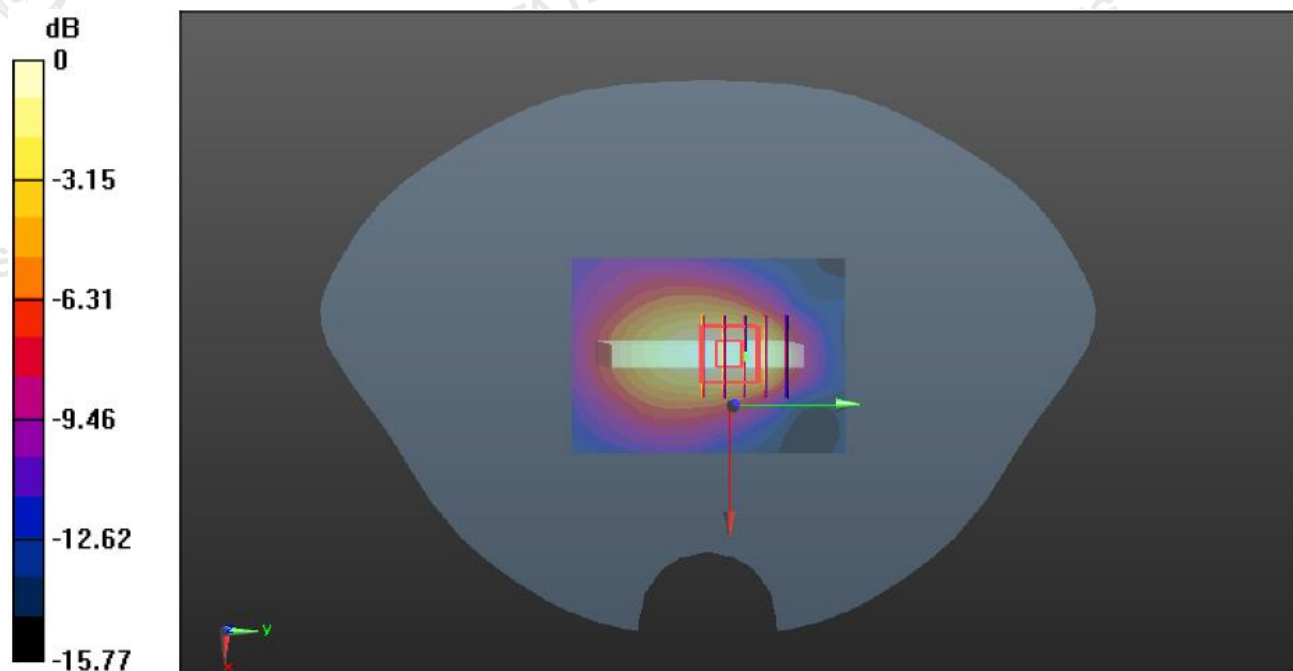

#9.

Date: 05/23/2024

**WCDMA II\_RMC 12.2Kbps\_ Back\_10mm\_Ch9400**

Communication System: UID 0, Generic WCDMA (0); Frequency: 1880.0 MHz; Duty Cycle: 1:1

Medium parameters used (interpolated):  $f = 1880.0$  MHz;  $\sigma = 1.433$  S/m;  $\epsilon_r = 39.541$ ;  $\rho = 1000$  kg/m<sup>3</sup>

Phantom section: Flat Section

**DASY5 Configuration:**

- Probe: EX3DV4 - SN7380; ConvF(8.05, 8.05, 8.05); Calibrated: June 21, 2023
- Sensor-Surface: 2mm (Mechanical Surface Detection)
- Electronics: DAE3 Sn428; Calibrated: Aug.30,2023;
- Phantom: Twin-SAM V8.0 ; Type: QD 000 P41 AA; Serial: 1974;
- DASY52 52.10.2(1495); SEMCAD X 14.6.12(7450)

**Area Scan (71x81x1):** Interpolated grid: dx=1.500 mm, dy=1.500 mm

Maximum value of SAR (interpolated) = 0.915 W/Kg

**Zoom Scan (5x5x7)/Cube 0:** Measurement grid: dx=8mm, dy=8mm, dz=5mm

Reference Value = 18.65 V/m; Power Drift = 0.08 dB

Peak SAR (extrapolated) = 1.039 W/kg

**SAR(1 g) = 0.612 W/Kg; SAR(10 g) = 0.324 W/Kg**

Maximum value of SAR (measured) = 1.01 W/Kg

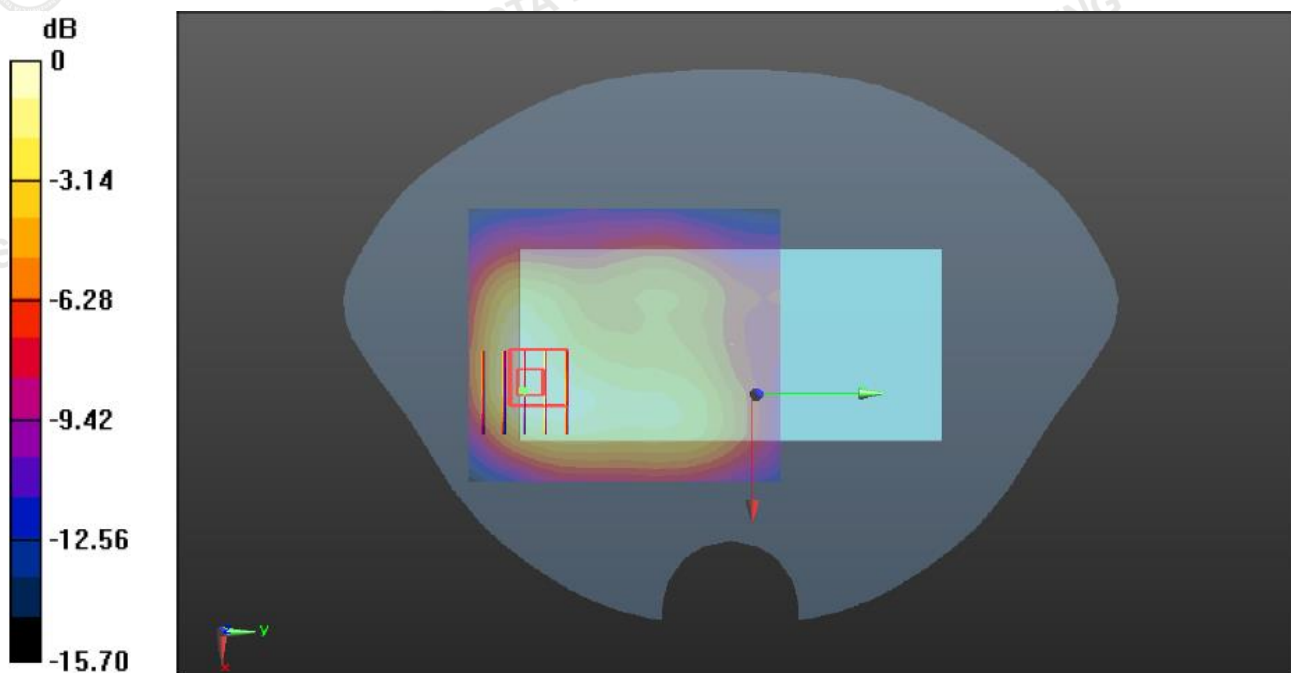

#10.

Date: 05/22/2024

**WCDMA IV\_RMC 12.2Kbps\_ Bottom \_10mm\_Ch1513**

Communication System: UID 0, Generic WCDMA (0); Frequency: 1752.6 MHz; Duty Cycle: 1:1

Medium parameters used (interpolated):  $f = 1752.6$  MHz;  $\sigma = 1.393$  S/m;  $\epsilon_r = 39.948$ ;  $\rho = 1000$  kg/m<sup>3</sup>

Phantom section: Flat Section

**DASY5 Configuration:**

- Probe: EX3DV4 - SN7380; ConvF(8.35, 8.35, 8.35); Calibrated: June 21, 2023
- Sensor-Surface: 2mm (Mechanical Surface Detection)
- Electronics: DAE3 Sn428; Calibrated: Aug.30,2023;
- Phantom: Twin-SAM V8.0 ; Type: QD 000 P41 AA; Serial: 1974;
- DASY52 52.10.2(1495); SEMCAD X 14.6.12(7450)

**Area Scan (41x71x1):** Interpolated grid: dx=1.500 mm, dy=1.500 mm

Maximum value of SAR (interpolated) = 1.21 W/Kg

**Zoom Scan (5x5x7)/Cube 0:** Measurement grid: dx=8mm, dy=8mm, dz=5mm

Reference Value = 27.46 V/m; Power Drift = 0.03 dB

Peak SAR (extrapolated) = 1.35 W/kg

**SAR(1 g) = 0.811 W/Kg; SAR(10 g) = 0.542 W/Kg**

Maximum value of SAR (measured) = 1.31 W/Kg

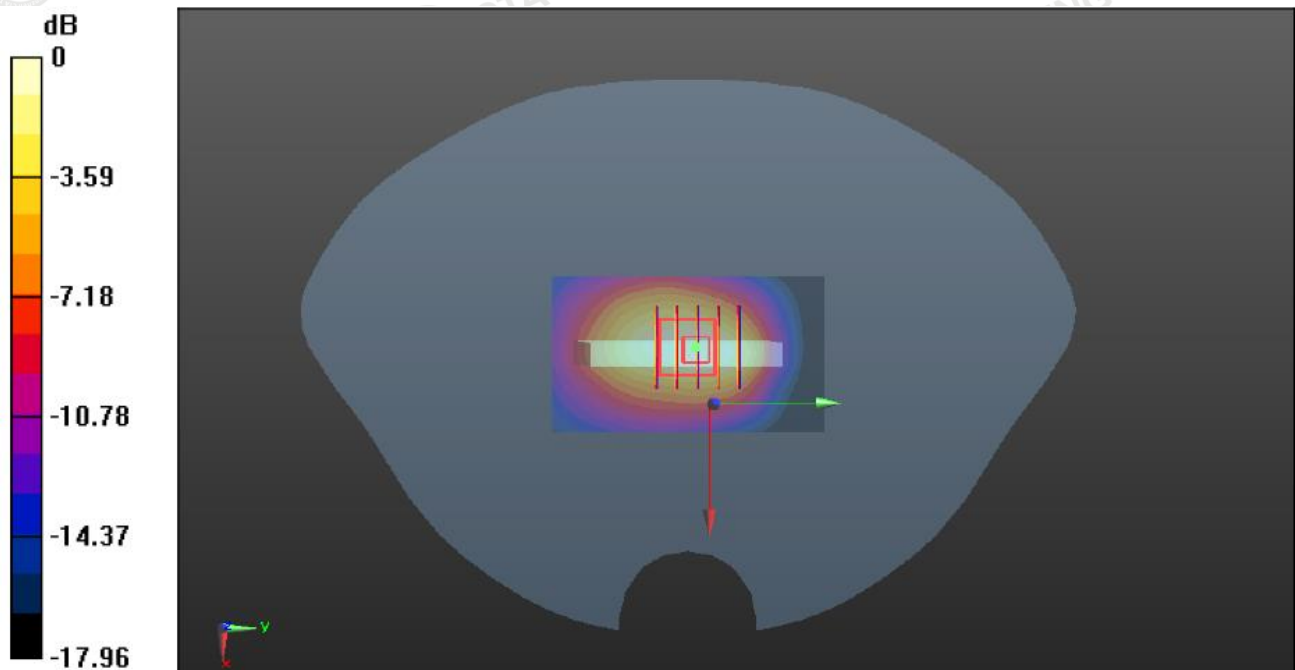

## #11.

Date: 05/21/2024

**WCDMA V\_RMC 12.2Kbps\_ Back\_10mm\_Ch4183**

Communication System: UID 0, Generic WCDMA (0); Frequency: 836.6 MHz; Duty Cycle: 1:1

Medium parameters used (interpolated):  $f = 836.6$  MHz;  $\sigma = 0.887$  S/m;  $\epsilon_r = 42.247$ ;  $\rho = 1000$  kg/m<sup>3</sup>

Phantom section: Flat Section

**DASY5 Configuration:**

- Probe: EX3DV4 - SN7380; ConvF(9.62, 9.62, 9.62); Calibrated: June 21, 2023
- Sensor-Surface: 2mm (Mechanical Surface Detection)
- Electronics: DAE3 Sn428; Calibrated: Aug.30,2023;
- Phantom: Twin-SAM V8.0 ; Type: QD 000 P41 AA; Serial: 1974;
- DASY52 52.10.2(1495); SEMCAD X 14.6.12(7450)

**Area Scan (71x121x1):** Interpolated grid: dx=1.500 mm, dy=1.500 mm

Maximum value of SAR (interpolated) = 0.901 W/Kg

**Zoom Scan (5x5x7)/Cube 0:** Measurement grid: dx=8mm, dy=8mm, dz=5mm

Reference Value = 19.36 V/m; Power Drift = 0.09 dB

Peak SAR (extrapolated) = 1.125 W/Kg

**SAR(1 g) = 0.648 W/Kg; SAR(10 g) = 0.477 W/Kg**

Maximum value of SAR (measured) = 0.977 W/Kg

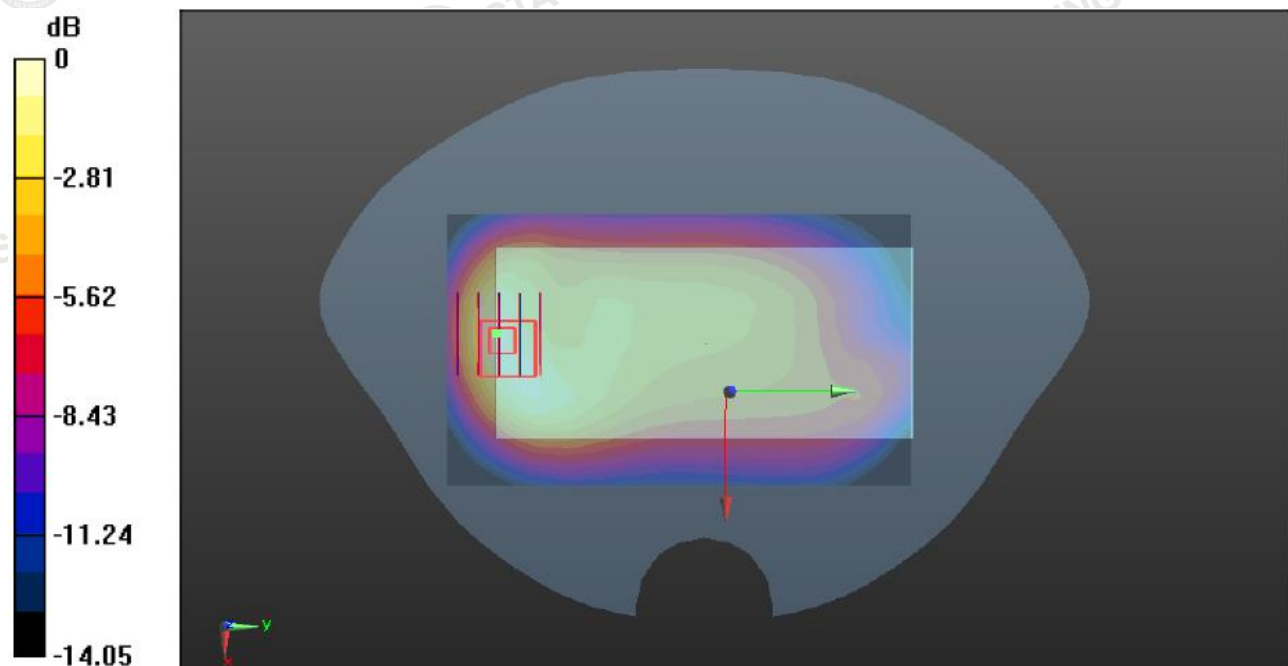

#12.

Date: 05/24/2024

**WLAN2.4GHz\_802.11b 1Mbps\_Back\_10mm\_Ch01**

Communication System: UID 0, Generic WIFI(0); Frequency: 2412 MHz; Duty Cycle: 1:1

Medium parameters used (interpolated):  $f = 2412$  MHz;  $\sigma = 1.805$  S/m;  $\epsilon_r = 40.204$ ;  $\rho = 1000$  kg/m<sup>3</sup>

Phantom section: Flat Section

**DASY5 Configuration:**

- Probe: EX3DV4 - SN7380; ConvF(7.50, 7.50, 7.50); Calibrated: June 21, 2023
- Sensor-Surface: 2mm (Mechanical Surface Detection)
- Electronics: DAE3 Sn428; Calibrated: Aug.30,2023;
- Phantom: Twin-SAM V8.0 ; Type: QD 000 P41 AA; Serial: 1974;
- DASY52 52.10.2(1495); SEMCAD X 14.6.12(7450)

**Area Scan (81x91x1):** Interpolated grid: dx=1.200 mm, dy=1.200 mm

Maximum value of SAR (interpolated) = 0.318 W/Kg

**Zoom Scan (7x7x7)/Cube 0:** Measurement grid: dx=5mm, dy=5mm, dz=5mm

Reference Value = 7.355 V/m; Power Drift = -0.07 dB

Peak SAR (extrapolated) = 0.478 W/kg

**SAR(1 g) = 0.281 W/Kg; SAR(10 g) = 0.117 W/Kg**

Maximum value of SAR (measured) = 0.432 W/Kg

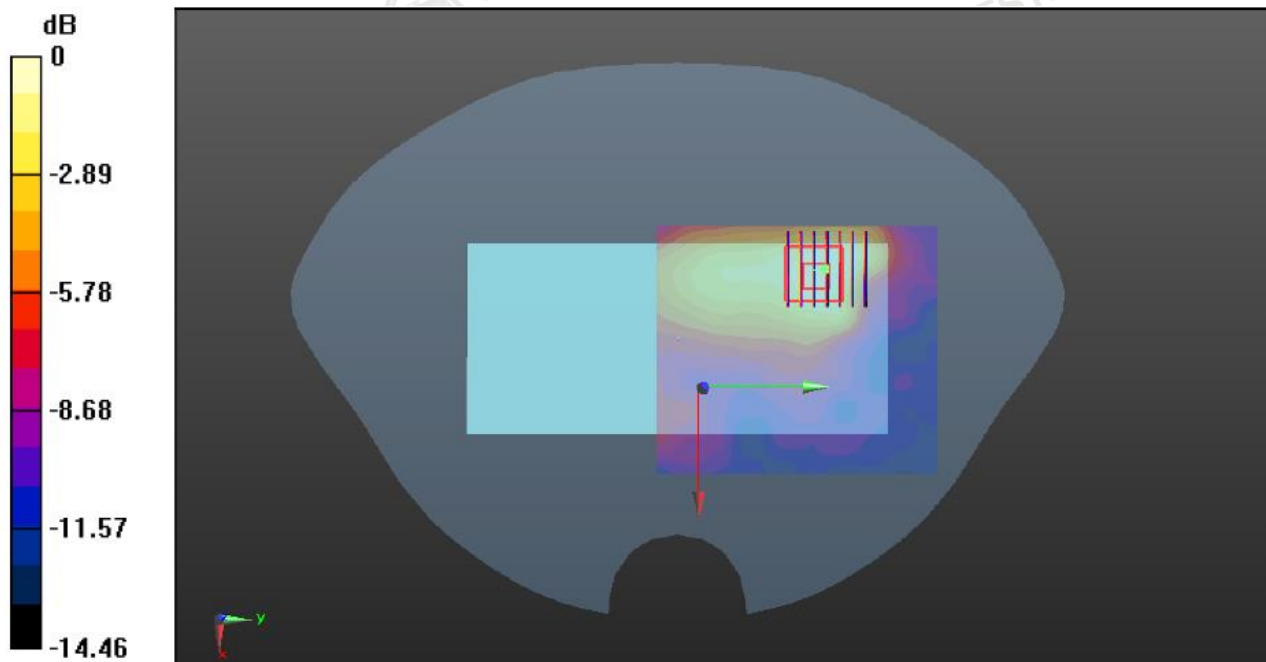





# Appendix D. DASY System Calibration Certificate



**TTL**  
In Collaboration with  
**s p e a g**  
CALIBRATION LABORATORY

Address: No.52 HuaYuanBei Road, Haidian District, Beijing, 100191, China  
Tel: +86-10-62304633-2117  
E-mail: cmf@caict.ac.cn http://www.caict.ac.cn

中国认可  
国际互认  
校准  
CALIBRATION  
CNAS L0570

Client: **ruixiang** Certificate No: **J23Z60276**

## CALIBRATION CERTIFICATE

**Object:** EX3DV4 - SN : 7380

**Calibration Procedure(s):** FF-Z11-004-02  
Calibration Procedures for Dosimetric E-field Probes



**Calibration date:** June 21, 2023

This calibration Certificate documents the traceability to national standards, which realize the physical units of measurements(SI). The measurements and the uncertainties with confidence probability are given on the following pages and are part of the certificate.

All calibrations have been conducted in the closed laboratory facility: environment temperature(22±3)°C and humidity<70%.

Calibration Equipment used (M&TE critical for calibration)

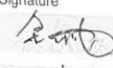
Primary Standards	ID #	Cal Date(Calibrated by, Certificate No.)	Scheduled Calibration
Power Meter NRP2	101919	12-Jun-23(CTTL, No.J23X05435)	Jun-24
Power sensor NRP-Z91	101547	12-Jun-23(CTTL, No.J23X05435)	Jun-24
Power sensor NRP-Z91	101548	12-Jun-23(CTTL, No.J23X05435)	Jun-24
Reference 10dBAAttenuator	18N50W-10dB	19-Jan-23(CTTL, No.J23X00212)	Jan-25
Reference 20dBAAttenuator	18N50W-20dB	19-Jan-23(CTTL, No.J23X00211)	Jan-25
Reference Probe EX3DV4	SN 7517	27-Jan-23(SPEAG, No.EX-7517_Jan23)	Jan-24
DAE4	SN 1555	25-Aug-22(SPEAG, No.DAE4-1555_Aug22)	Aug-23
Secondary Standards	ID #	Cal Date(Calibrated by, Certificate No.)	Scheduled Calibration
SignalGenerator MG3700A	6201052605	12-Jun-23(CTTL, No.J23X05434)	Jun-24
Network Analyzer E5071C	MY46110673	10-Jan-23(CTTL, No.J23X00104)	Jan-24
Reference 10dBAAttenuator	BT0520	11-May-23(CTTL, No.J23X04061)	May-25
Reference 20dBAAttenuator	BT0267	11-May-23(CTTL, No.J23X04062)	May-25
OCF DAK-3.5	SN 1040	18-Jan-23(SPEAG, No.OCP-DAK3.5-1040_Jan23)	Jan-24

	Name	Function	Signature
Calibrated by:	Yu Zongying	SAR Test Engineer	
Reviewed by:	Lin Hao	SAR Test Engineer	
Approved by:	Qi Dianyuan	SAR Project Leader	

Issued: June 27, 2023

This calibration certificate shall not be reproduced except in full without written approval of the laboratory.

Certificate No: J23Z60276
Page 1 of 9

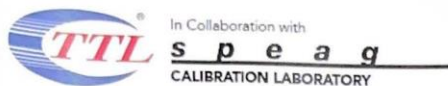

Add: No.52 HuaYuanBei Road, Haidian District, Beijing, 100191, China  
Tel: +86-10-62304633-2117  
E-mail: emf@caict.ac.cn <http://www.caict.ac.cn>

#### Glossary:

TSL	tissue simulating liquid
NORM <sub>x,y,z</sub>	sensitivity in free space
ConvF	sensitivity in TSL / NORM <sub>x,y,z</sub>
DCP	diode compression point
CF	crest factor (1/duty_cycle) of the RF signal
A,B,C,D	modulation dependent linearization parameters
Polarization $\Phi$	$\Phi$ rotation around probe axis
Polarization $\theta$	$\theta$ rotation around an axis that is in the plane normal to probe axis (at measurement center), $\theta=0$ is normal to probe axis
Connector Angle	information used in DASY system to align probe sensor X to the robot coordinate system

#### Calibration is Performed According to the Following Standards:

- IEEE Std 1528-2013, "IEEE Recommended Practice for Determining the Peak Spatial-Averaged Specific Absorption Rate (SAR) in the Human Head from Wireless Communications Devices: Measurement Techniques", June 2013
- IEC 62209-1, "Measurement procedure for the assessment of Specific Absorption Rate (SAR) from hand-held and body-mounted devices used next to the ear (frequency range of 300 MHz to 6 GHz)", July 2016
- IEC 62209-2, "Procedure to determine the Specific Absorption Rate (SAR) for wireless communication devices used in close proximity to the human body (frequency range of 30 MHz to 6 GHz)", March 2010
- KDB 865664, "SAR Measurement Requirements for 100 MHz to 6 GHz"

#### Methods Applied and Interpretation of Parameters:

- NORM<sub>x,y,z</sub>:** Assessed for E-field polarization  $\theta=0$  ( $f \leq 900\text{MHz}$  in TEM-cell;  $f > 1800\text{MHz}$ : waveguide). NORM<sub>x,y,z</sub> are only intermediate values, i.e., the uncertainties of NORM<sub>x,y,z</sub> does not effect the  $E^2$ -field uncertainty inside TSL (see below ConvF).
- NORM(f)<sub>x,y,z</sub> = NORM<sub>x,y,z</sub> \* frequency\_response** (see Frequency Response Chart). This linearization is implemented in DASY4 software versions later than 4.2. The uncertainty of the frequency response is included in the stated uncertainty of ConvF.
- DCP<sub>x,y,z</sub>:** DCP are numerical linearization parameters assessed based on the data of power sweep (no uncertainty required). DCP does not depend on frequency nor media.
- PAR:** PAR is the Peak to Average Ratio that is not calibrated but determined based on the signal characteristics.
- A<sub>x,y,z</sub>; B<sub>x,y,z</sub>; C<sub>x,y,z</sub>; VR<sub>x,y,z</sub>; A,B,C** are numerical linearization parameters assessed based on the data of power sweep for specific modulation signal. The parameters do not depend on frequency nor media. VR is the maximum calibration range expressed in RMS voltage across the diode.
- ConvF and Boundary Effect Parameters:** Assessed in flat phantom using E-field (or Temperature Transfer Standard for  $f \leq 800\text{MHz}$ ) and inside waveguide using analytical field distributions based on power measurements for  $f > 800\text{MHz}$ . The same setups are used for assessment of the parameters applied for boundary compensation (alpha, depth) of which typical uncertainty valued are given. These parameters are used in DASY4 software to improve probe accuracy close to the boundary. The sensitivity in TSL corresponds to NORM<sub>x,y,z</sub> \* ConvF whereby the uncertainty corresponds to that given for ConvF. A frequency dependent ConvF is used in DASY version 4.4 and higher which allows extending the validity from  $\pm 50\text{MHz}$  to  $\pm 100\text{MHz}$ .
- Spherical isotropy (3D deviation from isotropy):** in a field of low gradients realized using a flat phantom exposed by a patch antenna.
- Sensor Offset:** The sensor offset corresponds to the offset of virtual measurement center from the probe tip (on probe axis). No tolerance required.
- Connector Angle:** The angle is assessed using the information gained by determining the NORM<sub>x</sub> (no uncertainty required).

Certificate No: J23Z60276

Page 2 of 9

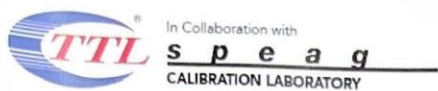

Add: No.52 HuaYuanBei Road, Haidian District, Beijing, 100191, China  
 Tel: +86-10-62304633-2117  
 E-mail: emf@caict.ac.cn http://www.caict.ac.cn

**DASY/EASY – Parameters of Probe: EX3DV4 – SN:7380**

**Basic Calibration Parameters**

	Sensor X	Sensor Y	Sensor Z	Unc (k=2)
Norm( $\mu\text{V}/(\text{V}/\text{m})^2$ ) <sup>A</sup>	0.44	0.35	0.41	$\pm 10.0\%$
DCP(mV) <sup>B</sup>	100.5	101.6	100.6	

**Modulation Calibration Parameters**

UID	Communication System Name		A dB	B dB $\mu\text{V}$	C	D dB	VR mV	Unc <sup>E</sup> (k=2)
0	CW	X	0.0	0.0	1.0	0.00	161.9	$\pm 2.2\%$
		Y	0.0	0.0	1.0		139.0	
		Z	0.0	0.0	1.0		149.3	

The reported uncertainty of measurement is stated as the standard uncertainty of Measurement multiplied by the coverage factor  $k=2$ , which for a normal distribution Corresponds to a coverage probability of approximately 95%.

<sup>A</sup> The uncertainties of Norm X, Y, Z do not affect the E<sup>2</sup>-field uncertainty inside TSL (see Page 4).  
<sup>B</sup> Numerical linearization parameter: uncertainty not required.  
<sup>E</sup> Uncertainty is determined using the max. deviation from linear response applying rectangular distribution and is expressed for the square of the field value.





Add: No.52 HuaYuanBei Road, Haidian District, Beijing, 100191, China  
 Tel: +86-10-62304633-2117  
 E-mail: emf@caict.ac.cn http://www.caict.ac.cn

**DASY/EASY – Parameters of Probe: EX3DV4 – SN:7380**

**Calibration Parameter Determined in Head Tissue Simulating Media**

f [MHz] <sup>C</sup>	Relative Permittivity <sup>F</sup>	Conductivity (S/m) <sup>F</sup>	ConvF X	ConvF Y	ConvF Z	Alpha <sup>G</sup>	Depth <sup>G</sup> (mm)	Unct. (k=2)
750	41.9	0.89	10.02	10.02	10.02	0.17	1.27	±12.7%
835	41.5	0.90	9.62	9.62	9.62	0.18	1.30	±12.7%
1750	40.1	1.37	8.35	8.35	8.35	0.28	1.02	±12.7%
1900	40.0	1.40	8.05	8.05	8.05	0.24	1.11	±12.7%
2100	39.8	1.49	8.00	8.00	8.00	0.24	1.11	±12.7%
2300	39.5	1.67	7.75	7.75	7.75	0.65	0.67	±12.7%
2450	39.2	1.80	7.50	7.50	7.50	0.65	0.69	±12.7%
2600	39.0	1.96	7.35	7.35	7.35	0.47	0.85	±12.7%
3500	37.9	2.91	6.85	6.85	6.85	0.41	1.03	±13.9%
3700	37.7	3.12	6.69	6.69	6.69	0.43	1.03	±13.9%
3900	37.5	3.32	6.58	6.58	6.58	0.30	1.50	±13.9%
4100	37.2	3.53	6.62	6.62	6.62	0.35	1.25	±13.9%
4200	37.1	3.63	6.52	6.52	6.52	0.30	1.45	±13.9%
4400	36.9	3.84	6.44	6.44	6.44	0.30	1.50	±13.9%
4600	36.7	4.04	6.41	6.41	6.41	0.35	1.48	±13.9%
4800	36.4	4.25	6.36	6.36	6.36	0.35	1.50	±13.9%
4950	36.3	4.40	5.95	5.95	5.95	0.35	1.55	±13.9%
5250	35.9	4.71	5.45	5.45	5.45	0.40	1.55	±13.9%
5600	35.5	5.07	4.86	4.86	4.86	0.45	1.40	±13.9%
5750	35.4	5.22	4.96	4.96	4.96	0.45	1.40	±13.9%

<sup>C</sup> Frequency validity above 300 MHz of ±100MHz only applies for DASY v4.4 and higher (Page 2), else it is restricted to ±50MHz. The uncertainty is the RSS of ConvF uncertainty at calibration frequency and the uncertainty for the indicated frequency band. Frequency validity below 300 MHz is ± 10, 25, 40, 50 and 70 MHz for ConvF assessments at 30, 64, 128, 150 and 220 MHz respectively. Above 5 GHz frequency validity can be extended to ± 110 MHz.

<sup>F</sup> At frequency up to 6 GHz, the validity of tissue parameters ( $\epsilon$  and  $\sigma$ ) can be relaxed to ±10% if liquid compensation formula is applied to measured SAR values. The uncertainty is the RSS of the ConvF uncertainty for indicated target tissue parameters.

<sup>G</sup> Alpha/Depth are determined during calibration. SPEAG warrants that the remaining deviation due to the boundary effect after compensation is always less than ± 1% for frequencies below 3 GHz and below ± 2% for the frequencies between 3-6 GHz at any distance larger than half the probe tip diameter from the boundary.



In Collaboration with  
**s p e a g**  
CALIBRATION LABORATORY



Add: No.52 HuaYuanBei Road, Haidian District, Beijing, 100191, China  
Tel: +86-10-62304633-2117  
E-mail: emf@caict.ac.cn <http://www.caict.ac.cn>

### Frequency Response of E-Field (TEM-Cell: ifi110 EXX, Waveguide: R22)

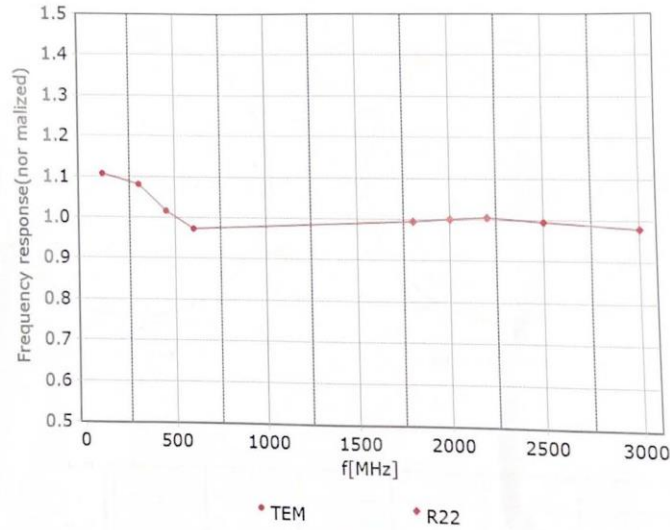

Uncertainty of Frequency Response of E-field:  $\pm 7.4\%$  ( $k=2$ )

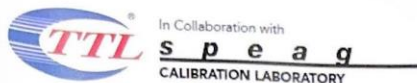

Add: No.52 HuaYuanBei Road, Haidian District, Beijing, 100191, China  
Tel: +86-10-62304633-2117  
E-mail: emf@caict.ac.cn http://www.caict.ac.cn

### Receiving Pattern ( $\Phi$ ), $\theta=0^\circ$

f=600 MHz, TEM

f=1800 MHz, R22

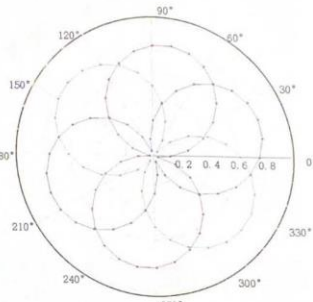
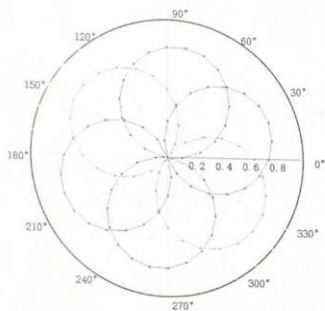

-- Tot -- X -- Y -- Z

-- Tot -- X -- Y -- Z

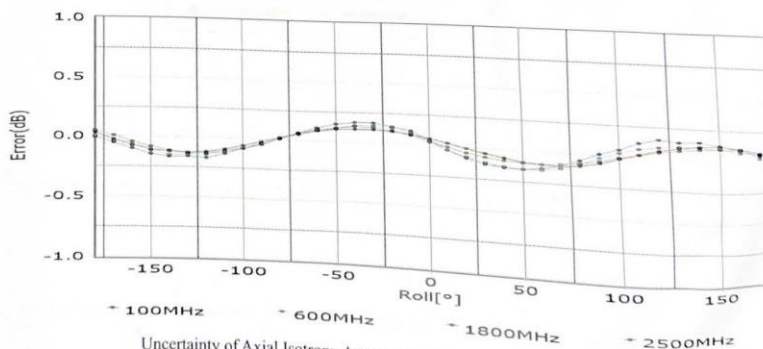

Uncertainty of Axial Isotropy Assessment:  $\pm 1.2\%$  ( $k=2$ )



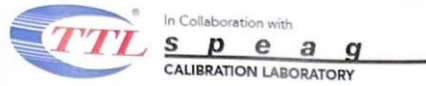

Add: No.52 HuaYuanBei Road, Haidian District, Beijing, 100191, China  
Tel: +86-10-62304633-2117  
E-mail: emf@caict.ac.cn http://www.caict.ac.cn

### Dynamic Range f(SAR<sub>head</sub>) (TEM cell, f = 900 MHz)

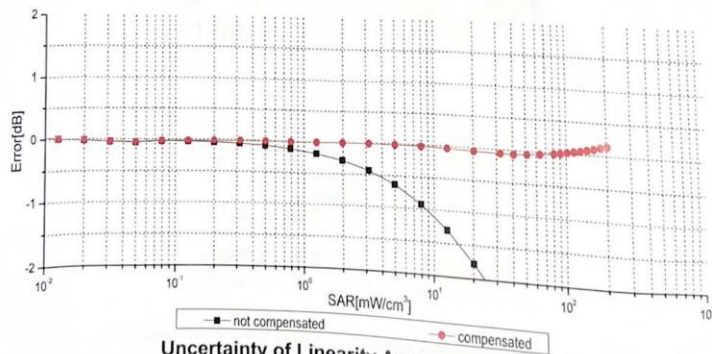
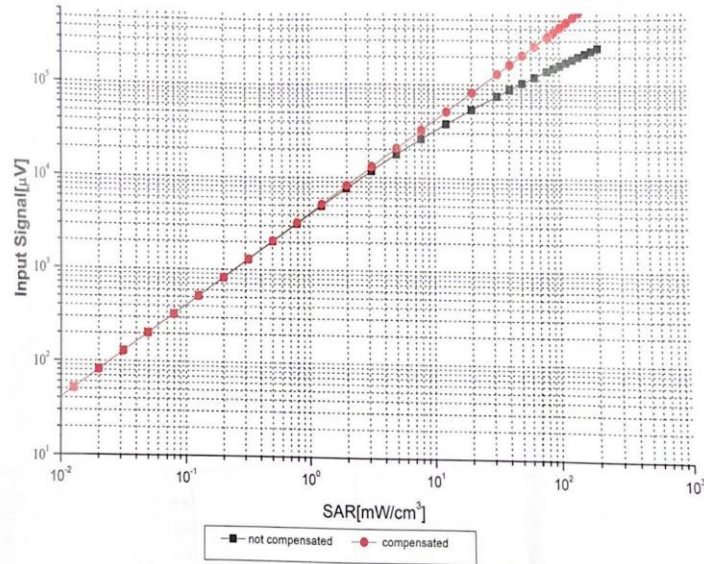

Uncertainty of Linearity Assessment: ±0.9% (k=2)



In Collaboration with  
**s p e a g**  
CALIBRATION LABORATORY



Add: No.52 HuaYuanBei Road, Haidian District, Beijing, 100191, China  
Tel: +86-10-62304633-2117  
E-mail: emf@caict.ac.cn <http://www.caict.ac.cn>

### Conversion Factor Assessment

f=750 MHz,WGLS R9(H\_convF)

f=1750 MHz,WGLS R22(H\_convF)

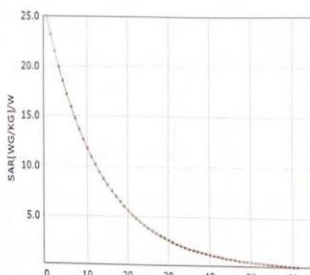
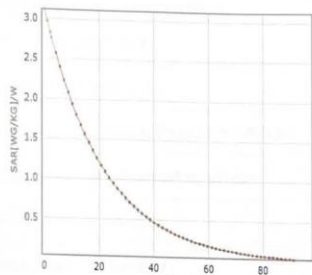

\*analytical \*measured

### Deviation from Isotropy in Liquid

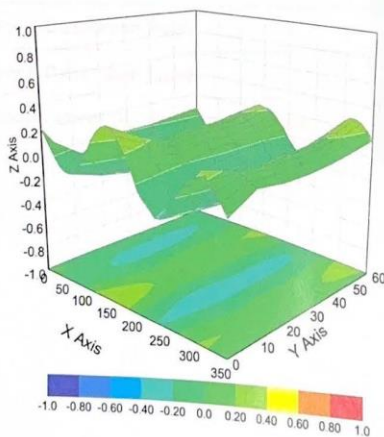

Uncertainty of Spherical Isotropy Assessment:  $\pm 3.2\%$  (k=2)

Certificate No:J23Z60276

Page 8 of 9

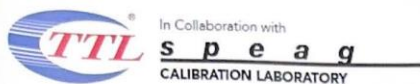

Add: No.52 HuaYuanBei Road, Haidian District, Beijing, 100191, China  
Tel: +86-10-62304633-2117  
E-mail: emf@caict.ac.cn http://www.caict.ac.cn

### DASY/EASY – Parameters of Probe: EX3DV4 – SN:7380

#### Other Probe Parameters

Sensor Arrangement	Triangular
Connector Angle (°)	83.7
Mechanical Surface Detection Mode	enabled
Optical Surface Detection Mode	disable
Probe Overall Length	337mm
Probe Body Diameter	10mm
Tip Length	9mm
Tip Diameter	2.5mm
Probe Tip to Sensor X Calibration Point	1mm
Probe Tip to Sensor Y Calibration Point	1mm
Probe Tip to Sensor Z Calibration Point	1mm
Recommended Measurement Distance from Surface	1.4mm



In Collaboration with  
**TTL Speag**  
 CALIBRATION LABORATORY  
 Add: No.52 HuaYuanBei Road, Haidian District, Beijing, 100191, China  
 Tel: +86-10-62304633-2117  
 E-mail: emf@caict.ac.cn <http://www.caict.ac.cn>



中国认可  
 国际互认  
 校准  
**CAICT**  
 CALIBRATION  
 CNAS L0570

Client : CTA

Certificate No: J23Z60391

**CALIBRATION CERTIFICATE**

Object: DAE3 - SN: 428  
 Calibration Procedure(s): FF-Z11-002-01  
 Calibration Procedure for the Data Acquisition Electronics (DAEx)  
 Calibration date: August 30, 2023

This calibration Certificate documents the traceability to national standards, which realize the physical units of measurements(SI). The measurements and the uncertainties with confidence probability are given on the following pages and are part of the certificate.

All calibrations have been conducted in the closed laboratory facility: environment temperature(22±3)°C and humidity<70%.

Calibration Equipment used (M&TE critical for calibration)

Primary Standards	ID #	Cal Date(Calibrated by, Certificate No.)	Scheduled Calibration
Process Calibrator 753	1971018	12-Jun-23 (CTTL, No.J23X05436)	Jun-24

	Name	Function	Signature
Calibrated by:	Yu Zongying	SAR Test Engineer	
Reviewed by:	Lin Hao	SAR Test Engineer	
Approved by:	Qi Dianyuan	SAR Project Leader	

Issued: September 06, 2023

This calibration certificate shall not be reproduced except in full without written approval of the laboratory.





In Collaboration with  
**s p e a g**  
CALIBRATION LABORATORY



Add: No.52 HuaYuanBei Road, Haidian District, Beijing, 100191, China  
Tel: +86-10-62304633-2117  
E-mail: [cmf@caict.ac.cn](mailto:cmf@caict.ac.cn) <http://www.caict.ac.cn>

**Glossary:**

DAE data acquisition electronics  
Connector angle information used in DASYS system to align probe sensor X to the robot coordinate system.

**Methods Applied and Interpretation of Parameters:**

- *DC Voltage Measurement:* Calibration Factor assessed for use in DASYS system by comparison with a calibrated instrument traceable to national standards. The figure given corresponds to the full scale range of the voltmeter in the respective range.
- *Connector angle:* The angle of the connector is assessed measuring the angle mechanically by a tool inserted. Uncertainty is not required.
- The report provide only calibration results for DAE, it does not contain other performance test results.



Add: No.52 HuaYuanBei Road, Haidian District, Beijing, 100191, China  
Tel: +86-10-62304633-2117  
E-mail: emf@caict.ac.cn <http://www.caict.ac.cn>

**DC Voltage Measurement**

A/D - Converter Resolution nominal  
High Range: 1LSB = 6.1 $\mu$ V, full range = -100...+300 mV  
Low Range: 1LSB = 61nV, full range = -1.....+3mV  
DASY measurement parameters: Auto Zero Time: 3 sec; Measuring time: 3 sec

Calibration Factors	X	Y	Z
High Range	404.468 $\pm$ 0.15% (k=2)	404.804 $\pm$ 0.15% (k=2)	404.579 $\pm$ 0.15% (k=2)
Low Range	3.95934 $\pm$ 0.7% (k=2)	3.95437 $\pm$ 0.7% (k=2)	3.91875 $\pm$ 0.7% (k=2)

**Connector Angle**

Connector Angle to be used in DASY system	258.5 $^{\circ}$ $\pm$ 1 $^{\circ}$
---	-------------------------------------





In Collaboration with  
 Add: No.52 HuaYuanBei Road, Haidian District, Beijing, 100191  
 Tel: +86-10-62304633-2117  
 E-mail: emf@caict.ac.cn http://www.caict.ac.cn



Client CTA

Certificate No: J23Z60387

**CALIBRATION CERTIFICATE**

Object D835V2 - SN: 484  
 Calibration Procedure(s) FF-Z11-003-01  
 Calibration Procedures for dipole validation kits  
 Calibration date: August 25, 2023

This calibration Certificate documents the traceability to national standards, which realize the physical units of measurements (SI). The measurements and the uncertainties with confidence probability are given on the following pages and are part of the certificate.

All calibrations have been conducted in the closed laboratory facility: environment temperature (22±3)°C and humidity<70%.

Calibration Equipment used (M&TE critical for calibration)

Primary Standards	ID #	Cal Date (Calibrated by, Certificate No.)	Scheduled Calibration
Power Meter NRP2	106277	22-Sep-22 (CTTL, No.J22X09561)	Sep-23
Power sensor NRP8S	104291	22-Sep-22 (CTTL, No.J22X09561)	Sep-23
Reference Probe EX3DV4	SN 3617	31-Mar-23(CTTL-SPEAG,No.Z23-60161)	Mar-24
DAE4	SN 1556	11-Jan-23(CTTL-SPEAG,No.Z23-60034)	Jan-24
Secondary Standards	ID #	Cal Date (Calibrated by, Certificate No.)	Scheduled Calibration
Signal Generator E4438C	MY49071430	05-Jan-23 (CTTL, No. J23X00107)	Jan-24
NetworkAnalyzer E5071C	MY46110673	10-Jan-23 (CTTL, No. J23X00104)	Jan-24

	Name	Function	Signature
Calibrated by:	Zhao Jing	SAR Test Engineer	
Reviewed by:	Lin Hao	SAR Test Engineer	
Approved by:	Qi Dianyuan	SAR Project Leader	

Issued: September 1, 2023

This calibration certificate shall not be reproduced except in full without written approval of the laboratory.



In Collaboration with  
**s p e a g**  
CALIBRATION LABORATORY



Add: No.52 HuaYuanBei Road, Haidian District, Beijing, 100191, China  
Tel: +86-10-62304633-2117  
E-mail: emf@caict.ac.cn http://www.caict.ac.cn

**Glossary:**

TSL	tissue simulating liquid
ConvF	sensitivity in TSL / NORM <sub>x,y,z</sub>
N/A	not applicable or not measured

**Calibration is Performed According to the Following Standards:**

- a) IEC/IEEE 62209-1528, "Measurement Procedure for The Assessment of Specific Absorption Rate of Human Exposure to Radio Frequency Fields from Hand-held and Body-mounted Wireless Communication Devices- Part 1528: Human Models, Instrumentation and Procedures (Frequency range of 4 MHz to 10 GHz)", October 2020
- b) KDB 865664, "SAR Measurement Requirements for 100 MHz to 6 GHz"

**Additional Documentation:**

- c) DAS4/5 System Handbook

**Methods Applied and Interpretation of Parameters:**

- *Measurement Conditions:* Further details are available from the Validation Report at the end of the certificate. All figures stated in the certificate are valid at the frequency indicated.
- *Antenna Parameters with TSL:* The dipole is mounted with the spacer to position its feed point exactly below the center marking of the flat phantom section, with the arms oriented parallel to the body axis.
- *Feed Point Impedance and Return Loss:* These parameters are measured with the dipole positioned under the liquid filled phantom. The impedance stated is transformed from the measurement at the SMA connector to the feed point. The Return Loss ensures low reflected power. No uncertainty required.
- *Electrical Delay:* One-way delay between the SMA connector and the antenna feed point. No uncertainty required.
- *SAR measured:* SAR measured at the stated antenna input power.
- *SAR normalized:* SAR as measured, normalized to an input power of 1 W at the antenna connector.
- *SAR for nominal TSL parameters:* The measured TSL parameters are used to calculate the nominal SAR result.

The reported uncertainty of measurement is stated as the standard uncertainty of Measurement multiplied by the coverage factor  $k=2$ , which for a normal distribution Corresponds to a coverage probability of approximately 95%.