

# Test Report

**Product:** Magnetic wireless charging  
**Trade Mark:** N/A  
**Model Number:** AW-P307  
**FCC ID:** 2BE7M-AWP307

**Prepared for**

Shenzhen Awell Technology Co., LTD  
4/F, Building C, Student Industrial Park, Hongqiaotou Community, Songgang  
Street, Bao 'an District, Shenzhen

**Prepared by**

Shenzhen HongBiao Certification& Testing Co., Ltd  
Room 102, 201, Building 2, Yuanwanggu RFID Industrial Park, Tongguan  
Road, Tianliao Community, Yutang Street, Guangming District, Shenzhen,  
China  
Tel.: +86-755-2998 9321 Fax.: +86-755-2998 5110  
Website: <http://www.sz-hongbiao.com>

---

## Table of Contents

|          |   |           |
|----------|---|-----------|
| <b>1</b> | <b>GENERAL DESCRIPTION .....</b>                | <b>5</b>  |
| 1.1      | DESCRIPTION OF EUT .....                        | 5         |
| 1.2      | TEST MODE.....                                  | 5         |
| 1.3      | TEST SETUP .....                                | 5         |
| 1.4      | ANCILLARY EQUIPMENT .....                       | 6         |
| <b>2</b> | <b>SUMMARY OF TEST RESULT .....</b>             | <b>7</b>  |
| <b>3</b> | <b>TEST FACILITIES AND ACCREDITATIONS .....</b> | <b>8</b>  |
| 3.1      | TEST LABORATORY .....                           | 8         |
| 3.2      | ENVIRONMENTAL CONDITIONS .....                  | 8         |
| 3.3      | MEASUREMENT UNCERTAINTY .....                   | 8         |
| 3.4      | TEST SOFTWARE .....                             | 8         |
| <b>4</b> | <b>LIST OF TEST EQUIPMENT .....</b>             | <b>9</b>  |
| <b>5</b> | <b>TEST ITEM AND RESULTS.....</b>               | <b>11</b> |
| 5.1      | ANTENNA REQUIREMENT .....                       | 11        |
| 5.2      | CONDUCTED EMISSION.....                         | 12        |
| 5.3      | RADIATED EMISSION .....                         | 16        |
| 5.4      | OCCUPIED BANDWIDTH .....                        | 21        |
| <b>6</b> | <b>PHOTOGRAPHS OF THE TEST SETUP.....</b>       | <b>22</b> |
| <b>7</b> | <b>PHOTOGRAPHS OF THE EUT.....</b>              | <b>24</b> |

**TEST RESULT CERTIFICATION**

**Applicant's Name**..... : Shenzhen Awell Technology Co., LTD  
**Address** ..... : 4/F, Building C, Student Industrial Park, Hongqiaotou  
Community, Songgang Street, Bao 'an District, Shenzhen

**Manufacturer's Name** ..... : Shenzhen Awell Technology Co., LTD  
**Address** ..... : 4/F, Building C, Student Industrial Park, Hongqiaotou  
Community, Songgang Street, Bao 'an District, Shenzhen

**Product description**

**Product name** ..... : Magnetic wireless charging  
**Model Number** ..... : AW-P307

**Standards** ..... : FCC Part 15C  
**Test procedure**..... : IEEE/ANSI C63.10-2020

This device described above has been tested by Shenzhen HongBiao Certification & Testing Co., Ltd and the test results show that the equipment under test (EUT) is in compliance with the EMC requirements. And it is applicable only to the tested sample identified in the report.

**Date of Test** ..... :  
**Date (s) of performance of tests**..... : Mar. 01, 2024~Mar. 14, 2024  
**Test Result**..... : **Pass**

**Testing Engineer** :   
**( Z o e S u )**

**Technical Manager** :   
**( G a r y L u )**

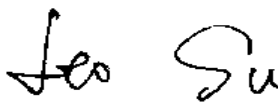
**Authorized Signatory** :   
**( L e o S u )**

**Revision History**

| Revised No. | Date of Issue | Description |
|-------------|---------------|-------------|
| 01          | Mar. 14, 2024 | Original    |
|             |               |             |
|             |               |             |
|             |               |             |
|             |               |             |
|             |               |             |
|             |               |             |
|             |               |             |
|             |               |             |
|             |               |             |
|             |               |             |
|             |               |             |
|             |               |             |
|             |               |             |
|             |               |             |
|             |               |             |
|             |               |             |
|             |               |             |
|             |               |             |
|             |               |             |
|             |               |             |
|             |               |             |
|             |               |             |
|             |               |             |
|             |               |             |
|             |               |             |
|             |               |             |
|             |               |             |
|             |               |             |
|             |               |             |
|             |               |             |
|             |               |             |
|             |               |             |
|             |               |             |

# 1 General Description

## 1.1 Description of EUT

|                            |  |
|----------------------------|--|
| Product name:              | Magnetic wireless charging   |
| Model name:                | AW-P307  |
| Series Model:              | N/A  |
| Different of series model: | N/A  |
| Operation frequency:       | 115kHz-205kHz  |
| Operational mode:          | Wireless charging  |
| Modulation type:           | FSK  |
| Antenna type:              | Coil Antenna   |
| Hardware version:          | V1.0   |
| Software version:          | V1.0   |
| Battery:                   | N/A  |
| Power supply:              | Input: DC 5V/3A, 9V/2.22A<br>Wireless Output: 5W, 7.5W, 10W, 15W (Max) |
| Adapter information:       | N/A  |

## 1.2 Test Mode

| Pretest Test Mode | Description of Mode   |
|-------------------|-----------------------|
| 1                 | Wireless Output: 5W   |
| 2                 | Wireless Output: 7.5W |
| 3                 | Wireless Output: 10W  |
| 4                 | Wireless Output: 15W  |

| Test Item           | Final Test Mode |
|---------------------|-----------------|
| Conducted Emissions | 3               |
| Radiated Emissions  | 4               |
| 20dB bandwidth      | 2               |

Note: All modes have been tested, and the report only reflects the test results of the worst mode (Final Test Mode).

## 1.3 Test Setup

See photographs of the test setup in the report for the actual setup and connections between EUT and support equipment.

### 1.4 Ancillary Equipment

| Equipment | Model  | S/N                      | Manufacturer                                      |
|-----------|--------|--------------------------|---|
| Adapter   | TA65B  | 2S36003438PL97<br>T09582 | Nanjing Bolande Electronic<br>Technology Co., Ltd |
| Load      | YBZ1.1 | 566712                   | YBZ   |
|           |        |                          |   |
|           |        |                          |   |
|           |        |                          |   |
|           |        |                          |   |

## 2 Summary of Test Result

Test procedures according to the technical standards:

| FCC Part 15C |                  |                     |        |        |
|--------------|------------------|---------------------|--------|--------|
| No.          | Standard Section | Test Item           | Result | Remark |
| 1            | FCC Part 15.203  | Antenna Requirement | Pass   |        |
| 2            | FCC Part 15.207  | Conducted Emission  | Pass   |        |
| 3            | FCC Part 15.209  | Radiated Emission   | Pass   |        |
| 4            | FCC Part 15.215  | 20dB Bandwidth      | Pass   |        |

Note:  
1. "N/A" means the test case does not apply to the test object.

### 3 Test Facilities and Accreditations

#### 3.1 Test Laboratory

|                       |   |
|-----------------------|---|
| Test Site             | Shenzhen HongBiao Certification& Testing Co., Ltd   |
| Test Site Location    | Room 102, 201, Building 2, Yuanwanggu RFID Industrial Park, Tongguan Road, Tianliao Community, Yutang Street, Guangming District, Shenzhen, China |
| Telephone:            | (86-755) 2998 9321  |
| Fax:                  | (86-755) 2998 5110  |
| FCC Registration No.: | CN1341  |
| A2LA Certificate No.: | 6765.01   |

#### 3.2 Environmental Conditions

During the measurement the environmental conditions were within the listed ranges:

|                    |              |
|--------------------|--------------|
| Temperature:       | 15°C~35°C    |
| Relative Humidity: | 20%~75%      |
| Air Pressure:      | 98kPa~101kPa |

#### 3.3 Measurement Uncertainty

The reported uncertainty of measurement  $y \pm U$ , where expanded uncertainty  $U$  is based on a standard uncertainty multiplied by a coverage factor of  $k=2$ , providing a level of confidence of approximately 95 %.

| Measurement Frequency Range      | U, (dB)            | Note |
|----------------------------------|--------------------|------|
| RF frequency                     | $2 \times 10^{-5}$ |      |
| RF power, conducted              | $\pm 0.57$ dB      |      |
| Conducted emission(150kHz~30MHz) | $\pm 2.5$ dB       |      |
| Radiated emission(9kHz-30MHz)    | $\pm 2.5$ dB       |      |
| Radiated emission(30MHz~1GHz)    | $\pm 4.2$ dB       |      |
| Radiated emission (above 1GHz)   | $\pm 4.7$ dB       |      |
| Occupied Bandwidth               | $\pm 3\%$          |      |
| Temperature                      | $\pm 1$ degree     |      |
| Humidity                         | $\pm 5 \%$         |      |

#### 3.4 Test Software

| Software name         | Manufacturer | Model    | Version  |
|-----------------------|--------------|----------|----------|
| EMI Measurement       | Farad        | EZ-EMC   | V1.1.4.2 |
| Conducted test system | MWRF-test    | MTS 8310 | V2.0.0   |



## 4 List of Test Equipment

| Radiation emission  |               |  |              |             |              |                  |            |
|---------------------|---------------|--|--------------|-------------|--------------|------------------|------------|
| Item                | Equipment No. | Equipment name                           | Manufacturer | Model       | Serial No.   | Calibration date | Due date   |
| 1                   | HB-E001       | Horn Antenna                             | Schwarzbeck  | BBHA 9120D  | 02592        | 2022-04-02       | 2024-04-01 |
| 2                   | HB-E002       | Biconical log-periodic composite antenna | Schwarzbeck  | VULB 9168   | 01340        | 2022-04-06       | 2024-04-05 |
| 3                   | HB-E003       | SHF-EHF Horn                             | Schwarzbeck  | BBHA 91270  | 01193        | 2022-04-02       | 2024-04-01 |
| 4                   | HB-E004       | Preamplifier                             | Noyetec      | LAN-0910    | NYCM1420101  | 2023-05-11       | 2024-05-10 |
| 5                   | HB-E005       | Preamplifier                             | Noyetec      | LAN-0118    | NYCM1420102  | 2023-05-12       | 2024-05-11 |
| 6                   | HB-E006       | Preamplifier                             | Noyetec      | LAN-1840    | NYCM1420103  | 2023-06-11       | 2024-06-10 |
| 7                   | HB-E007       | EMI TEST RECEIVER                        | R&S          | ESR7        | 102520       | 2023-05-12       | 2024-05-11 |
| 8                   | HB-E009       | POSITINAL COTROLLE R                     | Noyetec      | N/A         | N/A          | /                | /          |
| 9                   | HB-E013       | RF switch                                | Noyetec      | NY-RF4      | NY0CM1420204 | /                | /          |
| 10                  | HB-E066       | Illuminance Tester                       | TASI         | TA8121      | N/A          | 2023-05-11       | 2024-05-10 |
| 11                  | HB-E075       | Active loop antenna                      | Schwarzbeck  | FMZB 1519B  | 1519B-245    | 2022-07-24       | 2024-07-23 |
| Conduction emission |               |  |              |             |              |                  |            |
| Item                | Equipment No. | Equipment name                           | Manufacturer | Model       | Serial No.   | Calibration date | Due date   |
| 1                   | HB-E014       | 4 Path V-LISN                            | Schwarzbeck  | NNLK 8121   | 00770        | 2023-05-12       | 2024-05-11 |
| 2                   | HB-E015       | Pulse Limiter                            | Schwarzbeck  | VTSD 9561-F | 00949        | 2023-05-12       | 2024-05-11 |
| 3                   | HB-E016       | ZN23201                                  | Noyetec      | ZN23201     | N/A          | 2023-05-11       | 2024-05-10 |
| 4                   | HB-E059       | Attenuator                               | Xianghua     | TS2-6-1     | 220215166    | 2023-05-12       | 2024-05-11 |
| 5                   | HB-E069       | EMI TEST RECEIVER                        | R&S          | ESCI        | N/A          | 2023-05-12       | 2024-05-11 |
| RF                  |               |  |              |             |              |                  |            |
| Item                | Equipment No. | Equipment name                           | Manufacturer | Model       | Serial No.   | Calibration date | Due date   |
| 1                   | HB-E041       | MXG Anaioq Signal Generator              | Agilent      | N5181A      | MY47070421   | 2023-05-11       | 2024-05-10 |
| 2                   | HB-E042       | WIDEBAND RADIO COMMUNICA                 | R&S          | CMW500      | 132108       | 2023-05-11       | 2024-05-10 |

|   |         | TION TESTER                              |         |                |            |            |            |
|---|---------|--|---------|----------------|------------|------------|------------|
| 3 | HB-E043 | MXG Anaioq<br>Signal<br>Generator        | Agilent | N5182A         | US46240335 | 2023-05-11 | 2024-05-10 |
| 4 | HB-E044 | Signal&<br>spectrum<br>Analyzer          | R&S     | FSV3044        | 101264     | 2023-05-11 | 2024-05-10 |
| 5 | HB-E045 | RF Control<br>Box                        | Noyetec | NY100-R<br>FCB | N/A        | /          | /          |
| 6 | HB-E058 | Thermometer<br>Clock Humidity<br>Monitor | N/A     | HTC-1          | N/A        | /          | /          |

Note: the calibration interval of the above test instruments is 12&24 months and the calibrations are traceable to international system unit (SI).

## **5 Test Item And Results**

### **5.1 Antenna Requirement**

#### **5.1.1 Standard Requirement**

15.203 requirement: For intentional device, according to 15.203: an intentional radiator shall be designed to ensure that no antenna other than that furnished by the responsible party shall be used with the device

#### **5.1.2 Test Result**

The EUT antenna is Coil Antenna. It comply with the standard requirement. In case of replacement of broken antenna the same antenna type must be used.

## 5.2 Conducted Emission

### 5.2.1 Limits

| Limits – Class A  |              |           |
|---|--------------|-----------|
| Frequency (MHz)   | Limit (dBµV) |           |
|   | Quasi-Peak   | Average   |
| 0.15 to 0.5   | 79           | 66        |
| 0.5 to 30   | 73           | 60        |
| Limits – Class B  |              |           |
| Frequency (MHz)   | Limit (dBµV) |           |
|   | Quasi-Peak   | Average   |
| 0.15 to 0.5   | 66 to 56*    | 56 to 46* |
| 0.5 to 5  | 56           | 46        |
| 5 to 30   | 60           | 50        |
| Note:<br>1. the tighter limit applies at the band edges.<br>2. the limit of " * " marked band means the limitation decreases linearly with the logarithm of the frequency in the range. |              |           |

### 5.2.2 Test Procedures

- a) The EUT was placed 0.8 meters from the horizontal ground plane with EUT being connected to the power mains through a line impedance stabilization network (LISN). All other support equipment powered from additional LISN(s). The LISN provide 50 Ohm/ 50uH of coupling impedance for the measuring instrument.
- b) Interconnecting cables that hang closer than 40 cm to the ground plane shall be folded back and forth in the center forming a bundle 30 to 40 cm long.
- c) I/O cables that are not connected to a peripheral shall be bundled in the center. The end of the cable may be terminated, if required, using the correct terminating impedance. The overall length shall not exceed 1 m.
- d) LISN is at least 80 cm from nearest part of EUT chassis.
- e) For the actual test configuration, please refer to the related Item – photographs of the test setup.

### 5.2.3 Test setup

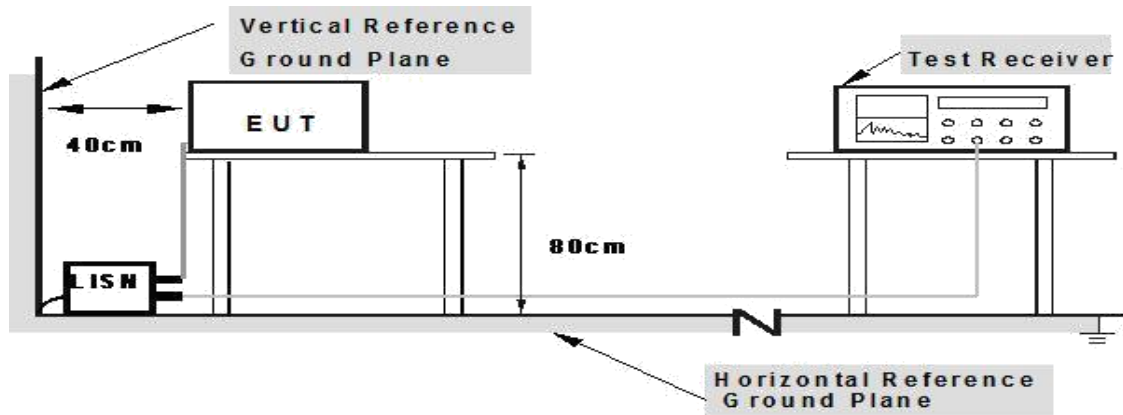

### 5.2.4 Test Result

|               |                                 |             |         |
|---------------|---------------------------------|-------------|---------|
| EUT:          | Magnetic wireless charging      | Model Name: | AW-P307 |
| Test Mode:    | Mode 3                          | Phase:      | L       |
| Test Voltage: | DC 9V from adapter AC 120V/60Hz |             |         |

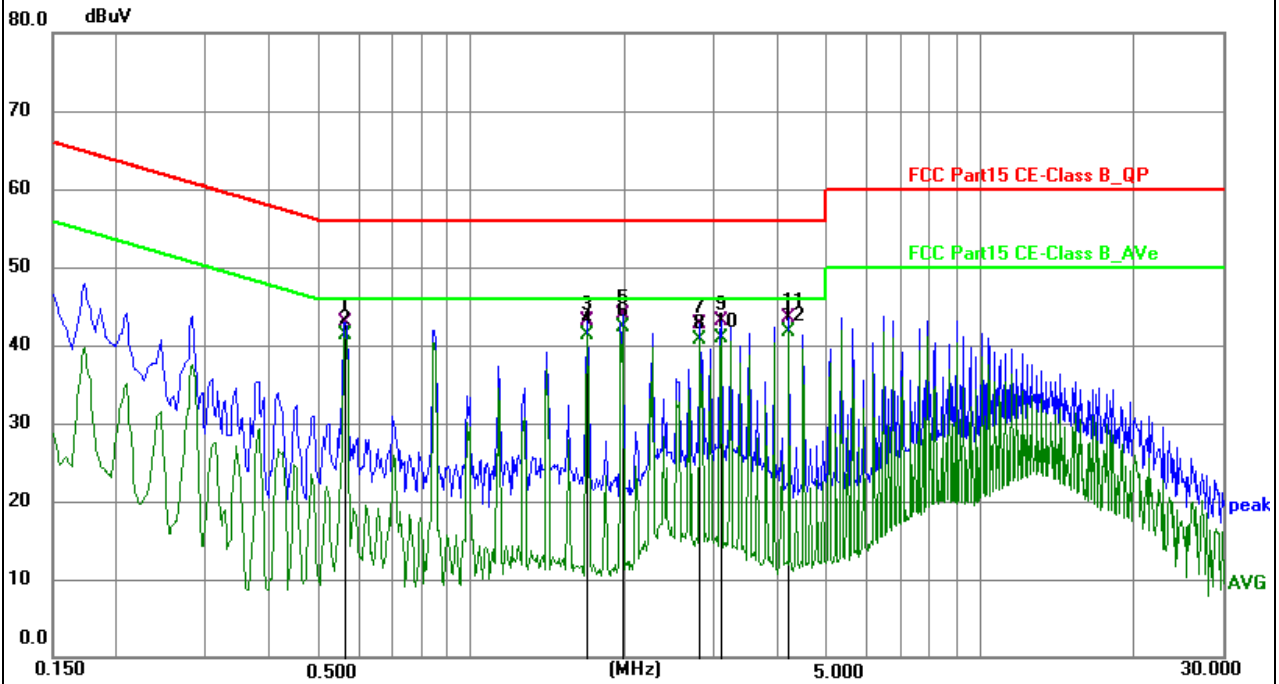

| No. | Frequency (MHz) | Reading (dBuV) | Factor (dB) | Level (dBuV) | Limit (dBuV) | Margin (dB) | Detector |
|-----|-----------------|----------------|-------------|--------------|--------------|-------------|----------|
| 1   | 0.563900        | 32.90          | 10.07       | 42.97        | 56.00        | -13.03      | QP       |
| 2   | 0.563900        | 31.23          | 10.07       | 41.30        | 46.00        | -4.70       | AVG      |
| 3   | 1.684500        | 32.99          | 10.02       | 43.01        | 56.00        | -12.99      | QP       |
| 4   | 1.684500        | 31.24          | 10.02       | 41.26        | 46.00        | -4.74       | AVG      |
| 5   | 1.981500        | 33.81          | 10.00       | 43.81        | 56.00        | -12.19      | QP       |
| 6 * | 1.981500        | 32.37          | 10.00       | 42.37        | 46.00        | -3.63       | AVG      |
| 7   | 2.809500        | 32.75          | 9.94        | 42.69        | 56.00        | -13.31      | QP       |
| 8   | 2.809500        | 30.81          | 9.94        | 40.75        | 46.00        | -5.25       | AVG      |
| 9   | 3.093000        | 33.11          | 9.93        | 43.04        | 56.00        | -12.96      | QP       |
| 10  | 3.093000        | 31.05          | 9.93        | 40.98        | 46.00        | -5.02       | AVG      |
| 11  | 4.213500        | 33.74          | 9.85        | 43.59        | 56.00        | -12.41      | QP       |
| 12  | 4.213500        | 31.86          | 9.85        | 41.71        | 46.00        | -4.29       | AVG      |

|               |                                 |             |         |
|---------------|---------------------------------|-------------|---------|
| EUT:          | Magnetic wireless charging      | Model Name: | AW-P307 |
| Test Mode:    | Mode 3                          | Phase:      | N       |
| Test Voltage: | DC 9V from adapter AC 120V/60Hz |             |         |

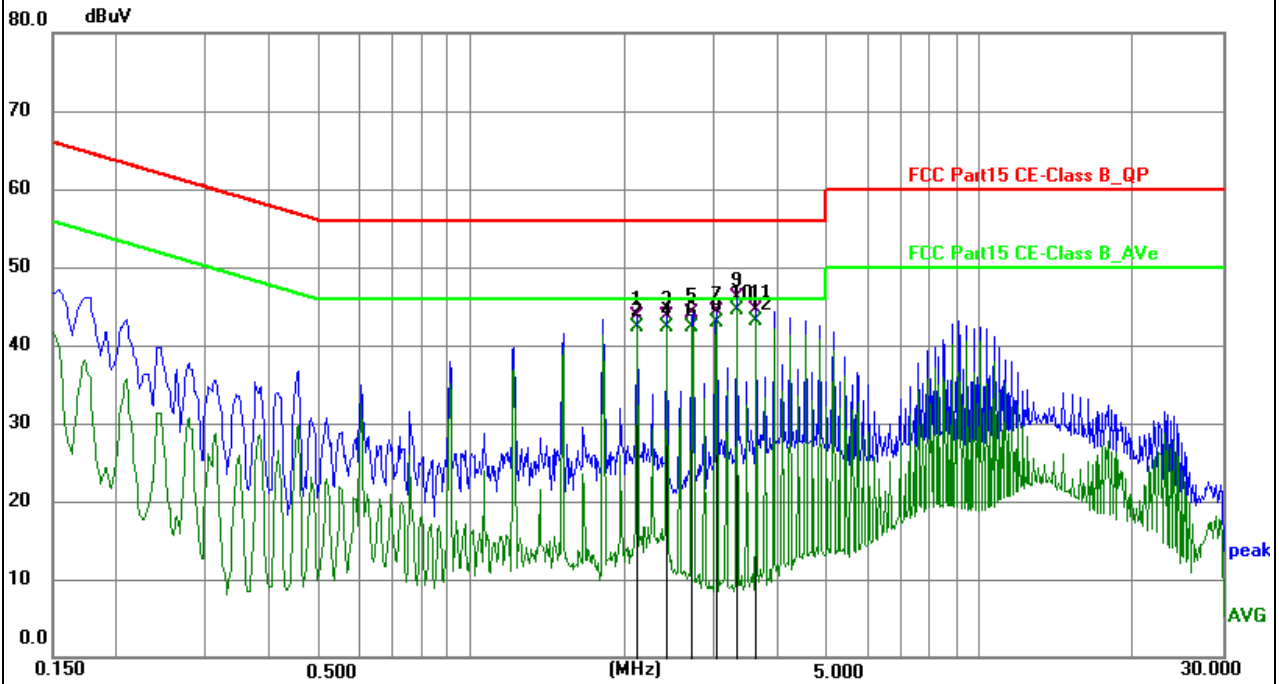

| No.  | Frequency (MHz) | Reading (dBuV) | Factor (dB) | Level (dBuV) | Limit (dBuV) | Margin (dB) | Detector |
|------|-----------------|----------------|-------------|--------------|--------------|-------------|----------|
| 1    | 2.116500        | 33.73          | 10.00       | 43.73        | 56.00        | -12.27      | QP       |
| 2    | 2.116500        | 32.26          | 10.00       | 42.26        | 46.00        | -3.74       | AVG      |
| 3    | 2.418000        | 33.76          | 9.96        | 43.72        | 56.00        | -12.28      | QP       |
| 4    | 2.418000        | 32.27          | 9.96        | 42.23        | 46.00        | -3.77       | AVG      |
| 5    | 2.723900        | 34.19          | 9.95        | 44.14        | 56.00        | -11.86      | QP       |
| 6    | 2.723900        | 32.45          | 9.95        | 42.40        | 46.00        | -3.60       | AVG      |
| 7    | 3.025500        | 34.43          | 9.93        | 44.36        | 56.00        | -11.64      | QP       |
| 8    | 3.025500        | 33.03          | 9.93        | 42.96        | 46.00        | -3.04       | AVG      |
| 9    | 3.327000        | 36.16          | 9.91        | 46.07        | 56.00        | -9.93       | QP       |
| 10 * | 3.327000        | 34.58          | 9.91        | 44.49        | 46.00        | -1.51       | AVG      |
| 11   | 3.628500        | 34.65          | 9.88        | 44.53        | 56.00        | -11.47      | QP       |
| 12   | 3.628500        | 33.20          | 9.88        | 43.08        | 46.00        | -2.92       | AVG      |

## 5.3 Radiated Emission

### 5.3.1 Limits

| Frequencies (MHz) | Field Strength (micorvolts/meter) | Measurement Distance (meters) |
|-------------------|-----------------------------------|-------------------------------|
| 0.009~0.490       | 2400/F(KHz)                       | 300                           |
| 0.490~1.705       | 24000/F(KHz)                      | 30                            |
| 1.705~30.0        | 30                                | 30                            |
| 30~88             | 100                               | 3                             |
| 88~216            | 150                               | 3                             |
| 216~960           | 200                               | 3                             |
| Above 960         | 500                               | 3                             |

| Receiver Parameter     | Setting                          |
|------------------------|----------------------------------|
| Attenuation            | Auto                             |
| Start ~ Stop Frequency | 9kHz~150kHz / RB 200Hz for QP    |
| Start ~ Stop Frequency | 150kHz~30MHz / RB 9kHz for QP    |
| Start ~ Stop Frequency | 30MHz~1000MHz / RB 120kHz for QP |

### 5.3.2 Test Procedures

- a) The radiated emission tests were performed in the 3 meters.
- b) The EUT was placed on the top of a rotating table 0.8 meters above the ground. The table was rotated 360 degrees to determine the position of the highest radiation.
- c) The height of the test antenna shall vary between 1m to 4m. Both horizontal and vertical polarizations of the antenna are set to make the measurement.
- d) If the peak mode measured value compliance with and lower than quasi peak mode limit, the EUT shall be deemed to meet QP limits and then no additional QP mode measurement performed.
- e) If the peak mode measured value compliance with and lower than average mode limit, the EUT shall be deemed to meet average limits and then no additional average mode measurement performed.
- f) For the actual test configuration, please refer to the related item – EUT test photos.

### 5.3.3 Test Setup



Radiated Emission Test-Up Frequency Below 30MHz

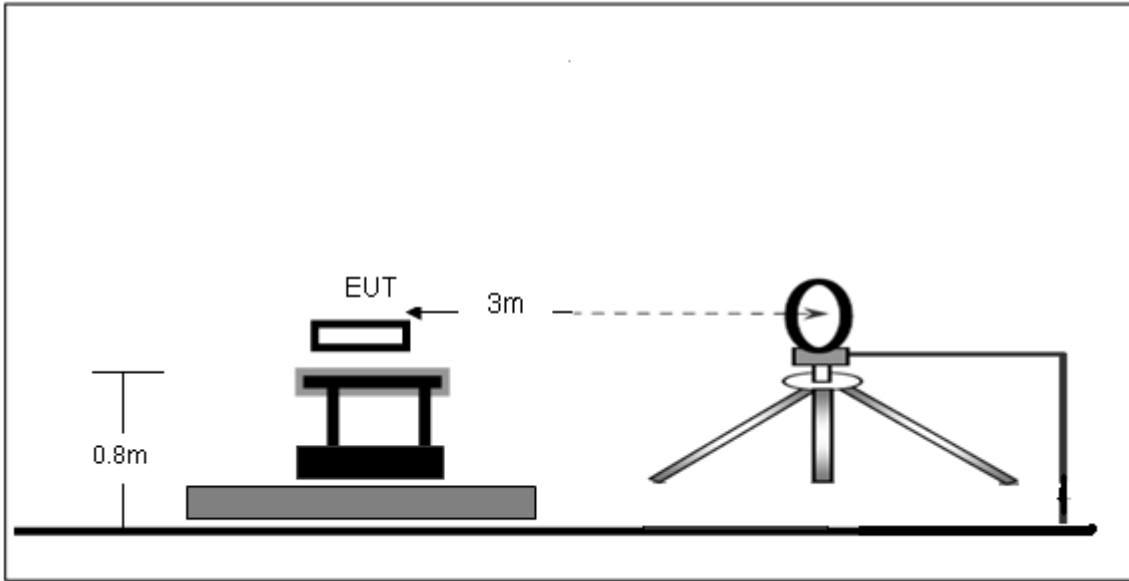

Radiated Emission Test-Up Frequency 30MHz~1GHz

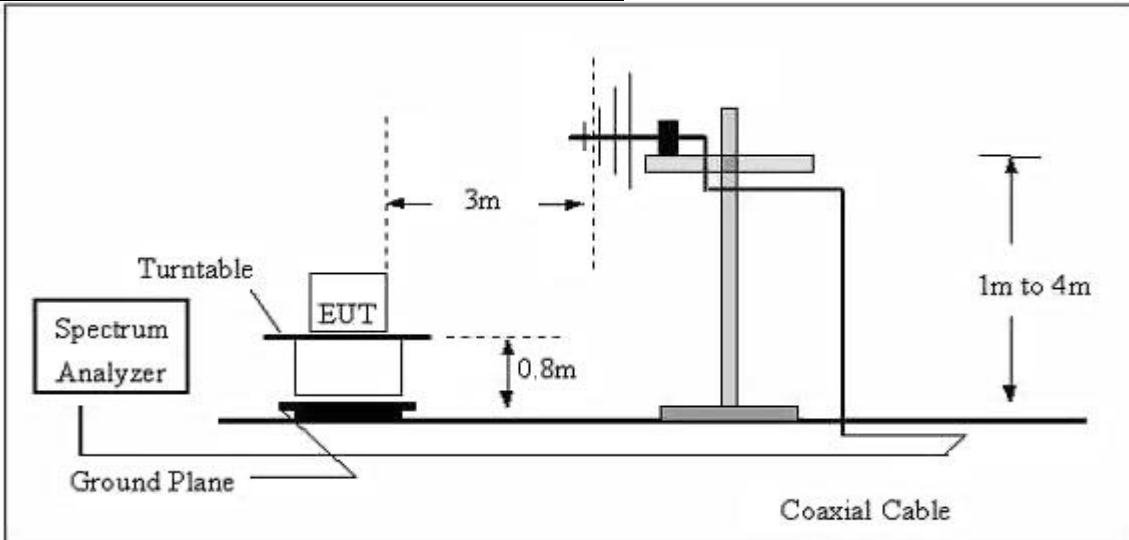

**5.3.4 Test Result**

Frequency range (9kHz – 30MHz)

|               |                                 |             |         |
|---------------|---------------------------------|-------------|---------|
| EUT:          | Magnetic wireless charging      | Model Name: | AW-P307 |
| Test Mode:    | Mode 4                          | Phase:      | Coaxial |
| Test Voltage: | DC 9V from adapter AC 120V/60Hz |             |         |

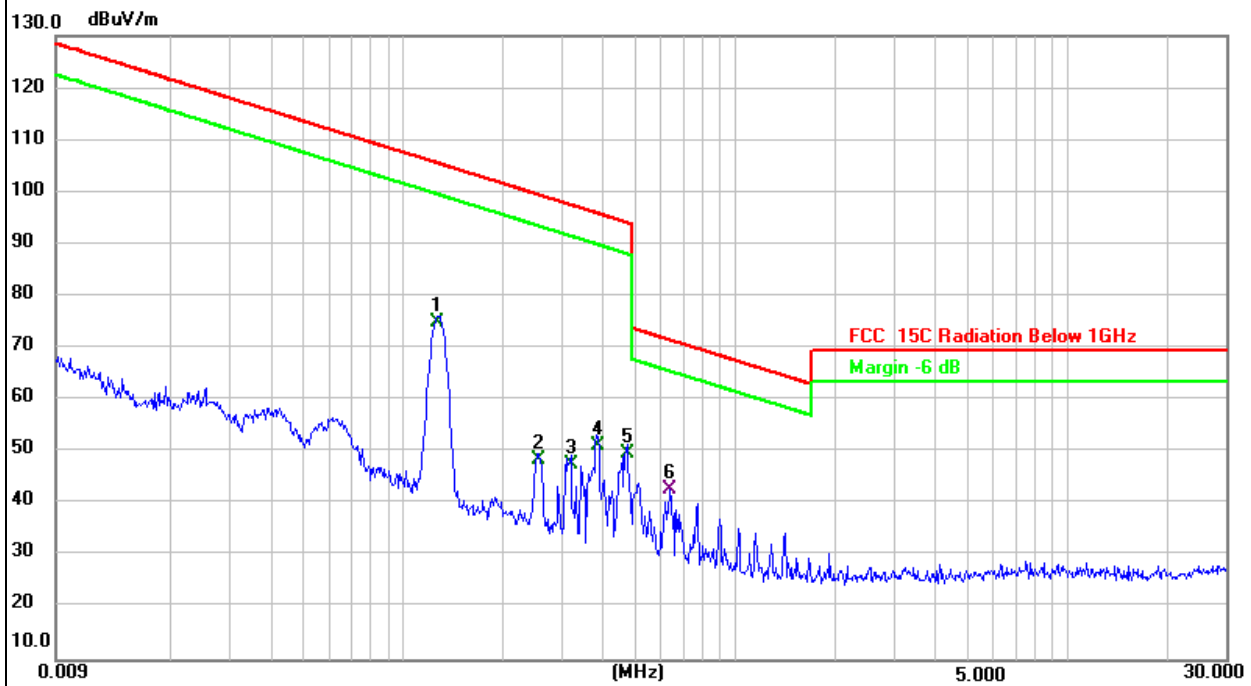

| No. | Frequency (MHz) | Reading (dBuV) | Factor (dB/m) | Level (dBuV/m) | Limit (dBuV/m) | Margin (dB) | Detector |
|-----|-----------------|----------------|---------------|----------------|----------------|-------------|----------|
| 1   | 0.1276          | 55.77          | 19.13         | 74.90          | 105.51         | -30.61      | AVG      |
| 2   | 0.2545          | 29.23          | 19.27         | 48.50          | 99.50          | -51.00      | AVG      |
| 3   | 0.3194          | 28.51          | 19.29         | 47.80          | 97.52          | -49.72      | AVG      |
| 4   | 0.3849          | 31.90          | 19.30         | 51.20          | 95.90          | -44.70      | AVG      |
| 5   | 0.4714          | 30.37          | 19.33         | 49.70          | 94.14          | -44.44      | AVG      |
| 6 * | 0.6363          | 23.51          | 19.35         | 42.86          | 71.54          | -28.68      | QP       |

Frequency range (30MHz – 1GHz)

|               |                                 |             |          |
|---------------|---------------------------------|-------------|----------|
| EUT:          | Magnetic wireless charging      | Model Name: | AW-P307  |
| Test Mode:    | Mode 4                          | Phase:      | Vertical |
| Test Voltage: | DC 9V from adapter AC 120V/60Hz |             |          |

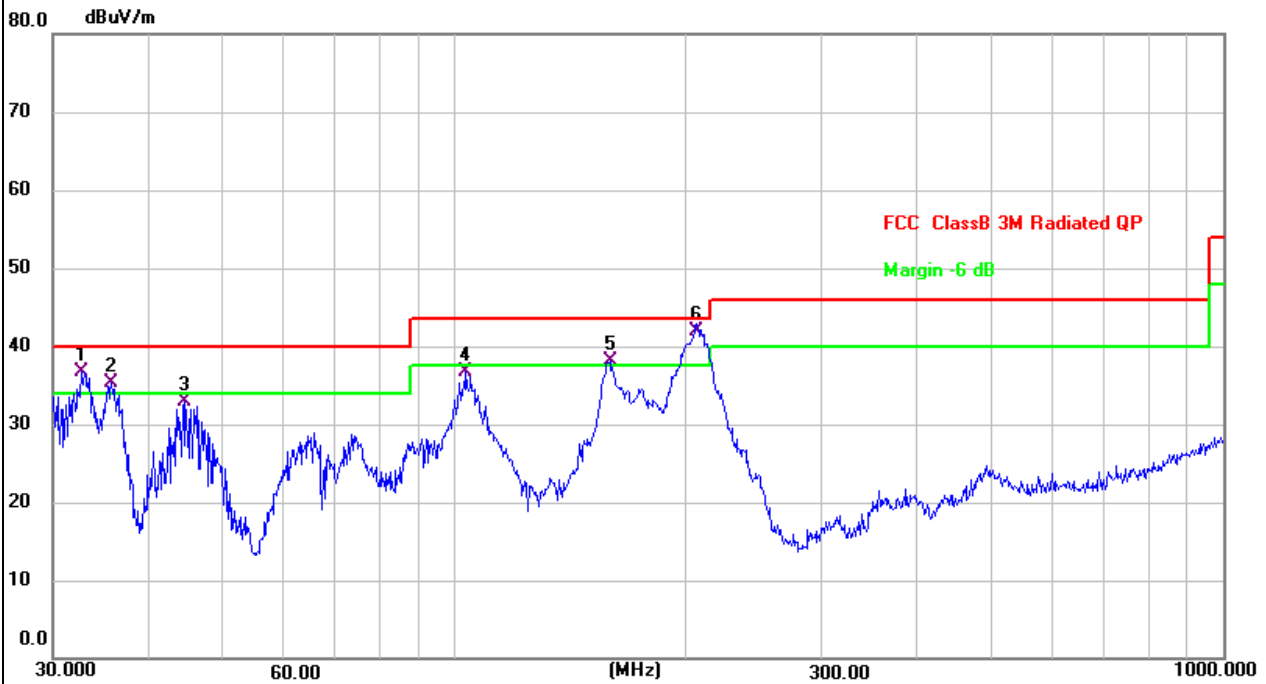

| No. | Frequency (MHz) | Reading (dBuV) | Factor (dB/m) | Level (dBuV/m) | Limit (dBuV/m) | Margin (dB) | Detector |
|-----|-----------------|----------------|---------------|----------------|----------------|-------------|----------|
| 1 ! | 32.6340         | 52.14          | -15.35        | 36.79          | 40.00          | -3.21       | QP       |
| 2 ! | 35.7490         | 50.21          | -14.84        | 35.37          | 40.00          | -4.63       | QP       |
| 3   | 44.5868         | 47.06          | -14.23        | 32.83          | 40.00          | -7.17       | QP       |
| 4   | 103.4421        | 54.59          | -17.92        | 36.67          | 43.50          | -6.83       | QP       |
| 5 ! | 159.2251        | 51.72          | -13.66        | 38.06          | 43.50          | -5.44       | QP       |
| 6 * | 206.3976        | 58.62          | -16.62        | 42.00          | 43.50          | -1.50       | QP       |

|               |                                 |             |            |
|---------------|---------------------------------|-------------|------------|
| EUT:          | Magnetic wireless charging      | Model Name: | AW-P307    |
| Test Mode:    | Mode 4                          | Phase:      | Horizontal |
| Test Voltage: | DC 9V from adapter AC 120V/60Hz |             |            |

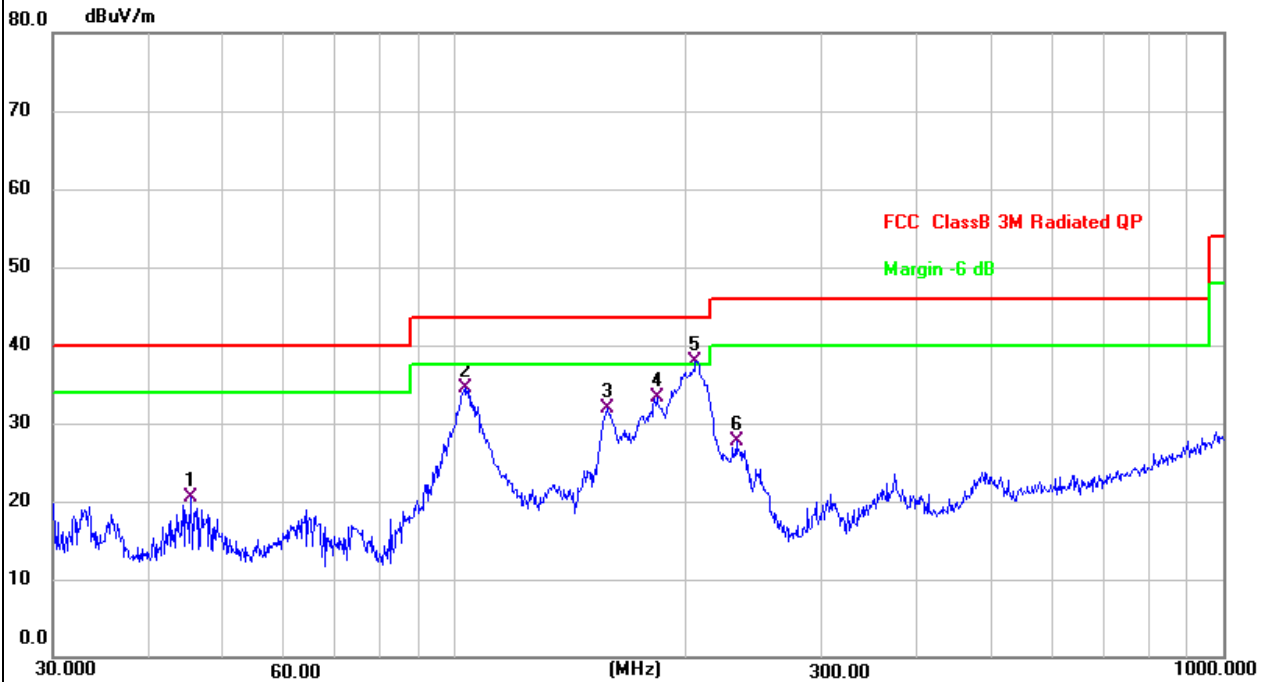

| No. | Frequency (MHz) | Reading (dBuV) | Factor (dB/m) | Level (dBuV/m) | Limit (dBuV/m) | Margin (dB) | Detector |
|-----|-----------------|----------------|---------------|----------------|----------------|-------------|----------|
| 1   | 45.3755         | 34.82          | -14.26        | 20.56          | 40.00          | -19.44      | QP       |
| 2   | 103.0800        | 52.51          | -17.97        | 34.54          | 43.50          | -8.96       | QP       |
| 3   | 158.1123        | 45.63          | -13.69        | 31.94          | 43.50          | -11.56      | QP       |
| 4   | 183.2005        | 48.85          | -15.46        | 33.39          | 43.50          | -10.11      | QP       |
| 5 * | 205.6751        | 54.61          | -16.64        | 37.97          | 43.50          | -5.53       | QP       |
| 6   | 232.5318        | 43.16          | -15.40        | 27.76          | 46.00          | -18.24      | QP       |

## 5.4 Occupied Bandwidth

### 5.4.1 Test method

Use the following spectrum analyzer settings:

Span = approximately 2 to 3 times the 20 dB bandwidth, centered on a hopping channel

RBW  $\geq 1\%$  of the 20 dB bandwidth

VBW  $\geq$  RBW

Sweep = auto

Detector function = peak

Trace = max hold

The EUT should be transmitting at its maximum data rate. Allow the trace to stabilize. Use the marker-to-peak function to set the marker to the peak of the emission. Use the marker-delta function to measure 20 dB down one side of the emission. Reset the marker-delta function, and move the marker to the other side of the emission, until it is (as close as possible to) even with the reference marker level. The marker-delta reading at this point is the 20 dB bandwidth and 99% occupied bandwidth of the emission.

### 5.4.2 Test result

| Frequency (kHz) | 20dB emission bandwidth (Hz) |
|-----------------|------------------------------|
| 127.65          | 769.20                       |

Test plots as below:



## 6 Photographs of the Test Setup

Radiated Emission Below 30MHz

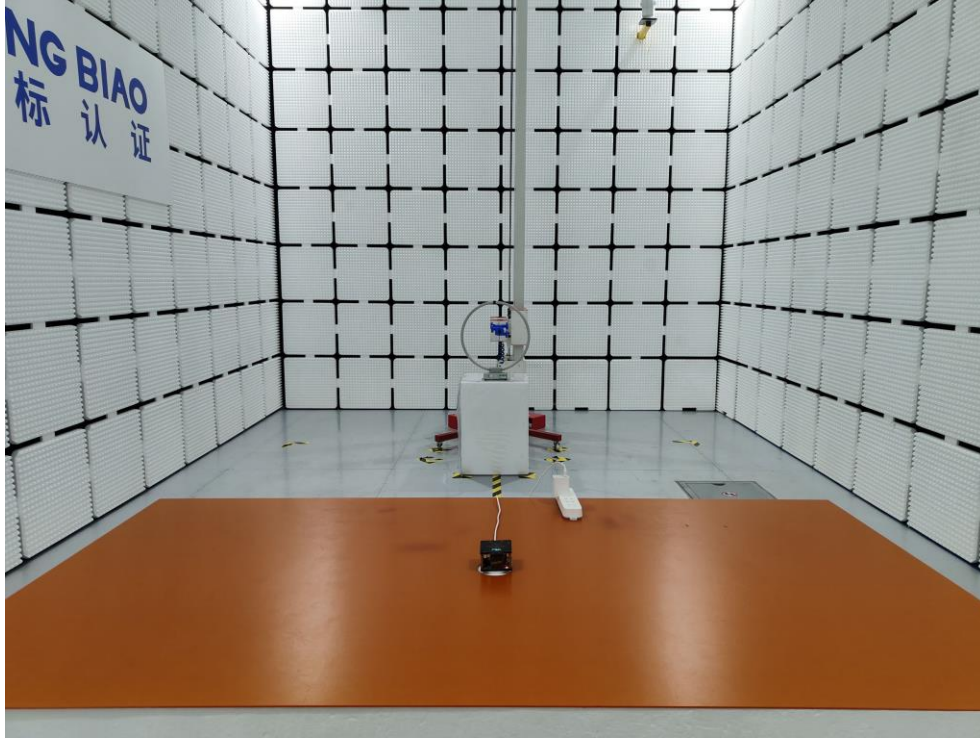

Radiated Emission Above 30MHz

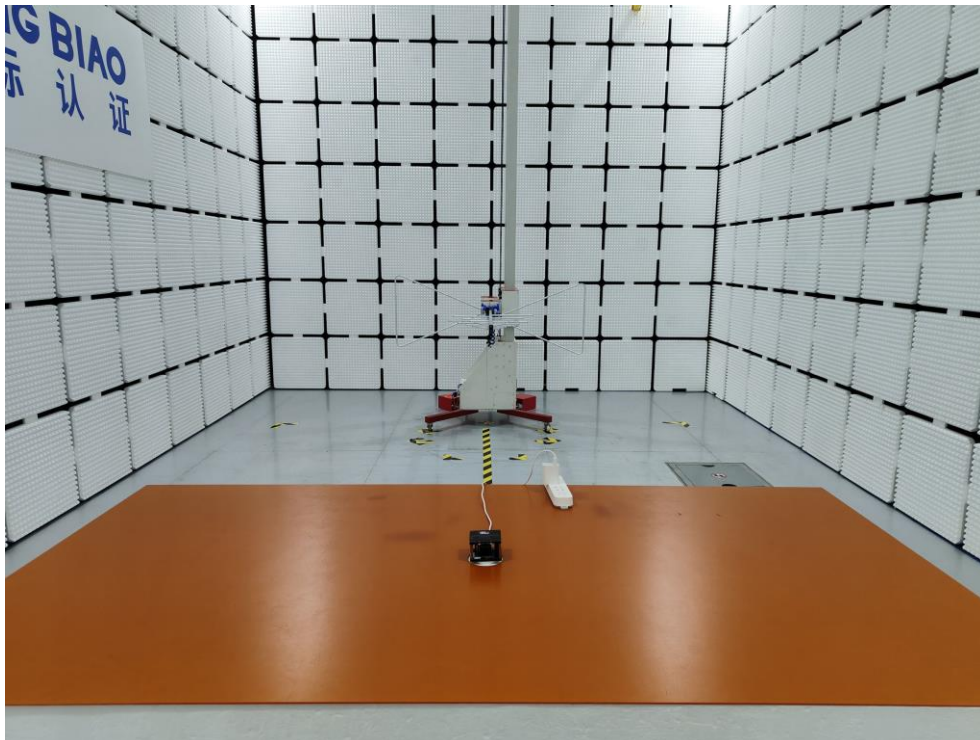



Conducted Emission

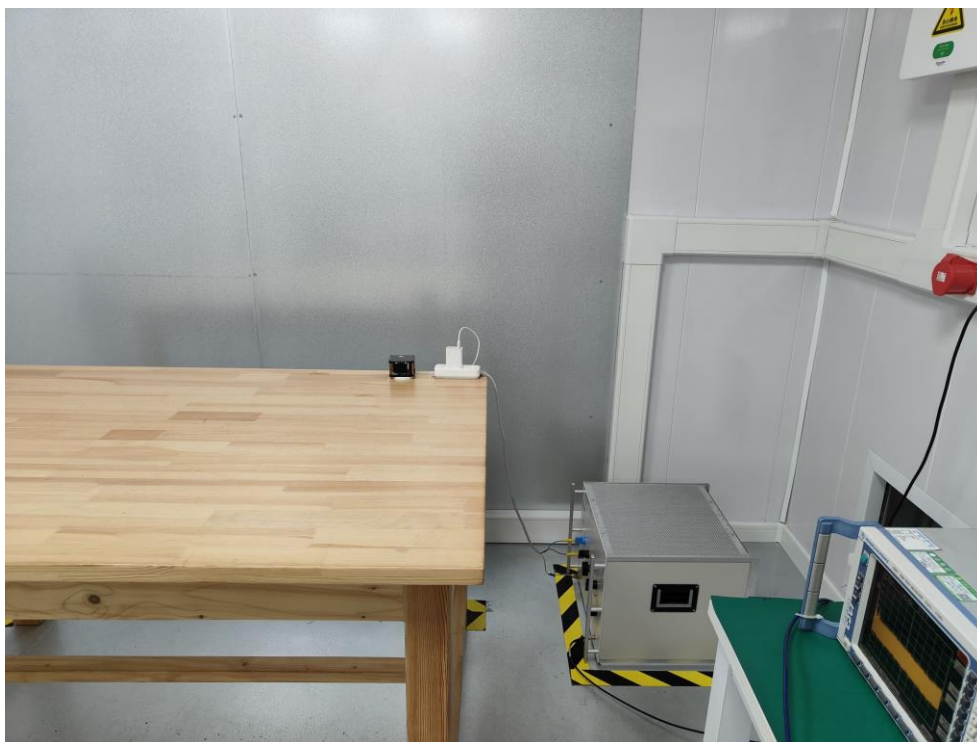

## 7 Photographs of the EUT

Photo 1

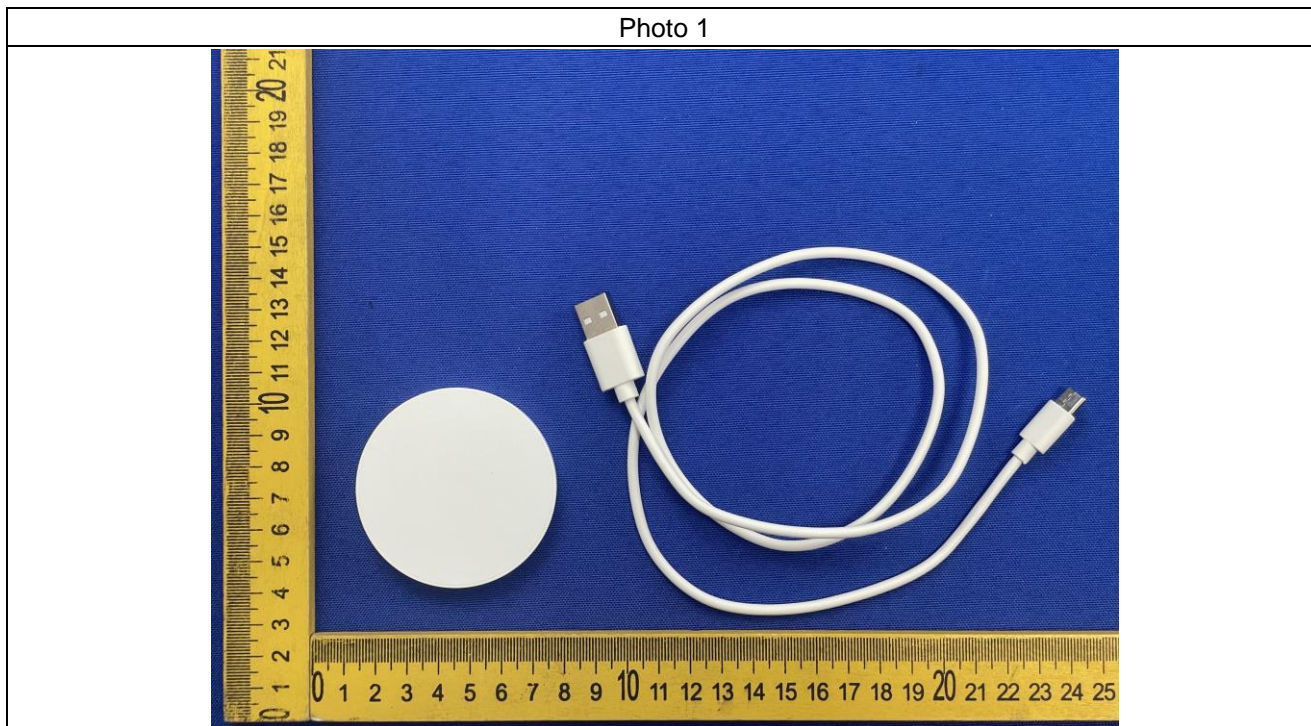

Photo 2





Photo 3

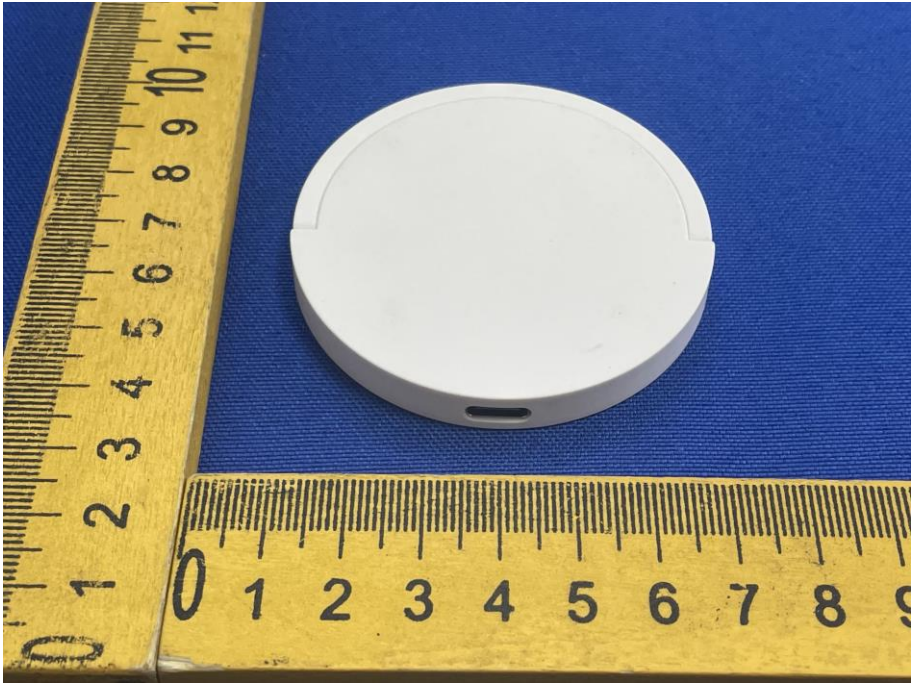

Photo 4

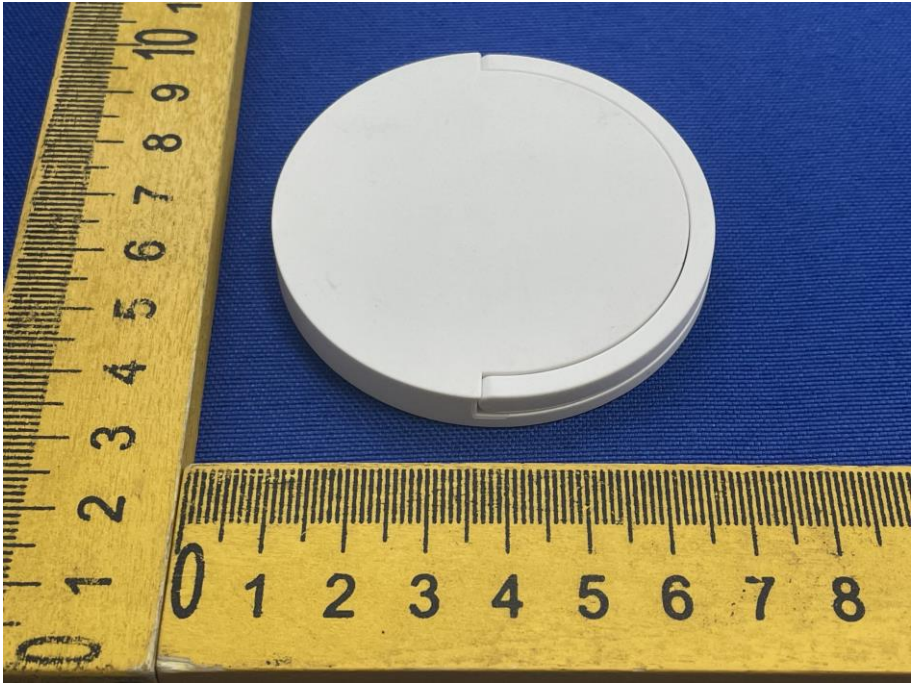

Photo 5



Photo 6

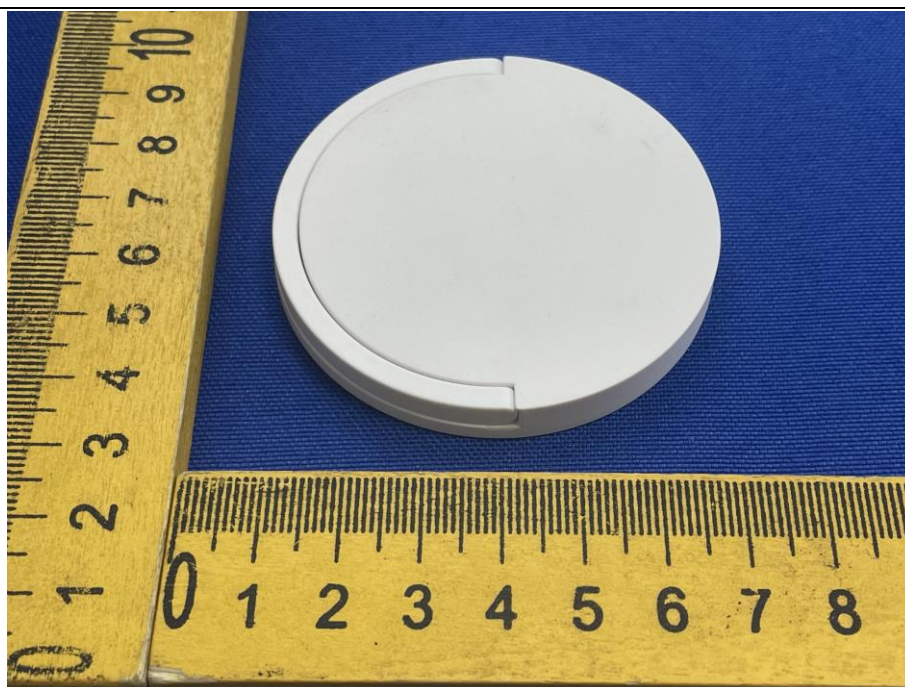



Photo 7

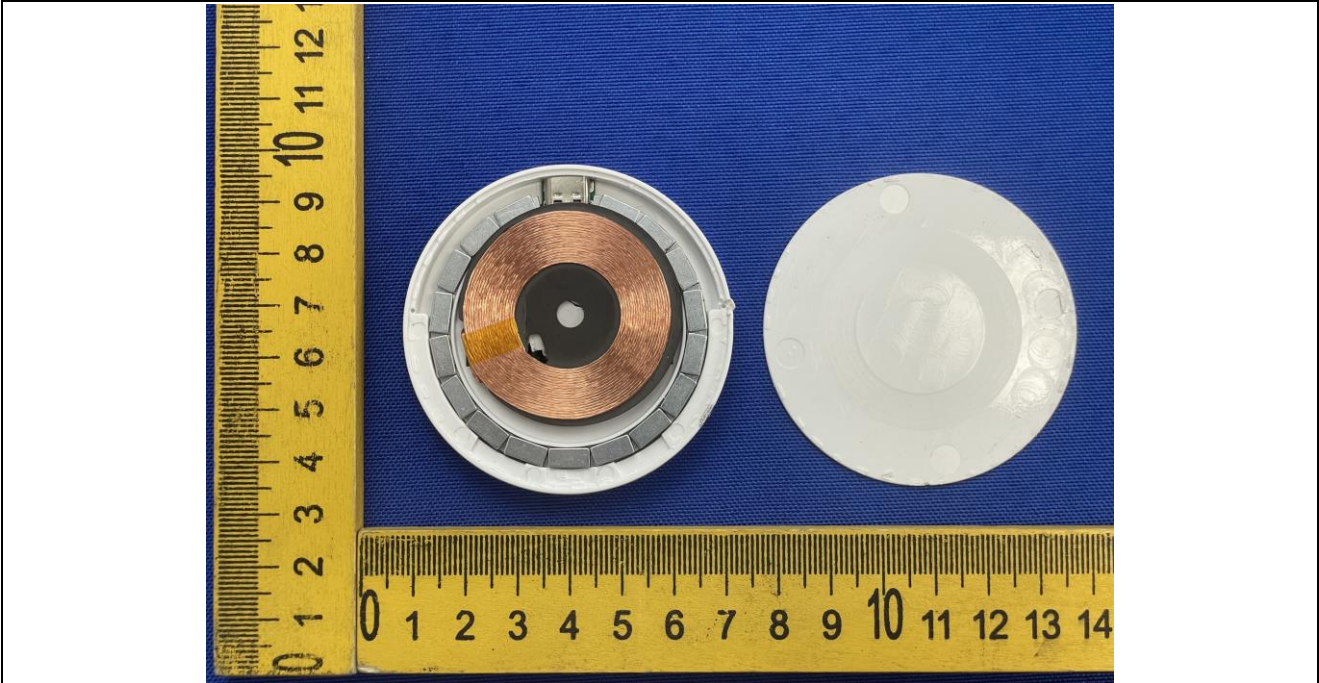

Photo 8

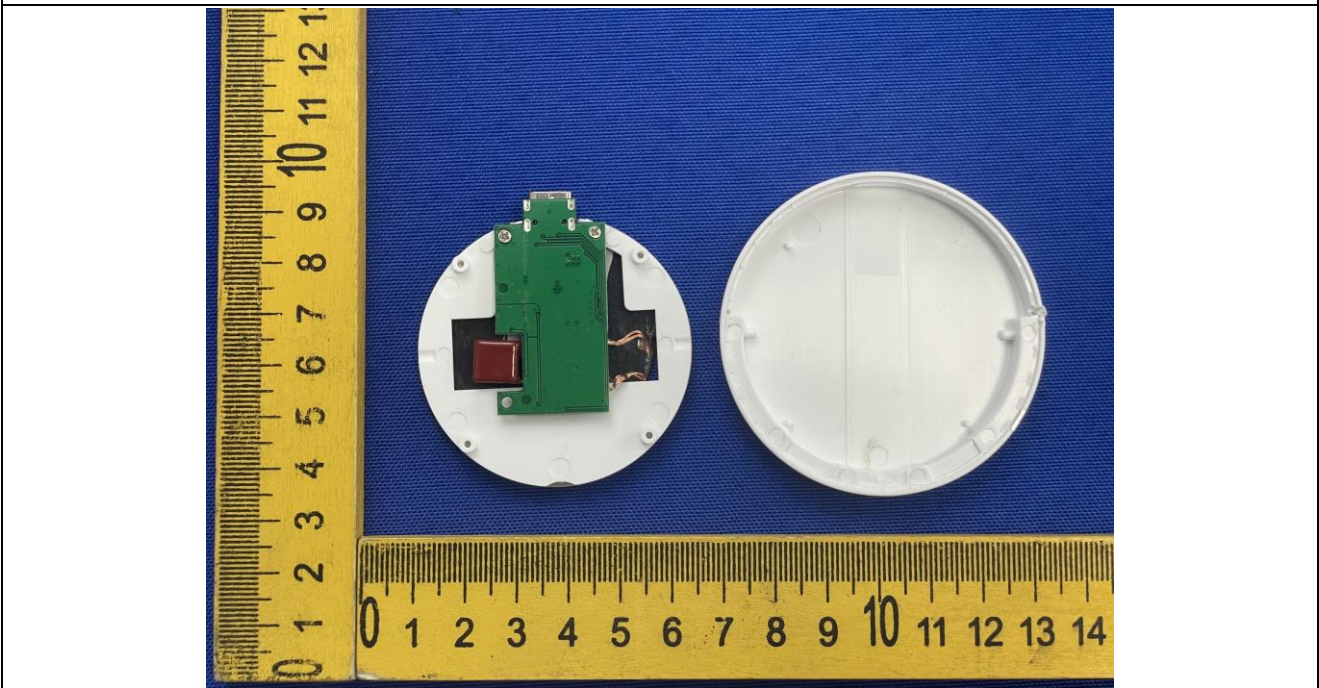



Photo 9

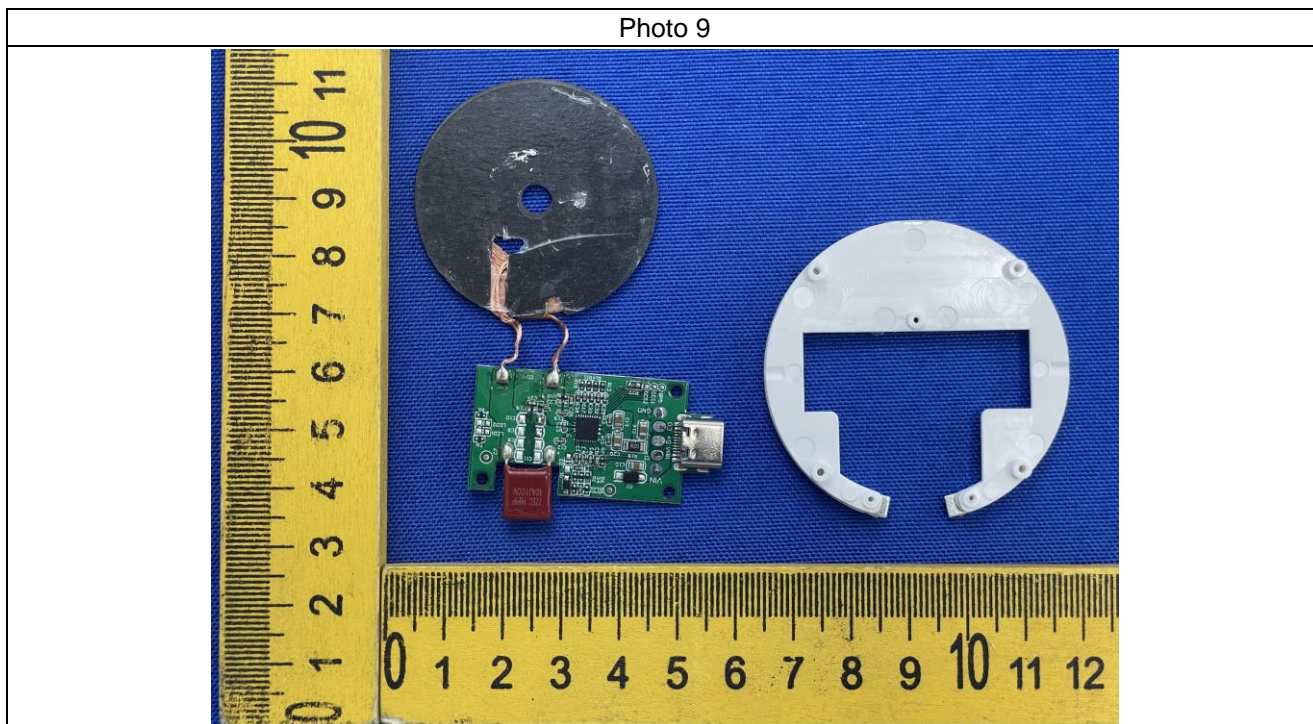
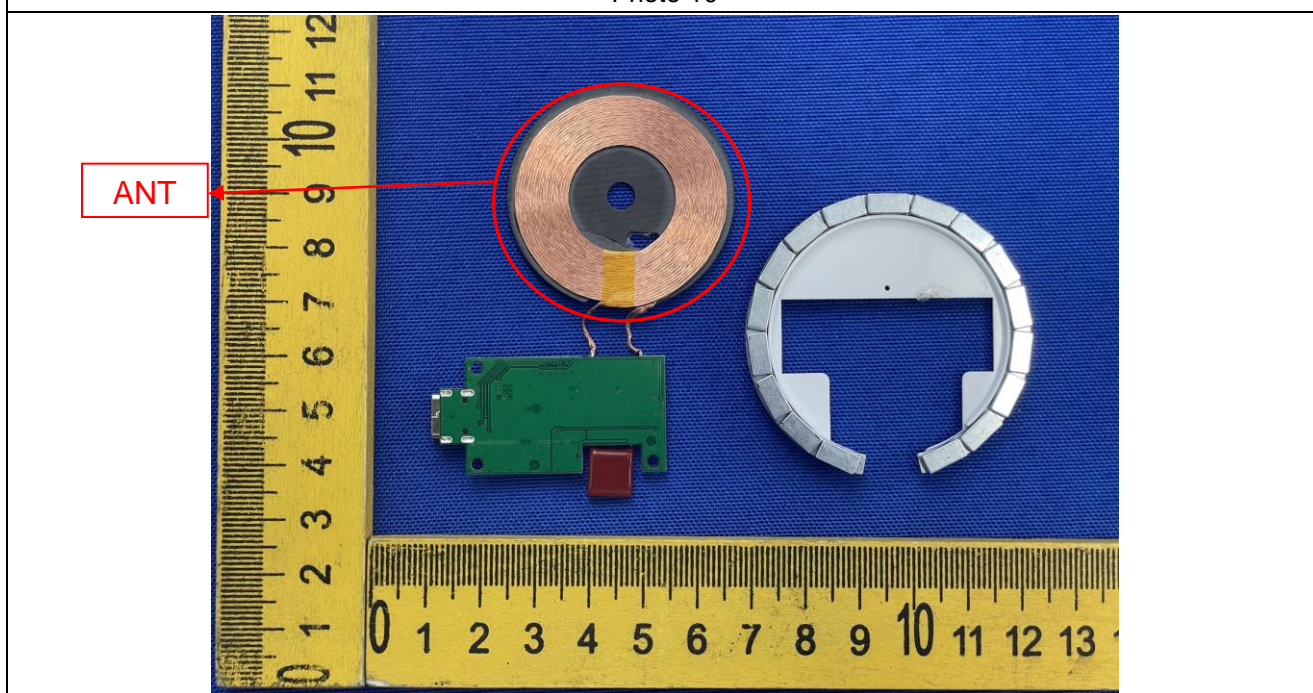

Photo 10



\*\*\*\*\* END OF REPORT \*\*\*\*\*