

1 Version

Revision History Of Report

Report No.	Version	Description	Issue Date
CQASZ20240300410E-01	Rev.01	Initial report	2024-03-28

2 Test Summary

Test Item	Test Requirement	Test method	Result
Antenna Requirement	47 CFR Part 15.203	/	PASS
AC Power Line Conducted Emission	47 CFR Part 15, Subpart C Section 15.207	ANSI C63.10-2013	PASS
Conducted Peak Output Power	47 CFR Part 15.247	ANSI C63.10-2013	PASS
20dB Occupied Bandwidth	47 CFR Part 15.247	ANSI C63.10-2013	PASS
Carrier Frequencies Separation	47 CFR Part 15.247	ANSI C63.10-2013	PASS
Hopping Channel Number	47 CFR Part 15.247	ANSI C63.10-2013	PASS
Dwell Time	47 CFR Part 15.247	ANSI C63.10-2013	PASS
Pseudorandom Frequency Hopping Sequence	47 CFR Part 15.247	ANSI C63.10-2013	PASS
Band-edge for RF Conducted Emissions	47 CFR Part 15.247	ANSI C63.10-2013	PASS
RF Conducted Spurious Emissions	47 CFR Part 15.247	ANSI C63.10-2013	PASS
Radiated Spurious emissions	47 CFR Part 15.209	ANSI C63.10-2013	PASS
Restricted bands around fundamental frequency (Radiated Emission)	47 CFR Part 15.205/15.209	ANSI C63.10-2013	PASS

Remark:

The tested sample(s) and the sample information are provided by the client.

Tx: In this whole report Tx (or tx) means Transmitter.

Rx: In this whole report Rx (or rx) means Receiver.

RF: In this whole report RF means Radiated Frequency.

CH: In this whole report CH means channel.

Volt: In this whole report Volt means Voltage.

Temp: In this whole report Temp means Temperature.

Humid: In this whole report Humid means humidity.

Press: In this whole report Press means Pressure.

N/A: In this whole report not application

3 Contents

	Page
1 VERSION	2
2 TEST SUMMARY	3
3 CONTENTS	4
4 GENERAL INFORMATION	5
4.1 CLIENT INFORMATION	5
4.2 GENERAL DESCRIPTION OF EUT	5
4.3 ADDITIONAL INSTRUCTIONS	7
4.4 TEST ENVIRONMENT	8
4.5 DESCRIPTION OF SUPPORT UNITS	8
4.6 STATEMENT OF THE MEASUREMENT UNCERTAINTY	9
4.7 TEST LOCATION	10
4.8 TEST FACILITY	10
4.9 ABNORMALITIES FROM STANDARD CONDITIONS	10
4.10 OTHER INFORMATION REQUESTED BY THE CUSTOMER	10
4.11 EQUIPMENT LIST	11
5 TEST RESULTS AND MEASUREMENT DATA	12
5.1 ANTENNA REQUIREMENT	12
5.2 CONDUCTED EMISSIONS	13
5.3 CONDUCTED PEAK OUTPUT POWER	17
5.4 20dB OCCUPIED BANDWIDTH	24
5.5 CARRIER FREQUENCIES SEPARATION	30
5.6 HOPPING CHANNEL NUMBER	34
5.7 DWELL TIME	37
5.8 BAND-EDGE FOR RF CONDUCTED EMISSIONS	48
5.9 SPURIOUS RF CONDUCTED EMISSIONS	56
5.10 OTHER REQUIREMENTS FREQUENCY HOPPING SPREAD SPECTRUM SYSTEM	71
5.11 RADIATED SPURIOUS EMISSION & RESTRICTED BANDS	73
5.11.1 Radiated Emission below 1GHz	76
5.11.2 Transmitter Emission above 1GHz	78
6 PHOTOGRAPHS - EUT TEST SETUP	81
6.1 RADIATED EMISSION	81
6.2 CONDUCTED EMISSION	82
7 PHOTOGRAPHS - EUT CONSTRUCTIONAL DETAILS	83

4 General Information

4.1 Client Information

Applicant:	ARTISTE TECHNOLOGY LTD.
Address of Applicant:	Room 1601, Building C1, Lingnan V-Valley, No.9, Guanhai Road, Liwan District, Guangzhou, Guangdong, China
Manufacturer:	ARTISTE TECHNOLOGY LTD.
Address of Manufacturer:	Room 1601, Building C1, Lingnan V-Valley, No.9, Guanhai Road, Liwan District, Guangzhou, Guangdong, China
Factory:	ARTISTE TECHNOLOGY LTD.
Address of Factory:	Room 1601, Building C1, Lingnan V-Valley, No.9, Guanhai Road, Liwan District, Guangzhou, Guangdong, China

4.2 General Description of EUT

Product Name:	Wireless earbuds
Model No.:	TN100
Test Model No.:	TN100
Trade Mark:	DAYSNEW, ARTISTE
Software Version:	V1
Hardware Version:	V2.1
Operation Frequency:	2402MHz~2480MHz
Bluetooth Version:	V5.3
Modulation Technique:	Frequency Hopping Spread Spectrum(FHSS)
Modulation Type:	GFSK, $\pi/4$ DQPSK, 8DPSK
Transfer Rate:	1Mbps/2Mbps/3Mbps
Number of Channel:	79
Hopping Channel Type:	Adaptive Frequency Hopping systems
Product Type:	<input type="checkbox"/> Mobile <input checked="" type="checkbox"/> Portable
Test Software of EUT:	bt_tool_v1.1.2
Antenna Type:	Ceramic antenna
Antenna Gain:	2.67dBi
Power Supply:	Li-ion battery DC 3.7V 35mAh, Charge by DC 5V for Charge box
Simultaneous Transmission	<input type="checkbox"/> Simultaneous TX is supported and evaluated in this report. <input checked="" type="checkbox"/> Simultaneous TX is not supported.

Operation Frequency each of channel							
Channel	Frequency	Channel	Frequency	Channel	Frequency	Channel	Frequency
0	2402MHz	20	2422MHz	40	2442MHz	60	2462MHz
1	2403MHz	21	2423MHz	41	2443MHz	61	2463MHz
2	2404MHz	22	2424MHz	42	2444MHz	62	2464MHz
3	2405MHz	23	2425MHz	43	2445MHz	63	2465MHz
4	2406MHz	24	2426MHz	44	2446MHz	64	2466MHz
5	2407MHz	25	2427MHz	45	2447MHz	65	2467MHz
6	2408MHz	26	2428MHz	46	2448MHz	66	2468MHz
7	2409MHz	27	2429MHz	47	2449MHz	67	2469MHz
8	2410MHz	28	2430MHz	48	2450MHz	68	2470MHz
9	2411MHz	29	2431MHz	49	2451MHz	69	2471MHz
10	2412MHz	30	2432MHz	50	2452MHz	70	2472MHz
11	2413MHz	31	2433MHz	51	2453MHz	71	2473MHz
12	2414MHz	32	2434MHz	52	2454MHz	72	2474MHz
13	2415MHz	33	2435MHz	53	2455MHz	73	2475MHz
14	2416MHz	34	2436MHz	54	2456MHz	74	2476MHz
15	2417MHz	35	2437MHz	55	2457MHz	75	2477MHz
16	2418MHz	36	2438MHz	56	2458MHz	76	2478MHz
17	2419MHz	37	2439MHz	57	2459MHz	77	2479MHz
18	2420MHz	38	2440MHz	58	2460MHz	78	2480MHz
19	2421MHz	39	2441MHz	59	2461MHz		

Note:

In section 15.31(m), regards to the operating frequency range over 10 MHz, the Lowest frequency, the middle frequency, and the highest frequency of channel were selected to perform the test, and the selected channel see below:

Channel	Frequency
The Lowest channel	2402MHz
The Middle channel	2441MHz
The Highest channel	2480MHz

4.3 Additional Instructions

EUT Test Software Settings:		
Mode:	<input checked="" type="checkbox"/> Special software is used. <input type="checkbox"/> Through engineering command into the engineering mode. engineering command: <code>###3646633###</code>	
EUT Power level:	(Power level is built-in set parameters and cannot be changed and selected)	
Use test software to set the lowest frequency, the middle frequency and the highest frequency keep transmitting of the EUT.		
Mode	Channel	Frequency(MHz)
DH1/DH3/DH5	CH0	2402
	CH39	2441
	CH78	2480
2DH1/2DH3/2DH5	CH0	2402
	CH39	2441
	CH78	2480
3DH1/3DH3/3DH5	CH0	2402
	CH39	2441
	CH78	2480

Run Software:

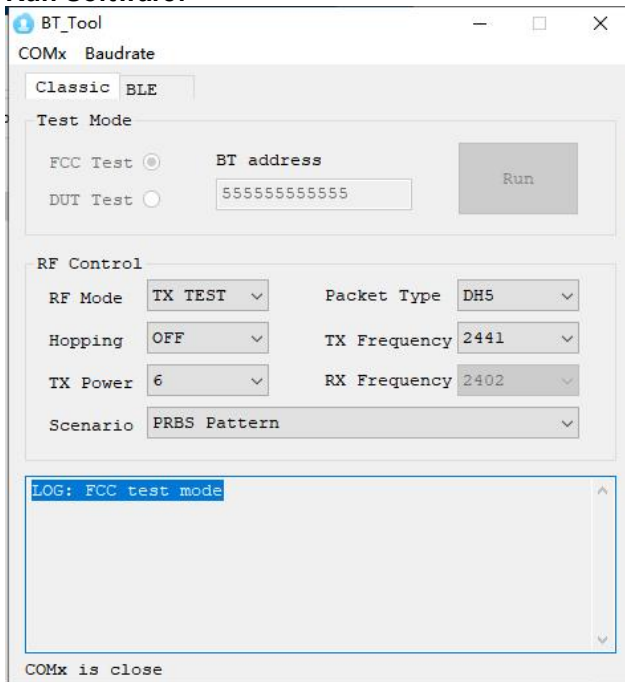

4.4 Test Environment

Operating Environment:	
Temperature:	25 °C
Humidity:	54% RH
Atmospheric Pressure:	1009mbar
Test Mode:	Use test software to set the lowest frequency, the middle frequency and the highest frequency keep transmitting of the EUT.

4.5 Description of Support Units

The EUT has been tested with associated equipment below.

Description	Manufacturer	Model No.	Remark	Supplied
Adapter	MI	/	/	CQA

4.6 Statement of the measurement uncertainty

The data and results referenced in this document are true and accurate.

The reader is cautioned that there may be errors within the calibration limits of the equipment and facilities.

The measurement uncertainty was calculated for all measurements listed in this test report acc. to CISPR 16 - 4 „Specification for radio disturbance and immunity measuring apparatus and methods – Part 4: Uncertainty in EMC Measurements“ and is documented in the **Shenzhen Huaxia Testing Technology Co., Ltd.** quality system acc. to DIN EN ISO/IEC 17025.

Furthermore, component and process variability of devices similar to that tested may result in additional deviation. The manufacturer has the sole responsibility of continued compliance of the device.

Hereafter the best measurement capability for CQA laboratory is reported:

No.	Item	Uncertainty
1	Radiated Emission (Below 1GHz)	5.12dB
2	Radiated Emission (Above 1GHz)	4.60dB
3	Conducted Disturbance (0.15~30MHz)	3.34dB
4	Radio Frequency	3×10^{-8}
5	Duty cycle	0.6 %
6	Occupied Bandwidth	1.1%
7	RF conducted power	0.86dB
8	RF power density	0.74
9	Conducted Spurious emissions	0.86dB
10	Temperature test	0.8°C
11	Humidity test	2.0%
12	Supply voltages	0.5 %
13	Frequency Error	5.5 Hz

4.7 Test Location

All tests were performed at:

Shenzhen Huaxia Testing Technology Co., Ltd.

1F., Block A of Tongsheng Technology Building, Huahui Road, Dalang Street, Longhua District, Shenzhen, China

4.8 Test Facility

The test facility is recognized, certified, or accredited by the following organizations:

IC Registration No.: 22984-1

The 3m Semi-anechoic chamber of Shenzhen Huaxia Testing Technology Co., Ltd. has been registered by Certification and Engineering Bureau of Industry Canada for radio equipment testing

The test facility is recognized, certified, or accredited by the following organizations:

• **CNAS (No. CNAS L5785)**

CNAS has accredited Shenzhen Huaxia Testing Technology Co., Ltd. Shenzhen Branch EMC Lab to ISO/IEC 17025:2005 General Requirements for the Competence of Testing and Calibration Laboratories (CNAS-CL01 Accreditation Criteria for the Competence of Testing and Calibration Laboratories) for the competence in the field of testing.

• **A2LA (Certificate No. 4742.01)**

Shenzhen Huaxia Testing Technology Co., Ltd., Shenzhen EMC Laboratory is accredited by the American Association for Laboratory Accreditation(A2LA). Certificate No. 4742.01.

• **FCC Registration No.: 522263**

Shenzhen Huaxia Testing Technology Co., Ltd., Shenzhen EMC Laboratory has been registered and fully described in a report filed with the (FCC) Federal Communications Commission. The acceptance letter from the FCC is maintained in our files. Registration No.:522263

4.9 Abnormalities from Standard Conditions

None.

4.10 Other Information Requested by the Customer

None.

4.11 Equipment List

Test Equipment	Manufacturer	Model No.	Instrument No.	Calibration Date	Calibration Due Date
EMI Test Receiver	R&S	ESR7	CQA-005	2023/09/08	2024/09/07
Spectrum analyzer	R&S	FSU26	CQA-038	2023/09/08	2024/09/07
Spectrum analyzer	R&S	FSU40	CQA-075	2023/09/08	2024/09/07
Preamplifier	MITEQ	AFS4-00010300-18-10P-4	CQA-035	2023/09/08	2024/09/07
Preamplifier	MITEQ	AMF-6D-02001800-29-20P	CQA-036	2023/09/08	2024/09/07
Preamplifier	EMCI	EMC184055SE	CQA-089	2023/09/08	2024/09/07
Loop antenna	Schwarzbeck	FMZB1516	CQA-060	2021/09/16	2024/09/15
Bilog Antenna	R&S	HL562	CQA-011	2021/09/16	2024/09/15
Horn Antenna	R&S	HF906	CQA-012	2021/09/16	2024/09/15
Horn Antenna	Schwarzbeck	BBHA 9170	CQA-088	2021/09/16	2024/09/15
Coaxial Cable (Above 1GHz)	CQA	N/A	C007	2023/09/08	2024/09/07
Coaxial Cable (Below 1GHz)	CQA	N/A	C013	2023/09/08	2024/09/07
RF cable(9KHz~40GHz)	CQA	RF-01	CQA-079	2023/09/08	2024/09/07
Antenna Connector	CQA	RFC-01	CQA-080	2023/09/08	2024/09/07
Power Sensor	KEYSIGHT	U2021XA	CQA-30	2023/09/08	2024/09/07
N1918A Power Analysis Manager Power Panel	Agilent	N1918A	CQA-074	2023/09/08	2024/09/07
Power meter	R&S	NRVD	CQA-029	2023/09/08	2024/09/07
Power divider	MIDWEST	PWD-2533-02-SMA-79	CQA-067	2023/09/08	2024/09/07
EMI Test Receiver	R&S	ESR7	CQA-005	2023/09/08	2024/09/07
LISN	R&S	ENV216	CQA-003	2023/09/08	2024/09/07
Coaxial cable	CQA	N/A	CQA-C009	2023/09/08	2024/09/07
DC power	KEYSIGHT	E3631A	CQA-028	2023/09/08	2024/09/07

Note:

The temporary antenna connector is soldered on the PCB board in order to perform conducted tests and this temporary antenna connector is listed in the equipment list.

5 Test results and Measurement Data

5.1 Antenna Requirement

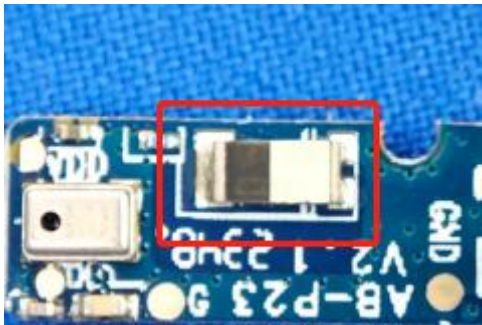
Standard requirement:	47 CFR Part 15C Section 15.203 /247(c)
<p>15.203 requirement: An intentional radiator shall be designed to ensure that no antenna other than that furnished by the responsible party shall be used with the device. The use of a permanently attached antenna or of an antenna that uses a unique coupling to the intentional radiator, the manufacturer may design the unit so that a broken antenna can be replaced by the user, but the use of a standard antenna jack or electrical connector is prohibited.</p> <p>15.247(b) (4) requirement: The conducted output power limit specified in paragraph (b) of this section is based on the use of antennas with directional gains that do not exceed 6 dBi. Except as shown in paragraph (c) of this section, if transmitting antennas of directional gain greater than 6 dBi are used, the conducted output power from the intentional radiator shall be reduced below the stated values in paragraphs (b)(1), (b)(2), and (b)(3) of this section, as appropriate, by the amount in dB that the directional gain of the antenna exceeds 6 dBi.</p>	
EUT Antenna:	
<p>The antenna is Chip antenna. The connection/connection type between the antenna to the EUT's antenna port is: permanently attachment. This is either permanently attachment or a unique coupling that satisfies the requirement.</p>	

5.2 Conducted Emissions

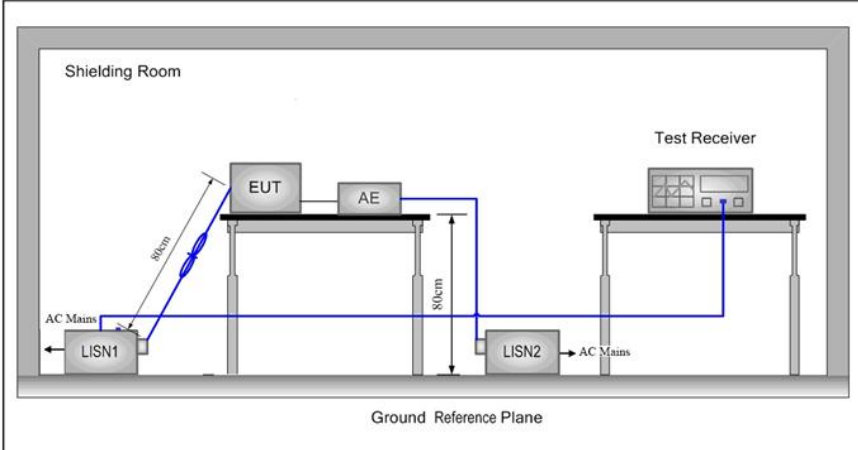
Test Requirement:	47 CFR Part 15C Section 15.207														
Test Method:	ANSI C63.10: 2013														
Test Frequency Range:	150kHz to 30MHz														
Limit:	<table border="1"> <thead> <tr> <th rowspan="2">Frequency range (MHz)</th> <th colspan="2">Limit (dBuV)</th> </tr> <tr> <th>Quasi-peak</th> <th>Average</th> </tr> </thead> <tbody> <tr> <td>0.15-0.5</td> <td>66 to 56*</td> <td>56 to 46*</td> </tr> <tr> <td>0.5-5</td> <td>56</td> <td>46</td> </tr> <tr> <td>5-30</td> <td>60</td> <td>50</td> </tr> </tbody> </table>	Frequency range (MHz)	Limit (dBuV)		Quasi-peak	Average	0.15-0.5	66 to 56*	56 to 46*	0.5-5	56	46	5-30	60	50
	Frequency range (MHz)		Limit (dBuV)												
		Quasi-peak	Average												
	0.15-0.5	66 to 56*	56 to 46*												
0.5-5	56	46													
5-30	60	50													
* Decreases with the logarithm of the frequency.															
Test Procedure:	<ol style="list-style-type: none"> 1) The mains terminal disturbance voltage test was conducted in a shielded room. 2) The EUT was connected to AC power source through a LISN 1 (Line Impedance Stabilization Network) which provides a $50\Omega/50\mu\text{H} + 5\Omega$ linear impedance. The power cables of all other units of the EUT were connected to a second LISN 2, which was bonded to the ground reference plane in the same way as the LISN 1 for the unit being measured. A multiple socket outlet strip was used to connect multiple power cables to a single LISN provided the rating of the LISN was not exceeded. 3) The tabletop EUT was placed upon a non-metallic table 0.8m above the ground reference plane. And for floor-standing arrangement, the EUT was placed on the horizontal ground reference plane, 4) The test was performed with a vertical ground reference plane. The rear of the EUT shall be 0.4 m from the vertical ground reference plane. The vertical ground reference plane was bonded to the horizontal ground reference plane. The LISN 1 was placed 0.8 m from the boundary of the unit under test and bonded to a ground reference plane for LISNs mounted on top of the ground reference plane. This distance was between the closest points of the LISN 1 and the EUT. All other units of the EUT and associated equipment was at least 0.8 m from the LISN 2. 5) In order to find the maximum emission, the relative positions of equipment and all of the interface cables must be changed according to ANSI C63.10: 2013 on conducted measurement. 														
Test Setup:															

Final Test Mode:	Charge mode
Test Voltage:	AC 120V/60Hz
Test Results:	Pass

Measurement Data

Live line:

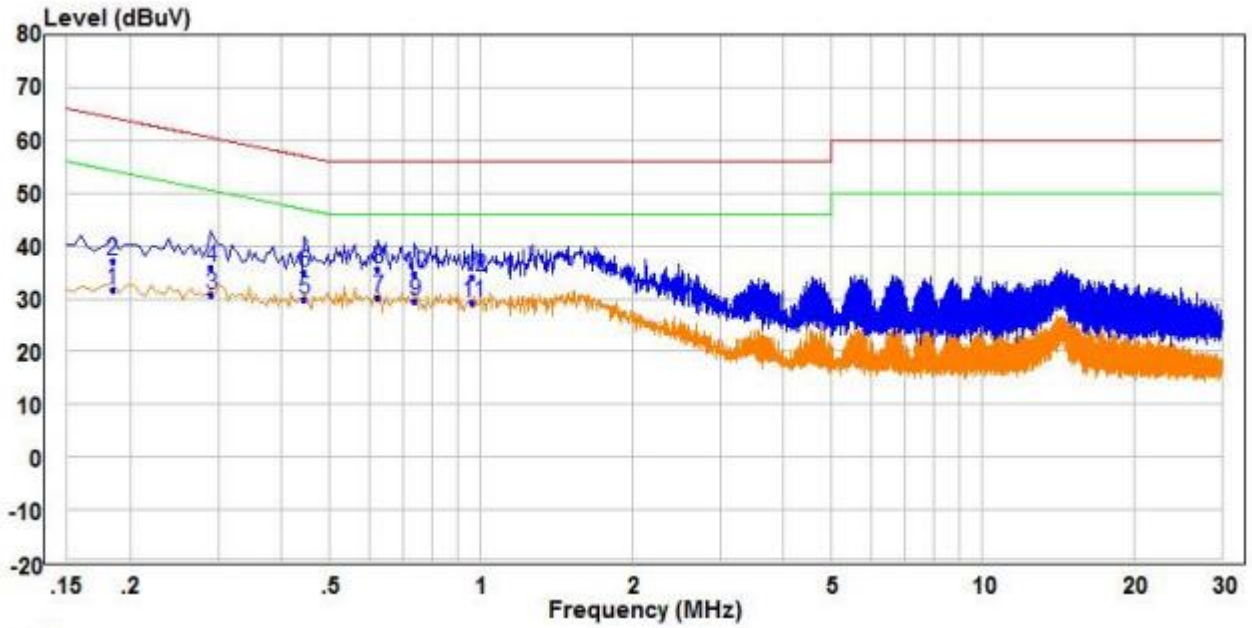

	Read			Limit	Over			
Freq	Level	Factor	Level	Line	Limit	Remark	Pol/Phase	
MHz	dBuV	dB	dBuV	dBuV	dB			
1	0.185	22.33	9.49	31.82	54.26	-22.44	Average	Line
2	0.185	27.58	9.49	37.07	64.26	-27.19	QP	Line
3	0.290	21.41	9.49	30.90	50.52	-19.62	Average	Line
4	0.290	26.49	9.49	35.98	60.52	-24.54	QP	Line
5	0.445	20.25	9.51	29.76	46.97	-17.21	Average	Line
6	0.445	25.62	9.51	35.13	56.97	-21.84	QP	Line
7 PP	0.625	20.33	9.75	30.08	46.00	-15.92	Average	Line
8 QP	0.625	26.03	9.75	35.78	56.00	-20.22	QP	Line
9	0.740	19.62	9.82	29.44	46.00	-16.56	Average	Line
10	0.740	24.82	9.82	34.64	56.00	-21.36	QP	Line
11	0.965	19.84	9.56	29.40	46.00	-16.60	Average	Line
12	0.965	24.61	9.56	34.17	56.00	-21.83	QP	Line

Remark:

1. The following Quasi-Peak and Average measurements were performed on the EUT:
2. Final Test Level = Receiver Reading + LISN Factor + Cable Loss.
3. If the Peak value under Average limit, the Average value is not recorded in the report.

Neutral line:

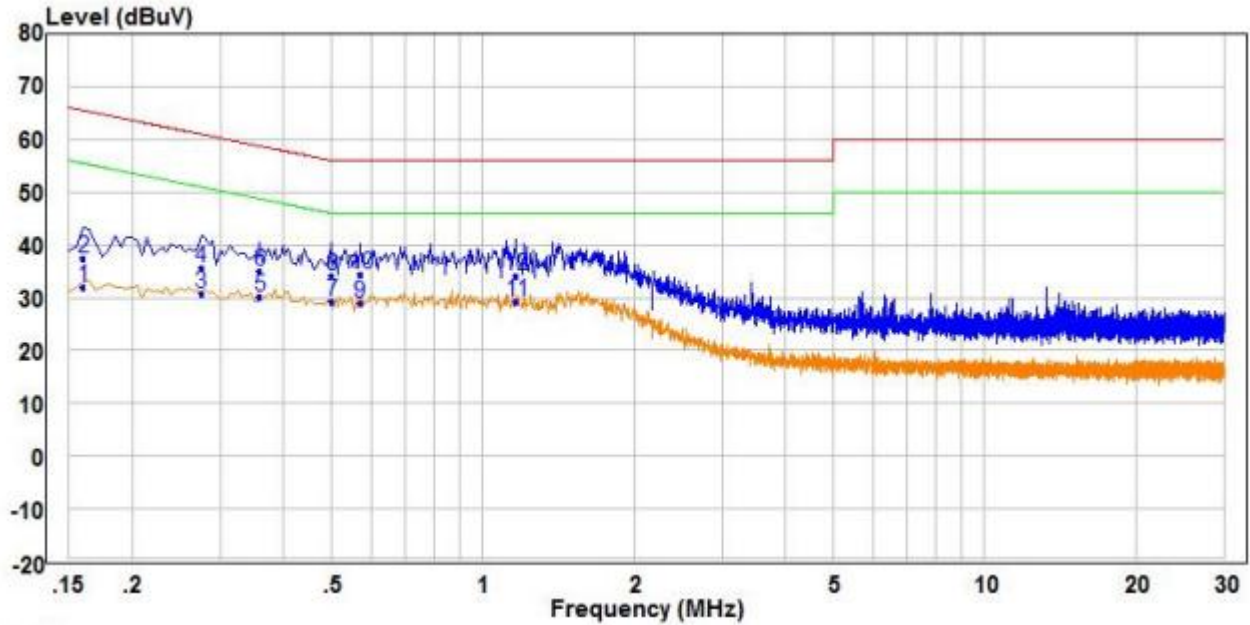

	Read		Limit	Over			
Freq	Level	Factor	Level	Line	Limit	Remark	Pol/Phase
MHz	dBuV	dB	dBuV	dBuV	dB		
1	0.160	22.34	9.68	32.02	55.46	-23.44 Average	Neutral
2	0.160	27.68	9.68	37.36	65.46	-28.10 QP	Neutral
3	0.275	21.36	9.51	30.87	50.97	-20.10 Average	Neutral
4	0.275	26.21	9.51	35.72	60.97	-25.25 QP	Neutral
5	0.360	20.55	9.56	30.11	48.73	-18.62 Average	Neutral
6	0.360	25.43	9.56	34.99	58.73	-23.74 QP	Neutral
7 PP	0.500	19.65	9.70	29.35	46.00	-16.65 Average	Neutral
8	0.500	24.49	9.70	34.19	56.00	-21.81 QP	Neutral
9	0.570	19.27	9.77	29.04	46.00	-16.96 Average	Neutral
10 QP	0.570	24.64	9.77	34.41	56.00	-21.59 QP	Neutral
11	1.165	19.56	9.71	29.27	46.00	-16.73 Average	Neutral
12	1.165	24.48	9.71	34.19	56.00	-21.81 QP	Neutral

Remark:

1. The following Quasi-Peak and Average measurements were performed on the EUT:
2. Final Test Level = Receiver Reading + LISN Factor + Cable Loss.
3. If the Peak value under Average limit, the Average value is not recorded in the report.

5.3 Conducted Peak Output Power

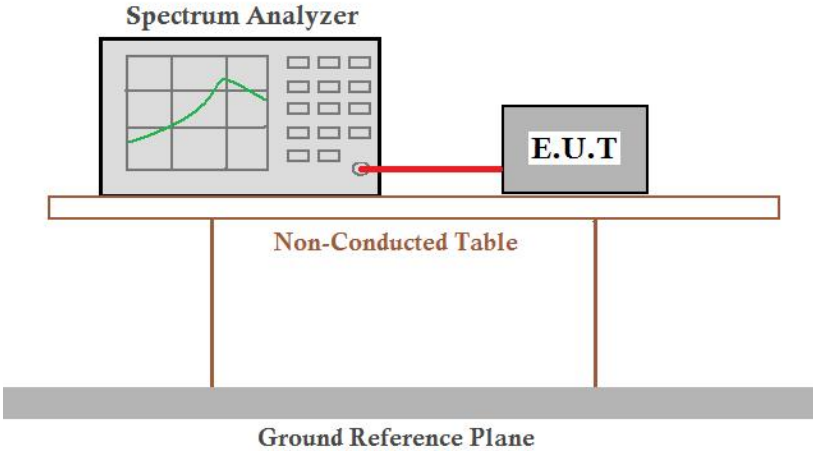
Test Requirement:	47 CFR Part 15C Section 15.247 (b)(1)
Test Method:	ANSI C63.10:2013
Test Setup:	<p>Setup for Power meter measurement method</p>  <p>Setup for Spectrum analyser measurement method</p>  <p><i>Remark: Offset=Cable loss+ attenuation factor.</i></p>
Limit:	21dBm
Exploratory Test Mode:	Non-hopping transmitting with all kind of modulation and all kind of data type
Final Test Mode:	Only the worst case is recorded in the report.
Test Results:	Pass

Measurement Data

GFSK mode			
Test channel	Peak Output Power (dBm)	Limit (dBm)	Result
Lowest	-1.26	21.00	Pass
Middle	-0.46	21.00	Pass
Highest	-0.98	21.00	Pass
$\pi/4$ DQPSK mode			
Test channel	Peak Output Power (dBm)	Limit (dBm)	Result
Lowest	-1.18	21.00	Pass
Middle	-0.52	21.00	Pass
Highest	-0.75	21.00	Pass
8DPSK mode			
Test channel	Peak Output Power (dBm)	Limit (dBm)	Result
Lowest	-1.23	21.00	Pass
Middle	-0.35	21.00	Pass
Highest	-0.98	21.00	Pass

Test plot as follows:

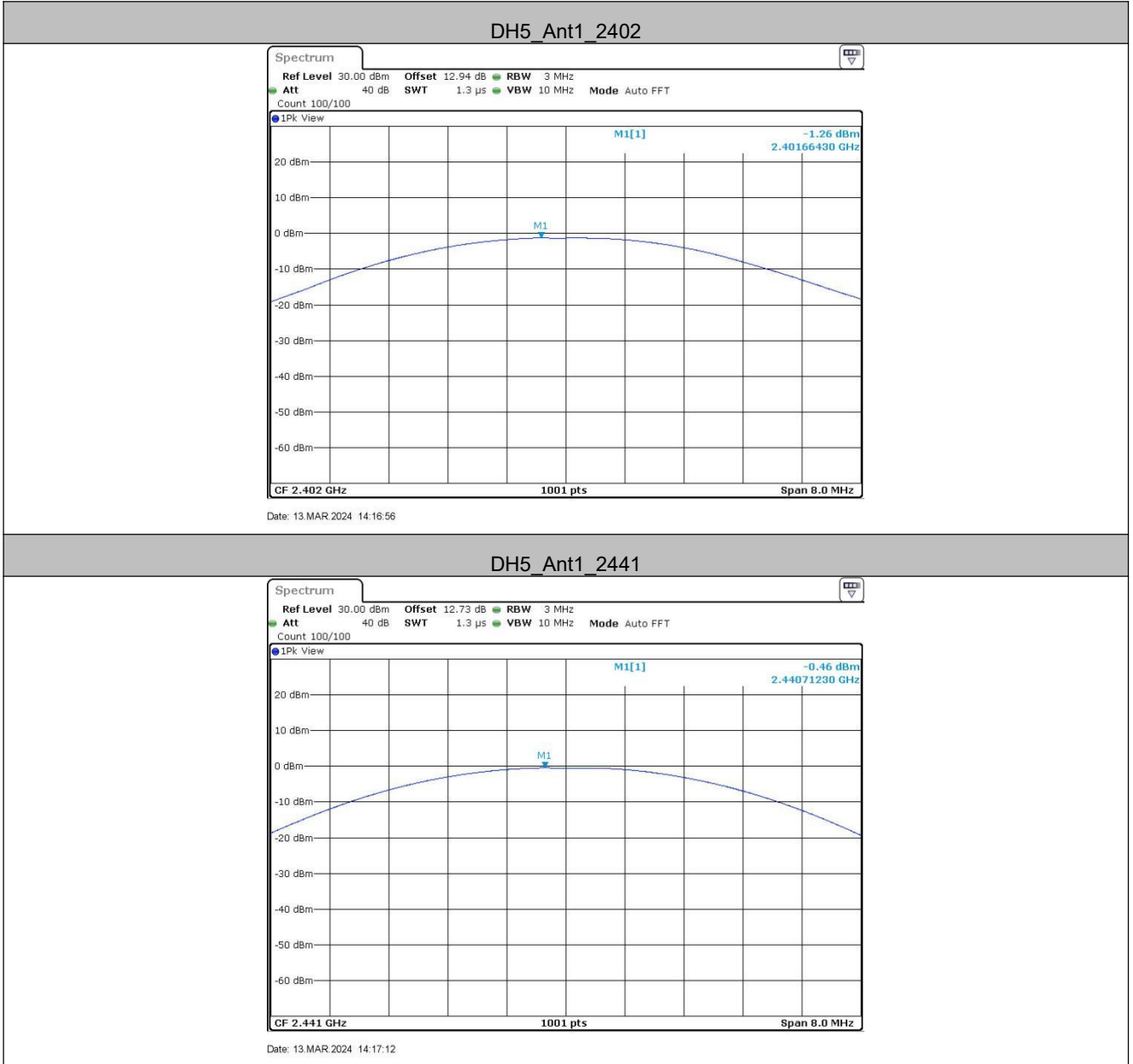

DH5_Ant1_2480

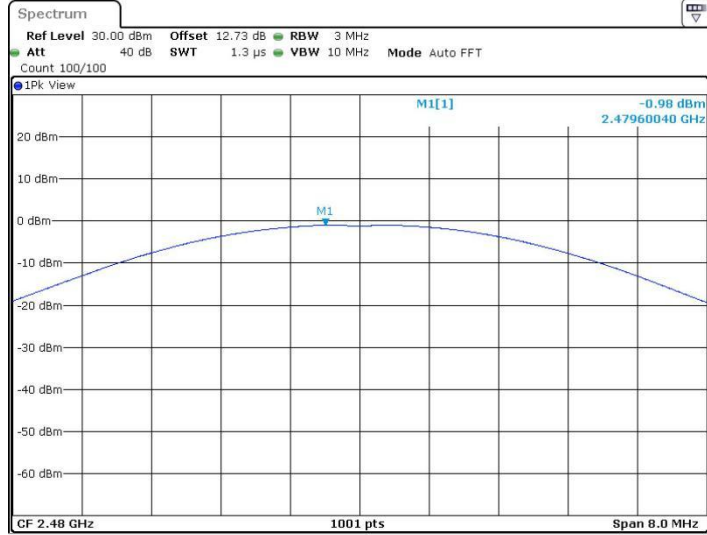

Date: 13.MAR.2024 14:17:27

2DH5_Ant1_2402

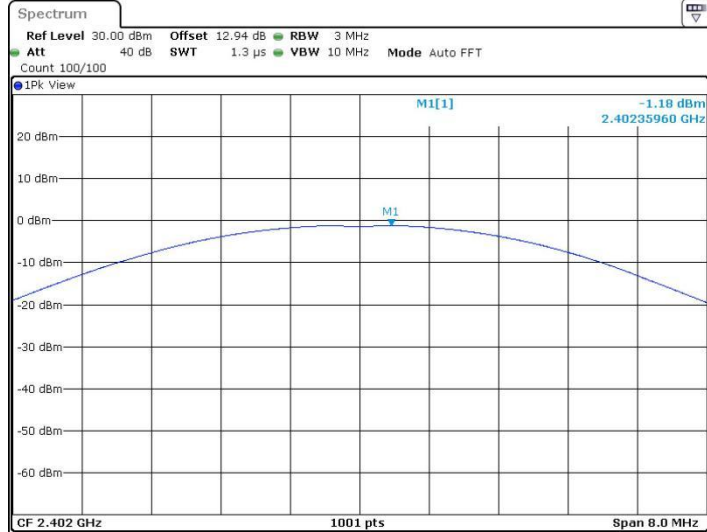

Date: 13.MAR.2024 14:17:42

2DH5_Ant1_2441

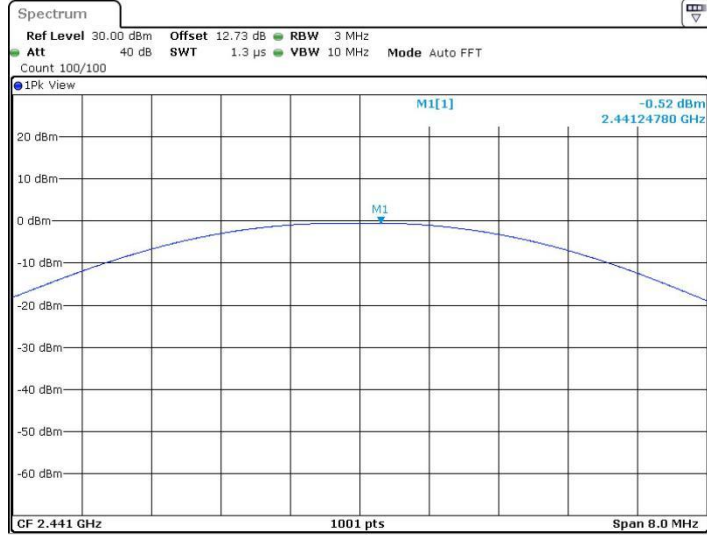

Date: 13.MAR.2024 14:17:56

2DH5_Ant1_2480

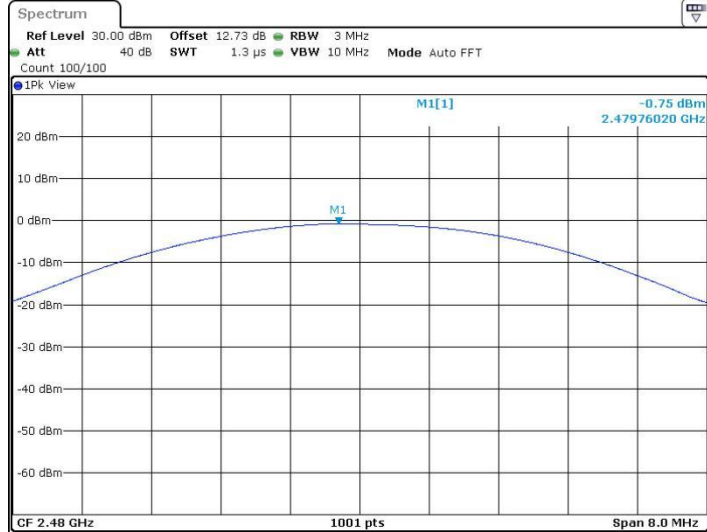

Date: 13.MAR.2024 14:18:10

3DH5_Ant1_2402

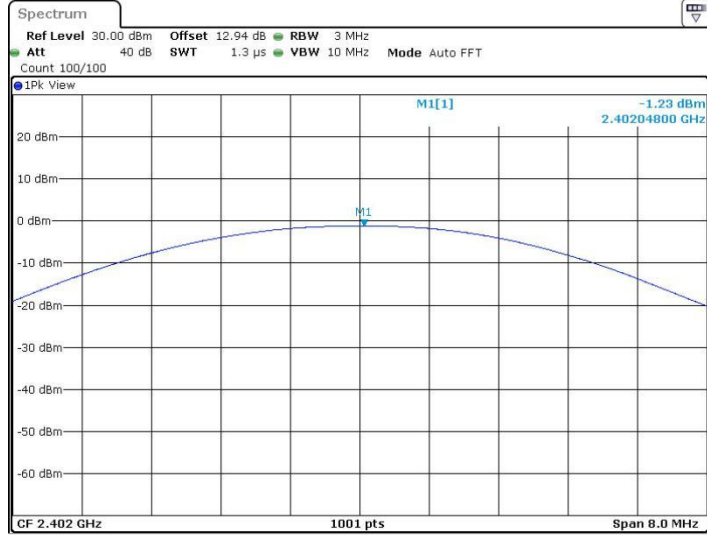

3DH5_Ant1_2441



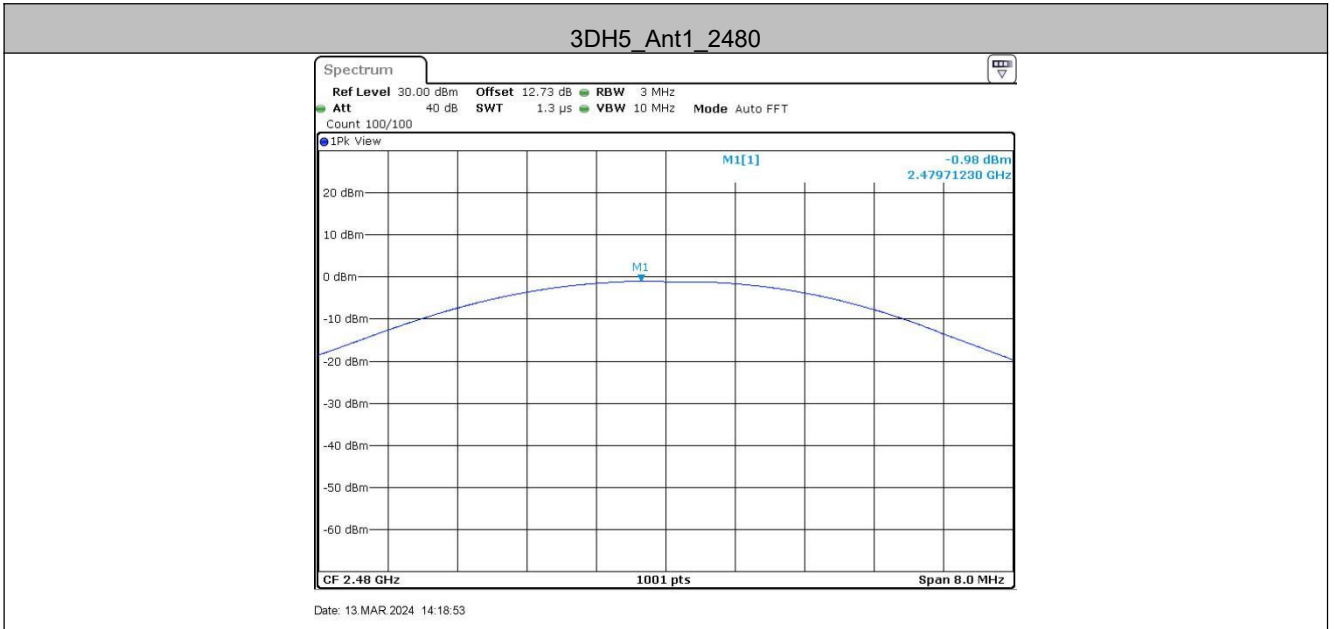

5.4 20dB Occupied Bandwidth

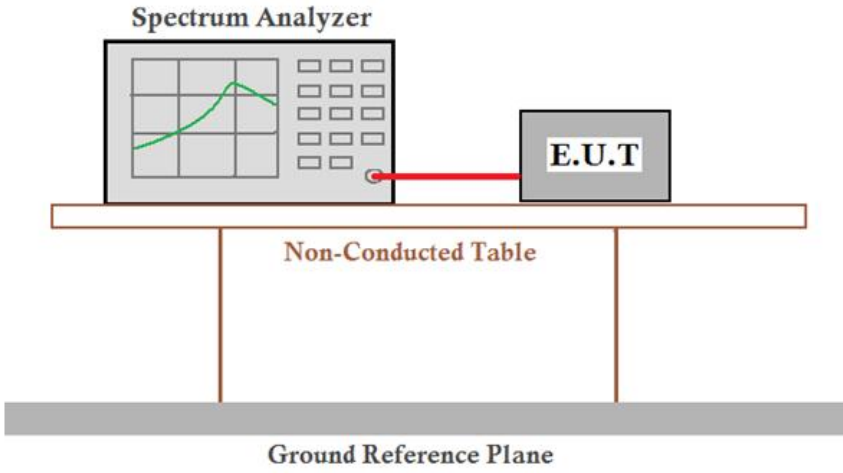
Test Requirement:	47 CFR Part 15C Section 15.247 (a)(1)
Test Method:	ANSI C63.10:2013
Test Setup:	 <p>Remark: Offset=Cable loss+ attenuation factor.</p>
Limit:	NA
Exploratory Test Mode:	Non-hopping transmitting with all kind of modulation and all kind of data type
Final Test Mode:	Only the worst case is recorded in the report.
Test Results:	Pass

Measurement Data

Test channel	20dB Occupy Bandwidth (MHz)		
	GFSK	$\pi/4$ DQPSK	8DPSK
Lowest	0.89	1.25	1.25
Middle	0.89	1.25	1.25
Highest	0.87	1.25	1.25

Test plot as follows:



DH5_Ant1_2480

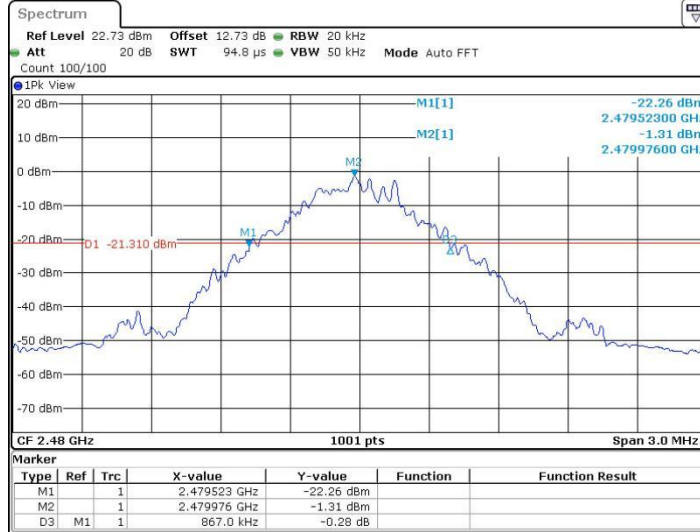

Date: 13.MAR.2024 12:51:22

2DH5_Ant1_2402

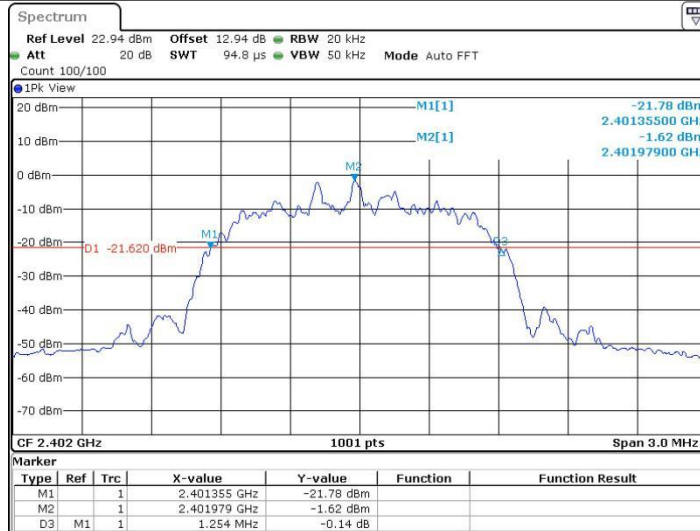

Date: 13.MAR.2024 12:55:47

2DH5_Ant1_2441

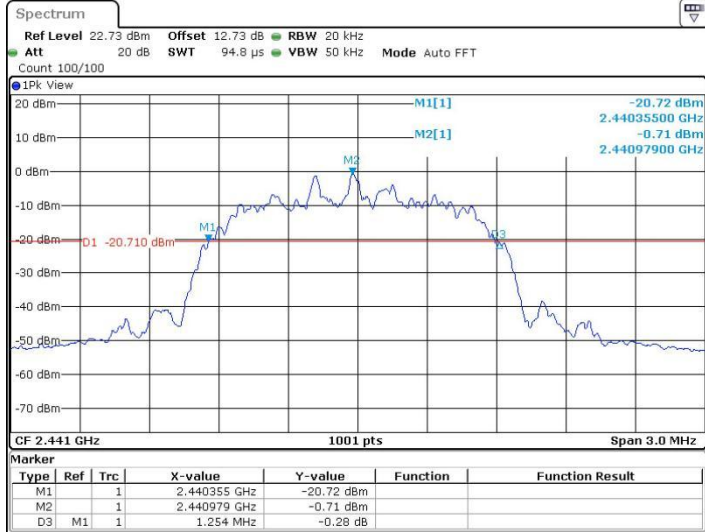

Date: 13.MAR.2024 12:59:21

2DH5_Ant1_2480



Date: 13.MAR.2024 13:02:57

3DH5_Ant1_2402

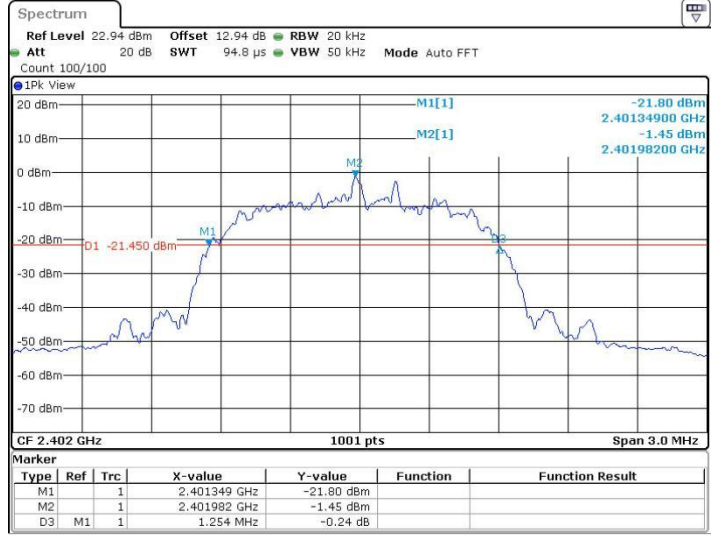

Date: 13.MAR.2024 13:23:38

3DH5_Ant1_2441

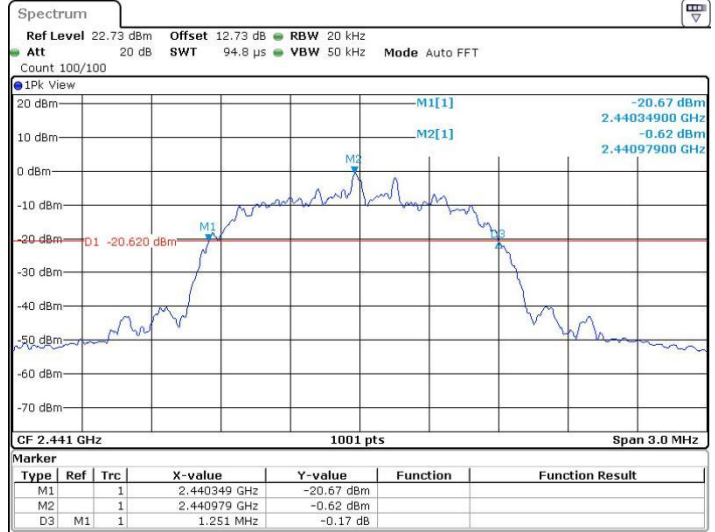

Date: 13.MAR.2024 13:26:19

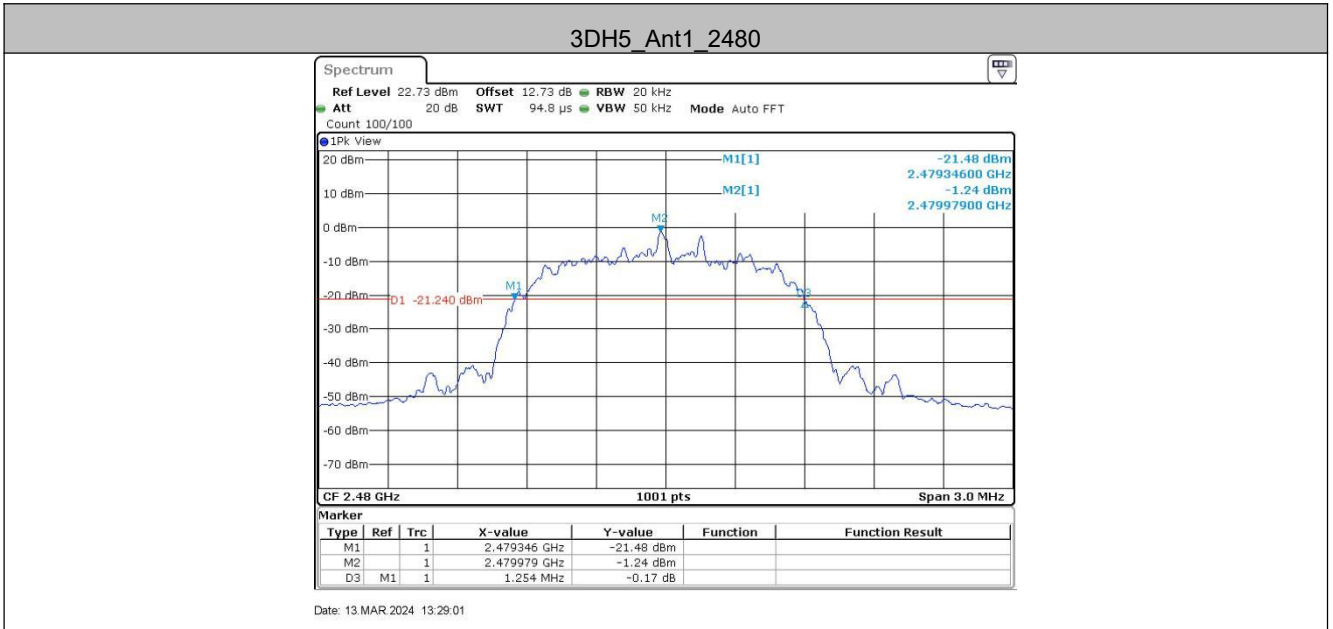

5.5 Carrier Frequencies Separation

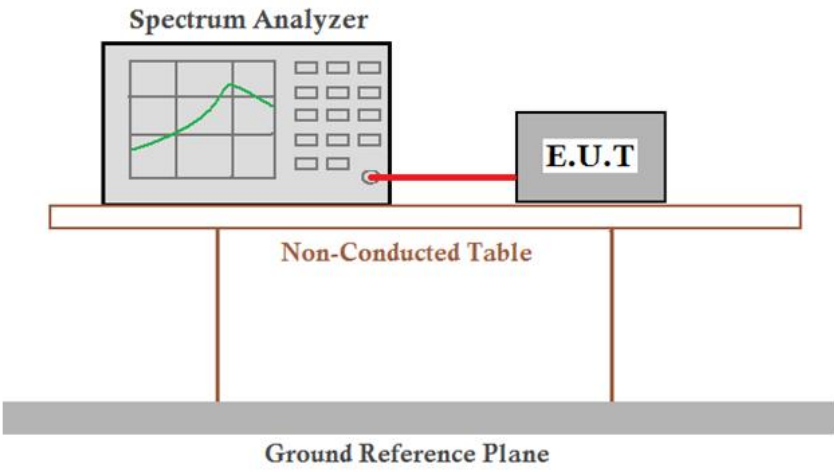
Test Requirement:	47 CFR Part 15C Section 15.247 (a)(1)
Test Method:	ANSI C63.10:2013
Test Setup:	 <p>Remark: Offset=Cable loss+ attenuation factor.</p>
Limit:	2/3 of the 20dB bandwidth
	Remark: the transmission power is less than 0.125W.
Exploratory Test Mode:	Hopping transmitting with all kind of modulation and all kind of data type
Final Test Mode:	Only the worst case is recorded in the report.
Test Results:	Pass

Measurement Data

TestMode	Freq(MHz)	Result[MHz]	Limit[MHz]	Verdict
DH5	Hop	0.997	≥0.593	PASS
2DH5	Hop	1.006	≥0.833	PASS
3DH5	Hop	1.006	≥0.833	PASS

Mode	20dB bandwidth (MHz) (worse case)	Limit (MHz) (Carrier Frequencies Separation)
GFSK	0.89	≥0.593
$\pi/4$ DQPSK	1.25	≥0.833
8DPSK	1.25	≥0.833

Test plot as follows:



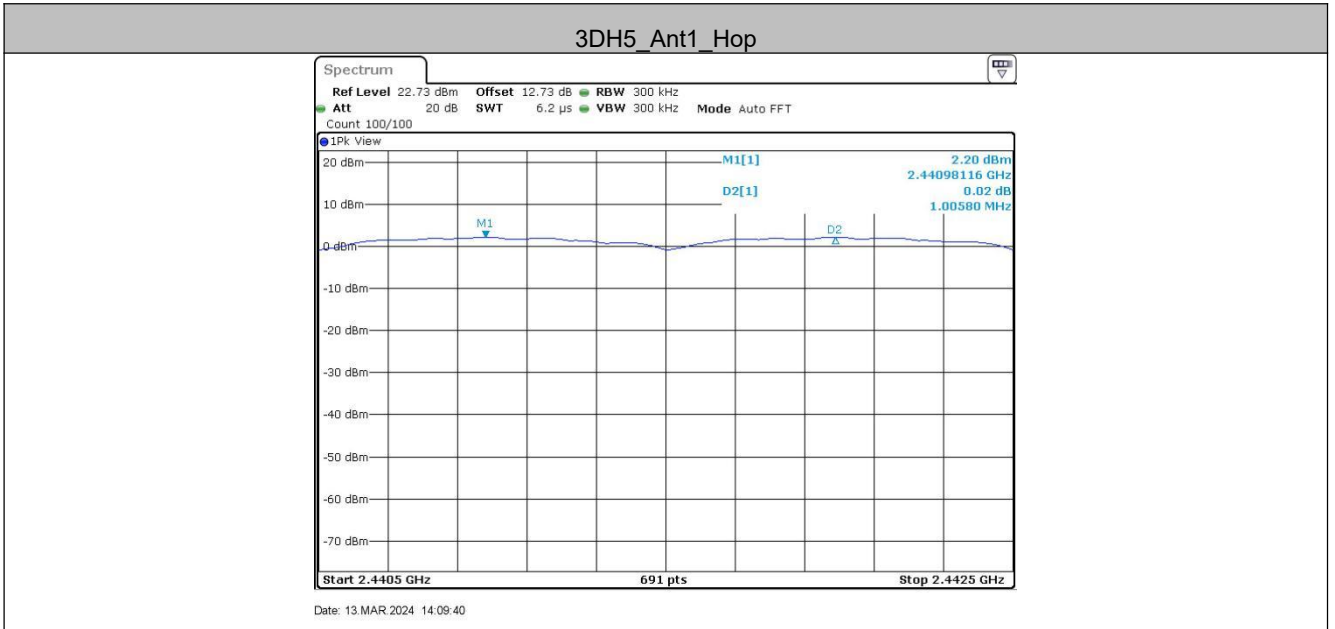

5.6 Hopping Channel Number

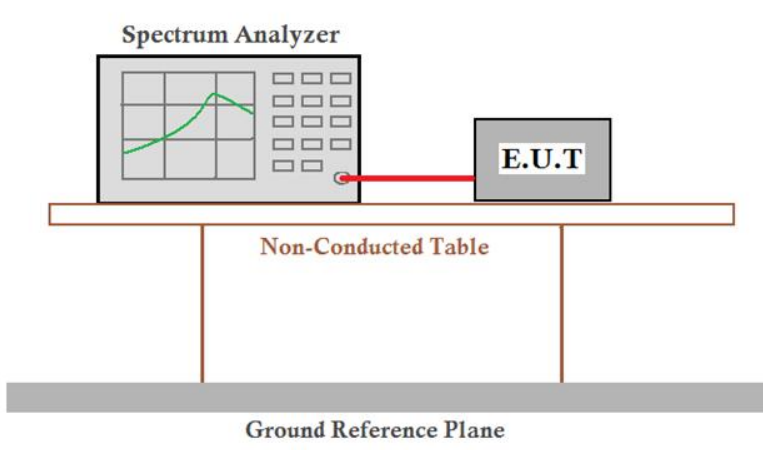
Test Requirement:	47 CFR Part 15C Section 15.247 (a)(1)
Test Method:	ANSI C63.10:2013
Test Setup:	 <p style="text-align: center;"><i>Remark: Offset=Cable loss+ attenuation factor.</i></p>
Limit:	At least 15 channels
Exploratory Test Mode:	hopping transmitting with all kind of modulation and all kind of data type
Final Test Mode:	Only the worst case is recorded in the report.
Test Results:	Pass

Measurement Data

Mode	Hopping channel numbers	Limit
GFSK	79	≥15
$\pi/4$ DQPSK	79	≥15
8DPSK	79	≥15

Test plot as follows:

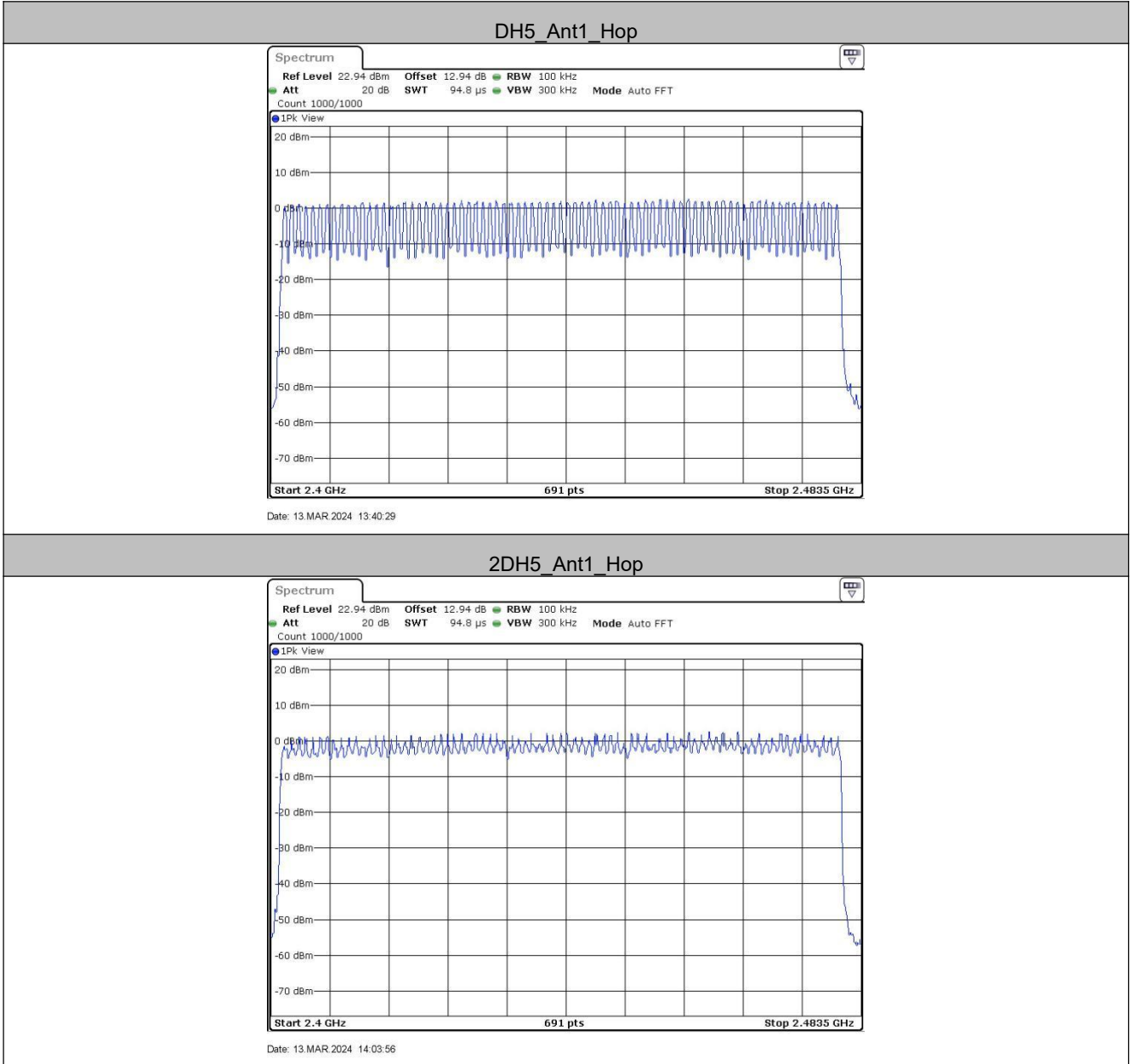

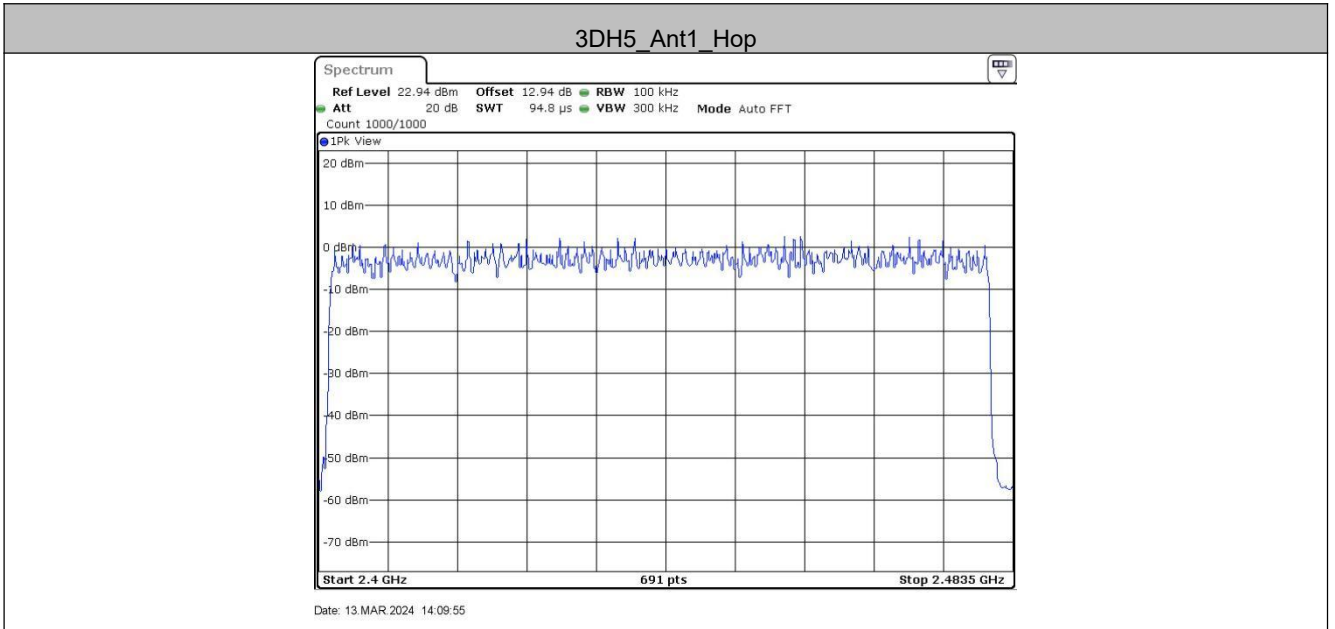

5.7 Dwell Time

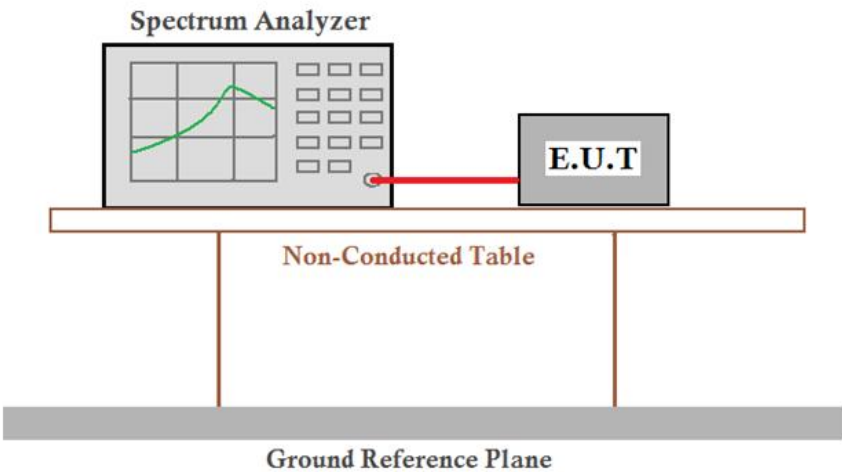
Test Requirement:	47 CFR Part 15C Section 15.247 (a)(1)
Test Method:	ANSI C63.10:2013
Test Setup:	 <p style="text-align: center;"><i>Remark: Offset=Cable loss+ attenuation factor.</i></p>
Test Mode:	Hopping transmitting with all kind of modulation and all kind of data type.
Limit:	0.4 Second
Test Results:	Pass

Measurement Data

TestMode	Freq(MHz)	BurstWidth [ms]	TotalHops [Num]	Result[s]	Limit[s]	Verdict
DH1	Hop	0.399	320	0.128	≤0.4	PASS
DH3	Hop	1.648	150	0.247	≤0.4	PASS
DH5	Hop	2.888	130	0.375	≤0.4	PASS
2DH1	Hop	0.409	320	0.131	≤0.4	PASS
2DH3	Hop	1.653	210	0.347	≤0.4	PASS
2DH5	Hop	2.893	110	0.318	≤0.4	PASS
3DH1	Hop	0.408	320	0.131	≤0.4	PASS
3DH3	Hop	1.650	150	0.248	≤0.4	PASS
3DH5	Hop	2.895	80	0.232	≤0.4	PASS

Remark:

The test period: $T = 0.4 \text{ Second/Channel} \times 79 \text{ Channel} = 31.6 \text{ s}$

Test plot as follows:

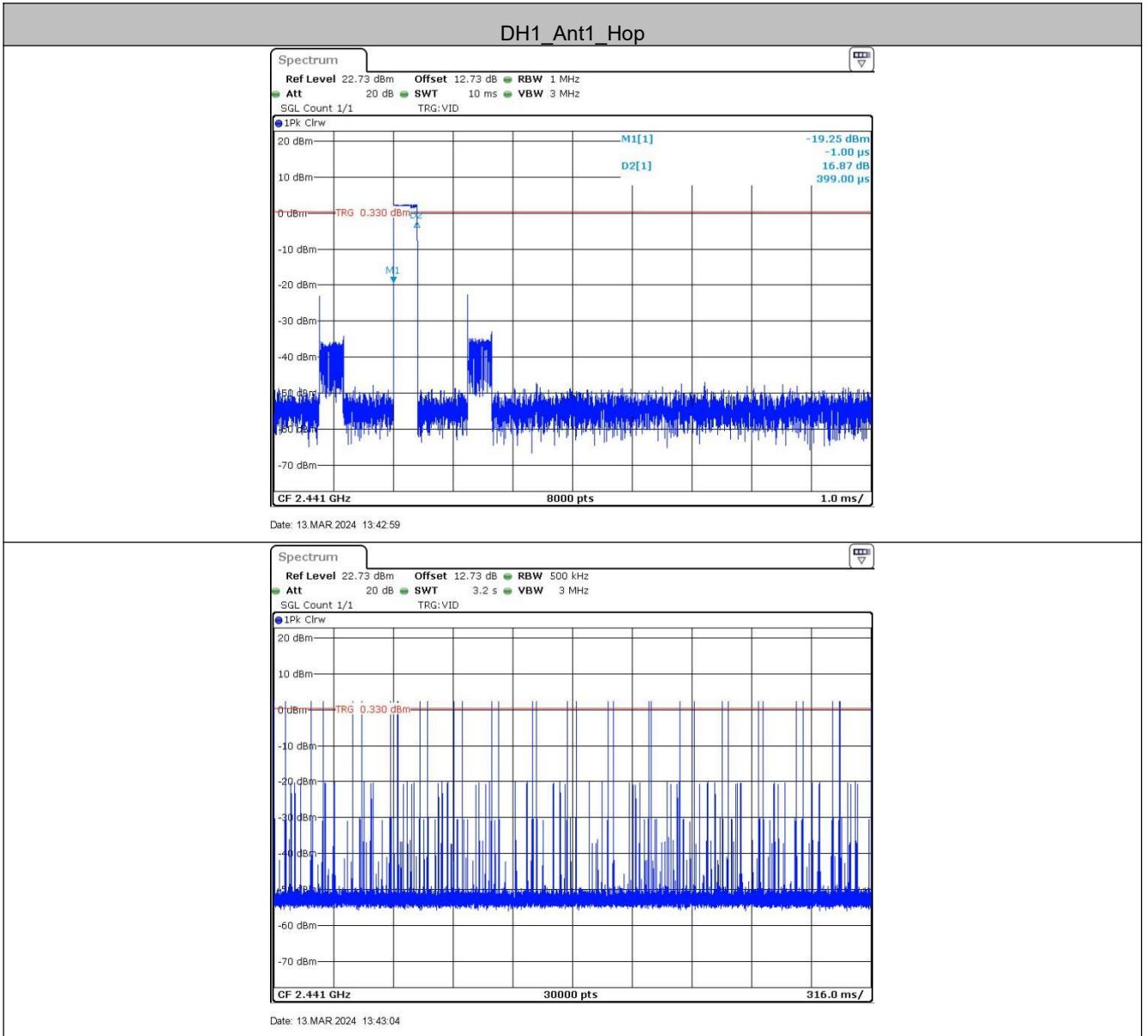

DH3_Ant1_Hop

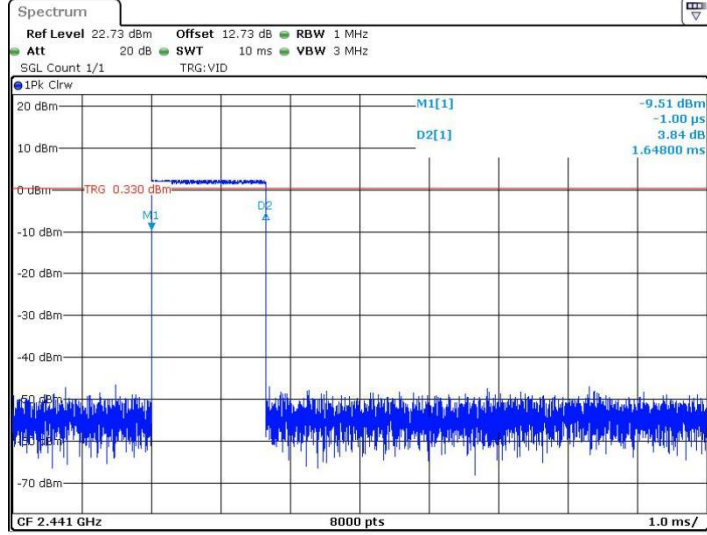

Date: 13.MAR 2024 13:43:43

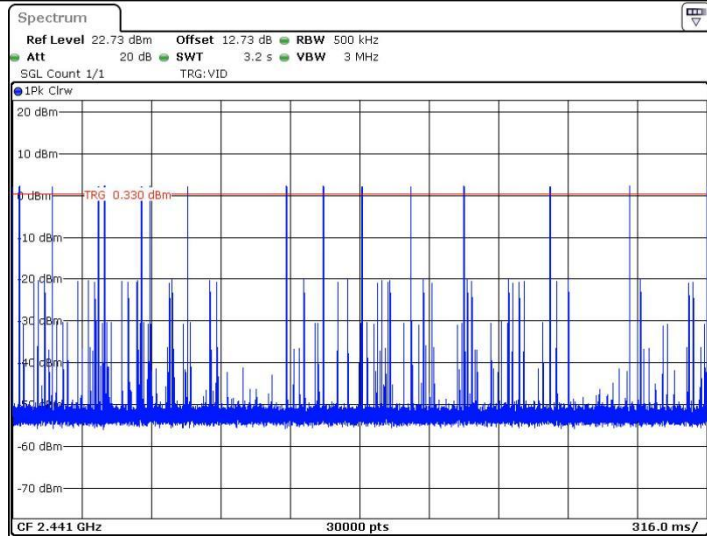

Date: 13.MAR 2024 13:43:49

DH5_Ant1_Hop

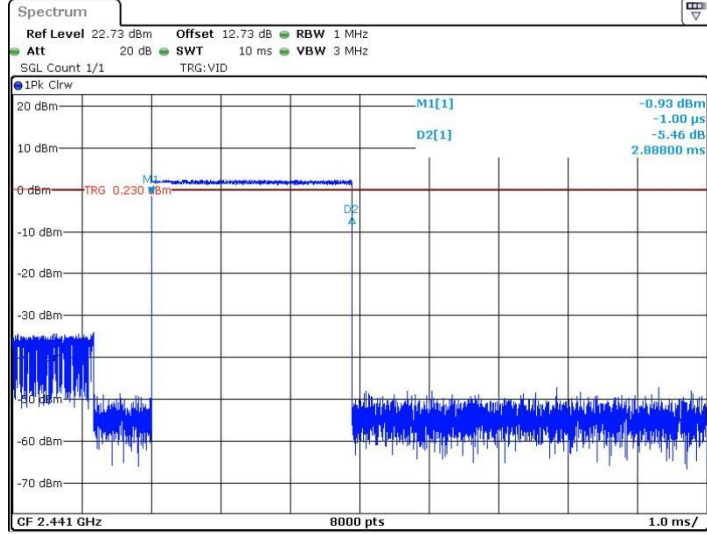

Date: 13.MAR 2024 14:13:45

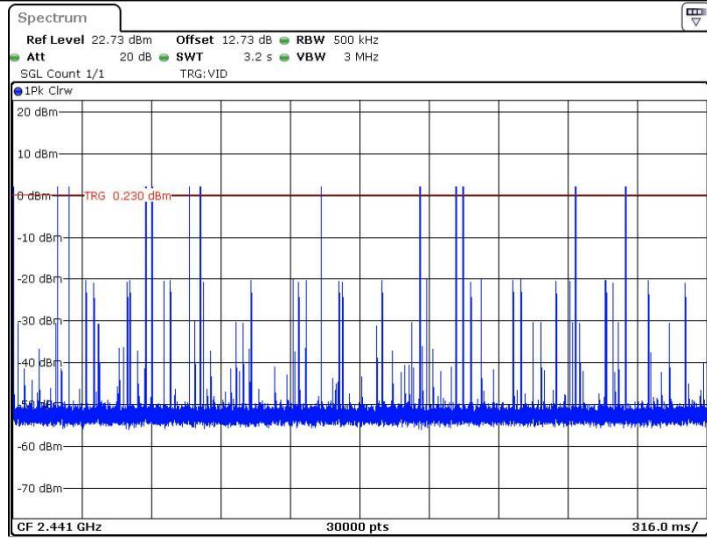

Date: 13.MAR 2024 14:13:50

2DH1_Ant1_Hop

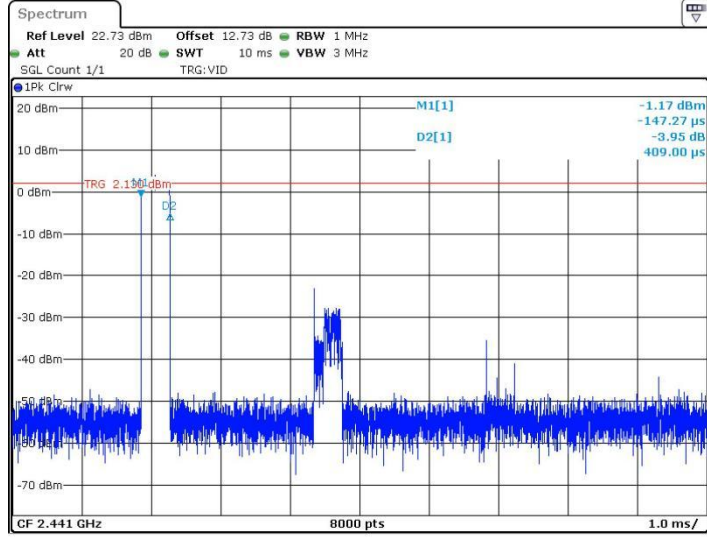

Date: 13.MAR 2024 14:04:46

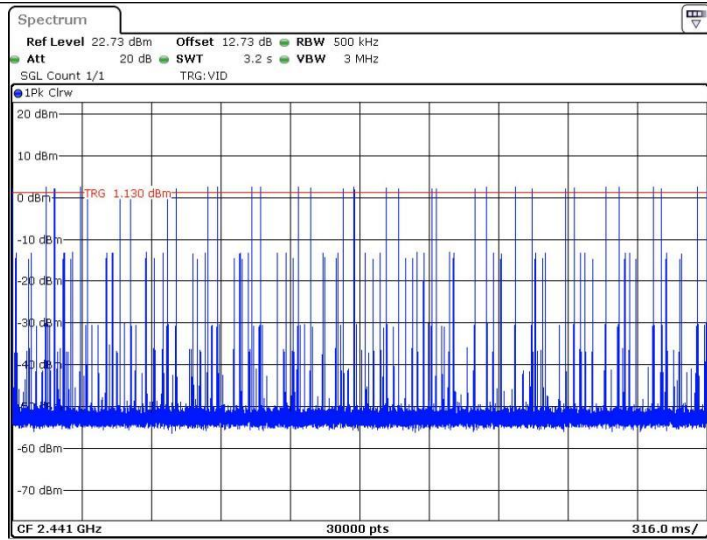

Date: 13.MAR 2024 14:04:58

2DH3_Ant1_Hop

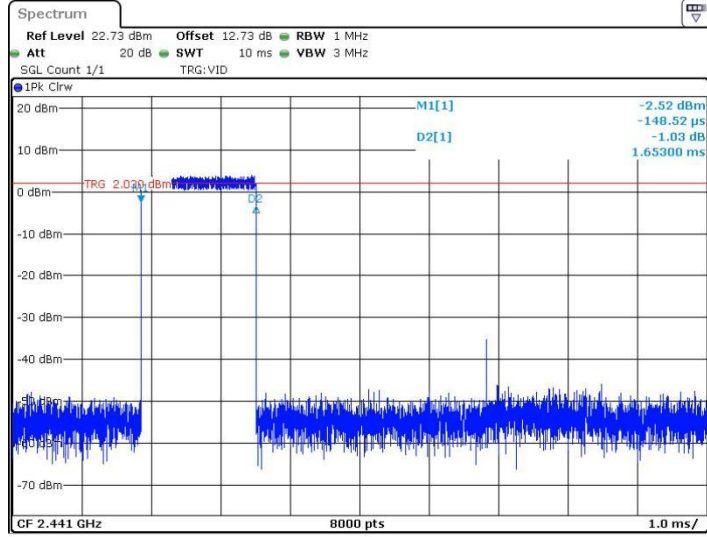

Date: 13.MAR 2024 14:05:23

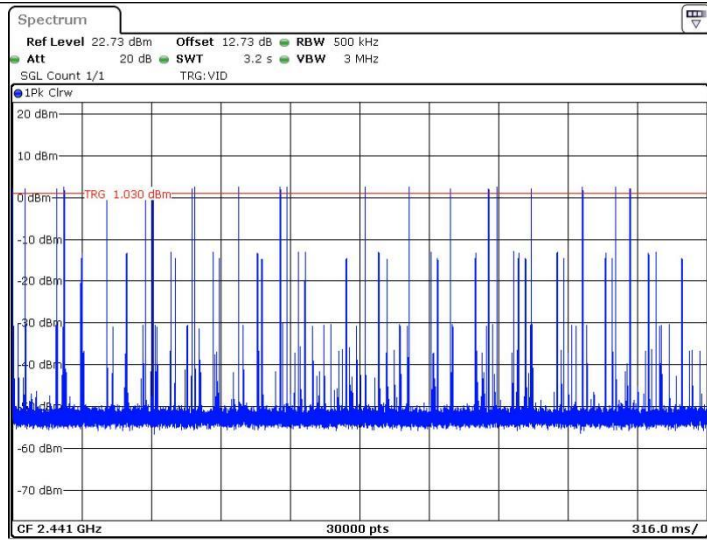

Date: 13.MAR 2024 14:05:35

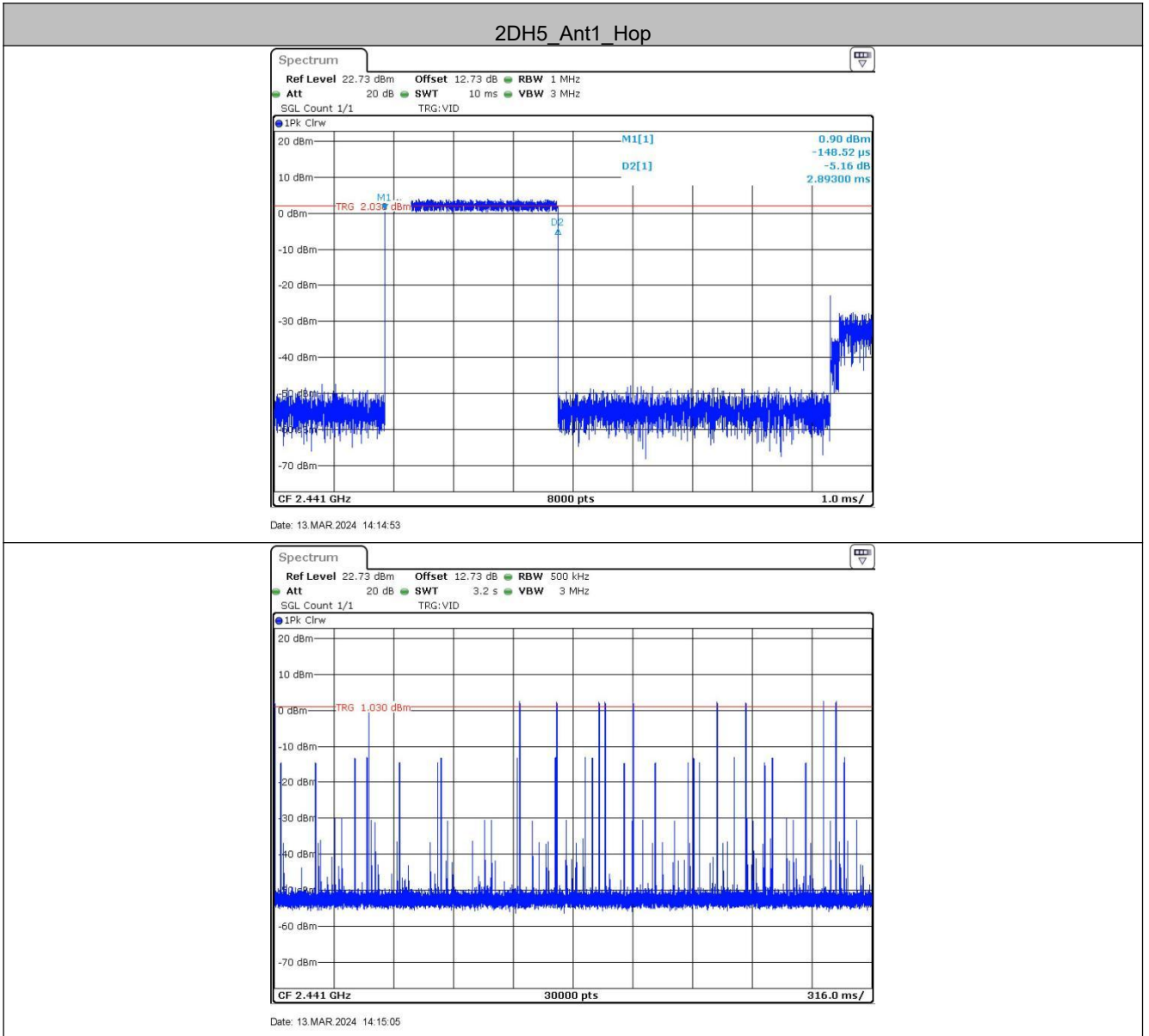

3DH1_Ant1_Hop

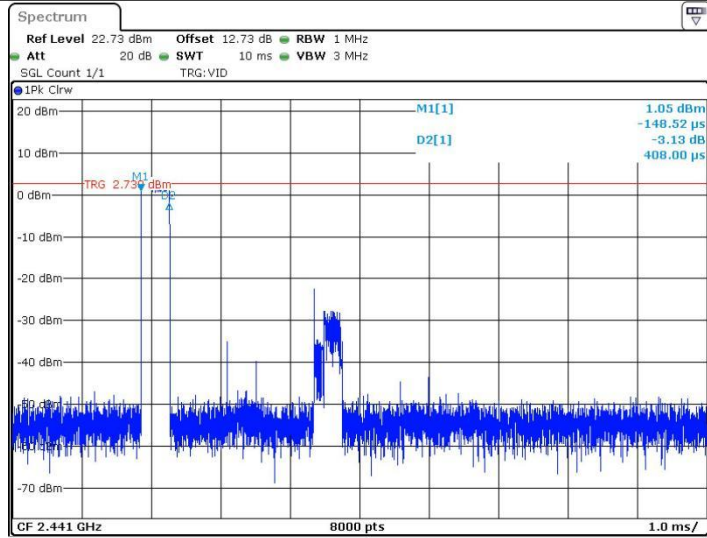

Date: 13.MAR 2024 14:10:47

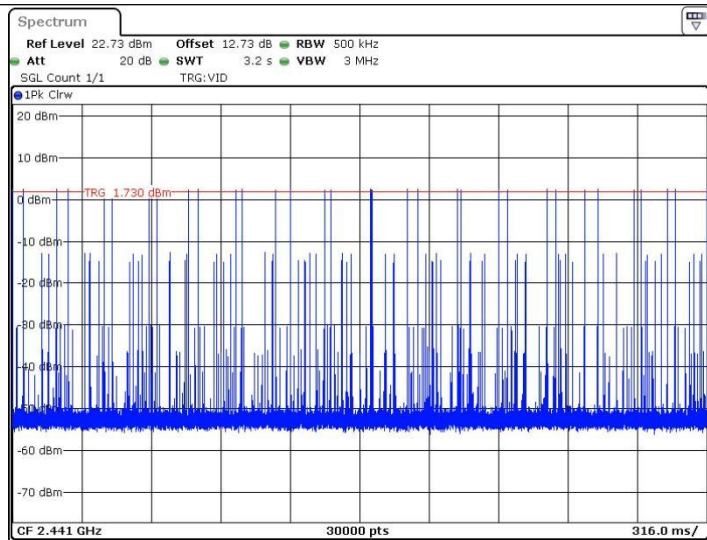

Date: 13.MAR 2024 14:10:59

3DH3_Ant1_Hop

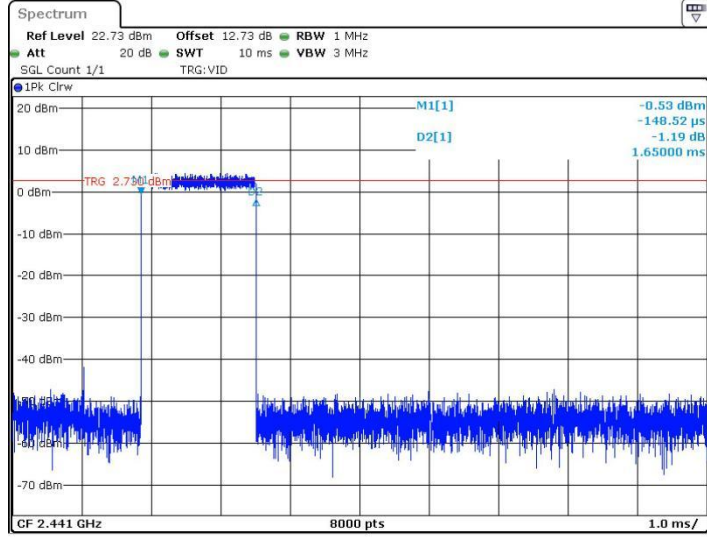

Date: 13.MAR.2024 14:11:22

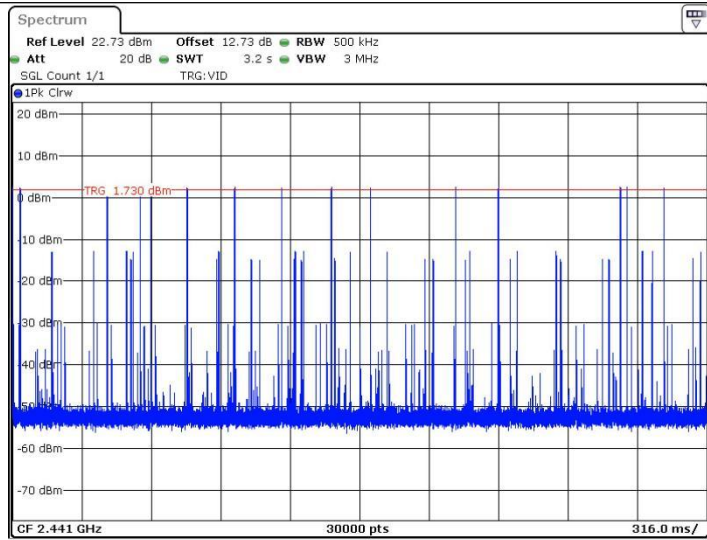

Date: 13.MAR.2024 14:11:34

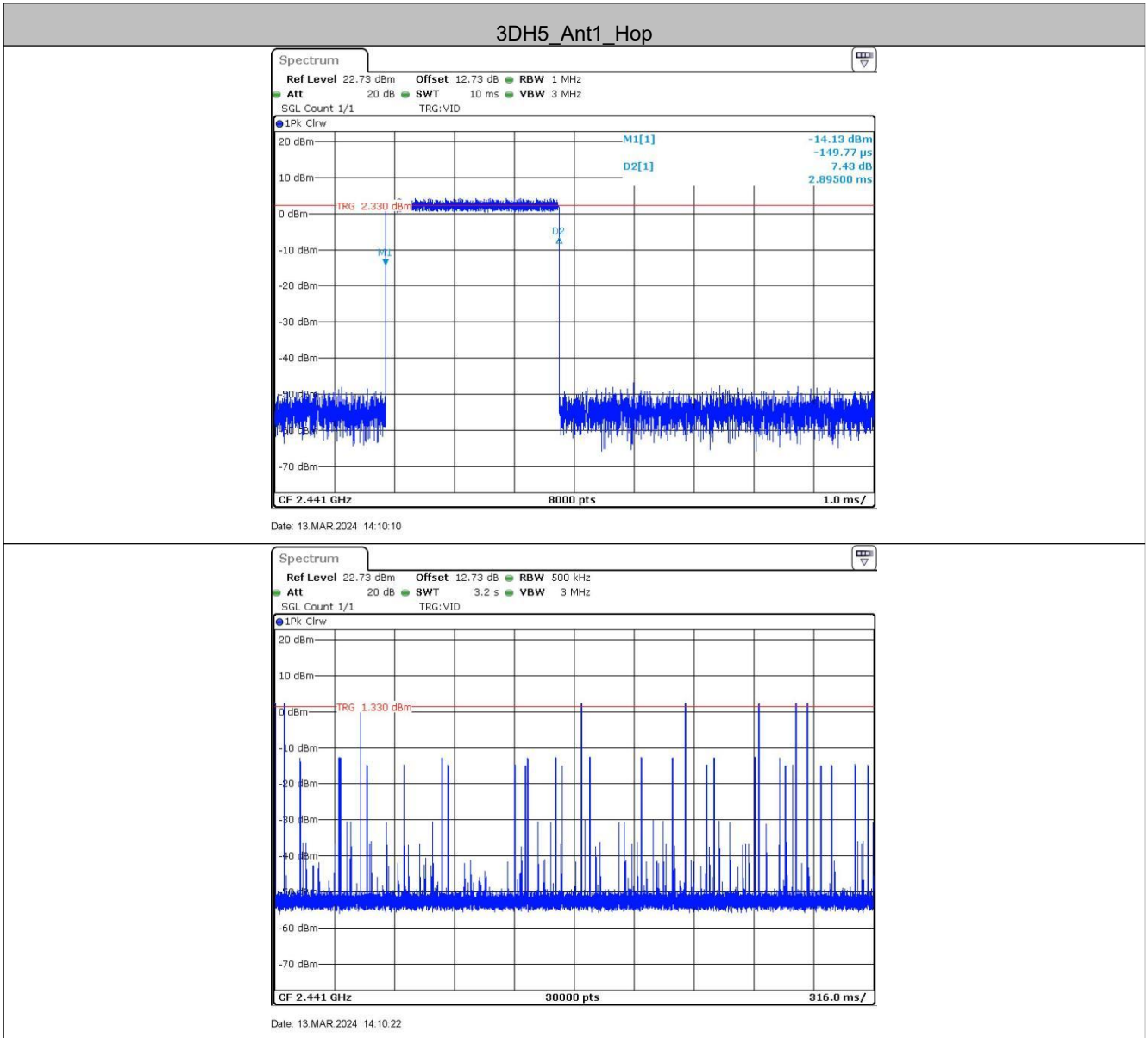

5.8 Band-edge for RF Conducted Emissions

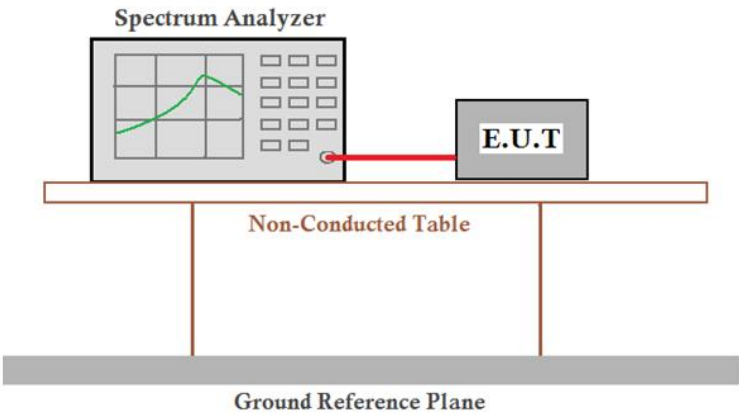
Test Requirement:	47 CFR Part 15C Section 15.247 (d)
Test Method:	ANSI C63.10:2013
Test Setup:	 <p style="text-align: center;"><i>Remark: Offset=cable loss+ attenuation factor.</i></p>
Limit:	In any 100 kHz bandwidth outside the frequency band in which the spread spectrum intentional radiator is operating, the radio frequency power that is produced by the intentional radiator shall be at least 20 dB below that in the 100 kHz bandwidth within the band that contains the highest level of the desired power, based on either an RF conducted or a radiated measurement.
Exploratory Test Mode:	Hopping and Non-hopping transmitting with all kind of modulation and all kind of data type
Final Test Mode:	Only the worst case is recorded in the report.
Test Results:	Pass

Measurement Data

TestMode	ChName	Freq(MHz)	RefLevel [dBm]	Result [dBm]	Limit [dBm]	Verdict
DH5	Low	2402	1.03	-54.17	≤-18.97	PASS
	High	2480	1.30	-53.74	≤-18.7	PASS
	Low	Hop_2402	0.28	-55.2	≤-19.72	PASS
	High	Hop_2480	1.89	-54.84	≤-18.11	PASS
2DH5	Low	2402	1.09	-53.53	≤-18.91	PASS
	High	2480	1.32	-53.12	≤-18.68	PASS
	Low	Hop_2402	0.83	-55.75	≤-19.17	PASS
	High	Hop_2480	1.69	-54.37	≤-18.31	PASS
3DH5	Low	2402	1.41	-46.65	≤-18.59	PASS
	High	2480	1.47	-54.22	≤-18.53	PASS
	Low	Hop_2402	-1.92	-55.46	≤-21.92	PASS
	High	Hop_2480	2.03	-55.26	≤-17.97	PASS

Test plot as follows:

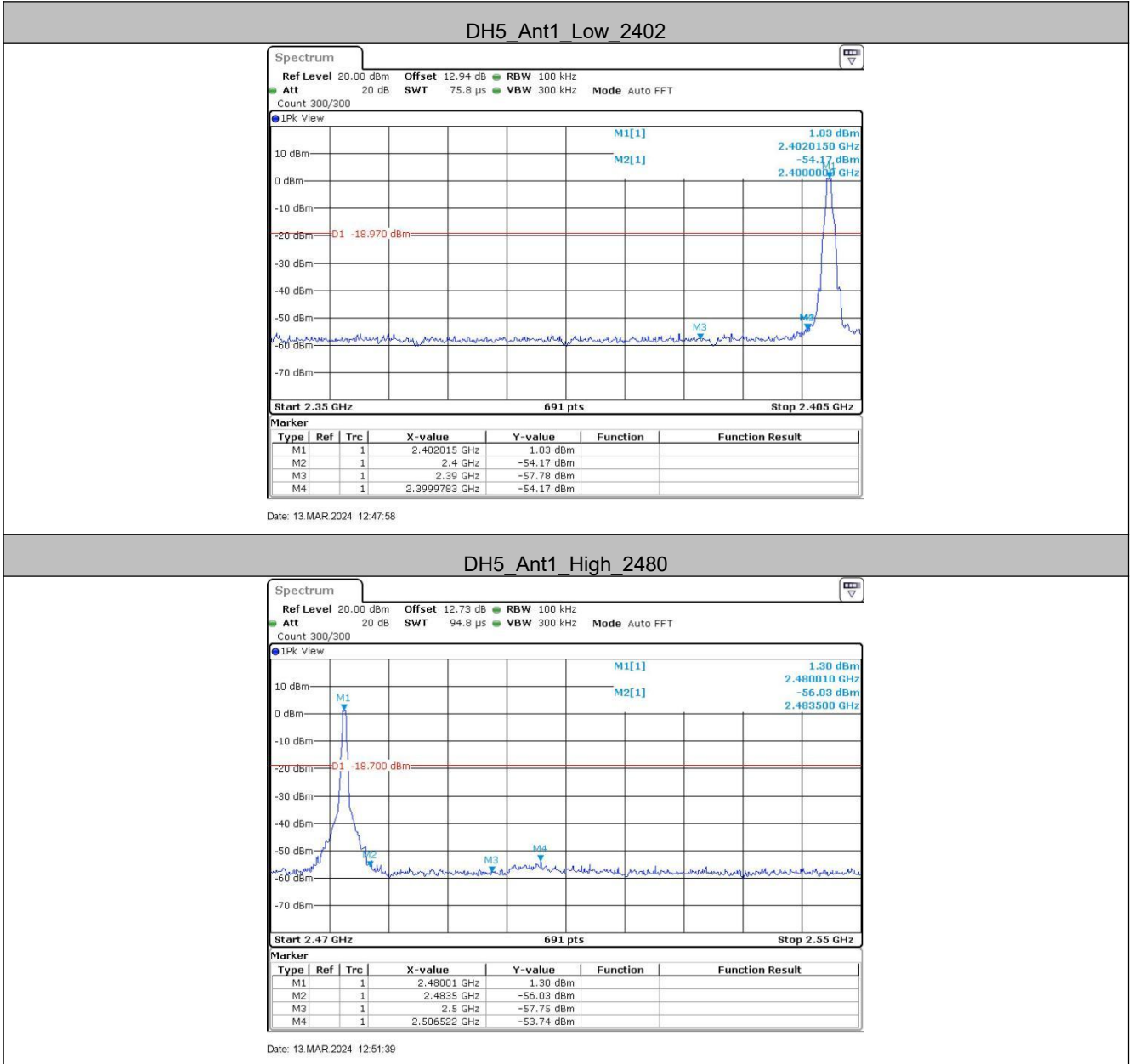

DH5_Ant1_Low_Hop_2402

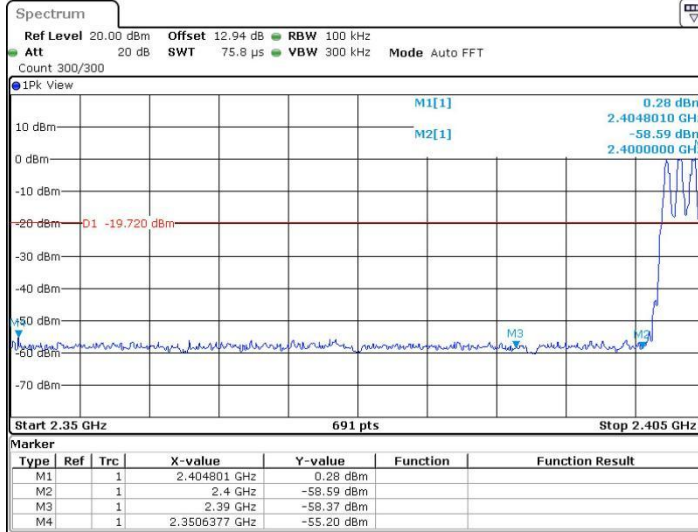

Date: 13.MAR.2024 13:35:15

DH5_Ant1_High_Hop_2480

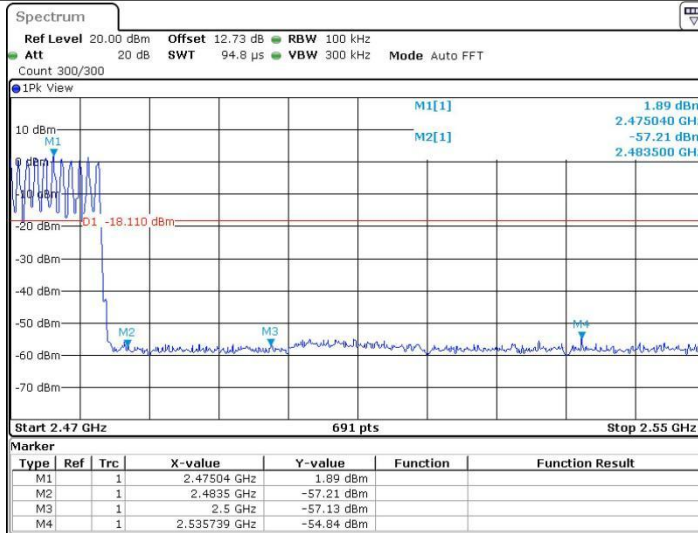

Date: 13.MAR.2024 13:45:56

2DH5_Ant1_Low_2402

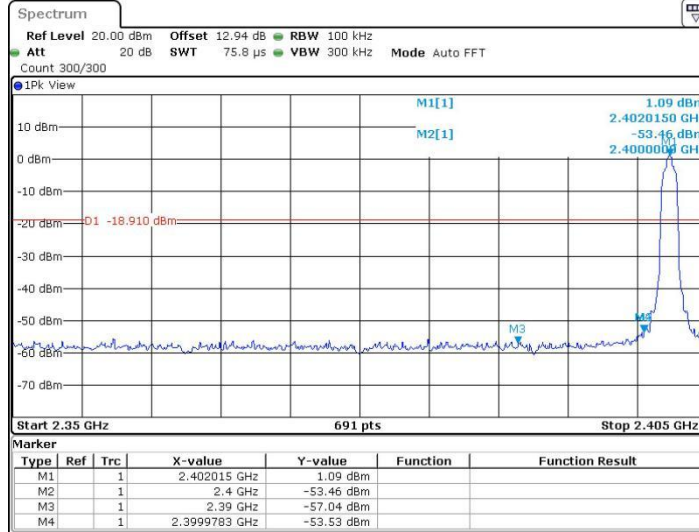

Date: 13.MAR.2024 12:56:04

2DH5_Ant1_High_2480

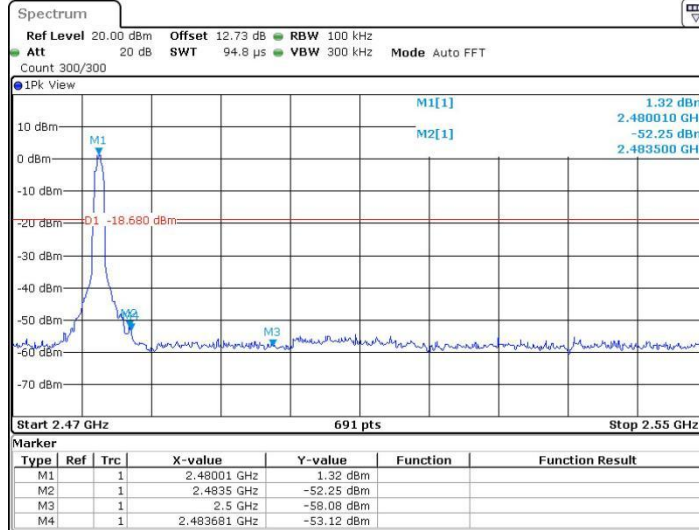

Date: 13.MAR.2024 13:03:13

2DH5_Ant1_Low_Hop_2402

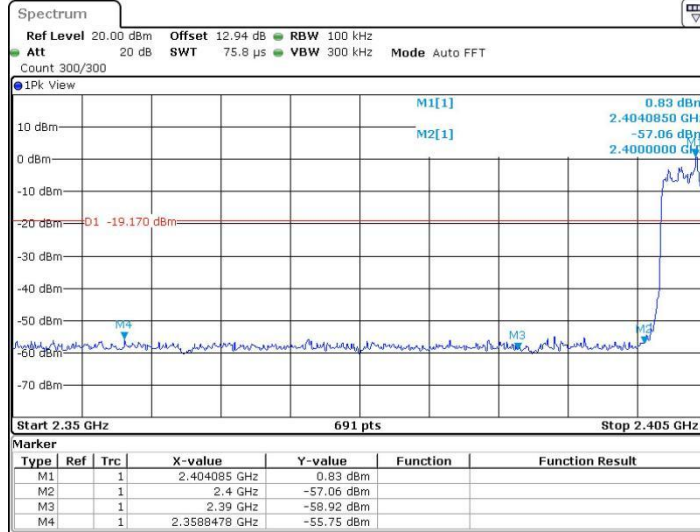

Date: 13.MAR.2024 14:00:33

2DH5_Ant1_High_Hop_2480

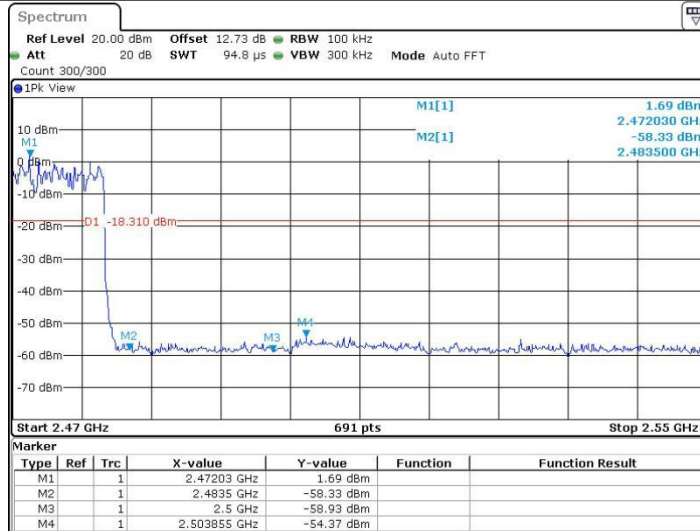

Date: 13.MAR.2024 14:05:54

3DH5_Ant1_Low_2402

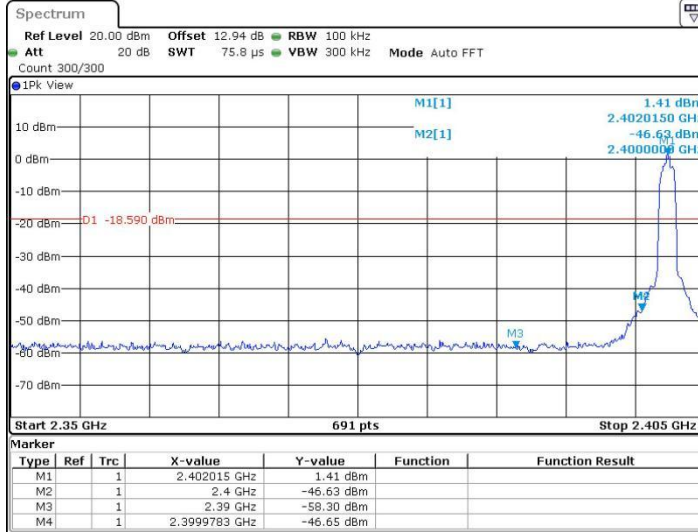

Date: 13.MAR 2024 13:23:55

3DH5_Ant1_High_2480

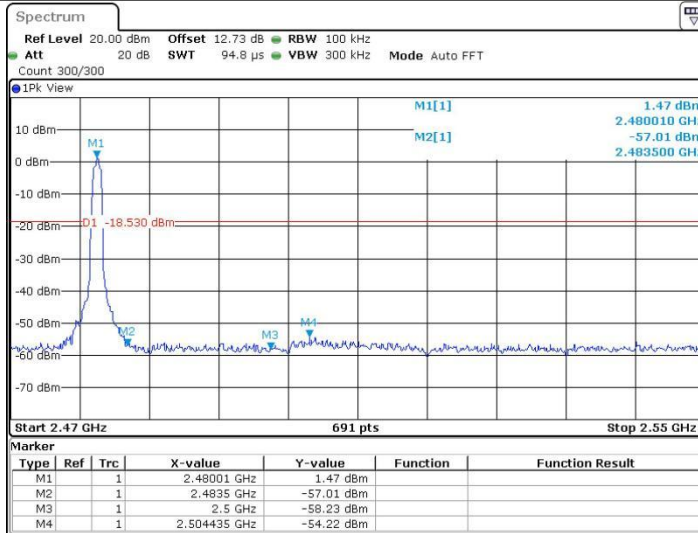

Date: 13.MAR 2024 13:29:18

3DH5_Ant1_Low_Hop_2402

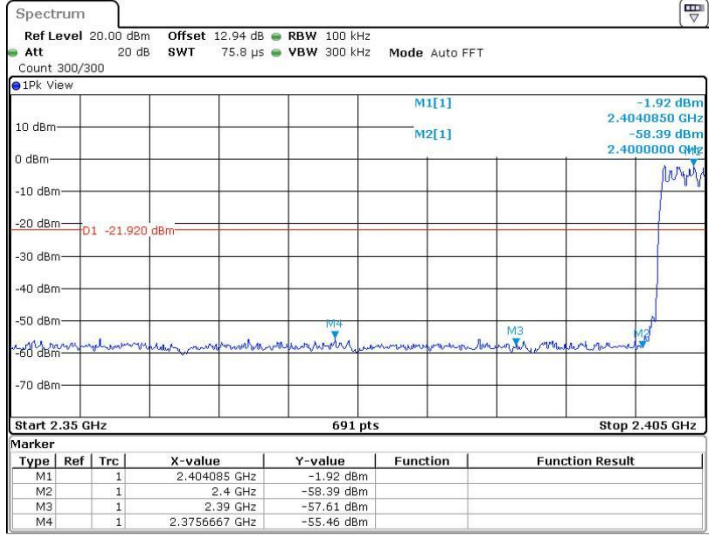

Date: 13.MAR.2024 14:07:20

3DH5_Ant1_High_Hop_2480

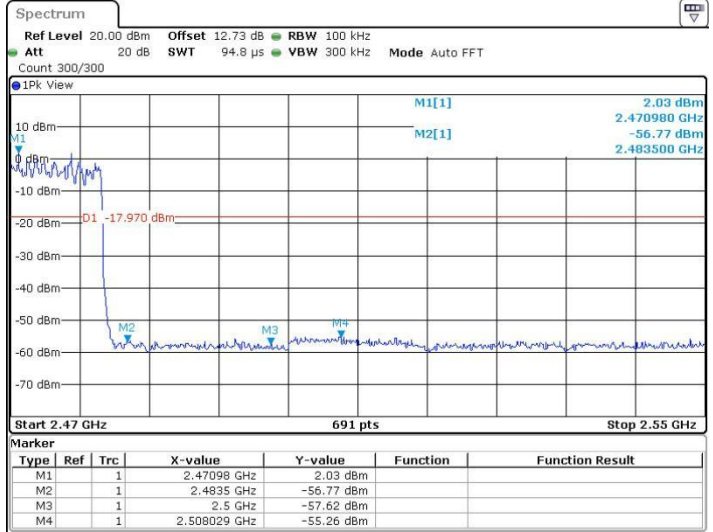

Date: 13.MAR.2024 14:11:57

5.9 Spurious RF Conducted Emissions

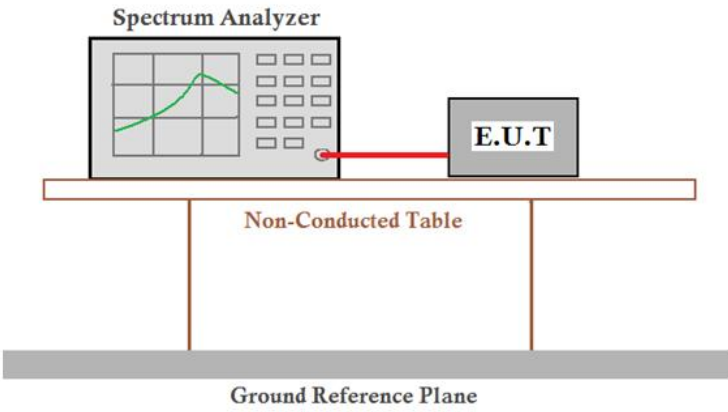
Test Requirement:	47 CFR Part 15C Section 15.247 (d)
Test Method:	ANSI C63.10:2013
Test Setup:	 <p style="text-align: center;"><i>Remark: Offset=cable loss+ attenuation factor.</i></p>
Limit:	In any 100 kHz bandwidth outside the frequency band in which the spread spectrum intentional radiator is operating, the radio frequency power that is produced by the intentional radiator shall be at least 20 dB below that in the 100 kHz bandwidth within the band that contains the highest level of the desired power, based on either an RF conducted or a radiated measurement.
Exploratory Test Mode:	Non-hopping transmitting with all kind of modulation and all kind of data type
Final Test Mode:	Through Pre-scan, find the DH5 of data type is the worst case of GFSK modulation type, 2-DH5 of data type is the worst case of $\pi/4$ DQPSK modulation type, 3-DH5 of data type is the worst case of 8DPSK modulation type.
Test Results:	Pass

DH5_Ant1_2402_0~Reference

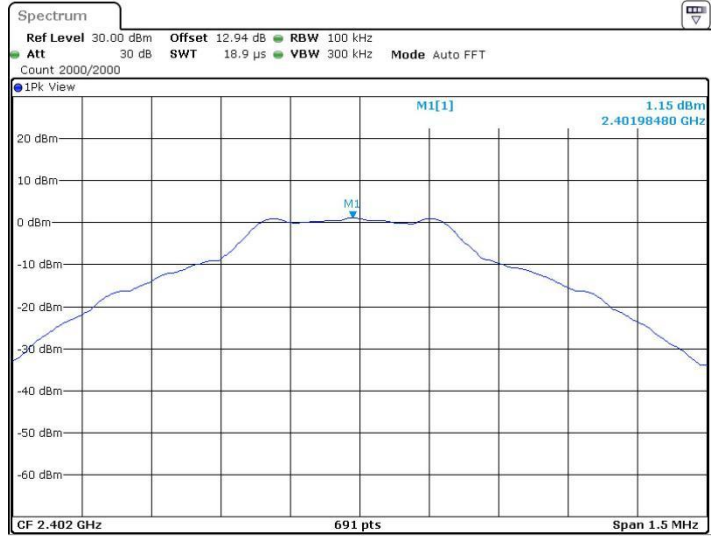

Date: 13 MAR 2024 12:49:36

DH5_Ant1_2402_30~1000

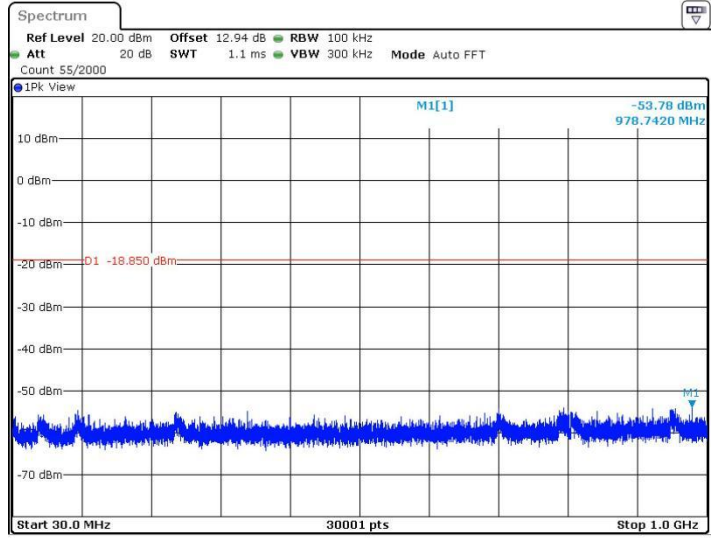

Date: 13 MAR 2024 12:49:43

DH5_Ant1_2402_1000~26500

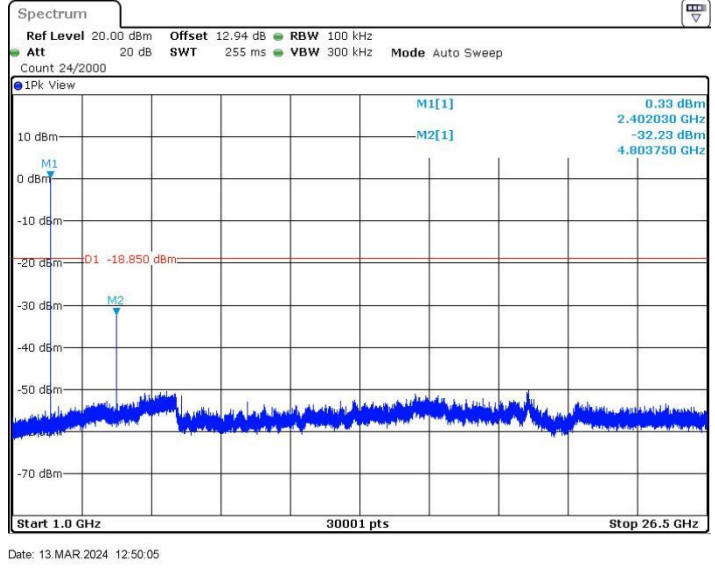

DH5_Ant1_2441_0~Reference

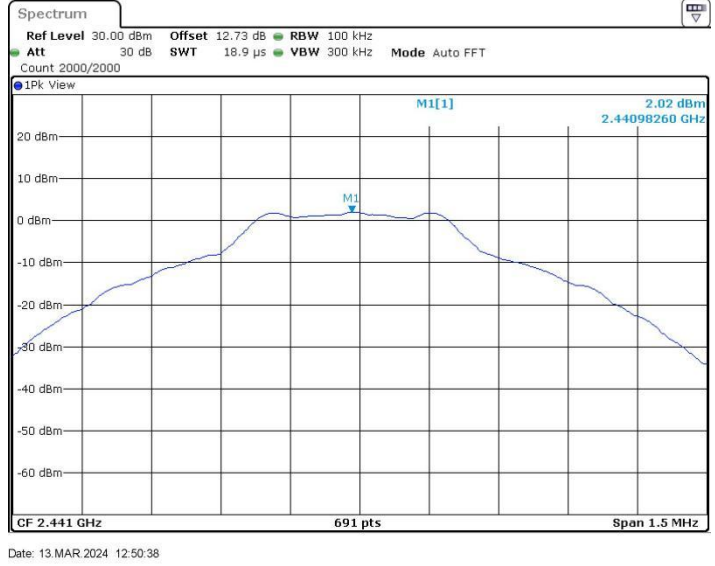

DH5_Ant1_2441_30~1000

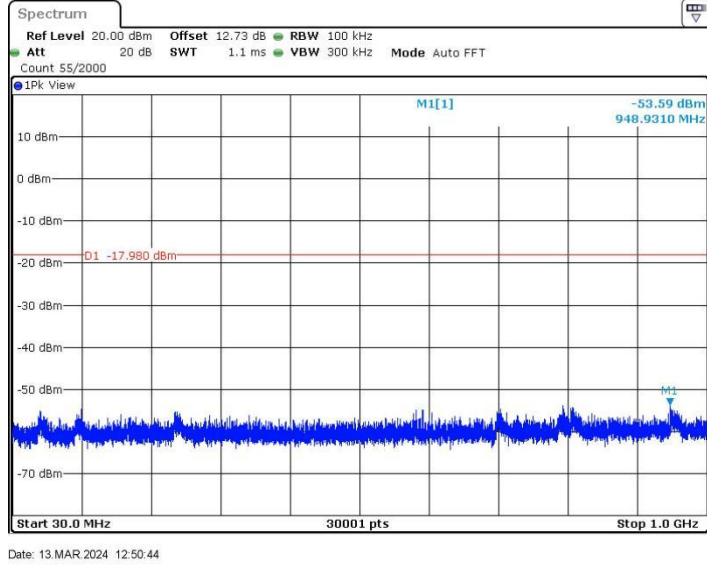

DH5_Ant1_2441_1000~26500

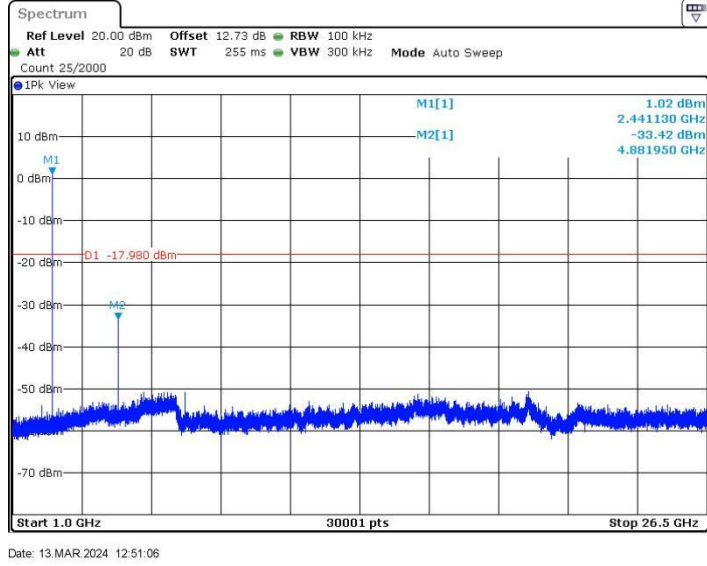

DH5_Ant1_2480_0~Reference



DH5_Ant1_2480_30~1000

