



### NB-IOT Band 71 BPSK 3.75kHz 1@0 CH-Low



### NB-IOT Band 71 BPSK 3.75kHz 1@47 CH-High



### NB-IOT Band 71 BPSK 15kHz 1@0 CH-Low



### NB-IOT Band 71 BPSK 15kHz 1@11 CH-High



### NB-IOT Band 71 QPSK 3.75kHz 1@0 CH-Low



### NB-IOT Band 71 QPSK 3.75kHz 1@47 CH-High

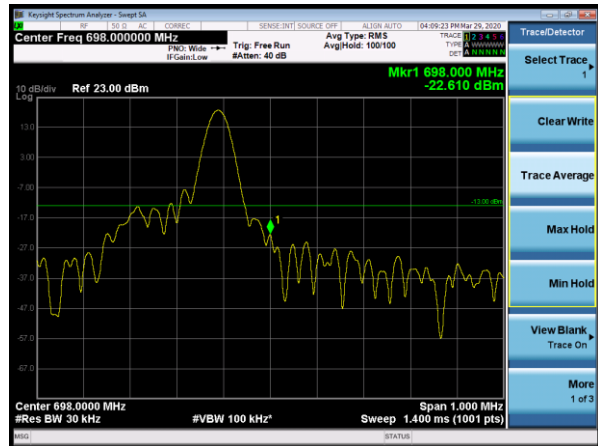

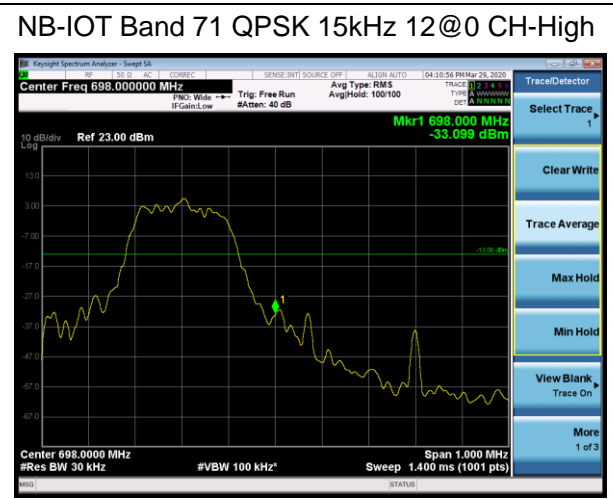
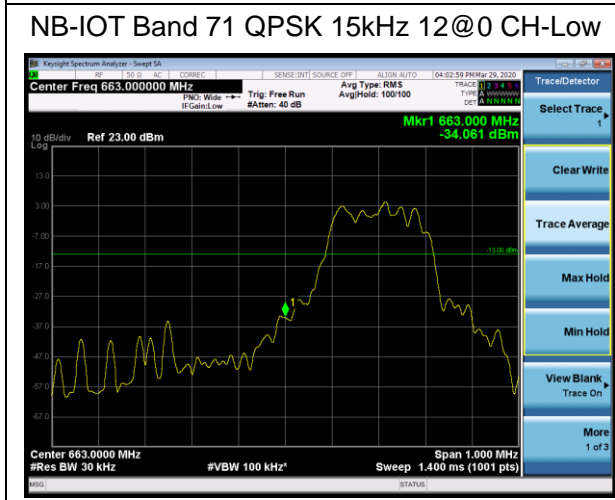
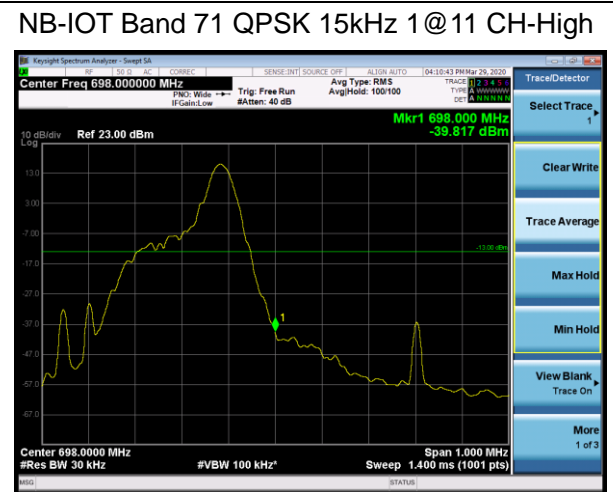
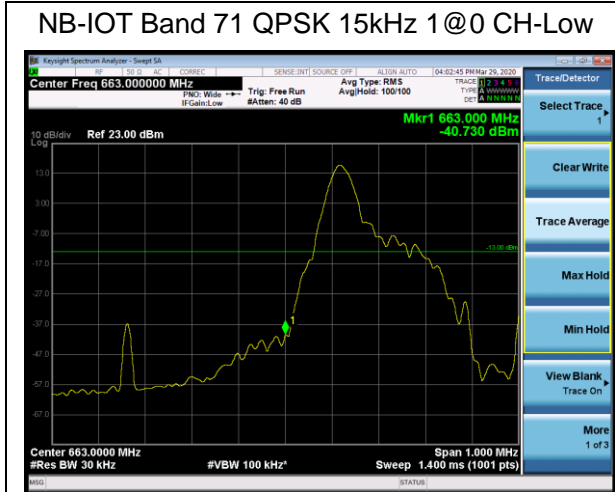

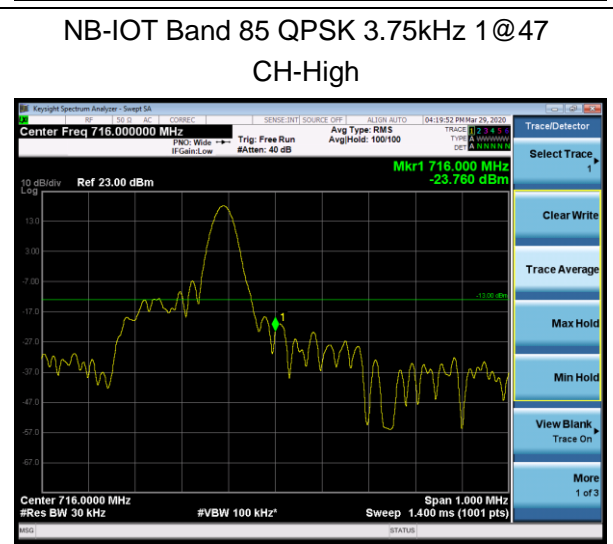
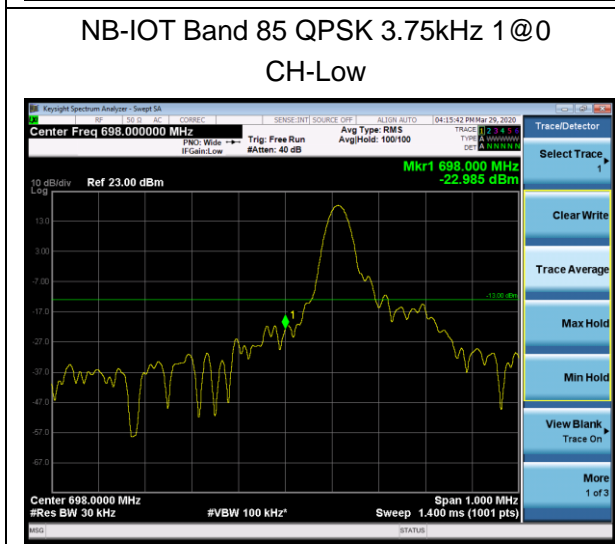
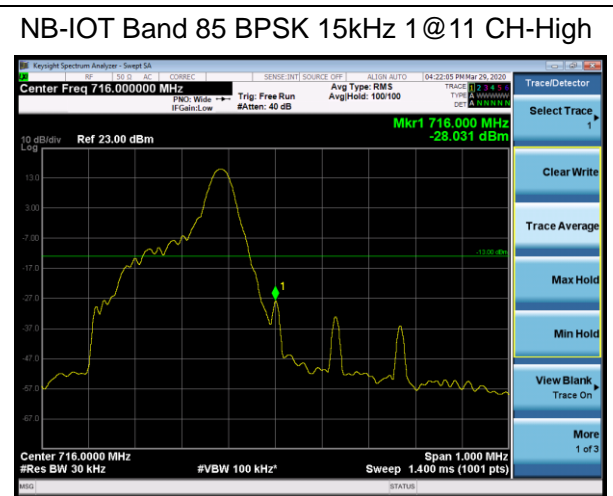
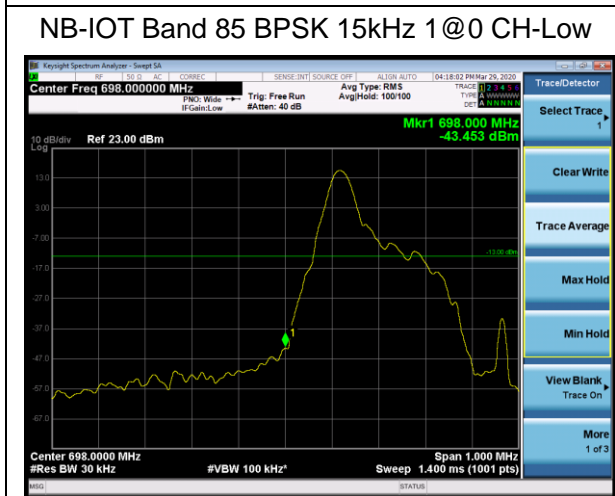
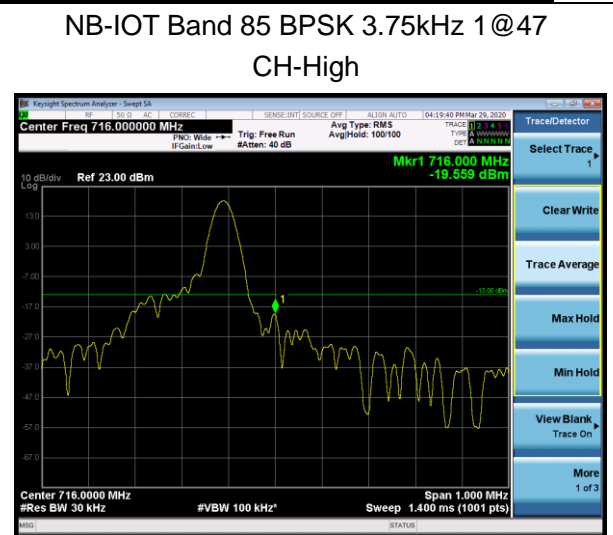
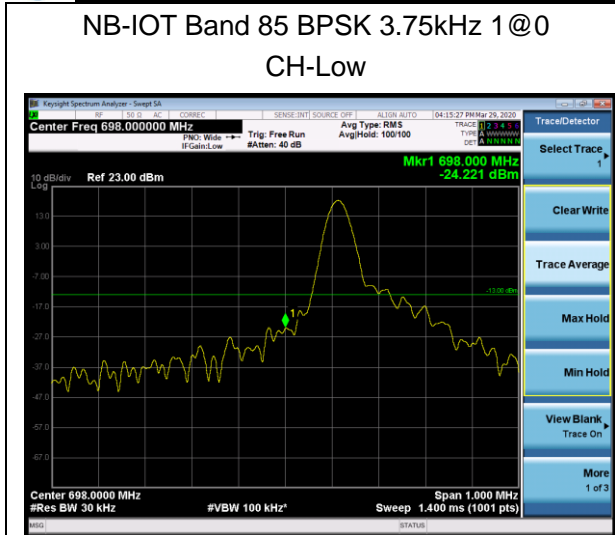

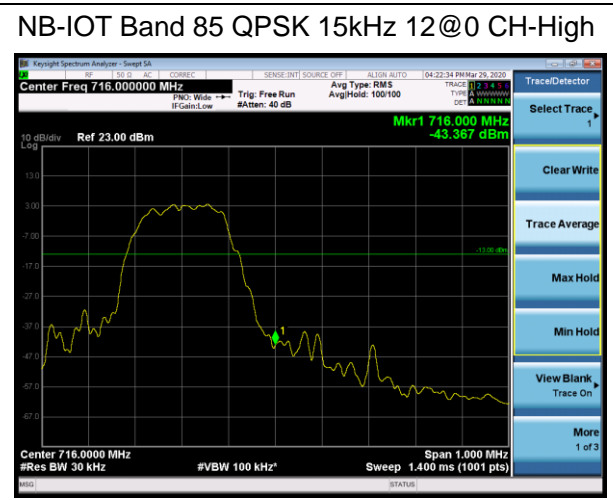
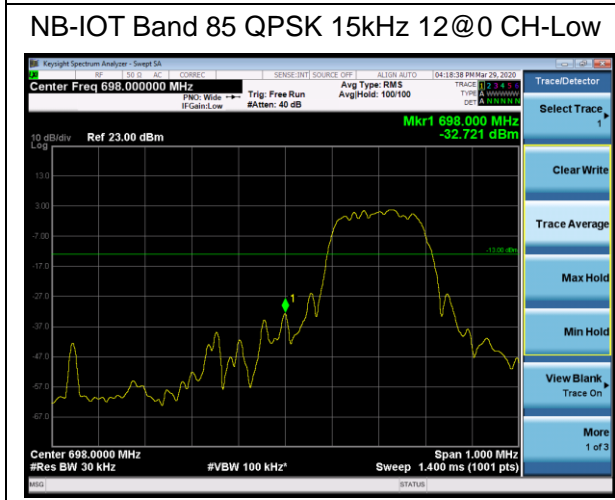
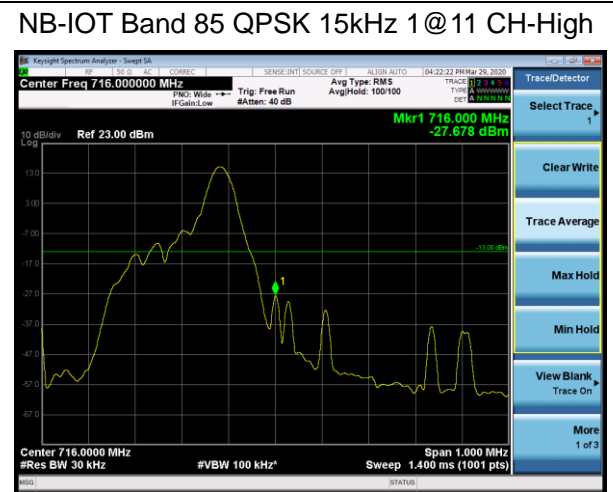
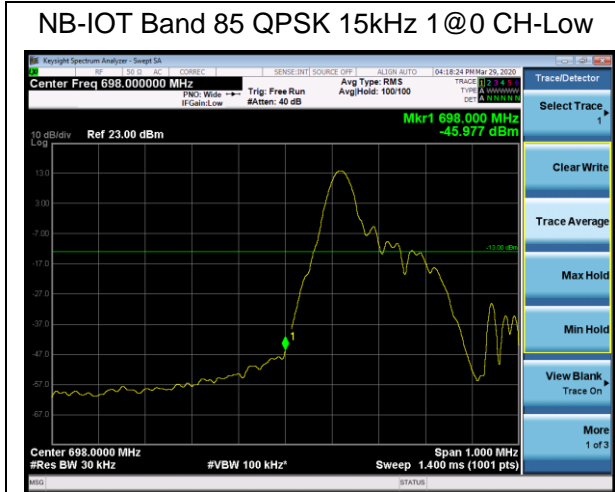

### 5.5 Peak-to-Average Power Ratio (PAPR)

#### Ambient condition

Temperature	Relative humidity	Pressure
23°C ~25°C	45%~50%	101.5kPa

#### Methods of Measurement

Measure the total peak power and record as PPK. And measure the total average power and record as PAvg. Both the peak and average power levels must be expressed in the same logarithmic units (e.g., dBm). Determine the PAPR from:

$$PAPR (dB) = PPK (dBm) - PAvg (dBm).$$

#### Test Setup

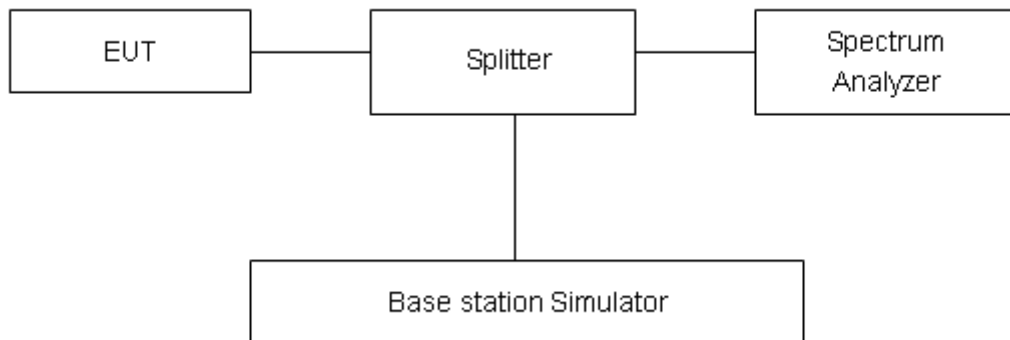

#### Limits

Rule Part 27.50(d)(5) Equipment employed must be authorized in accordance with the provisions of 24.51. Power measurements for transmissions by stations authorized under this section may be made either in accordance with a Commission-approved average power technique or in compliance with paragraph (d)(6) of this section. In measuring transmissions in this band using an average power technique, the peak-to-average ratio (PAR) of the transmission may not exceed 13 dB.

#### Measurement Uncertainty

The assessed measurement uncertainty to ensure 95% confidence level for the normal distribution is with the coverage factor  $k = 2$ ,  $U = 0.4$  dB.



## Test Results

Mode	Modulation	Sub-carrier spacing (KHz)	Channel/Frequency (MHz)	Peak-to-Average Power Ratio (PAPR)			Limit (dB)	Conclusion
				Peak(dBm)	Avg(dBm)	PAPR(dB)		
NB-IOT Band 4 Standalone	BPSK	3.75	20175/1732.5	21.82	18.00	3.82	≤13	PASS
	QPSK	3.75	20175/1732.5	21.38	17.95	3.43	≤13	PASS
	BPSK	15	20175/1732.5	21.59	15.12	6.47	≤13	PASS
	QPSK	15	20175/1732.5	21.53	15.09	6.44	≤13	PASS
Mode	Modulation	Sub-carrier spacing (KHz)	Channel/Frequency (MHz)	Peak-to-Average Power Ratio (PAPR)			Limit (dB)	Conclusion
NB-IOT Band 12 Standalone	BPSK	3.75	23095/707.5	22.12	18.35	3.77	≤13	PASS
	QPSK	3.75	23095/707.5	21.67	18.33	3.34	≤13	PASS
	BPSK	15	23095/707.5	21.98	15.51	6.47	≤13	PASS
	QPSK	15	23095/707.5	21.93	15.55	6.38	≤13	PASS
Mode	Modulation	Sub-carrier spacing (KHz)	Channel/Frequency (MHz)	Peak-to-Average Power Ratio (PAPR)			Limit (dB)	Conclusion
NB-IOT Band 13 Standalone	BPSK	3.75	23230/782	22.29	18.49	3.80	≤13	PASS
	QPSK	3.75	23230/782	21.90	18.50	3.40	≤13	PASS
	BPSK	15	23230/782	22.28	15.92	6.36	≤13	PASS
	QPSK	15	23230/782	22.23	15.86	6.37	≤13	PASS
Mode	Modulation	Sub-carrier spacing (KHz)	Channel/Frequency (MHz)	Peak-to-Average Power Ratio (PAPR)			Limit (dB)	Conclusion
NB-IOT Band 66 Standalone	BPSK	3.75	132322/1745	21.67	17.83	3.84	≤13	PASS
	QPSK	3.75	132322/1745	21.22	17.79	3.43	≤13	PASS
	BPSK	15	132322/1745	21.48	15.03	6.45	≤13	PASS
	QPSK	15	132322/1745	21.42	15.00	6.42	≤13	PASS
Mode	Modulation	Sub-carrier spacing (KHz)	Channel/Frequency (MHz)	Peak-to-Average Power Ratio (PAPR)			Limit (dB)	Conclusion
NB-IOT Band 71 Standalone	BPSK	3.75	133297/680.5	21.89	18.14	3.75	≤13	PASS
	QPSK	3.75	133297/680.5	21.42	18.09	3.33	≤13	PASS
	BPSK	15	133297/680.5	21.85	15.44	6.41	≤13	PASS
	QPSK	15	133297/680.5	21.78	15.47	6.31	≤13	PASS
Mode	Modulation	Sub-carrier spacing (KHz)	Channel/Frequency (MHz)	Peak-to-Average Power Ratio (PAPR)			Limit (dB)	Conclusion
NB-IOT Band 85 Standalone	BPSK	3.75	134092/707	22.22	18.46	3.76	≤13	PASS
	QPSK	3.75	134092/707	21.76	18.44	3.32	≤13	PASS
	BPSK	15	134092/707	22.08	15.66	6.42	≤13	PASS
	QPSK	15	134092/707	22.02	15.66	6.36	≤13	PASS



## 5.6 Frequency Stability

### Ambient condition

Temperature	Relative humidity	Pressure
23°C ~25°C	45%~50%	101.5kPa

### Method of Measurement

#### Frequency Stability (Temperature Variation)

The temperature inside the climate chamber is varied from -40°C to +85°C in 10°C step size.

(1) With all power removed, the temperature was decreased to -10°C and permitted to stabilize for three hours.

(2) Measure the carrier frequency with the test equipment in a “call mode”. These measurements should be made within 1 minute of powering up the mobile station, to prevent significant self warming.

(3) Repeat the above measurements at 10°C increments from -40°C to +85°C. Allow at least 1.5 hours at each temperature, un-powered, before making measurements.

#### Frequency Stability (Voltage Variation)

The frequency stability shall be measured with variation of primary supply voltage as follows:

(1) Vary primary supply voltage from 85 to 115 percent of the nominal value for other than hand carried battery equipment.

(2) For hand carried, battery powered equipment, reduce primary supply voltage to the battery-operating end point which shall be specified by the manufacturer.

This transceiver is specified to operate with an input voltage of between 3.3 V and 4.3V, with a nominal voltage of 3.8V.

### Test setup

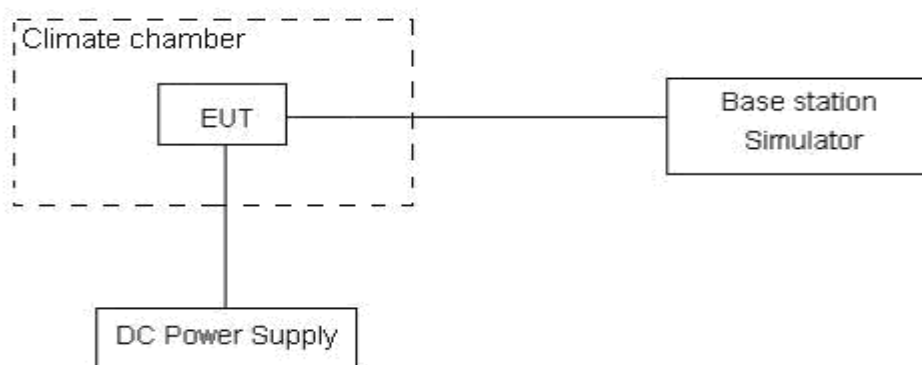

### Limits

The frequency stability shall be sufficient to ensure that the fundamental emissions stay within the authorized bands of operation.

### Measurement Uncertainty

The assessed measurement uncertainty to ensure 99.75% confidence level for the normal distribution is with the coverage factor  $k = 3, U = 0.01\text{ppm}$ .



## Test Result

NB-IOT Band 4						
Condition		Freq.Error (Hz)	Freq.Error (Hz)	Frequency Stability (ppm)	Frequency Stability (ppm)	Verdict
Sub-carrier spacing (KHz)	3.75					
Temperature	Voltage	BPSK	QPSK	BPSK	QPSK	
Normal (25°C)	Normal	7.04	9.72	0.00375	0.00517	PASS
Extreme (85°C)		5.40	14.61	0.00287	0.00777	PASS
Extreme (80°C)		14.89	1.28	0.00792	0.00068	PASS
Extreme (70°C)		4.12	11.84	0.00219	0.00630	PASS
Extreme (60°C)		17.89	17.67	0.00952	0.00940	PASS
Extreme (50°C)		1.92	14.08	0.00102	0.00749	PASS
Extreme (40°C)		3.99	3.16	0.00212	0.00168	PASS
Extreme (30°C)		13.06	1.42	0.00695	0.00075	PASS
Extreme (20°C)		9.41	16.49	0.00501	0.00877	PASS
Extreme (10°C)		9.95	14.93	0.00529	0.00794	PASS
Extreme (0°C)		17.43	5.69	0.00927	0.00303	PASS
Extreme (-10°C)		10.17	11.43	0.00541	0.00608	PASS
Extreme (-20°C)		12.02	11.29	0.00639	0.00600	PASS
Extreme (-30°C)		9.81	16.27	0.00522	0.00865	PASS
Extreme (-40°C)		4.83	9.36	0.00257	0.00498	PASS
25°C	LV	1.81	1.36	0.00097	0.00072	PASS
	HV	9.21	13.07	0.00490	0.00695	PASS
Condition		Freq.Error (Hz)	Freq.Error (Hz)	Frequency Stability (ppm)	Frequency Stability (ppm)	Verdict
Sub-carrier spacing (KHz)	15					
Temperature	Voltage	BPSK	QPSK	BPSK	QPSK	
Normal (25°C)	Normal	2.21	2.23	0.00117	0.00118	PASS
Extreme (85°C)		2.57	15.17	0.00137	0.00807	PASS
Extreme (80°C)		5.64	15.89	0.00300	0.00845	PASS
Extreme (70°C)		14.69	10.05	0.00781	0.00535	PASS
Extreme (60°C)		8.79	12.88	0.00468	0.00685	PASS
Extreme (50°C)		16.29	1.04	0.00867	0.00055	PASS
Extreme (40°C)		14.19	3.85	0.00755	0.00205	PASS
Extreme (30°C)		13.98	17.78	0.00743	0.00946	PASS
Extreme (20°C)		12.56	16.29	0.00668	0.00866	PASS
Extreme (10°C)		15.45	17.62	0.00822	0.00937	PASS
Extreme (0°C)		15.99	4.44	0.00850	0.00236	PASS
Extreme (-10°C)		1.63	6.62	0.00087	0.00352	PASS
Extreme (-20°C)		12.83	6.27	0.00683	0.00334	PASS



Extreme (-30°C)		14.01	14.65	0.00745	0.00779	PASS
Extreme (-40°C)		3.80	10.64	0.00202	0.00566	PASS
25°C	LV	17.50	5.43	0.00931	0.00289	PASS
	HV	7.77	4.24	0.00413	0.00226	PASS

NB-IOT Band 12						
Condition		Freq.Error (Hz)	Freq.Error (Hz)	Frequency Stability (ppm)	Frequency Stability (ppm)	Verdict
Sub-carrier spacing (KHz)	3.75					
Temperature	Voltage	BPSK	QPSK	BPSK	QPSK	
Normal (25°C)	Normal	10.27	9.91	0.00546	0.00527	PASS
Extreme (85°C)		2.68	7.32	0.00143	0.00390	PASS
Extreme (80°C)		9.55	6.56	0.00508	0.00349	PASS
Extreme (70°C)		6.00	6.33	0.00319	0.00337	PASS
Extreme (60°C)		12.31	13.60	0.00655	0.00724	PASS
Extreme (50°C)		12.65	3.00	0.00673	0.00160	PASS
Extreme (40°C)		4.76	6.31	0.00253	0.00336	PASS
Extreme (30°C)		12.31	13.64	0.00655	0.00726	PASS
Extreme (20°C)		9.43	5.46	0.00502	0.00290	PASS
Extreme (10°C)		13.95	13.15	0.00742	0.00699	PASS
Extreme (0°C)		5.03	5.07	0.00267	0.00270	PASS
Extreme (-10°C)		6.49	7.28	0.00345	0.00387	PASS
Extreme (-20°C)		12.74	9.69	0.00678	0.00516	PASS
Extreme (-30°C)		6.35	15.28	0.00338	0.00813	PASS
Extreme (-40°C)		15.94	2.76	0.00848	0.00147	PASS
25°C	LV	14.14	17.23	0.00752	0.00917	PASS
	HV	10.66	9.00	0.00567	0.00479	PASS
Condition		Freq.Error (Hz)	Freq.Error (Hz)	Frequency Stability (ppm)	Frequency Stability (ppm)	Verdict
Sub-carrier spacing (KHz)	15					
Temperature	Voltage	BPSK	QPSK	BPSK	QPSK	
Normal (25°C)	Normal	7.74	14.14	0.00412	0.00752	PASS
Extreme (85°C)		8.18	12.07	0.00435	0.00642	PASS
Extreme (80°C)		11.41	10.24	0.00607	0.00545	PASS
Extreme (70°C)		12.67	6.29	0.00674	0.00334	PASS
Extreme (60°C)		15.37	12.24	0.00817	0.00651	PASS
Extreme (50°C)		16.71	8.15	0.00889	0.00434	PASS
Extreme (40°C)		9.21	9.68	0.00490	0.00515	PASS
Extreme (30°C)		11.43	10.14	0.00608	0.00540	PASS
Extreme (20°C)		4.09	8.16	0.00218	0.00434	PASS



Extreme (10°C)		6.71	9.46	0.00357	0.00503	PASS
Extreme (0°C)		9.65	3.13	0.00513	0.00166	PASS
Extreme (-10°C)		3.42	8.06	0.00182	0.00429	PASS
Extreme (-20°C)		1.17	14.99	0.00062	0.00797	PASS
Extreme (-30°C)		14.68	16.05	0.00781	0.00854	PASS
Extreme (-40°C)		15.54	11.48	0.00827	0.00610	PASS
25°C	LV	10.77	7.54	0.00573	0.00401	PASS
	HV	17.26	11.73	0.00918	0.00624	PASS

NB-IOT Band 13						
Condition		Freq.Error (Hz)	Freq.Error (Hz)	Frequency Stability (ppm)	Frequency Stability (ppm)	Verdict
Sub-carrier spacing (KHz)	3.75					
Temperature	Voltage	BPSK	QPSK	BPSK	QPSK	
Normal (25°C)	Normal	13.29	5.53	0.00707	0.00294	PASS
Extreme (85°C)		5.58	13.11	0.00297	0.00697	PASS
Extreme (80°C)		2.80	12.39	0.00149	0.00659	PASS
Extreme (70°C)		17.39	15.24	0.00925	0.00811	PASS
Extreme (60°C)		11.29	14.43	0.00601	0.00768	PASS
Extreme (50°C)		17.16	7.85	0.00913	0.00418	PASS
Extreme (40°C)		11.50	4.01	0.00612	0.00213	PASS
Extreme (30°C)		12.69	12.14	0.00675	0.00646	PASS
Extreme (20°C)		11.02	13.79	0.00586	0.00733	PASS
Extreme (10°C)		3.17	9.52	0.00169	0.00506	PASS
Extreme (0°C)		17.30	7.50	0.00920	0.00399	PASS
Extreme (-10°C)		9.35	4.93	0.00497	0.00262	PASS
Extreme (-20°C)		5.02	3.06	0.00267	0.00163	PASS
Extreme (-30°C)		16.55	3.87	0.00880	0.00206	PASS
Extreme (-40°C)	11.00	2.61	0.00585	0.00139	PASS	
25°C	LV	8.44	8.38	0.00449	0.00446	PASS
	HV	5.45	7.32	0.00290	0.00389	PASS
Condition		Freq.Error (Hz)	Freq.Error (Hz)	Frequency Stability (ppm)	Frequency Stability (ppm)	Verdict
Sub-carrier spacing (KHz)	15					
Temperature	Voltage	BPSK	QPSK	BPSK	QPSK	
Normal (25°C)	Normal	2.50	13.18	0.00133	0.00701	PASS
Extreme (85°C)		17.53	13.02	0.00933	0.00693	PASS
Extreme (80°C)		16.26	14.89	0.00865	0.00792	PASS
Extreme (70°C)		3.67	12.34	0.00195	0.00657	PASS
Extreme (60°C)		17.21	12.81	0.00916	0.00681	PASS



Extreme (50°C)		14.08	2.82	0.00749	0.00150	PASS
Extreme (40°C)		8.49	3.50	0.00452	0.00186	PASS
Extreme (30°C)		3.25	17.56	0.00173	0.00934	PASS
Extreme (20°C)		9.49	9.16	0.00505	0.00487	PASS
Extreme (10°C)		1.21	5.71	0.00064	0.00304	PASS
Extreme (0°C)		11.48	12.20	0.00611	0.00649	PASS
Extreme (-10°C)		11.37	17.73	0.00605	0.00943	PASS
Extreme (-20°C)		4.06	12.66	0.00216	0.00673	PASS
Extreme (-30°C)		13.66	4.21	0.00727	0.00224	PASS
Extreme (-40°C)		1.34	1.70	0.00071	0.00091	PASS
25°C	LV	16.69	14.23	0.00888	0.00757	PASS
	HV	13.76	14.90	0.00732	0.00793	PASS

NB-IOT Band 66						
Condition		Freq.Error (Hz)	Freq.Error (Hz)	Frequency Stability (ppm)	Frequency Stability (ppm)	Verdict
Sub-carrier spacing (KHz)	3.75					
Temperature	Voltage	BPSK	QPSK	BPSK	QPSK	
Normal (25°C)	Normal	6.50	5.92	0.00346	0.00315	PASS
Extreme (85°C)		1.83	11.04	0.00097	0.00587	PASS
Extreme (80°C)		2.82	12.57	0.00150	0.00668	PASS
Extreme (70°C)		7.34	13.37	0.00391	0.00711	PASS
Extreme (60°C)		17.77	14.00	0.00945	0.00745	PASS
Extreme (50°C)		14.88	4.28	0.00791	0.00227	PASS
Extreme (40°C)		5.67	8.65	0.00302	0.00460	PASS
Extreme (30°C)		5.92	12.87	0.00315	0.00684	PASS
Extreme (20°C)		10.78	15.05	0.00573	0.00801	PASS
Extreme (10°C)		17.23	9.03	0.00916	0.00480	PASS
Extreme (0°C)		10.89	6.94	0.00579	0.00369	PASS
Extreme (-10°C)		13.39	12.40	0.00712	0.00660	PASS
Extreme (-20°C)		14.83	17.08	0.00789	0.00908	PASS
Extreme (-30°C)		15.74	2.03	0.00837	0.00108	PASS
25°C	LV	3.05	14.63	0.00162	0.00778	PASS
	HV	4.87	10.63	0.00259	0.00565	PASS
Condition		Freq.Error (Hz)	Freq.Error (Hz)	Frequency Stability (ppm)	Frequency Stability (ppm)	Verdict
Sub-carrier spacing (KHz)	15					
Temperature	Voltage	BPSK	QPSK	BPSK	QPSK	
Normal (25°C)	Normal	9.21	5.74	0.00490	0.00305	PASS



Extreme (85°C)		14.67	1.97	0.00780	0.00105	PASS
Extreme (80°C)		13.63	4.47	0.00725	0.00238	PASS
Extreme (70°C)		11.46	1.49	0.00610	0.00079	PASS
Extreme (60°C)		6.40	1.05	0.00340	0.00056	PASS
Extreme (50°C)		7.32	1.07	0.00389	0.00057	PASS
Extreme (40°C)		7.83	5.64	0.00417	0.00300	PASS
Extreme (30°C)		4.48	5.29	0.00238	0.00281	PASS
Extreme (20°C)		8.33	2.75	0.00443	0.00146	PASS
Extreme (10°C)		2.34	10.44	0.00124	0.00555	PASS
Extreme (0°C)		6.51	1.10	0.00346	0.00059	PASS
Extreme (-10°C)		15.20	13.13	0.00808	0.00698	PASS
Extreme (-20°C)		17.20	2.53	0.00915	0.00135	PASS
Extreme (-30°C)		14.81	5.70	0.00788	0.00303	PASS
Extreme (-40°C)		8.60	15.33	0.00457	0.00816	PASS
25°C	LV	12.73	10.71	0.00677	0.00570	PASS
	HV	13.96	12.42	0.00743	0.00661	PASS

NB-IOT Band 71						
Condition		Freq.Error (Hz)	Freq.Error (Hz)	Frequency Stability (ppm)	Frequency Stability (ppm)	Verdict
Sub-carrier spacing (KHz)	3.75	BPSK	QPSK	BPSK	QPSK	
Temperature	Voltage	BPSK	QPSK	BPSK	QPSK	
Normal (25°C)	Normal	6.73	2.28	0.00358	0.00121	PASS
Extreme (85°C)		10.16	17.55	0.00540	0.00934	PASS
Extreme (80°C)		16.29	6.86	0.00866	0.00365	PASS
Extreme (70°C)		1.56	15.12	0.00083	0.00804	PASS
Extreme (60°C)		7.37	4.45	0.00392	0.00237	PASS
Extreme (50°C)		9.67	14.03	0.00514	0.00746	PASS
Extreme (40°C)		5.58	9.51	0.00297	0.00506	PASS
Extreme (30°C)		2.57	1.74	0.00137	0.00093	PASS
Extreme (20°C)		1.49	10.30	0.00079	0.00548	PASS
Extreme (10°C)		13.41	12.74	0.00713	0.00677	PASS
Extreme (0°C)		9.06	2.89	0.00482	0.00154	PASS
Extreme (-10°C)		14.66	14.78	0.00780	0.00786	PASS
Extreme (-20°C)		9.79	16.22	0.00521	0.00863	PASS
Extreme (-30°C)		12.22	17.62	0.00650	0.00937	PASS
Extreme (-40°C)		8.93	14.90	0.00475	0.00792	PASS
25°C	LV	17.86	8.98	0.00950	0.00478	PASS
	HV	1.79	13.31	0.00095	0.00708	PASS
Condition		Freq.Error (Hz)	Freq.Error (Hz)	Frequency Stability	Frequency Stability	Verdict



Sub-carrier spacing (KHz)	15			(ppm)	(ppm)	
Temperature	Voltage	BPSK	QPSK	BPSK	QPSK	
Normal (25°C)	Normal	3.57	11.40	0.00190	0.00606	PASS
Extreme (85°C)		1.88	12.71	0.00100	0.00676	PASS
Extreme (80°C)		13.75	16.39	0.00731	0.00872	PASS
Extreme (70°C)		13.84	10.06	0.00736	0.00535	PASS
Extreme (60°C)		3.16	3.86	0.00168	0.00205	PASS
Extreme (50°C)		4.61	7.68	0.00245	0.00409	PASS
Extreme (40°C)		13.04	17.78	0.00694	0.00946	PASS
Extreme (30°C)		8.14	16.63	0.00433	0.00885	PASS
Extreme (20°C)		3.28	5.83	0.00175	0.00310	PASS
Extreme (10°C)		1.10	10.57	0.00058	0.00562	PASS
Extreme (0°C)		11.05	5.92	0.00588	0.00315	PASS
Extreme (-10°C)		16.58	8.80	0.00882	0.00468	PASS
Extreme (-20°C)		2.77	2.12	0.00147	0.00113	PASS
Extreme (-30°C)		14.28	15.52	0.00760	0.00825	PASS
Extreme (-40°C)		5.52	2.62	0.00293	0.00139	PASS
25°C	LV	7.40	1.42	0.00394	0.00076	PASS
	HV	6.92	8.05	0.00368	0.00428	PASS

NB-IOT Band 85						
Condition		Freq.Error (Hz)	Freq.Error (Hz)	Frequency Stability (ppm)	Frequency Stability (ppm)	Verdict
Sub-carrier spacing (KHz)	3.75					
Temperature	Voltage	BPSK	QPSK	BPSK	QPSK	
Normal (25°C)	Normal	11.97	16.48	0.00637	0.00876	PASS
Extreme (85°C)		1.79	3.66	0.00095	0.00195	PASS
Extreme (80°C)		12.10	6.42	0.00644	0.00342	PASS
Extreme (70°C)		11.28	2.87	0.00600	0.00153	PASS
Extreme (60°C)		12.25	7.57	0.00652	0.00402	PASS
Extreme (50°C)		10.35	9.74	0.00550	0.00518	PASS
Extreme (40°C)		15.11	17.84	0.00804	0.00949	PASS
Extreme (30°C)		15.42	3.59	0.00820	0.00191	PASS
Extreme (20°C)		2.45	8.47	0.00130	0.00451	PASS
Extreme (10°C)		7.43	14.54	0.00395	0.00774	PASS
Extreme (0°C)		7.68	14.09	0.00409	0.00750	PASS
Extreme (-10°C)		3.64	6.01	0.00194	0.00320	PASS
Extreme (-20°C)		12.48	4.89	0.00664	0.00260	PASS
Extreme (-30°C)		10.01	12.87	0.00532	0.00684	PASS
Extreme (-40°C)		6.72	13.37	0.00357	0.00711	PASS





25°C	LV	4.57	2.11	0.00243	0.00112	PASS
	HV	9.02	3.10	0.00480	0.00165	PASS
Condition		Freq.Error (Hz)	Freq.Error (Hz)	Frequency Stability (ppm)	Frequency Stability (ppm)	Verdict
Sub-carrier spacing (KHz)	15					
Temperature	Voltage	BPSK	QPSK	BPSK	QPSK	
Normal (25°C)	Normal	7.10	12.23	0.00378	0.00650	
Extreme (85°C)		7.96	6.53	0.00424	0.00347	PASS
Extreme (80°C)		4.46	8.21	0.00237	0.00437	PASS
Extreme (70°C)		12.43	2.17	0.00661	0.00115	PASS
Extreme (60°C)		2.15	17.19	0.00114	0.00914	PASS
Extreme (50°C)		1.59	1.05	0.00084	0.00056	PASS
Extreme (40°C)		7.37	1.24	0.00392	0.00066	PASS
Extreme (30°C)		8.53	16.49	0.00454	0.00877	PASS
Extreme (20°C)		16.93	6.52	0.00901	0.00347	PASS
Extreme (10°C)		16.95	8.74	0.00901	0.00465	PASS
Extreme (0°C)		10.58	1.18	0.00563	0.00063	PASS
Extreme (-10°C)		8.55	8.03	0.00455	0.00427	PASS
Extreme (-20°C)		7.95	6.14	0.00423	0.00327	PASS
Extreme (-30°C)		5.83	17.76	0.00310	0.00945	PASS
Extreme (-40°C)	12.60	14.44	0.00670	0.00768	PASS	
25°C	LV	14.80	6.83	0.00787	0.00364	PASS
	HV	11.89	5.35	0.00633	0.00285	PASS



## 5.7 Spurious Emissions at Antenna Terminals

### Ambient condition

Temperature	Relative humidity	Pressure
23°C ~25°C	45%~50%	101.5kPa

### Method of Measurement

The EUT was connected to Spectrum Analyzer and Base Station Simulator via power Splitter. The measurement is carried out using a spectrum analyzer. The spectrum analyzer scans from 9kHz to the 10th harmonic of the carrier. The peak detector is used.

RBW is set to 100kHz, VBW is set to 300kHz for 30MHz~1GHz

RBW is set to 1MHz, VBW is set to 3MHz for above 1GHz, Sweep is set to ATUO.

Of those disturbances below (limit – 20 dB), the mark is not required for the EUT.

The modulation mode and RB allocation refer to section 5.1, using the maximum output power configuration.

### Test setup

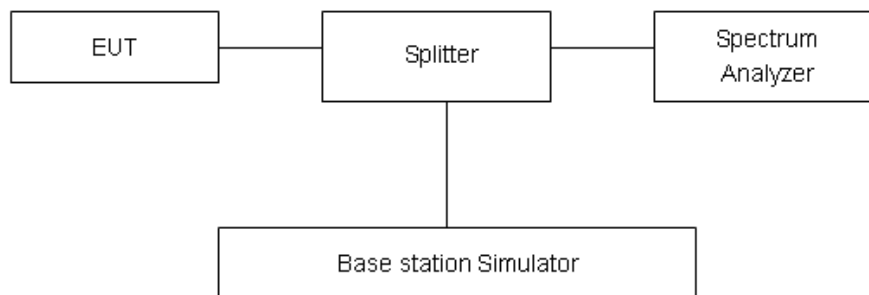

### Limits

Rule Part 27.53(h) specifies that “for operations in the 1695-1710 MHz, 1710-1755 MHz, 1755-1780 MHz, 1915-1920 MHz, 1995-2000 MHz, 2000-2020 MHz, 2110-2155 MHz, 2155-2180 MHz, and 2180-2200 bands, the power of any emission outside a licensee's frequency block shall be attenuated below the transmitter power (P) in watts by at least  $43 + 10 \log_{10}(P)$  dB..”

Rule Part 27.53 (g) For operations in the 600 MHz band and the 698-746 MHz band, the power of any emission outside a licensee's frequency band(s) of operation shall be attenuated below the transmitter power (P) within the licensed band(s) of operation, measured in watts, by at least  $43 + 10 \log(P)$  dB. Compliance with this provision is based on the use of measurement instrumentation employing a resolution bandwidth of 100 kilohertz or greater. However, in the 100 kilohertz bands immediately outside and adjacent to a licensee's frequency block, a resolution bandwidth of at least 30 kHz may be employed.

Rule Part 27.53(f) For operations in the 746-758 MHz, 775-788 MHz, and 805-806 MHz bands, emissions in the band 1559-1610 MHz shall be limited to  $-70$  dBW/MHz equivalent isotropically



radiated power (EIRP) for wideband signals, and  $-80$  dBW EIRP for discrete emissions of less than 700 Hz bandwidth. For the purpose of equipment authorization, a transmitter shall be tested with an antenna that is representative of the type that will be used with the equipment in normal operation.

Part 27.53 (c) For operations in the 746-758 MHz band and the 776-788 MHz band, the power of any emission outside the licensee's frequency band(s) of operation shall be attenuated below the transmitter power (P) within the licensed band(s) of operation, measured in watts, in accordance with the following:

- (1) On any frequency outside the 746-758 MHz band, the power of any emission shall be attenuated outside the band below the transmitter power (P) by at least  $43 + 10 \log (P)$  dB;
- (2) On any frequency outside the 776-788 MHz band, the power of any emission shall be attenuated outside the band below the transmitter power (P) by at least  $43 + 10 \log (P)$  dB;
- (3) On all frequencies between 763-775 MHz and 793-805 MHz, by a factor not less than  $76 + 10 \log (P)$  dB in a 6.25 kHz band segment, for base and fixed stations;
- (4) On all frequencies between 763-775 MHz and 793-805 MHz, by a factor not less than  $65 + 10 \log (P)$  dB in a 6.25 kHz band segment, for mobile and portable stations;
- (5) Compliance with the provisions of paragraphs (c)(1) and (c)(2) of this section is based on the use of measurement instrumentation employing a resolution bandwidth of 100 kHz or greater. However, in the 100 kHz bands immediately outside and adjacent to the frequency block, a resolution bandwidth of at least 30 kHz may be employed;

Part 27.53 (h)/(g) Limit		-13 dBm
Part 27.53(f) Limit	Limit out of the band 1559-1610 MHz	-13 dBm
	Limit in the band 1559-1610 MHz	-40 dBm

### Measurement Uncertainty

The assessed measurement uncertainty to ensure 99.75% confidence level for the normal distribution is with the coverage factor  $k = 1.96$ .

Frequency	Uncertainty
30MHz-1GHz	0.684 dB
1GHz-27GHz	1.407 dB



### Test Result

Sweep the whole frequency band through the range from 9kHz to the 10th harmonic of the carrier, the emissions more than 20 dB below the limit are not reported.

The signal beyond the limit is carrier.

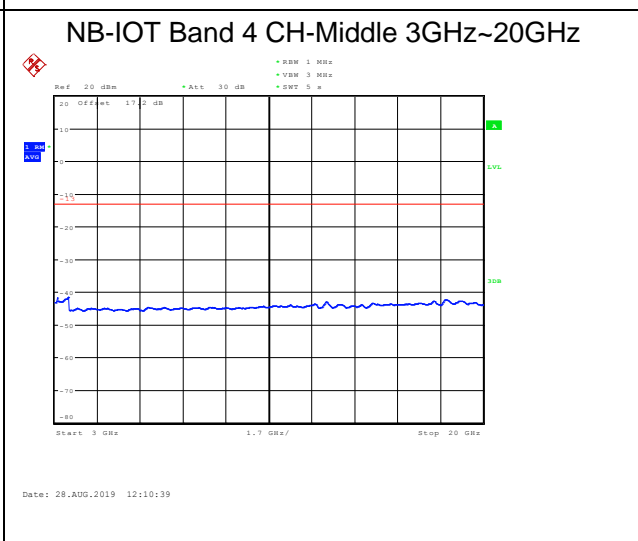
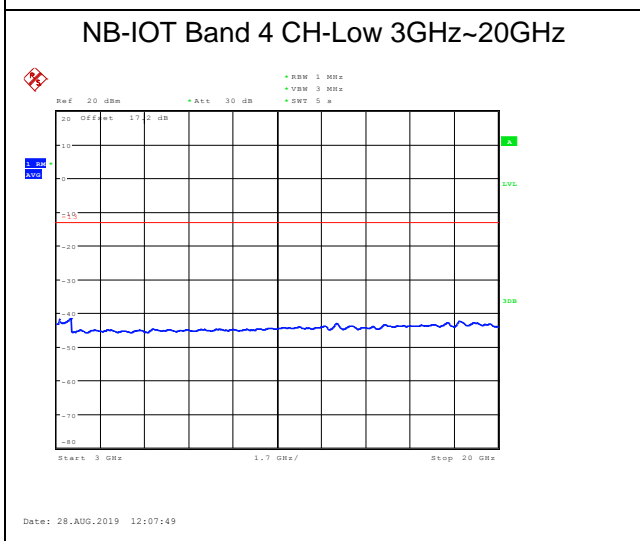
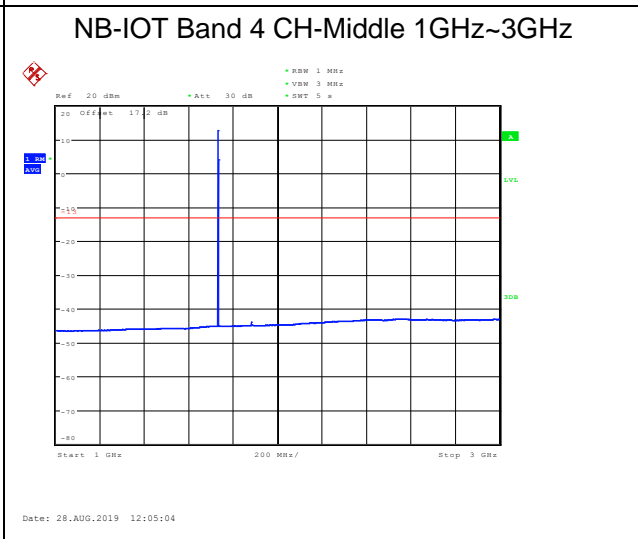
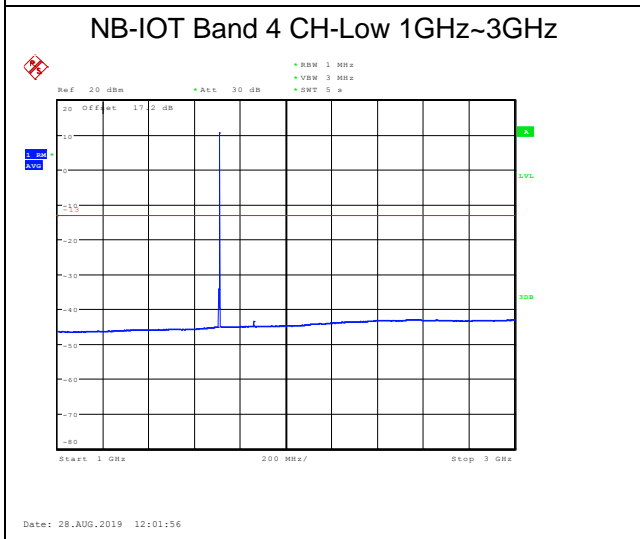
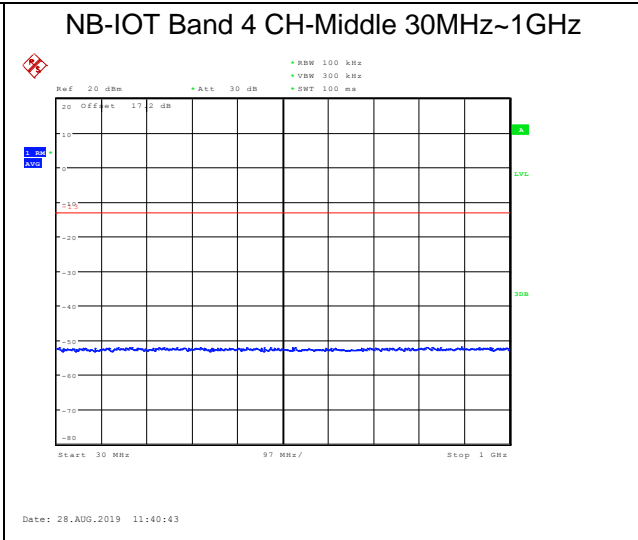
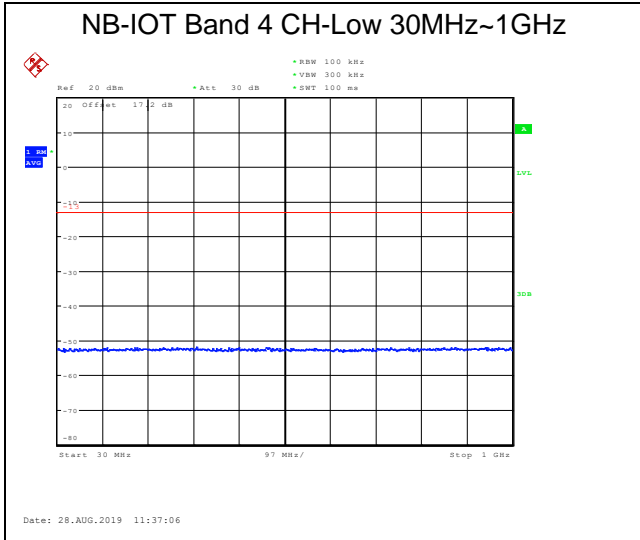

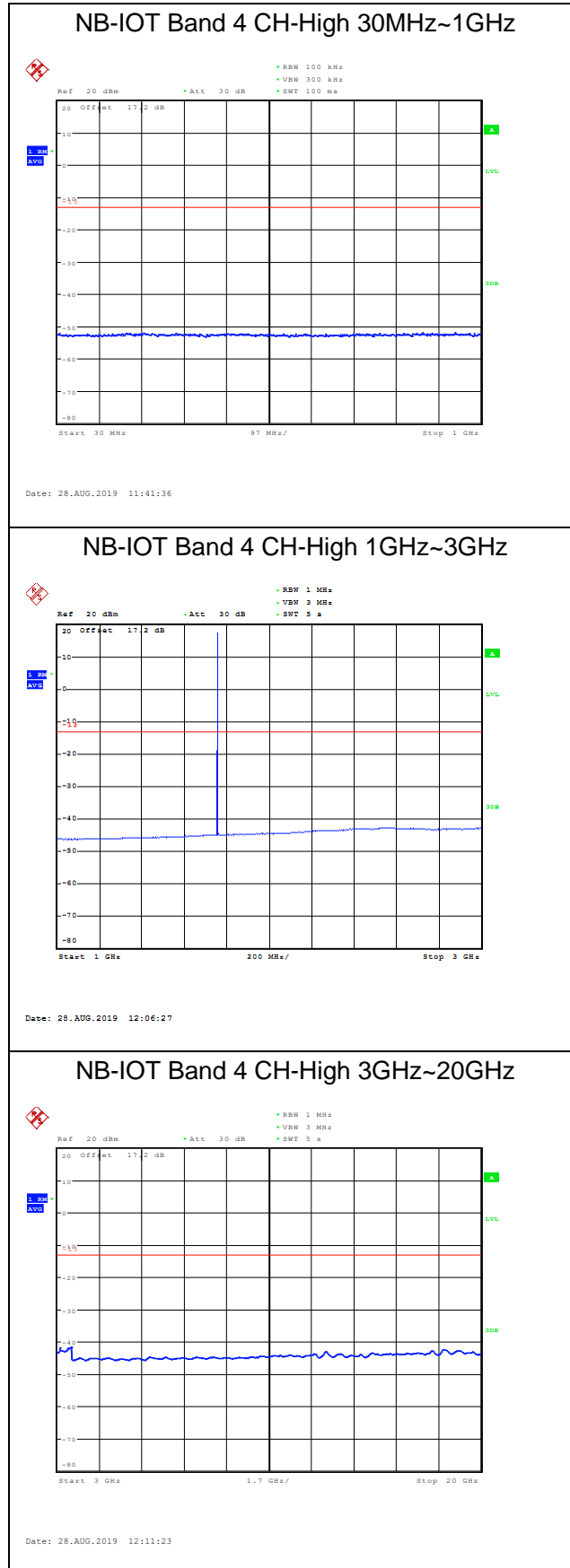



### NB-IOT Band 12 CH-Low 30MHz-1GHz

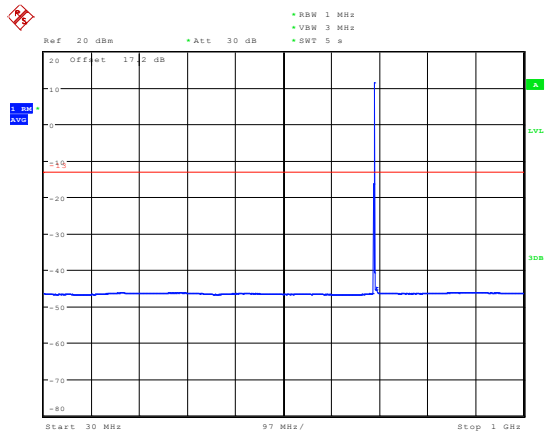

Date: 28.AUG.2019 12:35:00

### NB-IOT Band 12 CH-Low 1GHz-9GHz

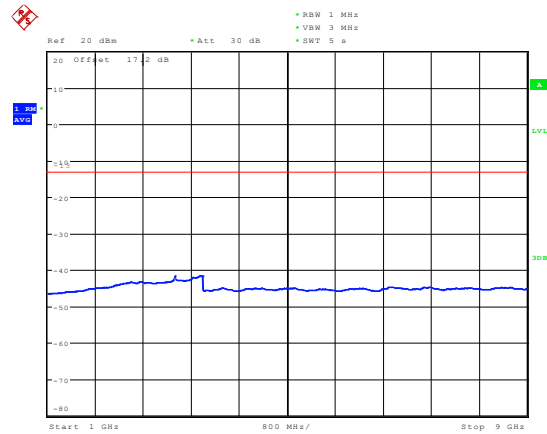

Date: 28.AUG.2019 12:45:03

### NB-IOT Band 12 CH-Middle 30MHz-1GHz

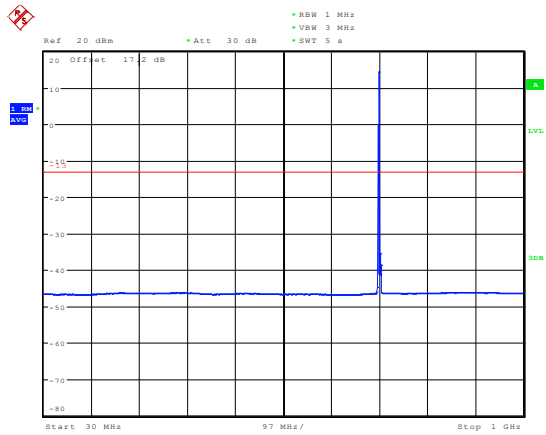

Date: 28.AUG.2019 12:38:10

### NB-IOT Band 12 CH-Middle 1GHz-9GHz

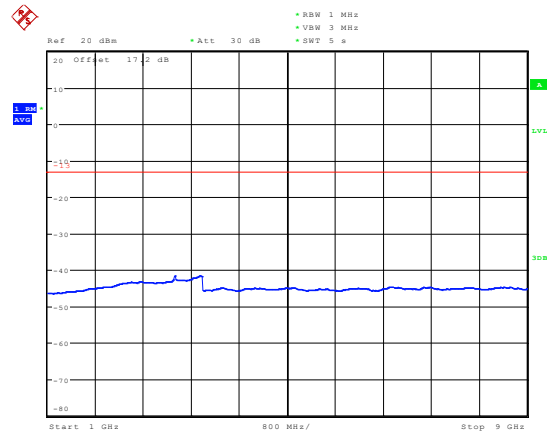

Date: 28.AUG.2019 12:49:06

### NB-IOT Band 12 CH-High 30MHz-1GHz

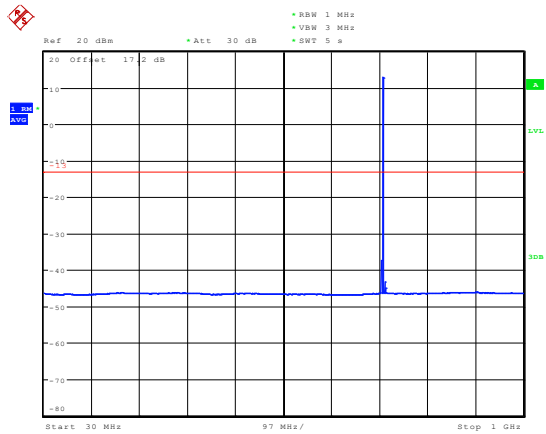

Date: 28.AUG.2019 12:40:33

### NB-IOT Band 12 CH-High 1GHz-9GHz

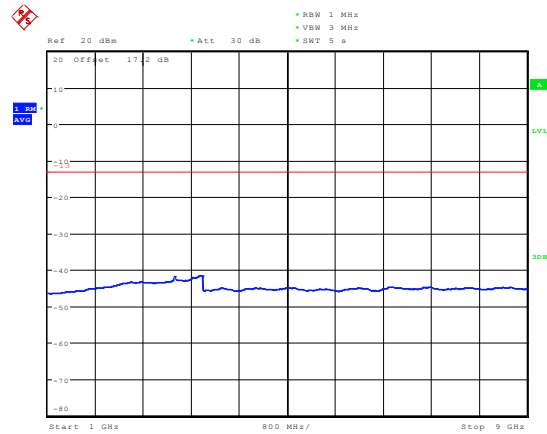

Date: 28.AUG.2019 12:50:48



### NB-IOT Band 13 CH-Low 30MHz-1GHz

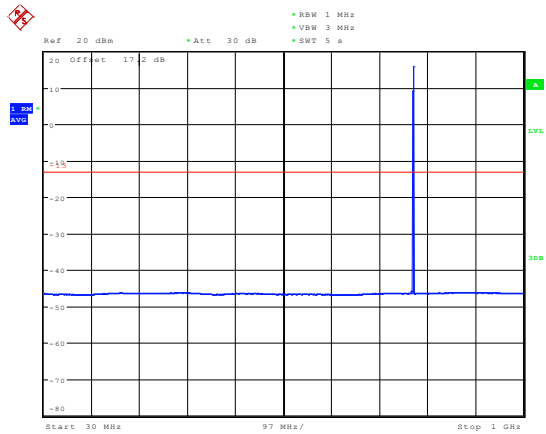

Date: 28.AUG.2019 12:57:04

### NB-IOT Band 13 CH-Low 1GHz-9GHz

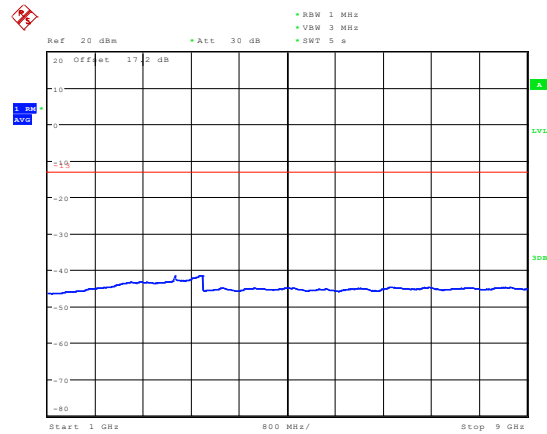

Date: 28.AUG.2019 13:11:41

### NB-IOT Band 13 CH-Middle 30MHz-1GHz

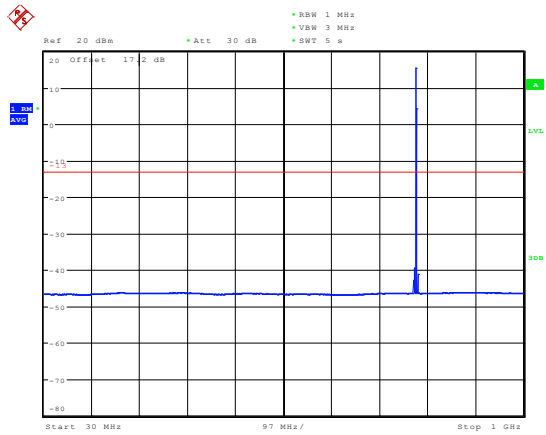

Date: 28.AUG.2019 13:02:59

### NB-IOT Band 13 CH-Middle 1GHz-9GHz

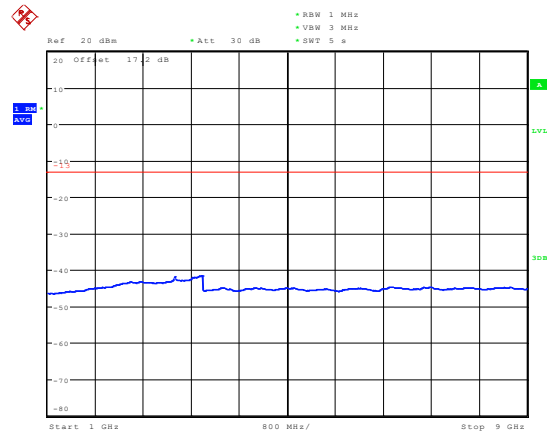

Date: 28.AUG.2019 13:15:47

### NB-IOT Band 13 CH-High 30MHz-1GHz

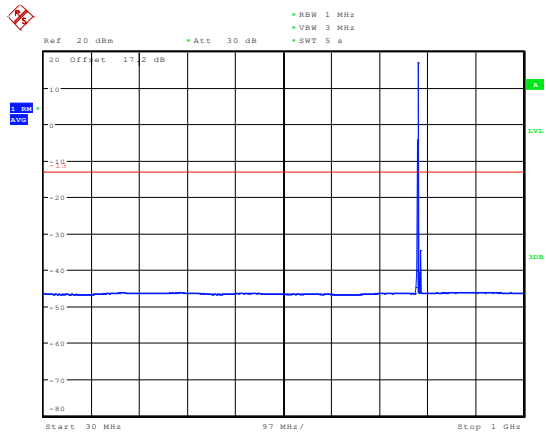

Date: 28.AUG.2019 13:04:21

### NB-IOT Band 13 CH-High 1GHz-9GHz

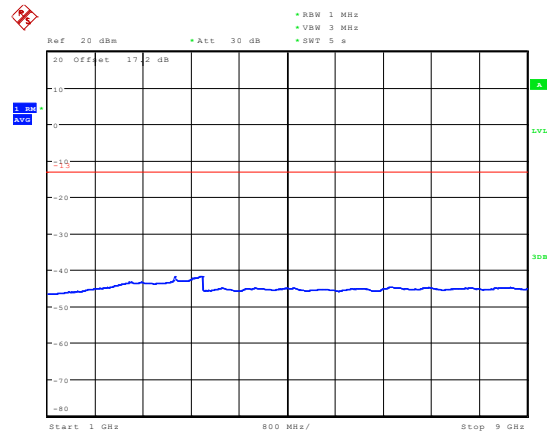

Date: 29.AUG.2019 10:57:02

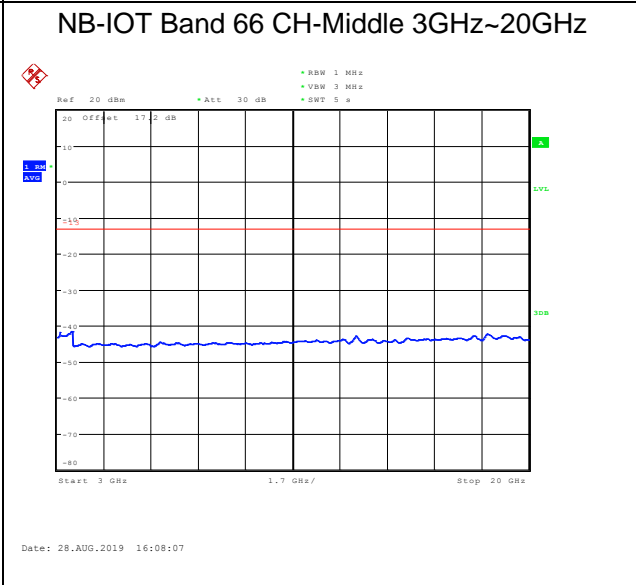
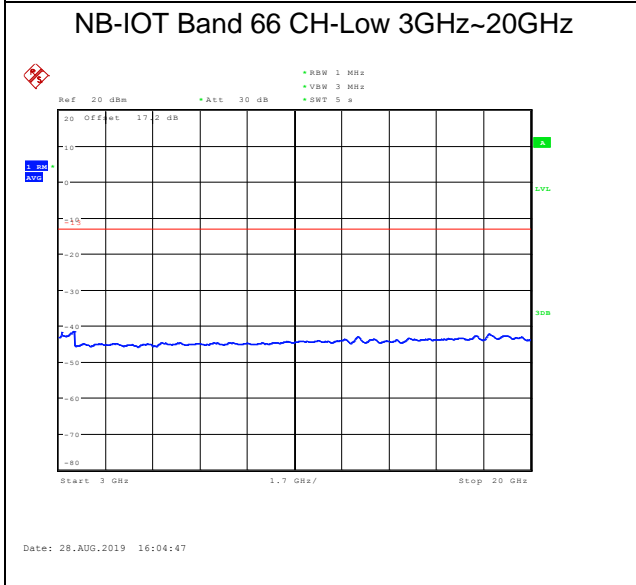
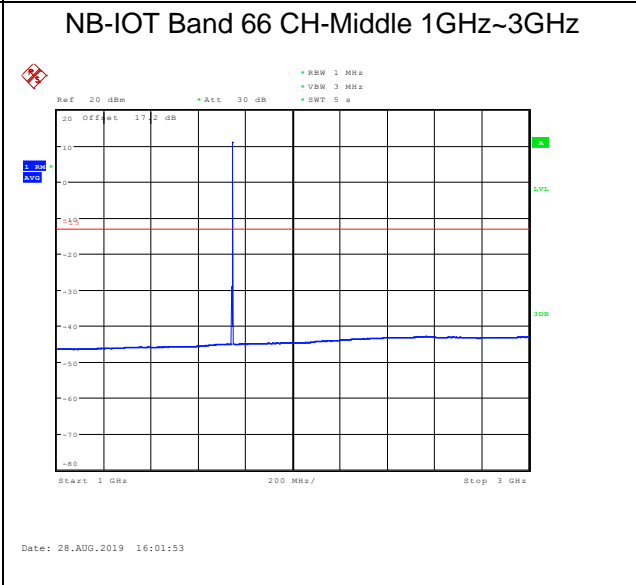
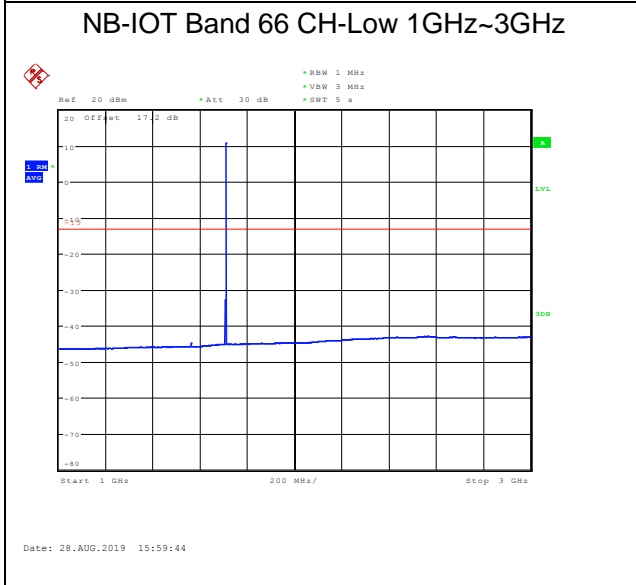
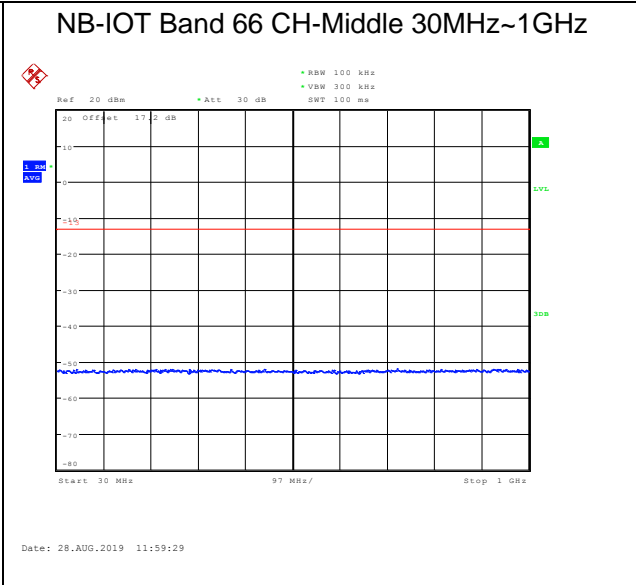
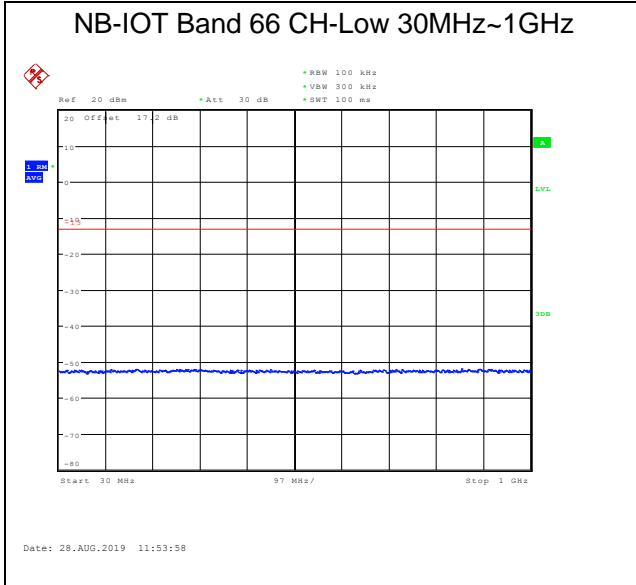

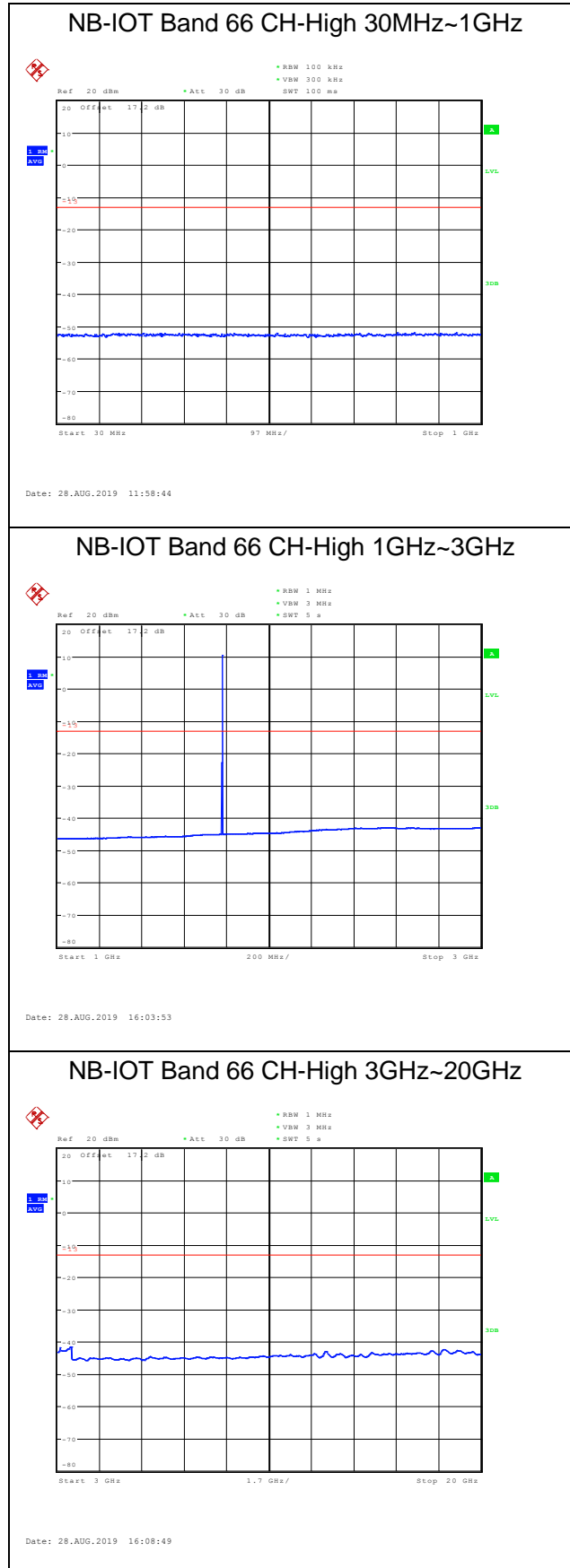





### NB-IOT Band 71 CH-Low 30MHz-1GHz

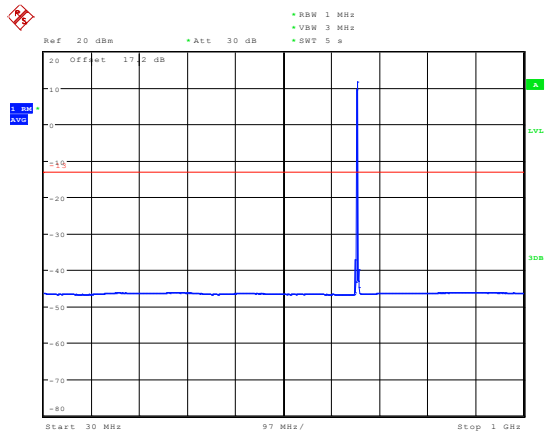

Date: 28.AUG.2019 16:12:57

### NB-IOT Band 71 CH-Low 1GHz-9GHz

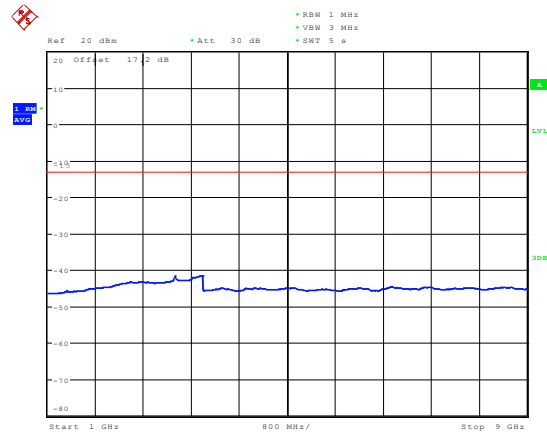

Date: 28.AUG.2019 16:17:20

### NB-IOT Band 71 CH-Middle 30MHz-1GHz

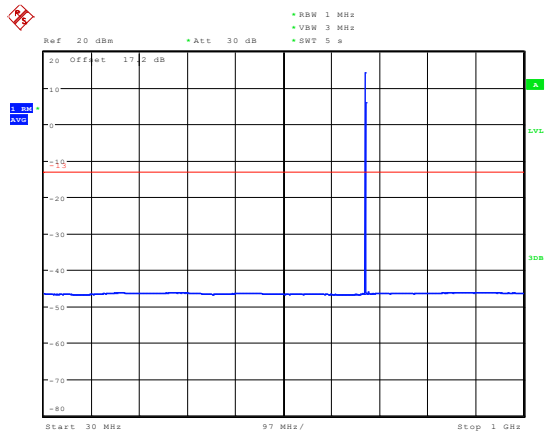

Date: 28.AUG.2019 16:14:45

### NB-IOT Band 71 CH-Middle 1GHz-9GHz

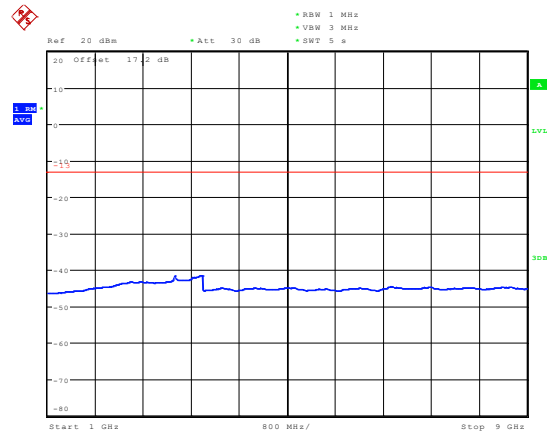

Date: 28.AUG.2019 16:18:50

### NB-IOT Band 71 CH-High 30MHz-1GHz

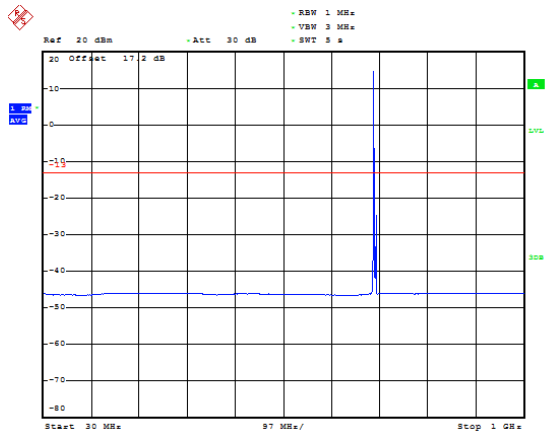

Date: 28.AUG.2019 16:19:50

### NB-IOT Band 71 CH-High 1GHz-9GHz

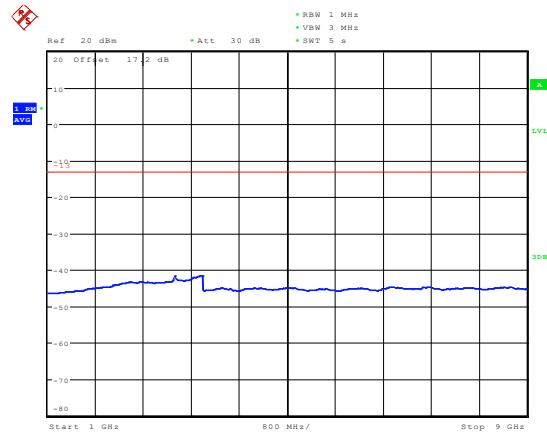

Date: 28.AUG.2019 16:20:00



### NB-IOT Band 85 CH-Low 30MHz-1GHz

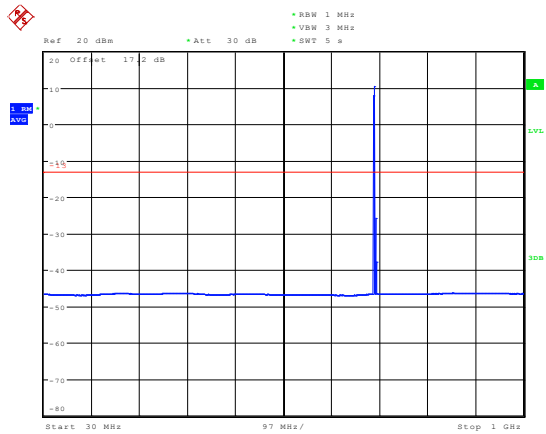

Date: 29.AUG.2019 11:00:34

### NB-IOT Band 85 CH-Low 1GHz-9GHz

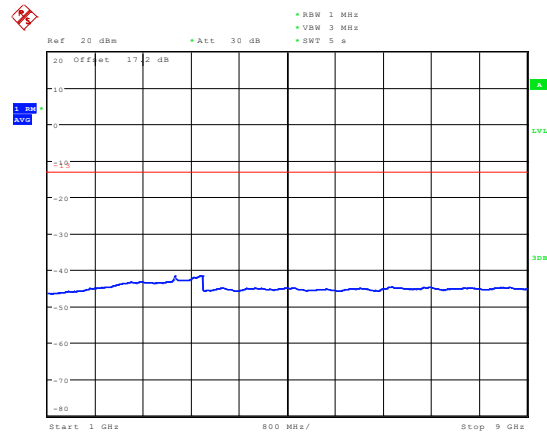

Date: 28.AUG.2019 17:01:58

### NB-IOT Band 85 CH-Middle 30MHz-1GHz

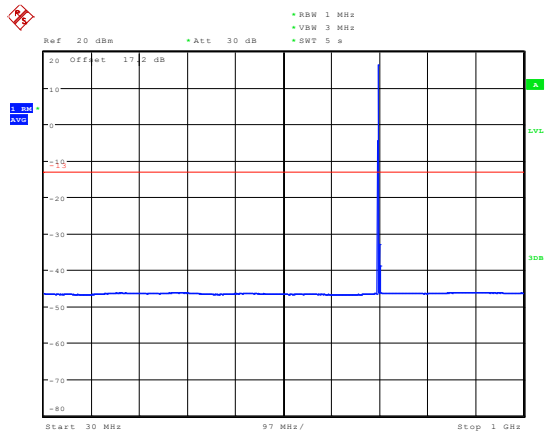

Date: 28.AUG.2019 16:57:53

### NB-IOT Band 85 CH-Middle 1GHz-9GHz

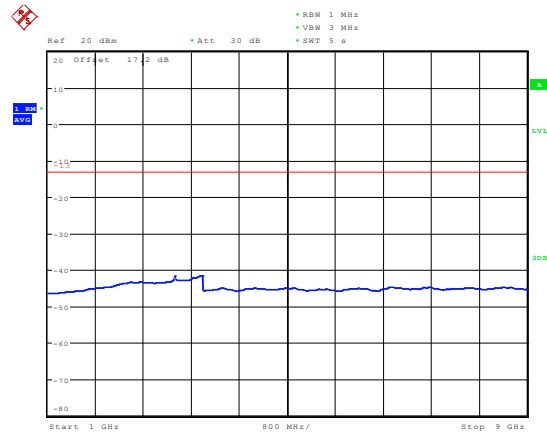

Date: 28.AUG.2019 17:06:19

### NB-IOT Band 85 CH-High 30MHz-1GHz

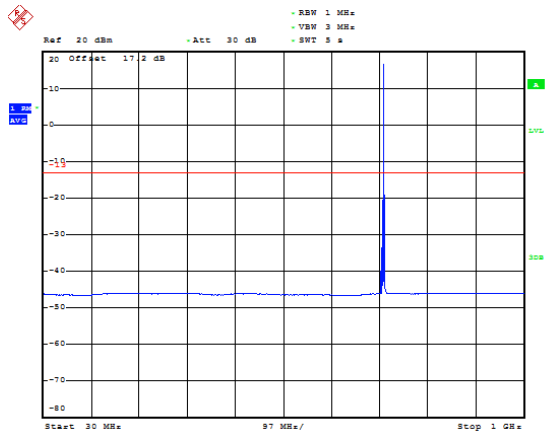

Date: 28.AUG.2019 16:58:58

### NB-IOT Band 85 CH-High 1GHz-9GHz

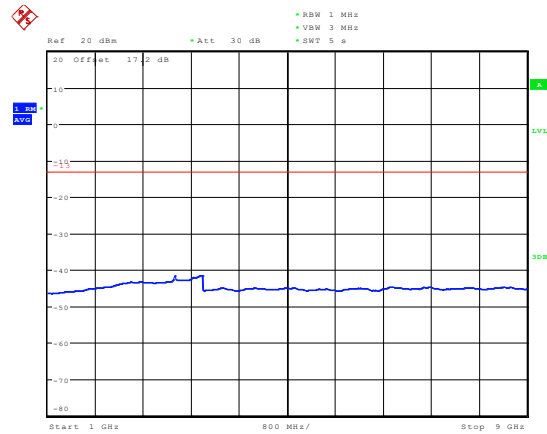

Date: 28.AUG.2019 17:06:28

## 5.8 Radiates Spurious Emission

### Ambient condition

Temperature	Relative humidity	Pressure
23°C ~25°C	45%~50%	101.5kPa

### Method of Measurement

- The testing follows FCC KDB 971168 D01 v03r01 Section 5.8 and ANSI C63.26 (2015).
- Below 1GHz: The EUT is placed on a turntable 0.8 meters above the ground in the chamber, 3 meter away from the antenna. The maximal emission value is acquired by adjusting the antenna height, polarisation and turntable azimuth. Normally, the height range of antenna is 1 m to 4 m, the azimuth range of turntable is 0° to 360°, and the receive antenna has two polarizations Vertical (V) and Horizontal (H). Above 1GHz: (Note: the FCC's permission to use 1.5m as an alternative per TCBC Conf call of Dec. 2, 2014.) The EUT is placed on a turntable 1.5 meters above the ground in the chamber, 3 meter away from the antenna. The maximal emission value is acquired by adjusting the antenna height, polarisation and turntable azimuth. Normally, the height range of antenna is 1 m to 4 m, the azimuth range of turntable is 0° to 360°, and the receive antenna has two polarizations Vertical (V) and Horizontal (H).
- A loop antenna, A log-periodic antenna or horn antenna shall be substituted in place of the EUT. The log-periodic antenna will be driven by a signal generator and the level will be adjusted till the same power value on the spectrum analyzer or receiver. The level of the spurious emissions can be calculated through the level of the signal generator, cable loss, the gain of the substitution antenna and the reading of the spectrum analyzer or receiver.
- The EUT is then put into continuously transmitting mode at its maximum power level during the test. Set Test Receiver or Spectrum RBW=200Hz,VBW=600Hz for 9kHz150kHz , RBW=10kHz, VBW=30kHz 150kHz-30MHz ,RBW=100kHz,VBW=300kHz for 30MHz to 1GHz and RBW=1MHz, VBW=3MHz for above 1GHz And the maximum value of the receiver should be recorded as (Pr).
- The EUT shall be replaced by a substitution antenna. In the chamber, an substitution antenna for the frequency band of interest is placed at the reference point of the chamber. An RF Signal source for the frequency band of interest is connected to the substitution antenna with a cable that has been constructed to not interfere with the radiation pattern of the antenna. A power (PMea) is applied to the input of the substitution antenna, and adjust the level of the signal generator output until the value of the receiver reach the previously recorded (Pr). The power of signal source (PMea) is recorded. The test should be performed by rotating the test item and adjusting the receiving antenna polarization.
- A amplifier should be connected to the Signal Source output port. And the cable should be connect between the Amplifier and the Substitution Antenna. The cable loss (Pcl) ,the Substitution Antenna Gain (Ga) and the Amplifier Gain (PAG) should be recorded after test.
- The measurement results are obtained as described below:  
 $Power(EIRP)=PMea- PAG - Pcl + Ga$   
 The measurement results are amend as described below:  
 $Power(EIRP)=PMea- Pcl + Ga$
- This value is EIRP since the measurement is calibrated using an antenna of known gain (2.15 dBi) and known input power. ERP can be calculated from EIRP by subtracting the gain of the dipole, ERP

= EIRP-2.15dBi.

The modulation mode and RB allocation refer to section 5.1, using the maximum output power configuration.

**Test setup**

**9KHz ~ 30MHz**

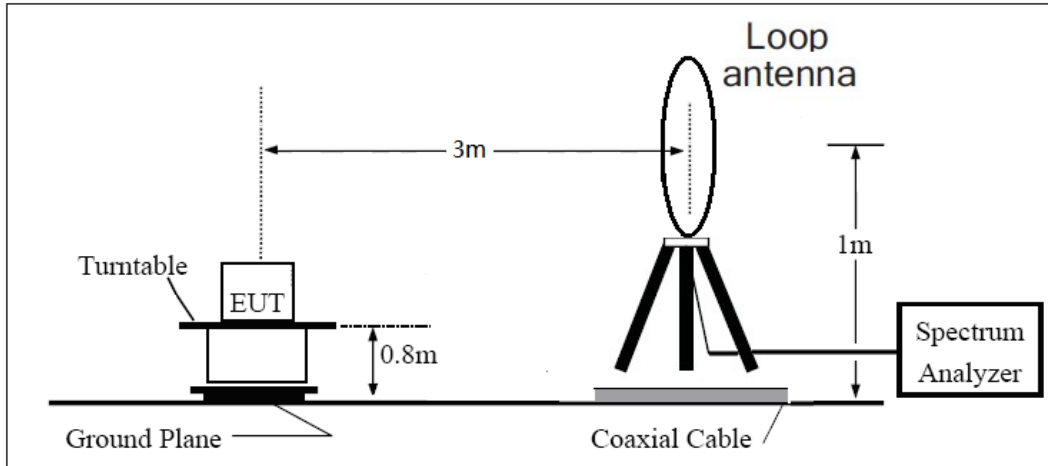

**30MHz ~ 1GHz**

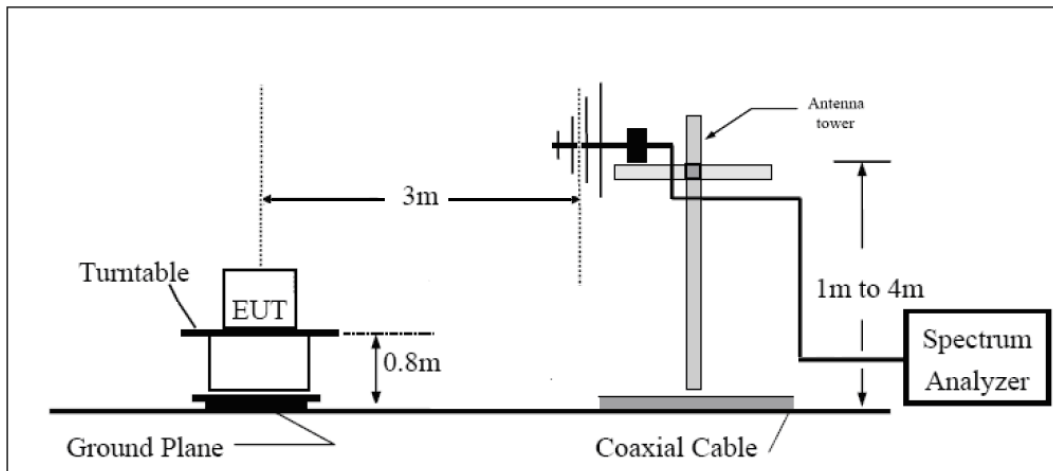

**Above 1GHz**

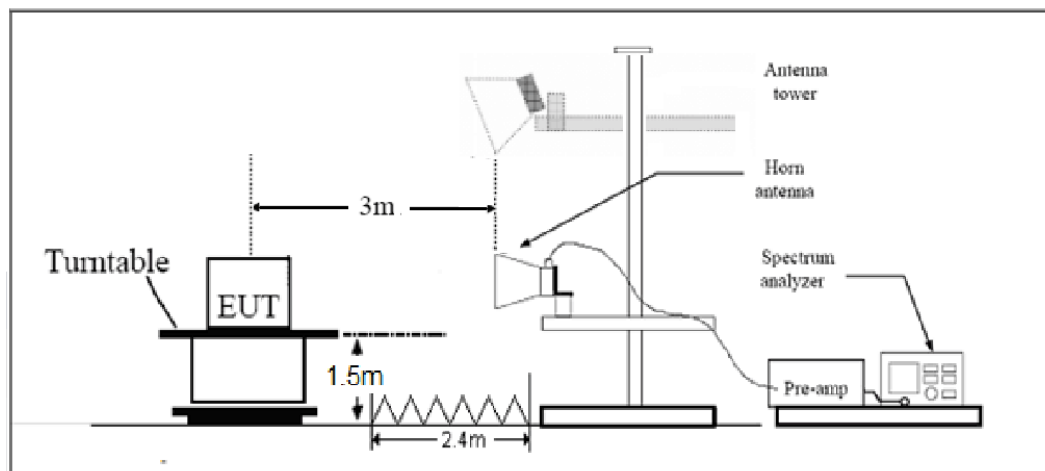

Note: Area side:2.4mX3.6m

**Limits**

Rule Part 27.53(h) specifies that “for operations in the 1695-1710 MHz, 1710-1755 MHz, 1755-1780 MHz, 1915-1920 MHz, 1995-2000 MHz, 2000-2020 MHz, 2110-2155 MHz, 2155-2180 MHz, and 2180-2200 bands, the power of any emission outside a licensee's frequency block shall be attenuated below the transmitter power (P) in watts by at least  $43 + 10 \log_{10}(P)$  dB.”

Rule Part 27.53 (g) For operations in the 600 MHz band and the 698-746 MHz band, the power of any emission outside a licensee's frequency band(s) of operation shall be attenuated below the transmitter power (P) within the licensed band(s) of operation, measured in watts, by at least  $43 + 10 \log(P)$  dB. Compliance with this provision is based on the use of measurement instrumentation employing a resolution bandwidth of 100 kilohertz or greater. However, in the 100 kilohertz bands immediately outside and adjacent to a licensee's frequency block, a resolution bandwidth of at least 30 kHz may be employed.

Rule Part 27.53(f) For operations in the 746-758 MHz, 775-788 MHz, and 805-806 MHz bands, emissions in the band 1559-1610 MHz shall be limited to  $-70$  dBW/MHz equivalent isotropically radiated power (EIRP) for wideband signals, and  $-80$  dBW EIRP for discrete emissions of less than 700 Hz bandwidth. For the purpose of equipment authorization, a transmitter shall be tested with an antenna that is representative of the type that will be used with the equipment in normal operation.

Rule Part 27.53 (c) For operations in the 746-758 MHz band and the 776-788 MHz band, the power of any emission outside the licensee's frequency band(s) of operation shall be attenuated below the transmitter power (P) within the licensed band(s) of operation, measured in watts, in accordance with the following:

- (1) On any frequency outside the 746-758 MHz band, the power of any emission shall be attenuated outside the band below the transmitter power (P) by at least  $43 + 10 \log(P)$  dB;
- (2) On any frequency outside the 776-788 MHz band, the power of any emission shall be attenuated outside the band below the transmitter power (P) by at least  $43 + 10 \log(P)$  dB;
- (3) On all frequencies between 763-775 MHz and 793-805 MHz, by a factor not less than  $76 + 10 \log(P)$  dB in a 6.25 kHz band segment, for base and fixed stations;
- (4) On all frequencies between 763-775 MHz and 793-805 MHz, by a factor not less than  $65 + 10 \log(P)$  dB in a 6.25 kHz band segment, for mobile and portable stations;
- (5) Compliance with the provisions of paragraphs (c)(1) and (c)(2) of this section is based on the use of measurement instrumentation employing a resolution bandwidth of 100 kHz or greater. However, in the 100 kHz bands immediately outside and adjacent to the frequency block, a resolution bandwidth of at least 30 kHz may be employed;

Part 27.53(a)/(h)/(g) Limit		-13 dBm
Part 27.53(f) Limit	Limit out of the band 1559-1610 MHz	-13 dBm
	Limit in the band 1559-1610 MHz	-40 dBm

**Measurement Uncertainty**



The assessed measurement uncertainty to ensure 95% confidence level for the normal distribution is with the coverage factor  $k = \pm 1.96$ ,  $U = \pm 3.55$  dB.

**Test Result**

Sweep the whole frequency band through the range from 9kHz to the 10th harmonic of the carrier, the emissions below the noise floor will not be recorded in the report.

## NB-IOT Band 4 CH-Low

Harmonic	Frequency (MHz)	SG (dBm)	Cable Loss (dB)	Gain (dBi)	Antenna Polarization	EIRP Level (dBm)	Limit (dBm)	Margin (dB)	Azimuth (deg)
2	3420	-65.08	2.6	10.15	Horizontal	-57.53	-13.00	44.53	135
3	5130	-63.53	2.4	11.35	Horizontal	-54.58	-13.00	41.58	180
4	6840	-59.40	4.5	10.85	Horizontal	-53.05	-13.00	40.05	315
5	8550	-57.11	5.1	11.35	Horizontal	-50.86	-13.00	37.86	135
6	10260	-54.23	5.3	11.95	Horizontal	-47.58	-13.00	34.58	225
7	11970	-54.17	5.5	13.55	Horizontal	-46.12	-13.00	33.12	90
8	13680	-51.84	6.3	13.75	Horizontal	-44.39	-13.00	31.39	135
9	15390	-53.29	6.7	13.85	Horizontal	-46.14	-13.00	33.14	45
10	17100	-51.57	6.8	14.25	Horizontal	-44.12	-13.00	31.12	180

Note: 1.The other Spurious RF Radiated emissions level is no more than noise floor.

2. The worst emission was found in the antenna is Horizontal position.

## NB-IOT Band 4 CH-Middle

Harmonic	Frequency (MHz)	SG (dBm)	Cable Loss (dB)	Gain (dBi)	Antenna Polarization	EIRP Level (dBm)	Limit (dBm)	Margin (dB)	Azimuth (deg)
2	3461	-56.96	2.6	10.75	Horizontal	-48.81	-13.00	35.81	135
3	5191.5	-58.68	2.4	11.05	Horizontal	-50.03	-13.00	37.03	180
4	6922	-58.89	4.5	11.15	Horizontal	-52.24	-13.00	39.24	315
5	8652.5	-51.97	5.1	11.35	Horizontal	-45.72	-13.00	32.72	135
6	10383	-49.92	5.3	11.95	Horizontal	-43.27	-13.00	30.27	225
7	12113.5	-49.60	5.5	13.55	Horizontal	-41.55	-13.00	28.55	90
8	13844	-49.44	6.3	13.75	Horizontal	-41.99	-13.00	28.99	135
9	15574.5	-49.78	6.7	13.85	Horizontal	-42.63	-13.00	29.63	45
10	17305	-47.96	6.8	14.25	Horizontal	-40.51	-13.00	27.51	180

Note: 1.The other Spurious RF Radiated emissions level is no more than noise floor.

2. The worst emission was found in the antenna is Horizontal position.



## NB-IOT Band 4 CH-High

Harmonic	Frequency (MHz)	SG (dBm)	Cable Loss (dB)	Gain (dBi)	Antenna Polarization	EIRP Level (dBm)	Limit (dBm)	Margin (dB)	Azimuth (deg)
2	3509.8	-58.37	2.6	10.15	Horizontal	-50.82	-13.00	37.82	135
3	5264.7	-64.44	2.4	11.05	Horizontal	-55.79	-13.00	42.79	180
4	7019.6	-59.61	4.5	11.15	Horizontal	-52.96	-13.00	39.96	315
5	8774.5	-56.19	5.1	11.35	Horizontal	-49.94	-13.00	36.94	135
6	10529.4	-54.89	5.3	11.95	Horizontal	-48.24	-13.00	35.24	225
7	12284.3	-54.10	5.5	13.55	Horizontal	-46.05	-13.00	33.05	90
8	14039.2	-52.01	6.3	13.75	Horizontal	-44.56	-13.00	31.56	135
9	15794.1	-53.21	6.7	13.85	Horizontal	-46.06	-13.00	33.06	45
10	17549	-51.92	6.8	14.25	Horizontal	-44.47	-13.00	31.47	180

Note: 1.The other Spurious RF Radiated emissions level is no more than noise floor.  
2. The worst emission was found in the antenna is Horizontal position.

## NB-IOT Band 12 CH-Low

Harmonic	Frequency (MHz)	SG (dBm)	Cable Loss (dB)	Gain (dBi)	Antenna Polarization	ERP Level (dBm)	Limit (dBm)	Margin (dB)	Azimuth (deg)
2	1398.2	-46.83	2.00	10.15	Horizontal	-40.83	-13.00	27.83	315
3	2097.3	-57.48	2.50	11.35	Horizontal	-50.78	-13.00	37.78	90
4	2796.4	-60.67	4.20	10.85	Horizontal	-56.17	-13.00	43.17	45
5	3495.5	-57.47	5.20	11.35	Horizontal	-53.47	-13.00	40.47	135
6	4194.6	-59.28	5.50	11.95	Horizontal	-54.98	-13.00	41.98	180
7	4893.7	-60.86	5.70	13.55	Horizontal	-55.16	-13.00	42.16	45
8	5592.8	-59.80	6.30	13.75	Horizontal	-54.50	-13.00	41.50	225
9	6291.9	-57.80	6.80	13.85	Horizontal	-52.90	-13.00	39.90	180
10	6991.0	-56.68	6.90	14.25	Horizontal	-51.48	-13.00	38.48	180

Note: 1.The other Spurious RF Radiated emissions level is no more than noise floor.  
2. The worst emission was found in the antenna is Horizontal position.





## NB-IOT Band 12 CH-Middle

Harmonic	Frequency (MHz)	SG (dBm)	Cable Loss (dB)	Gain (dBi)	Antenna Polarization	ERP Level (dBm)	Limit (dBm)	Margin (dB)	Azimuth (deg)
2	1415.0	-59.85	2.00	10.75	Horizontal	-53.25	-13.00	40.25	270
3	2122.5	-60.08	2.51	11.05	Horizontal	-53.69	-13.00	40.69	315
4	2830.0	-63.66	4.20	11.15	Horizontal	-58.86	-13.00	45.86	180
5	3537.5	-60.07	5.20	11.15	Horizontal	-56.27	-13.00	43.27	90
6	4245.0	-61.54	5.50	11.95	Horizontal	-57.24	-13.00	44.24	45
7	4952.5	-61.53	5.70	13.55	Horizontal	-55.83	-13.00	42.83	90
8	5660.0	-60.89	6.30	13.75	Horizontal	-55.59	-13.00	42.59	135
9	6367.5	-58.44	6.80	13.85	Horizontal	-53.54	-13.00	40.54	180
10	7075.0	-55.41	6.90	14.25	Horizontal	-50.21	-13.00	37.21	315

Note: 1. The other Spurious RF Radiated emissions level is no more than noise floor.  
2. The worst emission was found in the antenna is Horizontal position.

## NB-IOT Band 12 CH-High

Harmonic	Frequency (MHz)	SG (dBm)	Cable Loss (dB)	Gain (dBi)	Antenna Polarization	ERP Level (dBm)	Limit (dBm)	Margin (dB)	Azimuth (deg)
2	1431.8	-55.19	2.00	10.15	Horizontal	-49.19	-13.00	36.19	90
3	2147.7	-50.65	2.51	11.05	Horizontal	-44.26	-13.00	31.26	45
4	2863.6	-64.17	4.20	11.15	Horizontal	-59.37	-13.00	46.37	90
5	3579.5	-60.53	5.20	11.15	Horizontal	-56.73	-13.00	43.73	135
6	4295.4	-60.92	5.50	11.95	Horizontal	-56.62	-13.00	43.62	225
7	5011.3	-60.94	5.70	13.55	Horizontal	-55.24	-13.00	42.24	90
8	5727.2	-61.17	6.30	13.75	Horizontal	-55.87	-13.00	42.87	135
9	6443.1	-58.78	6.80	13.85	Horizontal	-53.88	-13.00	40.88	45
10	7159.0	-55.89	6.90	14.25	Horizontal	-50.69	-13.00	37.69	225

Note: 1. The other Spurious RF Radiated emissions level is no more than noise floor.  
2. The worst emission was found in the antenna is Horizontal position.



## NB-IOT Band 13 CH-Low

Harmonic	Frequency (MHz)	SG (dBm)	Cable Loss (dB)	Gain (dBi)	Antenna Polarization	ERP Level (dBm)	Limit (dBm)	Margin (dB)	Azimuth (deg)
2	1554.2	-58.73	2.00	10.15	Horizontal	-52.73	-13.00	39.73	45
3	2331.3	-46.36	2.50	11.35	Horizontal	-39.66	-13.00	26.66	315
4	3108.4	-57.30	4.20	10.85	Horizontal	-52.80	-13.00	39.80	180
5	3885.5	-60.00	5.20	11.35	Horizontal	-56.00	-13.00	43.00	90
6	4662.6	-59.99	5.50	11.95	Horizontal	-55.69	-13.00	42.69	45
7	5439.7	-60.97	5.70	13.55	Horizontal	-55.27	-13.00	42.27	90
8	6216.8	-59.12	6.30	13.75	Horizontal	-53.82	-13.00	40.82	135
9	6993.9	-56.12	6.80	13.85	Horizontal	-51.22	-13.00	38.22	180
10	7771.0	-54.63	6.90	14.25	Horizontal	-49.43	-13.00	36.43	45

Note: 1. The other Spurious RF Radiated emissions level is no more than noise floor.  
2. The worst emission was found in the antenna is Horizontal position.

## NB-IOT Band 13 CH-Middle

Harmonic	Frequency (MHz)	SG (dBm)	Cable Loss (dB)	Gain (dBi)	Antenna Polarization	EIRP Level (dBm)	Limit (dBm)	Margin (dB)	Azimuth (deg)
2	1564.0	-60.47	2.00	10.75	Horizontal	-53.87	-40.00	13.87	90
Harmonic	Frequency (MHz)	SG (dBm)	Cable Loss (dB)	Gain (dBi)	Antenna Polarization	ERP Level (dBm)	Limit (dBm)	Margin (dB)	Azimuth (deg)
3	2346.0	-48.12	2.51	11.05	Horizontal	-41.73	-13.00	28.73	45
4	3128.0	-58.76	4.20	11.15	Horizontal	-53.96	-13.00	40.96	225
5	3910.0	-59.13	5.20	11.15	Horizontal	-55.33	-13.00	42.33	180
6	4692.0	-59.96	5.50	11.95	Horizontal	-55.66	-13.00	42.66	180
7	5474.0	-59.97	5.70	13.55	Horizontal	-54.27	-13.00	41.27	90
8	6256.0	-58.99	6.30	13.75	Horizontal	-53.69	-13.00	40.69	45
9	7038.0	-54.87	6.80	13.85	Horizontal	-49.97	-13.00	36.97	90
10	7820.0	-54.71	6.90	14.25	Horizontal	-49.51	-13.00	36.51	135

Note: 1. The other Spurious RF Radiated emissions level is no more than noise floor.  
2. The worst emission was found in the antenna is Horizontal position.

NB-IOT Band 13 CH-High

Harmonic	Frequency (MHz)	SG (dBm)	Cable Loss (dB)	Gain (dBi)	Antenna Polarization	EIRP Level (dBm)	Limit (dBm)	Margin (dB)	Azimuth (deg)
2	1573.8	-62.98	2.00	10.15	Horizontal	-56.98	-40.00	16.98	270
Harmonic	Frequency (MHz)	SG (dBm)	Cable Loss (dB)	Gain (dBi)	Antenna Polarization	ERP Level (dBm)	Limit (dBm)	Margin (dB)	Azimuth (deg)
3	2360.7	-48.46	2.51	11.05	Horizontal	-42.07	-13.00	29.07	315
4	3147.6	-59.64	4.20	11.15	Horizontal	-54.84	-13.00	41.84	180
5	3934.5	-59.95	5.20	11.15	Horizontal	-56.15	-13.00	43.15	315
6	4721.4	-59.81	5.50	11.95	Horizontal	-55.51	-13.00	42.51	135
7	5508.3	-59.78	5.70	13.55	Horizontal	-54.08	-13.00	41.08	225
8	6295.2	-56.75	6.30	13.75	Horizontal	-51.45	-13.00	38.45	90
9	7082.1	-54.91	6.80	13.85	Horizontal	-50.01	-13.00	37.01	135
10	7869.0	-54.22	6.90	14.25	Horizontal	-49.02	-13.00	36.02	45

Note: 1.The other Spurious RF Radiated emissions level is no more than noise floor.  
2. The worst emission was found in the antenna is Horizontal position.

NB-IOT Band 66 CH-Low

Harmonic	Frequency (MHz)	SG (dBm)	Cable Loss (dB)	Gain (dBi)	Antenna Polarization	EIRP Level (dBm)	Limit (dBm)	Margin (dB)	Azimuth (deg)
2	3420.2	-54.76	2.6	10.15	Horizontal	-47.21	-13.00	34.21	45
3	5130.3	-61.68	2.4	11.35	Horizontal	-52.73	-13.00	39.73	315
4	6840.4	-58.21	4.5	10.85	Horizontal	-51.86	-13.00	38.86	90
5	8550.5	-56.02	5.1	11.35	Horizontal	-49.77	-13.00	36.77	45
6	10260.6	-52.31	5.3	11.95	Horizontal	-45.66	-13.00	32.66	270
7	11970.7	-53.22	5.5	13.55	Horizontal	-45.17	-13.00	32.17	315
8	13680.8	-52.74	6.3	13.75	Horizontal	-45.29	-13.00	32.29	180
9	15390.9	-53.72	6.7	13.85	Horizontal	-46.57	-13.00	33.57	90
10	17101	-50.64	6.8	14.25	Horizontal	-43.19	-13.00	30.19	45

Note: 1.The other Spurious RF Radiated emissions level is no more than noise floor.  
2. The worst emission was found in the antenna is Horizontal position.



## NB-IOT Band 66 CH-Middle

Harmonic	Frequency (MHz)	SG (dBm)	Cable Loss (dB)	Gain (dBi)	Antenna Polarization	EIRP Level (dBm)	Limit (dBm)	Margin (dB)	Azimuth (deg)
2	3490	-58.18	2.6	10.75	Horizontal	-50.03	-13.00	37.03	135
3	5235	-63.07	2.4	11.05	Horizontal	-54.42	-13.00	41.42	180
4	6980	-59.02	4.5	11.15	Horizontal	-52.37	-13.00	39.37	45
5	8725	-56.67	5.1	11.35	Horizontal	-50.42	-13.00	37.42	225
6	10470	-54.11	5.3	11.95	Horizontal	-47.46	-13.00	34.46	180
7	12215	-54.86	5.5	13.55	Horizontal	-46.81	-13.00	33.81	180
8	13960	-51.21	6.3	13.75	Horizontal	-43.76	-13.00	30.76	90
9	15705	-53.14	6.7	13.85	Horizontal	-45.99	-13.00	32.99	45
10	17450	-52.45	6.8	14.25	Horizontal	-45.00	-13.00	32.00	90

Note: 1.The other Spurious RF Radiated emissions level is no more than noise floor.

2. The worst emission was found in the antenna is Horizontal position.

## NB-IOT Band 66 CH-High

Harmonic	Frequency (MHz)	SG (dBm)	Cable Loss (dB)	Gain (dBi)	Antenna Polarization	EIRP Level (dBm)	Limit (dBm)	Margin (dB)	Azimuth (deg)
2	3559.8	-58.95	2.6	10.15	Horizontal	-51.40	-13.00	38.40	135
3	5339.7	-64.34	2.4	11.05	Horizontal	-55.69	-13.00	42.69	180
4	7119.6	-56.77	4.5	11.15	Horizontal	-50.12	-13.00	37.12	315
5	8899.5	-55.43	5.1	11.35	Horizontal	-49.18	-13.00	36.18	135
6	10679.4	-53.28	5.3	11.95	Horizontal	-46.63	-13.00	33.63	225
7	12459.3	-53.55	5.5	13.55	Horizontal	-45.50	-13.00	32.50	90
8	14239.2	-52.63	6.3	13.75	Horizontal	-45.18	-13.00	32.18	135
9	16019.1	-52.93	6.7	13.85	Horizontal	-45.78	-13.00	32.78	45
10	17799	-50.77	6.8	14.25	Horizontal	-43.32	-13.00	30.32	180

Note: 1.The other Spurious RF Radiated emissions level is no more than noise floor.

2. The worst emission was found in the antenna is Horizontal position.



## NB-IOT Band 71 CH-Low

Harmonic	Frequency (MHz)	SG (dBm)	Cable Loss (dB)	Gain (dBi)	Antenna Polarization	ERP Level (dBm)	Limit (dBm)	Margin (dB)	Azimuth (deg)
2	1331.0	-45.99	2.00	10.15	Horizontal	-39.99	-13.00	26.99	0
3	1996.5	-44.36	2.50	11.35	Horizontal	-37.66	-13.00	24.66	45
4	2662.0	-56.41	4.20	10.85	Horizontal	-51.91	-13.00	38.91	135
5	3327.5	-54.49	5.20	11.35	Horizontal	-50.49	-13.00	37.49	270
6	3993.0	-53.07	5.50	11.95	Horizontal	-48.77	-13.00	35.77	315
7	4658.5	-53.21	5.70	13.55	Horizontal	-47.51	-13.00	34.51	270
8	5324.0	-52.15	6.30	13.75	Horizontal	-46.85	-13.00	33.85	45
9	5989.5	-51.75	6.80	13.85	Horizontal	-46.85	-13.00	33.85	270
10	6655.0	-50.00	6.90	14.25	Horizontal	-44.80	-13.00	31.80	0

Note: 1.The other Spurious RF Radiated emissions level is no more than noise floor.  
2. The worst emission was found in the antenna is Horizontal position.

## NB-IOT Band 71 CH-Middle

Harmonic	Frequency (MHz)	SG (dBm)	Cable Loss (dB)	Gain (dBi)	Antenna Polarization	ERP Level (dBm)	Limit (dBm)	Margin (dB)	Azimuth (deg)
2	1361.0	-47.70	2.00	10.75	Horizontal	-41.10	-13.00	28.10	90
3	2041.5	-46.24	2.51	11.05	Horizontal	-39.85	-13.00	26.85	180
4	2722.0	-60.49	4.20	11.15	Horizontal	-55.69	-13.00	42.69	270
5	3402.5	-61.89	5.20	11.15	Horizontal	-58.09	-13.00	45.09	0
6	4083.0	-60.20	5.50	11.95	Horizontal	-55.90	-13.00	42.90	135
7	4763.5	-60.82	5.70	13.55	Horizontal	-55.12	-13.00	42.12	90
8	5444.0	-60.24	6.30	13.75	Horizontal	-54.94	-13.00	41.94	45
9	6124.5	-59.77	6.80	13.85	Horizontal	-54.87	-13.00	41.87	180
10	6805.0	-56.01	6.90	14.25	Horizontal	-50.81	-13.00	37.81	90

Note: 1.The other Spurious RF Radiated emissions level is no more than noise floor.  
2. The worst emission was found in the antenna is Horizontal position.



## NB-IOT Band 71 CH-High

Harmonic	Frequency (MHz)	SG (dBm)	Cable Loss (dB)	Gain (dBi)	Antenna Polarization	ERP Level (dBm)	Limit (dBm)	Margin (dB)	Azimuth (deg)
2	1391.0	-45.06	2.00	10.15	Horizontal	-39.06	-13.00	26.06	45
3	2086.5	-54.72	2.51	11.05	Horizontal	-48.33	-13.00	35.33	9
4	2782.0	-56.11	4.20	11.15	Horizontal	-51.31	-13.00	38.31	180
5	3477.5	-56.09	5.20	11.15	Horizontal	-52.29	-13.00	39.29	45
6	4173.0	-59.62	5.50	11.95	Horizontal	-55.32	-13.00	42.32	0
7	4868.5	-60.91	5.70	13.55	Horizontal	-55.21	-13.00	42.21	180
8	5564.0	-60.75	6.30	13.75	Horizontal	-55.45	-13.00	42.45	135
9	6259.5	-59.31	6.80	13.85	Horizontal	-54.41	-13.00	41.41	270
10	6955.0	-56.81	6.90	14.25	Horizontal	-51.61	-13.00	38.61	0

Note: 1.The other Spurious RF Radiated emissions level is no more than noise floor.  
2. The worst emission was found in the antenna is Horizontal position.

## NB-IOT Band 85 CH-Low

Harmonic	Frequency (MHz)	SG (dBm)	Cable Loss (dB)	Gain (dBi)	Antenna Polarization	ERP Level (dBm)	Limit (dBm)	Margin (dB)	Azimuth (deg)
2	1396.2	-47.06	2.00	10.15	Horizontal	-41.06	-13.00	28.06	135
3	2094.3	-53.77	2.50	11.35	Horizontal	-47.07	-13.00	34.07	12
4	2792.4	-57.67	4.20	10.85	Horizontal	-53.17	-13.00	40.17	0
5	3490.5	-56.56	5.20	11.35	Horizontal	-52.56	-13.00	39.56	0
6	4188.6	-60.32	5.50	11.95	Horizontal	-56.02	-13.00	43.02	135
7	4886.7	-65.64	5.70	13.55	Horizontal	-59.94	-13.00	46.94	270
8	5584.8	-60.83	6.30	13.75	Horizontal	-55.53	-13.00	42.53	0
9	6282.9	-58.74	6.80	13.85	Horizontal	-53.84	-13.00	40.84	180
10	6981.0	-56.60	6.90	14.25	Horizontal	-51.40	-13.00	38.40	45

Note: 1.The other Spurious RF Radiated emissions level is no more than noise floor.  
2. The worst emission was found in the antenna is Horizontal position.



## NB-IOT Band 85 CH-Middle

Harmonic	Frequency (MHz)	SG (dBm)	Cable Loss (dB)	Gain (dBi)	Antenna Polarization	ERP Level (dBm)	Limit (dBm)	Margin (dB)	Azimuth (deg)
2	1411.8	-44.92	2.00	10.75	Horizontal	-38.32	-13.00	25.32	180
3	2117.7	-49.68	2.51	11.05	Horizontal	-43.29	-13.00	30.29	270
4	2823.6	-58.43	4.20	11.15	Horizontal	-53.63	-13.00	40.63	45
5	3529.5	-58.99	5.20	11.15	Horizontal	-55.19	-13.00	42.19	90
6	4235.4	-60.50	5.50	11.95	Horizontal	-56.20	-13.00	43.20	135
7	4941.3	-61.26	5.70	13.55	Horizontal	-55.56	-13.00	42.56	270
8	5647.2	-60.37	6.30	13.75	Horizontal	-55.07	-13.00	42.07	315
9	6353.1	-59.22	6.80	13.85	Horizontal	-54.32	-13.00	41.32	180
10	7059.0	-56.89	6.90	14.25	Horizontal	-51.69	-13.00	38.69	45

Note: 1. The other Spurious RF Radiated emissions level is no more than noise floor.  
2. The worst emission was found in the antenna is Horizontal position.

## NB-IOT Band 85 CH-High

Harmonic	Frequency (MHz)	SG (dBm)	Cable Loss (dB)	Gain (dBi)	Antenna Polarization	ERP Level (dBm)	Limit (dBm)	Margin (dB)	Azimuth (deg)
2	1431.8	-52.66	2.00	10.15	Horizontal	-46.66	-13.00	33.66	90
3	2147.7	-49.92	2.51	11.05	Horizontal	-43.53	-13.00	30.53	180
4	2863.6	-60.60	4.20	11.15	Horizontal	-55.80	-13.00	42.80	45
5	3579.5	-58.53	5.20	11.15	Horizontal	-54.73	-13.00	41.73	0
6	4295.4	-60.14	5.50	11.95	Horizontal	-55.84	-13.00	42.84	90
7	5011.3	-60.78	5.70	13.55	Horizontal	-55.08	-13.00	42.08	45
8	5727.2	-60.60	6.30	13.75	Horizontal	-55.30	-13.00	42.30	45
9	6443.1	-60.05	6.80	13.85	Horizontal	-55.15	-13.00	42.15	135
10	7159.0	-55.57	6.90	14.25	Horizontal	-50.37	-13.00	37.37	315

Note: 1. The other Spurious RF Radiated emissions level is no more than noise floor.  
2. The worst emission was found in the antenna is Horizontal position.



## 6 Main Test Instruments

Name	Manufacturer	Type	Serial Number	Calibration Date	Expiration Date
Base Station Simulator	R&S	CMW500	113824	2019-05-19	2020-05-18
Power Splitter	Hua Xiang	SHX-GF2-2-13	10120101	/	/
Spectrum Analyzer	Key sight	N9010A	MY50210259	2019-05-19	2020-05-18
Signal Analyzer	R&S	FSV30	100815	2018-12-16	2019-12-15
Loop Antenna	SCHWARZBECK	FMZB1519	1519-047	2017-09-26	2020-09-25
Trilog Antenna	SCHWARZBECK	VUBL 9163	9163-201	2017-11-18	2020-11-17
Horn Antenna	R&S	HF907	100126	2018-07-07	2020-07-06
Horn Antenna	ETS-Lindgren	3160-09	00102643	2018-06-20	2020-06-19
Horn Antenna	STEATITE	QSH-SL-26-40-K-15	16779	2017-07-20	2020-07-19
Signal generator	R&S	SMB 100A	102594	2019-05-19	2020-05-18
Climatic Chamber	ESPEC	SU-242	93000506	2017-12-17	2020-12-16
Preamplifier	R&S	SCU18	102327	2019-05-19	2020-05-18
MOB COMMS DC SUPPLY	Keysight	66319D	MY43004105	2019-05-19	2020-05-18
RF Cable	Agilent	SMA 15cm	0001	2019-12-13	2020-06-12
Software	R&S	EMC32	9.26.0	/	/
Wireless Test Set	StarPoint	SP8315	SP8315-1202	2019-05-19	2020-05-18
Wireless Test Set	StarPoint	SP8315	SP8315-1203	2019-05-19	2020-05-18

\*\*\*\*\*END OF REPORT \*\*\*\*\*