

# TEST REPORT

**Applicant:** GMSTEK, LLC  
**EUT Description:** X-1 Cloud Connect  
**Model:** X-1 Cloud Connect v3.0  
**Brand:** X-1FBO  
**FCC ID:** 2BE49-X1CCAV2024030  
**Standards:** FCC 47 CFR Part 15 Subpart C  
**Date of Receipt:** 2024/04/25  
**Date of Test:** 2024/04/25 to 2024/10/22  
**Date of Issue:** 2024/10/22

TOWE. tested the above equipment in accordance with the requirements set forth in the above standards. The test results show that the equipment tested is capable of demonstrating compliance with the requirements as documented in this report.

the results documented in this report apply only to the tested sample, under the conditions and modes of operation as described herein. It is the manufacturer's responsibility to assure that additional production units of the model are manufactured with identical electrical and mechanical components. All sample tested were in good operating condition throughout the entire test program. Measurement Uncertainties are published for informational purposes only and were not taken into account unless noted otherwise. without written approval of TOWE, the test report shall not be reproduced except in full.

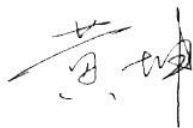

**Huangkun**  
**Approved By:**



**ChenChengfu**  
**Reviewed By:**

## Revision History

<b>Rev.</b>	<b>Issue Date</b>	<b>Description</b>	<b>Revised by</b>
01	2024/10/22	Original	ChenChengfu

## Summary of Test Results

FCC Part	Test Items	Result
§15.203/15.247(b)	Antenna Requirement	PASS
§15.207	AC Power Line Conducted Emission	N/A
§15.247 (b)(3)	Output Power	PASS
§15.247 (a)(2)	Occupied Bandwidth	PASS*
§15.247 (e)	Power Spectral Density	PASS*
§15.247(d)	Band Edge for Conducted Emissions	PASS*
§15.247(d)	Spurious RF Conducted Emissions	PASS*
§15.205/15.209	Radiated Spurious emissions and Band Edge	PASS

Test Method: ANSI C63.10-2013, KDB 558074 D01 15.247 Mesa Guidance v05r02.

Remark:

1. Pass is EUT meets standard requirements.
2. Pass\*: Refer to Module FCC ID: XMR20211108FC41D, Detailed data reference Report No.: BTL-FCCP-1-2111H032, provided by BTL Inc.
3. The EUT is DC power supply, "N/A" denotes "not applicable".

## Table of Contents

<b>1</b>	<b>General Description .....</b>	<b>5</b>
1.1	Lab Information.....	5
1.1.1	Testing Location .....	5
1.1.2	Test Facility / Accreditations .....	5
1.2	Client Information .....	5
1.2.1	Applicant.....	5
1.2.2	Manufacturer.....	5
1.3	Product Information.....	6
<b>2</b>	<b>Test Configuration .....</b>	<b>7</b>
2.1	Test Channel .....	7
2.2	Worst-case configuration and Mode .....	7
2.3	Support Unit used in test .....	7
2.4	Test Environment.....	7
2.5	Test RF Cable .....	7
2.6	Modifications.....	7
2.7	Test Setup Diagram .....	8
2.7.1	Conducted Configuration .....	8
2.7.2	Radiated Configuration .....	9
<b>3</b>	<b>Equipment and Measurement Uncertainty.....</b>	<b>10</b>
3.1	Test Equipment List.....	10
3.2	Measurement Uncertainty .....	11
<b>4</b>	<b>Test Results.....</b>	<b>12</b>
4.1	Antenna Requirement.....	12
4.2	Output Power .....	13
4.3	Radiated Spurious Emissions and Band Edge .....	14
<b>5</b>	<b>Test Setup Photos.....</b>	<b>16</b>
	Appendix.....	17

# 1 General Description

## 1.1 Lab Information

### 1.1.1 Testing Location

These measurements tests were conducted at the Sushi TOWE Wireless Testing(Shenzhen) Co., Ltd. facility located at F401 and F101, Building E, Hongwei Industrial Zone, Liuxian 3rd Road, Bao'an District, Shenzhen, China. The measurement facility is compliant with the test site requirements specified in ANSI C63.4-2014  
Tel.: +86-755-27212361  
Contact Email: info@towewireless.com

### 1.1.2 Test Facility / Accreditations

#### A2LA (Certificate Number: 7088.01)

This laboratory is accredited in accordance with the recognized International Standard ISO/IEC 17025:2017 General requirements for the competence of testing and calibration laboratories. This accreditation demonstrates technical competence for a defined scope and the operation of a laboratory quality management system (refer to joint ISO-ILAC-IAF Communiqué dated April 2017).

#### FCC Designation No.: CN1353

Sushi TOWE Wireless Testing(Shenzhen) Co., Ltd. has been recognized as an accredited testing laboratory. Designation Number: CN1353.

#### ISED CAB identifier: CN0152

Sushi TOWE Wireless Testing(Shenzhen) Co., Ltd. has been recognized by ISED as an accredited testing laboratory.  
CAB identifier: CN0152  
Company Number: 31000

## 1.2 Client Information

### 1.2.1 Applicant

Applicant:	GMSTEK, LLC
Address:	18001 OLD CUTLER RD STE 472 PALMETTO BAY, FL 33157-6437 UNITED STATES OF AMERICA

### 1.2.2 Manufacturer

Manufacturer:	GMSTEK, LLC
Address:	18001 OLD CUTLER RD STE 472 PALMETTO BAY, FL 33157-6437 UNITED STATES OF AMERICA

### 1.3 Product Information

EUT Description:	X-1 Cloud Connect		
Model:	X-1 Cloud Connect v3.0		
Brand:	X-1FBO		
Hardware Version:	3.0.2.15		
Software Version:	3.0.2.2406		
IMEI:	Conducted	863251074186854	
	Radiation	869267078787790	
Modulation Type:	802.11b:	DSSS-DBPSK, DQPSK, CCK	
	802.11g&n:	OFDM-BPSK, QPSK, 16QAM, 64QAM	
Smart System:	<input checked="" type="checkbox"/> SISO	802.11b/g/n	/
	<input type="checkbox"/> MIMO	802.11g/n	( )TX( )RX
	<input type="checkbox"/> CDD	802.11b	( )TX( )RX
Frequency Range:	2400 ~ 2483.5MHz		
Channel Frequency:	20M bandwidth Channel: 2412 ~ 2462MHz		
Channel Number:	11:	802.11b/g/n20	
Resource unit (RU):	<input type="checkbox"/> Support <input checked="" type="checkbox"/> Not Supported		
Antenna Type:	<input type="checkbox"/> External, <input checked="" type="checkbox"/> Integrated		
Antenna Gain:	-2.5dBi		
Remark: The above EUT's information was declared by applicant, please refer to the specifications or user's manual for more detailed description.			

## 2 Test Configuration

### 2.1 Test Channel

Frequency Channels							
Channel	Frequency	Channel	Frequency	Channel	Frequency	Channel	Frequency
1	2412MHz	4	2427MHz	7	2442MHz	10	2457MHz
2	2417MHz	5	2432MHz	8	2447MHz	11	2462MHz
3	2422MHz	6	2437MHz	9	2452MHz	/	

Remark:

In section 15.31(m), regards to the operating frequency range over 10 MHz, the Lowest frequency, the middle frequency, and the highest frequency of channel were selected to perform the test, and the selected channel see below:

Modulation Type	Test Channel	Test Frequency
802.11b/g/n20	The Lowest channel (CH1)	2412MHz
	The Middle channel (CH6)	2437MHz
	The Highest channel (CH11)	2462MHz

### 2.2 Worst-case configuration and Mode

Modulation Type	SISO - Data Rate	MIMO - Data Rate
802.11b	1 Mbps	N/A
802.11g	6 Mbps	N/A
802.11(n20)	MCS0 (6.5 Mbps)	N/A
Transmitting mode:	Keep the EUT was programmed to be in continuously transmitting mode.	
Normal Link:	Keep the EUT operation to normal function.	

### 2.3 Support Unit used in test

The EUT has been tested as an independent unit.

### 2.4 Test Environment

Temperature:	Normal: 15°C ~ 35°C
Relative Humidity	45-56 % RH Ambient
Voltage:	DC 24V
Remark: The testing environment is within the scope of the EUT user manual and meets the requirements of the standard testing environment.	

### 2.5 Test RF Cable

**For all conducted test items:** The offset level is set spectrum analyzer to compensate the RF cable loss and attenuator factor between RF conducted output port and spectrum analyzer. With the offset compensation, the spectrum analyzer reading level will be exactly the RF output level.

The spectrum analyzer offset is derived from RF cable loss and attenuator factor.

*Offset = RF cable loss + attenuator factor.*

### 2.6 Modifications

No modifications were made during testing.

## 2.7 Test Setup Diagram

### 2.7.1 Conducted Configuration

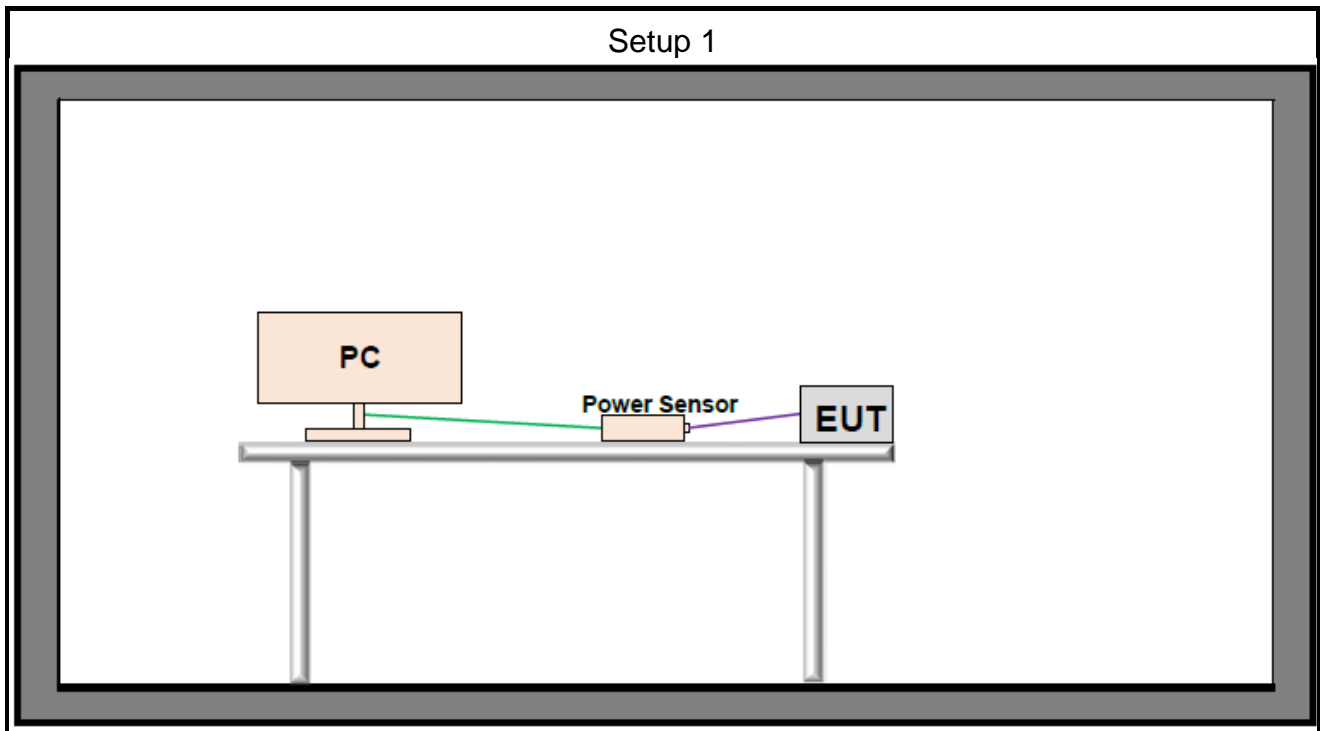



**2.7.2 Radiated Configuration**

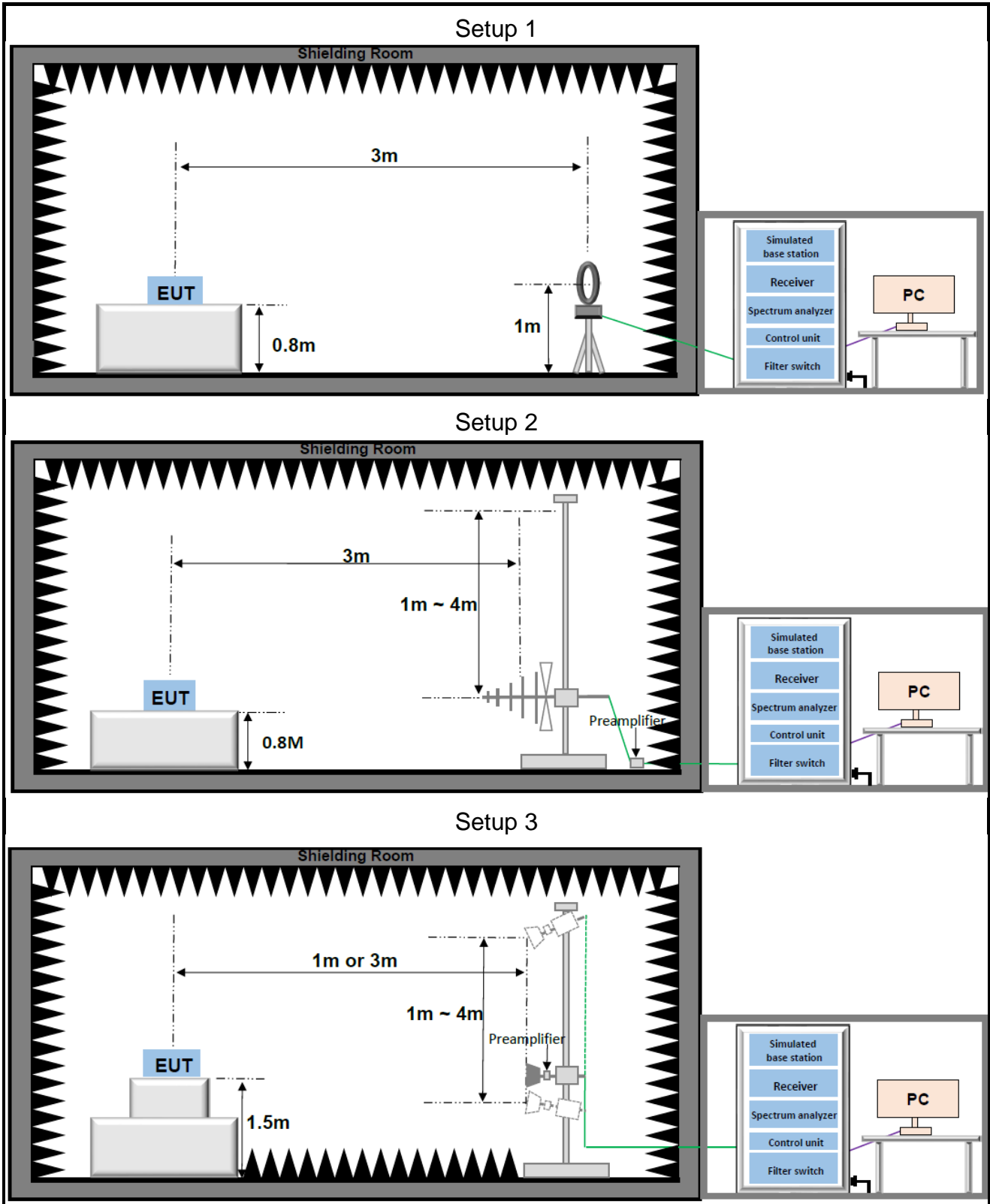

### 3 Equipment and Measurement Uncertainty

All test and measuring equipment utilized to perform the tests documented in this report are calibrated on a regular basis, whichever is less, and where applicable is traceable to recognized national standards.

#### 3.1 Test Equipment List

RF03					
Description	Manufacturer	Model	SN	Last Due	Cal Due
Signal Analyzer	Keysight	N9020A	US46470429	2024/03/25	2025/03/24
Vector Signal Generator	R&S	SMM100A	549353	2024/05/30	2025/05/29
RF Control Unit	Tonscend	JS0806-2	23C80620671	2024/05/30	2025/05/29
Power Sensor	Anritsu	MA24408A	12520	2024/05/30	2025/05/29
Measurement Software	Tonscend	JS1120-3 V3.5.39	10776	N/A	N/A

Radiated Emission					
Description	Manufacturer	Model	SN	Last Due	Cal Due
Biconic Logarithmic Periodic Antennas	Schwarzbeck	VULB9163	1643	2023/06/25	2025/06/24
Double-Ridged Horn Antennas	Schwarzbeck	BBHA 9120D	2809	2023/06/25	2025/06/24
Broad-Band Horn Antenna	Schwarzbeck	BBHA 9170	1290	2023/06/25	2025/06/24
Loop Antenna	Schwarzbeck	FMZB 1519C	1519C-028	2023/06/29	2025/06/28
Signal Analyzer	Keysight	N9020A	MY49100252	2024/03/25	2025/03/24
EXA Signal Analyzer, Multi-touch	Keysight	N9010B	MY63440541	2024/05/30	2025/05/29
Wideband Radio Communication Tester	R&S	CMW500	150645	2024/03/25	2025/03/24
Low Noise Amplifier	Tonscend	TAP9K3G40	AP23A8060273	2023/04/08	2025/04/07
Low Noise Amplifier	Tonscend	TAP01018050	AP22G806258	2023/04/08	2025/04/07
Low Noise Amplifier	Tonscend	TAP18040048	AP22G806247	2023/04/08	2025/04/07
Hygrometer	BINGYU	HTC-1	N/A	2023/06/01	2025/05/31
Test Software	Tonscend	TS+ V5.0.0	N/A	N/A	N/A

### 3.2 Measurement Uncertainty

Parameter	U <sub>lab</sub>
Output Power	0.76dB
Radiated Emissions(9kHz~30MHz)	2.40dB
Radiated Emissions(30MHz~1000MHz)	4.66dB
Radiated Emissions(1GHz~18GHz)	5.42dB
Radiated Emissions(18GHz~40GHz)	5.46dB

Uncertainty figures are valid to a confidence level of 95%

## 4 Test Results

### 4.1 Antenna Requirement

<b>Standard Applicable:</b>	47 CFR Part 15C Section 15.203 /247(b)
<p>15.203 requirement: An intentional radiator shall be designed to ensure that no antenna other than that furnished by the responsible party shall be used with the device. The use of a permanently attached antenna or of an antenna that uses a unique coupling to the intentional radiator, the manufacturer may design the unit so that a broken antenna can be replaced by the user, but the use of a standard antenna jack or electrical connector is prohibited.</p>	
<p>15.247(b) (4) requirement: The conducted output power limit specified in paragraph (b) of this section is based on the use of antennas with directional gains that do not exceed 6 dBi. Except as shown in paragraph (c) of this section, if transmitting antennas of directional gain greater than 6 dBi are used, the conducted output power from the intentional radiator shall be reduced below the stated values in paragraphs (b)(1), (b)(2), and (b)(3) of this section, as appropriate, by the amount in dB that the directional gain of the antenna exceeds 6 dBi.</p>	
<p>The antenna gain and type as provided by the manufacturer are as follows: The antenna Type is Integrated. With maximum gain is -2.5dBi. Antenna Anti-Replacement Construction: An embedded-in antenna design is used.</p>	

## 4.2 Output Power

### Limits

If with directional antenna gains less than 6 dBi, the limit is 30dBm.

### Test Procedure

ANSI C63.10:2013 Section 11.9.1.3(PKPM1) or 11.9.2.3.2(AVGPM-G)

### Test Settings

1. Set to the maximum power setting and enable the EUT transmit continuously.
2. The power output was measured on the EUT antenna port using RF Cable with attenuator connected to a power meter via wideband power sensor. Peak output power was read directly from power meter.
3. Measure and record the results in the test report.

### Test Setup

Refer to section 2.7.1 Setup 1 for details.

### Measuring Instruments

The measuring equipment is listed in the section 3.1 of this test report.

### Test Result

The detailed test data see: **Appendix**.

### 4.3 Radiated Spurious Emissions and Band Edge

#### Limits

Spurious emissions are permitted in an of the frequency bands:

MHz	MHz	MHz	MHz	GHz	GHz
0.090 - 0.110	12.29 - 12.293	149.9 - 150.05	1660 - 1710	4.5 - 5.15	14.47 - 14.5
0.495 - 0.505	12.51975 - 1252025	156.52475 - 156.52525	1718.8 - 1722.2	5.35 - 5.46	15.35 - 16.2
2.1735 - 2.1905	12.5767 - 12.57725	156.7 - 156.9	2200 - 2300	7.25 - 7.75	17.7 - 21.4
4.125 - 128	13.36 - 13.41	162.0125 - 167.17	2310 - 2390	8.025 - 8.5	22.01 - 23.12
4.17725 - 4.17775	16.42 - 16.423	167.72 - 173.2	2483.5 - 2500	9.0 - 9.2	23.6 - 24.0
4.20725 - 4.20775	16.69475 - 16.69525	240 - 285	2655 - 2900	9.3 - 9.5	31.2 - 31.8
6.215 - 6.218	1680425 - 1680475	322 - 335.4	3260 - 3267	10.6 - 12.7	36.43 - 36.5
6.26775 - 6.26825	25.5 - 25.67	399.9 - 410	3332 - 3339	13.25 - 13.4	
6.31175 - 6.31225	37.5 - 38.25	608 - 614	3345.8 - 3358		
8.291 - 8.294	73 - 74.6	960 - 1240	3600 - 4400		
8.362 - 8.366	74.8 - 75.2	1300 - 1427			
8.37625 - 8.38675	108 - 121.94	1435 - 1626.5			
8.41425 - 8.41475	123 - 138	1645.5 - 1646.5			

Radiated disturbance of an intentional radiator:

Frequency	Field strength (μV/m)	Limit (dBμV/m)	Remark	Measurement distance (m)
0.009MHz-0.490MHz	2400/F(kHz)	-	-	300
0.490MHz-1.705MHz	24000/F(kHz)	-	-	30
1.705MHz-30MHz	30	-	-	30
30MHz-88MHz	100	40.0	Quasi-peak	3
88MHz-216MHz	150	43.5	Quasi-peak	3
216MHz-960MHz	200	46.0	Quasi-peak	3
960MHz-1GHz	500	54.0	Quasi-peak	3
Above 1GHz	500	74.0	Peak	3
		54.0	Average	

#### Test Procedure

ANSI C63.10:2013 Section 6.4 & 6.5 & 6.6

#### Test Settings

- For radiated emissions measurements performed at frequencies less than or equal to 1GHz, the EUT shall be placed on a RF-transparent table or support at a nominal height of 80cm above the reference ground plane.
- For radiated emissions measurements performed at frequencies above 1GHz, the EUT shall be placed on a RF-transparent table or support at a nominal height of 150cm above the ground plane.
- Radiated measurements shall be made with the measurement antenna positioned in both horizontal and vertical polarization. The measurement antenna shall be varied from 1m to 4m in height above the reference ground in a search for the relative positioning that produces the maximum radiated signal level (i.e, field strength or received power), when orienting the measurement antenna in vertical polarization, the minimum height of the lowest element of the antenna shall clear the site reference ground plane by at least 25cm.
- For each suspected emission, the EUT was ranged its worst case and then tune the antenna tower(from 1~4m) and turntable(from 0~360°) find the maximum reading. Preamplifier and a high pass filter are used for the test in order get better signal level comply with the guidelines.
- Set to the maximum power setting and enable the EUT transmit continuously.
- The emission limits shown in the above table are based on measurements employing a CISPR quasi-peak detector except for the frequency bands 9-90 kHz, 110-490 kHz and above 1000 MHz. Radiated emission limits in these three bands are based on measurements employing an average detector.
- spectrum analyzer setting:  
Measurements 30MHz ~ 1000MHz: RBW = 120 kHz; VBW ≥ 300 kHz; Detector = Peak

Measurements Above 1000MHz: RBW = 1 MHz; VBW  $\geq$  3 MHz; Detector = Peak

Average Measurements Above 1000MHz:

RBW = 1 MHz, VBW  $\geq$  1/T, with peak detector for average measurements.

8. The field strength is calculated by adding the Antenna Factor, Cable Factor. The basic equation with a sample calculation is as follows:

Level = Reading(dB $\mu$ V) + AF(dB/m) + Factor(dB):

AF = Antenna Factor(dB/m)

Factor = Cable Factor(dB) - Preamplifier gain(dB)

Margin = Limit(dB $\mu$ V/m) – Level(dB $\mu$ V/m)

9. Repeat above procedures until all frequencies measured was complete.  
10. Measure and record the results in the test report.

### **Test Notes**

1. Emissions below 18GHz were measured at a 3-meter test distance while emissions above 18GHz were measured at a 1-meter test distance with the application of a distance correction factor.
2. Radiated spurious emissions were investigated from 9kHz to 30MHz, 30MHz-1GHz and above 1GHz. the disturbance between 9kHz to 30MHz, 30MHz-1GHz and 18GHz to 40GHz was very low. The amplitude of spurious emissions from the radiator which are attenuated more than 20dB below the limit need not be recorded, so only the harmonics had been displayed.
3. The "-" shown in the following RSE tables are used to denote a noise floor measurement.

### **Test Setup**

Refer to section 2.7.2 for details.

### **Measuring Instruments**

The measuring equipment is listed in the section 3.1 of this test report.

### **Test Result**

The detailed test data see: **Appendix**.

## 5 Test Setup Photos

The detailed test data see: **Test Setup Photos**



# Appendix

## Maximum conducted output power Test Result

TestMode	Antenna	Frequency[MHz]	Conducted Power[dBm]	Conducted Limit[dBm]	Verdict
802.11b	Ant1	2412	18.402	≤30	PASS
	Ant1	2437	18.358	≤30	PASS
	Ant1	2462	18.941	≤30	PASS
802.11g	Ant1	2412	21.904	≤30	PASS
	Ant1	2437	22.092	≤30	PASS
	Ant1	2462	22.305	≤30	PASS
802.11n20	Ant1	2412	21.037	≤30	PASS
	Ant1	2437	21.028	≤30	PASS
	Ant1	2462	21.901	≤30	PASS

## Radiated Spurious Emissions Test Result

Project Information			
Mode:	802.11b	Band:	/
Bandwidth	20MHz	Channel	1
IMEI:	869267078787790	Engineer:	申状
Remark:	Polarity: Z		
Test Standard: FCC PART 15 C			

### Test Graph

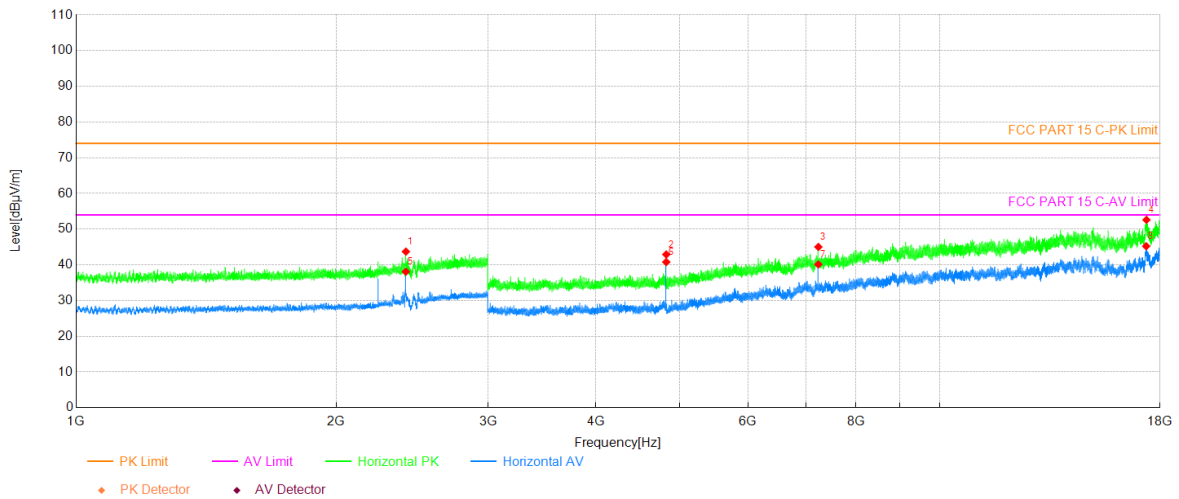

### Data List

NO.	Freq. [MHz]	Reading [dBμV]	Factor [dB]	Level [dBμV/m]	Limit [dBμV/m]	Margin [dB]	Polarity	Verdict
1	2409.40	39.22	4.49	43.71	-	-	Horizontal	NA
2	4824.00	50.75	-7.84	42.91	74.00	31.09	Horizontal	PASS
3	7237.50	46.52	-1.49	45.03	74.00	28.97	Horizontal	PASS
4	17360.50	40.16	12.45	52.61	74.00	21.39	Horizontal	PASS
5	2409.00	33.62	4.48	38.10	-	-	Horizontal	NA
6	4824.50	48.65	-7.85	40.80	54.00	13.20	Horizontal	PASS
7	7236.00	41.63	-1.49	40.14	54.00	13.86	Horizontal	PASS
8	17349.50	32.39	12.84	45.23	54.00	8.77	Horizontal	PASS

Project Information			
Mode:	802.11b	Band:	/
Bandwidth	20MHz	Channel	1
IMEI:	869267078787790	Engineer:	申状
Remark:	Polarity: Z		
Test Standard: FCC PART 15 C			

### Test Graph

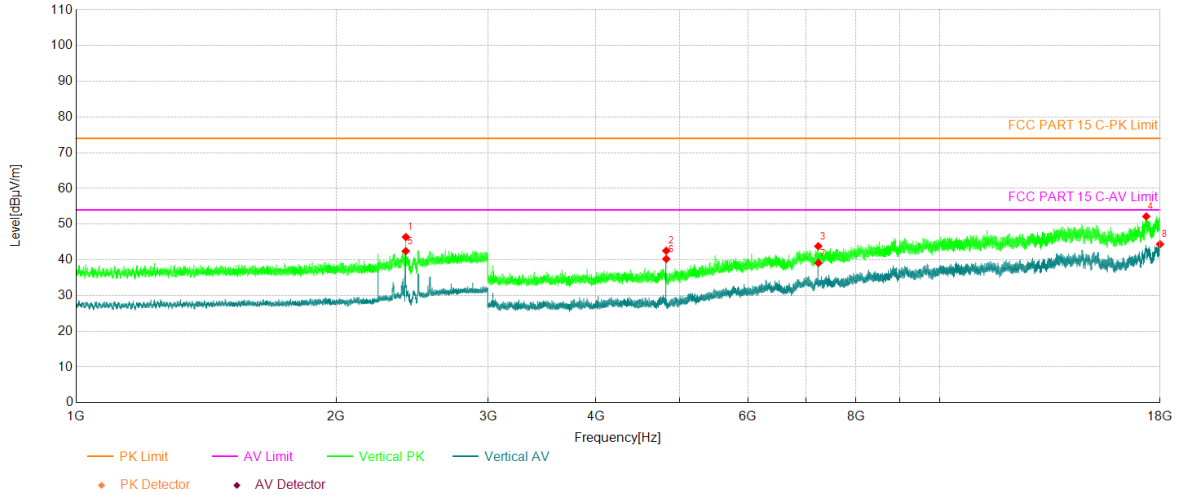

Data List								
NO.	Freq. [MHz]	Reading [dBuV]	Factor [dB]	Level [dBµV/m]	Limit [dBµV/m]	Margin [dB]	Polarity	Verdict
1	2409.20	41.91	4.48	46.39	-	-	Vertical	NA
2	4824.00	50.39	-7.84	42.55	74.00	31.45	Vertical	PASS
3	7235.00	45.32	-1.49	43.83	74.00	30.17	Vertical	PASS
4	17351.00	39.34	12.82	52.16	74.00	21.84	Vertical	PASS
5	2408.60	37.99	4.47	42.46	-	-	Vertical	NA
6	4824.50	48.10	-7.85	40.25	54.00	13.75	Vertical	PASS
7	7237.50	40.63	-1.49	39.14	54.00	14.86	Vertical	PASS
8	17998.50	31.57	12.81	44.38	54.00	9.62	Vertical	PASS

Project Information			
Mode:	802.11b	Band:	/
Bandwidth	20MHz	Channel	6
IMEI:	869267078787790	Engineer:	申状
Remark:	Polarity: Z		
Test Standard: FCC PART 15 C			

### Test Graph

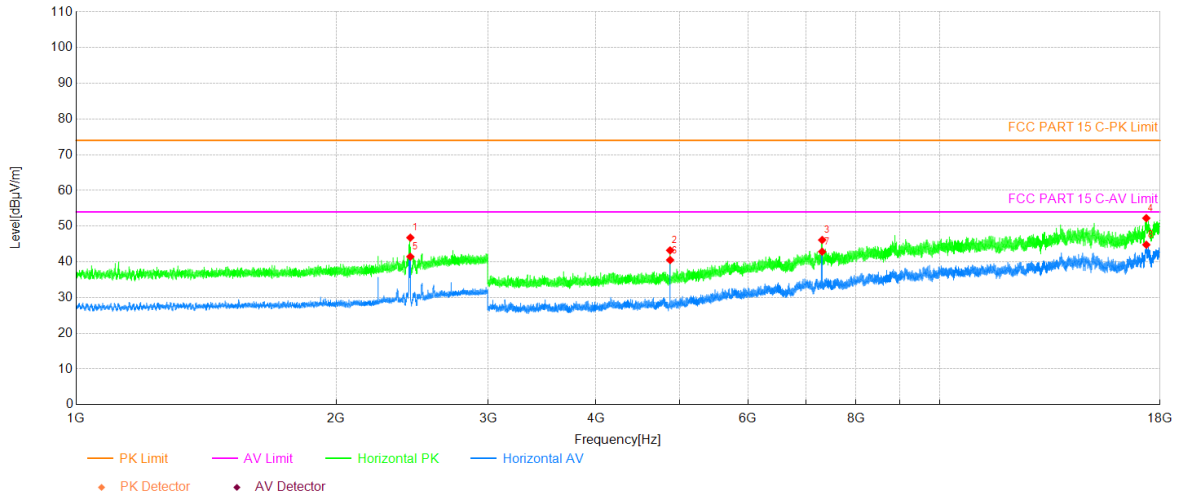

Data List								
NO.	Freq. [MHz]	Reading [dBuV]	Factor [dB]	Level [dBµV/m]	Limit [dBµV/m]	Margin [dB]	Polarity	Verdict
1	2438.00	42.15	4.64	46.79	-	-	Horizontal	NA
2	4874.00	51.30	-8.08	43.22	74.00	30.78	Horizontal	PASS
3	7311.00	47.41	-1.27	46.14	74.00	27.86	Horizontal	PASS
4	17351.50	39.44	12.80	52.24	74.00	21.76	Horizontal	PASS
5	2438.20	36.81	4.64	41.45	-	-	Horizontal	NA
6	4874.50	48.60	-8.08	40.52	54.00	13.48	Horizontal	PASS
7	7310.50	44.13	-1.26	42.87	54.00	11.13	Horizontal	PASS
8	17353.50	32.08	12.72	44.80	54.00	9.20	Horizontal	PASS

Project Information			
Mode:	802.11b	Band:	/
Bandwidth	20MHz	Channel	6
IMEI:	869267078787790	Engineer:	申状
Remark:	Polarity: Z		
Test Standard: FCC PART 15 C			

### Test Graph

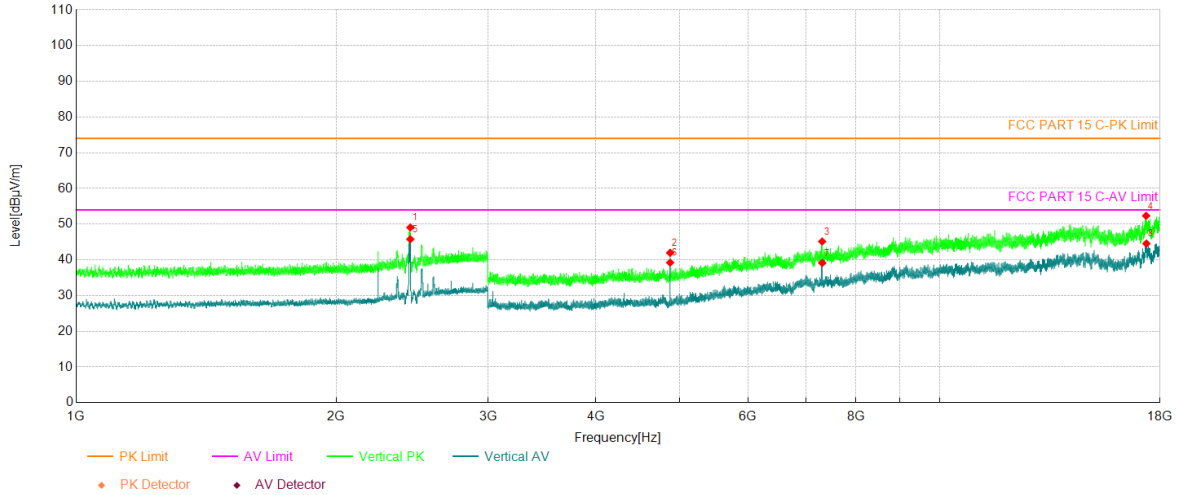

Data List								
NO.	Freq. [MHz]	Reading [dBuV]	Factor [dB]	Level [dBμV/m]	Limit [dBμV/m]	Margin [dB]	Polarity	Verdict
1	2438.00	44.43	4.64	49.07	-	-	Vertical	NA
2	4874.00	50.05	-8.08	41.97	74.00	32.03	Vertical	PASS
3	7310.50	46.41	-1.26	45.15	74.00	28.85	Vertical	PASS
4	17345.50	39.68	12.66	52.34	74.00	21.66	Vertical	PASS
5	2437.80	41.15	4.64	45.79	-	-	Vertical	NA
6	4874.50	47.31	-8.08	39.23	54.00	14.77	Vertical	PASS
7	7312.50	40.42	-1.28	39.14	54.00	14.86	Vertical	PASS
8	17357.00	31.98	12.59	44.57	54.00	9.43	Vertical	PASS

Project Information			
Mode:	802.11b	Band:	/
Bandwidth	20MHz	Channel	11
IMEI:	869267078787790	Engineer:	申状
Remark:	Polarity: Z		
Test Standard: FCC PART 15 C			

### Test Graph

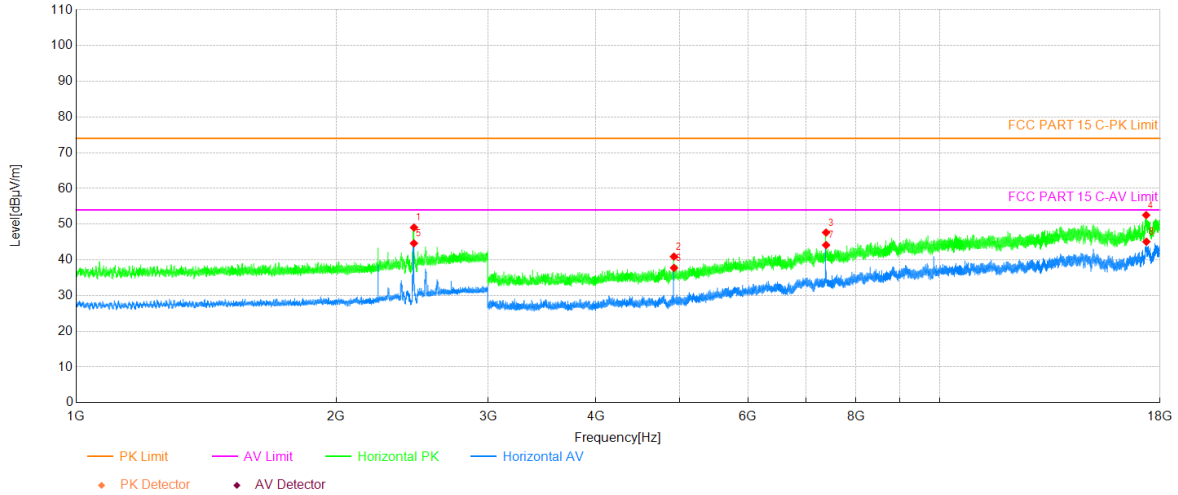

Data List								
NO.	Freq. [MHz]	Reading [dBuV]	Factor [dB]	Level [dBµV/m]	Limit [dBµV/m]	Margin [dB]	Polarity	Verdict
1	2462.00	44.28	4.78	49.06	-	-	Horizontal	NA
2	4924.00	48.67	-7.76	40.91	74.00	33.09	Horizontal	PASS
3	7387.00	48.81	-1.15	47.66	74.00	26.34	Horizontal	PASS
4	17347.00	39.81	12.73	52.54	74.00	21.46	Horizontal	PASS
5	2461.40	39.85	4.78	44.63	-	-	Horizontal	NA
6	4924.50	45.52	-7.76	37.76	54.00	16.24	Horizontal	PASS
7	7387.50	45.30	-1.15	44.15	54.00	9.85	Horizontal	PASS
8	17358.00	32.54	12.55	45.09	54.00	8.91	Horizontal	PASS

Project Information			
Mode:	802.11b	Band:	/
Bandwidth	20MHz	Channel	11
IMEI:	869267078787790	Engineer:	申状
Remark:	Polarity: Z		
Test Standard: FCC PART 15 C			

### Test Graph

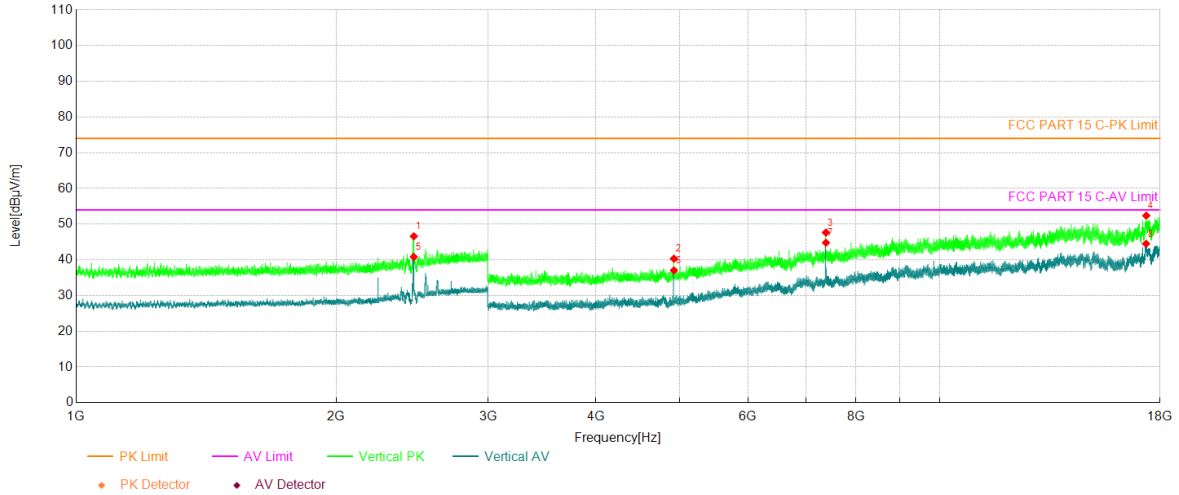

Data List								
NO.	Freq. [MHz]	Reading [dBuV]	Factor [dB]	Level [dBµV/m]	Limit [dBµV/m]	Margin [dB]	Polarity	Verdict
1	2461.00	41.83	4.77	46.60	-	-	Vertical	NA
2	4924.00	48.09	-7.76	40.33	74.00	33.67	Vertical	PASS
3	7385.00	48.82	-1.17	47.65	74.00	26.35	Vertical	PASS
4	17351.50	39.59	12.80	52.39	74.00	21.61	Vertical	PASS
5	2460.80	36.06	4.77	40.83	-	-	Vertical	NA
6	4924.50	44.81	-7.76	37.05	54.00	16.95	Vertical	PASS
7	7385.50	45.97	-1.17	44.80	54.00	9.20	Vertical	PASS
8	17341.50	32.05	12.47	44.52	54.00	9.48	Vertical	PASS

Project Information			
Mode:	802.11g	Band:	/
Bandwidth	20MHz	Channel	1
IMEI:	869267078787790	Engineer:	申状
Remark:	Polarity: Z		
Test Standard: FCC PART 15 C			

### Test Graph

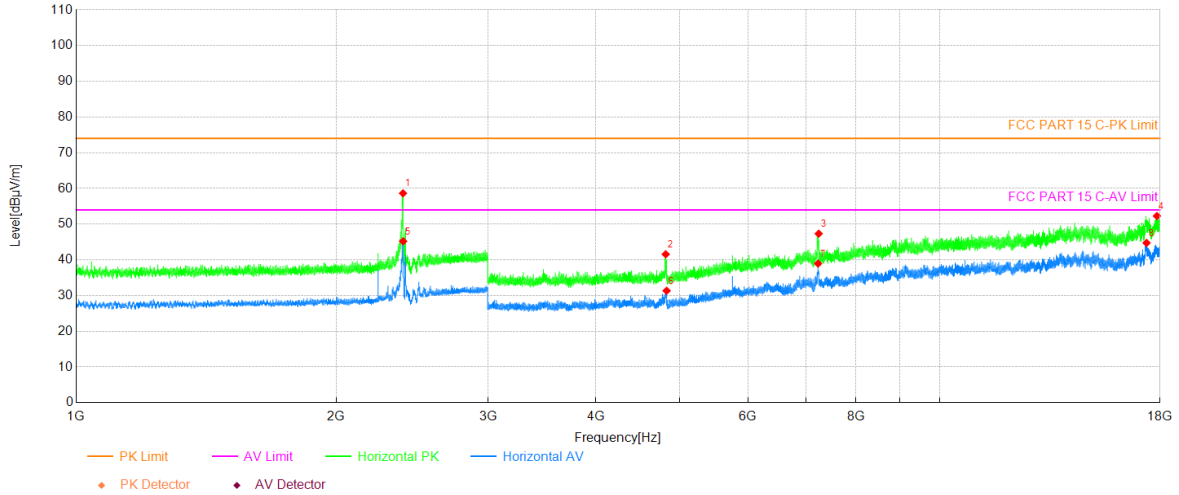

Data List								
NO.	Freq. [MHz]	Reading [dBuV]	Factor [dB]	Level [dBμV/m]	Limit [dBμV/m]	Margin [dB]	Polarity	Verdict
1	2390.80	54.24	4.40	58.64	-	-	Horizontal	NA
2	4817.50	49.32	-7.75	41.57	74.00	32.43	Horizontal	PASS
3	7244.00	48.86	-1.52	47.34	74.00	26.66	Horizontal	PASS
4	17851.50	39.50	12.78	52.28	74.00	21.72	Horizontal	PASS
5	2391.80	40.82	4.40	45.22	-	-	Horizontal	NA
6	4828.50	39.26	-7.90	31.36	54.00	22.64	Horizontal	PASS
7	7231.50	40.45	-1.48	38.97	54.00	15.03	Horizontal	PASS
8	17365.50	32.49	12.26	44.75	54.00	9.25	Horizontal	PASS



Project Information			
Mode:	802.11g	Band:	/
Bandwidth	20MHz	Channel	1
IMEI:	869267078787790	Engineer:	申状
Remark:	Polarity: Z		
Test Standard: FCC PART 15 C			

### Test Graph

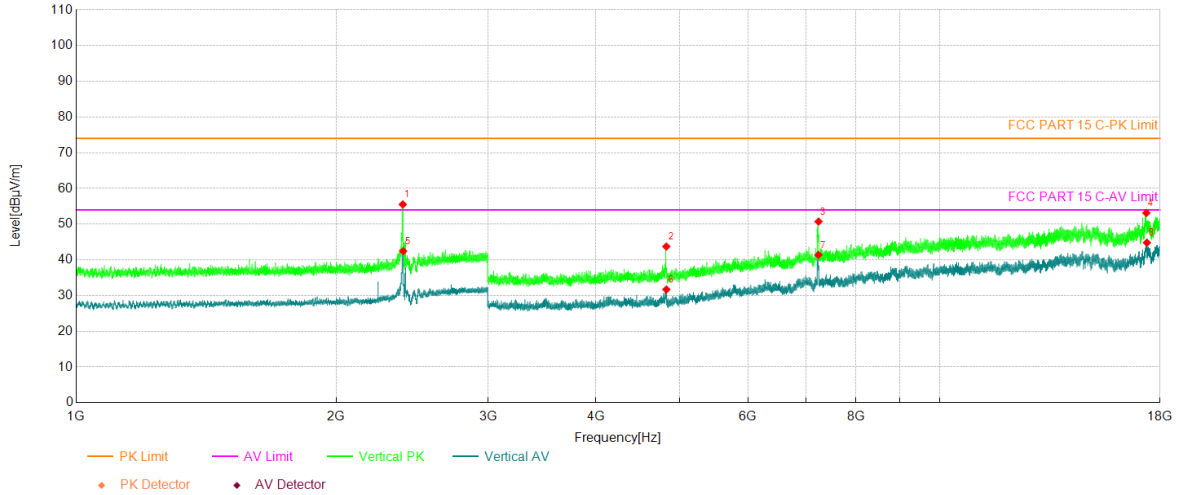

Data List								
NO.	Freq. [MHz]	Reading [dBuV]	Factor [dB]	Level [dBµV/m]	Limit [dBµV/m]	Margin [dB]	Polarity	Verdict
1	2389.40	51.14	4.39	55.53	-	-	Vertical	NA
2	4825.00	51.60	-7.86	43.74	74.00	30.26	Vertical	PASS
3	7241.00	52.24	-1.51	50.73	74.00	23.27	Vertical	PASS
4	17356.00	40.51	12.63	53.14	74.00	20.86	Vertical	PASS
5	2391.80	38.06	4.40	42.46	-	-	Vertical	NA
6	4825.50	39.57	-7.86	31.71	54.00	22.29	Vertical	PASS
7	7238.00	42.89	-1.50	41.39	54.00	12.61	Vertical	PASS
8	17382.50	33.24	11.58	44.82	54.00	9.18	Vertical	PASS

Project Information			
Mode:	802.11g	Band:	/
Bandwidth	20MHz	Channel	6
IMEI:	869267078787790	Engineer:	申状
Remark:	Polarity: Z		
Test Standard: FCC PART 15 C			

### Test Graph

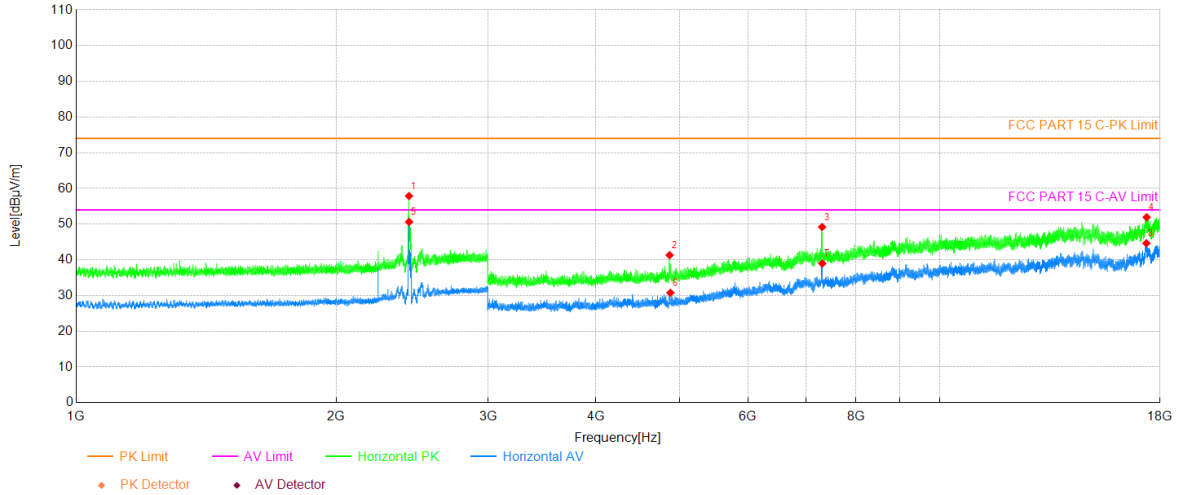

Data List								
NO.	Freq. [MHz]	Reading [dBuV]	Factor [dB]	Level [dBµV/m]	Limit [dBµV/m]	Margin [dB]	Polarity	Verdict
1	2429.20	53.28	4.60	57.88	-	-	Horizontal	NA
2	4867.00	49.42	-8.11	41.31	74.00	32.69	Horizontal	PASS
3	7309.00	50.46	-1.26	49.20	74.00	24.80	Horizontal	PASS
4	17370.00	39.86	12.08	51.94	74.00	22.06	Horizontal	PASS
5	2429.80	46.04	4.60	50.64	-	-	Horizontal	NA
6	4878.00	38.85	-8.06	30.79	54.00	23.21	Horizontal	PASS
7	7313.50	40.27	-1.28	38.99	54.00	15.01	Horizontal	PASS
8	17355.50	32.01	12.65	44.66	54.00	9.34	Horizontal	PASS

Project Information			
Mode:	802.11g	Band:	/
Bandwidth	20MHz	Channel	6
IMEI:	869267078787790	Engineer:	申状
Remark:	Polarity: Z		
Test Standard: FCC PART 15 C			

### Test Graph

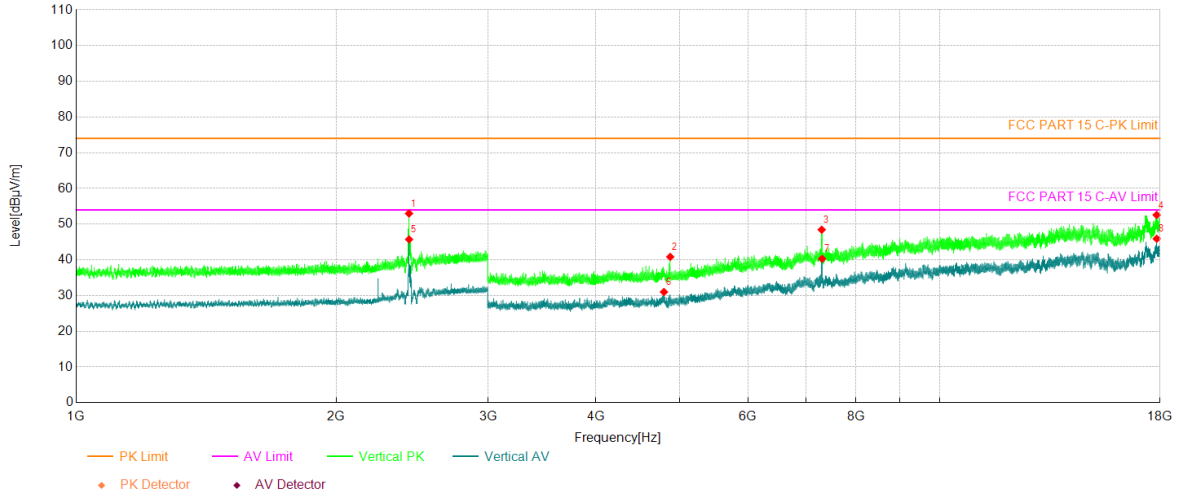

Data List								
NO.	Freq. [MHz]	Reading [dBuV]	Factor [dB]	Level [dBµV/m]	Limit [dBµV/m]	Margin [dB]	Polarity	Verdict
1	2429.40	48.39	4.60	52.99	-	-	Vertical	NA
2	4875.50	48.91	-8.07	40.84	74.00	33.16	Vertical	PASS
3	7301.50	49.65	-1.20	48.45	74.00	25.55	Vertical	PASS
4	17840.50	39.91	12.66	52.57	74.00	21.43	Vertical	PASS
5	2429.80	41.14	4.60	45.74	-	-	Vertical	NA
6	4794.50	38.59	-7.58	31.01	54.00	22.99	Vertical	PASS
7	7311.00	41.59	-1.27	40.32	54.00	13.68	Vertical	PASS
8	17843.00	33.22	12.70	45.92	54.00	8.08	Vertical	PASS

Project Information			
Mode:	802.11g	Band:	/
Bandwidth	20MHz	Channel	11
IMEI:	869267078787790	Engineer:	申状
Remark:	Polarity: Z		
Test Standard: FCC PART 15 C			

### Test Graph

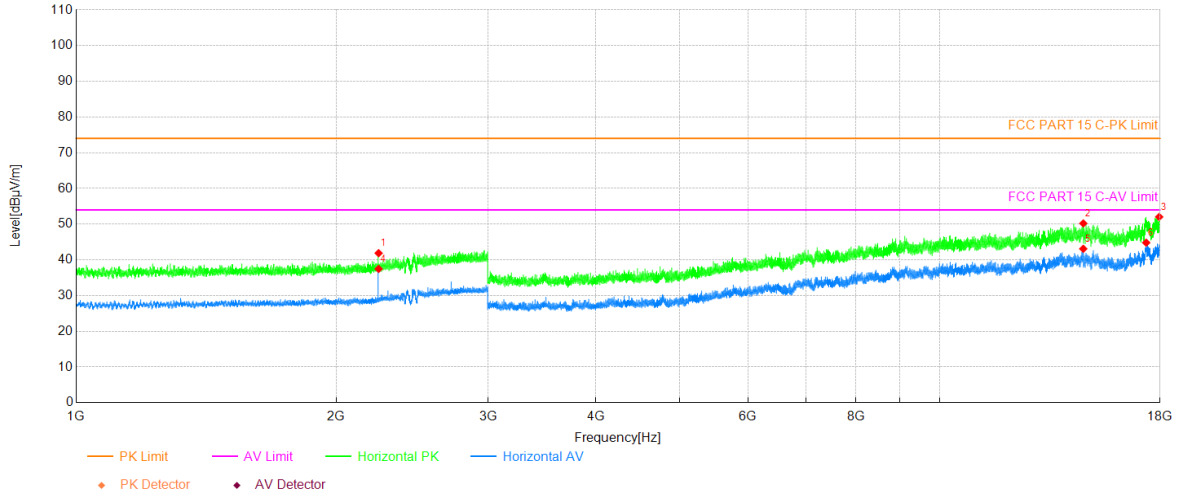

Data List								
NO.	Freq. [MHz]	Reading [dBuV]	Factor [dB]	Level [dBµV/m]	Limit [dBµV/m]	Margin [dB]	Polarity	Verdict
1	2240.20	38.25	3.63	41.88	74.00	32.12	Horizontal	PASS
2	14669.50	40.84	9.38	50.22	74.00	23.78	Horizontal	PASS
3	17960.50	39.73	12.30	52.03	74.00	21.97	Horizontal	PASS
4	2240.20	33.84	3.63	37.47	54.00	16.53	Horizontal	PASS
5	14667.50	33.66	9.44	43.10	54.00	10.90	Horizontal	PASS
6	17347.50	32.07	12.75	44.82	54.00	9.18	Horizontal	PASS

Project Information			
Mode:	802.11g	Band:	/
Bandwidth	20MHz	Channel	11
IMEI:	869267078787790	Engineer:	申状
Remark:	Polarity: Z		
Test Standard: FCC PART 15 C			

### Test Graph

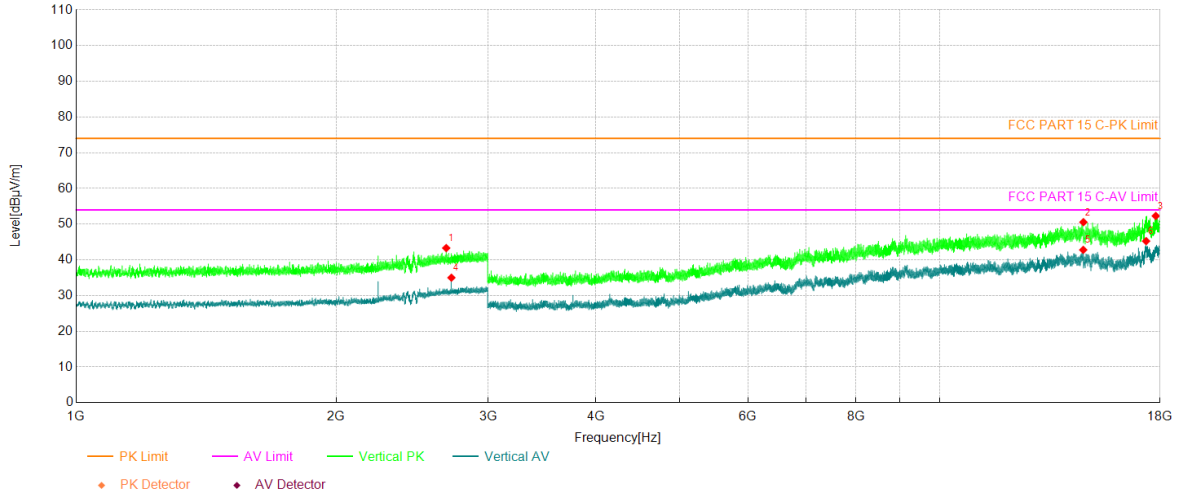

Data List								
NO.	Freq. [MHz]	Reading [dBuV]	Factor [dB]	Level [dBµV/m]	Limit [dBµV/m]	Margin [dB]	Polarity	Verdict
1	2683.00	37.26	6.05	43.31	74.00	30.69	Vertical	PASS
2	14673.50	41.29	9.27	50.56	74.00	23.44	Vertical	PASS
3	17796.00	40.33	11.96	52.29	74.00	21.71	Vertical	PASS
4	2720.20	28.78	6.23	35.01	54.00	18.99	Vertical	PASS
5	14666.50	33.34	9.46	42.80	54.00	11.20	Vertical	PASS
6	17344.50	32.66	12.60	45.26	54.00	8.74	Vertical	PASS

Project Information			
Mode:	802.11n20	Band:	/
Bandwidth	20MHz	Channel	1
IMEI:	869267078787790	Engineer:	申状
Remark:	Polarity: Z		
Test Standard: FCC PART 15 C			

### Test Graph

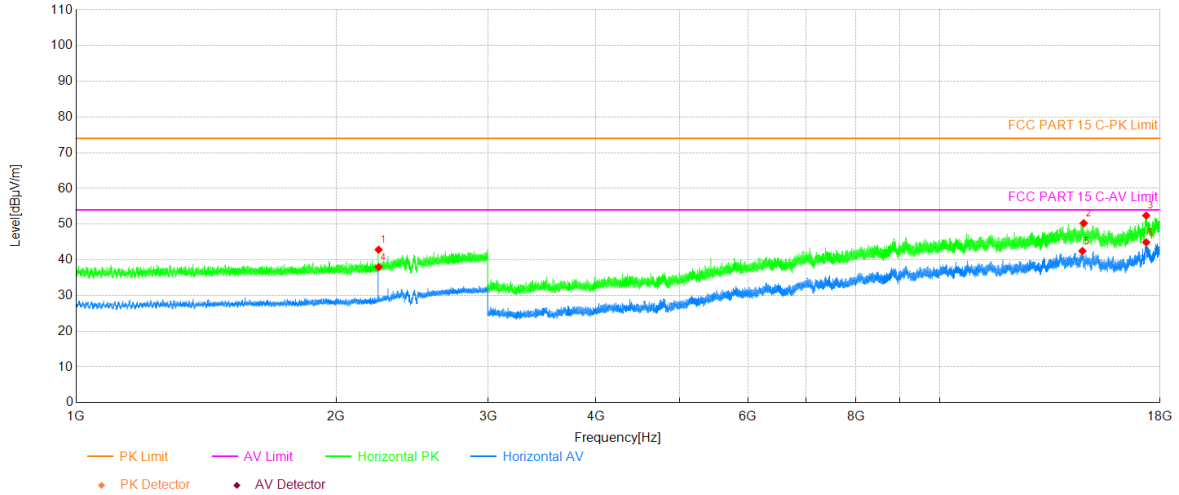

Data List								
NO.	Freq. [MHz]	Reading [dBuV]	Factor [dB]	Level [dBµV/m]	Limit [dBµV/m]	Margin [dB]	Polarity	Verdict
1	2240.40	39.22	3.63	42.85	74.00	31.15	Horizontal	PASS
2	14686.50	41.35	8.91	50.26	74.00	23.74	Horizontal	PASS
3	17350.00	39.55	12.86	52.41	74.00	21.59	Horizontal	PASS
4	2240.20	34.35	3.63	37.98	54.00	16.02	Horizontal	PASS
5	14633.50	32.96	9.53	42.49	54.00	11.51	Horizontal	PASS
6	17348.50	32.12	12.79	44.91	54.00	9.09	Horizontal	PASS

Project Information			
Mode:	802.11n20	Band:	/
Bandwidth	20MHz	Channel	1
IMEI:	869267078787790	Engineer:	申状
Remark:	Polarity: Z		
Test Standard: FCC PART 15 C			

### Test Graph

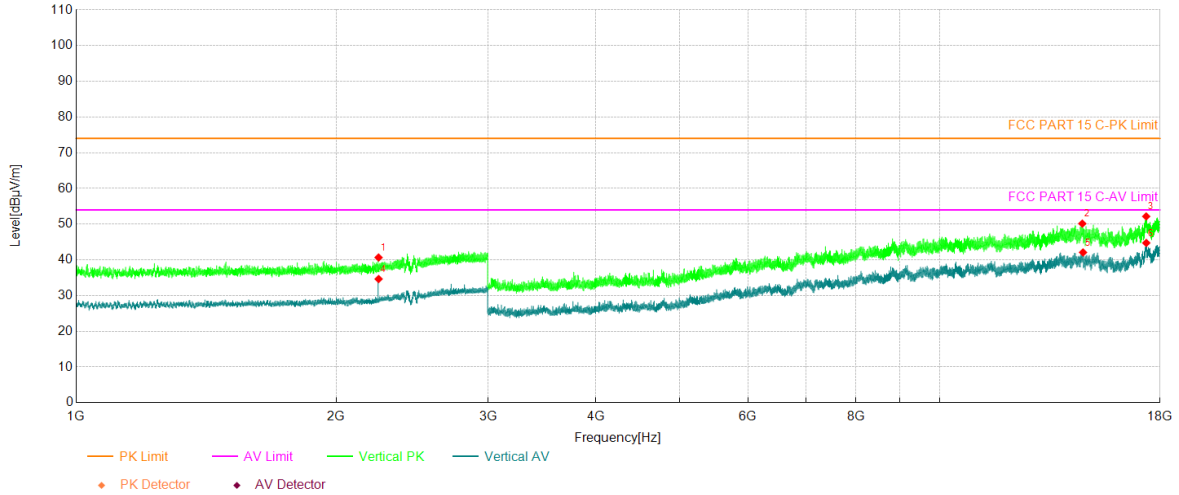

Data List								
NO.	Freq. [MHz]	Reading [dBuV]	Factor [dB]	Level [dBµV/m]	Limit [dBµV/m]	Margin [dB]	Polarity	Verdict
1	2240.00	37.04	3.63	40.67	74.00	33.33	Vertical	PASS
2	14630.50	40.70	9.46	50.16	74.00	23.84	Vertical	PASS
3	17347.50	39.42	12.75	52.17	74.00	21.83	Vertical	PASS
4	2240.20	31.01	3.63	34.64	54.00	19.36	Vertical	PASS
5	14659.00	32.42	9.67	42.09	54.00	11.91	Vertical	PASS
6	17351.00	31.92	12.82	44.74	54.00	9.26	Vertical	PASS

Project Information			
Mode:	802.11n20	Band:	/
Bandwidth	20MHz	Channel	6
IMEI:	869267078787790	Engineer:	申状
Remark:	Polarity: Z		
Test Standard: FCC PART 15 C			

### Test Graph

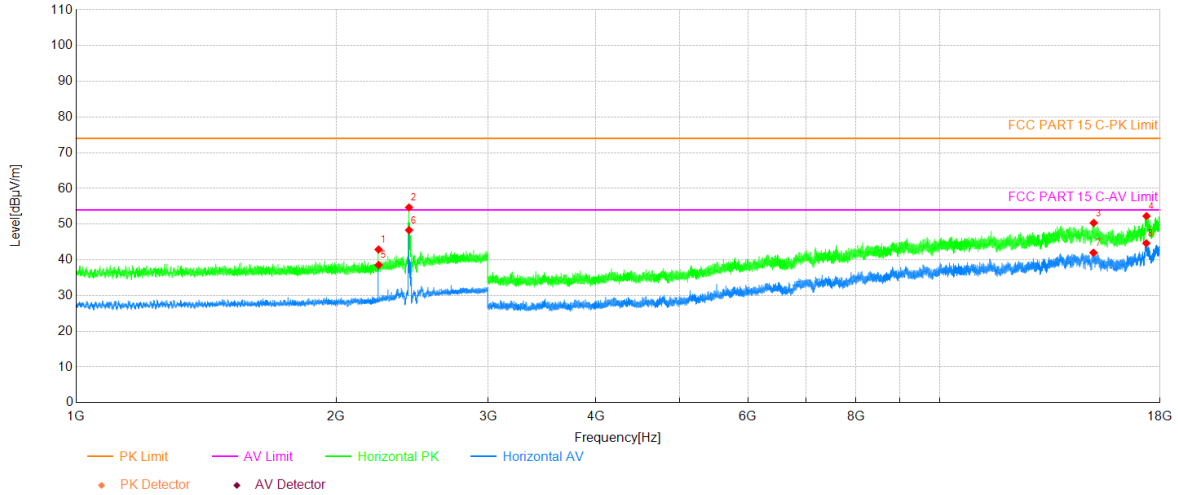

Data List								
NO.	Freq. [MHz]	Reading [dBuV]	Factor [dB]	Level [dBµV/m]	Limit [dBµV/m]	Margin [dB]	Polarity	Verdict
1	2240.00	39.28	3.63	42.91	74.00	31.09	Horizontal	PASS
2	2429.40	50.08	4.60	54.68	-	-	Horizontal	NA
3	15080.50	41.36	8.99	50.35	74.00	23.65	Horizontal	PASS
4	17361.50	39.85	12.41	52.26	74.00	21.74	Horizontal	PASS
5	2240.20	34.94	3.63	38.57	54.00	15.43	Horizontal	PASS
6	2429.80	43.73	4.60	48.33	-	-	Horizontal	NA
7	15072.00	33.05	8.96	42.01	54.00	11.99	Horizontal	PASS
8	17352.50	31.90	12.76	44.66	54.00	9.34	Horizontal	PASS



Project Information			
Mode:	802.11n20	Band:	/
Bandwidth	20MHz	Channel	6
IMEI:	869267078787790	Engineer:	申状
Remark:	Polarity: Z		
Test Standard: FCC PART 15 C			

### Test Graph

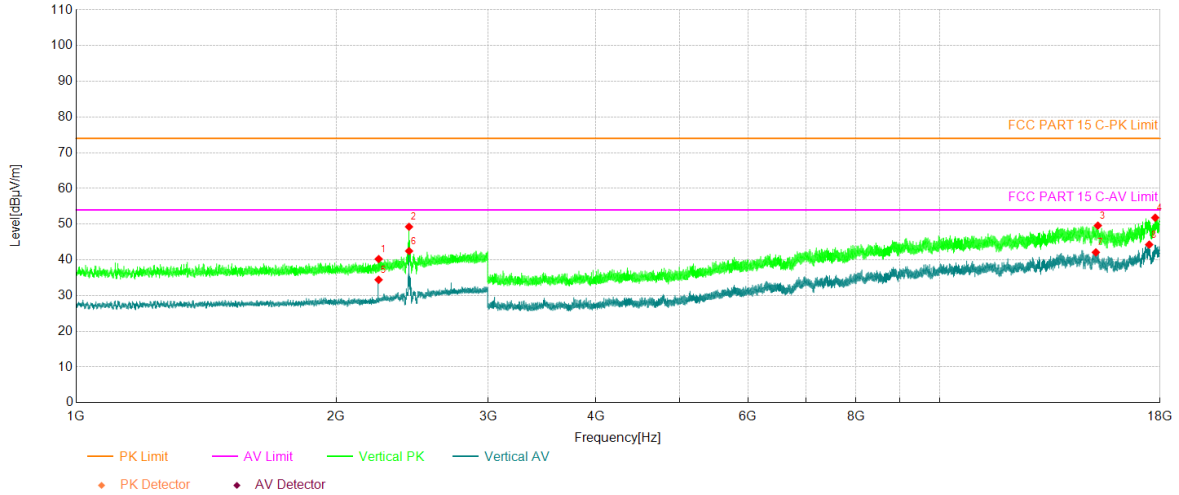

Data List								
NO.	Freq. [MHz]	Reading [dBuV]	Factor [dB]	Level [dBµV/m]	Limit [dBµV/m]	Margin [dB]	Polarity	Verdict
1	2240.60	36.60	3.63	40.23	74.00	33.77	Vertical	PASS
2	2429.40	44.67	4.60	49.27	-	-	Vertical	NA
3	15249.50	40.26	9.34	49.60	74.00	24.40	Vertical	PASS
4	17768.50	40.62	11.20	51.82	74.00	22.18	Vertical	PASS
5	2240.20	30.80	3.63	34.43	54.00	19.57	Vertical	PASS
6	2429.80	37.87	4.60	42.47	-	-	Vertical	NA
7	15167.50	33.81	8.30	42.11	54.00	11.89	Vertical	PASS
8	17487.50	32.58	11.70	44.28	54.00	9.72	Vertical	PASS

Project Information			
Mode:	802.11n20	Band:	/
Bandwidth	20MHz	Channel	11
IMEI:	869267078787790	Engineer:	申状
Remark:	Polarity: Z		
Test Standard: FCC PART 15 C			

### Test Graph

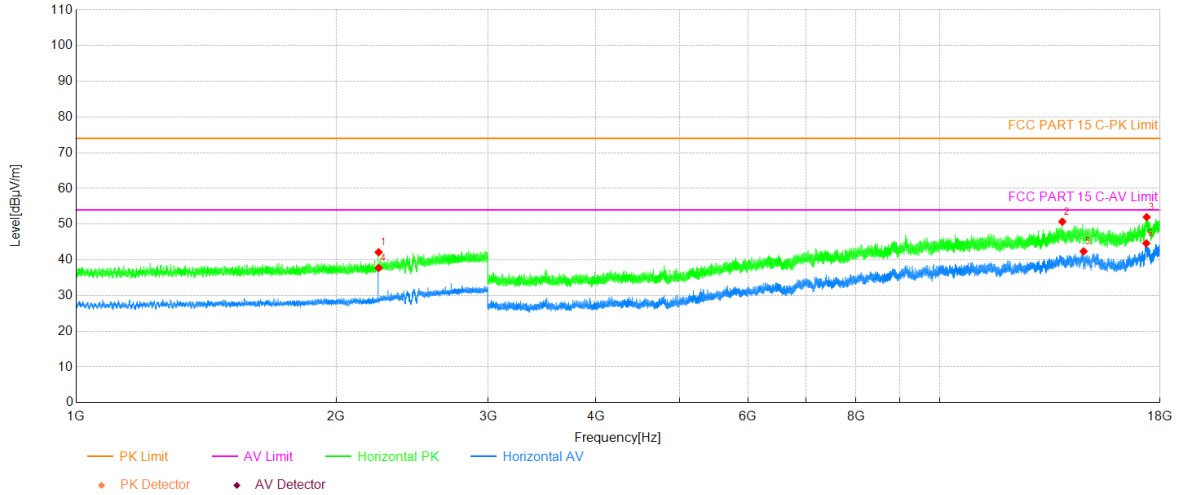

Data List								
NO.	Freq. [MHz]	Reading [dBuV]	Factor [dB]	Level [dBµV/m]	Limit [dBµV/m]	Margin [dB]	Polarity	Verdict
1	2240.20	38.51	3.63	42.14	74.00	31.86	Horizontal	PASS
2	13870.50	42.32	8.38	50.70	74.00	23.30	Horizontal	PASS
3	17371.00	39.94	12.04	51.98	74.00	22.02	Horizontal	PASS
4	2240.20	34.11	3.63	37.74	54.00	16.26	Horizontal	PASS
5	14681.00	33.33	9.06	42.39	54.00	11.61	Horizontal	PASS
6	17353.50	31.92	12.72	44.64	54.00	9.36	Horizontal	PASS

Project Information			
Mode:	802.11n20	Band:	/
Bandwidth	20MHz	Channel	11
IMEI:	869267078787790	Engineer:	申状
Remark:	Polarity: Z		
Test Standard: FCC PART 15 C			

### Test Graph

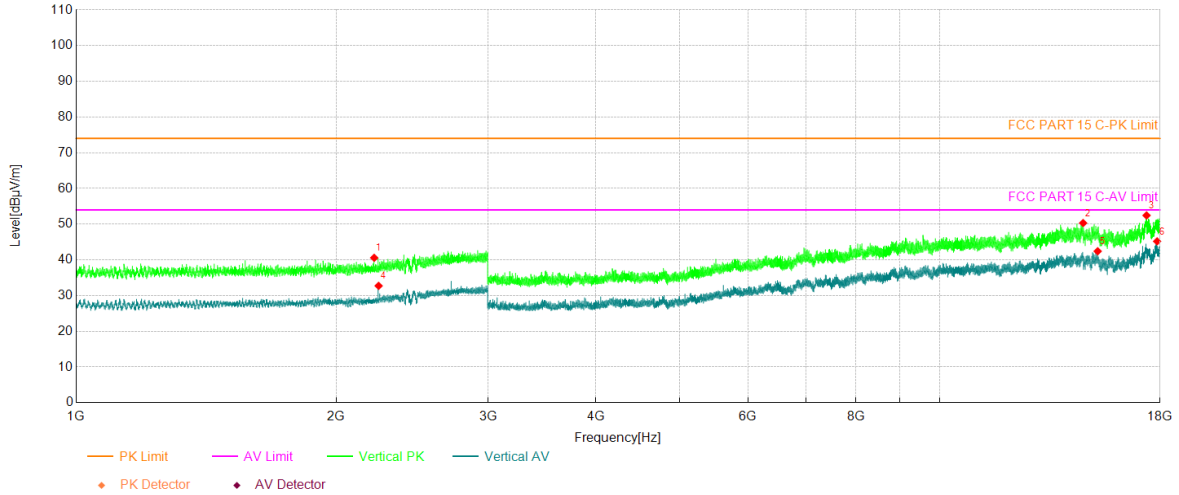

Data List								
NO.	Freq. [MHz]	Reading [dBuV]	Factor [dB]	Level [dBµV/m]	Limit [dBµV/m]	Margin [dB]	Polarity	Verdict
1	2214.00	37.33	3.25	40.58	74.00	33.42	Vertical	PASS
2	14662.50	40.75	9.57	50.32	74.00	23.68	Vertical	PASS
3	17363.50	40.12	12.33	52.45	74.00	21.55	Vertical	PASS
4	2240.20	29.10	3.63	32.73	54.00	21.27	Vertical	PASS
5	15242.00	33.26	9.16	42.42	54.00	11.58	Vertical	PASS
6	17860.00	32.51	12.68	45.19	54.00	8.81	Vertical	PASS

## Radiated Band Edge Test Result

Project Information			
Mode:	802.11b	Band:	/
Bandwidth	20MHz	Channel	1
IMEI:	869267078787790	Engineer:	申状
Remark:	Polarity: X		
Test Standard: FCC PART 15 C			

### Test Graph

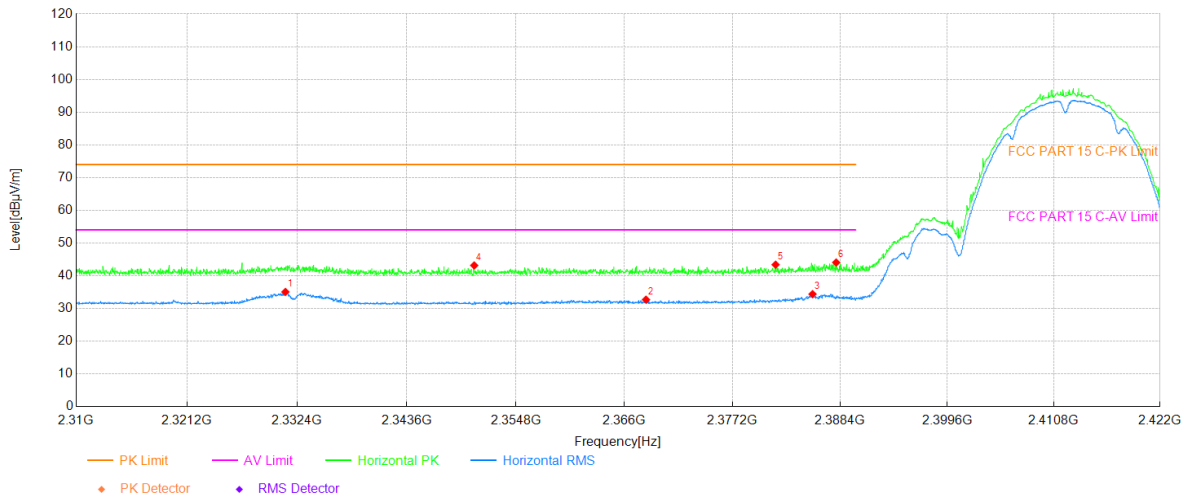

### Data List

NO.	Freq. [MHz]	Reading [dBµV]	Factor [dB]	Level [dBµV/m]	Limit [dBµV/m]	Margin [dB]	Polarity	Verdict
1	2331.21	31.78	3.29	35.07	54.00	18.93	Horizontal	PASS
2	2368.22	29.39	3.31	32.70	54.00	21.30	Horizontal	PASS
3	2385.51	31.01	3.38	34.39	54.00	19.61	Horizontal	PASS
4	2350.52	39.93	3.23	43.16	74.00	30.84	Horizontal	PASS
5	2381.67	40.03	3.36	43.39	74.00	30.61	Horizontal	PASS
6	2387.98	40.67	3.39	44.06	74.00	29.94	Horizontal	PASS

Project Information			
Mode:	802.11b	Band:	/
Bandwidth	20MHz	Channel	1
IMEI:	869267078787790	Engineer:	申状
Remark:	Polarity: X		
Test Standard: FCC PART 15 C			

### Test Graph

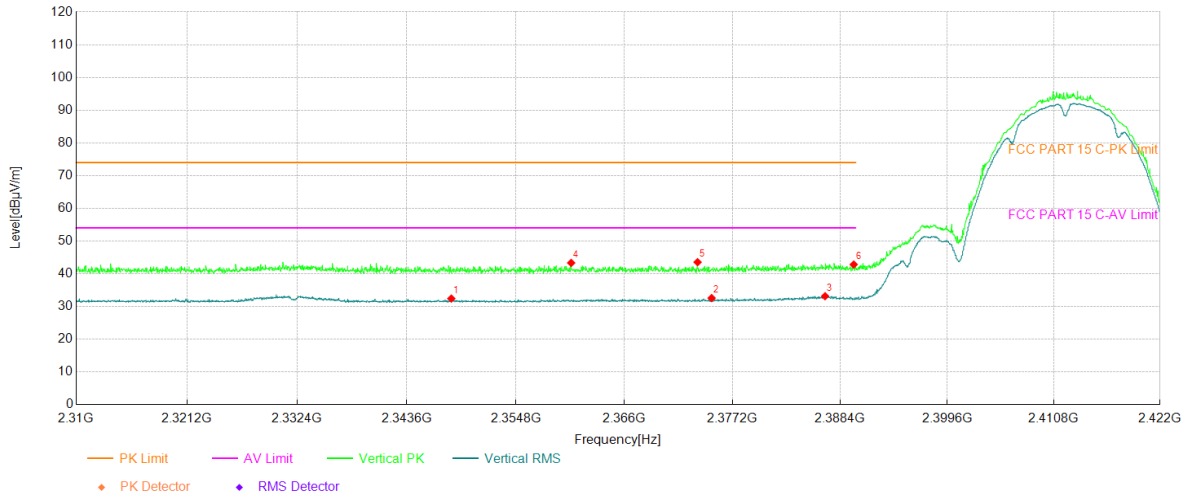

Data List								
NO.	Freq. [MHz]	Reading [dBuV]	Factor [dB]	Level [dBµV/m]	Limit [dBµV/m]	Margin [dB]	Polarity	Verdict
1	2348.17	29.19	3.24	32.43	54.00	21.57	Vertical	PASS
2	2375.02	29.23	3.34	32.57	54.00	21.43	Vertical	PASS
3	2386.82	29.77	3.38	33.15	54.00	20.85	Vertical	PASS
4	2360.49	40.05	3.27	43.32	74.00	30.68	Vertical	PASS
5	2373.56	40.21	3.33	43.54	74.00	30.46	Vertical	PASS
6	2389.81	39.43	3.40	42.83	74.00	31.17	Vertical	PASS

Project Information			
Mode:	802.11b	Band:	/
Bandwidth	20MHz	Channel	1
IMEI:	869267078787790	Engineer:	申状
Remark:	Polarity: Z		
Test Standard: FCC PART 15 C			

### Test Graph

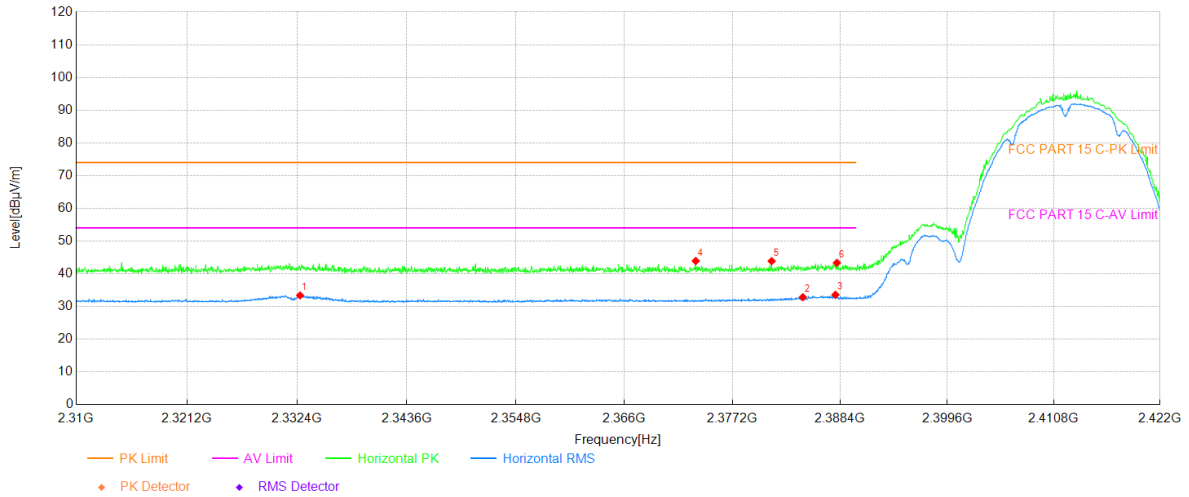

Data List								
NO.	Freq. [MHz]	Reading [dBuV]	Factor [dB]	Level [dBμV/m]	Limit [dBμV/m]	Margin [dB]	Polarity	Verdict
1	2332.71	30.10	3.29	33.39	54.00	20.61	Horizontal	PASS
2	2384.50	29.46	3.38	32.84	54.00	21.16	Horizontal	PASS
3	2387.90	30.19	3.39	33.58	54.00	20.42	Horizontal	PASS
4	2373.38	40.58	3.33	43.91	74.00	30.09	Horizontal	PASS
5	2381.26	40.51	3.36	43.87	74.00	30.13	Horizontal	PASS
6	2388.05	39.96	3.39	43.35	74.00	30.65	Horizontal	PASS

Project Information			
Mode:	802.11b	Band:	/
Bandwidth	20MHz	Channel	1
IMEI:	869267078787790	Engineer:	申状
Remark:	Polarity: Z		
Test Standard: FCC PART 15 C			

### Test Graph

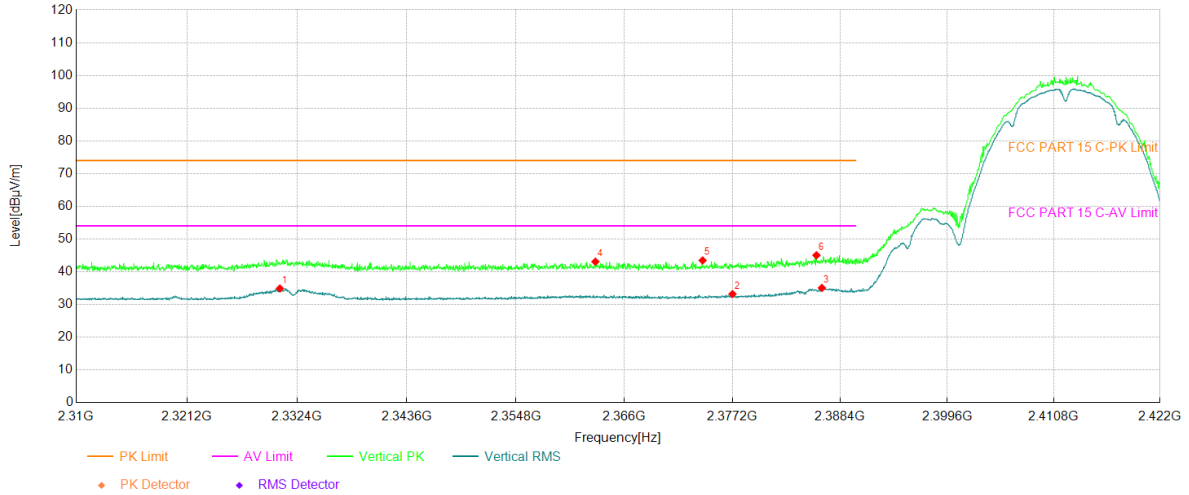

Data List								
NO.	Freq. [MHz]	Reading [dBuV]	Factor [dB]	Level [dBµV/m]	Limit [dBµV/m]	Margin [dB]	Polarity	Verdict
1	2330.65	31.61	3.29	34.90	54.00	19.10	Vertical	PASS
2	2377.19	29.85	3.34	33.19	54.00	20.81	Vertical	PASS
3	2386.48	31.68	3.38	35.06	54.00	18.94	Vertical	PASS
4	2362.99	39.80	3.29	43.09	74.00	30.91	Vertical	PASS
5	2374.09	40.14	3.33	43.47	74.00	30.53	Vertical	PASS
6	2385.92	41.66	3.38	45.04	74.00	28.96	Vertical	PASS

Project Information			
Mode:	802.11b	Band:	/
Bandwidth	20MHz	Channel	11
IMEI:	869267078787790	Engineer:	申状
Remark:	Polarity: Z		
Test Standard: FCC Part 15C			

### Test Graph

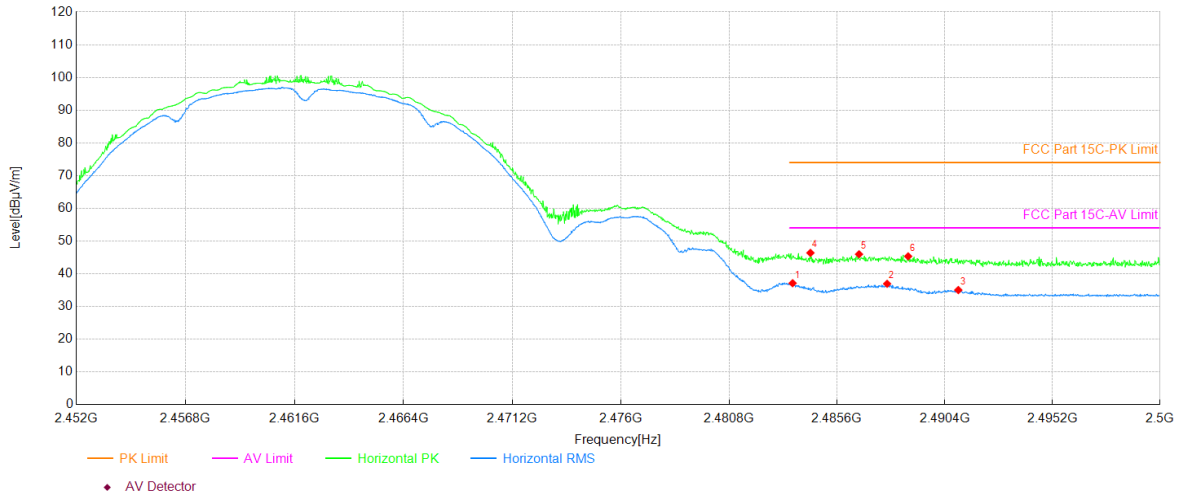

Data List								
NO.	Freq. [MHz]	Reading [dBuV]	Factor [dB]	Level [dBμV/m]	Limit [dBμV/m]	Margin [dB]	Polarity	Verdict
1	2483.62	32.87	4.25	37.12	54.00	16.88	Horizontal	PASS
2	2487.83	32.68	4.27	36.95	54.00	17.05	Horizontal	PASS
3	2491.00	30.75	4.28	35.03	54.00	18.97	Horizontal	PASS
4	2484.42	42.12	4.26	46.38	74.00	27.62	Horizontal	PASS
5	2486.58	41.70	4.27	45.97	74.00	28.03	Horizontal	PASS
6	2488.76	41.05	4.28	45.33	74.00	28.67	Horizontal	PASS



Project Information			
Mode:	802.11b	Band:	/
Bandwidth	20MHz	Channel	11
IMEI:	869267078787790	Engineer:	申状
Remark:	Polarity: Z		
Test Standard: FCC Part 15C			

### Test Graph

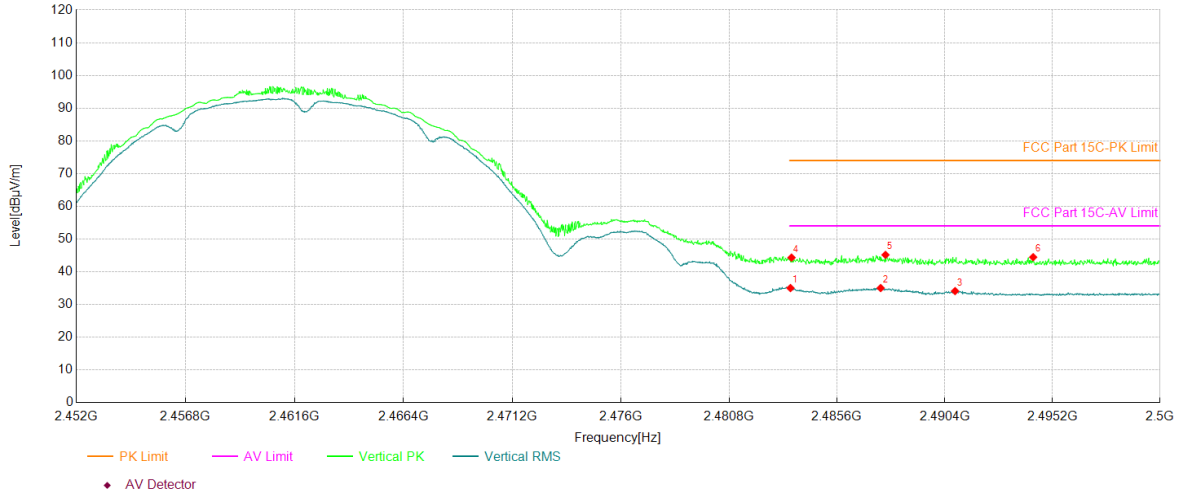

Data List								
NO.	Freq. [MHz]	Reading [dBuV]	Factor [dB]	Level [dBµV/m]	Limit [dBµV/m]	Margin [dB]	Polarity	Verdict
1	2483.53	30.78	4.25	35.03	54.00	18.97	Vertical	PASS
2	2487.54	30.75	4.27	35.02	54.00	18.98	Vertical	PASS
3	2490.85	29.83	4.28	34.11	54.00	19.89	Vertical	PASS
4	2483.58	40.07	4.25	44.32	74.00	29.68	Vertical	PASS
5	2487.75	40.90	4.27	45.17	74.00	28.83	Vertical	PASS
6	2494.33	40.17	4.30	44.47	74.00	29.53	Vertical	PASS

Project Information			
Mode:	802.11g	Band:	/
Bandwidth	20MHz	Channel	1
IMEI:	869267078787790	Engineer:	申状
Remark:	Polarity: Z		
Test Standard: FCC PART 15 C			

### Test Graph

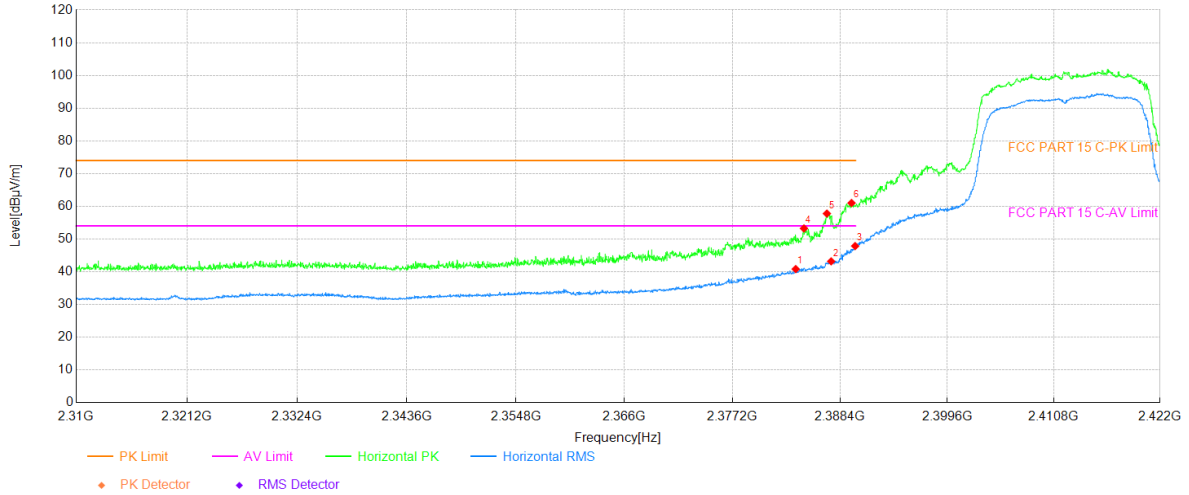

Data List								
NO.	Freq. [MHz]	Reading [dBuV]	Factor [dB]	Level [dBµV/m]	Limit [dBµV/m]	Margin [dB]	Polarity	Verdict
1	2383.76	37.46	3.37	40.83	54.00	13.17	Horizontal	PASS
2	2387.46	39.81	3.38	43.19	54.00	10.81	Horizontal	PASS
3	2389.96	44.46	3.40	47.86	54.00	6.14	Horizontal	PASS
4	2384.62	49.87	3.38	53.25	74.00	20.75	Horizontal	PASS
5	2387.01	54.41	3.38	57.79	74.00	16.21	Horizontal	PASS
6	2389.58	57.61	3.40	61.01	74.00	12.99	Horizontal	PASS

Project Information			
Mode:	802.11g	Band:	/
Bandwidth	20MHz	Channel	1
IMEI:	869267078787790	Engineer:	申状
Remark:	Polarity: Z		
Test Standard: FCC PART 15 C			

### Test Graph

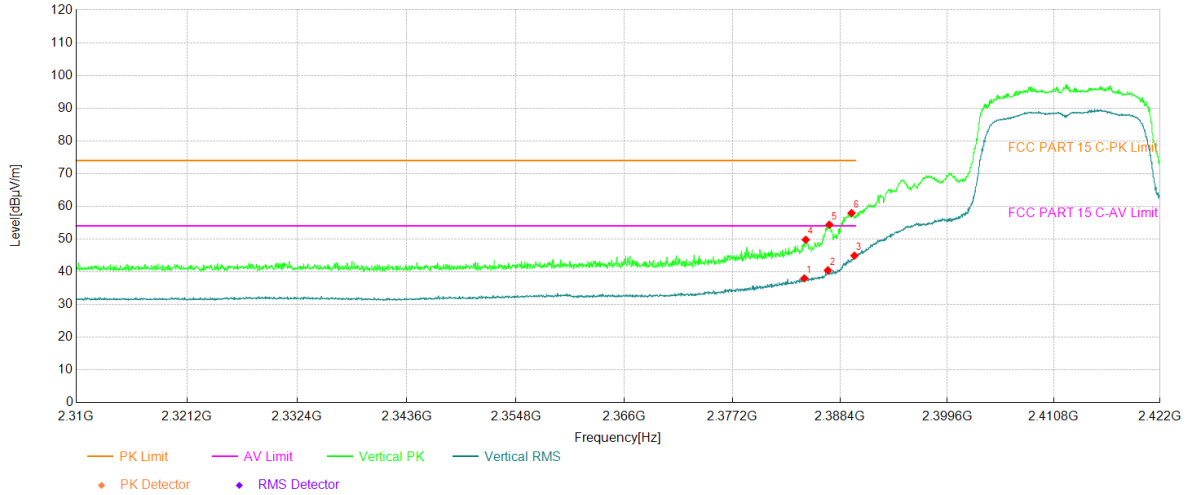

Data List								
NO.	Freq. [MHz]	Reading [dBuV]	Factor [dB]	Level [dBµV/m]	Limit [dBµV/m]	Margin [dB]	Polarity	Verdict
1	2384.65	34.61	3.38	37.99	54.00	16.01	Vertical	PASS
2	2387.12	37.08	3.38	40.46	54.00	13.54	Vertical	PASS
3	2389.88	41.53	3.40	44.93	54.00	9.07	Vertical	PASS
4	2384.80	46.41	3.38	49.79	74.00	24.21	Vertical	PASS
5	2387.27	51.01	3.38	54.39	74.00	19.61	Vertical	PASS
6	2389.58	54.54	3.40	57.94	74.00	16.06	Vertical	PASS

Project Information			
Mode:	802.11g	Band:	/
Bandwidth	20MHz	Channel	11
IMEI:	869267078787790	Engineer:	申状
Remark:	Polarity: Z		
Test Standard: FCC Part 15C			

### Test Graph

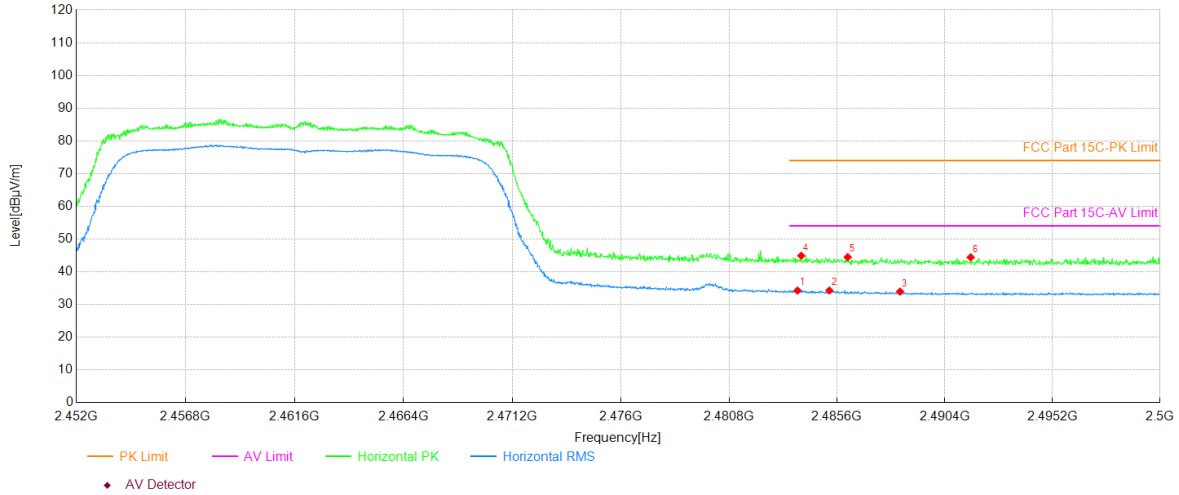

Data List								
NO.	Freq. [MHz]	Reading [dBuV]	Factor [dB]	Level [dBµV/m]	Limit [dBµV/m]	Margin [dB]	Polarity	Verdict
1	2483.84	30.00	4.26	34.26	54.00	19.74	Horizontal	PASS
2	2485.26	30.03	4.26	34.29	54.00	19.71	Horizontal	PASS
3	2488.40	29.68	4.27	33.95	54.00	20.05	Horizontal	PASS
4	2484.01	40.65	4.26	44.91	74.00	29.09	Horizontal	PASS
5	2486.07	40.21	4.26	44.47	74.00	29.53	Horizontal	PASS
6	2491.55	40.13	4.29	44.42	74.00	29.58	Horizontal	PASS

Project Information			
Mode:	802.11g	Band:	/
Bandwidth	20MHz	Channel	11
IMEI:	869267078787790	Engineer:	申状
Remark:	Polarity: Z		
Test Standard: FCC Part 15C			

### Test Graph

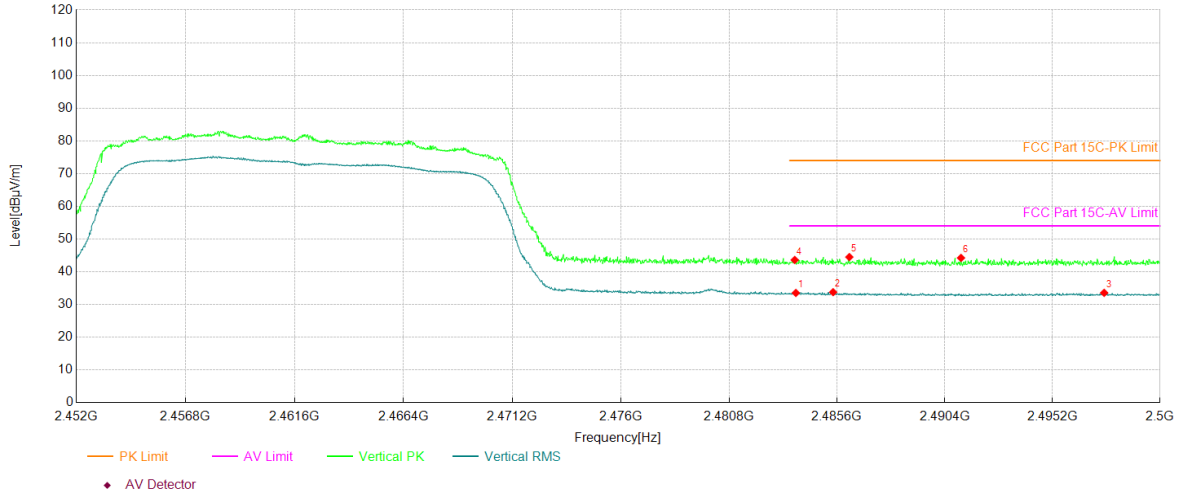

Data List								
NO.	Freq. [MHz]	Reading [dBuV]	Factor [dB]	Level [dBµV/m]	Limit [dBµV/m]	Margin [dB]	Polarity	Verdict
1	2483.77	29.28	4.26	33.54	54.00	20.46	Vertical	PASS
2	2485.42	29.51	4.26	33.77	54.00	20.23	Vertical	PASS
3	2497.50	29.25	4.31	33.56	54.00	20.44	Vertical	PASS
4	2483.72	39.36	4.25	43.61	74.00	30.39	Vertical	PASS
5	2486.15	40.24	4.26	44.50	74.00	29.50	Vertical	PASS
6	2491.12	39.96	4.28	44.24	74.00	29.76	Vertical	PASS

Project Information			
Mode:	802.11n20	Band:	/
Bandwidth	20MHz	Channel	1
IMEI:	869267078787790	Engineer:	申状
Remark:	Polarity: Z		
Test Standard: FCC PART 15 C			

### Test Graph

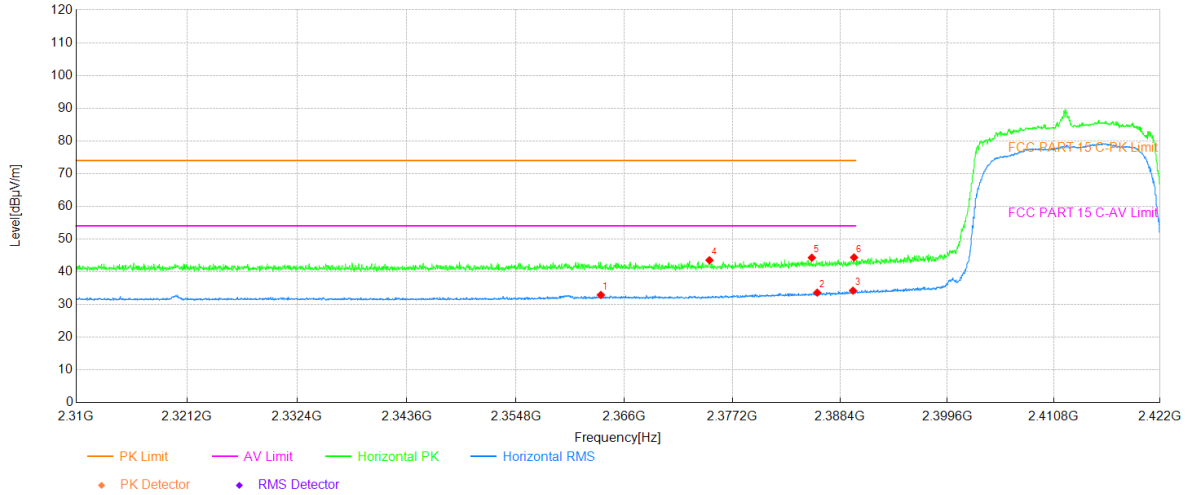

Data List								
NO.	Freq. [MHz]	Reading [dBuV]	Factor [dB]	Level [dBμV/m]	Limit [dBμV/m]	Margin [dB]	Polarity	Verdict
1	2363.55	29.62	3.29	32.91	54.00	21.09	Horizontal	PASS
2	2386.00	30.24	3.38	33.62	54.00	20.38	Horizontal	PASS
3	2389.73	30.83	3.40	34.23	54.00	19.77	Horizontal	PASS
4	2374.79	40.20	3.33	43.53	74.00	30.47	Horizontal	PASS
5	2385.44	40.92	3.38	44.30	74.00	29.70	Horizontal	PASS
6	2389.85	40.98	3.40	44.38	74.00	29.62	Horizontal	PASS

Project Information			
Mode:	802.11n20	Band:	/
Bandwidth	20MHz	Channel	1
IMEI:	869267078787790	Engineer:	申状
Remark:	Polarity: Z		
Test Standard: FCC PART 15 C			

### Test Graph

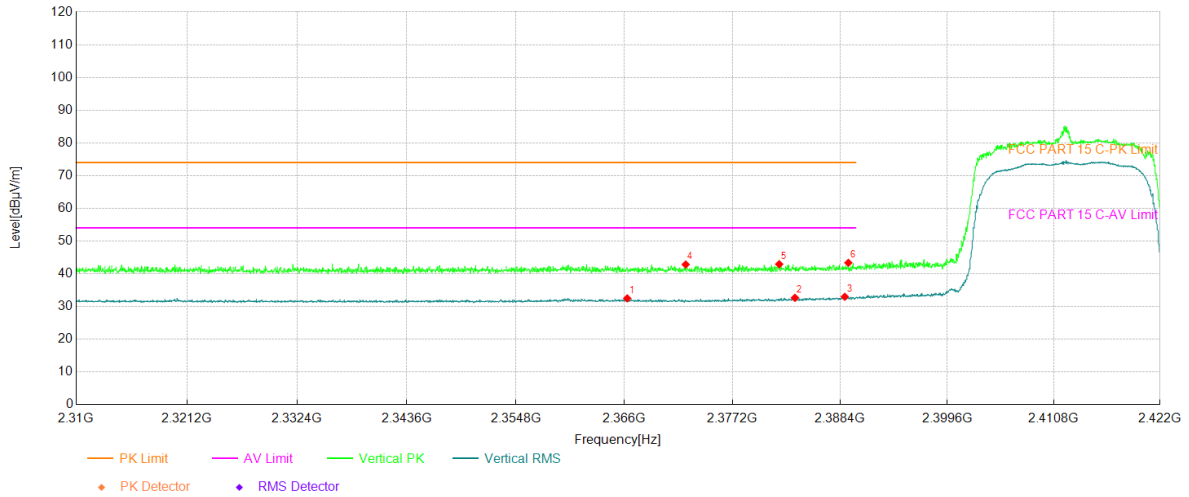

Data List								
NO.	Freq. [MHz]	Reading [dBuV]	Factor [dB]	Level [dBµV/m]	Limit [dBµV/m]	Margin [dB]	Polarity	Verdict
1	2366.28	29.19	3.30	32.49	54.00	21.51	Vertical	PASS
2	2383.68	29.28	3.37	32.65	54.00	21.35	Vertical	PASS
3	2388.87	29.57	3.40	32.97	54.00	21.03	Vertical	PASS
4	2372.33	39.52	3.32	42.84	74.00	31.16	Vertical	PASS
5	2382.04	39.56	3.36	42.92	74.00	31.08	Vertical	PASS
6	2389.25	39.95	3.40	43.35	74.00	30.65	Vertical	PASS

Project Information			
Mode:	802.11n20	Band:	/
Bandwidth	20MHz	Channel	11
IMEI:	869267078787790	Engineer:	申状
Remark:	Polarity: Z		
Test Standard: FCC Part 15C			

### Test Graph

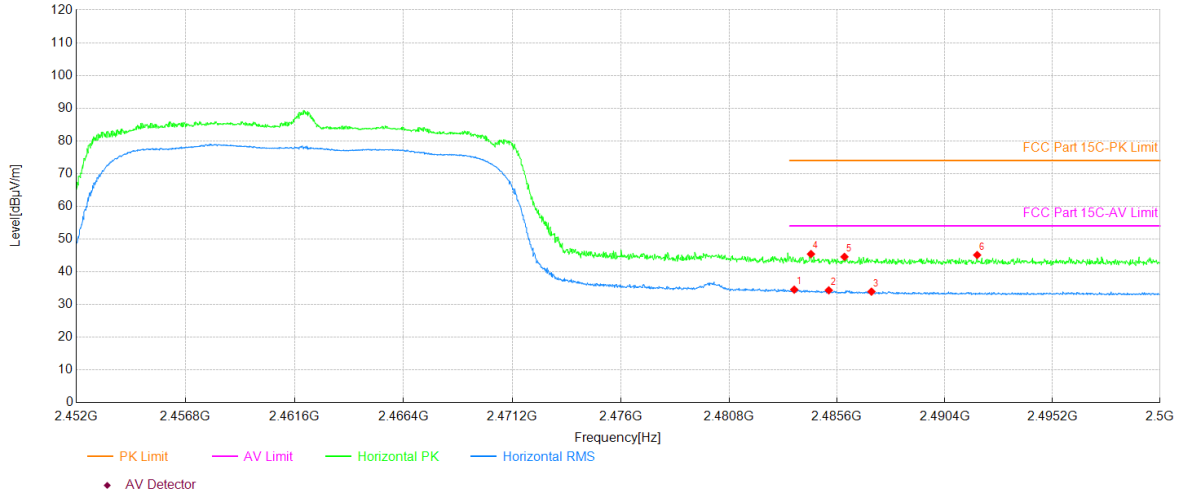

Data List								
NO.	Freq. [MHz]	Reading [dBuV]	Factor [dB]	Level [dBµV/m]	Limit [dBµV/m]	Margin [dB]	Polarity	Verdict
1	2483.70	30.29	4.25	34.54	54.00	19.46	Horizontal	PASS
2	2485.23	30.07	4.26	34.33	54.00	19.67	Horizontal	PASS
3	2487.13	29.66	4.27	33.93	54.00	20.07	Horizontal	PASS
4	2484.44	41.16	4.26	45.42	74.00	28.58	Horizontal	PASS
5	2485.93	40.31	4.26	44.57	74.00	29.43	Horizontal	PASS
6	2491.84	40.83	4.29	45.12	74.00	28.88	Horizontal	PASS



Project Information			
Mode:	802.11n20	Band:	/
Bandwidth	20MHz	Channel	11
IMEI:	869267078787790	Engineer:	申状
Remark:	Polarity: Z		
Test Standard: FCC Part 15C			

### Test Graph

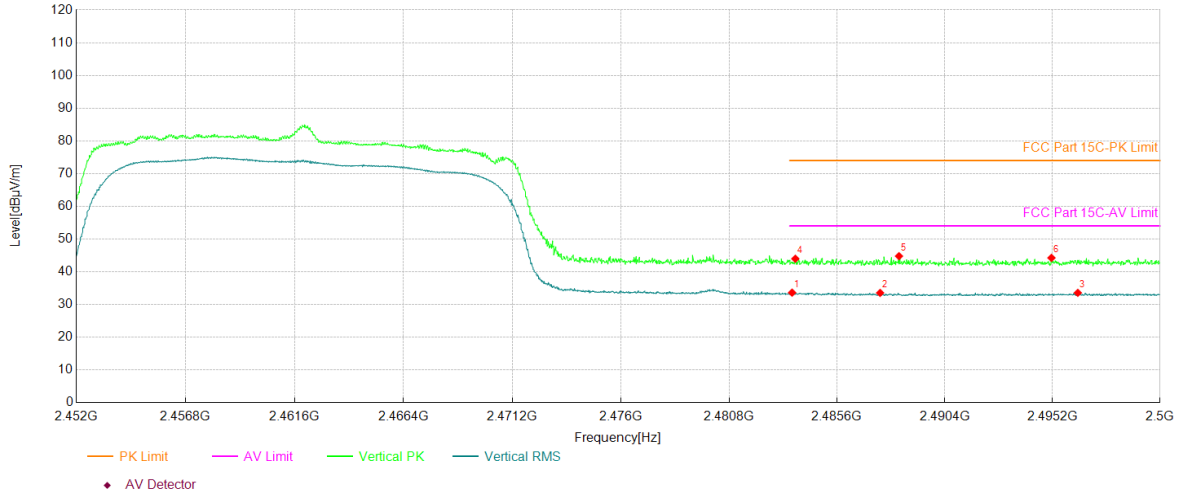

Data List								
NO.	Freq. [MHz]	Reading [dBuV]	Factor [dB]	Level [dBµV/m]	Limit [dBµV/m]	Margin [dB]	Polarity	Verdict
1	2483.60	29.37	4.25	33.62	54.00	20.38	Vertical	PASS
2	2487.51	29.27	4.27	33.54	54.00	20.46	Vertical	PASS
3	2496.33	29.25	4.31	33.56	54.00	20.44	Vertical	PASS
4	2483.74	39.73	4.25	43.98	74.00	30.02	Vertical	PASS
5	2488.35	40.52	4.27	44.79	74.00	29.21	Vertical	PASS
6	2495.15	39.95	4.30	44.25	74.00	29.75	Vertical	PASS

~The End~