

FCC Radio Test Report

FCC ID: XMR20211108FC41D

This report concerns: Original Grant

Project No. : 2111H032
Equipment : Stand-alone Wi-Fi&Bluetooth module
Brand Name : Quectel
Test Model : FC41D
Series Model : N/A
Applicant : Quectel Wireless Solutions Co., Ltd
Address : Building 5, Shanghai Business Park Phase III (Area B), No.1016 Tianlin Road, Minhang District, Shanghai, China 200233
Manufacturer : Quectel Wireless Solutions Co., Ltd
Address : Building 5, Shanghai Business Park Phase III (Area B), No.1016 Tianlin Road, Minhang District, Shanghai, China 200233
Factory : N/A
Address : N/A
Date of Receipt : Nov. 25, 2021
Date of Test : Nov. 30, 2021~Jan. 06, 2022
Issued Date : Jan. 18, 2022
Report Version : R00
Test Sample : Engineering Sample No.: SH20211125128 for radiated, SH20211125127 for conducted
Standard(s) : FCC CFR Title 47, Part 15, Subpart C
FCC KDB 558074 D01 15.247 Meas Guidance v05r02
ANSI C63.10-2013

The above equipment has been tested and found compliance with the requirement of the relative standards by BTL Inc.

Antonio Long

Prepared by : Antonio Long

Ryan Wang

Approved by : Ryan Wang



TESTING CERT #5123.03

Add: No. 29, Jintang Road, Tangzhen Industry Park, Pudong New Area, Shanghai 201210, China

TEL: +86-021-61765666

Web: www.newbtl.com

Declaration

BTL represents to the client that testing is done in accordance with standard procedures as applicable and that test instruments used has been calibrated with standards traceable to international standard(s) and/or national standard(s).

BTL's reports apply only to the specific samples tested under conditions. It is manufacture's responsibility to ensure that additional production units of this model are manufactured with the identical electrical and mechanical components. **BTL** shall have no liability for any declarations, inferences or generalizations drawn by the client or others from **BTL** issued reports.

The report must not be used by the client to claim product certification, approval, or endorsement by NVLAP, NIST, A2LA, or any agency of the U.S. Government.

This report is the confidential property of the client. As a mutual protection to the clients, the public and ourselves, the test report shall not be reproduced, except in full, without our written approval.

BTL's laboratory quality assurance procedures are in compliance with the **ISO/IEC 17025** requirements, and accredited by the conformity assessment authorities listed in this test report.

BTL is not responsible for the sampling stage, so the results only apply to the sample as received.

The information, data and test plan are provided by manufacturer which may affect the validity of results, so it is manufacturer's responsibility to ensure that the apparatus meets the essential requirements of applied standards and in all the possible configurations as representative of its intended use.

Limitation

For the use of the authority's logo is limited unless the Test Standard(s)/Scope(s)/Item(s) mentioned in this test report is (are) included in the conformity assessment authorities acceptance respective.

Please note that the measurement uncertainty is provided for informational purpose only and are not use in determining the Pass/Fail results.

Table of Contents	Page
REPORT ISSUED HISTORY	6
1 . SUMMARY OF TEST RESULTS	7
1.1 TEST FACILITY	8
1.2 MEASUREMENT UNCERTAINTY	8
1.3 TEST ENVIRONMENT CONDITIONS	8
2 . GENERAL INFORMATION	9
2.1 GENERAL DESCRIPTION OF EUT	9
2.2 DESCRIPTION OF TEST MODES	11
2.3 PARAMETERS OF TEST SOFTWARE	12
2.4 DUTY CYCLE	13
2.5 BLOCK DIAGRAM SHOWING THE CONFIGURATION OF SYSTEM TESTED	15
2.6 SUPPORT UNITS	15
3 . AC POWER LINE CONDUCTED EMISSIONS	16
3.1 LIMIT	16
3.2 TEST PROCEDURE	16
3.3 DEVIATION FROM TEST STANDARD	16
3.4 TEST SETUP	17
3.5 EUT OPERATION CONDITIONS	17
3.6 TEST RESULTS	17
4 . RADIATED EMISSIONS	18
4.1 LIMIT	18
4.2 TEST PROCEDURE	19
4.3 DEVIATION FROM TEST STANDARD	20
4.4 TEST SETUP	20
4.5 EUT OPERATION CONDITIONS	21
4.6 TEST RESULTS - 9 KHZ TO 30 MHZ	21
4.7 TEST RESULTS - 30 MHZ TO 1000 MHZ	21
4.8 TEST RESULTS - ABOVE 1000 MHZ	21
5 . BANDWIDTH	22
5.1 LIMIT	22
5.2 TEST PROCEDURE	22
5.3 DEVIATION FROM STANDARD	22
5.4 TEST SETUP	22

Table of Contents	Page
5.5 EUT OPERATION CONDITIONS	22
5.6 TEST RESULTS	22
6 . MAXIMUM OUTPUT POWER	23
6.1 LIMIT	23
6.2 TEST PROCEDURE	23
6.3 DEVIATION FROM STANDARD	23
6.4 TEST SETUP	23
6.5 EUT OPERATION CONDITIONS	23
6.6 TEST RESULTS	23
7 . CONDUCTED SPURIOUS EMISSIONS	24
7.1 LIMIT	24
7.2 TEST PROCEDURE	24
7.3 DEVIATION FROM STANDARD	24
7.4 TEST SETUP	24
7.5 EUT OPERATION CONDITIONS	24
7.6 TEST RESULTS	24
8 . POWER SPECTRAL DENSITY	25
8.1 LIMIT	25
8.2 TEST PROCEDURE	25
8.3 DEVIATION FROM STANDARD	25
8.4 TEST SETUP	25
8.5 EUT OPERATION CONDITIONS	25
8.6 TEST RESULTS	25
9 . MEASUREMENT INSTRUMENTS LIST	26
10 . EUT TEST PHOTO	28
APPENDIX A - AC POWER LINE CONDUCTED EMISSIONS	30
APPENDIX B - RADIATED EMISSION - 9 KHZ TO 30 MHZ	31
APPENDIX C - RADIATED EMISSION - 30 MHZ TO 1000 MHZ	32
APPENDIX D - RADIATED EMISSION- ABOVE 1000 MHZ	35
APPENDIX E - BANDWIDTH	72
APPENDIX F - MAXIMUM OUTPUT POWER	76
APPENDIX G - CONDUCTED SPURIOUS EMISSIONS	78

Table of Contents

Page

APPENDIX H - POWER SPECTRAL DENSITY

82

REPORT ISSUED HISTORY

Report Version	Description	Issued Date
R00	Original Issue.	Jan. 18, 2022

1. SUMMARY OF TEST RESULTS

Test procedures according to the technical standard(s):

FCC CFR Title 47, Part 15, Subpart C				
Standard(s) Section	Test Item	Test Result	Judgment	Remark
15.207	AC Power Line Conducted Emissions	APPENDIX A	N/A	-----
15.247(d) 15.205(a) 15.209(a)	Radiated Emissions	APPENDIX B APPENDIX C APPENDIX D	PASS	-----
15.247(a)(2)	Bandwidth	APPENDIX E	PASS	-----
15.247(b)(3)	Maximum Output Power	APPENDIX F	PASS	-----
15.247(d)	Conducted Spurious Emissions	APPENDIX G	PASS	-----
15.247(e)	Power Spectral Density	APPENDIX H	PASS	-----
15.203	Antenna Requirement	-----	PASS	Note(2)

Note:

- (1) "N/A" denotes test is not applicable in this test report.
- (2) The device what use a permanently attached antenna were considered sufficient to comply with the provisions of 15.203.

1.1 TEST FACILITY

The test facilities used to collect the test data in this report is at the location of No. 29, Jintang Road, Tangzhen Industry Park, Pudong New Area, Shanghai 201210, China
 BTL's Test Firm Registration Number for FCC: 476765
 BTL's Designation Number for FCC: CN1241

1.2 MEASUREMENT UNCERTAINTY

ISO/IEC 17025 requires that an estimate of the measurement uncertainties associated with the emissions test results be included in the report. The measurement uncertainties given below are based on a 95% confidence level (based on a coverage factor (k=2))
 The BTL measurement uncertainty as below table:

A. Radiated emissions test:

Test Site	Method	Measurement Frequency Range	Ant. H / V	U, (dB)
SH-CB02	CISPR	9 KHz~30 MHz	-	2.16
		30 MHz~200 MHz	V	4.04
		30 MHz~200 MHz	H	2.90
		200 MHz~1,000 MHz	V	3.76
		200 MHz~1,000 MHz	H	3.82
		1GHz ~ 6GHz	-	4.56
		6GHz ~ 18GHz	-	4.14
		18 ~ 26.5 GHz	-	3.48

B. Conducted test:

Parameter	U
Output Power	±0.95 dB
Occupied Channel Bandwidth	±3.8 %
Power Spectral Density	±0.86 dB
Conducted Spurious Emission	±2.71 dB
Temperature	±0.08 °C
Humidity	±1.5 %
Supply voltages	±0.3 %

Note: Unless specifically mentioned, the uncertainty of measurement has not been taken into account to declare the compliance or non-compliance to the specification.

1.3 TEST ENVIRONMENT CONDITIONS

Test Item	Temperature	Humidity	Test Voltage	Tested By
Radiated Emissions-30MHz to 1000MHz	19°C	47%	DC 3.3V	Forest Li
Radiated Emissions-Above 1000MHz	19°C	47%	DC 3.3V	Forest Li
Bandwidth	20°C	52%	DC 3.3V	Danny Dang
Maximum Output Power	20°C	52%	DC 3.3V	Danny Dang
Conducted Spurious Emissions	20°C	52%	DC 3.3V	Danny Dang
Power Spectral Density	20°C	52%	DC 3.3V	Danny Dang

2. GENERAL INFORMATION

2.1 GENERAL DESCRIPTION OF EUT

Equipment	Stand-alone Wi-Fi&Bluetooth module
Brand Name	Quectel
Test Model	FC41D
Series Model	N/A
Model Difference(s)	N/A
Software Version	N/A
Hardware Version	R1.0
Power Source	DC power supply.
Power Rating	DC 3.3V
Operation Frequency	2412 MHz ~ 2462 MHz
Modulation Type	IEEE 802.11b: DSSS IEEE 802.11g: OFDM IEEE 802.11n: OFDM
Bit Rate of Transmitter	IEEE 802.11b: 11/5.5/2/1 Mbps IEEE 802.11g: 54/48/36/24/18/12/9/6 Mbps IEEE 802.11n: up to 72.2 Mbps
Maximum Output Power	IEEE 802.11g: 23.35 dBm (0.2163 W)

Note:

1. For a more detailed features description, please refer to the manufacturer's specifications or the user's manual.

2. Channel List:

CH01 - CH11 for IEEE 802.11b, IEEE 802.11g, IEEE 802.11n(HT20)							
Channel	Frequency (MHz)	Channel	Frequency (MHz)	Channel	Frequency (MHz)	Channel	Frequency (MHz)
01	2412	04	2427	07	2442	10	2457
02	2417	05	2432	08	2447	11	2462
03	2422	06	2437	09	2452		

3. Antenna Specification:

Ant.	Brand	Model Name	Antenna Type	Connector	Gain (dBi)
1	N/A	N/A	PCB	N/A	2

Note:

- 1) The antenna gain is provided by the manufacturer.

2.2 DESCRIPTION OF TEST MODES

The test system was pre-tested based on the consideration of all possible combinations of EUT operation mode.

Pretest Mode	Description
Mode 1	TX B Mode Channel 01/06/11
Mode 2	TX G Mode Channel 01/06/11
Mode 3	TX N(HT20) Mode Channel 01/06/11
Mode 4	TX G Mode Channel 11

Following mode(s) was (were) found to be the worst case(s) and selected for the final test.

Radiated emissions test - Below 1GHz	
Final Test Mode	Description
Mode 4	TX G Mode Channel 11

Radiated emissions test- Above 1GHz	
Final Test Mode	Description
Mode 1	TX B Mode Channel 01/06/11
Mode 2	TX G Mode Channel 01/06/11
Mode 3	TX N(HT20) Mode Channel 01/06/11

Conducted test	
Final Test Mode	Description
Mode 1	TX B Mode Channel 01/06/11
Mode 2	TX G Mode Channel 01/06/11
Mode 3	TX N(HT20) Mode Channel 01/06/11

NOTE:

- (1) All the bit rate of transmitter have been tested and found the lowest rate is found to be the worst case and recorded.
- (2) For radiated emission below 1 GHz test, the TX G Mode Channel 11 is found to be the worst case and recorded.

2.3 PARAMETERS OF TEST SOFTWARE

Test Software Version	QCOM_V1.6		
Frequency (MHz)	2412	2437	2462
IEEE 802.11b	Auto	Auto	Auto
IEEE 802.11g	Auto	Auto	Auto
IEEE 802.11n(HT20)	Auto	Auto	Auto

2.4 DUTY CYCLE

If duty cycle is $\geq 98\%$, duty factor is not required.
 If duty cycle is $< 98\%$, duty factor shall be considered.
 The output power = measured power + duty factor.

IEEE 802.11b

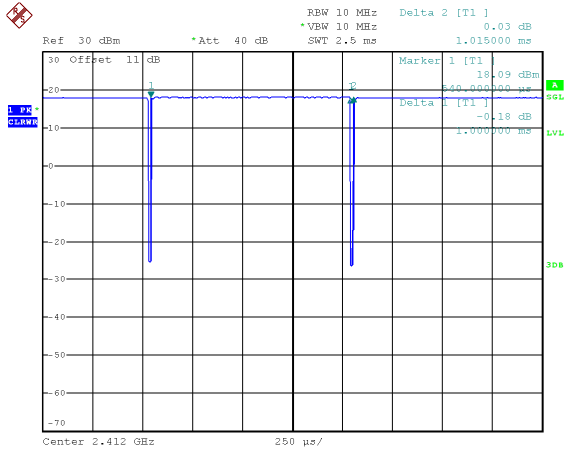

Date: 1.DEC.2021 17:14:49

Duty cycle = $1.000 \text{ ms} / 1.015 \text{ ms} = 98.52\%$
 Duty Factor = $10 \log(1/\text{Duty cycle}) = 0.0647$

IEEE 802.11g

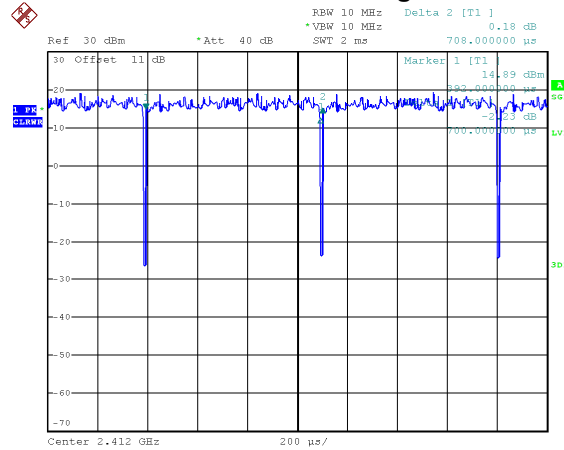

Date: 1.DEC.2021 17:19:56

Duty cycle = $0.700 \text{ ms} / 0.708 \text{ ms} = 98.87\%$
 Duty Factor = $10 \log(1/\text{Duty cycle}) = 0.0494$

IEEE 802.11n(HT20)

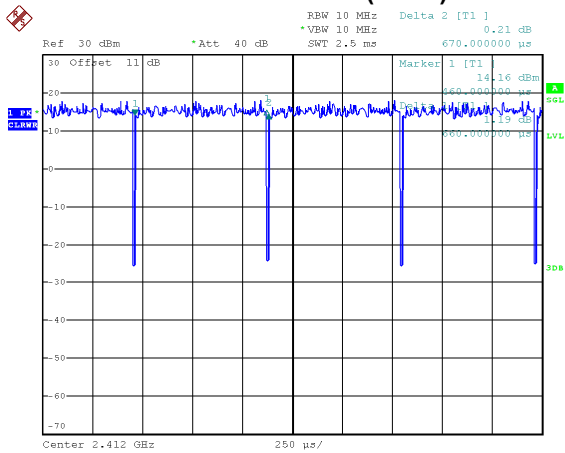

Date: 1.DEC.2021 17:21:32

Duty cycle = $0.660 \text{ ms} / 0.670 \text{ ms} = 98.51\%$
 Duty Factor = $10 \log(1/\text{Duty cycle}) = 0.0653$

NOTE:

For IEEE 802.11b:

For radiated emissions frequency above 1 GHz, the resolution bandwidth of test receiver/spectrum analyzer is 1 MHz and the video bandwidth is 10 Hz.

For IEEE 802.11g:

For radiated emissions frequency above 1 GHz, the resolution bandwidth of test receiver/spectrum analyzer is 1 MHz and the video bandwidth is 10 Hz.

For IEEE 802.11n(HT20):

For radiated emissions frequency above 1 GHz, the resolution bandwidth of test receiver/spectrum analyzer is 1 MHz and the video bandwidth is 10 Hz.

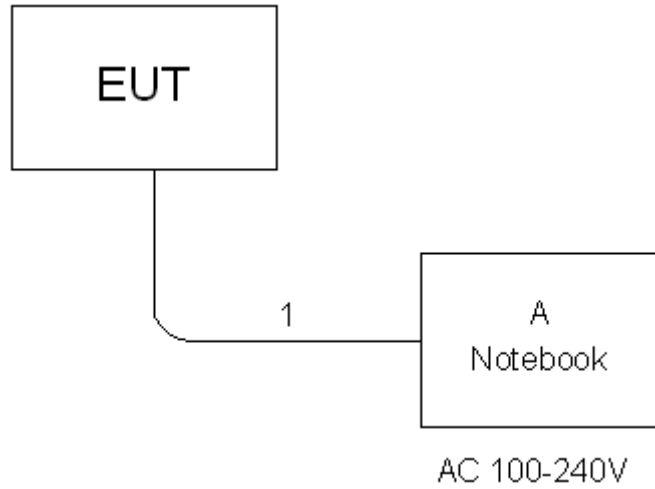
2.5 BLOCK DIAGRAM SHOWING THE CONFIGURATION OF SYSTEM TESTED**2.6 SUPPORT UNITS**

Item	Equipment	Brand	Model/Type No.	Series No.
A	Notebook	Lenovo	V130-14IKB001	N/A

Item	Cable Type	Shielded Type	Ferrite Core	Length
1	USB	N/A	N/A	1m

3. AC POWER LINE CONDUCTED EMISSIONS

3.1 LIMIT

Frequency of Emission (MHz)	Limit (dB μ V)	
	Quasi-peak	Average
0.15 - 0.5	66 to 56*	56 to 46*
0.5 - 5.0	56	46
5.0 - 30.0	60	50

NOTE:

- (1) The tighter limit applies at the band edges.
- (2) The limit of "*" marked band means the limitation decreases linearly with the logarithm of the frequency in the range.

3.2 TEST PROCEDURE

- a. The EUT was placed 0.8 meters from the horizontal ground plane with EUT being connected to the power mains through a line impedance stabilization network (LISN). All other support equipment powered from additional LISN(s). The LISN provide 50 Ohm/ 50uH of coupling impedance for the measuring instrument.
- b. Interconnecting cables that hang closer than 40 cm to the ground plane shall be folded back and forth in the center forming a bundle 30 to 40 cm long.
- c. I/O cables that are not connected to a peripheral shall be bundled in the center. The end of the cable may be terminated, if required, using the correct terminating impedance. The overall length shall not exceed 1 m.
- d. LISN at least 80 cm from nearest part of EUT chassis.
- e. For the actual test configuration, please refer to the related Item -EUT Test Photos.

The following table is the setting of the receiver:

Receiver Parameters	Setting
Start Frequency	0.15 MHz
Stop Frequency	30 MHz
IF Bandwidth	9 kHz

3.3 DEVIATION FROM TEST STANDARD

No deviation.

3.4 TEST SETUP

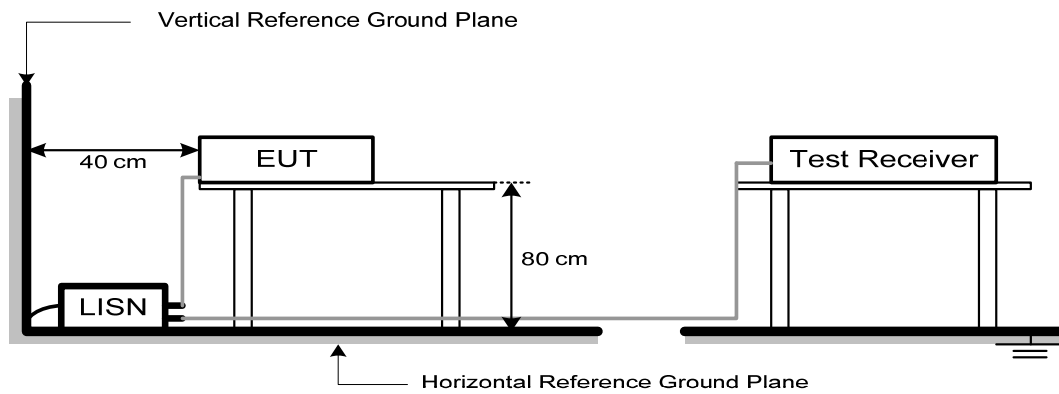

3.5 EUT OPERATION CONDITIONS

EUT was programmed to be in continuously transmitting mode.

3.6 TEST RESULTS

Please refer to the APPENDIX A.

4. RADIATED EMISSIONS

4.1 LIMIT

In case the emission fall within the restricted band specified on 15.205(a), then the 15.209(a) limit in the table below has to be followed.

LIMITS OF RADIATED EMISSION MEASUREMENT (9 kHz-1000 MHz)

Frequency (MHz)	Field Strength (microvolts/meter)	Measurement Distance (meters)
0.009-0.490	2400/F(kHz)	300
0.490-1.705	24000/F(kHz)	30
1.705-30.0	30	30
30-88	100	3
88-216	150	3
216-960	200	3
Above 960	500	3

LIMITS OF RADIATED EMISSION MEASUREMENT (Above 1000 MHz)

Frequency (MHz)	(dBuV/m at 3 m)	
	Peak	Average
Above 1000	74	54

NOTE:

- (1) The limit for radiated test was performed according to FCC CFR Title 47, Part 15, Subpart C.
- (2) The tighter limit applies at the band edges.
- (3) Emission level (dBuV/m)=20log Emission level (uV/m).

4.2 TEST PROCEDURE

- a. The measuring distance of 3 m shall be used for measurements. The EUT was placed on the top of a rotating table 0.8 meter above the ground at a 3 meter semi-anechoic chamber. The table was rotated 360 degrees to determine the position of the highest radiation.(below 1 GHz)
- b. The measuring distance of 3 m shall be used for measurements. The EUT was placed on the top of a rotating table 1.5 meter above the ground at a 3 meter semi-anechoic chamber. The table was rotated 360 degrees to determine the position of the highest radiation.(above 1 GHz)
- c. The height of the equipment or of the substitution antenna shall be 0.8m or 1.5m; the height of the test antenna shall vary between 1 m to 4 m. Both horizontal and vertical polarizations of the antenna are set to make the measurement.
- d. For each suspected emission, the EUT was arranged to its worst case and then the antenna was tuned to heights find the maximum reading (used Bore sight function).
- e. The receiver system was set to peak and average detect function and specified bandwidth with maximum hold mode when the test frequency is above 1 GHz.
- f. The initial step in collecting radiated emission data is a receiver peak detector mode pre-scanning the measurement frequency range. Significant peaks are then marked and then Quasi Peak detector mode re-measured.
- g. All readings are Peak unless otherwise stated QP in column of Note. Peak denotes that the Peak reading compliance with the QP Limits and then QP Mode measurement didn't perform.
(below 1 GHz)
- h. All readings are Peak Mode value unless otherwise stated AVG in column of Note. If the Peak Mode Measured value compliance with the Peak Limits and lower than AVG Limits, the EUT shall be deemed to meet both Peak & AVG Limits and then only Peak Mode was measured, but AVG Mode didn't perform. (above 1 GHz)
- i. For the actual test configuration, please refer to the related Item -EUT Test Photos.

The following table is the setting of the receiver:

Spectrum Parameters	Setting
Start ~ Stop Frequency	9 kHz~150 kHz for RBW 200 Hz
Start ~ Stop Frequency	0.15 MHz~30 MHz for RBW 9 kHz
Start ~ Stop Frequency	30 MHz~1000 MHz for RBW 100 kHz

Spectrum Parameters	Setting
Start Frequency	1000 MHz
Stop Frequency	10th carrier harmonic
RBW / VBW (Emission in restricted band)	1 MHz / 3 MHz for PK value 1 MHz / 1/T Hz for AVG value

Receiver Parameters	Setting
Start ~ Stop Frequency	9 kHz~90 kHz for PK/AVG detector
Start ~ Stop Frequency	90 kHz~110 kHz for QP detector
Start ~ Stop Frequency	110 kHz~490 kHz for PK/AVG detector
Start ~ Stop Frequency	490 kHz~30 MHz for QP detector
Start ~ Stop Frequency	30 MHz~1000 MHz for QP detector
Start ~ Stop Frequency	1 GHz~26.5 GHz for PK/AVG detector

4.3 DEVIATION FROM TEST STANDARD

No deviation.

4.4 TEST SETUP

9 kHz to 30 MHz

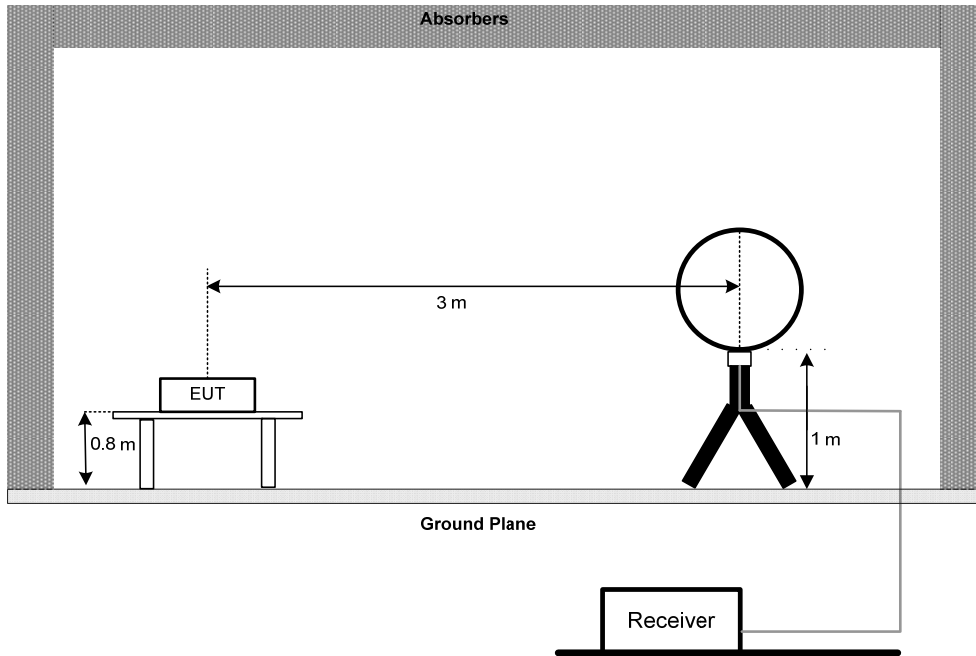

30 MHz to 1 GHz

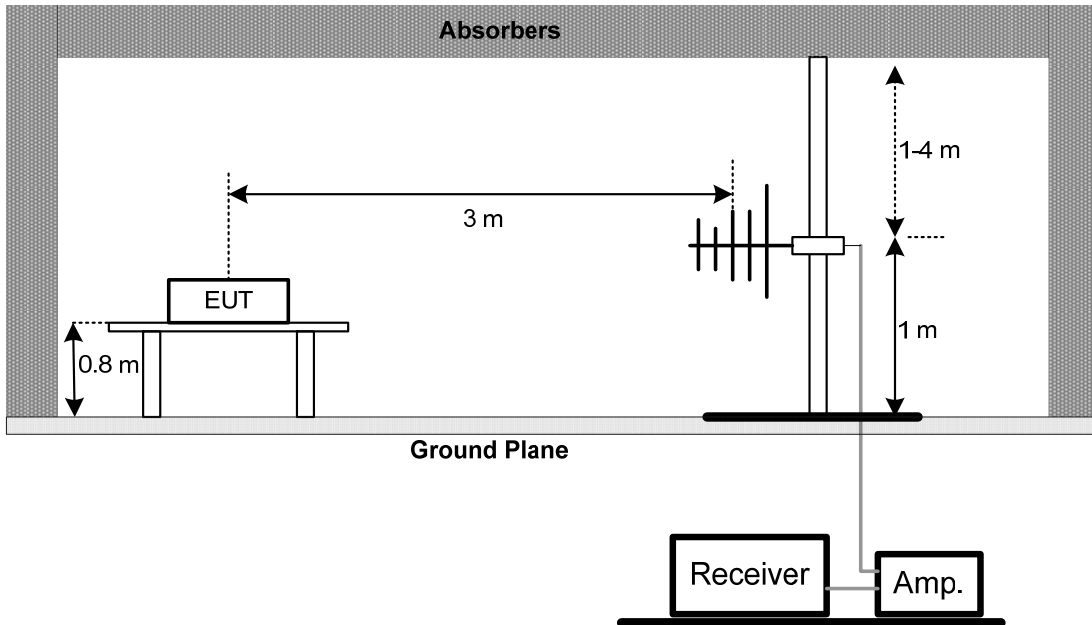

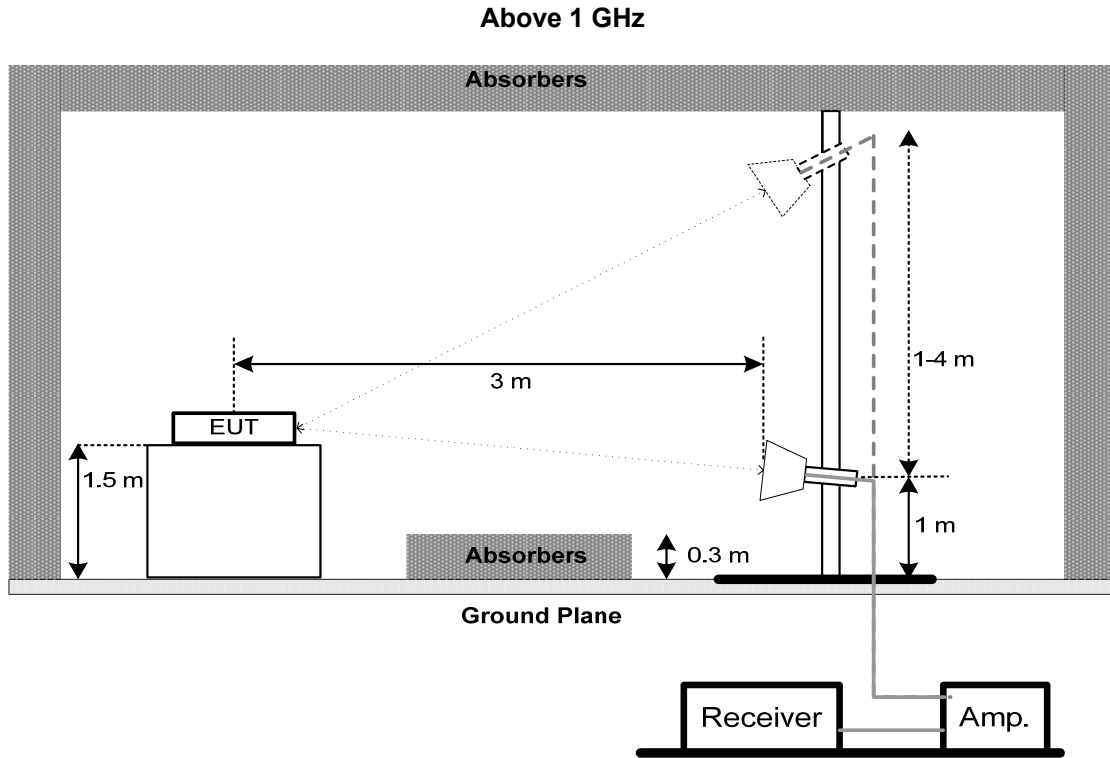

4.5 EUT OPERATION CONDITIONS

The EUT was programmed to be in continuously transmitting mode.

4.6 TEST RESULTS - 9 KHZ TO 30 MHZ

Please refer to the APPENDIX B.

Remark:

- (1) Distance extrapolation factor = $40 \log (\text{specific distance} / \text{test distance})$ (dB).
- (2) Limit line = specific limits (dBuV) + distance extrapolation factor.

4.7 TEST RESULTS - 30 MHZ TO 1000 MHZ

Please refer to the APPENDIX C.

4.8 TEST RESULTS - ABOVE 1000 MHZ

Please refer to the APPENDIX D.

Remark:

- (1) No limit: This is fundamental signal, the judgment is not applicable.
For fundamental signal judgment was referred to Peak output test.

5. BANDWIDTH

5.1 LIMIT

Section	Test Item	Limit
FCC 15.247(a)(2)	6 dB Bandwidth	Minimum 500 kHz
	99% Emission Bandwidth	-

5.2 TEST PROCEDURE

- The EUT was directly connected to the spectrum analyzer and antenna output port as show in the block diagram below.
- The following table is the setting of the spectrum analyzer:

For 6 dB Bandwidth:

Spectrum Parameters	Setting
Span Frequency	> Measurement Bandwidth
RBW	100 kHz
VBW	300 kHz
Detector	Peak
Trace	Max Hold
Sweep Time	Auto

For 99% Emission Bandwidth:

Spectrum Parameters	Setting
Span Frequency	Between 1.5 times and 5.0 times the OBW
RBW	300 kHz For 20MHz 1 MHz For 40MHz
VBW	1 MHz For 20MHz 3 MHz For 40MHz
Detector	Peak
Trace	Max Hold
Sweep Time	Auto

5.3 DEVIATION FROM STANDARD

No deviation.

5.4 TEST SETUP



5.5 EUT OPERATION CONDITIONS

The EUT was programmed to be in continuously transmitting mode.

5.6 TEST RESULTS

Please refer to the APPENDIX E.

6. MAXIMUM OUTPUT POWER

6.1 LIMIT

Section	Test Item	Limit
FCC 15.247(b)(3)	Maximum Output Power	1.0000 Watt or 30.00 dBm

6.2 TEST PROCEDURE

- The EUT was directly connected to the power meter and antenna output port as show in the block diagram below.
- The maximum conducted output power was performed in accordance with method 11.9.2.3.1 (for AVG power) of ANSI C63.10-2013.

6.3 DEVIATION FROM STANDARD

No deviation.

6.4 TEST SETUP

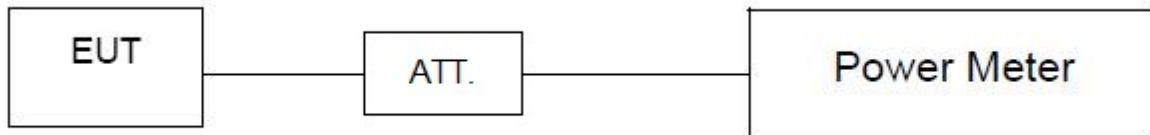

6.5 EUT OPERATION CONDITIONS

The EUT was programmed to be in continuously transmitting mode.

6.6 TEST RESULTS

Please refer to the APPENDIX F.

7. CONDUCTED SPURIOUS EMISSIONS

7.1 LIMIT

In any 100 kHz bandwidth outside the frequency band in which the spread spectrum or digitally modulated intentional radiator is operating, the radio frequency power that is produced by the intentional radiator shall be at least 20 dB below that in the 100 kHz bandwidth within the band that contains the highest level of the desired power, based on either an RF conducted or a radiated measurement, provided the transmitter demonstrates compliance with the peak Output Power limits. If the transmitter complies with the Output Power limits based on the use of RMS averaging over a time interval, as permitted under paragraph (b)(3) of this section, the attenuation required under this paragraph shall be 30 dB instead of 20 dB. Attenuation below the general limits specified in Section 15.209(a) is not required.

7.2 TEST PROCEDURE

- a. The EUT was directly connected to the spectrum analyzer and antenna output port as show in the block diagram below.
- b. The following table is the setting of the spectrum analyzer:

Spectrum Parameters	Setting
Start Frequency	30 MHz
Stop Frequency	26.5 GHz
RBW	100 kHz
VBW	300 kHz
Detector	Peak
Trace	Max Hold
Sweep Time	Auto

7.3 DEVIATION FROM STANDARD

No deviation.

7.4 TEST SETUP



7.5 EUT OPERATION CONDITIONS

The EUT was programmed to be in continuously transmitting mode.

7.6 TEST RESULTS

Please refer to the APPENDIX G.

8. POWER SPECTRAL DENSITY

8.1 LIMIT

Section	Test Item	Limit
FCC 15.247(e)	Power Spectral Density	8 dBm (in any 3 kHz)

8.2 TEST PROCEDURE

- a. The EUT was directly connected to the spectrum analyzer and antenna output port as show in the block diagram below.
- b. The following table is the setting of the spectrum analyzer:

Spectrum Parameters	Setting
Span Frequency	25 MHz (20 MHz) / 60 MHz (40 MHz)
RBW	3 kHz
VBW	10 kHz
Detector	Peak
Trace	Max Hold
Sweep Time	Auto

8.3 DEVIATION FROM STANDARD

No deviation.

8.4 TEST SETUP



8.5 EUT OPERATION CONDITIONS

The EUT was programmed to be in continuously transmitting mode.

8.6 TEST RESULTS

Please refer to the APPENDIX H.

9. MEASUREMENT INSTRUMENTS LIST

Radiated Emissions - 9 kHz to 30 MHz					
Item	Kind of Equipment	Manufacturer	Type No.	Serial No.	Calibrated until
1	Loop Antenna	EMCI	EMCI LPA600	275	May. 20, 2022
2	MXE EMI Receiver	Keysight	N9038A	MY56400088	Mar. 21, 2022
3	Measurement Software	Farad	EZ-EMC Ver.NB-03A1-01	N/A	N/A

Radiated Emissions - 30 MHz to 1 GHz					
Item	Kind of Equipment	Manufacturer	Type No.	Serial No.	Calibrated until
1	TRILOG Broadband Antenna	Schwarzbeck	VULB 9160	9160-3233	Mar. 26, 2022
2	Pre-Amplifier	emci	EMC9135	980401	Mar. 20, 2022
3	MXE EMI Receiver	Keysight	N9038A	MY56400088	Mar. 21, 2022
4	Test Cable	emci	EMC104-SM-SM-7 000	181020	Apr. 11, 2022
5	Test Cable	emci	EMC104-SM-SM-2 500	170618	Apr. 11, 2022
6	Test Cable	emci	EMC104-SM-SM-8 00	170647	Apr. 11, 2022
7	Measurement Software	Farad	EZ-EMC Ver.NB-03A1-01	N/A	N/A

Radiated Emissions - Above 1 GHz					
Item	Kind of Equipment	Manufacturer	Type No.	Serial No.	Calibrated until
1	Double Ridged Broadband Horn Antenna	Schwarzbeck	BBHA 9120D	9120D-1817	Mar. 26, 2022
2	Pre-Amplifier	emci	EMC051845SE	980725	Aug. 23, 2022
3	EXA Spectrum Analyzer	Keysight	N9010A	MY56480579	Mar. 21, 2022
4	Test Cable	emci	EMC104-SM-SM-7 000	181020	Apr. 11, 2022
5	Test Cable	emci	EMC104-SM-SM-2 500	170618	Apr. 11, 2022
6	Test Cable	emci	EMC104-SM-SM-8 00	170647	Apr. 11, 2022
7	Double-Ridged Waveguide Horn Antenna	ETS-Lindgren	3116C	00203919	May 19, 2022
8	Pre-Amplifier	emci	EMC184045B	980265	Apr. 11, 2022
9	Test Cable	emci	EMC102-SM-SM-8 00	170335	Apr. 11, 2022
10	Test Cable	emci	EMC102-KM-KM-2 500	170627	Apr. 11, 2022
11	MXE EMI Receiver	Keysight	N9038A	MY5640088	Mar. 21, 2022
12	Measurement Software	Farad	EZ-EMC Ver.NB-03A1-01	N/A	N/A
13	Double Ridged Broadband Horn Antenna	Schwarzbeck	BBHA 9120D	9120D-1817	Mar. 26, 2022

Bandwidth					
Item	Kind of Equipment	Manufacturer	Type No.	Serial No.	Calibrated until
1	Spectrum Analyzer	R&S	FSP40	100626	May 29, 2022
2	Attenuator	JUK	ATT-2W6G-S-10	N/A	N/A

Maximum Output Power					
Item	Kind of Equipment	Manufacturer	Type No.	Serial No.	Calibrated until
1	Peak Power Analyze	Keysight	8990B	MY51000507	Mar. 21, 2022
2	Wideband Power Sensor	Keysight	N1923A	MY58310003	Mar. 21, 2022
3	Attenuator	JUK	ATT-2W6G-S-10	N/A	N/A

Antenna Conducted Spurious Emissions					
Item	Kind of Equipment	Manufacturer	Type No.	Serial No.	Calibrated until
1	Spectrum Analyzer	R&S	FSP40	100626	May 29, 2022
2	Attenuator	JUK	ATT-2W6G-S-10	N/A	N/A

Power Spectral Density					
Item	Kind of Equipment	Manufacturer	Type No.	Serial No.	Calibrated until
1	Spectrum Analyzer	R&S	FSP40	100626	May 29, 2022
2	Attenuator	JUK	ATT-2W6G-S-10	N/A	N/A

Remark: "N/A" denotes no model name, serial no. or calibration specified.

All calibration period of equipment list is one year.

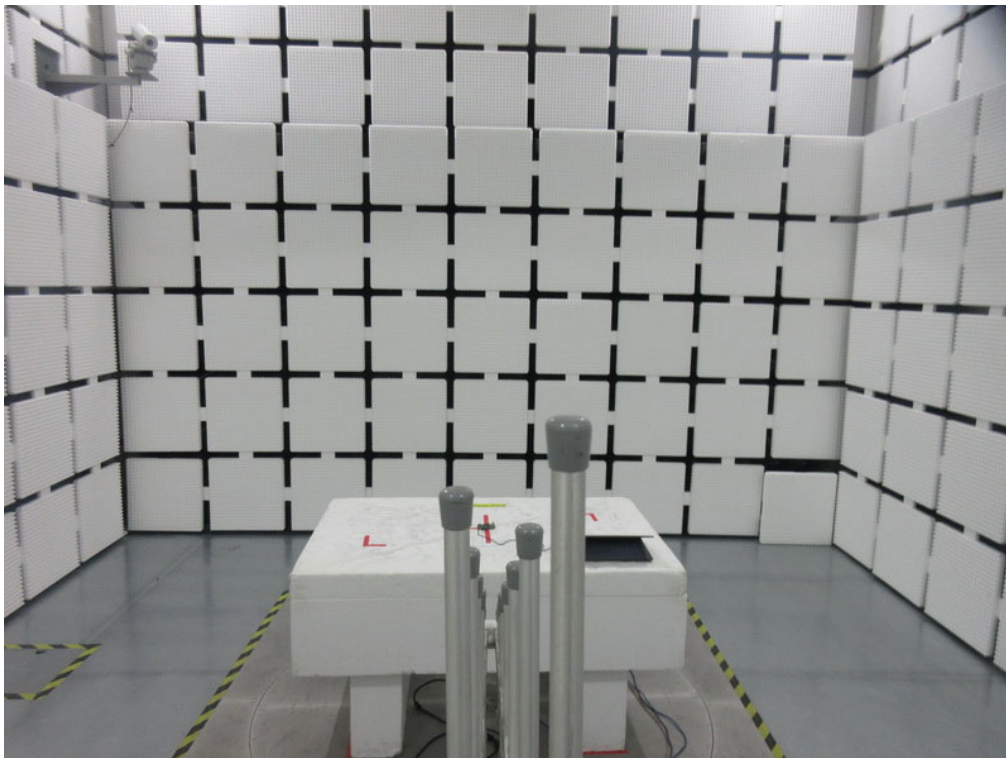
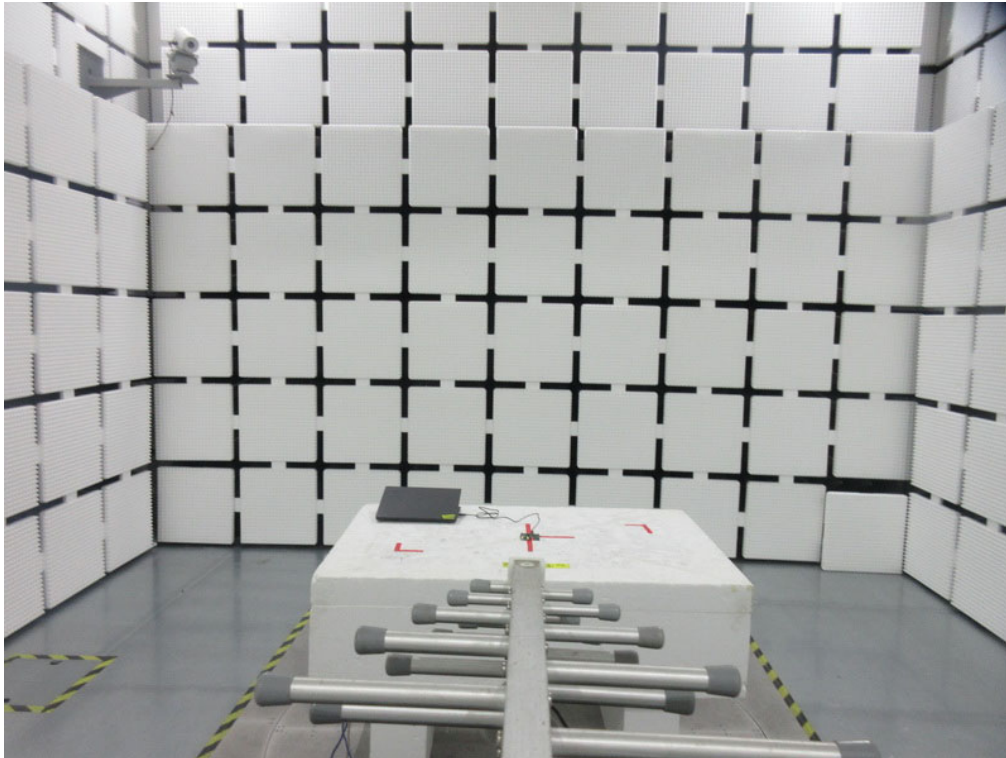
10. EUT TEST PHOTO**Radiated Emissions Test Photos****30 MHz to 1 GHz**

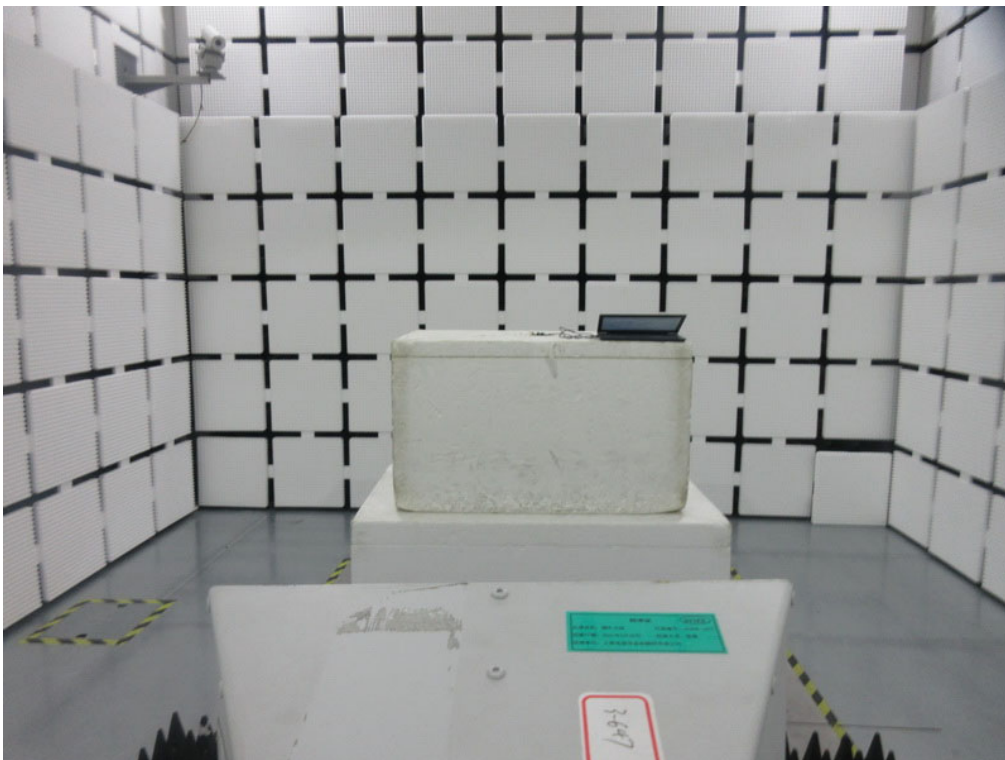
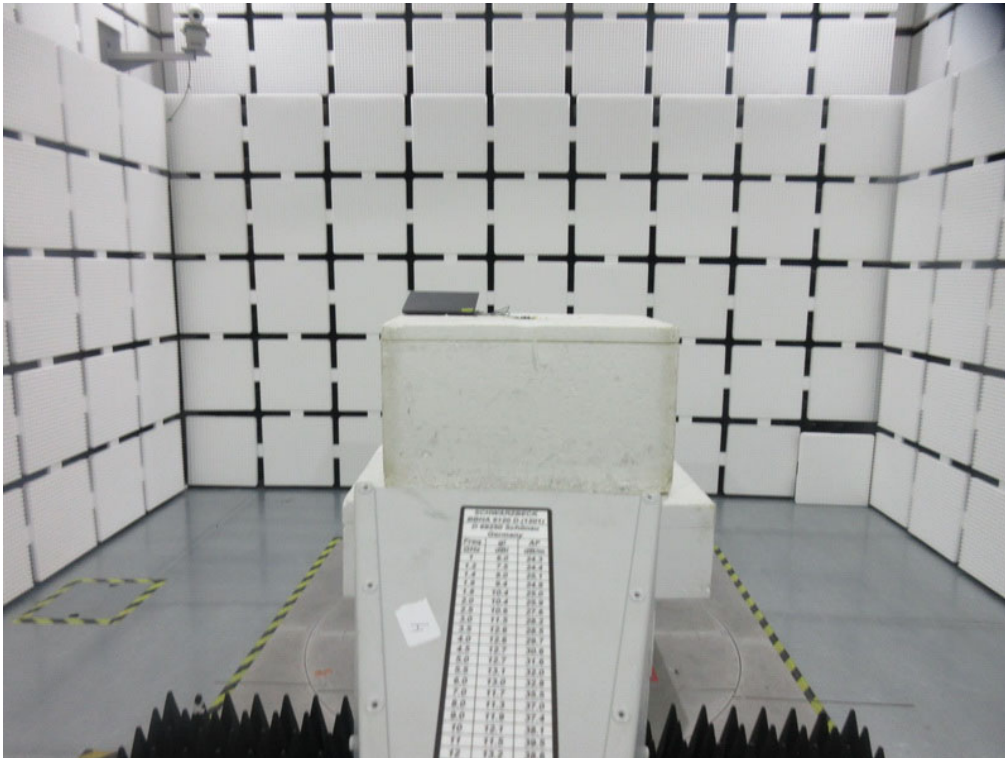
Radiated Emissions Test Photos**Above 1 GHz**

APPENDIX A - AC POWER LINE CONDUCTED EMISSIONS

Note: The EUT is DC power supply, so this item is not applicable.

APPENDIX B - RADIATED EMISSION - 9 KHZ TO 30 MHZ

Note: The measured value have enough margin over 20dB than the limit, therefore they are not reported.

APPENDIX C - RADIATED EMISSION - 30 MHZ TO 1000 MHZ

Test Mode	TX G Mode Channel 11	Polarization	Vertical
-----------	----------------------	--------------	----------

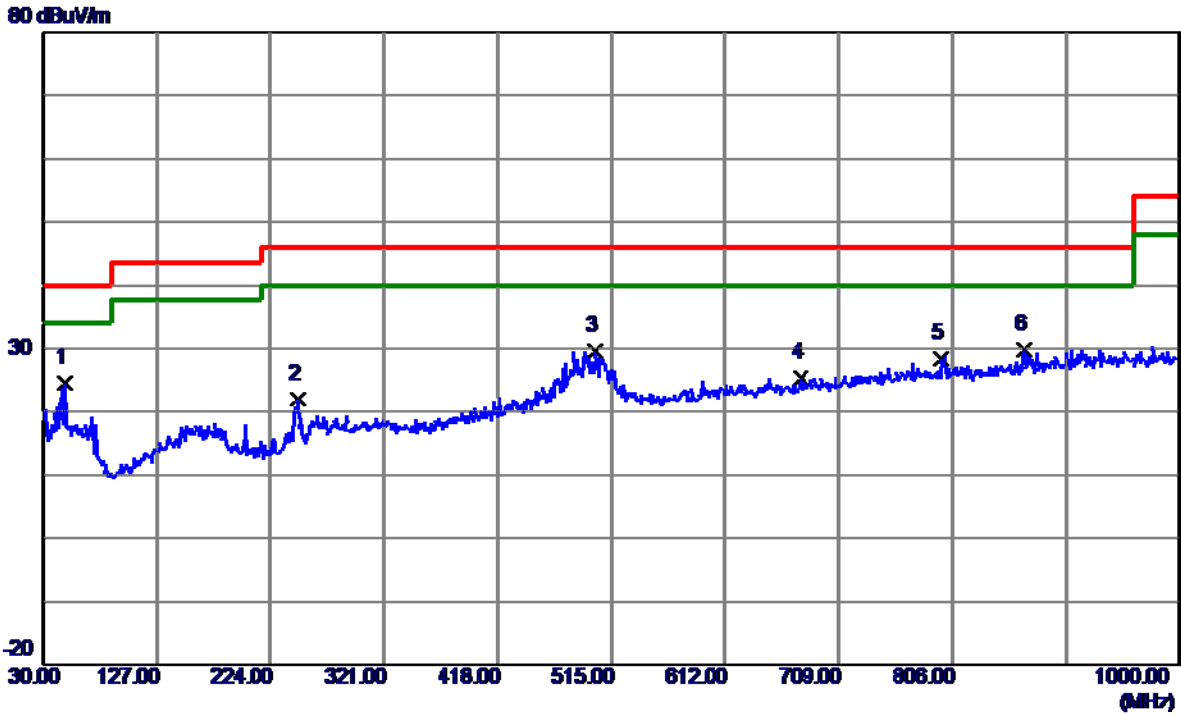

No.	Freq. MHz	Reading Level dBuV/m	Correct Factor dB	Measure ment dBuV/m	Limit dBuV/m	Margin dB	Detector	Comment
1 *	48.4300	41.43	-16.80	24.63	40.00	-15.37	Peak	
2	247.7650	39.39	-17.44	21.95	46.00	-24.05	Peak	
3	500.9350	40.83	-11.20	29.63	46.00	-16.37	Peak	
4	676.5050	33.77	-8.29	25.48	46.00	-20.52	Peak	
5	796.7849	34.91	-6.56	28.35	46.00	-17.65	Peak	
6	867.5950	36.06	-6.20	29.86	46.00	-16.14	Peak	

REMARKS:

(1) Measurement Value = Reading Level + Correct Factor.

(2) Margin Level = Measurement Value - Limit Value.

Test Mode	TX G Mode Channel 11	Polarization	Horizontal
-----------	----------------------	--------------	------------

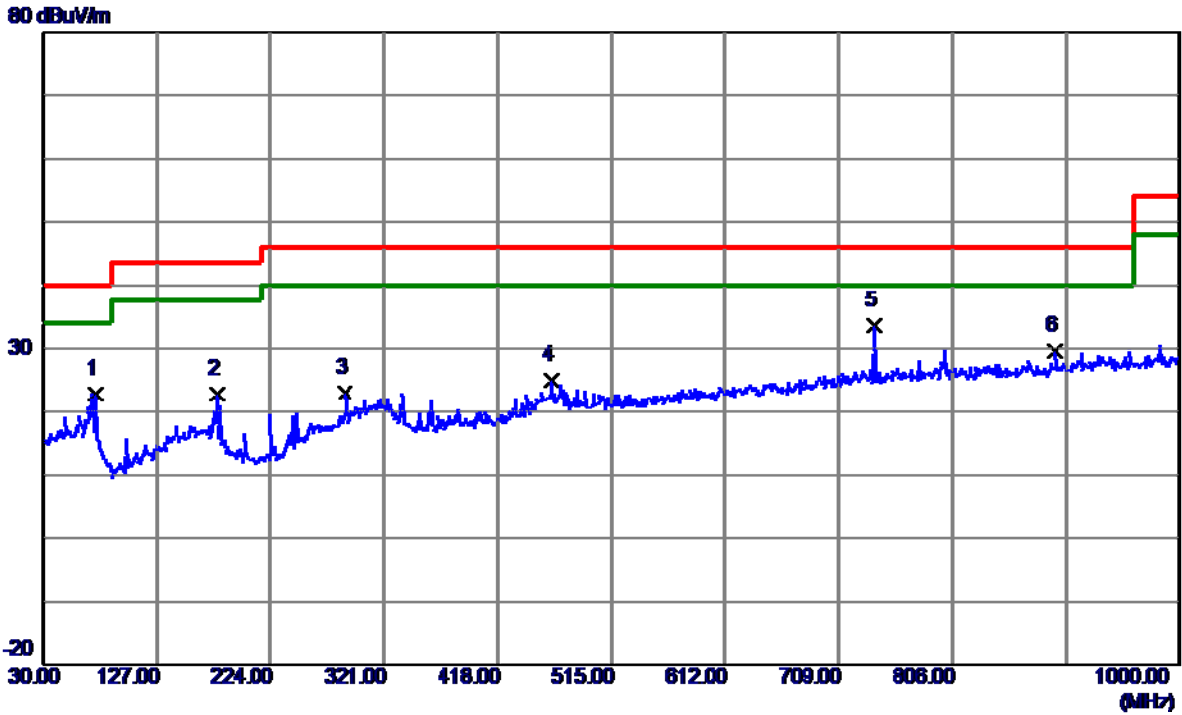

No.	Freq. MHz	Reading Level dBuV/m	Correct Factor dB	Measure ment dBuV/m	Limit dBuV/m	Margin dB	Detector	Comment
1	75.5899	42.73	-19.84	22.89	40.00	-17.11	Peak	
2	178.8950	39.91	-17.20	22.71	43.50	-20.79	Peak	
3	288.0200	38.94	-15.91	23.03	46.00	-22.97	Peak	
4	464.0750	36.65	-11.67	24.98	46.00	-21.02	Peak	
5 *	739.5550	40.98	-7.32	33.66	46.00	-12.34	Peak	
6	893.7850	35.53	-5.99	29.54	46.00	-16.46	Peak	

REMARKS:

- (1) Measurement Value = Reading Level + Correct Factor.
- (2) Margin Level = Measurement Value - Limit Value.

APPENDIX D - RADIATED EMISSION- ABOVE 1000 MHZ

Test Mode	TX B Mode 2412 MHz	Polarization	Vertical
-----------	--------------------	--------------	----------

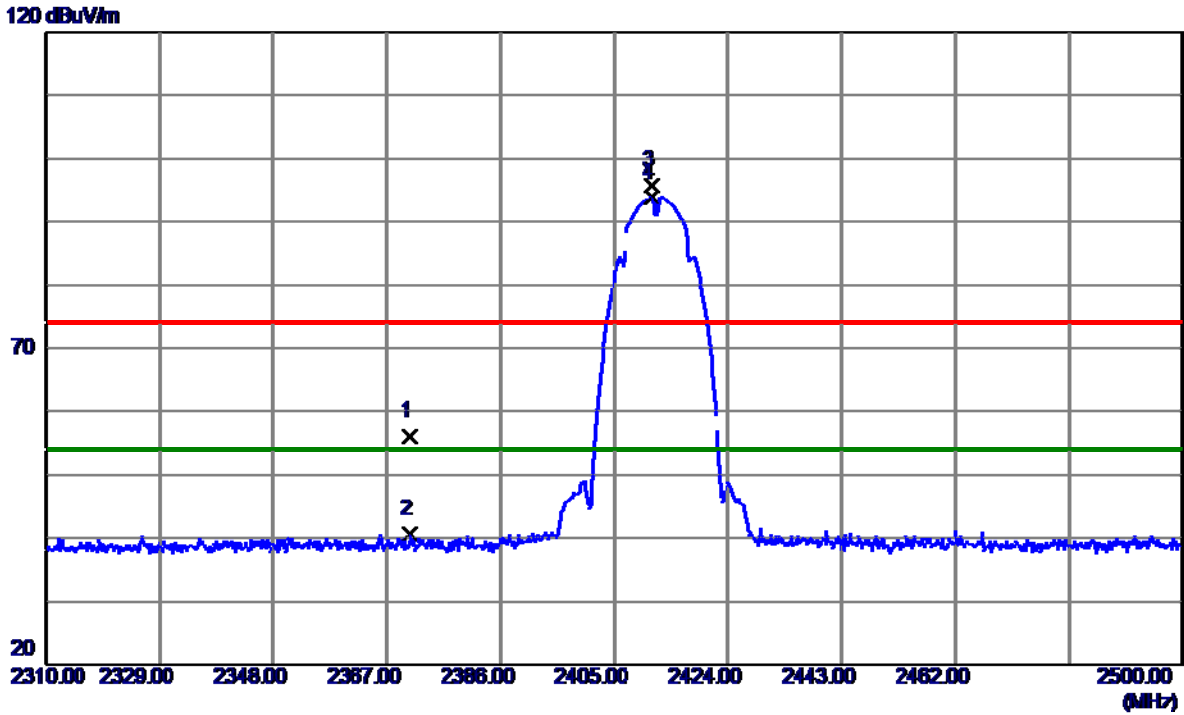

No.	Freq. MHz	Reading Level dBuV/m	Correct Factor dB	Measure ment dBuV/m	Limit dBuV/m	Margin dB	Detector	Comment
1	2370.8950	24.20	31.78	55.98	74.00	-18.02	Peak	
2	2370.8950	8.78	31.78	40.56	54.00	-13.44	AVG	
3	2411.2700	64.05	31.72	95.77	74.00	21.77	Peak	NO limit
4 *	2411.2700	62.09	31.72	93.81	54.00	39.81	AVG	NO limit

REMARKS:

- (1) Measurement Value = Reading Level + Correct Factor.
- (2) Margin Level = Measurement Value - Limit Value.

Test Mode	TX B Mode 2412 MHz	Polarization	Vertical
-----------	--------------------	--------------	----------

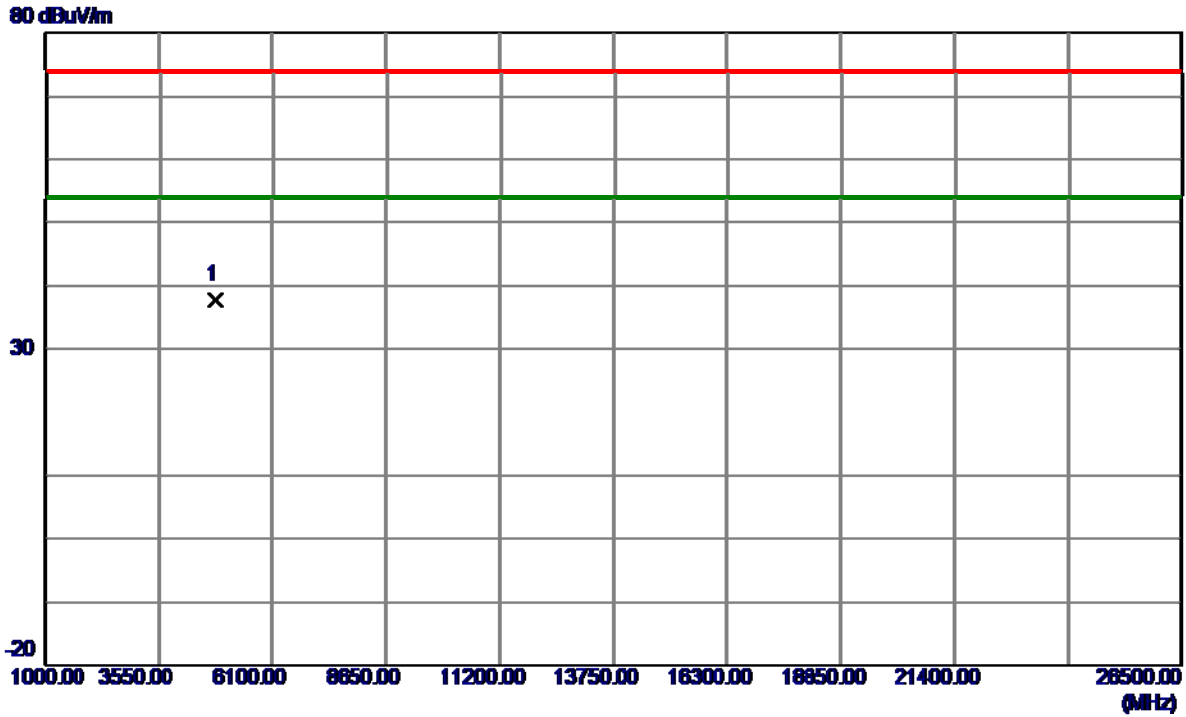

No.	Freq. MHz	Reading Level dBuV/m	Correct Factor dB	Measure ment dBuV/m	Limit dBuV/m	Margin dB	Detector	Comment
1 *	4824.0000	54.78	-16.98	37.80	74.00	-36.20	Peak	

REMARKS:

- (1) Measurement Value = Reading Level + Correct Factor.
- (2) Margin Level = Measurement Value - Limit Value.

Test Mode	TX B Mode 2412 MHz	Polarization	Horizontal
-----------	--------------------	--------------	------------

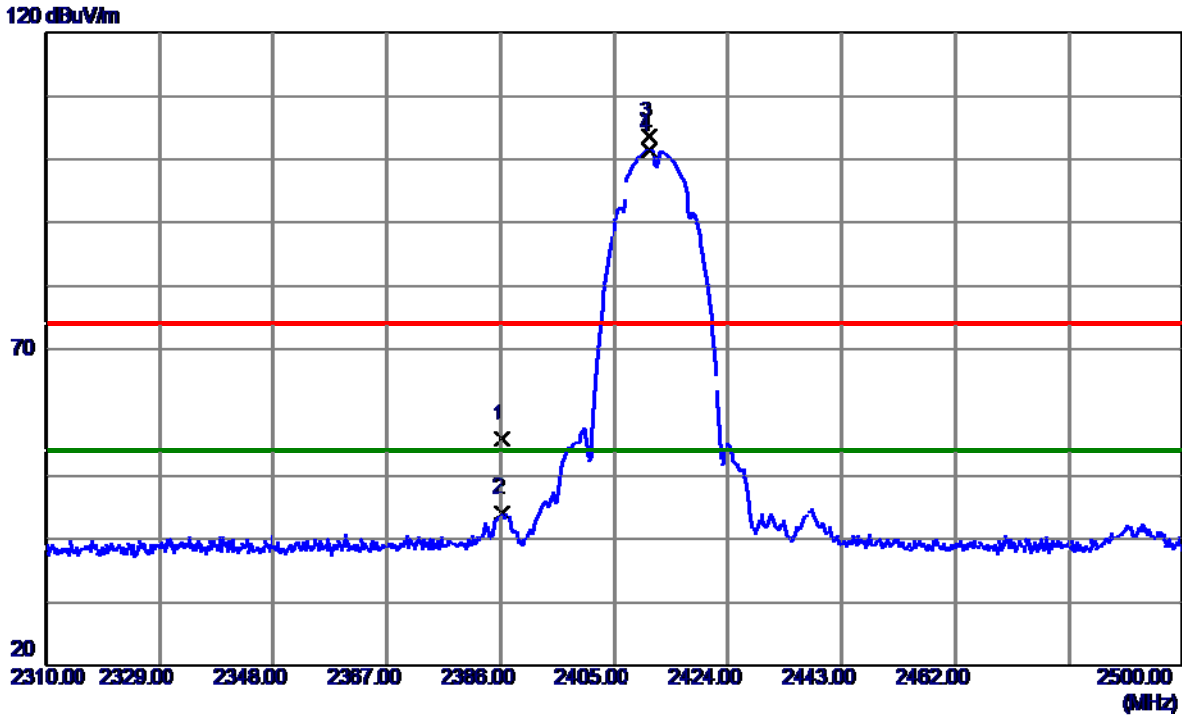

No.	Freq. MHz	Reading Level dBuV/m	Correct Factor dB	Measure ment dBuV/m	Limit dBuV/m	Margin dB	Detector	Comment
1	2386.1900	24.08	31.75	55.83	74.00	-18.17	Peak	
2	2386.1900	12.36	31.75	44.11	54.00	9.89	AVG	
3	2410.9850	71.93	31.72	103.65	74.00	29.65	Peak	NO limit
4 *	2410.9850	69.76	31.72	101.48	54.00	47.48	AVG	NO limit

REMARKS:

(1) Measurement Value = Reading Level + Correct Factor.

(2) Margin Level = Measurement Value - Limit Value.

Test Mode	TX B Mode 2412 MHz	Polarization	Horizontal
-----------	--------------------	--------------	------------

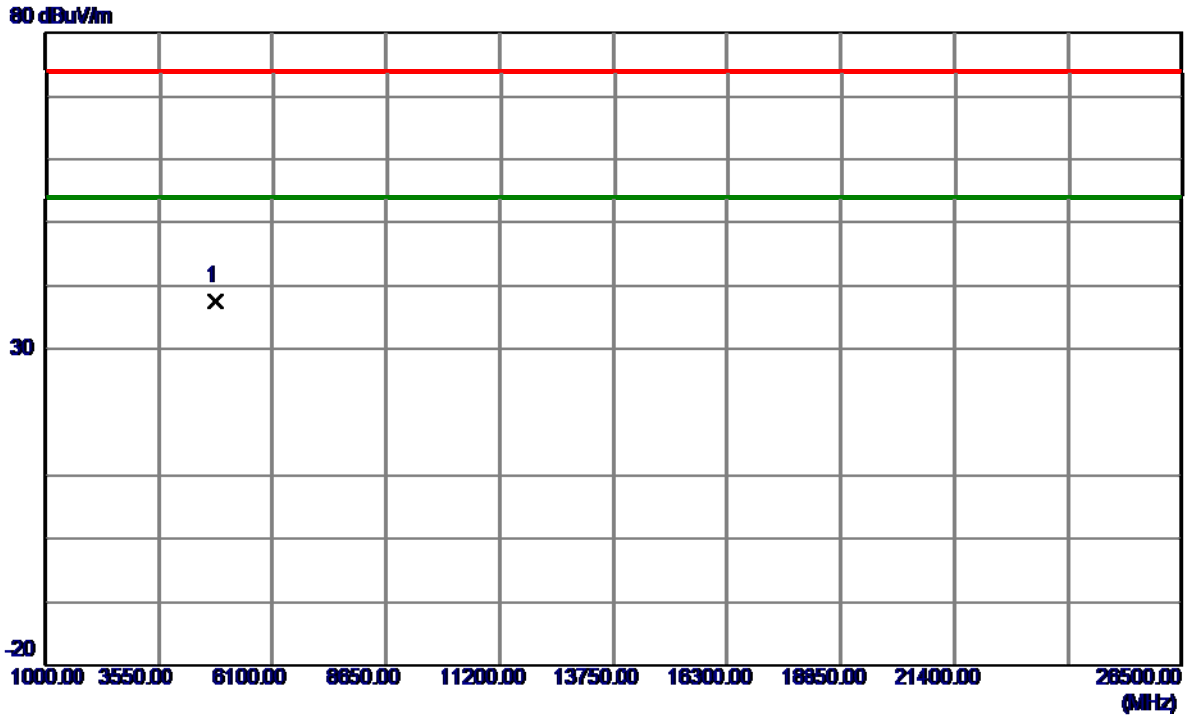

No.	Freq. MHz	Reading Level dBuV/m	Correct Factor dB	Measure ment dBuV/m	Limit dBuV/m	Margin dB	Detector	Comment
1 *	4823.7250	54.59	-16.98	37.61	74.00	-36.39	Peak	

REMARKS:

- (1) Measurement Value = Reading Level + Correct Factor.
- (2) Margin Level = Measurement Value - Limit Value.

Test Mode	TX B Mode 2437 MHz	Polarization	Vertical
-----------	--------------------	--------------	----------

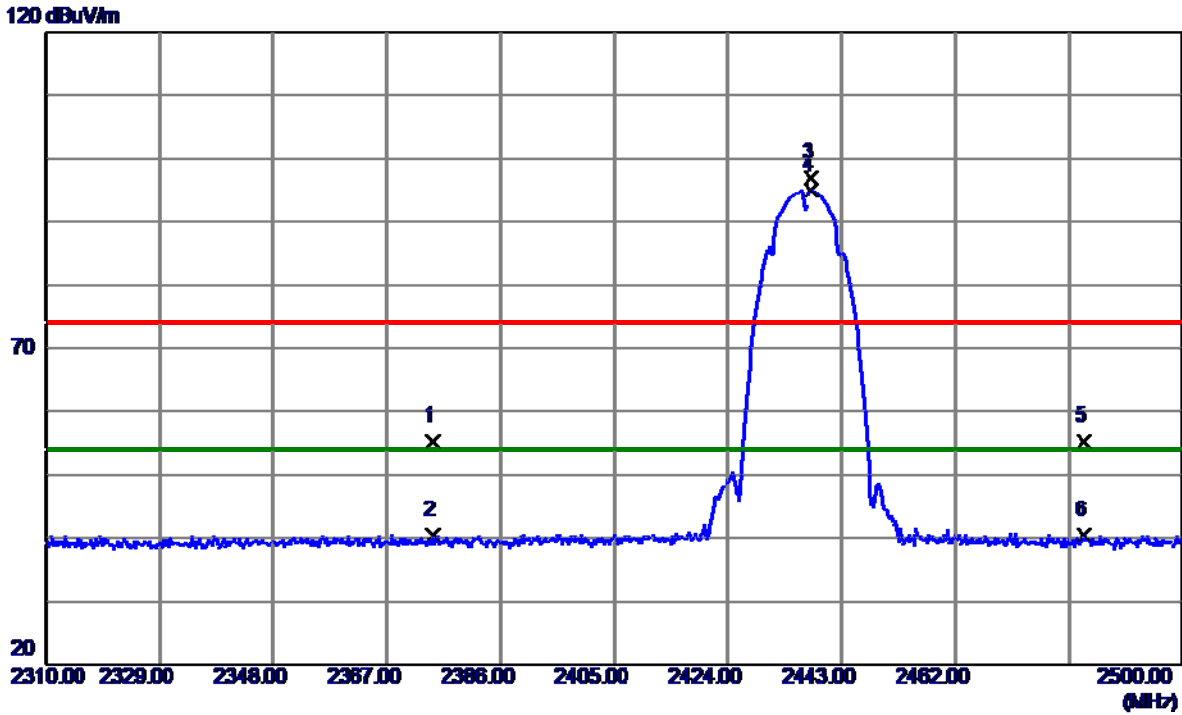

No.	Freq. MHz	Reading Level dBuV/m	Correct Factor dB	Measure ment dBuV/m	Limit dBuV/m	Margin dB	Detector	Comment
1	2374.5049	23.40	31.77	55.17	74.00	-18.83	Peak	
2	2374.5049	8.61	31.77	40.38	54.00	-13.62	AVG	
3	2437.8700	65.22	31.72	96.94	74.00	22.94	Peak	NO limit
4 *	2437.8700	63.28	31.72	95.00	54.00	41.00	AVG	NO limit
5	2483.5000	23.53	31.71	55.24	74.00	-18.76	Peak	
6	2483.5000	8.71	31.71	40.42	54.00	-13.58	AVG	

REMARKS:

- (1) Measurement Value = Reading Level + Correct Factor.
- (2) Margin Level = Measurement Value - Limit Value.

Test Mode	TX B Mode 2437 MHz	Polarization	Vertical
-----------	--------------------	--------------	----------

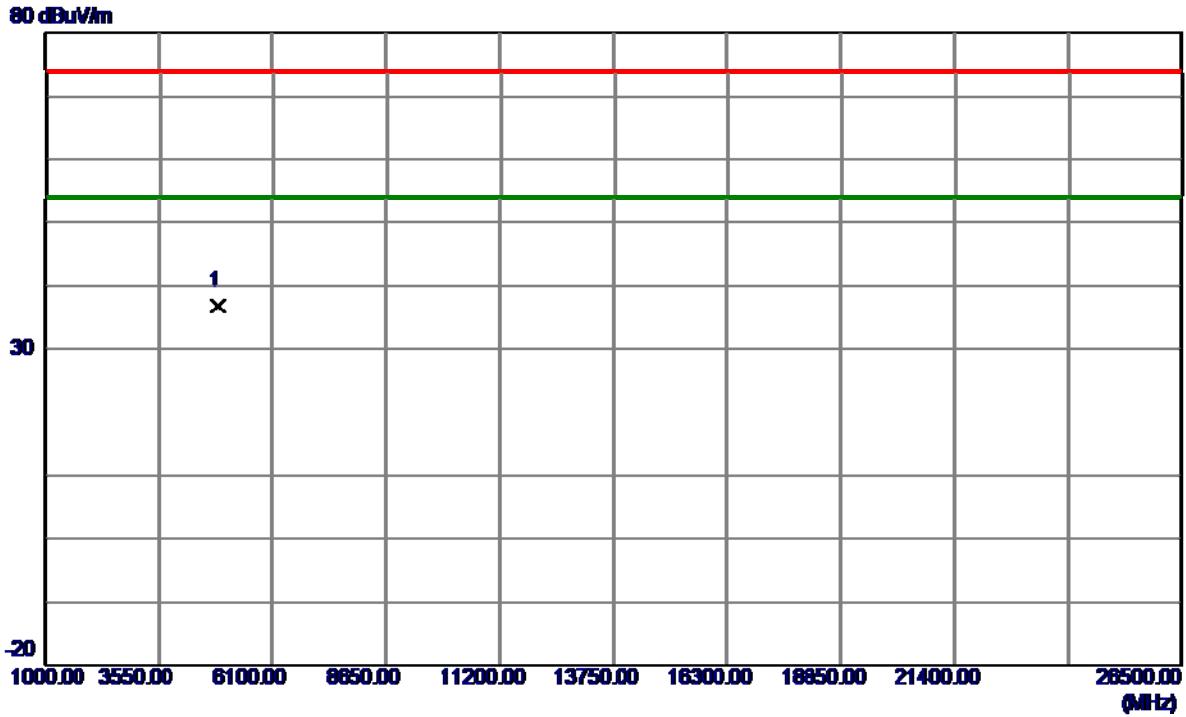

No.	Freq. MHz	Reading Level dBuV/m	Correct Factor dB	Measure ment dBuV/m	Limit dBuV/m	Margin dB	Detector	Comment
1 *	4874.0000	53.79	-16.91	36.88	74.00	-37.12	Peak	

REMARKS:

- (1) Measurement Value = Reading Level + Correct Factor.
- (2) Margin Level = Measurement Value - Limit Value.

Test Mode	TX B Mode 2437 MHz	Polarization	Horizontal
-----------	--------------------	--------------	------------

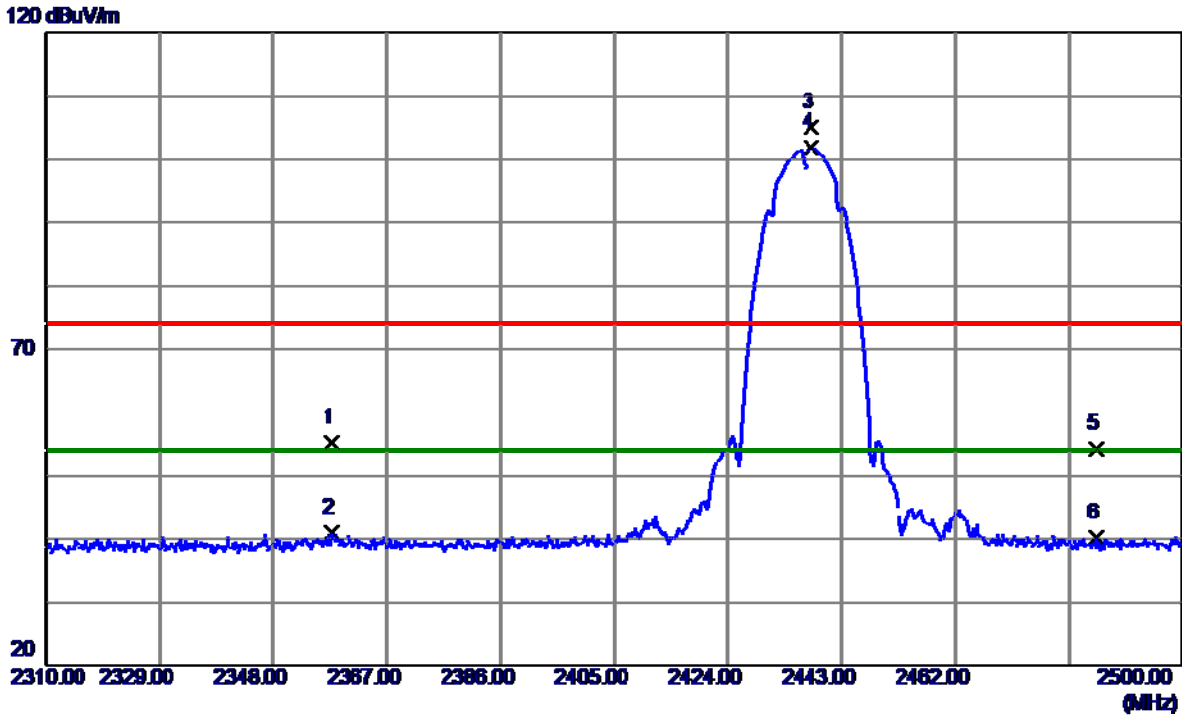

No.	Freq. MHz	Reading Level dBuV/m	Correct Factor dB	Measure ment dBuV/m	Limit dBuV/m	Margin dB	Detector	Comment
1	2357.7850	23.37	31.80	55.17	74.00	-18.83	Peak	
2	2357.7850	9.23	31.80	41.03	54.00	12.97	AVG	
3	2437.8700	73.18	31.72	104.90	74.00	30.90	Peak	NO limit
4 *	2437.8700	70.06	31.72	101.78	54.00	47.78	AVG	NO limit
5	2485.6550	22.53	31.71	54.24	74.00	-19.76	Peak	
6	2485.6550	8.58	31.71	40.29	54.00	-13.71	AVG	

REMARKS:

- (1) Measurement Value = Reading Level + Correct Factor.
- (2) Margin Level = Measurement Value - Limit Value.

Test Mode	TX B Mode 2437 MHz	Polarization	Horizontal
-----------	--------------------	--------------	------------

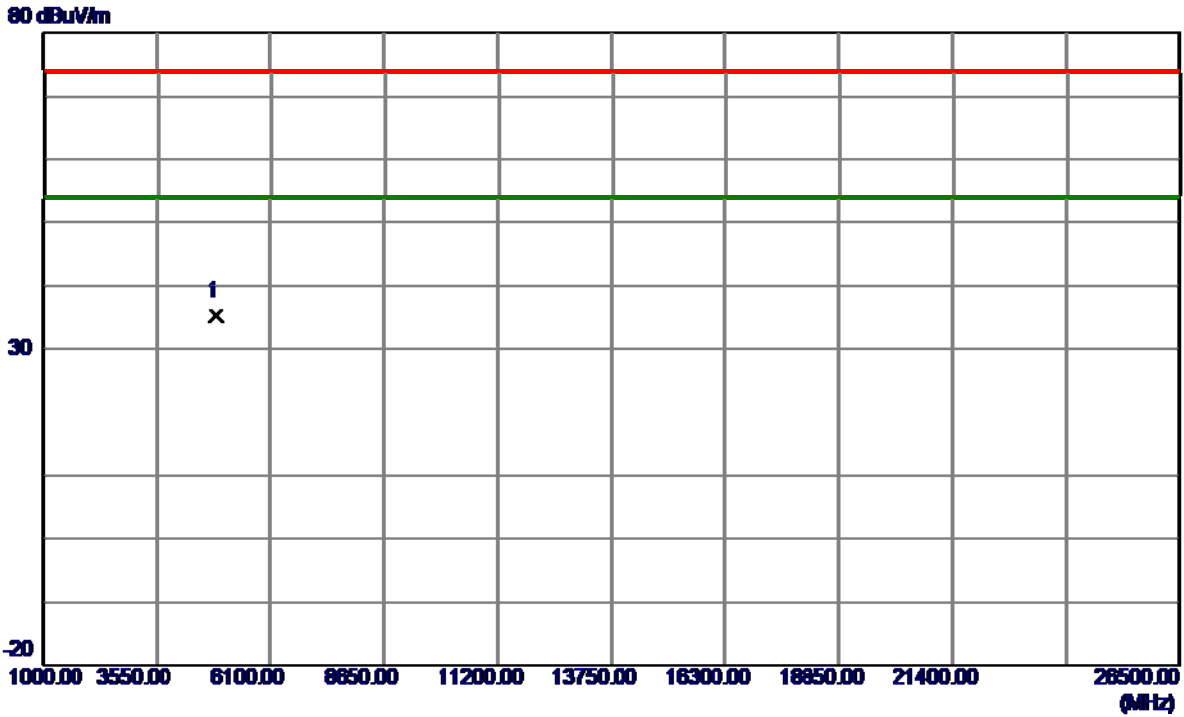

No.	Freq. MHz	Reading Level dBuV/m	Correct Factor dB	Measure ment dBuV/m	Limit dBuV/m	Margin dB	Detector	Comment
1 *	4874.0000	52.08	-16.91	35.17	74.00	-38.83	Peak	

REMARKS:

- (1) Measurement Value = Reading Level + Correct Factor.
- (2) Margin Level = Measurement Value - Limit Value.

Test Mode	TX B Mode 2462 MHz	Polarization	Vertical
-----------	--------------------	--------------	----------

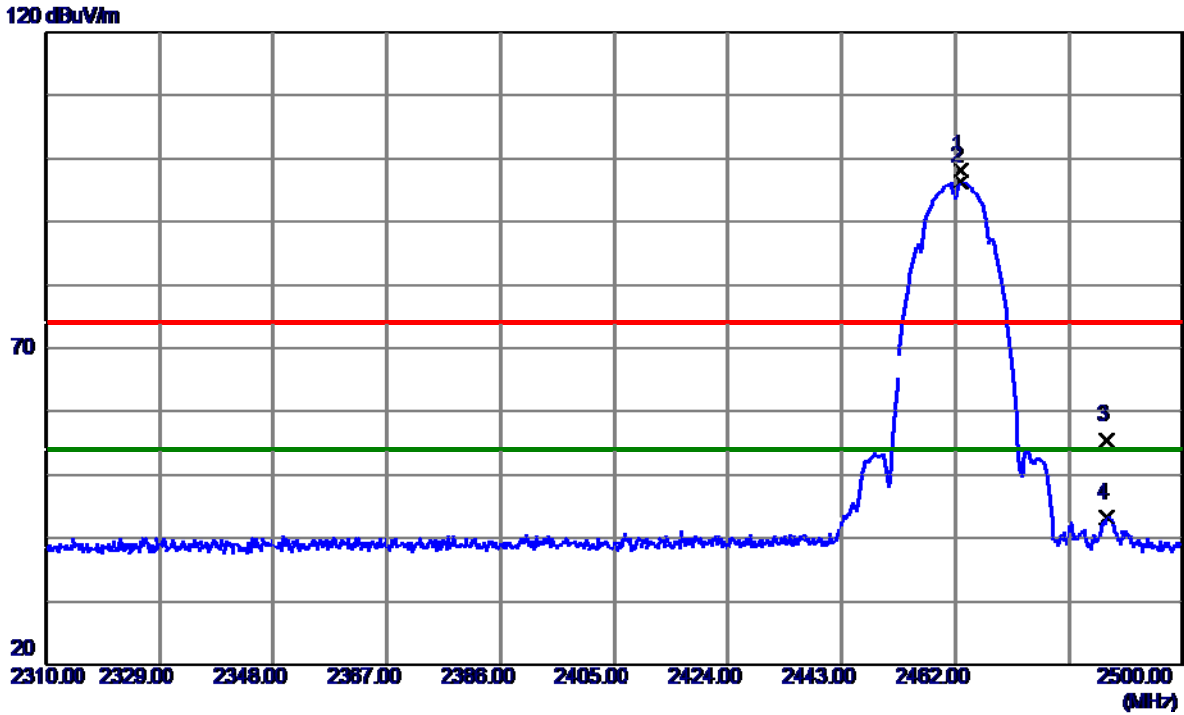

No.	Freq. MHz	Reading Level dBuV/m	Correct Factor dB	Measure ment dBuV/m	Limit dBuV/m	Margin dB	Detector	Comment
1	2462.9500	66.51	31.71	98.22	74.00	24.22	Peak	NO limit
2 *	2462.9500	64.60	31.71	96.31	54.00	42.31	AVG	NO limit
3	2487.3650	23.69	31.71	55.40	74.00	-18.60	Peak	
4	2487.3650	11.43	31.71	43.14	54.00	-10.86	AVG	

REMARKS:

- (1) Measurement Value = Reading Level + Correct Factor.
- (2) Margin Level = Measurement Value - Limit Value.

Test Mode	TX B Mode 2462 MHz	Polarization	Vertical
-----------	--------------------	--------------	----------

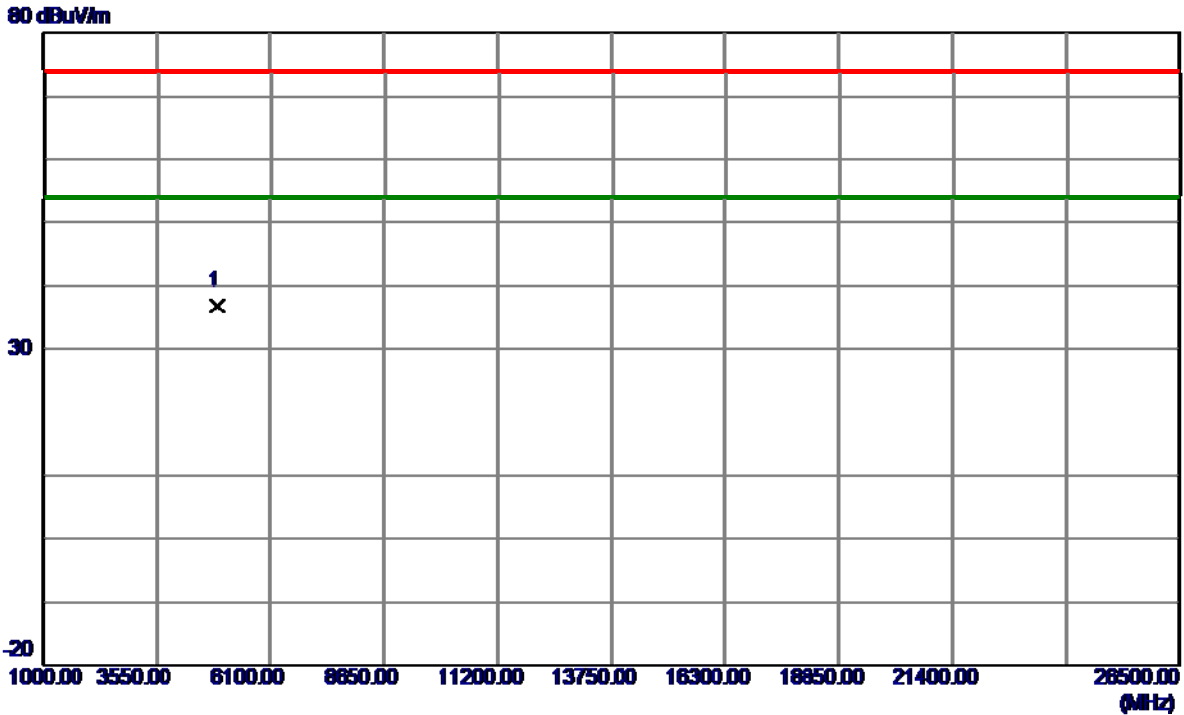

No.	Freq. MHz	Reading Level dBuV/m	Correct Factor dB	Measure ment dBuV/m	Limit dBuV/m	Margin dB	Detector	Comment
1 *	4924.0000	53.53	-16.77	36.76	74.00	-37.24	Peak	

REMARKS:

- (1) Measurement Value = Reading Level + Correct Factor.
- (2) Margin Level = Measurement Value - Limit Value.

Test Mode	TX B Mode 2462 MHz	Polarization	Horizontal
-----------	--------------------	--------------	------------

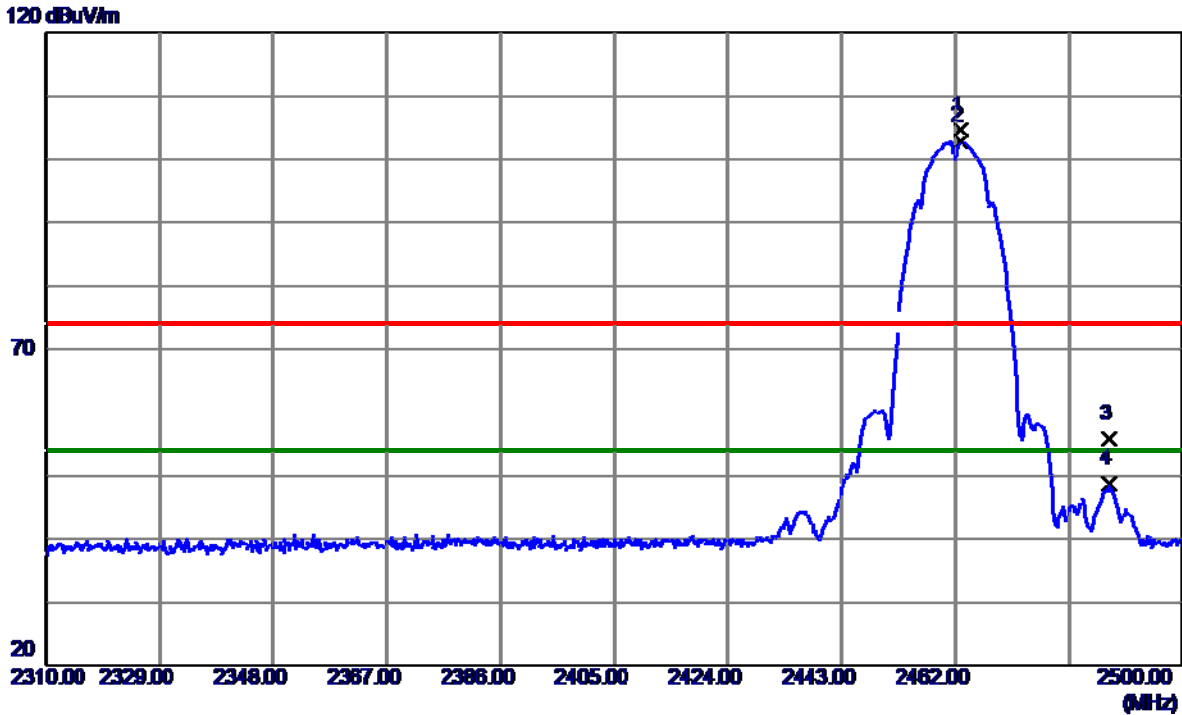

No.	Freq. MHz	Reading Level dBuV/m	Correct Factor dB	Measure ment dBuV/m	Limit dBuV/m	Margin dB	Detector	Comment
1	2462.8550	72.94	31.71	104.65	74.00	30.65	Peak	NO limit
2 *	2462.8550	71.10	31.71	102.81	54.00	48.81	AVG	NO limit
3	2487.8400	24.03	31.71	55.74	74.00	-18.26	Peak	
4	2487.8400	17.02	31.71	48.73	54.00	-5.27	AVG	

REMARKS:

- (1) Measurement Value = Reading Level + Correct Factor.
- (2) Margin Level = Measurement Value - Limit Value.

Test Mode	TX B Mode 2462 MHz	Polarization	Horizontal
-----------	--------------------	--------------	------------

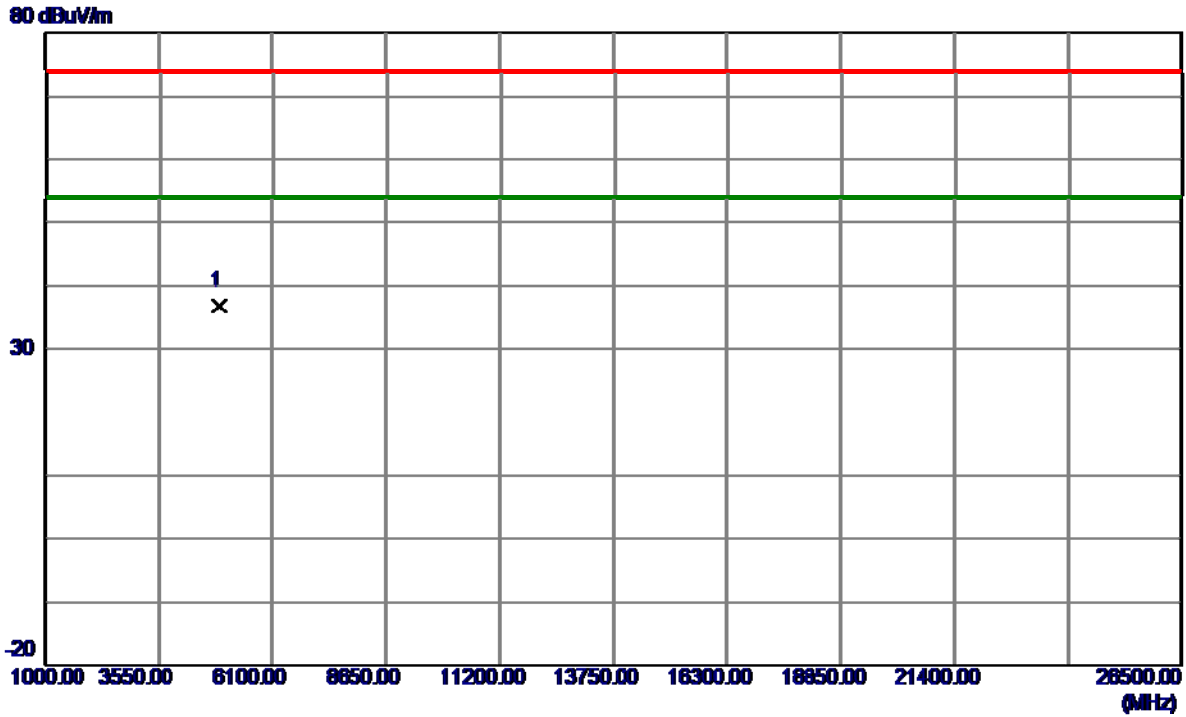

No.	Freq. MHz	Reading Level dBuV/m	Correct Factor dB	Measure ment dBuV/m	Limit dBuV/m	Margin dB	Detector	Comment
1 *	4924.0000	53.48	-16.77	36.71	74.00	-37.29	Peak	

REMARKS:

- (1) Measurement Value = Reading Level + Correct Factor.
- (2) Margin Level = Measurement Value - Limit Value.

Test Mode	TX G Mode 2412 MHz	Polarization	Vertical
-----------	--------------------	--------------	----------

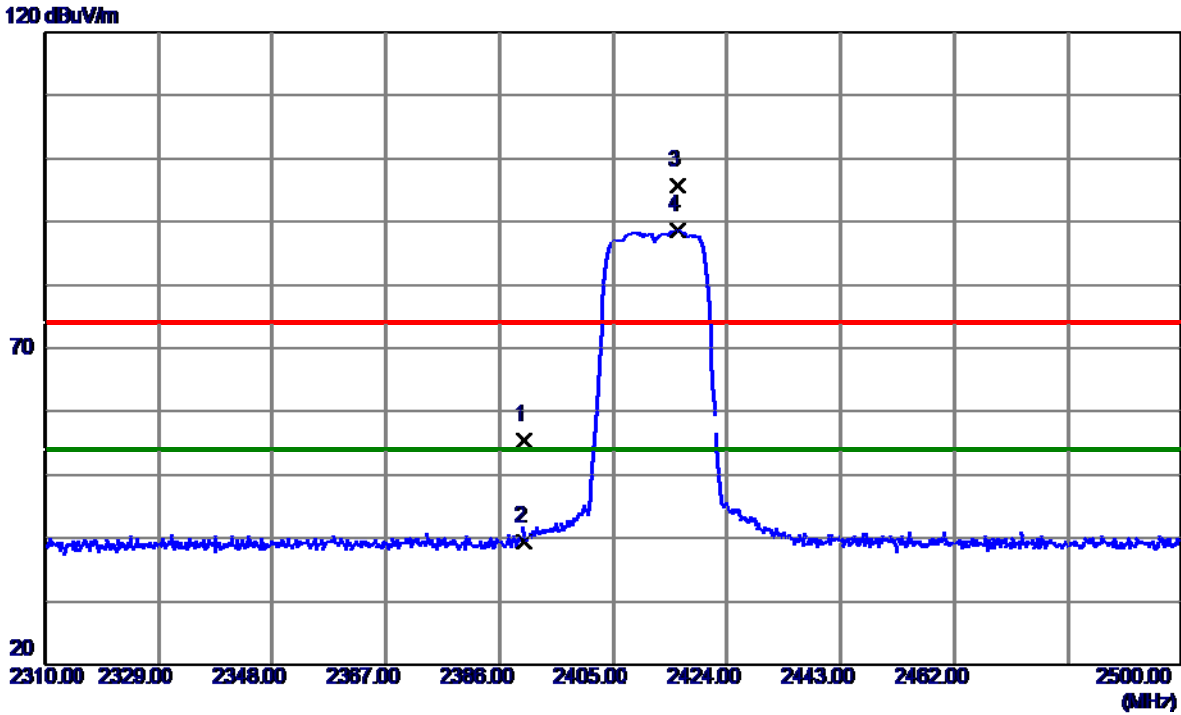

No.	Freq. MHz	Reading Level dBuV/m	Correct Factor dB	Measure ment dBuV/m	Limit dBuV/m	Margin dB	Detector	Comment
1	2390.0000	23.62	31.74	55.36	74.00	-18.64	Peak	
2	2390.0000	7.72	31.74	39.46	54.00	-14.54	AVG	
3	2415.7350	64.13	31.72	95.85	74.00	21.85	Peak	NO limit
4 *	2415.7350	56.89	31.72	88.61	54.00	34.61	AVG	NO limit

REMARKS:

(1) Measurement Value = Reading Level + Correct Factor.

(2) Margin Level = Measurement Value - Limit Value.

Test Mode	TX G Mode 2412 MHz	Polarization	Vertical
-----------	--------------------	--------------	----------

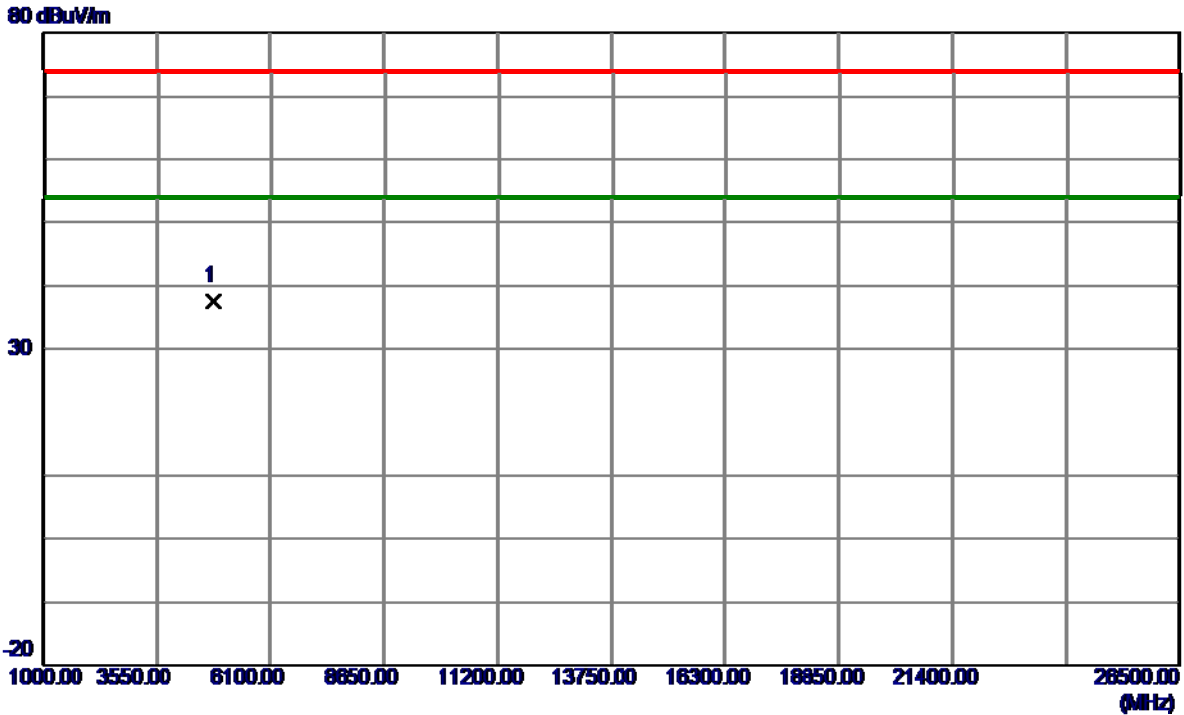

No.	Freq. MHz	Reading Level dBuV/m	Correct Factor dB	Measure ment dBuV/m	Limit dBuV/m	Margin dB	Detector	Comment
1 *	4824.0000	54.53	-16.98	37.55	74.00	-36.45	Peak	

REMARKS:

- (1) Measurement Value = Reading Level + Correct Factor.
- (2) Margin Level = Measurement Value - Limit Value.

Test Mode	TX G Mode 2412 MHz	Polarization	Horizontal
-----------	--------------------	--------------	------------

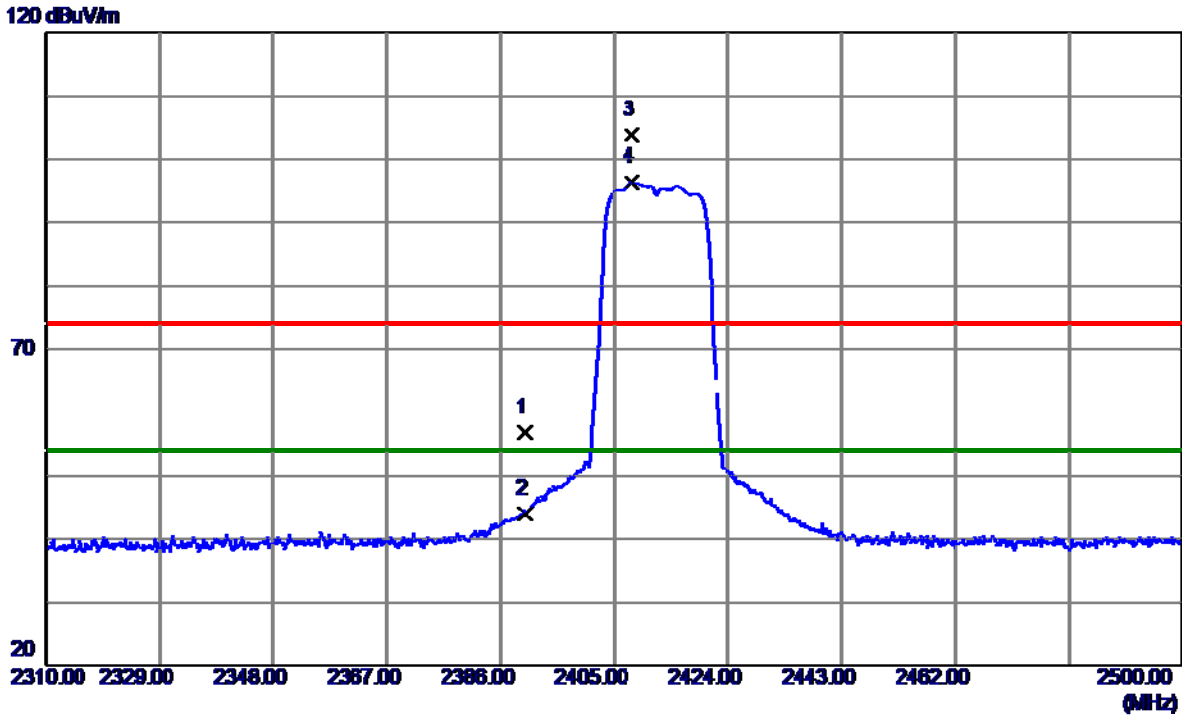

No.	Freq. MHz	Reading Level dBuV/m	Correct Factor dB	Measure ment dBuV/m	Limit dBuV/m	Margin dB	Detector	Comment
1	2390.0000	25.03	31.74	56.77	74.00	-17.23	Peak	
2	2390.0000	12.31	31.74	44.05	54.00	9.95	AVG	
3	2408.0400	72.09	31.72	103.81	74.00	29.81	Peak	NO limit
4 *	2408.0400	64.64	31.72	96.36	54.00	42.36	AVG	NO limit

REMARKS:

(1) Measurement Value = Reading Level + Correct Factor.

(2) Margin Level = Measurement Value - Limit Value.

Test Mode	TX G Mode 2412 MHz	Polarization	Horizontal
-----------	--------------------	--------------	------------

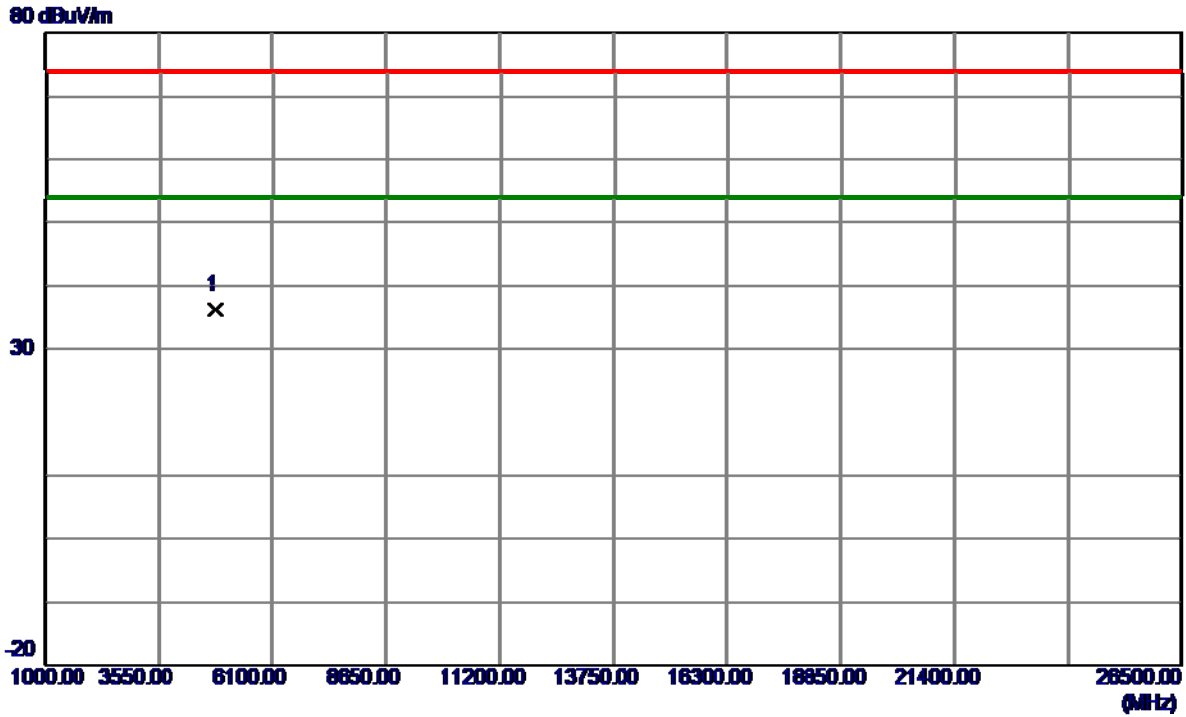

No.	Freq. MHz	Reading Level dBuV/m	Correct Factor dB	Measure ment dBuV/m	Limit dBuV/m	Margin dB	Detector	Comment
1 *	4824.0000	53.26	-16.98	36.28	74.00	-37.72	Peak	

REMARKS:

- (1) Measurement Value = Reading Level + Correct Factor.
- (2) Margin Level = Measurement Value - Limit Value.

Test Mode	TX G Mode 2437 MHz	Polarization	Vertical
-----------	--------------------	--------------	----------

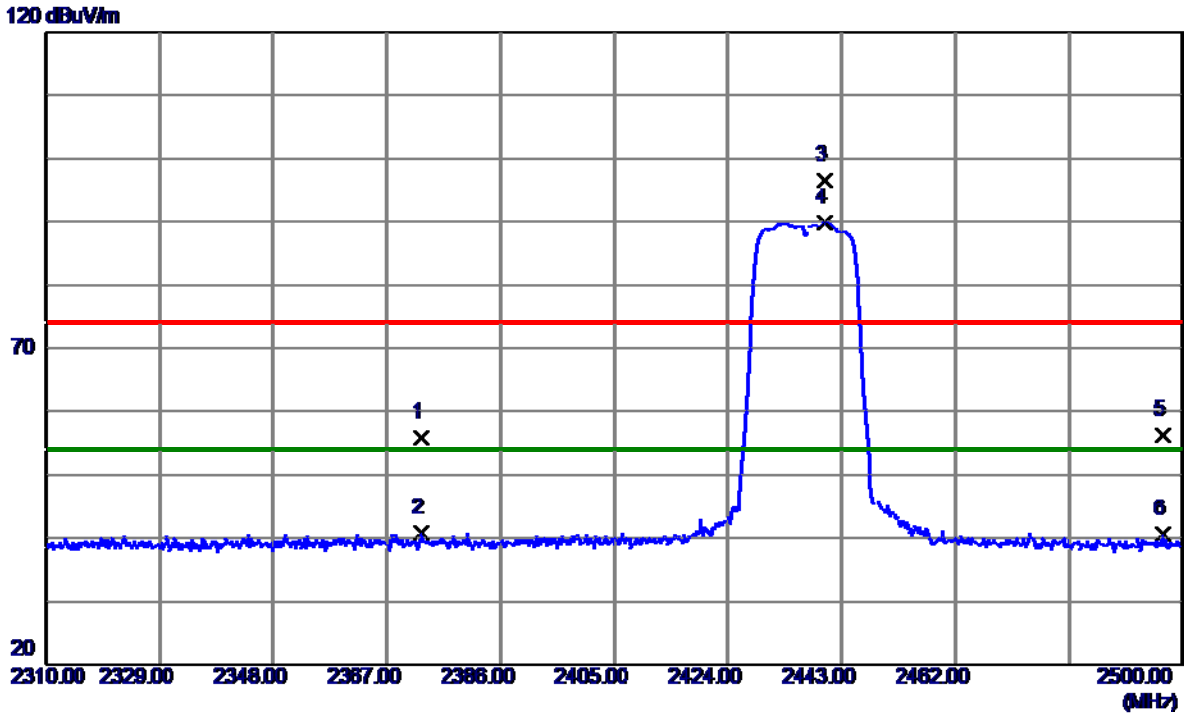

No.	Freq. MHz	Reading Level dBuV/m	Correct Factor dB	Measure ment dBuV/m	Limit dBuV/m	Margin dB	Detector	Comment
1	2372.7950	24.07	31.77	55.84	74.00	-18.16	Peak	
2	2372.7950	8.99	31.77	40.76	54.00	-13.24	AVG	
3	2440.2450	64.93	31.72	96.65	74.00	22.65	Peak	NO limit
4 *	2440.2450	58.10	31.72	89.82	54.00	35.82	AVG	NO limit
5	2496.6750	24.47	31.71	56.18	74.00	-17.82	Peak	
6	2496.6750	8.89	31.71	40.60	54.00	-13.40	AVG	

REMARKS:

- (1) Measurement Value = Reading Level + Correct Factor.
- (2) Margin Level = Measurement Value - Limit Value.

Test Mode	TX G Mode 2437 MHz	Polarization	Vertical
-----------	--------------------	--------------	----------

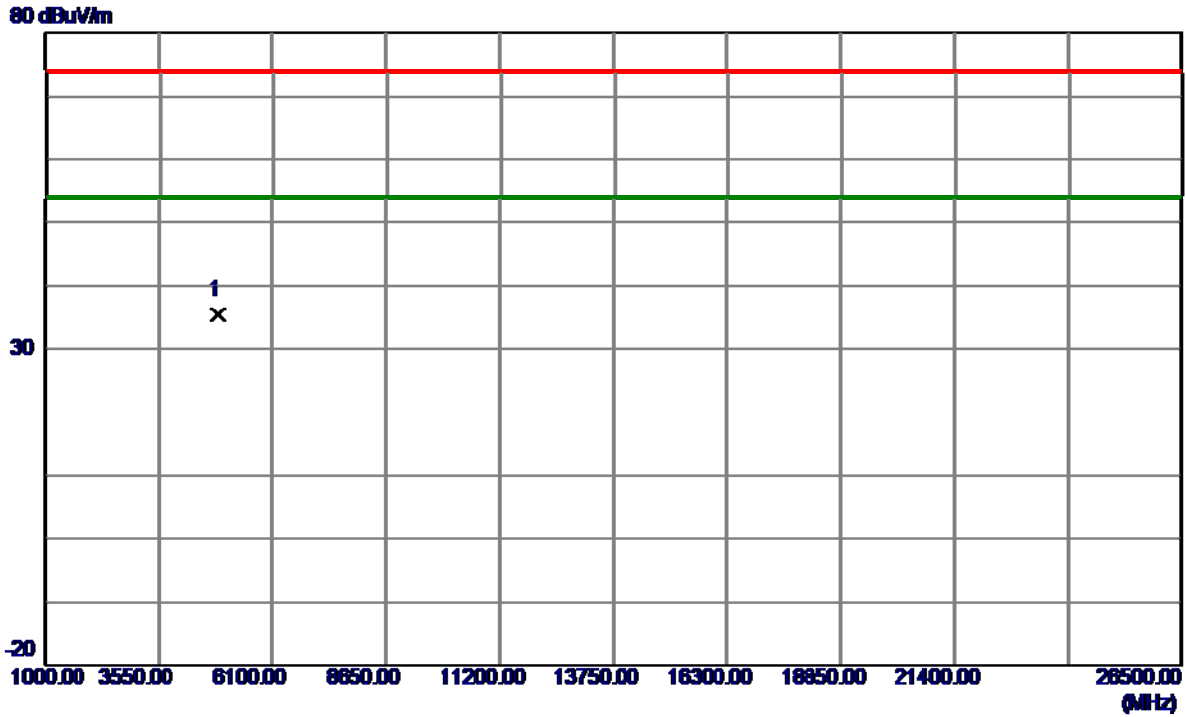

No.	Freq. MHz	Reading Level dBuV/m	Correct Factor dB	Measure ment dBuV/m	Limit dBuV/m	Margin dB	Detector	Comment
1 *	4874.0000	52.27	-16.91	35.36	74.00	-38.64	Peak	

REMARKS:

- (1) Measurement Value = Reading Level + Correct Factor.
- (2) Margin Level = Measurement Value - Limit Value.

Test Mode	TX G Mode 2437 MHz	Polarization	Horizontal
-----------	--------------------	--------------	------------

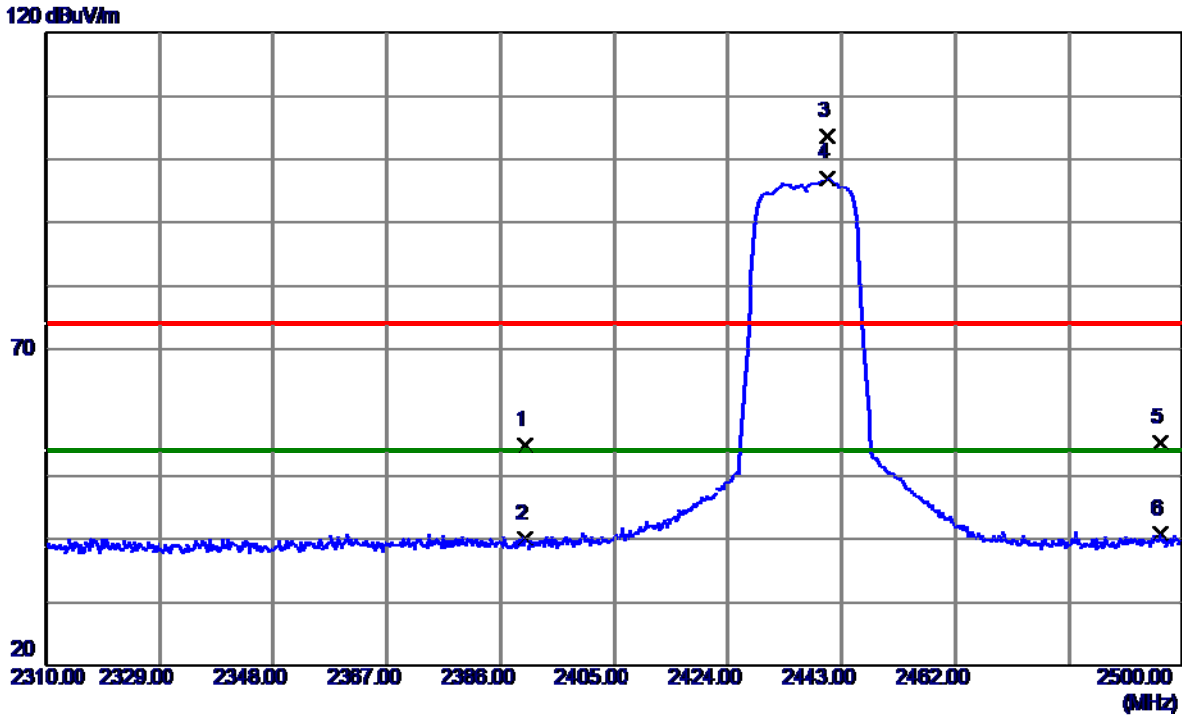

No.	Freq. MHz	Reading Level dBuV/m	Correct Factor dB	Measure ment dBuV/m	Limit dBuV/m	Margin dB	Detector	Comment
1	2390.0000	23.11	31.74	54.85	74.00	-19.15	Peak	
2	2390.0000	8.18	31.74	39.92	54.00	14.08	AVG	
3	2440.7200	71.94	31.72	103.66	74.00	29.66	Peak	NO limit
4 *	2440.7200	65.19	31.72	96.91	54.00	42.91	AVG	NO limit
5	2496.1050	23.44	31.71	55.15	74.00	-18.85	Peak	
6	2496.1050	9.05	31.71	40.76	54.00	-13.24	AVG	

REMARKS:

(1) Measurement Value = Reading Level + Correct Factor.

(2) Margin Level = Measurement Value - Limit Value.

Test Mode	TX G Mode 2437 MHz	Polarization	Horizontal
-----------	--------------------	--------------	------------

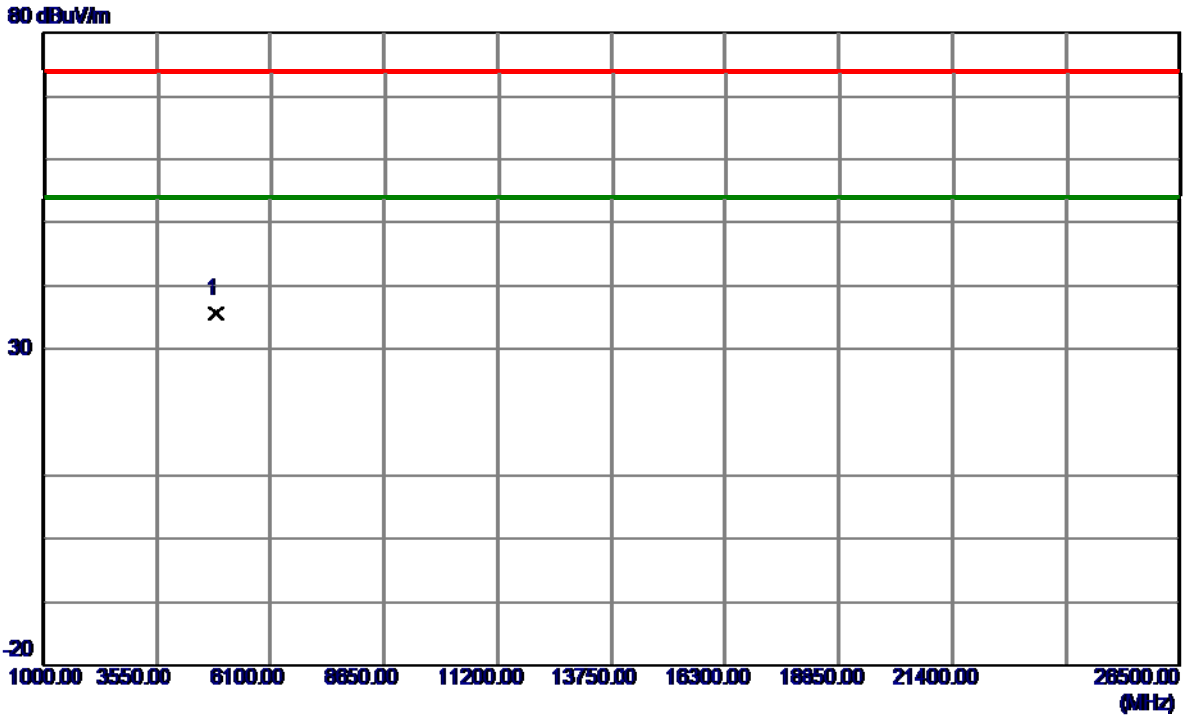

No.	Freq. MHz	Reading Level dBuV/m	Correct Factor dB	Measure ment dBuV/m	Limit dBuV/m	Margin dB	Detector	Comment
1 *	4874.0000	52.55	-16.91	35.64	74.00	-38.36	Peak	

REMARKS:

- (1) Measurement Value = Reading Level + Correct Factor.
- (2) Margin Level = Measurement Value - Limit Value.

Test Mode	TX G Mode 2462 MHz	Polarization	Vertical
-----------	--------------------	--------------	----------

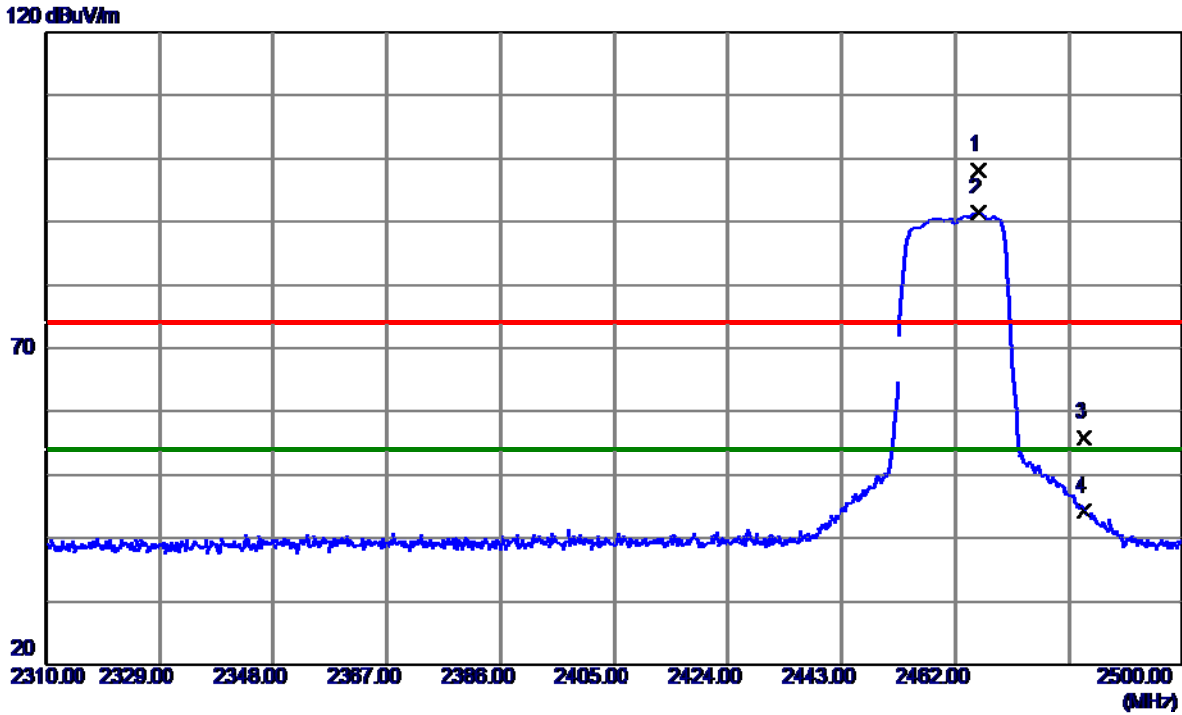

No.	Freq. MHz	Reading Level dBuV/m	Correct Factor dB	Measure ment dBuV/m	Limit dBuV/m	Margin dB	Detector	Comment
1	2465.7050	66.41	31.71	98.12	74.00	24.12	Peak	NO limit
2 *	2465.7050	59.67	31.71	91.38	54.00	37.38	AVG	NO limit
3	2483.5000	24.16	31.71	55.87	74.00	-18.13	Peak	
4	2483.5000	12.40	31.71	44.11	54.00	-9.89	AVG	

REMARKS:

- (1) Measurement Value = Reading Level + Correct Factor.
- (2) Margin Level = Measurement Value - Limit Value.

Test Mode	TX G Mode 2462 MHz	Polarization	Vertical
-----------	--------------------	--------------	----------

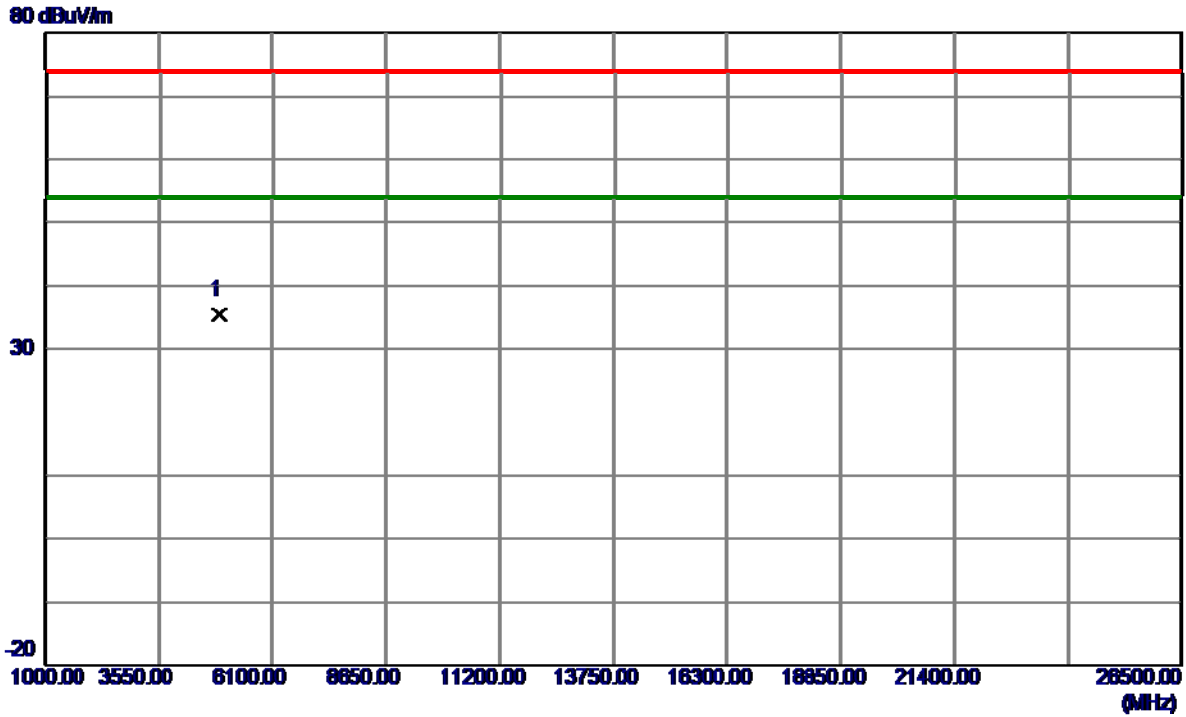

No.	Freq. MHz	Reading Level dBuV/m	Correct Factor dB	Measure ment dBuV/m	Limit dBuV/m	Margin dB	Detector	Comment
1 *	4924.0000	52.24	-16.77	35.47	74.00	-38.53	Peak	

REMARKS:

- (1) Measurement Value = Reading Level + Correct Factor.
- (2) Margin Level = Measurement Value - Limit Value.

Test Mode	TX G Mode 2462 MHz	Polarization	Horizontal
-----------	--------------------	--------------	------------

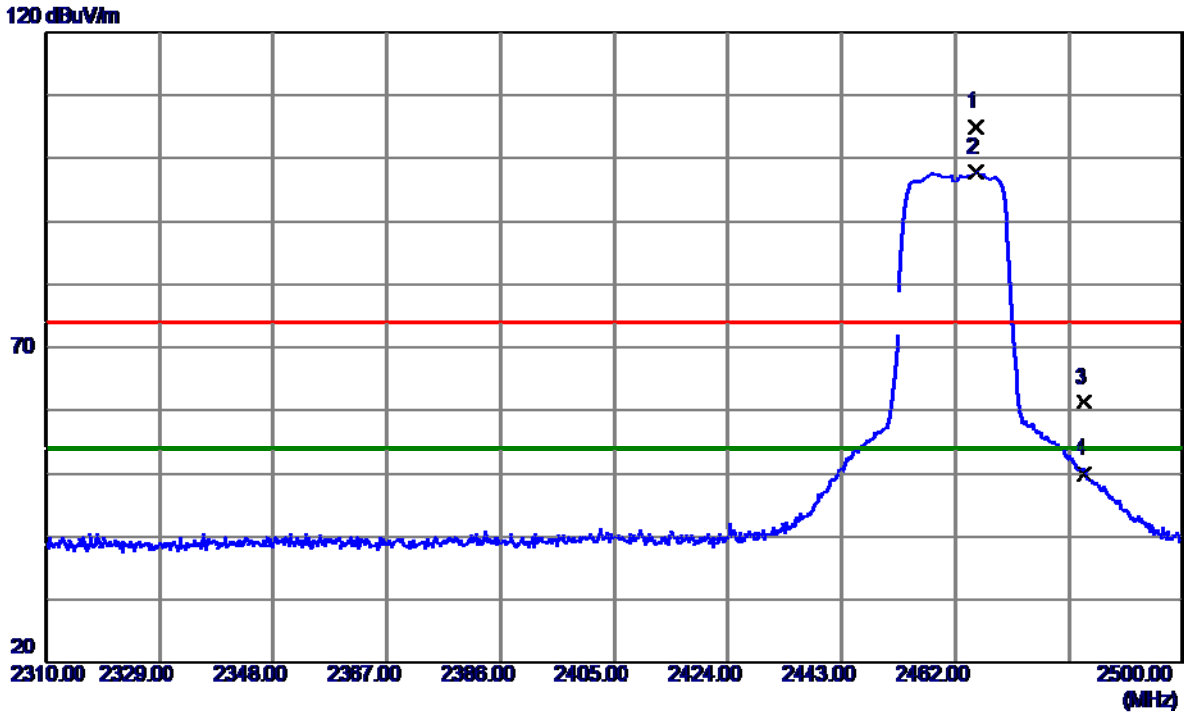

No.	Freq. MHz	Reading Level dBuV/m	Correct Factor dB	Measure ment dBuV/m	Limit dBuV/m	Margin dB	Detector	Comment
1	2465.4200	73.38	31.71	105.09	74.00	31.09	Peak	NO limit
2 *	2465.4200	66.05	31.71	97.76	54.00	43.76	AVG	NO limit
3	2483.5000	29.59	31.71	61.30	74.00	-12.70	Peak	
4	2483.5000	18.34	31.71	50.05	54.00	-3.95	AVG	

REMARKS:

- (1) Measurement Value = Reading Level + Correct Factor.
- (2) Margin Level = Measurement Value - Limit Value.

Test Mode	TX G Mode 2462 MHz	Polarization	Horizontal
-----------	--------------------	--------------	------------

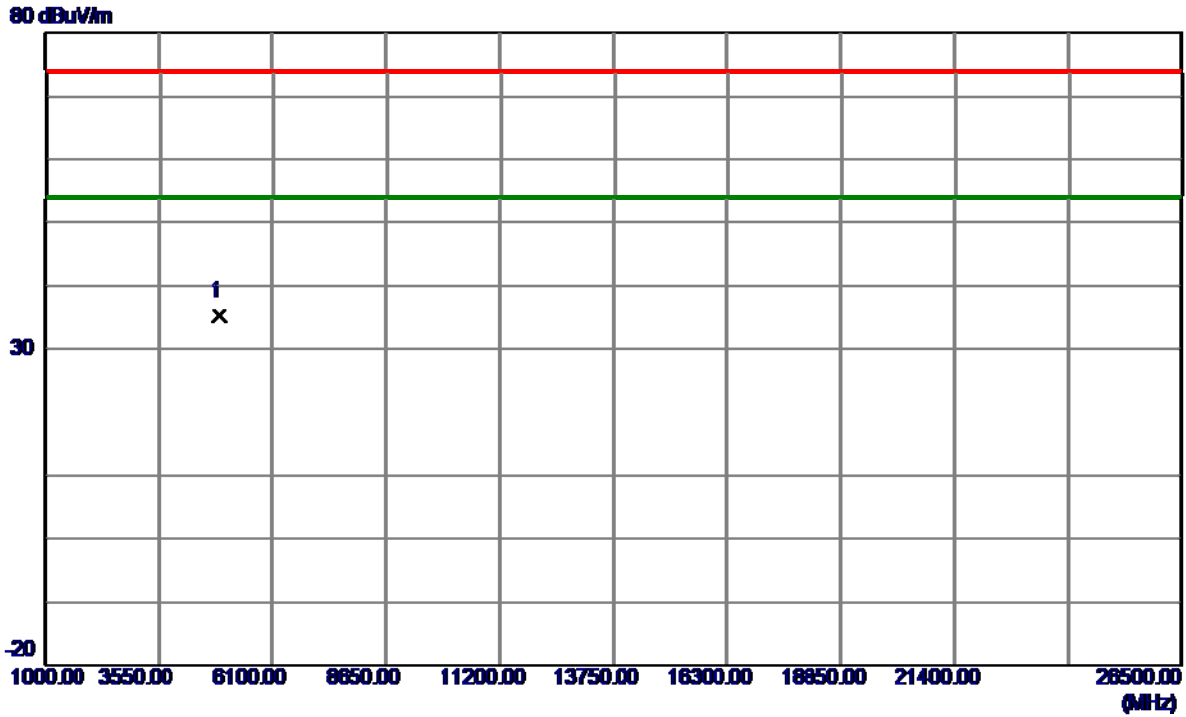

No.	Freq. MHz	Reading Level dBuV/m	Correct Factor dB	Measure ment dBuV/m	Limit dBuV/m	Margin dB	Detector	Comment
1 *	4924.0000	51.94	-16.77	35.17	74.00	-38.83	Peak	

REMARKS:

- (1) Measurement Value = Reading Level + Correct Factor.
- (2) Margin Level = Measurement Value - Limit Value.

Test Mode	TX N(HT20) Mode 2412 MHz	Polarization	Vertical
-----------	--------------------------	--------------	----------

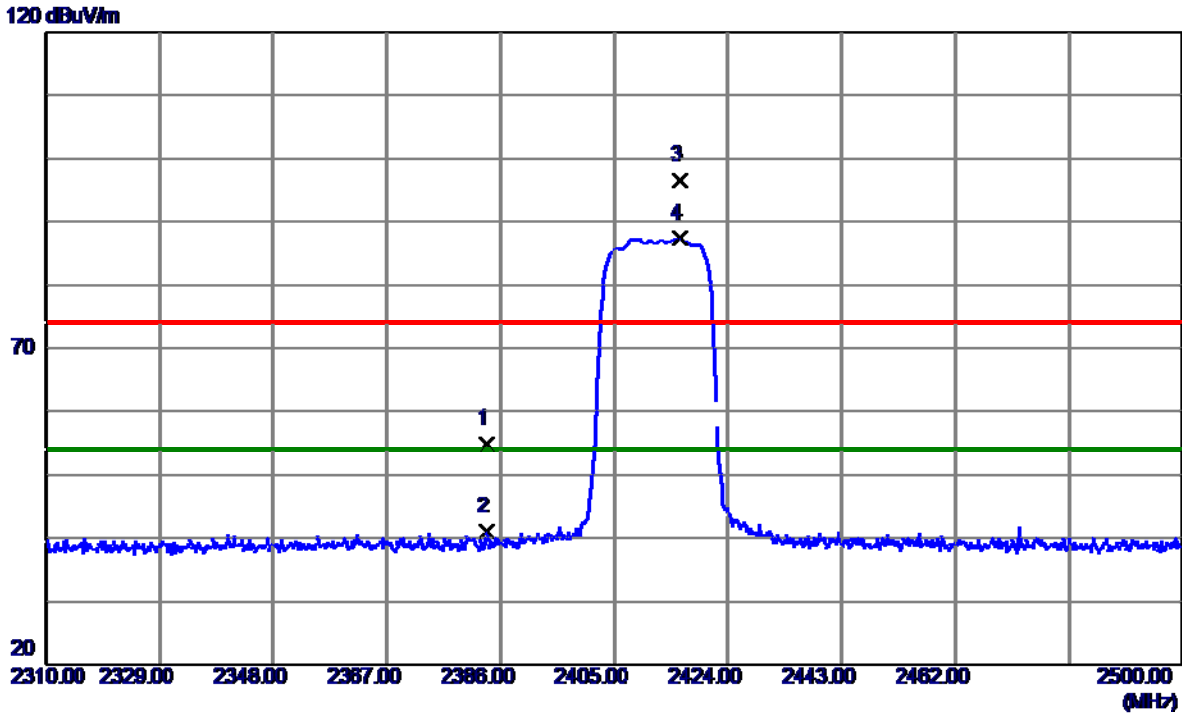

No.	Freq. MHz	Reading Level dBuV/m	Correct Factor dB	Measure ment dBuV/m	Limit dBuV/m	Margin dB	Detector	Comment
1	2383.7200	23.09	31.75	54.84	74.00	-19.16	Peak	
2	2383.7200	9.28	31.75	41.03	54.00	-12.97	AVG	
3	2416.0200	64.96	31.72	96.68	74.00	22.68	Peak	NO limit
4 *	2416.0200	55.58	31.72	87.30	54.00	33.30	AVG	NO limit

REMARKS:

- (1) Measurement Value = Reading Level + Correct Factor.
- (2) Margin Level = Measurement Value - Limit Value.

Test Mode	TX N(HT20) Mode 2412 MHz	Polarization	Vertical
-----------	--------------------------	--------------	----------

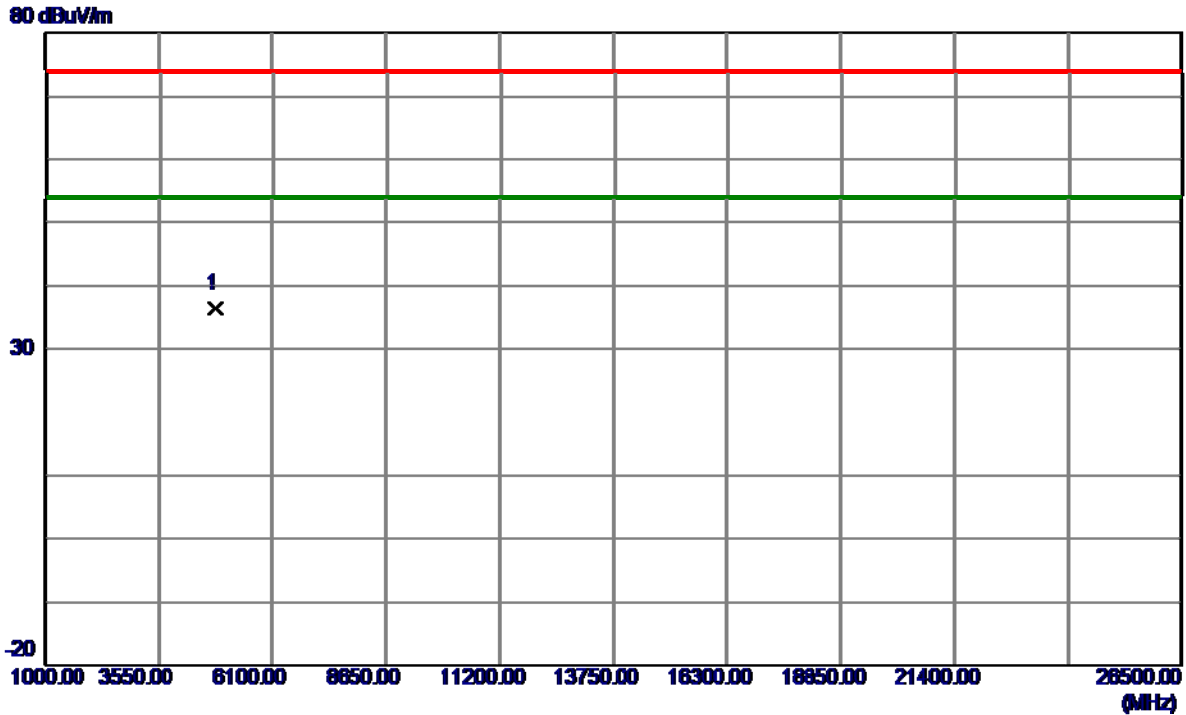

No.	Freq. MHz	Reading Level dBuV/m	Correct Factor dB	Measure ment dBuV/m	Limit dBuV/m	Margin dB	Detector	Comment
1 *	4824.0000	53.44	-16.98	36.46	74.00	-37.54	Peak	

REMARKS:

- (1) Measurement Value = Reading Level + Correct Factor.
- (2) Margin Level = Measurement Value - Limit Value.

Test Mode	TX N(HT20) Mode 2412 MHz	Polarization	Horizontal
-----------	--------------------------	--------------	------------

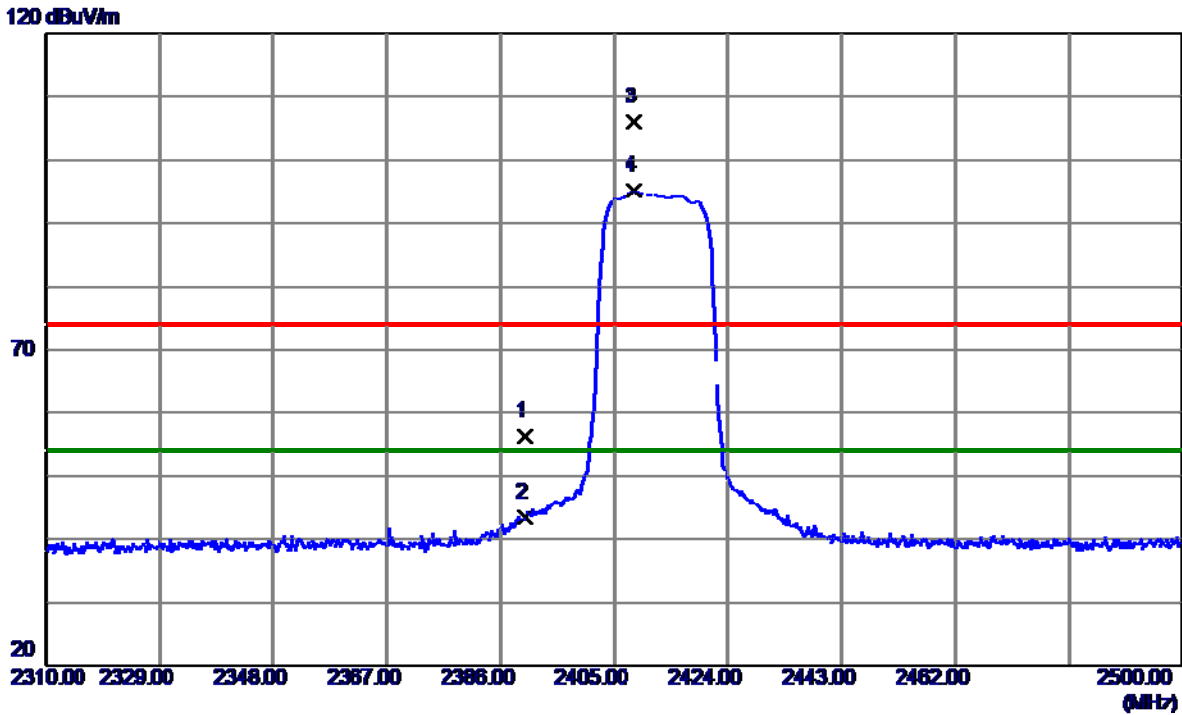

No.	Freq. MHz	Reading Level dBuV/m	Correct Factor dB	Measure ment dBuV/m	Limit dBuV/m	Margin dB	Detector	Comment
1	2390.0000	24.47	31.74	56.21	74.00	-17.79	Peak	
2	2390.0000	11.67	31.74	43.41	54.00	-10.59	AVG	
3	2408.3250	74.30	31.72	106.02	74.00	32.02	Peak	NO limit
4 *	2408.3250	63.41	31.72	95.13	54.00	41.13	AVG	NO limit

REMARKS:

- (1) Measurement Value = Reading Level + Correct Factor.
- (2) Margin Level = Measurement Value - Limit Value.

Test Mode	TX N(HT20) Mode 2412 MHz	Polarization	Horizontal
-----------	--------------------------	--------------	------------

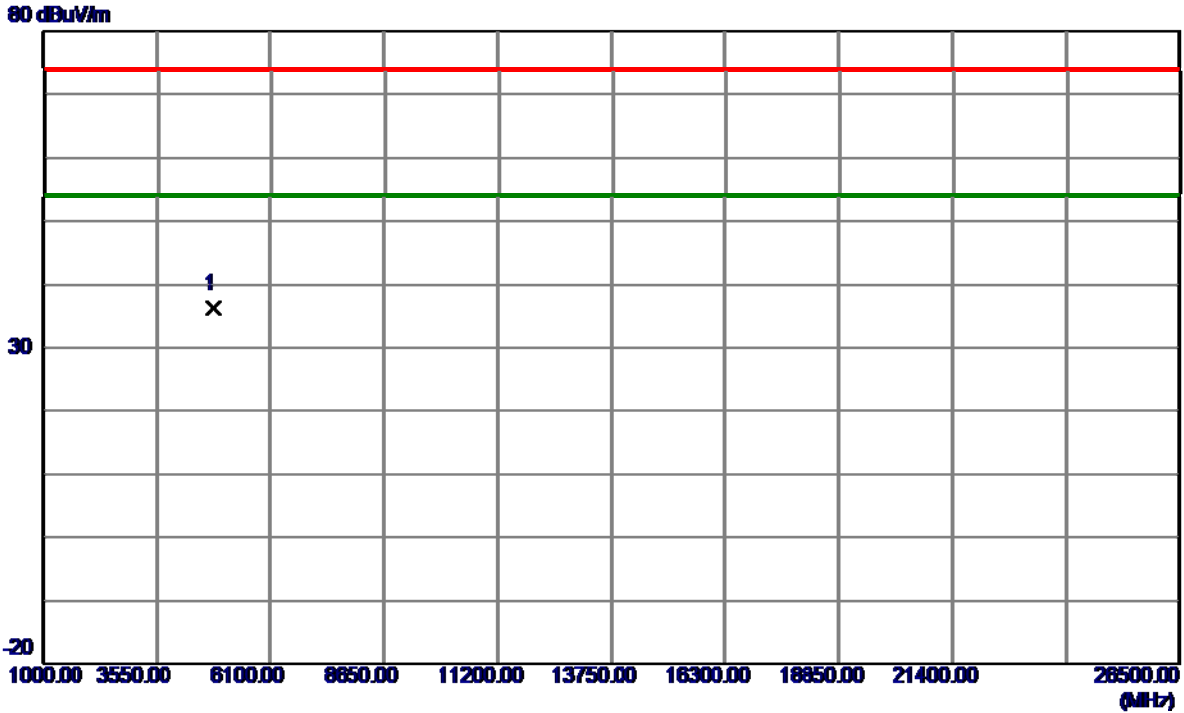

No.	Freq. MHz	Reading Level dBuV/m	Correct Factor dB	Measure ment dBuV/m	Limit dBuV/m	Margin dB	Detector	Comment
1 *	4824.0000	53.20	-16.98	36.22	74.00	-37.78	Peak	

REMARKS:

- (1) Measurement Value = Reading Level + Correct Factor.
- (2) Margin Level = Measurement Value - Limit Value.

Test Mode	TX N(HT20) Mode 2437 MHz	Polarization	Vertical
-----------	--------------------------	--------------	----------

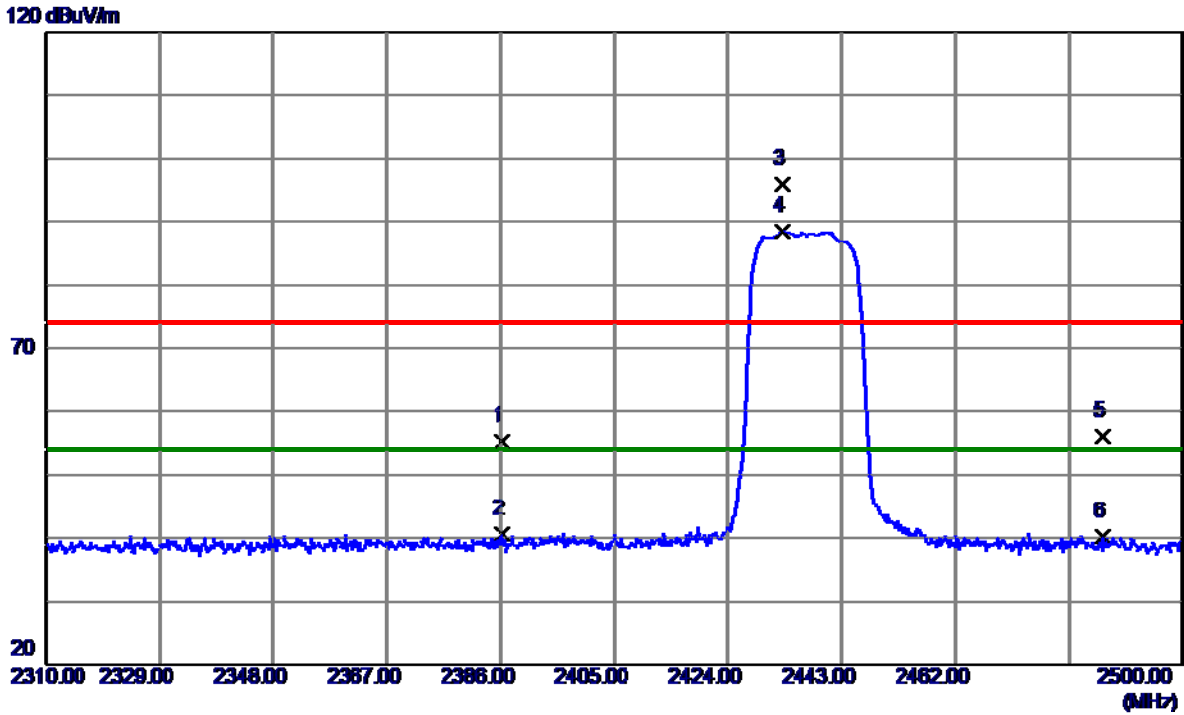

No.	Freq. MHz	Reading Level dBuV/m	Correct Factor dB	Measure ment dBuV/m	Limit dBuV/m	Margin dB	Detector	Comment
1	2386.2850	23.43	31.75	55.18	74.00	-18.82	Peak	
2	2386.2850	8.85	31.75	40.60	54.00	-13.40	AVG	
3	2433.1200	64.34	31.72	96.06	74.00	22.06	Peak	NO limit
4 *	2433.1200	56.62	31.72	88.34	54.00	34.34	AVG	NO limit
5	2486.7000	24.27	31.71	55.98	74.00	-18.02	Peak	
6	2486.7000	8.52	31.71	40.23	54.00	-13.77	AVG	

REMARKS:

- (1) Measurement Value = Reading Level + Correct Factor.
- (2) Margin Level = Measurement Value - Limit Value.

Test Mode	TX N(HT20) Mode 2437 MHz	Polarization	Vertical
-----------	--------------------------	--------------	----------

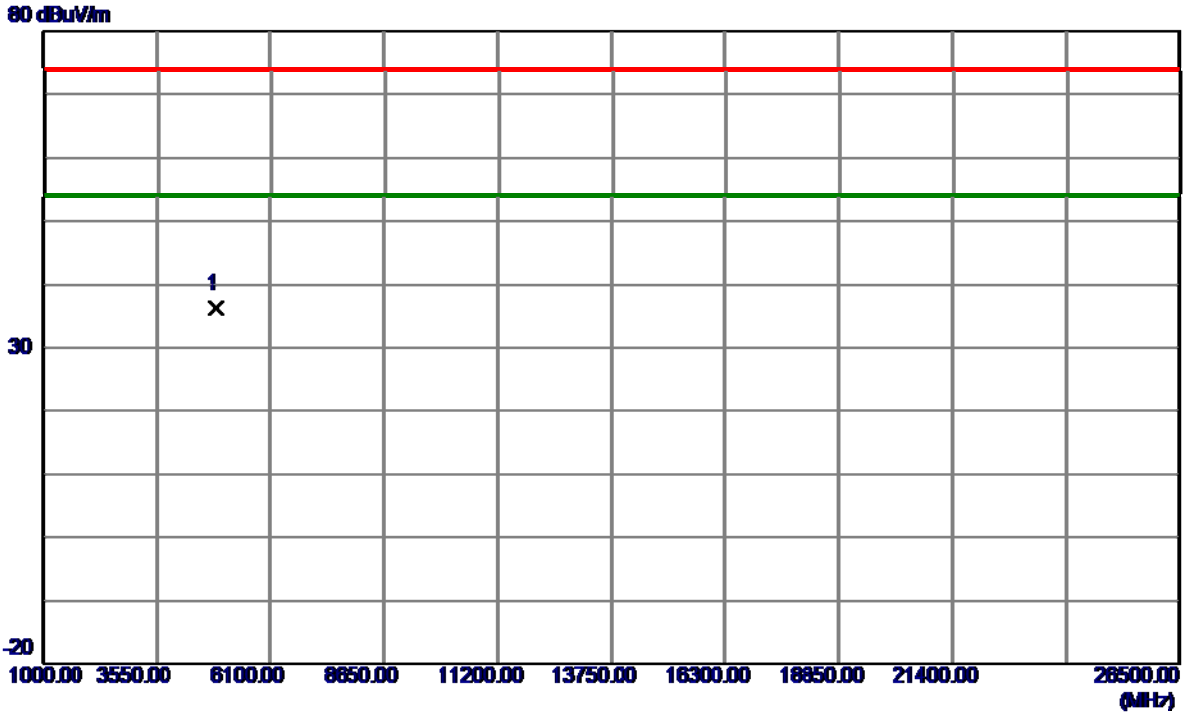

No.	Freq. MHz	Reading Level dBuV/m	Correct Factor dB	Measure ment dBuV/m	Limit dBuV/m	Margin dB	Detector	Comment
1 *	4874.0000	53.03	-16.91	36.12	74.00	-37.88	Peak	

REMARKS:

- (1) Measurement Value = Reading Level + Correct Factor.
- (2) Margin Level = Measurement Value - Limit Value.

Test Mode	TX N(HT20) Mode 2437 MHz	Polarization	Horizontal
-----------	--------------------------	--------------	------------

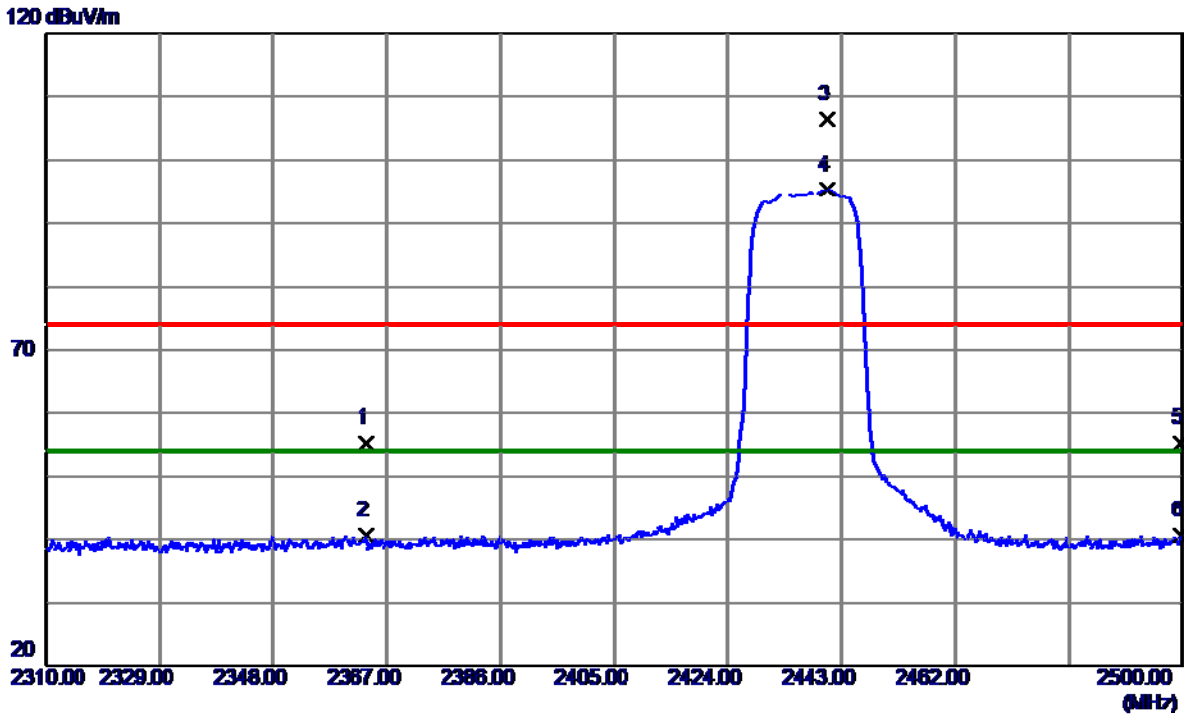

No.	Freq. MHz	Reading Level dBuV/m	Correct Factor dB	Measure ment dBuV/m	Limit dBuV/m	Margin dB	Detector	Comment
1	2363.5800	23.45	31.79	55.24	74.00	-18.76	Peak	
2	2363.5800	8.72	31.79	40.51	54.00	-13.49	AVG	
3	2440.7200	74.72	31.72	106.44	74.00	32.44	Peak	NO limit
4 *	2440.7200	63.58	31.72	95.30	54.00	41.30	AVG	NO limit
5	2499.7150	23.42	31.71	55.13	74.00	-18.87	Peak	
6	2499.7150	8.98	31.71	40.69	54.00	-13.31	AVG	

REMARKS:

- (1) Measurement Value = Reading Level + Correct Factor.
- (2) Margin Level = Measurement Value - Limit Value.

Test Mode	TX N(HT20) Mode 2437 MHz	Polarization	Horizontal
-----------	--------------------------	--------------	------------

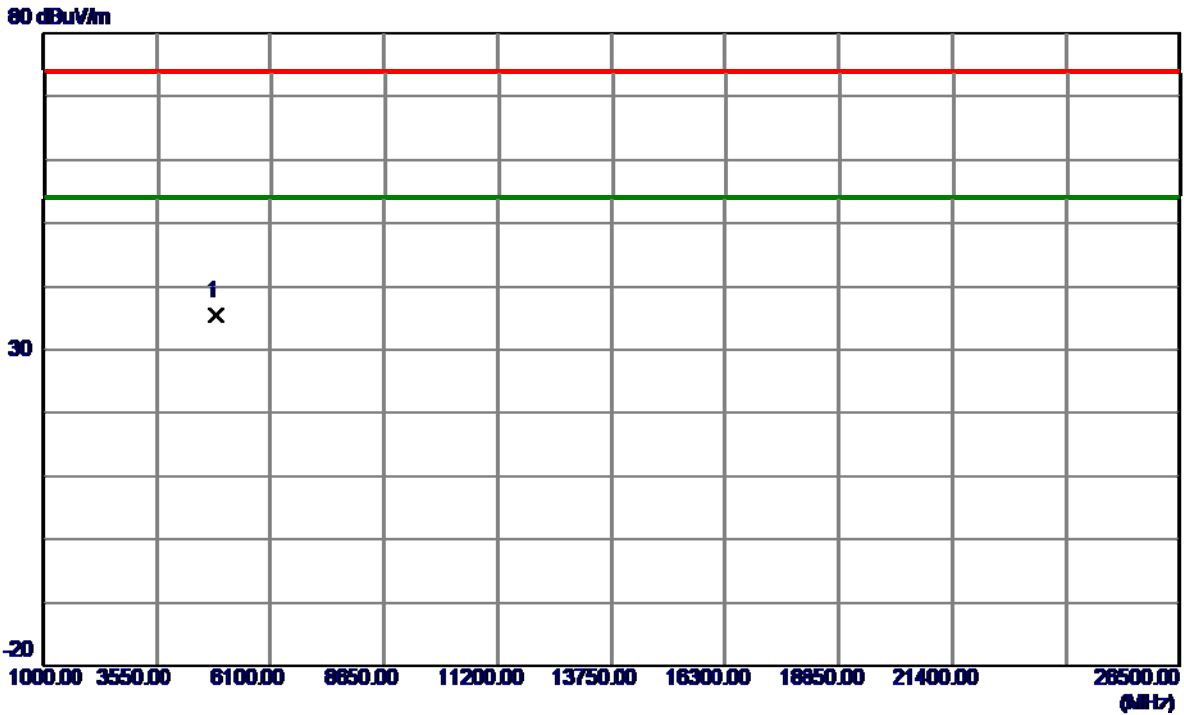

No.	Freq. MHz	Reading Level dBuV/m	Correct Factor dB	Measure ment dBuV/m	Limit dBuV/m	Margin dB	Detector	Comment
1 *	4874.0000	52.29	-16.91	35.38	74.00	-38.62	Peak	

REMARKS:

- (1) Measurement Value = Reading Level + Correct Factor.
- (2) Margin Level = Measurement Value - Limit Value.

Test Mode	TX N(HT20) Mode 2462 MHz	Polarization	Vertical
-----------	--------------------------	--------------	----------

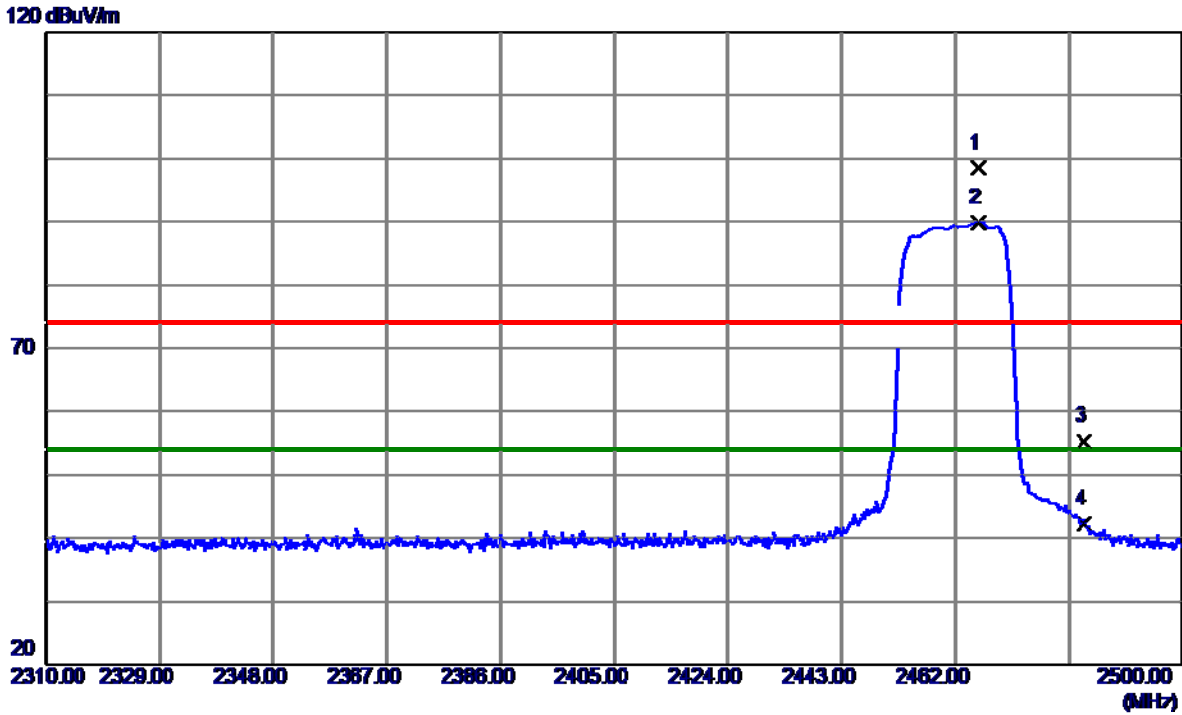

No.	Freq. MHz	Reading Level dBuV/m	Correct Factor dB	Measure ment dBuV/m	Limit dBuV/m	Margin dB	Detector	Comment
1	2465.7050	66.79	31.71	98.50	74.00	24.50	Peak	NO limit
2 *	2465.7050	58.14	31.71	89.85	54.00	35.85	AVG	NO limit
3	2483.5000	23.43	31.71	55.14	74.00	-18.86	Peak	
4	2483.5000	10.40	31.71	42.11	54.00	-11.89	AVG	

REMARKS:

- (1) Measurement Value = Reading Level + Correct Factor.
- (2) Margin Level = Measurement Value - Limit Value.

Test Mode	TX N(HT20) Mode 2462 MHz	Polarization	Vertical
-----------	--------------------------	--------------	----------

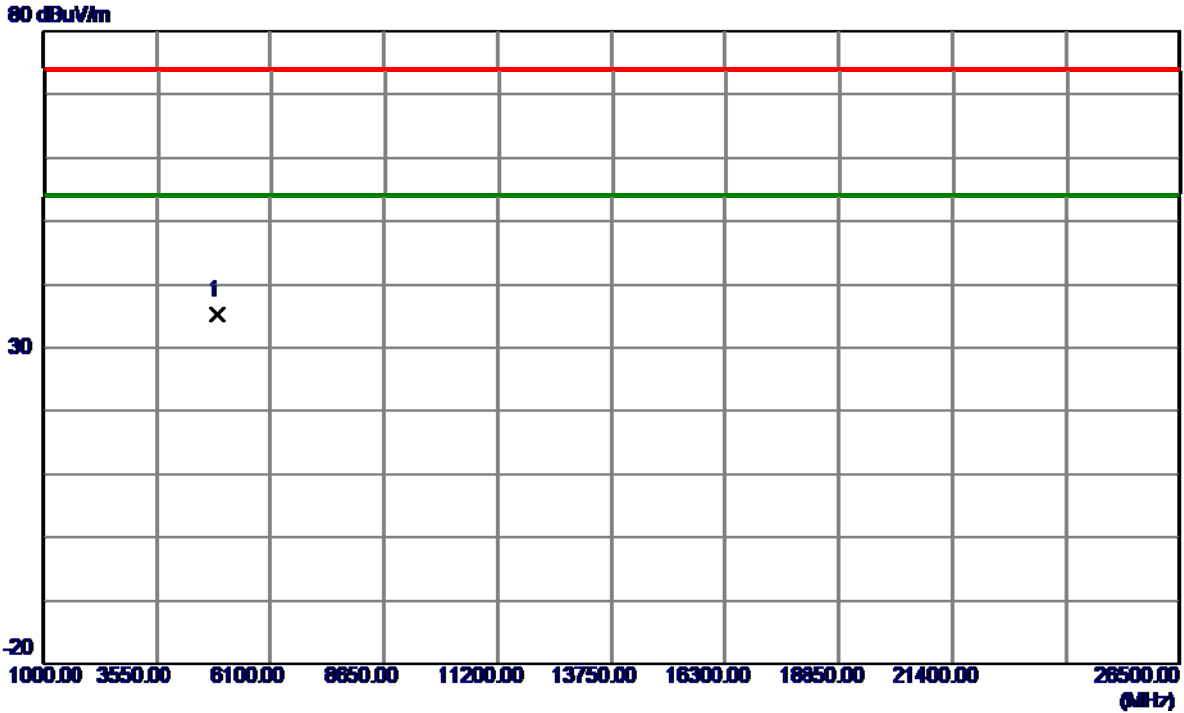

No.	Freq. MHz	Reading Level dBuV/m	Correct Factor dB	Measure ment dBuV/m	Limit dBuV/m	Margin dB	Detector	Comment
1 *	4924.0000	51.96	-16.77	35.19	74.00	-38.81	Peak	

REMARKS:

- (1) Measurement Value = Reading Level + Correct Factor.
- (2) Margin Level = Measurement Value - Limit Value.

Test Mode	TX N(HT20) Mode 2462 MHz	Polarization	Horizontal
-----------	--------------------------	--------------	------------

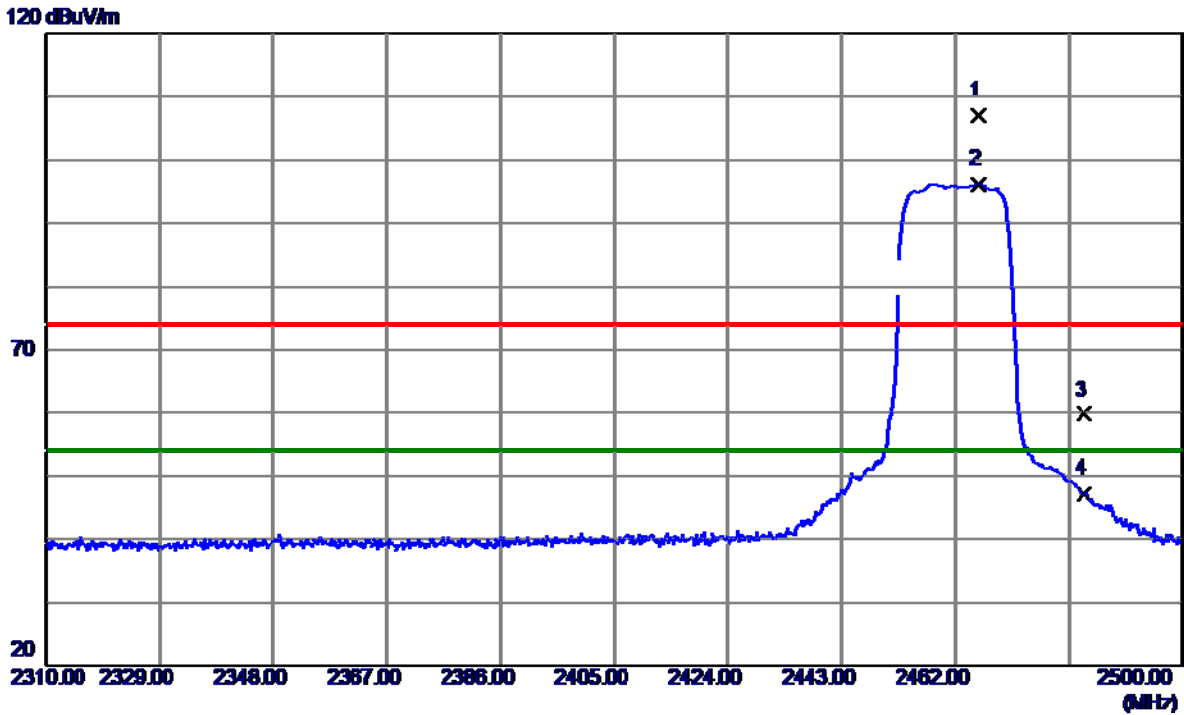

No.	Freq. MHz	Reading Level dBuV/m	Correct Factor dB	Measure ment dBuV/m	Limit dBuV/m	Margin dB	Detector	Comment
1	2465.7050	75.26	31.71	106.97	74.00	32.97	Peak	NO limit
2 *	2465.7050	64.54	31.71	96.25	54.00	42.25	AVG	NO limit
3	2483.5000	27.99	31.71	59.70	74.00	-14.30	Peak	
4	2483.5000	15.53	31.71	47.24	54.00	-6.76	AVG	

REMARKS:

- (1) Measurement Value = Reading Level + Correct Factor.
- (2) Margin Level = Measurement Value - Limit Value.

Test Mode	TX N(HT20) Mode 2462 MHz	Polarization	Horizontal
-----------	--------------------------	--------------	------------

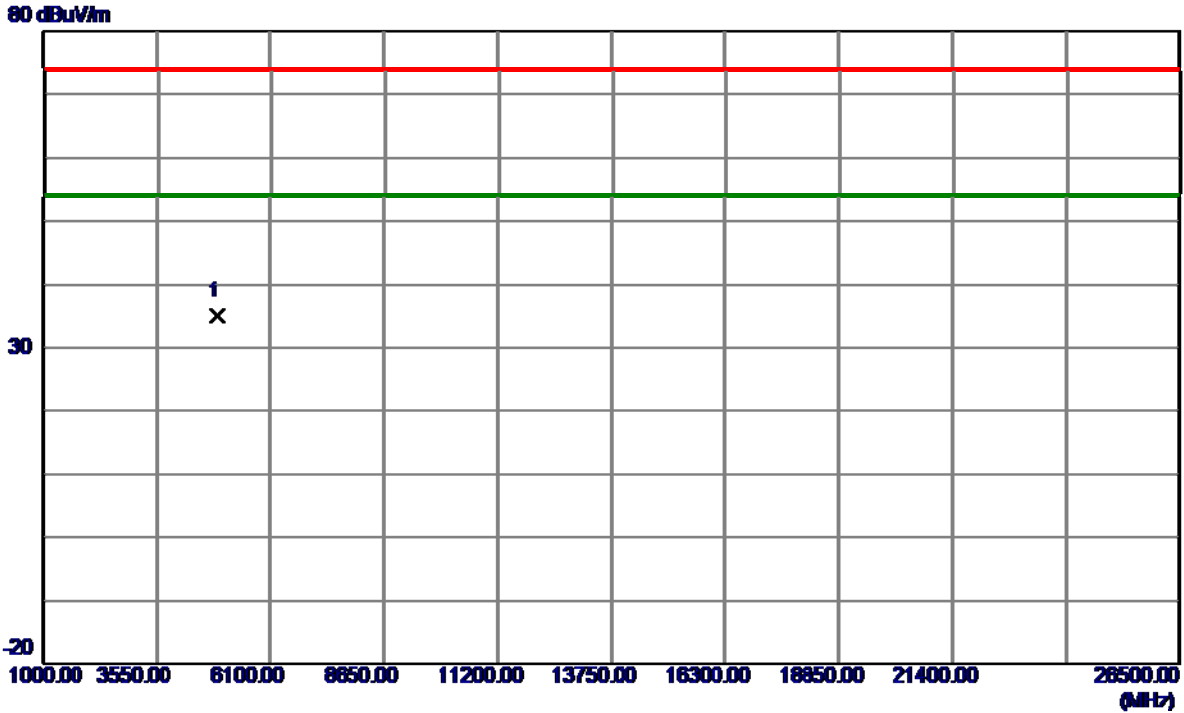

No.	Freq. MHz	Reading Level dBuV/m	Correct Factor dB	Measure ment dBuV/m	Limit dBuV/m	Margin dB	Detector	Comment
1 *	4924.0000	51.74	-16.77	34.97	74.00	-39.03	Peak	

REMARKS:

- (1) Measurement Value = Reading Level + Correct Factor.
- (2) Margin Level = Measurement Value - Limit Value.

APPENDIX E - BANDWIDTH

Test Mode	TX B Mode
-----------	-----------

Channel	Frequency (MHz)	6 dB Bandwidth (MHz)	99 % Occupied Bandwidth (MHz)	6 dB Bandwidth Min. Limit (MHz)	Result
01	2412	12.59	15.36	0.5	Complies
06	2437	12.64	15.44	0.5	Complies
11	2462	12.59	15.44	0.5	Complies

CH01

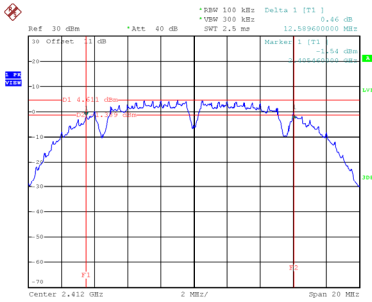

Date: 4.DEC.2021 17:23:31

CH06

6 dB Bandwidth

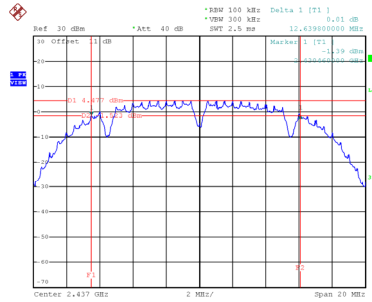

Date: 4.DEC.2021 17:26:56

CH11

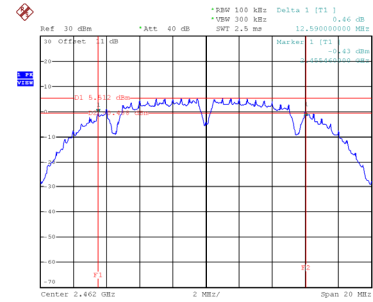

Date: 4.DEC.2021 17:28:30

99 % Occupied Bandwidth

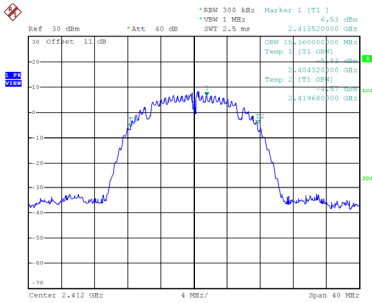

Date: 4.DEC.2021 17:23:38

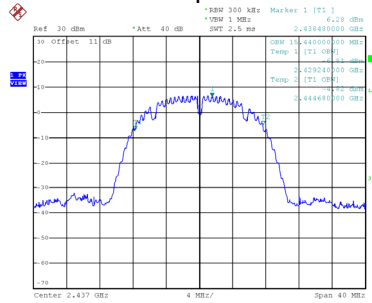

Date: 4.DEC.2021 17:27:03

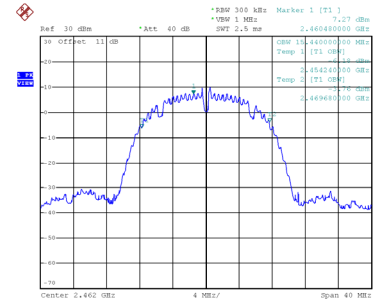

Date: 4.DEC.2021 17:28:44

Test Mode	TX G Mode
-----------	-----------

Channel	Frequency (MHz)	6 dB Bandwidth (MHz)	99 % Occupied Bandwidth (MHz)	6 dB Bandwidth Min. Limit (MHz)	Result
01	2412	15.68	17.28	0.5	Complies
06	2437	15.76	17.28	0.5	Complies
11	2462	15.76	17.20	0.5	Complies

CH01

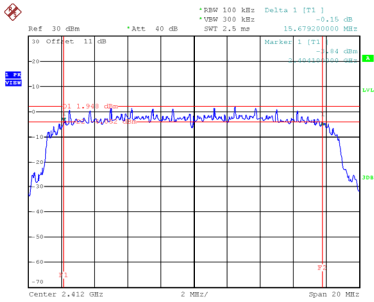

Date: 4.DEC.2021 17:30:15

CH06
6 dB Bandwidth

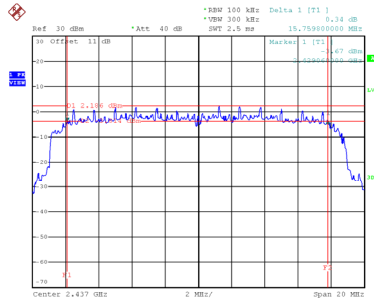

Date: 4.DEC.2021 17:32:58

CH11

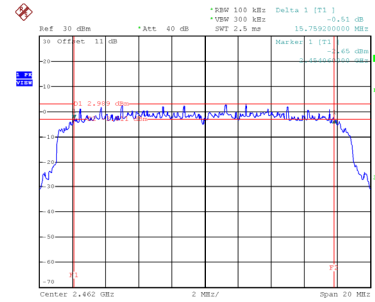

Date: 4.DEC.2021 17:39:15

99 % Occupied Bandwidth

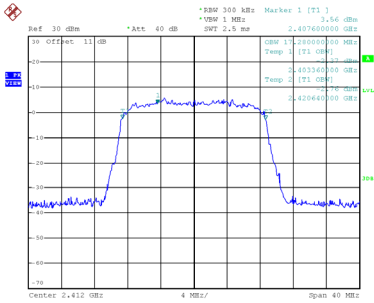

Date: 4.DEC.2021 17:30:22

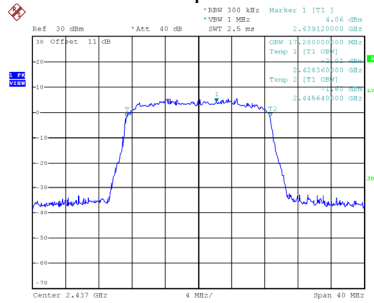

Date: 4.DEC.2021 17:33:05

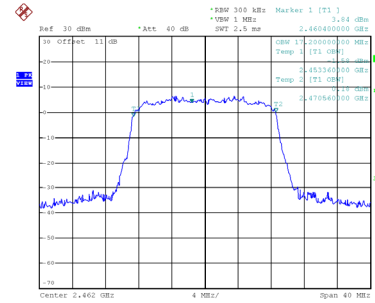

Date: 4.DEC.2021 17:39:22

Test Mode	TX N(HT20) Mode
-----------	-----------------

Channel	Frequency (MHz)	6 dB Bandwidth (MHz)	99 % Occupied Bandwidth (MHz)	6 dB Bandwidth Min. Limit (MHz)	Result
01	2412	15.55	18.16	0.5	Complies
06	2437	15.20	18.08	0.5	Complies
11	2462	15.20	18.08	0.5	Complies

CH01

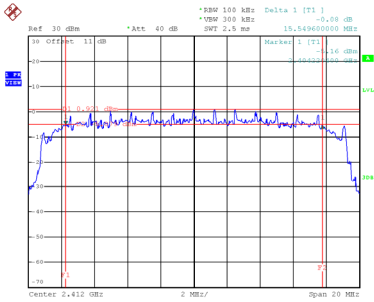

Date: 4.DEC.2021 17:41:05

CH06
6 dB Bandwidth

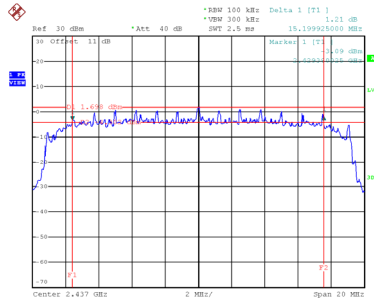

Date: 4.DEC.2021 17:43:26

CH11

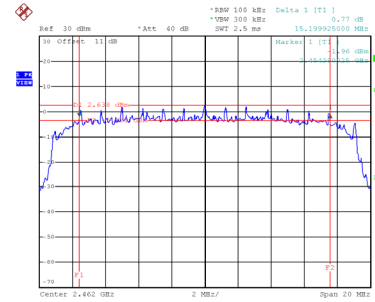

Date: 4.DEC.2021 17:47:10

99 % Occupied Bandwidth

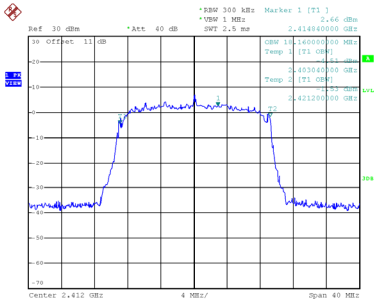

Date: 4.DEC.2021 17:41:12

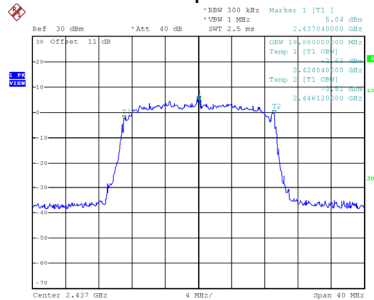

Date: 4.DEC.2021 17:43:32

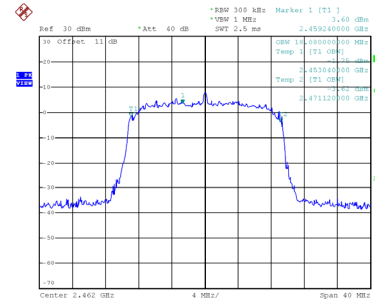

Date: 4.DEC.2021 17:47:25

APPENDIX F - MAXIMUM OUTPUT POWER

Test Mode	TX B Mode_Ant. 1
-----------	------------------

Channel	Frequency (MHz)	Output Power (dBm)	Max. Limit (dBm)	Max. Limit (W)	Result
01	2412	18.57	30.00	1.0000	Complies
06	2437	18.72	30.00	1.0000	Complies
11	2462	19.64	30.00	1.0000	Complies

Test Mode	TX G Mode_Ant. 1
-----------	------------------

Channel	Frequency (MHz)	Output Power (dBm)	Max. Limit (dBm)	Max. Limit (W)	Result
01	2412	22.13	30.00	1.0000	Complies
06	2437	22.58	30.00	1.0000	Complies
11	2462	23.35	30.00	1.0000	Complies

Test Mode	TX N(HT20) Mode_Ant. 1
-----------	------------------------

Channel	Frequency (MHz)	Output Power (dBm)	Max. Limit (dBm)	Max. Limit (W)	Result
01	2412	21.49	30.00	1.0000	Complies
06	2437	21.72	30.00	1.0000	Complies
11	2462	22.67	30.00	1.0000	Complies

APPENDIX G - CONDUCTED SPURIOUS EMISSIONS

Test Mode TX B Mode_Ant. 1

Bandedge-CH01

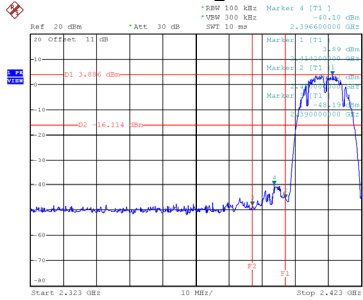

Date: 6.DEC.2021 15:46:52

Bandedge-CH11

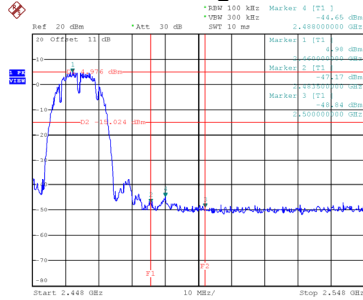

Date: 6.DEC.2021 15:43:24

CH01 – 10th Harmonic of the fundamental frequency

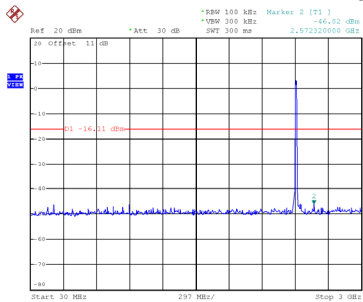

Date: 6.DEC.2021 15:41:05

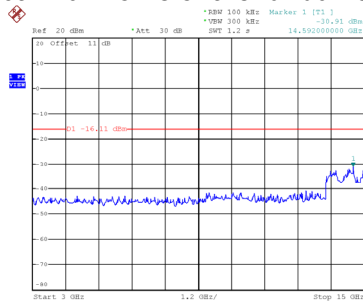

Date: 6.DEC.2021 15:41:12

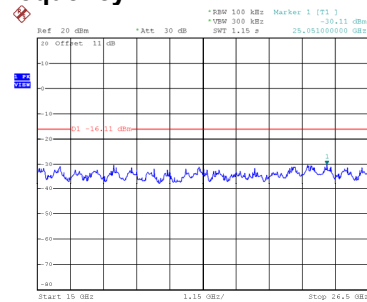

Date: 6.DEC.2021 15:41:19

CH06 – 10th Harmonic of the fundamental frequency

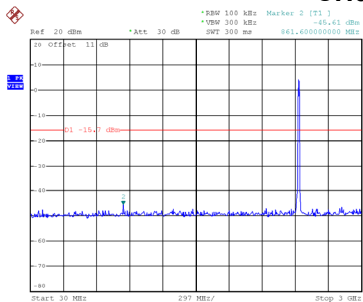

Date: 6.DEC.2021 15:41:59

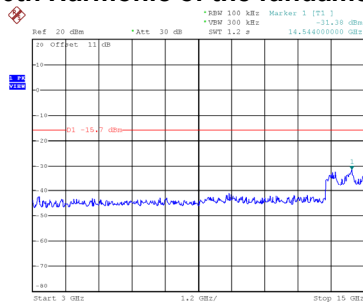

Date: 6.DEC.2021 15:42:06

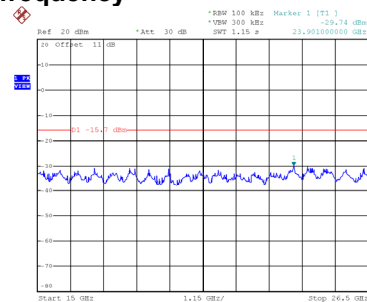

Date: 6.DEC.2021 15:42:14

CH11 – 10th Harmonic of the fundamental frequency

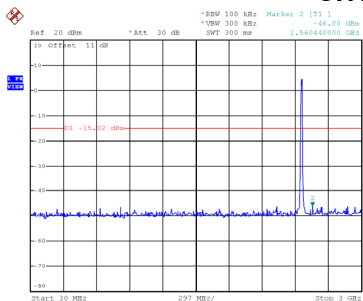

Date: 6.DEC.2021 15:43:38

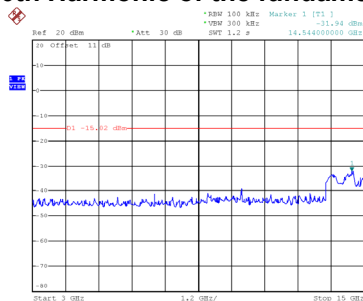

Date: 6.DEC.2021 15:43:45

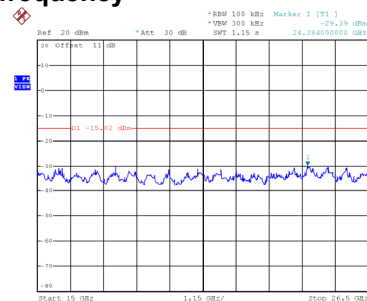

Date: 6.DEC.2021 15:43:52

Test Mode TX G Mode_Ant. 1

Bandedge-CH01

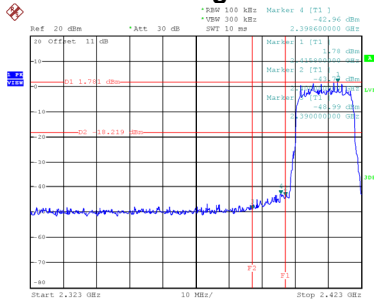

Date: 6.DEC.2021 15:44:20

Bandedge-CH11

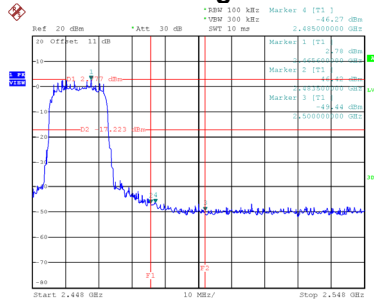

Date: 6.DEC.2021 15:46:17

CH01 – 10th Harmonic of the fundamental frequency

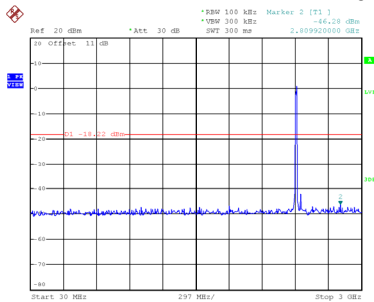

Date: 6.DEC.2021 15:44:33

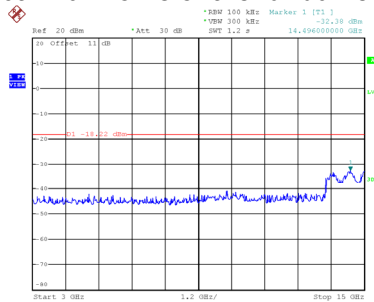

Date: 6.DEC.2021 15:44:41

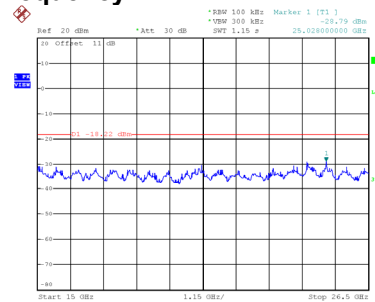

Date: 6.DEC.2021 15:44:48

CH06 – 10th Harmonic of the fundamental frequency

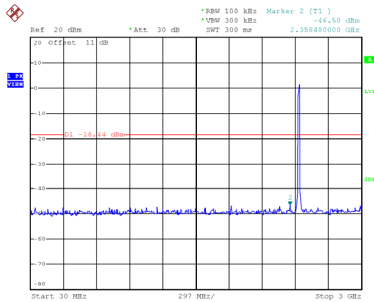

Date: 6.DEC.2021 15:45:26

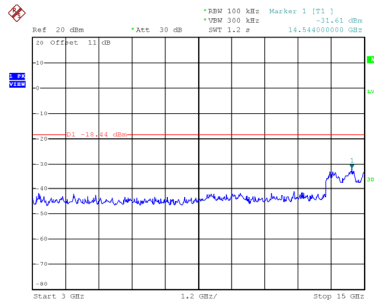

Date: 6.DEC.2021 15:45:33

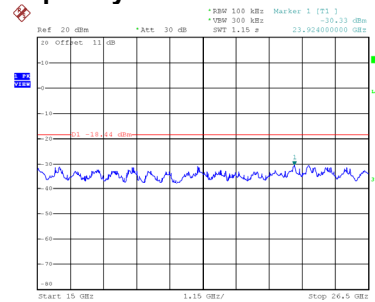

Date: 6.DEC.2021 15:45:40

CH11 – 10th Harmonic of the fundamental frequency

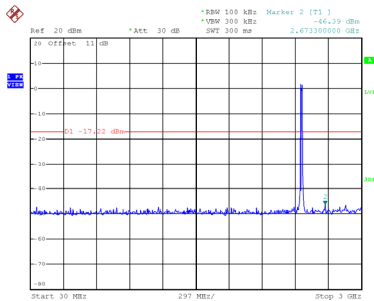

Date: 6.DEC.2021 15:46:30

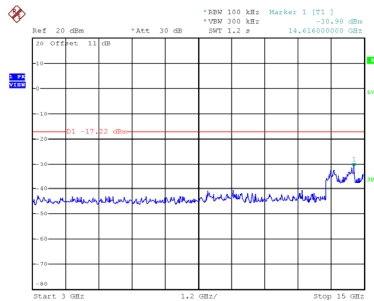

Date: 6.DEC.2021 15:46:37

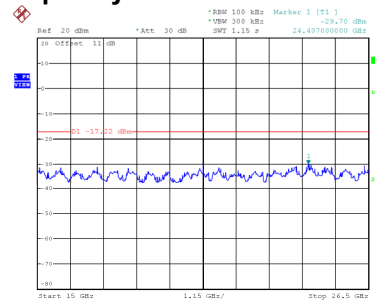

Date: 6.DEC.2021 15:46:45

Test Mode TX N(HT20) Mode_Ant. 1

Bandedge-CH01

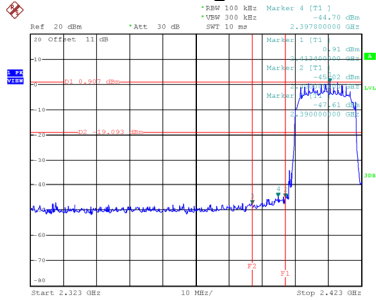

Date: 6.DEC.2021 15:47:11

Bandedge-CH11

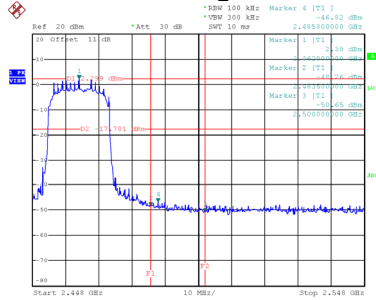

Date: 6.DEC.2021 15:48:47

CH01 – 10th Harmonic of the fundamental frequency

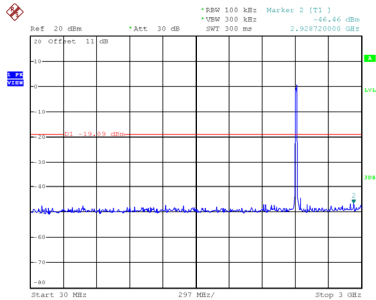

Date: 6.DEC.2021 15:47:24

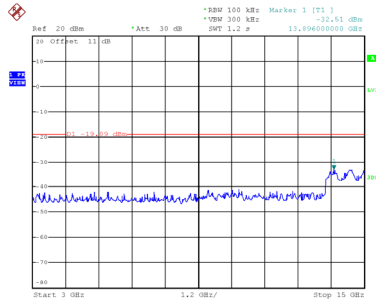

Date: 6.DEC.2021 15:47:32

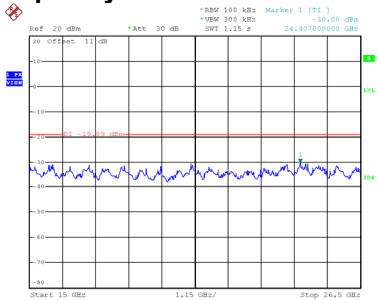

Date: 6.DEC.2021 15:47:39

CH06 – 10th Harmonic of the fundamental frequency

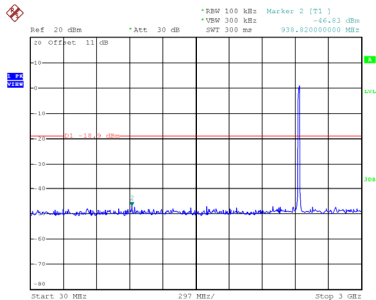

Date: 6.DEC.2021 15:48:11

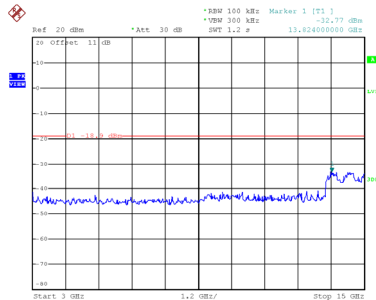

Date: 6.DEC.2021 15:48:19

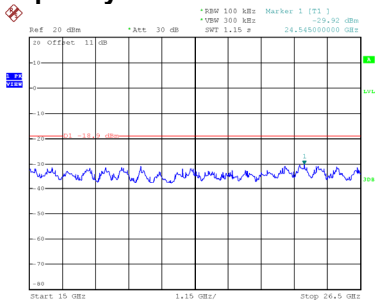

Date: 6.DEC.2021 15:48:26

CH11 – 10th Harmonic of the fundamental frequency

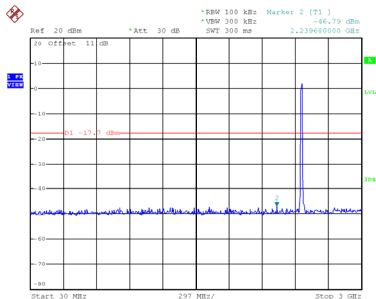

Date: 6.DEC.2021 15:49:00

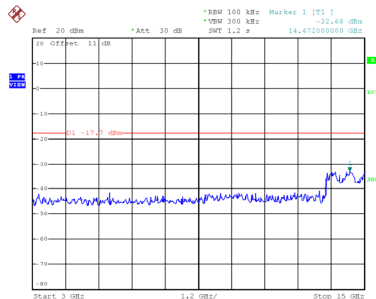

Date: 6.DEC.2021 15:49:08

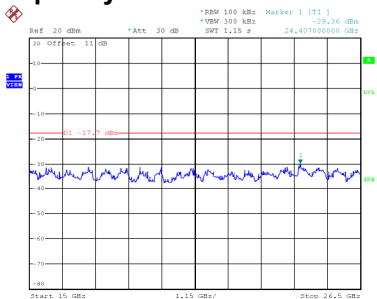

Date: 6.DEC.2021 15:49:15

APPENDIX H - POWER SPECTRAL DENSITY

Test Mode	TX B Mode_Ant. 1
-----------	------------------

Channel	Frequency (MHz)	Power Spectral Density (dBm/3kHz)	Max. Limit (dBm/3kHz)	Result
01	2412	-8.16	8.00	Complies
06	2437	-8.05	8.00	Complies
11	2462	-7.13	8.00	Complies

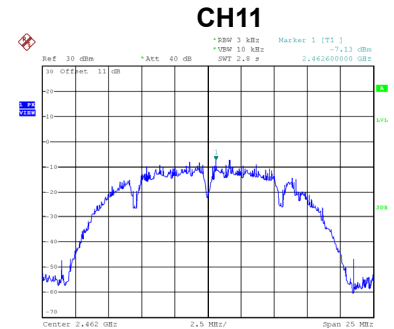
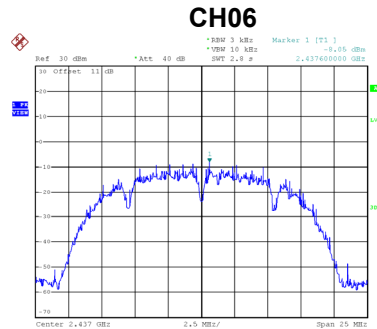
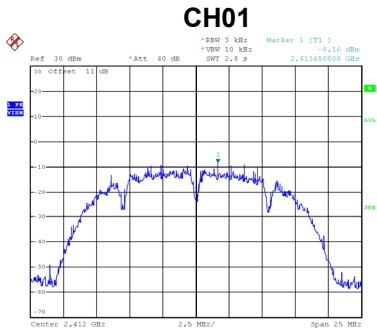

Test Mode	TX G Mode_Ant. 1
-----------	------------------

Channel	Frequency (MHz)	Power Spectral Density (dBm/3kHz)	Max. Limit (dBm/3kHz)	Result
01	2412	-12.60	8.00	Complies
06	2437	-11.07	8.00	Complies
11	2462	-11.50	8.00	Complies

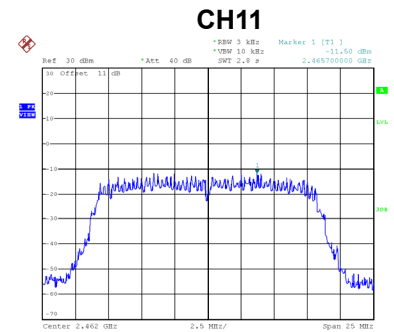
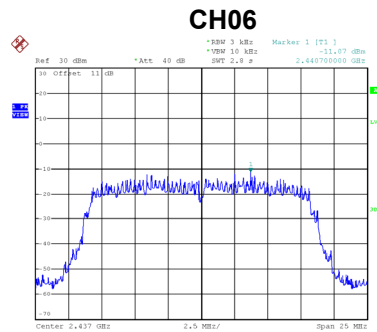
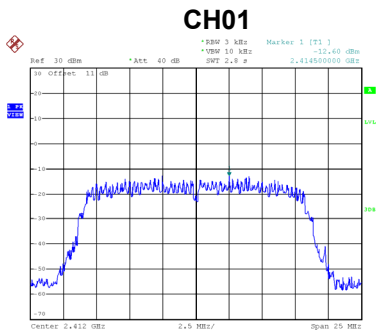

Test Mode	TX N(HT20) Mode_Ant. 1
-----------	------------------------

Channel	Frequency (MHz)	Power Spectral Density (dBm/3kHz)	Max. Limit (dBm/3kHz)	Result
01	2412	-14.31	8.00	Complies
06	2437	-14.44	8.00	Complies
11	2462	-13.42	8.00	Complies

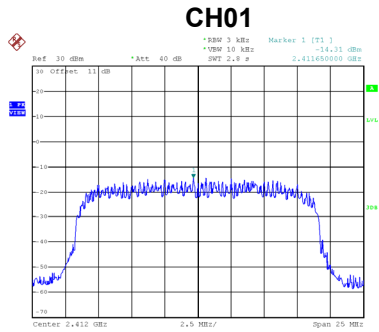

Date: 4.DEC.2021 17:41:55

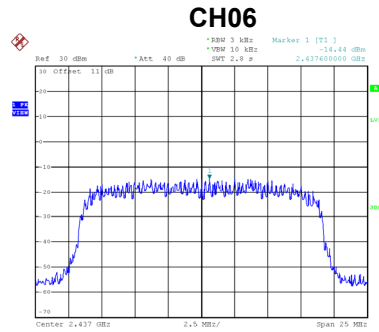

Date: 4.DEC.2021 17:44:16

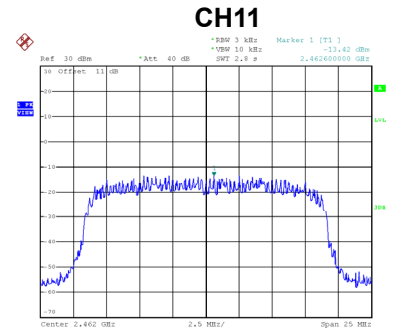

Date: 4.DEC.2021 17:48:08

End of Test Report