



**Shenzhen CTA Testing Technology Co., Ltd**

Room 106, Building 1, Yibaolai Industrial Park, Qiaotou Community, Fuhai Street, Bao'an District, Shenzhen, China

**TEST REPORT  
FCC Rules and Regulations Part PART 15.249**

**Report Reference No.....: CTA24092400401**

**FCC ID.....: 2BE3B-UJ99**

Compiled by  
( position+printed name+signature.. File administrators Jinghua Xiao

Supervised by  
( position+printed name+signature.. Project Engineer Xudong Zhang

Approved by  
( position+printed name+signature.. RF Manager Eric Wang

Date of issue..... Sep. 26, 2024

*Jinghua Xiao*  
*Xudong Zhang*  
*Eric Wang*  
**approved**

**Testing Laboratory Name ..... Shenzhen CTA Testing Technology Co., Ltd**  
Address ..... Room 106, Building 1, Yibaolai Industrial Park, Qiaotou Community, Fuhai Street, Bao'an District, Shenzhen, China

**Applicant's name ..... Shenzhen Jialetong Technology Co., Ltd**  
Address ..... 302, No.18, Zone 1, 5th Industrial Zone, Shangfen Community, Minzhi Street, Longhua, Shenzhen, Guangdong, China

**Standard ..... FCC Rules and Regulations PART 15.249**

**Shenzhen CTA Testing Technology Co., Ltd All rights reserved.**  
This publication may be reproduced in whole or in part for non-commercial purposes as long as the Shenzhen CTA Testing Technology Co., Ltd is acknowledged as copyright owner and source of the material. Shenzhen CTA Testing Technology Co., Ltd takes no responsibility for and will not assume liability for damages resulting from the reader's interpretation of the reproduced material due to its placement and context.

**Test item description ..... Remote control toys**  
Trade Mark ..... Kelaton  
Manufacturer ..... Shenzhen Jialetong Technology Co., Ltd  
Model/Type reference..... UJ99  
Listed Models ..... Refer to page 2  
Modulation ..... GFSK  
Frequency..... 2407MHz  
Ratings ..... DC 3.0V From battery  
Result..... **PASS**

# TEST REPORT

Equipment under Test : Remote control toys

Model /Type : UJ99

Listed Models

: YL-101, YL-102, YL-103, CV-C700, HD3366, 8601, S811, S812, 1841-1, 1841-2, 2277, 2377, YL-92, YL-92-1, YL-104, YL-104-1, CV-B800, JD155-7A, JD155-8A, BC1031, BC1034, BC1035, BC1047, 3349, SC16A01, SC16A02, SC16A03, SC16A04, SC16A05, SC16A06, SC16A07, SC16A08, RC-18A, RC-18B, RC-18C, RC-18D, RC-19A, RC-19B, RC-19C, RC-19D, 70010, 70011, 70012, 70013, 70014, 70015, 70016, 70017, 70018, 70019, 70030, 70031, 70050, 70051, 70052, 70053

Applicant : Shenzhen Jialetong Technology Co., Ltd

Address : 3302, No.18, Zone 1, 5th Industrial Zone, Shangfen Community, Minzhi Street, Longhua, Shenzhen, Guangdong, China

Manufacturer : Shenzhen Jialetong Technology Co., Ltd

Address : 302, No.18, Zone 1, 5th Industrial Zone, Shangfen Community, Minzhi Street, Longhua, Shenzhen, Guangdong, China

<b>Test Result:</b>	<b>PASS</b>
---------------------	-------------

The test report merely corresponds to the test sample.  
It is not permitted to copy extracts of these test result without the written permission of the test laboratory.

## Contents

<b>1.</b>	<b><u>TEST STANDARDS</u></b> .....	<b>4</b>
<b>2.</b>	<b><u>SUMMARY</u></b> .....	<b>5</b>
2.1.	General Remarks	5
2.2.	Product Description	5
2.3.	Equipment Under Test	5
2.4.	Short description of the Equipment under Test (EUT)	5
2.5.	EUT operation mode	6
2.6.	Block Diagram of Test Setup	6
2.7.	Modifications	6
<b>3.</b>	<b><u>TEST ENVIRONMENT</u></b> .....	<b>7</b>
3.1.	Address of the test laboratory	7
3.2.	Test Facility	7
3.3.	Environmental conditions	7
3.4.	Summary of measurement results	8
3.5.	Statement of the measurement uncertainty	8
3.6.	Equipments Used during the Test	8
<b>4.</b>	<b><u>TEST CONDITIONS AND RESULTS</u></b> .....	<b>10</b>
4.1.	AC Power Conducted Emission .....	10
4.2.	Radiated Emission and Band Edges .....	11
4.3.	20dB Bandwidth Measurement .....	16
4.4.	Antenna Requirement.....	18
<b>5.</b>	<b><u>TEST SETUP PHOTOS OF THE EUT</u></b> .....	<b>19</b>
<b>6.</b>	<b><u>TEST PHOTOS OF THE EUT</u></b> .....	<b>20</b>

## **1. TEST STANDARDS**

The tests were performed according to following standards:

**FCC Rules Part 15.249:** Operation within the bands 902 - 928 MHz, 2400 - 2483.5 MHz, 5725 - 5875 MHz, and 24.0 - 24.25 GHz.

**ANSI C63.10:2013 :** American National Standard for Testing Unlicensed Wireless Devices

**ANSI C63.4: 2014:** –American National Standard for Methods of Measurement of Radio-Noise Emissions from Low-Voltage Electrical and Electronic Equipment in the Range of 9 kHz to 40GHz  
Range of 9 kHz to 40GHz

## 2. SUMMARY

### 2.1. General Remarks

Date of receipt of test sample	:	Sep. 22, 2024
Testing commenced on	:	Sep. 22, 2024
Testing concluded on	:	Sep. 26, 2024

### 2.2. Product Description

Name of EUT	Remote control toys
Model Number	UJ99
Power Rating	DC 3.0V From battery
Hardware version	V1.0
Software version	V1.0
Sample ID	CTA240924004-1# (Engineer sample) CTA240924004-2# (Normal sample)
Operation frequency	2407MHz
Modulation	GFSK
Antenna Type	Internal antenna
Antenna Gain	0.55 dBi

### 2.3. Equipment Under Test

#### Power supply system utilised

Power supply voltage	:	<input type="radio"/> 230V / 50 Hz	<input type="radio"/> 120V / 60Hz
		<input type="radio"/> 12 V DC	<input type="radio"/> 24 V DC
		<input checked="" type="radio"/> Other (specified in blank below)	

DC 3.0V From battery

### 2.4. Short description of the Equipment under Test (EUT)

This is a Remote control toys.

For more details, refer to the user's manual of the EUT.

## 2.5. EUT operation mode

The Applicant use Key to control the EUT for staying in continuous transmitting and receiving mode for testing. There is 1 channel provided to the EUT.

### Operation Frequency:

Channel	Frequency (MHz)
1	2407

Test frequency:

Channel	Frequency (MHz)
Low	2407

## 2.6. Block Diagram of Test Setup

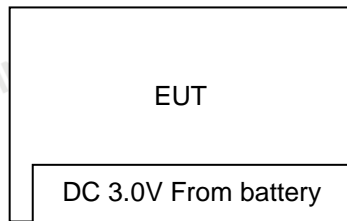

## 2.7. Modifications

No modifications were implemented to meet testing criteria.

### **3. TEST ENVIRONMENT**

#### **3.1. Address of the test laboratory**

**Shenzhen CTA Testing Technology Co., Ltd**

Room 106, Building 1, Yibaolai Industrial Park, Qiaotou Community, Fuhai Street, Bao'an District, Shenzhen, China

#### **3.2. Test Facility**

The test facility is recognized, certified, or accredited by the following organizations:

**FCC-Registration No.: 517856    Designation Number: CN1318**

Shenzhen CTA Testing Technology Co., Ltd has been listed on the US Federal Communications Commission list of test facilities recognized to perform electromagnetic emissions measurements.

**Industry Canada Registration Number. Is: 27890    CAB identifier: CN0127**

The Laboratory has been registered by Certification and Engineering Bureau of Industry Canada for radio equipment testing.

**A2LA-Lab Cert. No.: 6534.01**

Shenzhen CTA Testing Technology Co., Ltd has been listed by American Association for Laboratory Accreditation to perform electromagnetic emission measurement.

The 3m-Semi anechoic test site fulfils CISPR 16-1-4 according to ANSI C63.10 and CISPR 16-1-4:2010.

#### **3.3. Environmental conditions**

During the measurement the environmental conditions were within the listed ranges:

Radiated Emission:

Temperature:	23 ° C
Humidity:	48 %
Atmospheric pressure:	950-1050mbar

AC Main Conducted testing:

Temperature:	24 ° C
Humidity:	45 %
Atmospheric pressure:	950-1050mbar

Conducted testing:

Temperature:	24 ° C
Humidity:	45 %
Atmospheric pressure:	950-1050mbar

### 3.4. Summary of measurement results

FCC PART 15.249		
FCC Part 15.249(a)	Field Strength of Fundamental	PASS
FCC Part 15.209	Spurious Emission	PASS
FCC Part 15.209	Band edge	PASS
FCC Part 15.215(c)	20dB bandwidth	PASS
FCC Part 15.207	Conducted Emission	N/A
FCC Part 15.203	Antenna Requirement	PASS

### 3.5. Statement of the measurement uncertainty

The data and results referenced in this document are true and accurate. The reader is cautioned that there may be errors within the calibration limits of the equipment and facilities. The measurement uncertainty was calculated for all measurements listed in this test report acc. to TR-100028-01 "Electromagnetic compatibility and Radio spectrum Matters (ERM);Uncertainties in the measurement of mobile radio equipment characteristics; Part 1" and TR-100028-02 "Electromagnetic compatibility and Radio spectrum Matters (ERM);Uncertainties in the measurement of mobile radio equipment characteristics; Part 2 " and is documented in the Shenzhen CTA Testing Technology Co., Ltd quality system acc. to DIN EN ISO/IEC 17025. Furthermore, component and process variability of devices similar to that tested may result in additional deviation. The manufacturer has the sole responsibility of continued compliance of the device.

Hereafter the best measurement capability for Shenzhen CTA Testing Technology Co., Ltd :

Test	Range	Measurement Uncertainty	Notes
Radiated Emission	9KHz~30MHz	3.02 dB	(1)
Radiated Emission	30~1000MHz	4.06 dB	(1)
Radiated Emission	1~18GHz	5.14 dB	(1)
Radiated Emission	18-40GHz	5.38 dB	(1)
Conducted Disturbance	0.15~30MHz	2.14 dB	(1)
Output Peak power	30MHz~18GHz	0.55 dB	(1)
Power spectral density	/	0.57 dB	(1)
Spectrum bandwidth	/	1.1%	(1)
Radiated spurious emission (30MHz-1GHz)	30~1000MHz	4.10 dB	(1)
Radiated spurious emission (1GHz-18GHz)	1~18GHz	4.32 dB	(1)
Radiated spurious emission (18GHz-40GHz)	18-40GHz	5.54 dB	(1)

(1)This uncertainty represents an expanded uncertainty expressed at approximately the 95% confidence level using a coverage factor of k=2.

### 3.6. Equipments Used during the Test

Test Equipment	Manufacturer	Model No.	Equipment No.	Calibration Date	Calibration Due Date
LISN	R&S	ENV216	CTA-308	2024/08/03	2025/08/02
LISN	R&S	ENV216	CTA-314	2024/08/03	2025/08/02
EMI Test Receiver	R&S	ESPI	CTA-307	2024/08/03	2025/08/02
EMI Test Receiver	R&S	ESCI	CTA-306	2024/08/03	2025/08/02
Spectrum Analyzer	Agilent	N9020A	CTA-301	2024/08/03	2025/08/02



Spectrum Analyzer	R&S	FSU	CTA-337	2024/08/03	2025/08/02
Vector Signal generator	Agilent	N5182A	CTA-305	2024/08/03	2025/08/02
Analog Signal Generator	R&S	SML03	CTA-304	2024/08/03	2025/08/02
WIDEBAND RADIO COMMUNICATION TESTER	CMW500	R&S	CTA-302	2024/08/03	2025/08/02
Temperature and humidity meter	Chigo	ZG-7020	CTA-326	2024/08/03	2025/08/02
Ultra-Broadband Antenna	Schwarzbeck	VULB9163	CTA-310	2023/10/17	2024/10/16
Horn Antenna	Schwarzbeck	BBHA 9120D	CTA-309	2023/10/13	2024/10/12
Loop Antenna	Zhinan	ZN30900C	CTA-311	2023/10/17	2024/10/16
Horn Antenna	Beijing Hangwei Dayang	OBH100400	CTA-336	2023/10/17	2024/10/16
Amplifier	Schwarzbeck	BBV 9745	CTA-312	2024/08/03	2025/08/02
Amplifier	Taiwan chengyi	EMC051845B	CTA-313	2024/08/03	2025/08/02
Directional coupler	NARDA	4226-10	CTA-303	2024/08/03	2025/08/02
High-Pass Filter	XingBo	XBLBQ-GTA18	CTA-402	2024/08/03	2025/08/02
High-Pass Filter	XingBo	XBLBQ-GTA27	CTA-403	2024/08/03	2025/08/02
Automated filter bank	Tonscend	JS0806-F	CTA-404	2024/08/03	2025/08/02
Power Sensor	Agilent	U2021XA	CTA-405	2024/08/03	2025/08/02
Amplifier	Schwarzbeck	BBV9719	CTA-406	2024/08/03	2025/08/02

Test Equipment	Manufacturer	Model No.	Version number	Calibration Date	Calibration Due Date
EMI Test Software	Tonscend	TS@JS32-RE	5.0.0.2	N/A	N/A
EMI Test Software	Tonscend	TS@JS32-CE	5.0.0.1	N/A	N/A
RF Test Software	Tonscend	TS@JS1120-3	3.1.65	N/A	N/A
RF Test Software	Tonscend	TS@JS1120	3.1.46	N/A	N/A

## 4. TEST CONDITIONS AND RESULTS

### 4.1. AC Power Conducted Emission

#### TEST CONFIGURATION

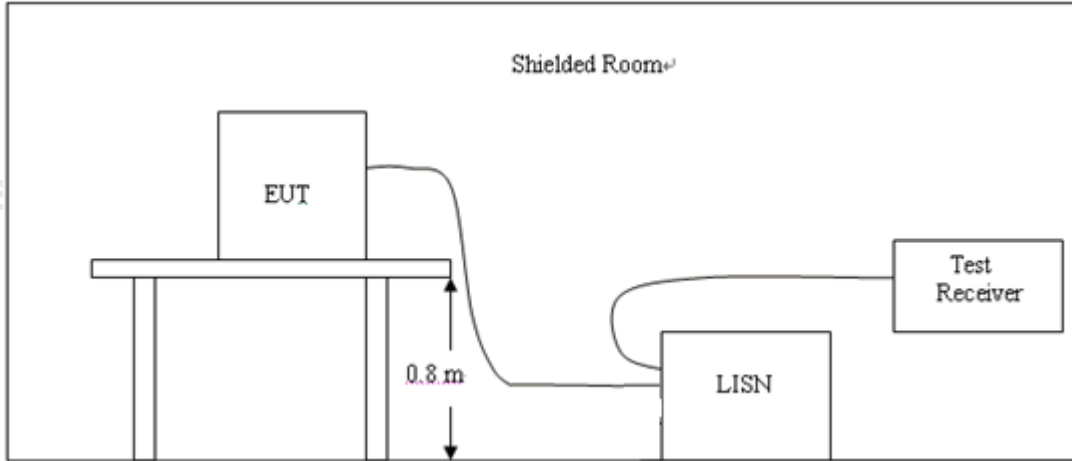

#### TEST PROCEDURE

- 1, The equipment was set up as per the test configuration to simulate typical actual usage per the user's manual. The EUT is a tabletop system, a wooden table with a height of 0.8 meters is used and is placed on the ground plane as per ANSI C63.10.
- 2, Support equipment, if needed, was placed as per ANSI C63.10.
- 3, All I/O cables were positioned to simulate typical actual usage as per ANSI C63.10.
- 4, If a EUT received DC power from the USB Port of Notebook PC, the PC's adapter received power through a Line Impedance Stabilization Network (LISN) which supplied power source and was grounded to the ground plane.
- 5, All support equipments received AC power from a second LISN, if any.
- 6, The EUT test program was started. Emissions were measured on each current carrying line of the EUT using a spectrum Analyzer / Receiver connected to the LISN powering the EUT. The LISN has two monitoring points: Line 1 (Hot Side) and Line 2 (Neutral Side). Two scans were taken: one with Line 1 connected to Analyzer / Receiver and Line 2 connected to a 50 ohm load; the second scan had Line 1 connected to a 50 ohm load and Line 2 connected to the Analyzer / Receiver.
- 7, Analyzer / Receiver scanned from 150 KHz to 30MHz for emissions in each of the test modes.

#### AC Power Conducted Emission Limit

For intentional device, according to § 15.207(a) AC Power Conducted Emission Limits is as following :

Frequency range (MHz)	Limit (dBuV)	
	Quasi-peak	Average
0.15-0.5	66 to 56*	56 to 46*
0.5-5	56	46
5-30	60	50

\* Decreases with the logarithm of the frequency.

#### TEST RESULTS

The EUT is powered by the Battery, so this test item is not applicable for the EUT.

### 4.2. Radiated Emission and Band Edges

#### TEST CONFIGURATION

Frequency range 9 KHz – 30MHz

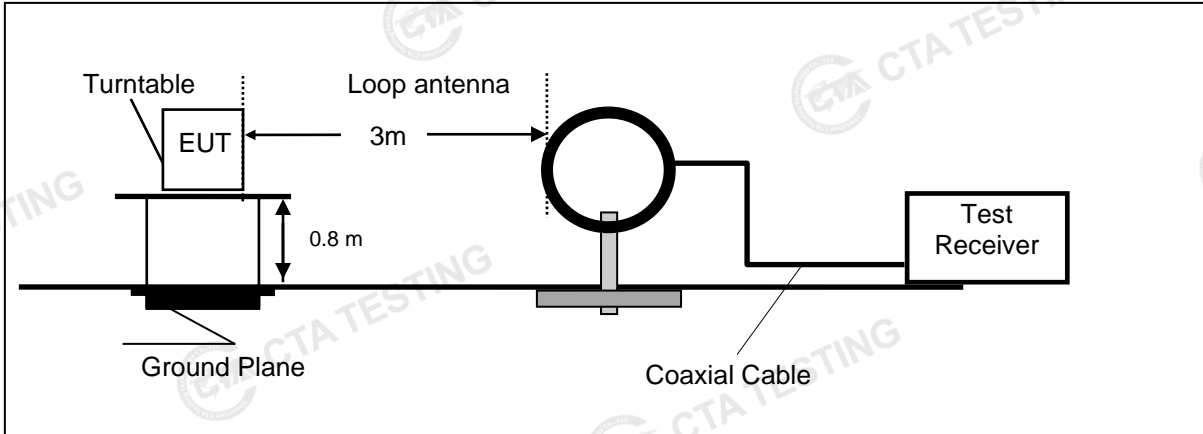

Frequency range 30MHz – 1000MHz

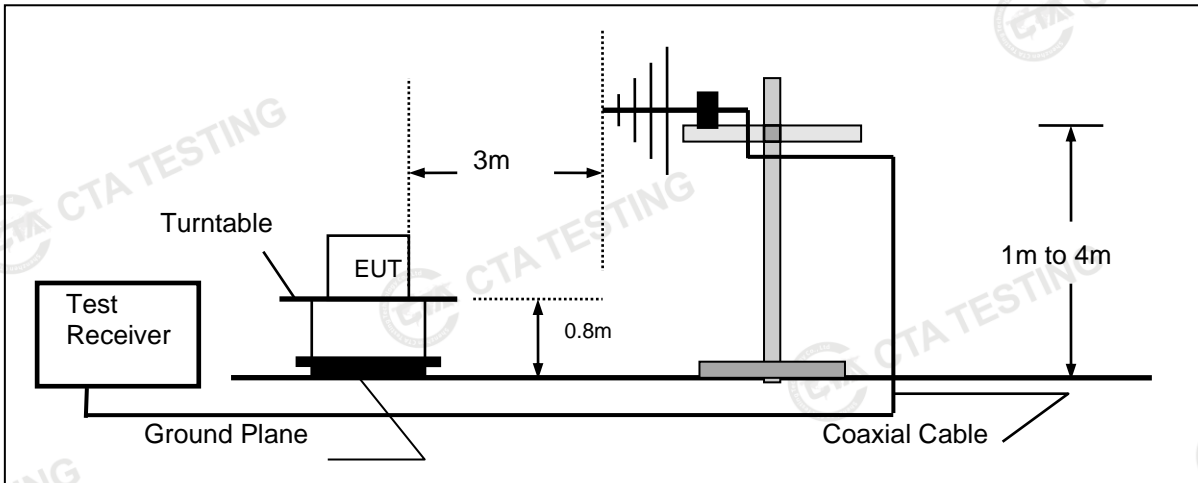

Frequency range above 1GHz-25GHz

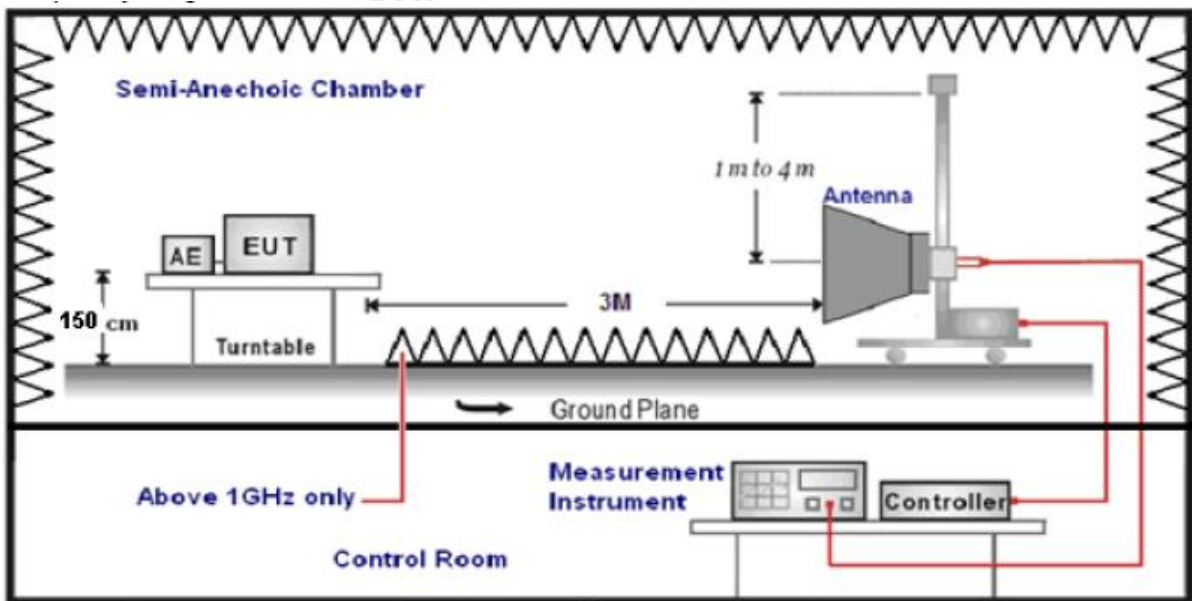

**TEST PROCEDURE**

1. The EUT was placed on a turn table which is 0.8m above ground plane when testing frequency range 9 KHz –25GHz.
2. Maximum procedure was performed by raising the receiving antenna from 1m to 4m and rotating the turn table from 0°C to 360°C to acquire the highest emissions from EUT.
3. And also, each emission was to be maximized by changing the polarization of receiving antenna both horizontal and vertical.
4. Repeat above procedures until all frequency measurements have been completed.
5. The EUT minimum operation frequency was 26MHz and maximum operation frequency was 1910MHz.so radiated emission test frequency band from 9KHz to 25GHz.
6. The distance between test antenna and EUT as following table states:

Test Frequency range	Test Antenna Type	Test Distance
9KHz-30MHz	Active Loop Antenna	3
30MHz-1GHz	Ultra-Broadband Antenna	3
1GHz-18GHz	Double Ridged Horn Antenna	3
18GHz-25GHz	Horn Antenna	1

7. Setting test receiver/spectrum as following table states:

Test Frequency range	Test Receiver/Spectrum Setting	Detector
9KHz-150KHz	RBW=200Hz/VBW=3KHz, Sweep time=Auto	QP
150KHz-30MHz	RBW=9KHz/VBW=100KHz, Sweep time=Auto	QP
30MHz-1GHz	RBW=120KHz/VBW=1000KHz, Sweep time=Auto	QP
1GHz-40GHz	Peak Value: RBW=1MHz/VBW=3MHz, Sweep time=Auto Average Value: RBW=1MHz/VBW=10Hz, Sweep time=Auto	Peak

**Field Strength Calculation**

The field strength is calculated by adding the Antenna Factor and Cable Factor and subtracting the Amplifier Gain and Duty Cycle Correction Factor(if any) from the measured reading. The basic equation with a sample calculation is as follows:

**FS = RA + AF + CL - AG**

Where FS = Field Strength	CL = Cable Attenuation Factor (Cable Loss)
RA = Reading Amplitude	AG = Amplifier Gain
AF = Antenna Factor	

Transd=AF +CL-AG

**RADIATION LIMIT**

According 15.249, the field strength of emissions from intentional radiators operated within 2400MHz-2483.5 MHz shall not exceed 94dBµV/m (50mV/m):

FCC PART 15.249(d) Emissions radiated outside of the specified frequency bands, except for harmonics, shall be attenuated by at least 50 dB below the level of the fundamental or to the general radiated emission limits in §15.209, whichever is the lesser attenuation.

In addition, radiated emissions which fall in the restricted bands, as defined in §15.205(a), must also comply with the radiated emission limits specified in §15.209(a)

Radiated emission limits

Frequency (MHz)	Distance (Meters)	Radiated (dBµV/m)	Radiated (µV/m)
0.009-0.49	3	20log(2400/F(KHz))+40log(300/3)	2400/F(KHz)
0.49-1.705	3	20log(24000/F(KHz))+ 40log(30/3)	24000/F(KHz)
1.705-30	3	20log(30)+ 40log(30/3)	30
30-88	3	40.0	100
88-216	3	43.5	150
216-960	3	46.0	200
Above 960	3	54.0	500

**TEST RESULTS**

Remark:

1. This test was performed with EUT in X, Y, Z position and the worse case was found when EUT in X position.
2. Both modes of GFSK were tested at Low, Middle, and High channel and recorded worst mode at GFSK
3. Radiated emission test from 9 KHz to 10th harmonic of fundamental was verified, and no emission found except system noise floor in 9 KHz to 30MHz and not recorded in this report.

**For 30MHz-1GHz**

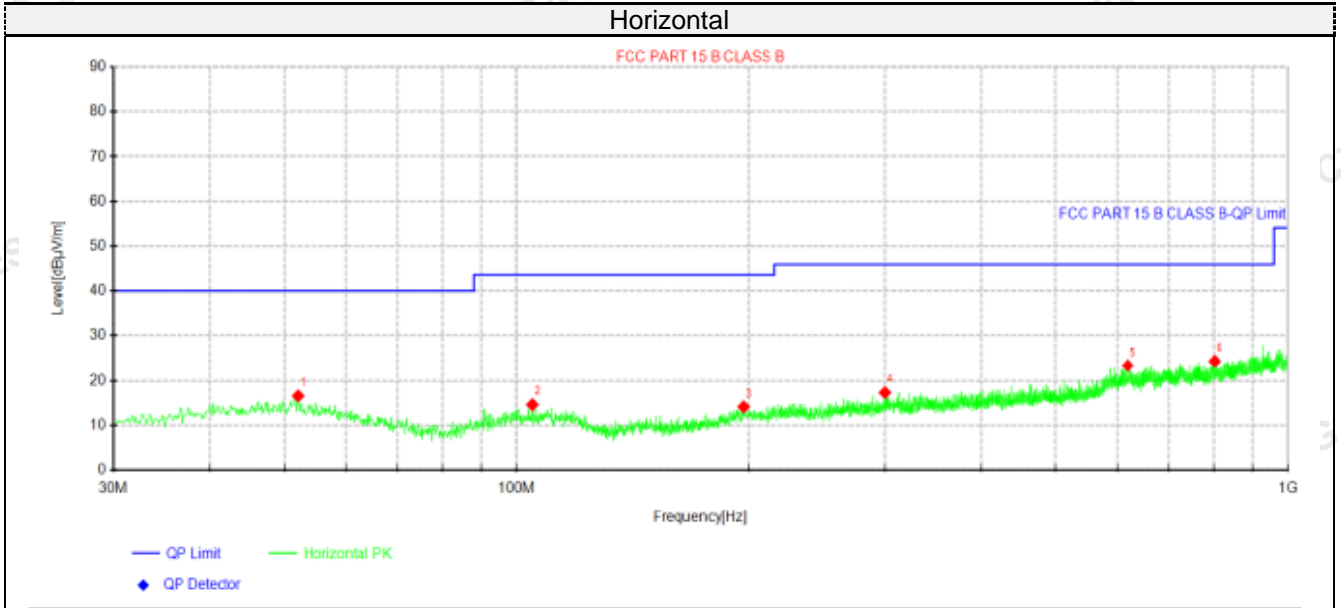

Suspected Data List									
NO.	Freq. [MHz]	Reading [dBµV]	Level [dBµV/m]	Factor [dB/m]	Limit [dBµV/m]	Margin [dB]	Height [cm]	Angle [°]	Polarity
1	52.0675	27.95	16.64	-11.31	40.00	23.36	100	230	Horizontal
2	104.69	27.74	14.71	-13.03	43.50	28.79	100	114	Horizontal
3	196.961	27.30	14.25	-13.05	43.50	29.25	100	91	Horizontal
4	300.145	28.24	17.36	-10.88	46.00	28.64	100	230	Horizontal
5	619.76	29.08	23.36	-5.72	46.00	22.64	100	323	Horizontal
6	803.09	28.91	24.36	-4.55	46.00	21.64	100	79	Horizontal

- Note: 1). Level (dBµV/m) = Reading (dBµV) + Factor (dB/m)  
 2). Factor (dB/m) = Antenna Factor (dB/m) + Cable loss (dB) - Pre Amplifier gain (dB)  
 3). Margin (dB) = Limit (dBµV/m) - Level (dBµV/m)

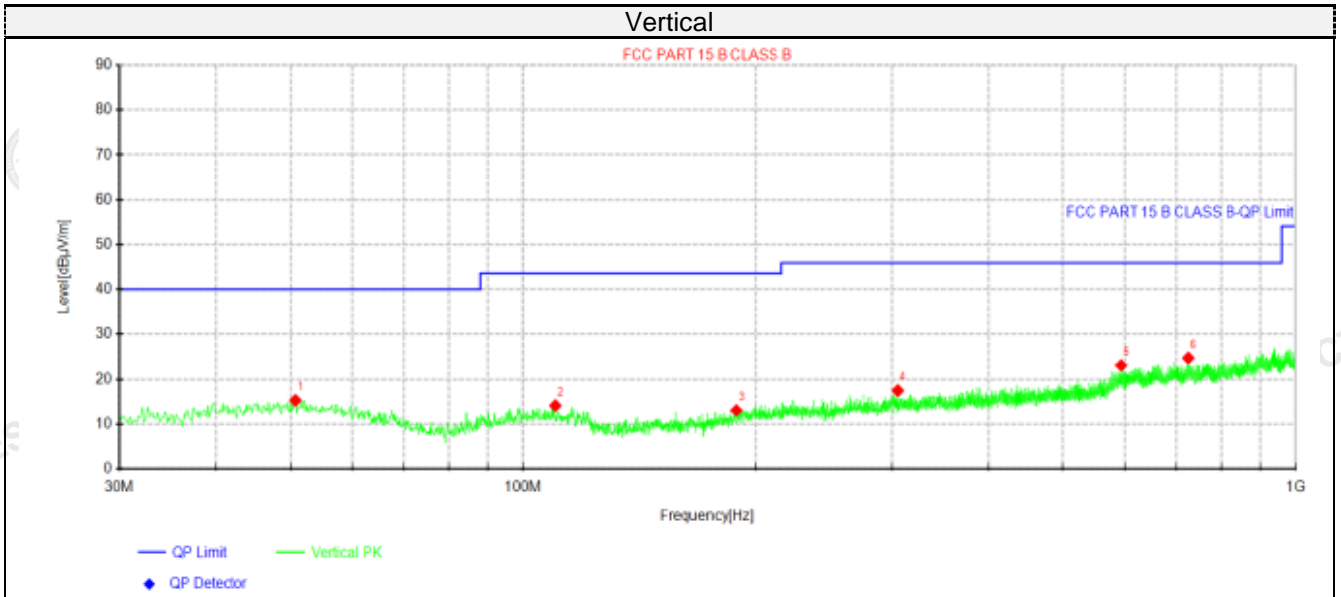

Suspected Data List									
NO.	Freq. [MHz]	Reading [dBµV]	Level [dBµV/m]	Factor [dB/m]	Limit [dBµV/m]	Margin [dB]	Height [cm]	Angle [°]	Polarity
1	50.7338	26.56	15.36	-11.20	40.00	24.64	100	15	Vertical
2	110.146	27.57	14.22	-13.35	43.50	29.28	100	338	Vertical
3	188.958	26.80	13.12	-13.68	43.50	30.38	100	293	Vertical
4	305.237	28.40	17.52	-10.88	46.00	28.48	100	0	Vertical
5	594.055	29.30	23.12	-6.18	46.00	22.88	100	0	Vertical
6	726.823	29.73	24.80	-4.93	46.00	21.20	100	0	Vertical

Note: 1). Level (dBµV/m) = Reading (dBµV) + Factor (dB/m)  
 2). Factor (dB/m) = Antenna Factor (dB/m) + Cable loss (dB) - Pre Amplifier gain (dB)  
 3). Margin (dB) = Limit (dBµV/m) - Level (dBµV/m)

For 1GHz to 25GHz

**GFSK (above 1GHz)**

Frequency(MHz):			2407		Polarity:		HORIZONTAL		
Frequency (MHz)	Emission Level (dBuV/m)		Limit (dBuV/m)	Margin (dB)	Raw Value (dBuV)	Antenna Factor (dB/m)	Cable Factor (dB)	Pre-amplifier (dB)	Correction Factor (dB/m)
2407.00	92.83	PK	114.00	21.17	104.11	27.47	3.43	42.18	-11.28
2407.00	81.22	AV	94.00	12.78	92.50	27.48	3.43	42.19	-11.28
4814.00	50.15	PK	74.00	23.85	54.40	32.34	5.16	41.75	-4.25
4814.00	39.97	AV	54.00	14.03	44.22	32.34	5.16	41.75	-4.25
7221.00	49.95	PK	74.00	24.05	50.48	36.61	6.52	43.66	-0.53
7221.00	36.89	AV	54.00	17.11	37.42	36.61	6.52	43.66	-0.53

Frequency(MHz):			2407		Polarity:		VERTICAL		
Frequency (MHz)	Emission Level (dBuV/m)		Limit (dBuV/m)	Margin (dB)	Raw Value (dBuV)	Antenna Factor (dB/m)	Cable Factor (dB)	Pre-amplifier (dB)	Correction Factor (dB/m)
2407.00	90.46	PK	114.00	23.54	101.74	27.48	3.43	42.19	-11.28
2407.00	78.04	AV	94.00	15.96	89.32	27.48	3.43	42.19	-11.28
4814.00	46.53	PK	74.00	27.47	50.78	32.34	5.16	41.75	-4.25
4814.00	37.46	AV	54.00	16.54	41.71	32.34	5.16	41.75	-4.25
7221.00	48.64	PK	74.00	25.36	49.17	36.61	6.52	43.66	-0.53
7221.00	34.52	AV	54.00	19.48	35.05	36.61	6.52	43.66	-0.53

REMARKS:

1. Emission level (dBuV/m) = Raw Value (dBuV) + Correction Factor (dB/m)
2. Correction Factor (dB/m) = Antenna Factor (dB/m) + Cable Factor (dB) - Pre-amplifier
3. Margin value = Limit value - Emission level.
4. -- Mean the PK detector measured value is below average limit.
5. The other emission levels were very low against the limit.

**Results of Band Edges Test (Radiated)**

Frequency(MHz):			2407		Polarity:		HORIZONTAL		
Frequency (MHz)	Emission Level (dBuV/m)		Limit (dBuV/m)	Margin (dB)	Raw Value (dBuV)	Antenna Factor (dB/m)	Cable Factor (dB)	Pre-amplifier (dB)	Correction Factor (dB/m)
2390.00	61.73	PK	74	12.27	72.15	27.42	4.31	42.15	-10.42
2390.00	42.61	AV	54	11.39	53.03	27.42	4.31	42.15	-10.42
Frequency(MHz):			2407		Polarity:		VERTICAL		
Frequency (MHz)	Emission Level (dBuV/m)		Limit (dBuV/m)	Margin (dB)	Raw Value (dBuV)	Antenna Factor (dB/m)	Cable Factor (dB)	Pre-amplifier (dB)	Correction Factor (dB/m)
2390.00	60.02	PK	74	13.98	70.44	27.42	4.31	42.15	-10.42
2390.00	40.61	AV	54	13.39	51.03	27.42	4.31	42.15	-10.42

Note:

- 1) Emission level (dBuV/m) = Meter Reading + antenna Factor + cable loss - preamp factor.
- 2) Margin value = Limits - Emission level.
- 3) -- Mean the PK detector measured value is below average limit.
- 4) The other emission levels were very low against the limit.
- 5) RBW1MHz VBW3MHz Peak detector is for PK value; RBW 1MHz VBW10Hz Peak detector is for AV value.

### 4.3. 20dB Bandwidth Measurement

#### TEST CONFIGURATION



#### TEST PROCEDURE

The transmitter output was connected to the spectrum analyzer through an attenuator. The bandwidth of the fundamental frequency was measured by spectrum analyzer with 30KHz RBW and 300KHz VBW.

The 20dB bandwidth is defined as the total spectrum the power of which is higher than peak power minus 20dB.

#### LIMIT

N/A

#### TEST RESULTS

Modulation	Channel	20dB bandwidth (MHz)	Result
GFSK	Low	1.194	PASS

Note: 1.The test results including the cable lose.



GFSK

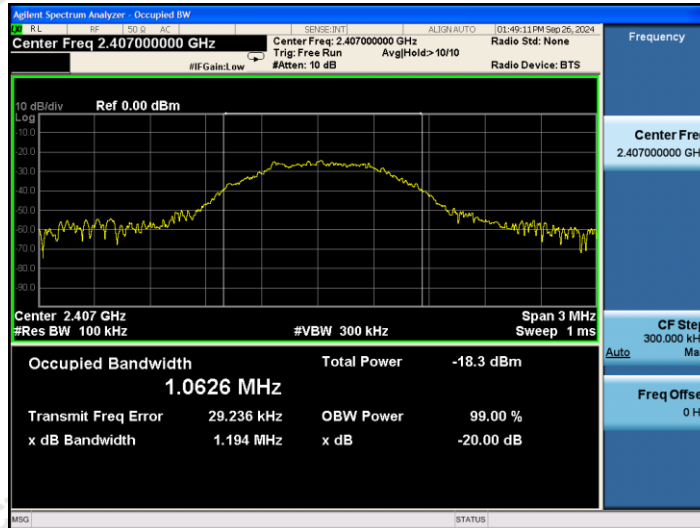

Low

#### 4.4. Antenna Requirement

##### Standard Applicable

For intentional device, according to FCC 47 CFR Section 15.203, an intentional radiator shall be designed to ensure that no antenna other than that furnished by the responsible party shall be used with the device.

And according to FCC 47 CFR Section 15.247 (c), if transmitting antennas of directional gain greater than 6dBi are used, the power shall be reduced by the amount in dB that the directional gain of the antenna exceeds 6dBi.

##### **Antenna Information**

The maximum gain of antenna was 0.55 dBi.

Remark: The antenna gain is provided by the customer, if the data provided by the customer is not accurate, Shenzhen CTA Testing Technology Co., Ltd does not assume any responsibility.

### 5. Test Setup Photos of the EUT

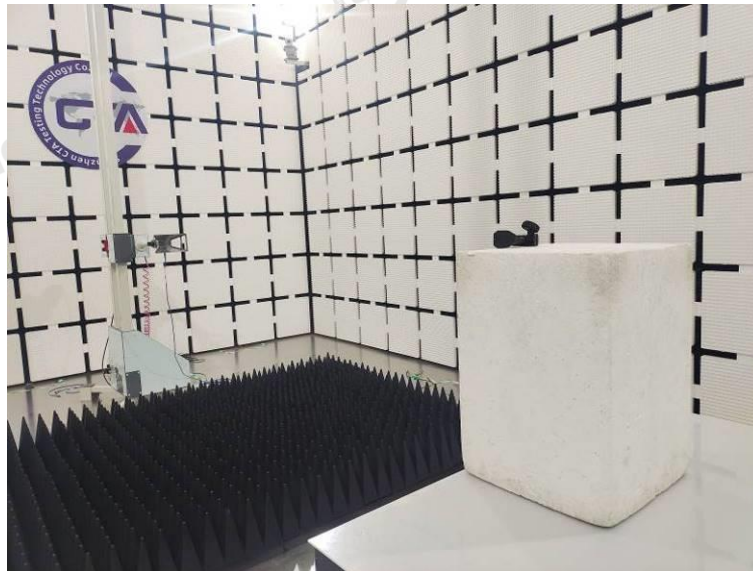

### 6. Test Photos of the EUT









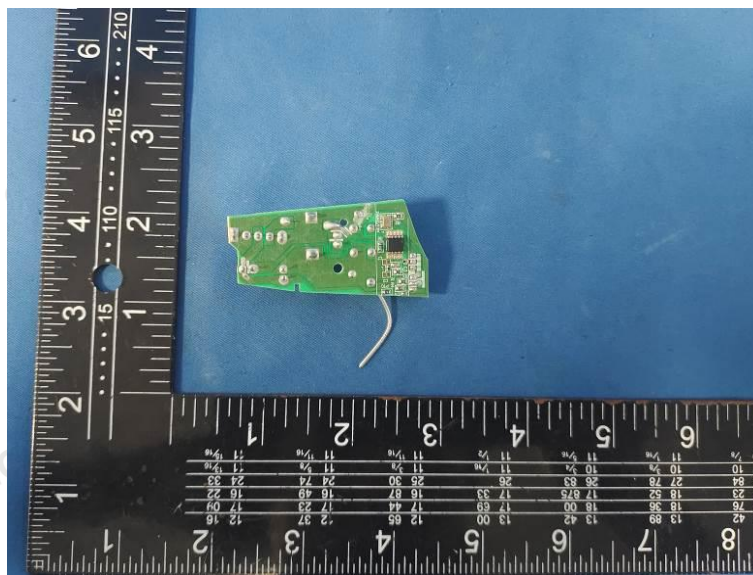
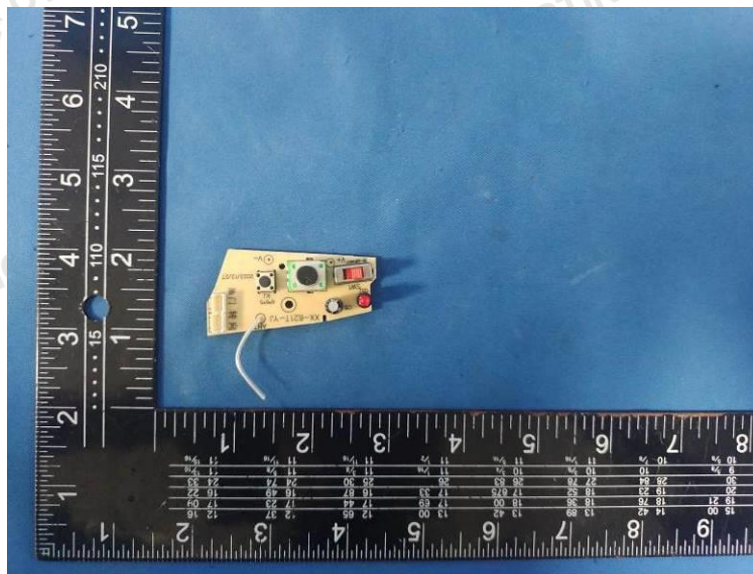



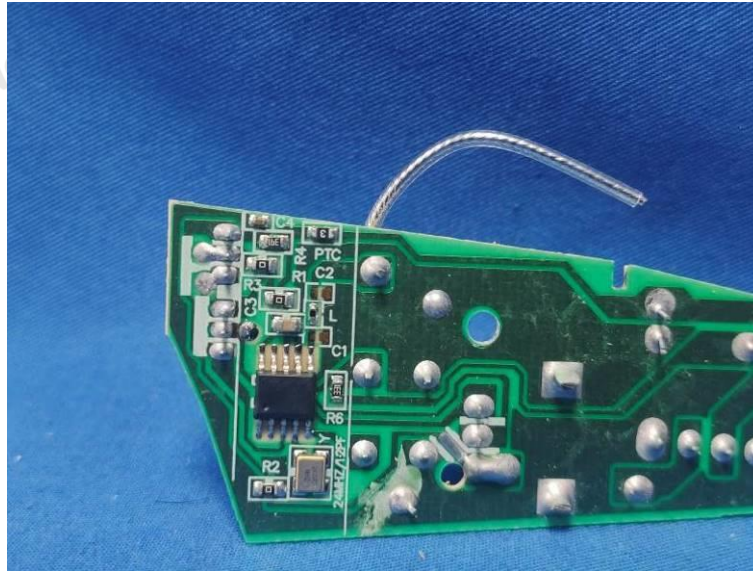

.....End of Report.....