

2.4G-2.48G frequency band On the pcb board PIFA Antenna test report

SPECIFICATIONS	
Frequency (MHz)	2400-2480
Peak Gain (dBi)	2.499
Average Gain (dBi)	>-4
VSWR	<3.2
Impedance (Ω)	50 Ω
Antenna Type	Plannar Inverted F Antenna on board
Polarization	Linear

testing environment: China Science and Technology Dark Room Test System

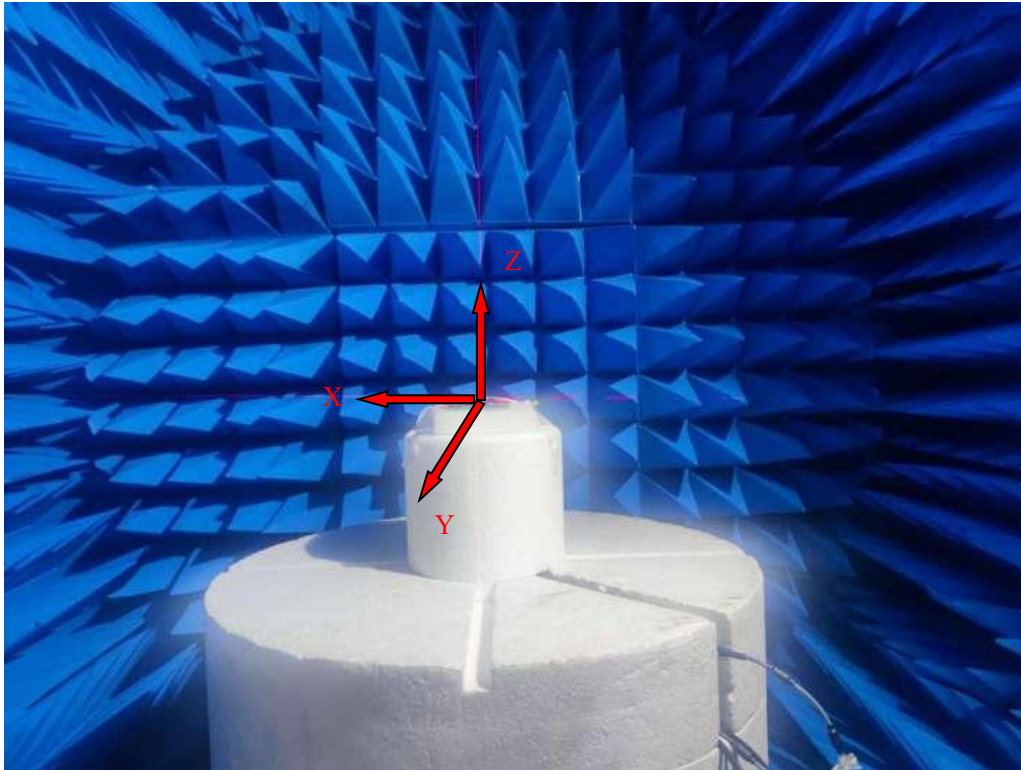

Antenna physical and physical dimensions

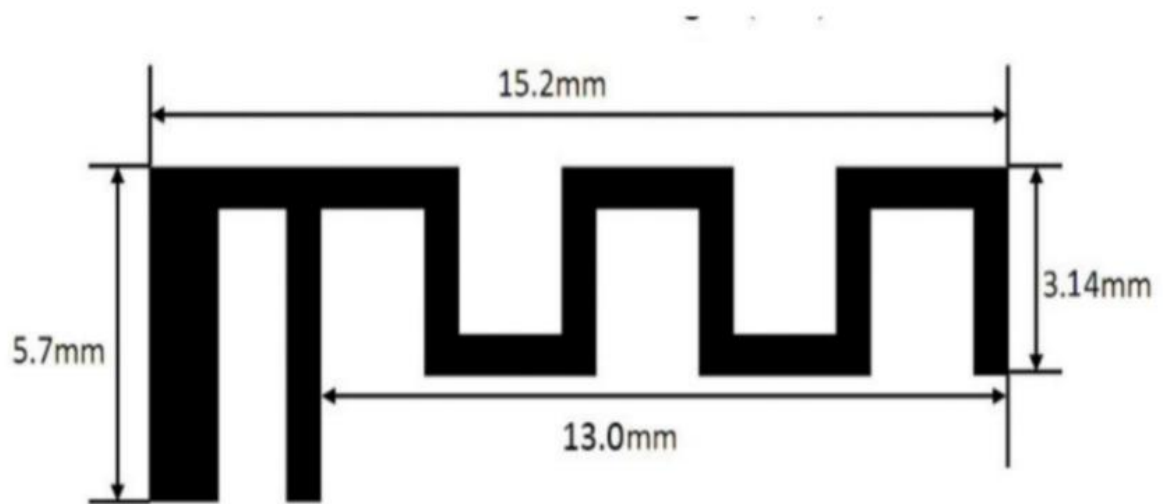
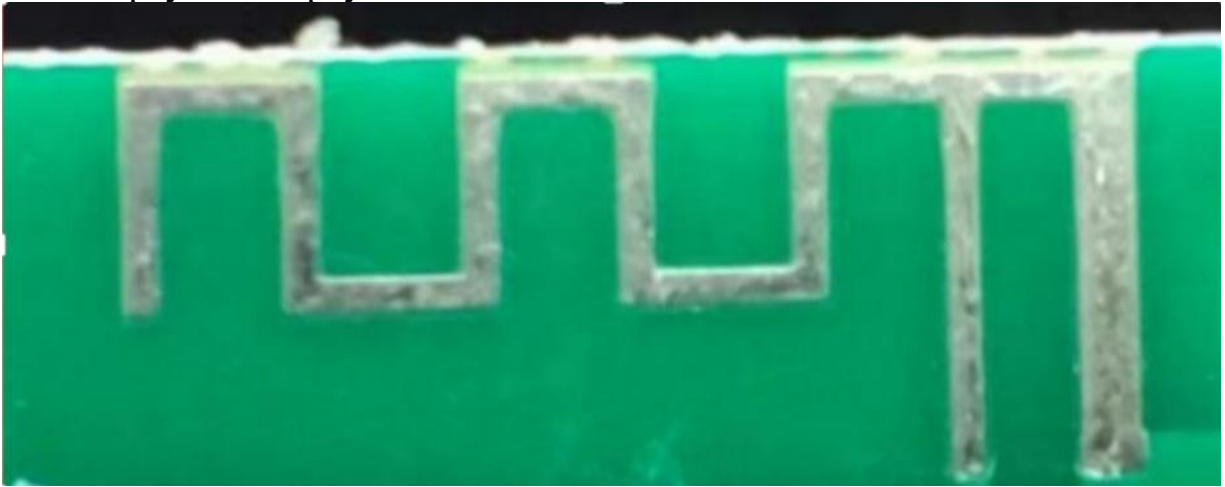

AntennapassivitySparameter: VSWR, ReturnLossandsmithchart

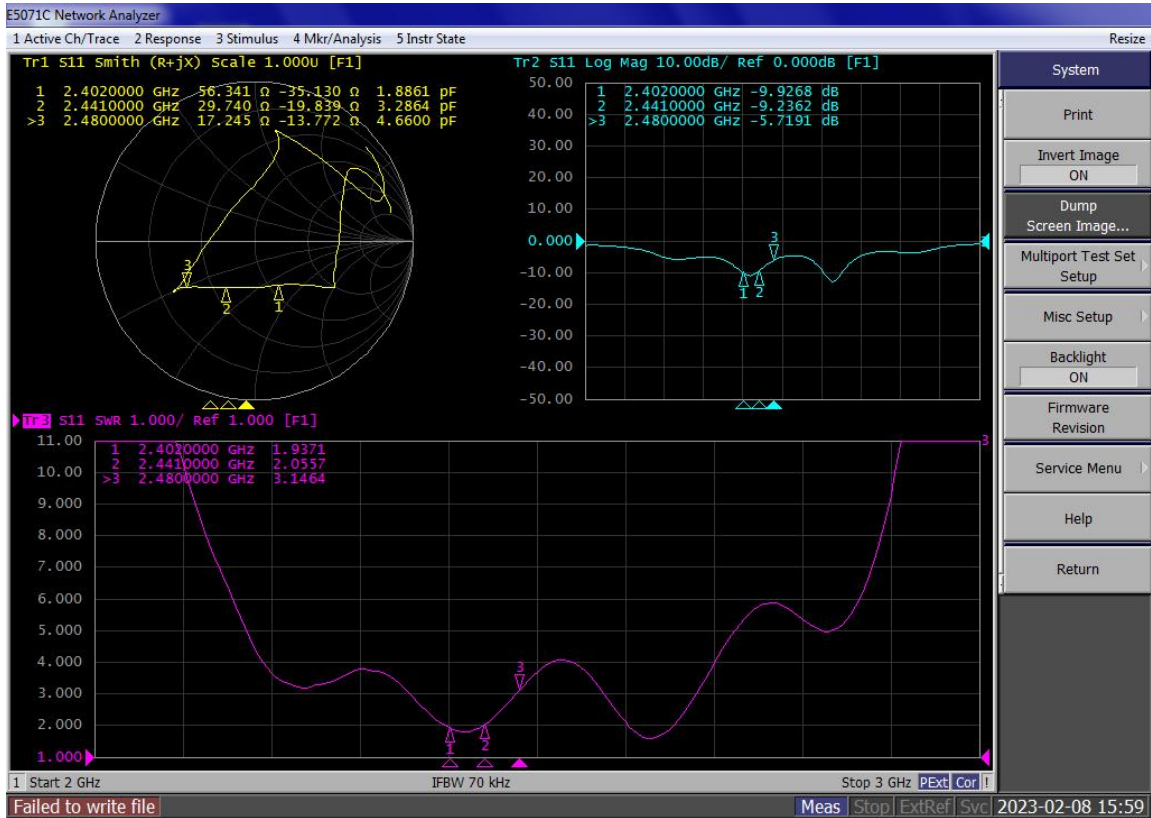

Antenna efficiency and gain

Frequency (MHz)	Gain (dBi)	Efficiency (%)	Average Gain (dBi)	Efficiency (dB)
2400	1.433	59.329%	-2.717	-2.267
2410	0.927	51.861%	-3.416	-2.852
2420	0.829	52.112%	-3.166	-2.831
2430	0.881	49.299%	-3.258	-3.072
2440	1.192	50.672%	-3.144	-2.952
2450	1.688	53.067%	-2.735	-2.752
2460	2.194	59.423%	-2.276	-2.260
2470	2.118	56.680%	-2.438	-2.466
2480	2.499	61.727%	-2.112	-2.095
Average	1.529	54.908%	-2.806	-2.616
Peak	2.499	61.727%	-2.112	-2.095

RF 2440MHz 2D-Theta Pattern

2D-Theta 2D-Line-Theta 2D-Phi 2D-Line-Phi DataLine HeatMap 3D

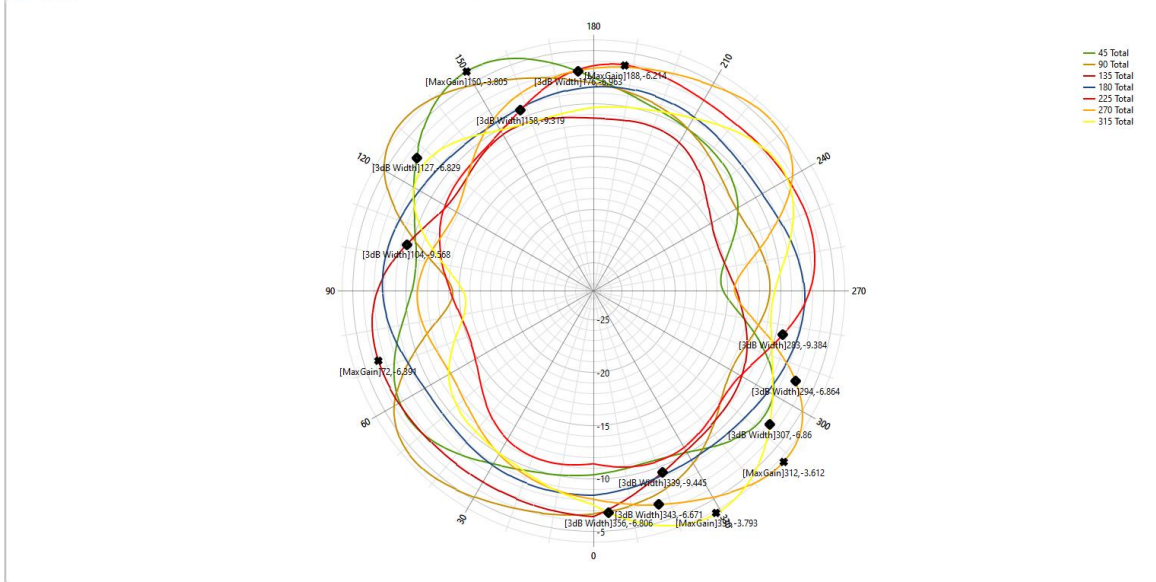

RF 2440MHz 2D-Phi Pattern

2D-Theta 2D-Line-Theta 2D-Phi 2D-Line-Phi DataLine HeatMap 3D

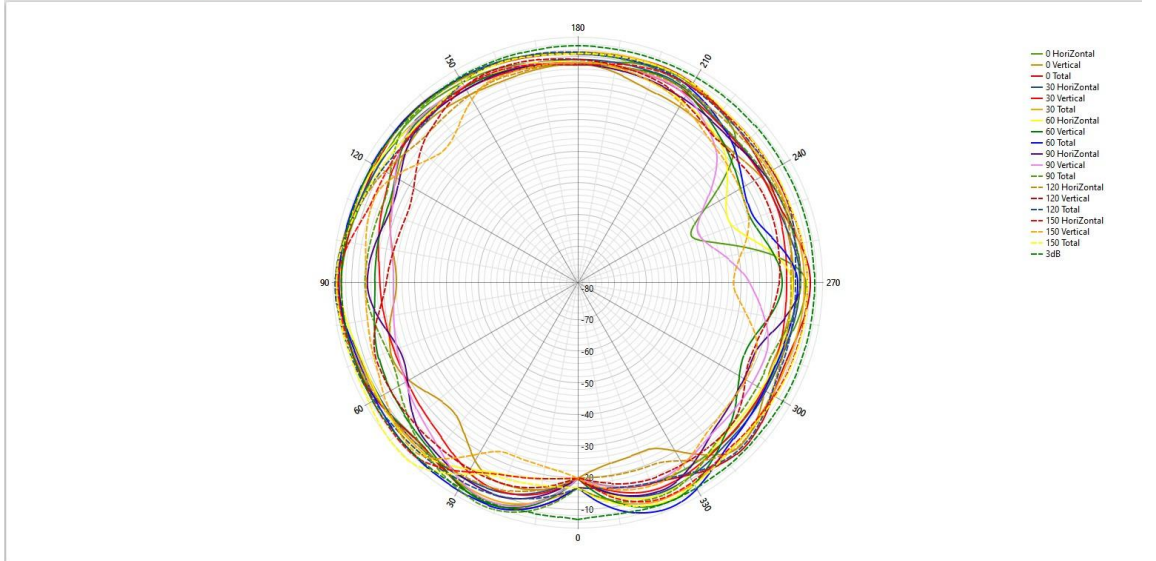

RF 2440MHz 3D-Horizontal Pattern

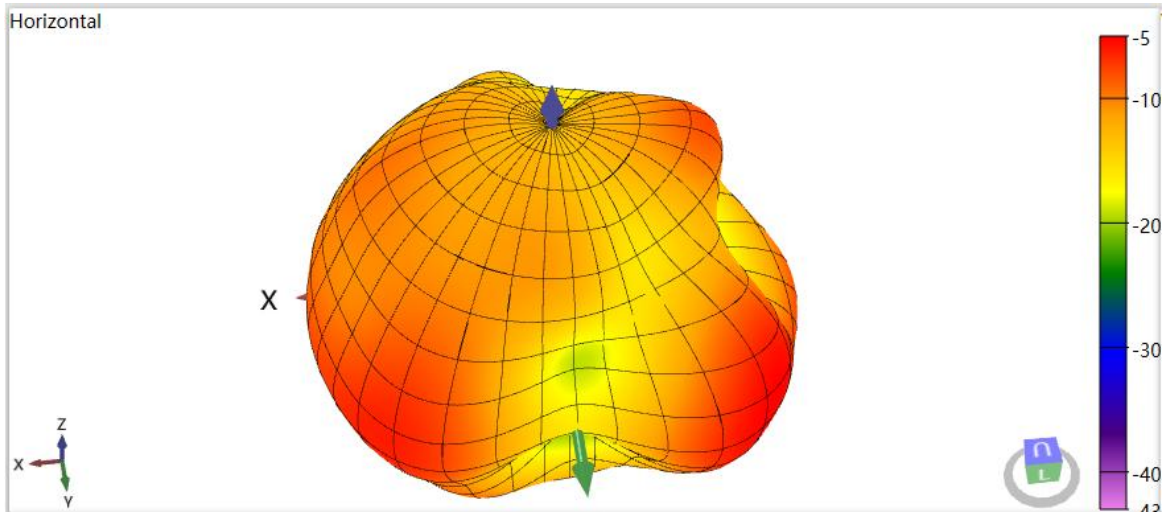

RF 2440MHz 3D-Vertical Pattern

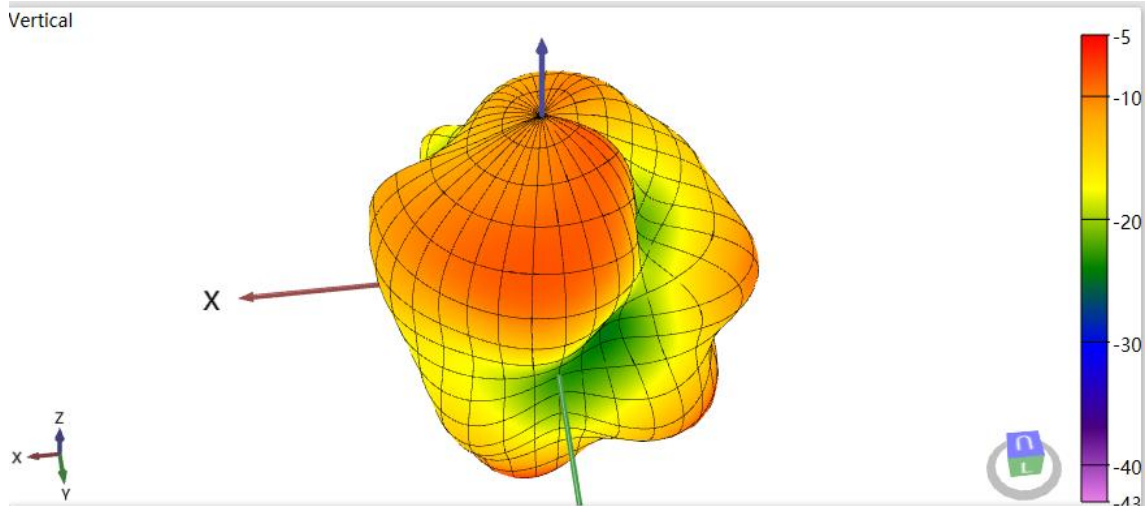

2440MHz 3D-Total Pattern

