

# Energizer Solar Peak 600 Portable Power Station

User Manual

# Contents

<b>Parameters</b>	<b>1</b>
<hr/>	
<b>Safety Guidelines</b>	
<hr/>	
Warning	2
Discard	3
<b>User Guidelines</b>	
<hr/>	
Product Overview	4
LCD Screen	6
How to Use	6
AC Charging	9
PV Charging	10
Car Charging	10
Constant Power	11
Energizer Solar Portable Power App	11
EPS Function	12
<b>FAQ's</b>	<b>12</b>
<hr/>	
<b>Error Messages &amp; Solutions</b>	<b>13</b>
<hr/>	
<b>What's in the box</b>	<b>15</b>
<hr/>	
<b>Maintenance</b>	<b>15</b>
<hr/>	
<b>Disclaimer</b>	<b>15</b>
<hr/>	

# Parameters

General	
Net Weight	7kg (15lbs)
Dimensions (W x H x D)	301 x 227 x 193mm (11.8" x 8.9" x 7.6")
Battery Capacity	512Wh 25.6V $\approx$ , 20Ah
WiFi	Supported
Output (EU/UK/FR/AU/ZA)	
AC Output x 2 (Inverter mode)	Pure sine-wave, total 600W (peak 1000W), 220-240V~(50/60Hz), 3A
AC Output (Bypass mode)	220-240V~(50/60Hz), 600W Max., 3A
Output (US)	
AC Output x 4 (Inverter mode)	Pure sine-wave, total 600W (peak 1000W), 120V~(60Hz), 6A
AC Output (Bypass mode)	100-120V~(60Hz), 600W Max., 6A
Other Outputs	
USB-A x 2	5V $\approx$ 2.4A, 12W Max.
USB-C x 2	5/9/12/15V $\approx$ 3A, 20V $\approx$ 5A, 100W Max.
Car Charger	12.6V $\approx$ 10A, 126W Max.
DC5521 Output x 2	12.6V $\approx$ 3A

\* Car charge and DC5521 share power, 126W Max.

\* Inverter mode: the output AC power comes from the battery, not the grid.

\* Bypass mode: the output AC power comes from the grid, not the battery.

Input (EU/UK/FR/AU/ZA)	
AC Input Power	1200W Max., 6A
AC Input Voltage	220-240V~(50/60Hz)
Input (US)	
AC Input Power	1200W Max., 10A
AC Input Voltage	100-120V~(60Hz)
Other Inputs	
PV Charge	12-20V $\approx$ 10A, 200W Max..
Car Charging Input	12V Battery Supported, 8A by default

# Parameters

Input Charging	
AC Charging Power	200W Max.
PV/Car Charging Power x 2	600W Max.
AC+PV Charging Power	600W Max.
Battery	
Cell Type	Lithium Iron Phosphate Battery (LiFePO <sub>4</sub> )
Life Cycle	3,000 cycles
Protection Type	Over temperature protection, low temperature protection, over discharge protection, over charge protection, over load protection, short circuit protection, over current protection
Operating Temperature	
Optimum Operating Temperature	20°C ~ 30°C (68°F ~ 86°F)
Discharge Ambient Temperature	-20°C ~ 45°C (-4°F ~ 113°F)
Charge Ambient Temperature	0°C ~ 45°C (32°F ~ 113°F)
Storage Ambient Temperature	-20°C ~ 45°C (-4°F ~ 113°F)

\*Whether the product can be charged or discharged is subject to the actual battery pack temperature.

# Safety Guidelines

## Warning

- Do not let a working power station be close to a heat source, such as a fire or a heater.
- Do not let the power station come into contact with any liquid.
- Do not use the power station in a strong electrostatic or strong magnetic field environment.
- Do not disassemble the power station in any way or pierce it with a sharp object.
- Do not use wires or other metal objects to short-circuit the product.
- Avoid stepping, sitting or climbing on the power station.
- Do not use parts or accessories that are not officially supplied. If a replacement is required, please contact Energizer Solar at [www.energizersolar.com](http://www.energizersolar.com).
- When using the power station, please follow the temperature guidelines outlined in this user manual. Excessively high temperatures can lead to a risk of battery ignition, while excessively low temperatures will significantly compromise the power station's performance and may affect its normal operation.
- Do not place heavy objects on top of the power station.
- Do not forcibly stop the fan or expose the power station to unventilated or dusty environments while it's operating.
- Please avoid dropping and violent vibration. If severe impact happens, shut down the power station immediately. Please secure the power station during transportation to avoid vibration and impact.
- If the power station accidentally falls into water, place it in a safe and spacious area, and maintain a safe distance until its completely dry. Even after the product has dried do not attempt to use the product again. Dispose of it properly according to the discard section in this user manual. If the power station is on fire, please use the recommended fire extinguishing methods in the following order: water or water mist, sand, fire blanket, dry powder, dioxide carbon fire extinguisher.

13. If the surface is dirty, clean it with a microfibre cloth.
14. Handle the power station with care to prevent damage. In the event of a severe impact causing the power station to tip over and sustain significant damage, turn it off immediately. Place the power station in a well-ventilated area, away from flammable materials and people. Dispose of it in accordance with local laws and regulations.
15. Keep the power station out of the reach of children and pets.
16. Keep the power station in a dry and ventilated place.
17. In humid environments, such as seaside locations or areas near water, it is advisable to use a moisture-proof bag with the power station. If you discover water inside the power station, refrain from using or starting it again. Take precautions to prevent electric shock before handling the power station. Place it in a safe, waterproof location and promptly contact customer service.
18. It is not recommended to use the power station to provide power for safety-critical emergency medical equipment, such as medical-grade breathing machines (hospital version CPAP: Continuous Positive Airway Pressure) and artificial lungs (ECMO: Extracorporeal Membrane Oxygenation). However, it is suitable for powering a home version CPAP at home, which does not require continuous professional monitoring. Always follow your doctor's recommendations and consult Energizer Solar for any device usage restrictions. For general medical equipment, please monitor the power levels to ensure power does not run out.
19. Power supplies generate electromagnetic fields that may interfere with implantable medical devices or the normal operation of personal medical devices, such as pacemakers, cochlear implants, hearing aids, and defibrillators.
20. When the power station is connected to a refrigerator, it may automatically shut down because of the power fluctuation property of the refrigerator. When connecting the power supply to a refrigerator that stores medicine, vaccines or other valuable items, it is recommended to set the AC output to "Never off" in the Energizer Solar Portable Power App, so as to ensure continuous power. Users should pay attention to power consumption.
21. During the push-pull movement of this product, it is strongly recommended to avoid placing other items on the power station.

## Discard

1. When conditions allow, ensure the battery is completely discharged before placing the power station in a designated battery recycling bin. The power station contains potentially hazardous batteries, so it is important not to dispose of them in regular waste bins. Refer to local laws and regulations for guidance on proper battery recycling and disposal procedures.
2. If the battery cannot be fully discharged due to product malfunction, avoid placing it directly in the battery recycling bin. Instead, contact a professional battery recycling company for appropriate disposal.
3. If the battery fails to restart after over-discharging, it should be safely disposed of as waste.

# User Guidelines

## Product Overview

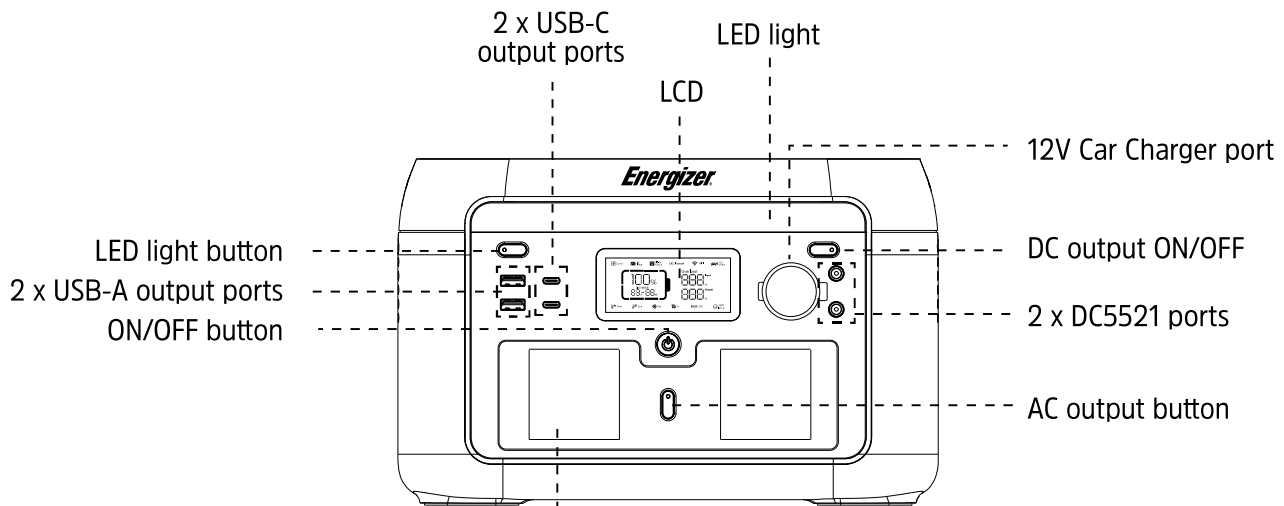

2 x AC outputs

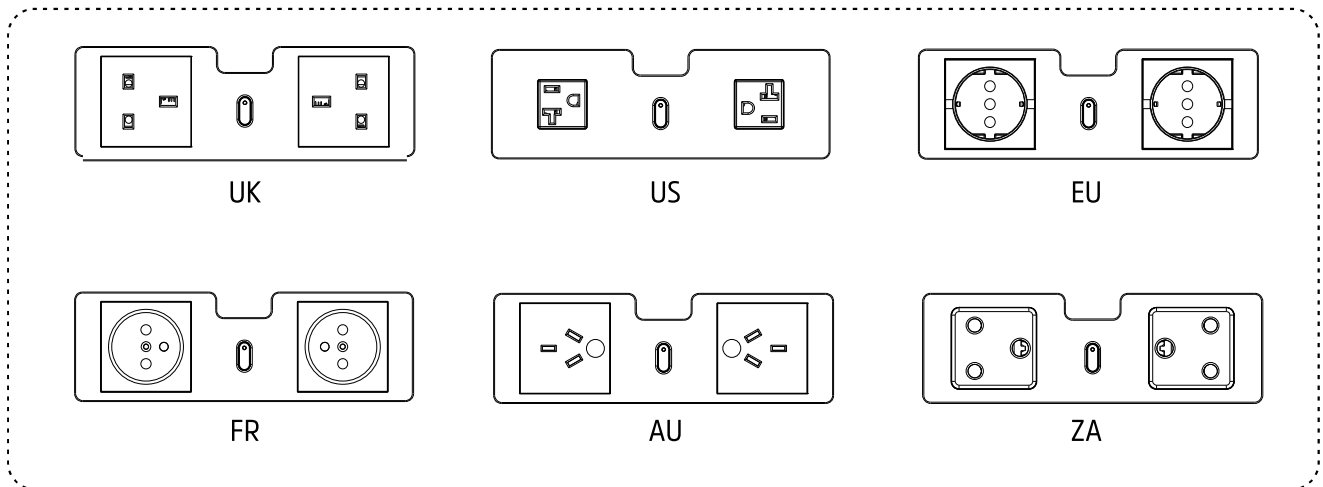

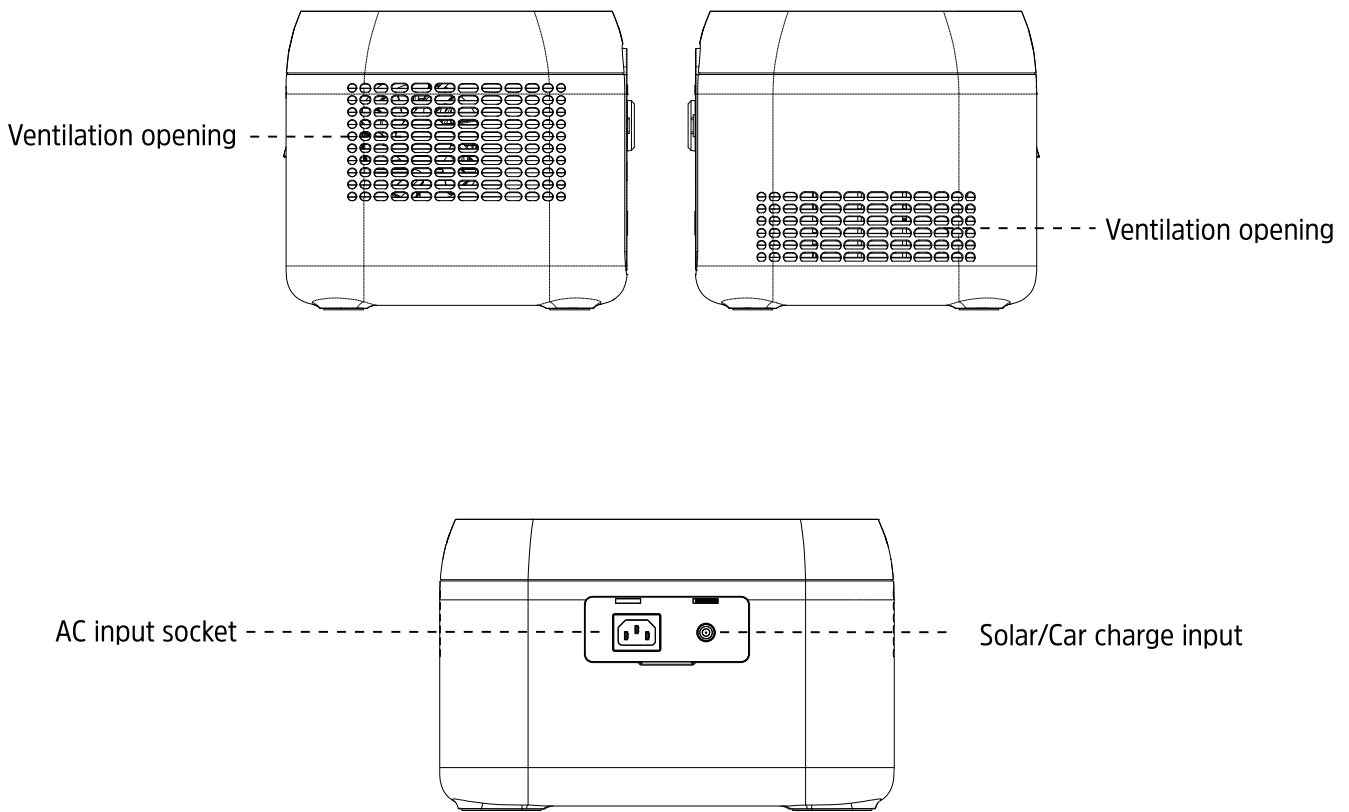

### LCD Screen

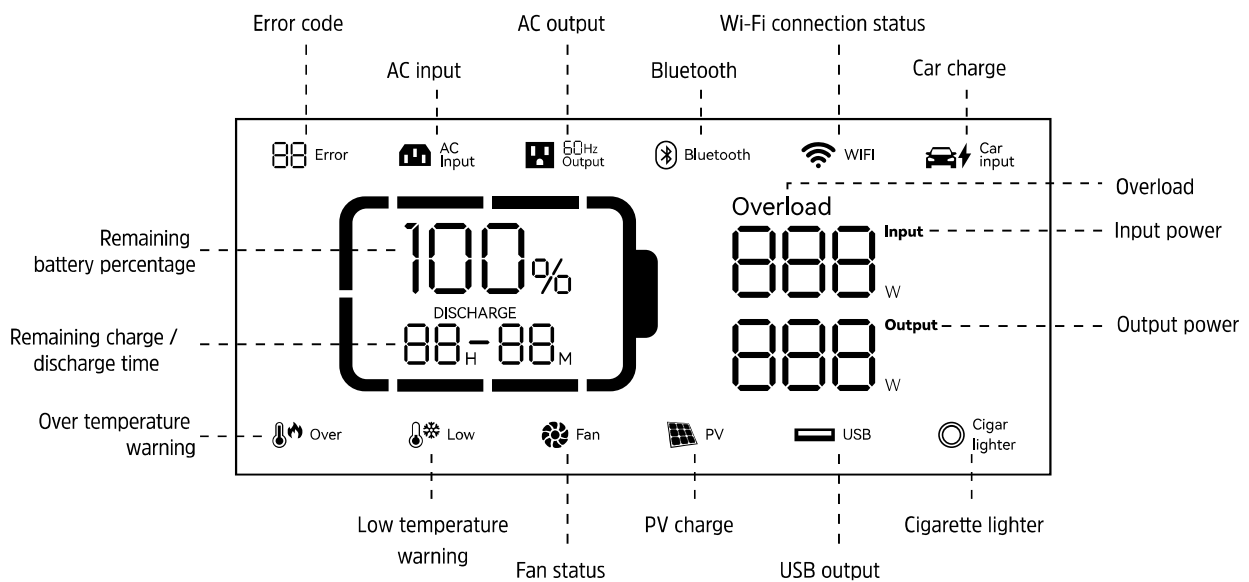

**Battery capacity:** When the power station is being charged, the SOC icon will flicker.



**Wi-Fi connection status:** The flickering icon indicates that power station is ready for pairing. The icon will keep flickering if a mobile phone and power station are connected by hotspot. After network connection succeeds, the icon will always be on. If connection fails, the icon will be off.

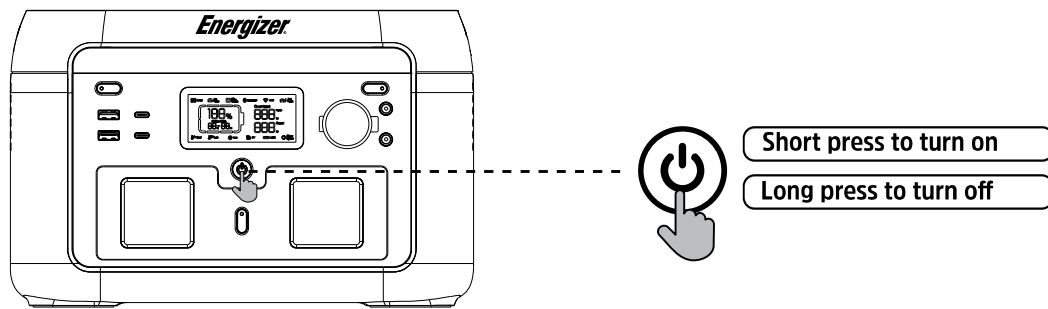

\* Please refer to Error Messages & Solutions for more details regarding error messages.

## Use



## On and off

- Press the main power switch to turn on the device, then the screen will be lit and the main power indicator will enter the slowly blinking light mode.
- If no operation is performed to the power station for 5 minutes, the power station will enter hibernation state and the LCD will automatically turn off. When there is load change or operation to the power station, the LCD screen will illuminate automatically. Press the main power switch to turn on or turn off the LCD.
- Press and hold the main power switch to toggle the LCD on or off.
- In the normal mode (the power is above 5%), the default standby time of this product is 2 hours; when the AC output switch is not turned on, and there is no charge or discharge for 2 hours, the product will automatically shut down, and the standby time can be set it on the Energizer Solar Portable Power App; when the power is 5% or below, the product will be forced to enter the low power mode. In the case of no charge or discharge, the product will adjust the standby time according to the power and automatically shut down.
- In normal mode, long press the LED light button to exit the automatic shutdown setting, and the battery icon  on the screen will flash. Long press again to enter the automatic shutdown setting, and the battery icon  will not flash. The automatic shutdown setting is to protect the battery from low power, exiting this setting may damage the battery life, please use it with caution.

**Note:** With no AC input active, long press the above AC output button, you can switch the AC off-grid output frequency ( 50Hz Output /  60Hz Output), long press 2s to switch, the AC output icon will flash 3 times after successful switching.

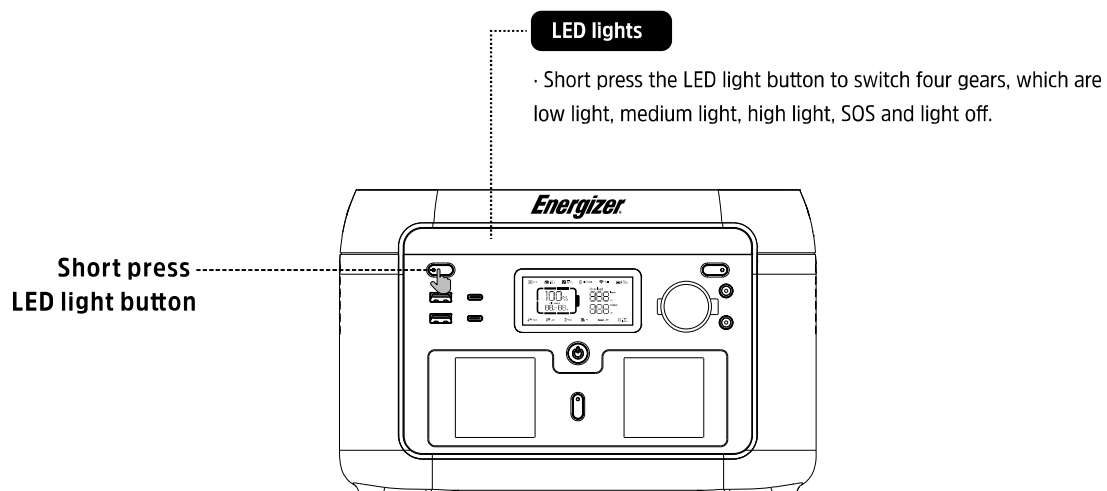



- After the main power switch is turned on, press the 12V DC output power switch to enable the DC output port.
- Press the 12V DC output power switch again to turn it off.
- When the 12V DC output power switch is turned on, power station does not shut down automatically.

### USB output

USB output is enabled by default after the main power switch is turned on.

### 12V DC output

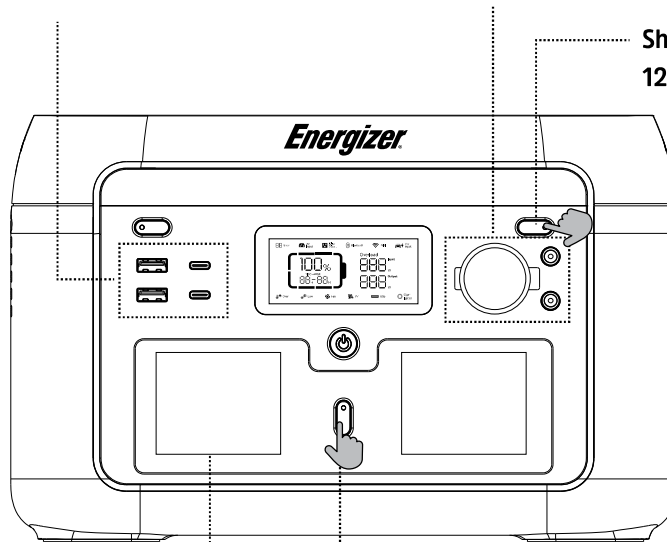

Short press  
12V DC output power switch

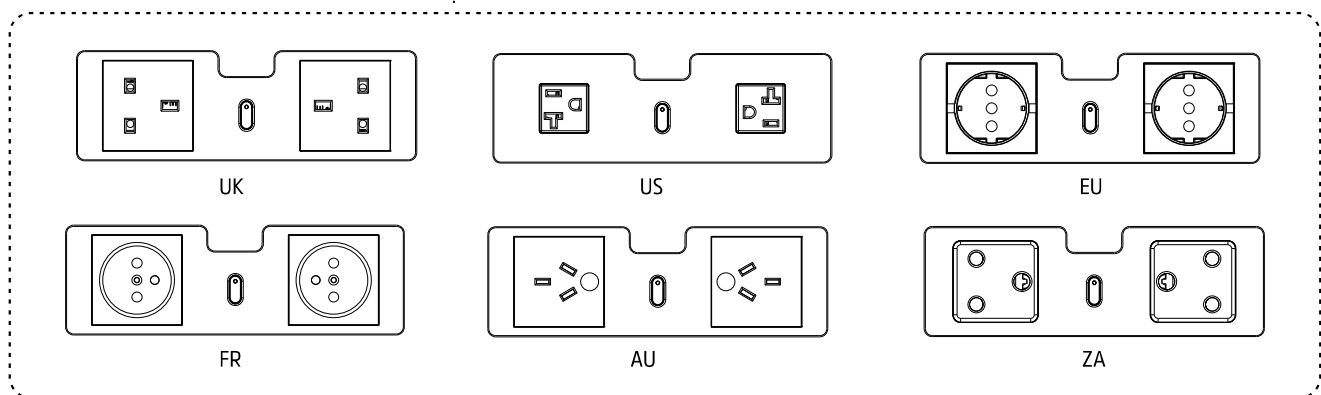

Short press AC output power switch



### AC output

- After ensuring that the main power is turned on, short press the AC output power switch to turn on the AC output. Short press the AC output power switch again to turn it off.
- The default standby time of the AC output port is 1 hour. After 1 hour without any load on the AC output port of this product, the AC output power will be automatically turned off. In normal mode, long press the LED light button, the AC output power switch can exit the automatic shutdown setting, and the battery icon  on the screen will flash. Long press again, the AC output power switch enters the automatic shutdown setting, and the battery icon  does not flash.
- Long press the LED light button to exit the AC automatic shutdown setting: it is applicable to AC equipment below 10W and pulse working equipment.
- When the AC output is not in use, turn it off to save power consumption.

## AC Charging

When the product is turned on, the default fast charging mode is working. If your product has a WiFi function, you can control the recharge rate through the Energizer Solar Portable Power App.

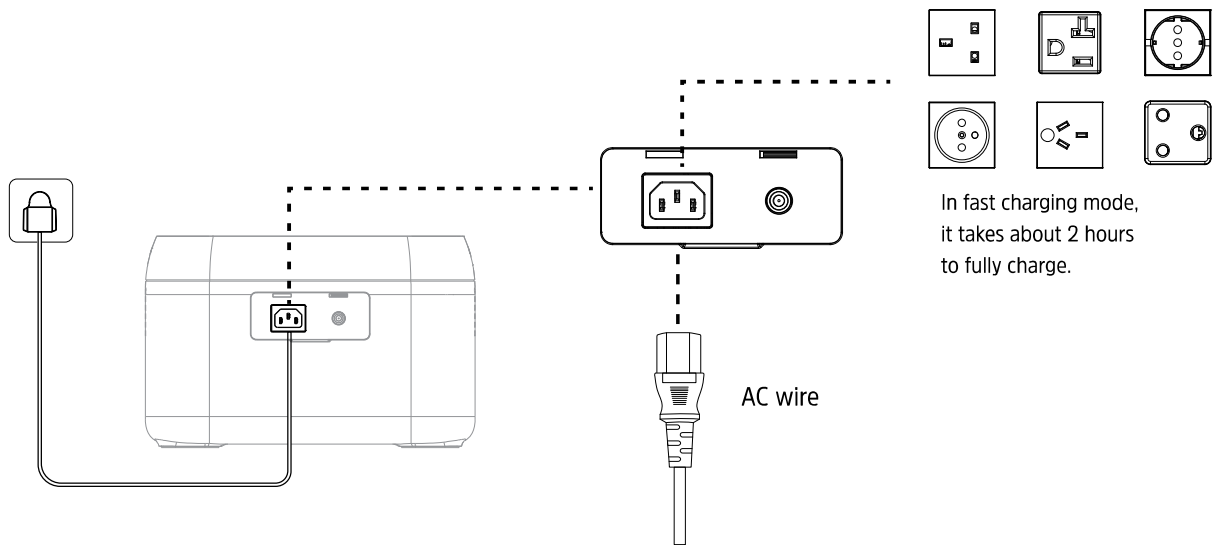

Please use the standard AC charging Cable for fast charging. AC Charging Cable should directly plug into 10A (or above) wall-mounted socket. We take no responsibilities for any damage caused by using unofficial AC charging cable, and other failures to follow instructions.

## PV Charging

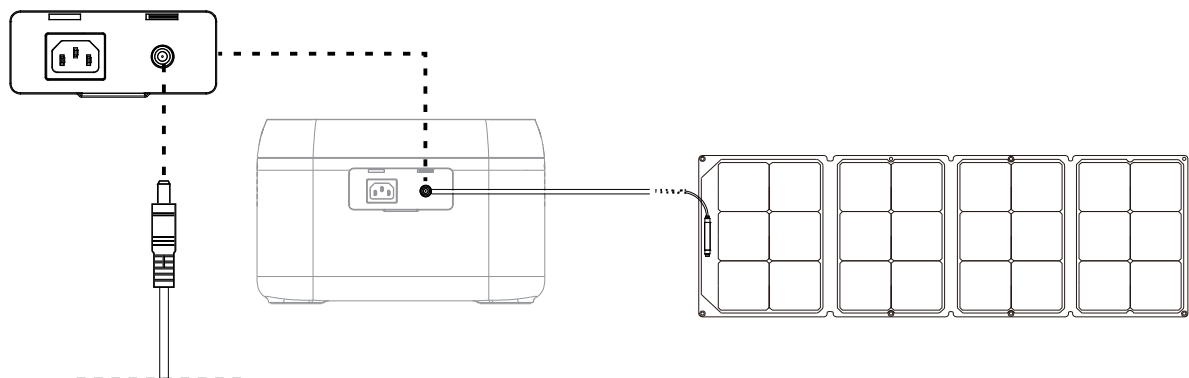

A Solar panel can be used to charge the power station as shown in the above diagram

**Charge the power station by solar panel.**

### \*Solar charging cable (DC7909)

- Please follow the Energizer Solar Sunpack user manual to connect the solar panels.
- Before connecting the solar panel, check whether its output voltage is within the power station specifications to avoid damage to power station.

\*The interface of this product is DC7909. If you need an adapter cable from MC4 to DC7909, please contact Energizer Solar at [www.energizersolar.com](http://www.energizersolar.com) on how to purchase.

## Car Charging

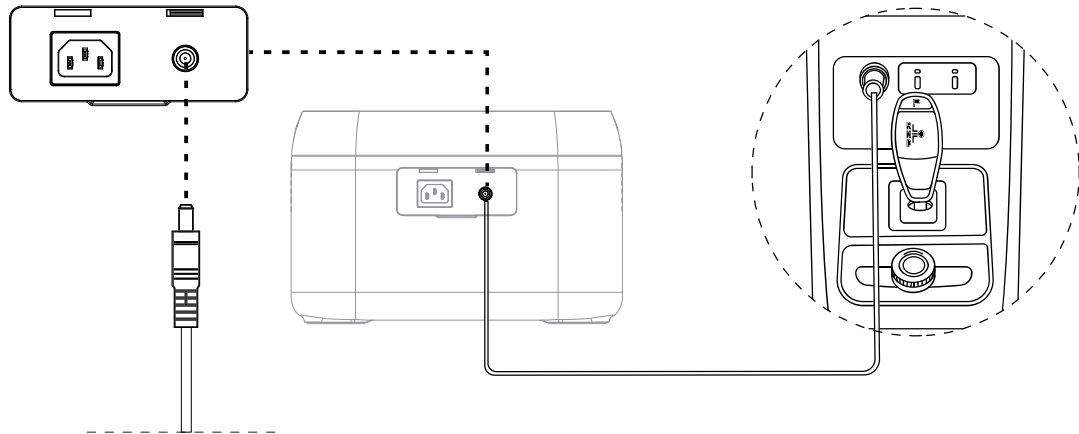

\*Car charger cable (DC7909)

Power station can be charged by a car charging port. It should be charged after the car starts, so as to avoid the car battery loss and failure to start. At the same time, ensure good connection between the car charging port and cigarette lighter. We take no responsibilities for any loss caused by improper operation.

## Constant power

1. The constant power output function is not enabled by default, which can be turned on or off by Energizer Solar Portable Power App.
2. In the following cases, constant power output function is not enabled:
  - (1) AC output turned on in charging status (bypass mode).
  - (2) Constant power output turned off.
3. Constant power output function is more suitable for heater and motor instead of all electrical equipment. It is not suitable for some electrical appliances with voltage protection (such as precision instruments). Constant power output function application is subject to actual testing.

## Energizer Solar Portable Power App

You are able to view information and data and control this product via the Energizer Solar Portable Power App. To download the app, search for [**Energizer Solar Portable Power**] in the Google App Store or Apple App Store. Once downloaded, create an account and register your product to manage and control how you use your Energizer Solar Portable Power Station. For WiFi connection instructions, visit [www.energizersolar.com](http://www.energizersolar.com) and go to the resources page.

## EPS Function



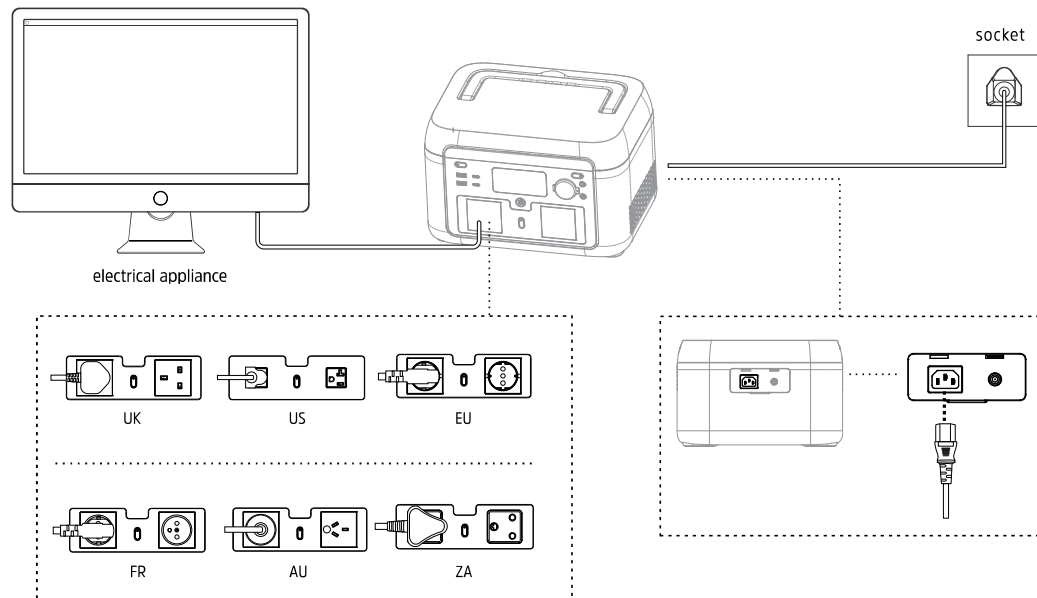



This product supports the EPS (emergency backup power) function. You connect the power grid and the AC input port of this product through the AC charging cable; Bypass mode (AC power comes from the grid, not the battery); when the grid suddenly loses power, the product can automatically switch to battery power supply mode within 10ms, at this time it is an inverter mode (AC power comes from the battery, not the grid). This function does not support 0ms switching. Please do not connect it to devices that require high uninterrupted power supply, such as data servers and workstations, or use it after multiple tests to confirm whether it is compatible, and It is recommended to use only one device during use, and do not use multiple devices at the same time to avoid overload protection of the product. If the device does not operate normally or data is lost due to failure to follow the instructions, our company will not bear the corresponding responsibility.





## FAQ's

- 1. What kind of battery is used?**  
 Lithium iron phosphate battery (LiFePO<sub>4</sub>).
- 2. What equipment can be connected to the AC output ports?**  
 The AC output has high rating power and maximum power, which enables it to supply power to most household appliances. Suggest check the equipment power prior to connecting and make sure power of all equipment lower than rated power.
- 3. How to know the supply time?**  
 Time shows in the LCD, which can be referred to for estimation for equipment with stable power consumption.
- 4. How to know it is charging?**  
 When in charge, the LCD shows remaining charging time. The SOC flickers, and input power is shown.
- 5. How to clean the unit?**  
 Clean the unit with a microfibre cloth.
- 6. How to store the unit?**  
 Turn it off, and keep it in a dry and ventilated place. Do not expose it close to water. For long-term storage, suggest discharge to 0% and charge to 100% every 3 months to extend the service life.
- 7. Can it be taken on a plane?**  
 No, the Energizer Solar Peak 600 does not comply with aviation standards.

# Error Messages & Solutions

Icon	Icon Characteristics	Fault Description	Solution
 Error	Error code always on	Pressure difference is too large	Automatic recovery after fault clearing; 3 consecutive locks within a certain period of time, longer recovery time.
 Over  Error	High Temperature icon flashes / Error code always on	Battery OTP (over temperature protection) fault	Shut down, after temperature recovery, rechargeable activation.
 Low  Error	Low Temperature icon flashes / Error code always on	Battery UTP (under temperature protection) fault	Shut down, after temperature recovery, rechargeable activation.
 Error	Error code always on	OCP (over current protection) fault	Remove the over-power device, and it will automatically recover after the fault is cleared; if it is triggered continuously for 3 times within 1 minute, it will be locked, and the recovery time will be prolonged, and it can be recovered by powering on and off again.
 Error	Error code always on	Abnormal precharge	Power on and off again to clear the fault.
 Error	Error code always on	Battery under voltage fault	Repeated charging failures or failure to charge, please contact customer service.
 Error	Error code always on	Abnormal INV battery voltage	Automatic recovery after the fault is cleared; if it is triggered 3 times within 1 minute, it will be locked, and the recovery time will be extended, and it can be recovered by powering on and off again.
 Error	Error code always on	Grid voltage or frequency fault	The fault is cleared when the grid returns to normal.
 Error	Error code always on	Abnormal INV BUS voltage	Automatic recovery after the fault is cleared; if it is triggered 3 times within 1 minute, it will be locked, and the recovery time will be extended, and it can be recovered by powering on and off again.
 Error	Error code always on	Abnormal INV output	Automatic recovery after the fault is cleared; if it is triggered 3 times within 1 minute, it will be locked, and the recovery time will be extended, and it can be recovered by powering on and off again.
Overload  Error	Overload icon flashes / Error code always on	INV discharge overload	Remove the over-power device, and it will automatically recover after the fault is cleared; if it is triggered continuously for 3 times within 1 minute, it will be locked, and the recovery time will be prolonged, and it can be recovered by powering on and off again.
Overload  Error	Overload icon flashes / Error code always on	Charge overload	Automatic recovery after the fault is cleared; if it is triggered 3 times within 1 minute, it will be locked, and the recovery time will be extended, and it can be recovered by powering on and off again.
 Error	Error code always on	INV Tz	Auto recover after fault is cleared.
 Error	Error code always on	INV output short	Fault will be cleared after reboot.

Icon	Icon Characteristics	Fault Description	Solution
 Over 20 Error	High Temperature icon flashes / Error code always on	MOSFET OTP fault	After removing the device and restarting, the fault is cleared.
21 Error	Error code always on	Fan stop	Exclude the fan abnormality, turn on and off, contact after sales if still not fixed.
22 Error	Error code always on	Discharge soft start fault	Auto recover after fault is cleared.
23 Error	Error code always on	Charge soft start fault	Automatic recovery after the fault is cleared; if it is triggered 3 times within 1 minute, it will be locked, and the recovery time will be extended, and it can be recovered by powering on and off again.
24 Error	Error code always on	MOSFET UTP fault	Automatic recovery after the product heats up.
27 Error	Error code always on	PV hardware OCP fault	Remove PV charge, auto recover after connecting PV and turn on.
28 Error	Error code always on	PV1 software OCP fault	Stop PV1 charging, auto recover after connecting PV and turn on.
30 Error	Error code always on	Car charge output OCP fault	Turn off output, manual recover after fault is cleared.
31 Error	Error code always on	PV input OVP (over voltage protection) fault	PV charging does not work, return to normal working range, fault cleared.
 Over 35 Error	High Temperature icon flashes / Error code always on	PV1 OTP fault	Stop PV1. Auto recover after fault is cleared.
38 Error	Overload icon flashes / Error code always on	Abnormal communication	Turn on and off, or change operation environment. Contact after sales if still not fixed.

If there is a warning occurs during the use of this product, and the warning icon still does not disappear after restarting the device, please stop using it immediately (do not try to charge or discharge). If none of the above information can solve problem you encounter, please contact Energizer Solar at [www.energizersolar.com](http://www.energizersolar.com)

## What's in the Box

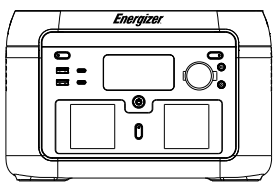

Power station

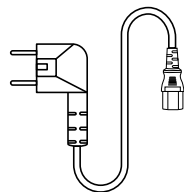

AC cable

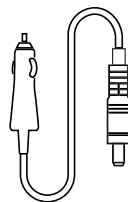

Car charge cable

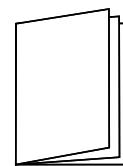

User manual

## Maintenance

- It is recommended to use or store the power station between the optimum operating temperature range. Ensure it is kept away from water, heaters, and metal surfaces.
- For long-term storage, charge and discharge every 3 months, i.e. discharge to 0% then charge to 100%.
- For safety reasons, avoid storing the power station at temperatures above 45°C (113°F) or below -20°C (4°F).
- If the capacity is lower than 1%, please charge to 60%. Long-term storage with serious power shortage will cause irreversible damage to the battery cells and shorten the service life of the product.
- If the battery capacity becomes critically low, and the device remains idle for an extended period, the product will enter deep sleep mode and can only be used again after being recharged.

## Disclaimer

- The product features a built-in battery management system, which has various protection measures, including overcharge, overdischarge, overcurrent, short circuit, high and low temperature, and abnormal communication. During the use of this product, these protection mechanisms may activate and temporarily cause output interruption. Any potential loss stemming from accidental power interruptions while supplying power to specific equipment, such as medical devices or servers, is not the responsibility of Energizer Solar.
- Before using the power station, please read this user manual to ensure understanding and proper use. After reading the user manual, please keep it safe for future reference. Improper operation may cause serious injury to yourself or others, or result in product damage and property loss. Once using the power station, you are deemed to have understood and accepted all terms and contents herein. Users are expected to take responsibility for their actions and any resulting consequences. Energizer Solar is not responsible for any losses that may occur if users do not adhere to the instructions in this user manual.
- In compliance with laws and regulations, the company reserves the right of final interpretation of this document and all related documents of this product. Subject to update, revision or termination without prior notice, please visit [www.energizersolar.com](http://www.energizersolar.com) for the latest product information.

### ISED Statement

This device contains licence-exempt transmitter(s)/receiver(s) that comply with Innovation, Science and Economic Development

Canada's licence-exempt RSS(s). Operation is subject to the following two conditions:

1. This device may not cause interference.
2. This device must accept any interference, including interference that may cause undesired operation of the device.

This equipment should be installed and operated with a minimum distance of 20 cm between the radiator and your body.

Le présent appareil est conforme aux CNR d'Industrie Canada applicables aux appareils radio exempts de licence. L'exploitation est autorisée aux deux conditions suivantes :

- (1) l'appareil ne doit pas produire de brouillage, et
- (2) l'utilisateur de l'appareil doit accepter tout brouillage radioélectrique subi, même si le brouillage est susceptible d'en compromettre le fonctionnement. Cet équipement doit être installé et utilisé avec une distance minimale de 20 cm entre le radiateur et votre corps.

### FCC Statement

This device complies with Part 15 of the FCC Rules. Operation is subject to the following two conditions:

- (1) This device may not cause harmful interference.
  - (2) This device must accept any interference received, including interference that may cause undesired operation.
2. Changes or modifications not expressly approved by the party responsible for compliance could void the user's authority to operate the equipment.

Note: This equipment has been tested and found to comply with the limits for a class B digital device, pursuant to Part 15 of the FCC Rules. These limits are designed to provide reasonable protection against harmful interference in a residential installation.

This equipment generates uses and can radiate radio frequency energy and, if not installed and used in accordance with the instructions, may cause harmful interference to radio communications. However, there is no guarantee that interference will not occur in a particular installation. If this equipment does cause harmful interference to radio or television reception, which can be determined by turning the equipment off and on, the user is encouraged to try to correct the interference by one or more of the following measures:

- Reorient or relocate the receiving antenna.
- Increase the separation between the equipment and receiver.
- Connect the equipment into an outlet on a circuit different from that to which the receiver is connected.
- Consult the dealer or an experienced radio/TV technician for help.

The device has been evaluated to meet general RF exposure requirement. The device can be used in portable exposure condition without restriction.

This equipment should be installed and operated with a minimum distance of 20 cm between the radiator and your body.



**North America**  
888 Prospect Street, Suite 200  
La Jolla California 92037  
+1 424 254 5344

**Europe**  
The Black Church, St Mary's Place  
Dublin D07 P4AX, Ireland  
+353 1 254 8222

**Australia**  
Level 35, 477 Collins St, Melbourne  
Victoria 3000, Australia  
+61 1300 757 827

 [energizersolar.com](https://energizersolar.com)