



FCC Test Report

**Test report
On Behalf of
RADIOSHACK WORLDWIDE CORP.
For
6 BUTTONS WIRELESS MOUSE
Model No.: 2604760
FCC ID: 2BDUR-2604760**

Prepared For : RADIOSHACK WORLDWIDE CORP.

**Building AFRA, Ave. Samuel Lewis and street 54, Panama City, Panama 5,
Republic of Panama**

Prepared By : Shenzhen HUAK Testing Technology Co., Ltd.

**1-2/F., Building B2, Junfeng Zhongcheng Zhizao Innovation Park, Heping,
Fuhai Street, Bao'an District, Shenzhen, Guangdong, China**

Date of Test: Nov. 24, 2023 ~Dec. 14, 2023

Date of Report: Dec. 14, 2023

Report Number: HK2311245687-E



Test Result Certification

Applicant's name : RADIOSHACK WORLDWIDE CORP.
Address : Building AFRA, Ave. Samuel Lewis and street 54, Panama City,
Panama 5, Republic of Panama
Manufacturer's Name : Shenzhen Carpo Technology Co., Ltd.
Address : Floor 5, No.4 Shuotai Street, Loucun Community, Xinhu Street,
Guangming District, Shenzhen, China

Product description

Trade Mark: N/A
Product name : 6 BUTTONS WIRELESS MOUSE
Model and/or type reference : 2604760
Standards : FCC Rules and Regulations Part 15 Subpart C Section 15.249
ANSI C63.10: 2013

This publication may be reproduced in whole or in part for non-commercial purposes as long as the Shenzhen HUAK Testing Technology Co., Ltd. is acknowledged as copyright owner and source of the material. Shenzhen HUAK Testing Technology Co., Ltd. takes no responsibility for and will not assume liability for damages resulting from the reader's interpretation of the reproduced material due to its placement and context.

Date of Test :
Date (s) of performance of tests : Nov. 24, 2023 ~Dec. 14, 2023
Date of Issue : Dec. 14, 2023
Test Result : **Pass**

Testing Engineer : Len Liao
(Len Liao)

Technical Manager : Sliver Wan
(Sliver Wan)

Authorized Signatory : Jason Zhou
(Jason Zhou)

The results shown in this test report refer only to the sample(s) tested unless otherwise stated and the sample(s) are retained for 30 days only. The document is issued by HUAK, this document cannot be reproduced except in full with our prior written permission. The more details and the authenticity of the report will be confirmed at <http://www.cer-mark.com>.

**Table of Contents****Page**

1 . Test Summary	5
1.1 . Test Procedures and Results	5
1.2 . Information of the Test Laboratory	5
1.3 . Measurement Uncertainty	5
2 . General Information	6
2.1 . General Description of EUT	6
2.2 . Operation of EUT During Testing	7
2.3 . Description of Test Setup	8
2.4. Description of Support Units	8
2.5. Measurement Instruments List	9
3 . Conducted Emissions Test	10
3.1. Conducted Power Line Emission Limit	10
3.2. Test Setup	10
3.3. Test Procedure	10
3.4. Test Result	11
4. Radiated Emission Test	12
4.1. Radiation Limit	12
4.2. Test Setup	12
4.3. Test Procedure	13
4.4. Test Result	13
5. Band Edge	19
5.1. Limits	19
5.2. Test Procedure	19
5.3. Test Result	20
6. Occupied Bandwidth Measurement	22
6.1. Test Setup	22
6.2. Test Procedure	22
6.3. Measurement Equipment Used	22
6.4. Test Result	22
7. Antenna Requirement	24
8. Photograph of Test	25
9. Photos of the EUT	26



**** Modified History ****

Revision	Description	Issued Data	Remark
Revision 1.0	Initial Test Report Release	Dec. 14, 2023	Jason Zhou

The results shown in this test report refer only to the sample(s) tested unless otherwise stated and the sample(s) are retained for 30 days only. The document is issued by HUAK, this document cannot be reproduced except in full with our prior written permission. The more details and the authenticity of the report will be confirmed at <http://www.cer-mark.com>.

TEL : +86-755 2302 9901 FAX : +86-755 2302 9901 E-mail : service@cer-mark.com

Address: 1-2F., Building B2, Junfeng Zhongcheng Zhizao Innovation Park, Heping Community, Fuhai Street, Bao'an District, Shenzhen, Guangdong, China



1. Test Summary

1.1. Test Procedures and Results

DESCRIPTION OF TEST	SECTION NUMBER	RESULT
CONDUCTED EMISSIONS TEST	15.207	N/A
RADIATED EMISSION TEST	15.249(a)/15.209	COMPLIANT
BAND EDGE	15.249(d)/15.205	COMPLIANT
OCCUPIED BANDWIDTH MEASUREMENT	15.215 (c)	COMPLIANT
ANTENNA REQUIREMENT	15.203	COMPLIANT

1.2. Information of the Test Laboratory

Shenzhen HUAK Testing Technology Co., Ltd.
 Add.: 1-2/F., Building B2, Junfeng Zhongcheng Zhizao Innovation Park, Heping, Fuhai Street,
 Bao'an District, Shenzhen, Guangdong, China

Testing Laboratory Authorization:

A2LA Accreditation Code is 4781.01.
 FCC Designation Number is CN1229.
 Canada IC CAB identifier is CN0045.
 CNAS Registration Number is L9589.

1.3. Measurement Uncertainty

Measurement Uncertainty

- Conducted Emission Expanded Uncertainty = 2.71dB, k=2
- Radiated emission expanded uncertainty(9kHz-30MHz) = 3.90dB, k=2
- Radiated emission expanded uncertainty(30MHz-1000MHz) = 3.90dB, k=2
- Radiated emission expanded uncertainty(Above 1GHz) = 4.28dB, k=2



2. General Information

2.1. General Description of EUT

Equipment:	6 BUTTONS WIRELESS MOUSE
Model Name:	2604760
Series Model:	N/A
Model Difference:	N/A
FCC ID:	2BDUR-2604760
Antenna Type:	PCB Antenna
Antenna Gain:	3.85dBi
Operation frequency:	2402.65-2480.65MHz
Number of Channels:	16CH
Modulation Type:	GFSK
Power Source:	DC 1.5V From Battery
Power Rating:	DC 1.5V From Battery



2.1.1. Carrier Frequency of Channels

Channel	Frequency (MHz)	Channel	Frequency (MHz)	Channel	Frequency (MHz)
1	2402.65	7	2436.65	13	2463.65
2	2407.65	8	2439.65	14	2466.65
3	2414.65	9	2441.65	15	2473.65
4	2419.65	10	2445.65	16	2480.65
5	2422.65	11	2453.65		
6	2426.65	12	2459.65		

2.2. Operation of EUT During Testing

Operating Mode

The mode is used: **Transmitting mode**

Low Channel: 2402.65MHz

Middle Channel: 2441.65MHz

High Channel: 2480.65MHz



2.3. Description of Test Setup

Operation of EUT during testing:

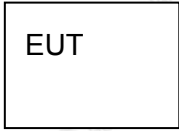

The sample was placed (0.8m below 1GHz, 1.5m above 1GHz) above the ground plane of 3m chamber. Measurements in both horizontal and vertical polarities were performed. During the test, each emission was maximized by: having the EUT continuously working, investigated all operating modes, rotated about all 3 axis (X, Y & Z) and considered typical configuration to obtain worst position, manipulating interconnecting cables, rotating the turntable, varying antenna height from 1m to 4m in both horizontal and vertical polarizations. The emissions worst-case are shown in Test Results of the following pages. The worst case is X position.

2.4. Description of Support Units

The EUT has been tested as an independent unit together with other necessary accessories or support units. The following support units or accessories were used to form a representative test configuration during the tests.

Item	Equipment	Trade Mark	Model/Type No.	Specification	Remark
1	6 BUTTONS WIRELESS MOUSE	N/A	2604760	N/A	EUT
2	RF Cable	N/A	N/A	Length:0.1m	Peripheral

Note:

1. All the equipment/cables were placed in the worst-case configuration to maximize the emission during the test.
2. Grounding was established in accordance with the manufacturer’s requirements and conditions for the intended use.
3. For conducted measurements (Occupied Bandwidth), the antenna of EUT is connected to the test equipment via temporary antenna connector, the antenna connector is soldered on the antenna port of EUT, and the temporary antenna connector is listed in the Test Instruments.



2.5. Measurement Instruments List

Item	Equipment	Manufacturer	Model No.	Serial No.	Last Cal.	Cal. Interval
1.	L.I.S.N. Artificial Mains Network	R&S	ENV216	HKE-002	Feb. 17, 2023	1 Year
2.	Receiver	R&S	ESR-7	HKE-005	Feb. 17, 2023	1 Year
3.	RF automatic control unit	Tonscend	JS0806-2	HKE-060	Feb. 17, 2023	1 Year
4.	Spectrum analyzer	R&S	FSP40	HKE-025	Feb. 17, 2023	1 Year
5.	Spectrum analyzer	Agilent	N9020A	HKE-048	Feb. 17, 2023	1 Year
6.	Preamplifier	Schwarzbeck	BBV 9743	HKE-006	Feb. 17, 2023	1 Year
7.	EMI Test Receiver	Rohde & Schwarz	ESR-7	HKE-010	Feb. 17, 2023	1 Year
8.	Bilog Broadband Antenna	Schwarzbeck	VULB9163	HKE-012	Feb. 17, 2023	1 Year
9.	Loop Antenna	Schwarzbeck	FMZB 1519 B	HKE-014	Feb. 17, 2023	1 Year
10.	Horn Antenna	Schwarzbeck	9120D	HKE-013	Feb. 17, 2023	1 Year
11.	Pre-amplifier	EMCI	EMC051845S E	HKE-015	Feb. 17, 2023	1 Year
12.	Pre-amplifier	Agilent	83051A	HKE-016	Feb. 17, 2023	1 Year
13.	EMI Test Software EZ-EMC	Tonscend	JY3120-B Version	HKE-083	N/A	N/A
14.	Power Sensor	Agilent	E9300A	HKE-086	Feb. 17, 2023	1 Year
15.	Spectrum analyzer	Agilent	N9020A	HKE-048	Feb. 17, 2023	1 Year
16.	Signal generator	Agilent	N5182A	HKE-029	Feb. 17, 2023	1 Year
17.	Signal Generator	Agilent	83630A	HKE-028	Feb. 17, 2023	1 Year
18.	Shielded room	Shiel Hong	4*3*3	HKE-039	Dec. 09, 2021	3 Year
19.	Hight gain antenna	Schwarzbeck	LB-180400KF	HKE-054	Feb. 17, 2023	1 Year
20.	10dB Attenuator	Schwarzbeck	VTSD9561F	HKE-153	Feb. 17, 2023	1 Year

The results shown in this test report refer only to the sample(s) tested unless otherwise stated and the sample(s) are retained for 30 days only. The document is issued by HUAK, this document cannot be reproduced except in full with our prior written permission. The more details and the authenticity of the report will be confirmed at <http://www.cer-mark.com>.

TEL : +86-755 2302 9901 FAX : +86-755 2302 9901 E-mail : service@cer-mark.com

Add: 1-2F., Building B2, Junfeng Zhongcheng Zhizao Innovation Park, Heping Community, Fuhai Street, Bao'an District, Shenzhen, Guangdong, China



3. Conducted Emissions Test

3.1. Conducted Power Line Emission Limit

For unintentional device, according to § 15.107(a) Line Conducted Emission Limits is as following.

Frequency (MHz)	Maximum RF Line Voltage (dBµV)			
	CLASS A		CLASS B	
	Q.P.	Ave.	Q.P.	Ave.
0.15 - 0.50	79	66	66-56*	56-46*
0.50 - 5.00	73	60	56	46
5.00 - 30.0	73	60	60	50

* Decreasing linearly with the logarithm of the frequency.

For intentional device, according to §15.207(a) Line Conducted Emission Limit is same as above table.

3.2. Test Setup

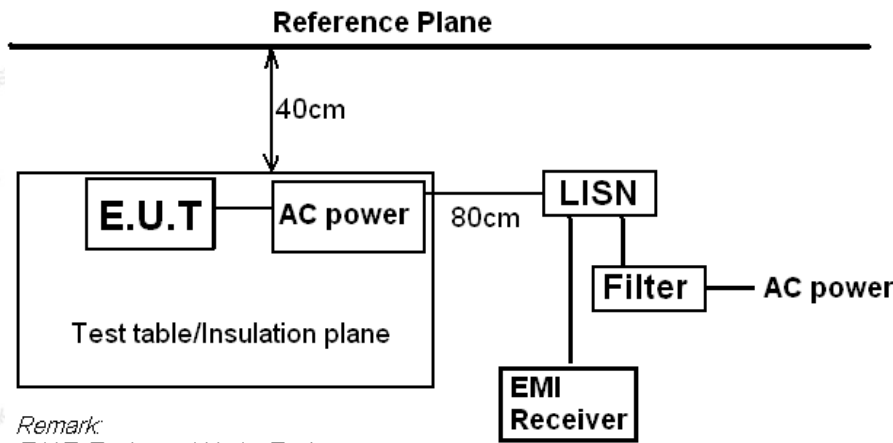

Remark:
 E.U.T: Equipment Under Test
 LISN: Line Impedance Stabilization Network
 Test table height=0.8m

3.3. Test Procedure

1. The equipment was set up as per the test configuration to simulate typical actual usage per the user's manual. The EUT is a tabletop system, a wooden table with a height of 0.8 meters is used and is placed on the ground plane as per ANSI C63.10.
2. Support equipment, if needed, was placed as per ANSI C63.10.
3. All I/O cables were positioned to simulate typical actual usage as per ANSI C63.10.
4. If a EUT received DC power from the USB Port of Notebook PC, the PC's adapter received AC120V/60Hz power through a Line Impedance Stabilization Network (LISN) which supplied power source and was grounded to the ground plane.
5. All support equipments received AC power from a second LISN, if any.
6. The EUT test program was started. Emissions were measured on each current carrying line of the EUT using a spectrum Analyzer / Receiver connected to the LISN powering the EUT. The LISN has two monitoring points: Line 1 (Hot Side) and Line 2 (Neutral Side). Two scans were taken: one with Line 1 connected to Analyzer / Receiver and Line 2 connected to a 50 ohm load; the second scan had Line 1 connected to a 50 ohm load and Line 2 connected to the Analyzer / Receiver.
7. Analyzer / Receiver scanned from 150 KHz to 30MHz for emissions in each of the test modes.



3.4. Test Result

Not applicable.

Note: EUT power supply by DC Power, so this test item not applicable.

4. Radiated Emission Test

4.1. Radiation Limit

For unintentional device, according to § 15.109(a), except for Class A digital devices, the field strength of radiated emissions from unintentional radiators at a distance of 3 meters shall not exceed the following values:

Frequency (MHz)	Distance (Meters)	Radiated (dB μ V/m)	Radiated (μ V/m)
0.009-0.490	300	20log 2400/F (kHz)	2400/F (kHz)
0.490-1.705	30	20log 24000/F (kHz)	24000/F (kHz)
1.705-30	30	20log 30	30
30-88	3	40	100
88-216	3	43.5	150
216-960	3	46	200
Above 960	3	54	500

For intentional device, according to § 15.209(a), the general requirement of field strength of radiated emissions from intentional radiators at a distance of 3 meters shall not exceed the above table.

4.2. Test Setup

(1) Radiated Emission Test-Up Frequency Below 30MHz

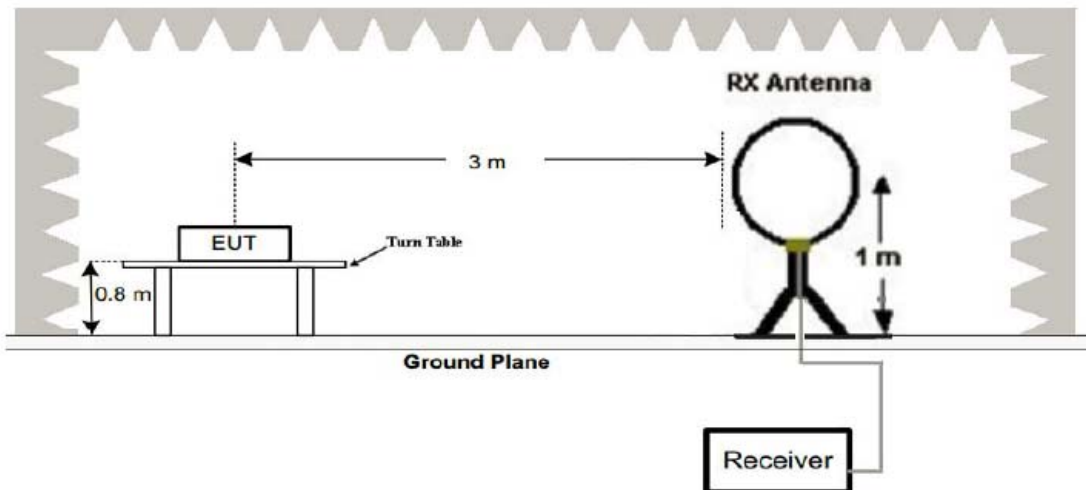

(2) Radiated Emission Test-Up Frequency 30MHz~1GHz

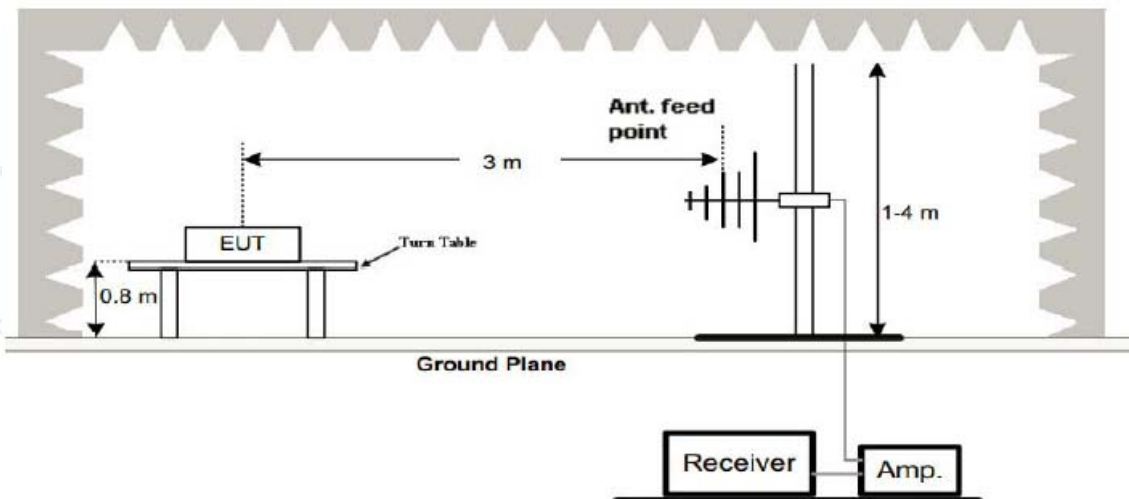

(3) Radiated Emission Test-Up Frequency Above 1GHz

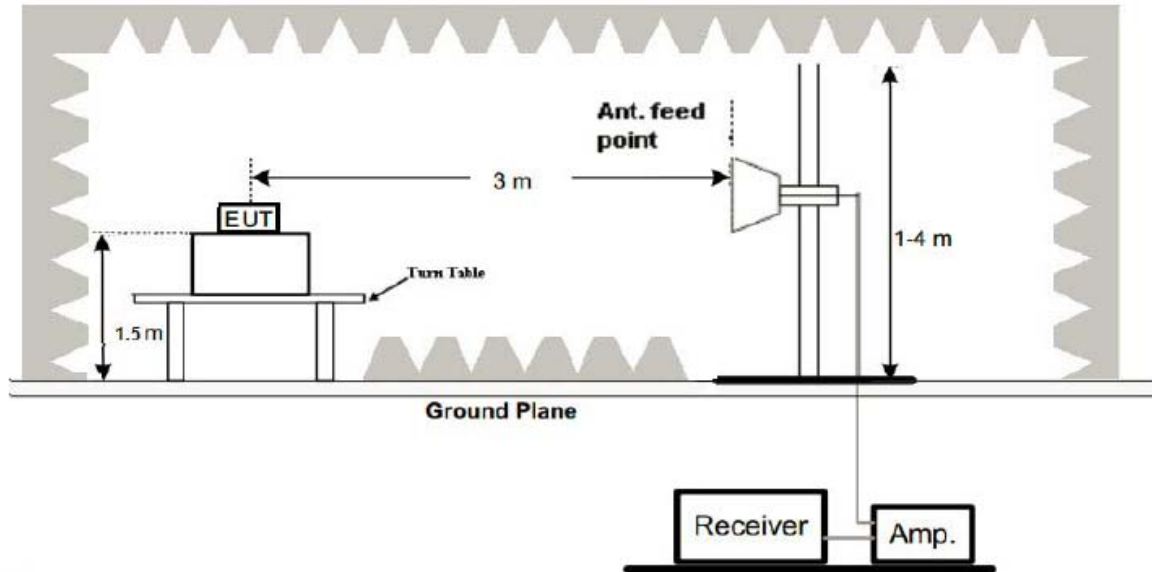

4.3. Test Procedure

1. Below 1GHz measurement the EUT is placed on turntable which is 0.8m above ground plane. And above 1GHz measurement EUT was placed on low permittivity and low tangent turn table which is 1.5m above ground plane.
2. The turntable shall be rotated for 360 degrees to determine the position of maximum emission level.
3. EUT is set 3m away from the receiving antenna, which is varied from 1m to 4m to find out the highest emissions.
4. Maximum procedure was performed on the six highest emissions to ensure EUT compliance.
5. And also, each emission was to be maximized by changing the polarization of receiving antenna both horizontal and vertical.
6. Repeat above procedures until the measurements for all frequencies are complete.
7. The test frequency range from 9KHz to 25GHz per FCC PART 15.33(a).

Note:

For battery operated equipment, the equipment tests shall be performed using a new battery.

4.4. Test Result

PASS

All the test modes completed for test. The worst case of Radiated Emission is Low channel; the test data of this mode was reported.



Below 1GHz Test Results:

Antenna polarity: H

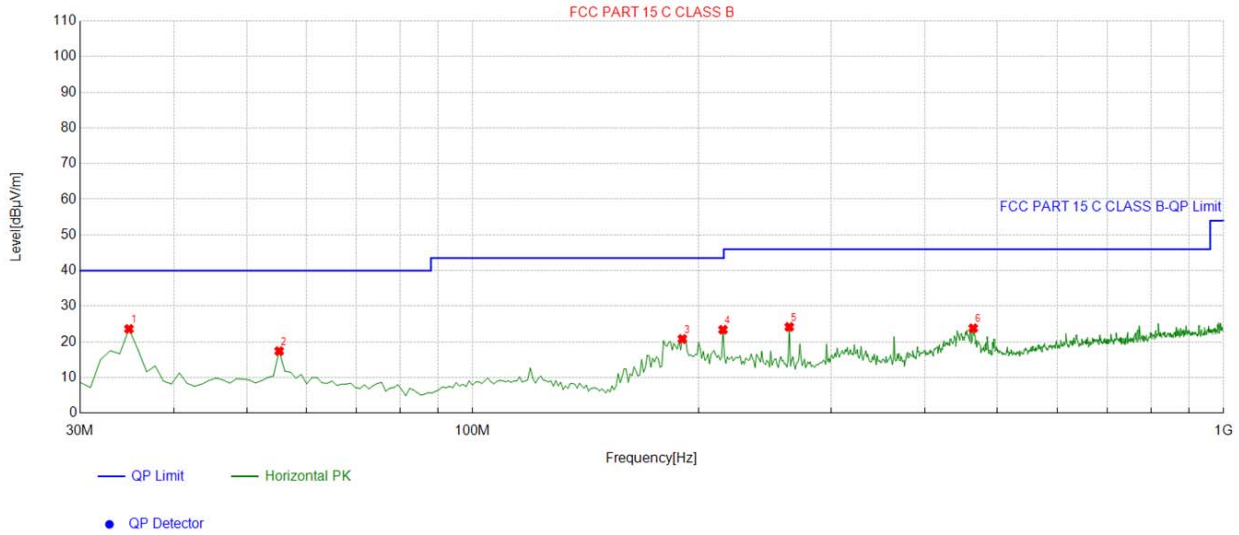

Suspected List									
NO.	Freq. [MHz]	Factor [dB]	Reading [dBµV/m]	Level [dBµV/m]	Limit [dBµV/m]	Margin [dB]	Height [cm]	Angle [°]	Polarity
1	34.854855	-16.04	39.67	23.63	40.00	16.37	100	140	Horizontal
2	55.245245	-14.32	31.74	17.42	40.00	22.58	100	348	Horizontal
3	190.21021	-17.06	37.88	20.82	43.50	22.68	100	112	Horizontal
4	215.45545	-14.42	37.83	23.41	43.50	20.09	100	159	Horizontal
5	264.00400	-12.71	36.90	24.19	46.00	21.81	100	156	Horizontal
6	464.02402	-8.25	32.07	23.82	46.00	22.18	100	291	Horizontal

Remark: Factor = Cable loss + Antenna factor – Preamplifier; Level = Reading + Factor; Margin = Limit – Level



Antenna polarity: V

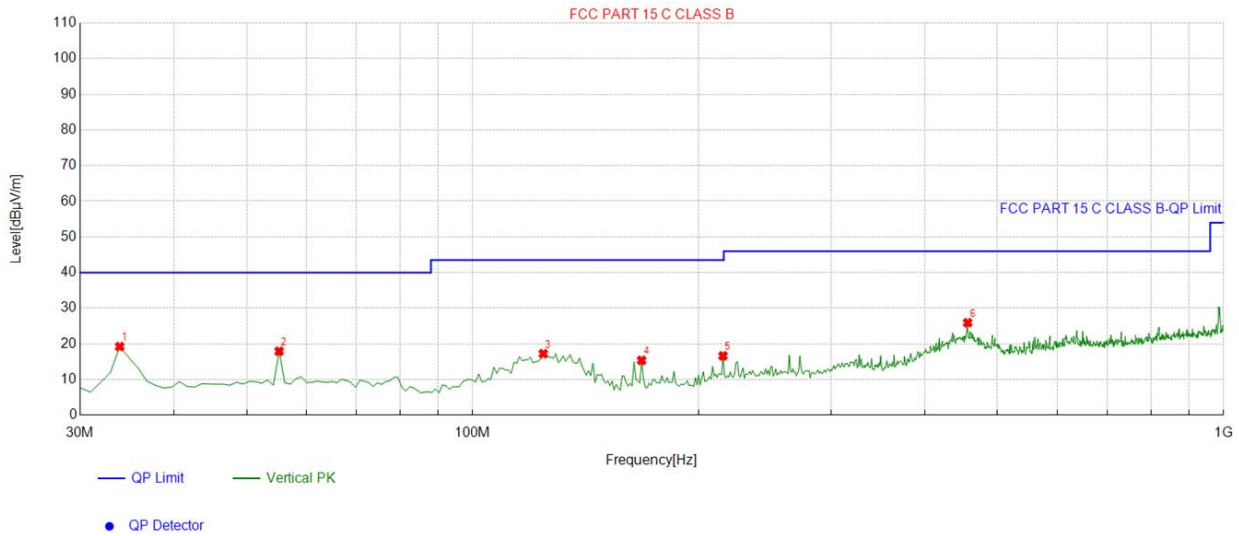

Suspected List									
NO.	Freq. [MHz]	Factor [dB]	Reading [dBµV/m]	Level [dBµV/m]	Limit [dBµV/m]	Margin [dB]	Height [cm]	Angle [°]	Polarity
1	33.883884	-16.38	35.63	19.25	40.00	20.75	100	352	Vertical
2	55.245245	-14.32	32.25	17.93	40.00	22.07	100	359	Vertical
3	124.18418	-16.08	33.33	17.25	43.50	26.25	100	121	Vertical
4	167.87787	-16.99	32.37	15.38	43.50	28.12	100	313	Vertical
5	215.45545	-14.42	31.06	16.64	43.50	26.86	100	217	Vertical
6	456.25625	-8.37	34.30	25.93	46.00	20.07	100	340	Vertical

Remark: Factor = Cable loss + Antenna factor – Pre-amplifier; Level = Reading + Factor; Margin = Limit – Level

Harmonics and Spurious Emissions

Frequency Range (9 kHz-30MHz)

Frequency (MHz)	Level@3m (dBµV/m)	Limit@3m (dBµV/m)
--	--	--
--	--	--
--	--	--
--	--	--

Note: 1. Emission Level=Reading+ Cable loss+ Antenna factor-Amp factor.

2. The emission levels are 20 dB below the limit value, which are not reported. It is deemed to comply with the requirement.



Above 1 GHz Test Results:

CH Low (2402.65MHz)

Horizontal:

Frequency (MHz)	Meter Reading (dBµV)	Factor (dB)	Emission Level (dBµV/m)	Limits (dBµV/m)	Margin (dB)	Detector Type
2402.65	102.04	-5.84	96.2	114	-17.8	peak
2402.65	81.34	-5.84	75.5	94	-18.5	AVG
4805.30	54.13	-3.64	50.49	74	-23.51	peak
4805.30	42.24	-3.64	38.6	54	-15.4	AVG
7207.95	51.32	-0.95	50.37	74	-23.63	peak
7207.95	39.99	-0.95	39.04	54	-14.96	AVG

Remark: Factor = Antenna Factor + Cable Loss – Pre-amplifier; Level = Reading + Factor; Margin = Level-Limit.

Vertical:

Frequency (MHz)	Meter Reading (dBµV)	Factor (dB)	Emission Level (dBµV/m)	Limits (dBµV/m)	Margin (dB)	Detector Type
2402.65	102.44	-5.84	96.6	114	-17.4	peak
2402.65	82.05	-5.84	76.21	94	-17.79	AVG
4805.30	51.18	-3.64	47.54	74	-26.46	peak
4805.30	43.02	-3.64	39.38	54	-14.62	AVG
7207.95	50.77	-0.95	49.82	74	-24.18	peak
7207.95	42.61	-0.95	41.66	54	-12.34	AVG

Remark: Factor = Antenna Factor + Cable Loss – Pre-amplifier; Level = Reading + Factor; Margin = Level-Limit.



CH Middle (2441.65MHz)

Horizontal:

Frequency (MHz)	Meter Reading (dBμV)	Factor (dB)	Emission Level (dBμV/m)	Limits (dBμV/m)	Margin (dB)	Detector Type
2441.65	103.86	-5.71	98.15	114	-15.85	peak
2441.65	71.69	-5.71	65.98	94	-28.02	AVG
4883.30	52.73	-3.51	49.22	74	-24.78	peak
4883.30	41.25	-3.51	37.74	54	-16.26	AVG
7324.95	50.23	-0.82	49.41	74	-24.59	peak
7324.95	39.79	-0.82	38.97	54	-15.03	AVG

Remark: Factor = Antenna Factor + Cable Loss – Pre-amplifier; Level = Reading + Factor; Margin = Level-Limit.

Vertical:

Frequency (MHz)	Meter Reading (dBμV)	Factor (dB)	Emission Level (dBμV/m)	Limits (dBμV/m)	Margin (dB)	Detector Type
2441.65	102.41	-5.71	96.7	114	-17.3	peak
2441.65	78.98	-5.71	73.27	94	-20.73	AVG
4883.30	54.48	-3.51	50.97	74	-23.03	peak
4883.30	44.62	-3.51	41.11	54	-12.89	AVG
7324.95	51.45	-0.82	50.63	74	-23.37	peak
7324.95	40.24	-0.82	39.42	54	-14.58	AVG

Remark: Factor = Antenna Factor + Cable Loss – Pre-amplifier; Level = Reading + Factor; Margin = Level-Limit.



CH High (2480.65MHz)

Horizontal:

Frequency (MHz)	Meter Reading (dBµV)	Factor (dB)	Emission Level (dBµV/m)	Limits (dBµV/m)	Margin (dB)	Detector Type
2480.65	105.31	-5.65	99.66	114	-14.34	peak
2480.65	80.93	-5.65	75.28	94	-18.72	AVG
4961.30	54.03	-3.43	50.6	74	-23.4	peak
4961.30	42.06	-3.43	38.63	54	-15.37	AVG
7441.95	53.52	-0.75	52.77	74	-21.23	peak
7441.95	40.49	-0.75	39.74	54	-14.26	AVG

Remark: Factor = Antenna Factor + Cable Loss – Pre-amplifier; Level = Reading + Factor; Margin = Level-Limit.

Vertical:

Frequency (MHz)	Meter Reading (dBµV)	Factor (dB)	Emission Level (dBµV/m)	Limits (dBµV/m)	Margin (dB)	Detector Type
2480.65	104.84	-5.65	99.19	114	-14.81	peak
2480.65	78.72	-5.65	73.07	94	-20.93	AVG
4961.30	52.75	-3.43	49.32	74	-24.68	peak
4961.30	43.86	-3.43	40.43	54	-13.57	AVG
7441.95	52.12	-0.75	51.37	74	-22.63	peak
7441.95	40.86	-0.75	40.11	54	-13.89	AVG

Remark: Factor = Antenna Factor + Cable Loss – Pre-amplifier; Level = Reading + Factor; Margin = Level-Limit.

Remark :

- (1) Measuring frequencies from 1 GHz to the 25 GHz.
- (2) "F" denotes fundamental frequency; "H" denotes spurious frequency; "E" denotes band edge frequency.
- (3) * denotes emission frequency which appearing within the Restricted Bands specified in provision of 15.205, then the general radiated emission limits in 15.209 apply.
- (4) The emissions are attenuated more than 20dB below the permissible limits are not record in the report.
- (5) The IF bandwidth of EMI Test Receiver between 30MHz to 1GHz was 120KHz, 1 MHz for measuring above 1 GHz, below 30MHz was 10KHz. The resolution bandwidth of test receiver/spectrum analyzer is 1MHz and video bandwidth is 3MHz for peak measurement with peak detector at frequency above 1GHz. The resolution bandwidth of test receiver/spectrum analyzer is 1MHz and video bandwidth is 10Hz for Average measurement with peak detection at frequency above 1GHz.
- (6) When the test results of Peak Detected below the limits of Average Detected, the Average Detected is not need completed. For example: Top Channel at Fundamental 73.16dBuV/m(PK Value) <93.98(AV Limit), at harmonic 53.20 dBuV/m(PK Value) <54 dBuV/m(AV Limit), the Average Detected not need to completed.
- (7) All modes of operation were investigated and the worst-case emissions are reported.



5. Band Edge

5.1. Limits

FCC PART 15.249(d) Emissions radiated outside of the specified frequency bands, except for harmonics, shall be attenuated by at least 50 dB below the level of the fundamental or to the general radiated emission limits in §15.209, whichever is the lesser attenuation.

5.2. Test Procedure

The band edge compliance of RF radiated emission should be measured by following the guidance in ANSI C63.10 with respect to maximizing the emission by rotating the EUT, measuring the emission while the EUT is situated in three orthogonal planes (if appropriate), adjusting the measurement antenna height and polarization etc. Set RBW to 1MHz and VBM to 3MHz to measure the peak field strength and set RBW to 1MHz and VBW to 10Hz to measure the average radiated field strength.



5.3. Test Result

PASS

Radiated Band Edge Test:

Operation Mode: TX CH Low (2402.65MHz)

Horizontal (Worst case)

Frequency (MHz)	Meter Reading (dBµV)	Factor (dB)	Emission Level (dBµV/m)	Limits (dBµV/m)	Margin (dB)	Detector Type
2310	56.25	-5.81	50.44	74	-23.56	peak
2310	/	-5.81	/	54	/	AVG
2390	54.79	-5.84	48.95	74	-25.05	peak
2390	/	-5.84	/	54	/	AVG
2400	53.17	-5.84	47.33	74	-26.67	peak
2400	/	-5.84	/	54	/	AVG

Remark: Factor = Antenna Factor + Cable Loss – Pre-amplifier; Level = Reading + Factor; Margin = Level-Limit.

Vertical:

Frequency (MHz)	Meter Reading (dBµV)	Factor (dB)	Emission Level (dBµV/m)	Limits (dBµV/m)	Margin (dB)	Detector Type
2310	55.23	-5.81	49.42	74	-24.58	peak
2310	/	-5.81	/	54	/	AVG
2390	52.79	-5.84	46.95	74	-27.05	peak
2390	/	-5.84	/	54	/	AVG
2400	50.16	-5.84	44.32	74	-29.68	peak
2400	/	-5.84	/	54	/	AVG

Remark: Factor = Antenna Factor + Cable Loss – Pre-amplifier; Level = Reading + Factor; Margin = Level-Limit.



Operation Mode: TX CH High (2480.65MHz)

Horizontal (Worst case)

Frequency	Reading Result	Factor	Emission Level	Limits	Margin	Detector Type
(MHz)	(dBµV)	(dB)	(dBµV/m)	(dBµV/m)	(dB)	
2483.50	53.88	-5.65	48.23	74	-25.77	peak
2483.50	/	-5.65	/	54	/	AVG
2500.00	52.16	-5.65	46.51	74	-27.49	peak
2500.00	/	-5.65	/	54	/	AVG

Remark: Factor = Antenna Factor + Cable Loss – Pre-amplifier; Level = Reading + Factor; Margin = Level-Limit.

Vertical:

Frequency	Reading Result	Factor	Emission Level	Limits	Margin	Detector Type
(MHz)	(dBµV)	(dB)	(dBµV/m)	(dBµV/m)	(dB)	
2483.50	55.08	-5.65	49.43	74	-24.57	peak
2483.50	/	-5.65	/	54	/	AVG
2500.00	53.41	-5.65	47.76	74	-26.24	peak
2500.00	/	-5.65	/	54	/	AVG

Remark: Factor = Antenna Factor + Cable Loss – Pre-amplifier; Level = Reading + Factor; Margin = Level-Limit.

Remark: All the other emissions not reported were too low to read and deemed to comply with FCC limit.

Remark:

1. If the PK measured levels comply with average limit, then the average level were deemed to comply with average limit.
2. In restricted bands of operation, the spurious emissions below the permissible value more than 20dB.
3. The amplitude of spurious emissions which are attenuated by more than 20dB below the permissible value has no need to be reported.



6. Occupied Bandwidth Measurement

6.1. Test Setup

Same as Radiated Emission Measurement

6.2. Test Procedure

1. The EUT was placed on a turn table which is 0.8m above ground plane.
2. Set EUT as normal operation.
3. Based on ANSI C63.10 section 6.9.2: RBW= 30KHz. VBW= 91KHz, Span=5MHz.
4. The useful radiated emission from the EUT was detected by the spectrum analyzer with peak detector.

6.3. Measurement Equipment Used

Same as Radiated Emission Measurement

6.4. Test Result

PASS

Frequency	20dB Bandwidth (MHz)	Result
2402.65 MHz	2.011	PASS
2441.65 MHz	2.084	PASS
2480.65 MHz	2.022	PASS

CH: 2402.65MHz



The results shown in this test report refer only to the sample(s) tested unless otherwise stated and the sample(s) are retained for 30 days only. The document is issued by HUAKE, this document cannot be reproduced except in full with our prior written permission. The more details and the authenticity of the report will be confirmed at <http://www.cer-mark.com>.



CH: 2441.65MHz



CH: 2480.65MHz

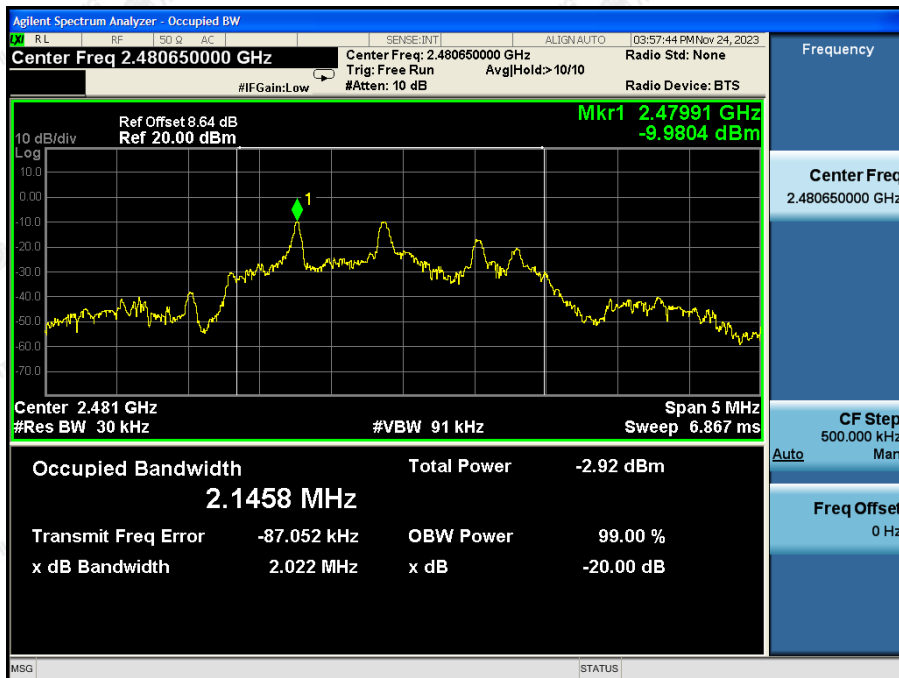

The results shown in this test report refer only to the sample(s) tested unless otherwise stated and the sample(s) are retained for 30 days only. The document is issued by HUAKE, this document cannot be reproduced except in full with our prior written permission. The more details and the authenticity of the report will be confirmed at <http://www.cer-mark.com>.

TEL : +86-755 2302 9901 FAX : +86-755 2302 9901 E-mail : service@cer-mark.com

Add: 1-2F., Building B2, Junfeng Zhongcheng Zhizao Innovation Park, Heping Community, Fuhai Street, Bao'an District, Shenzhen, Guangdong, China

7. Antenna Requirement

Standard Applicable

For intentional device, according to FCC 47 CFR Section 15.203, an intentional radiator shall be designed to ensure that no antenna other than that furnished by the responsible party shall be used with the device.

Antenna Connected Construction

The antenna used in this product is a PCB Antenna, which permanently attached. It conforms to the standard requirements. The directional gains of antenna used for transmitting is 3.85dBi.

Antenna

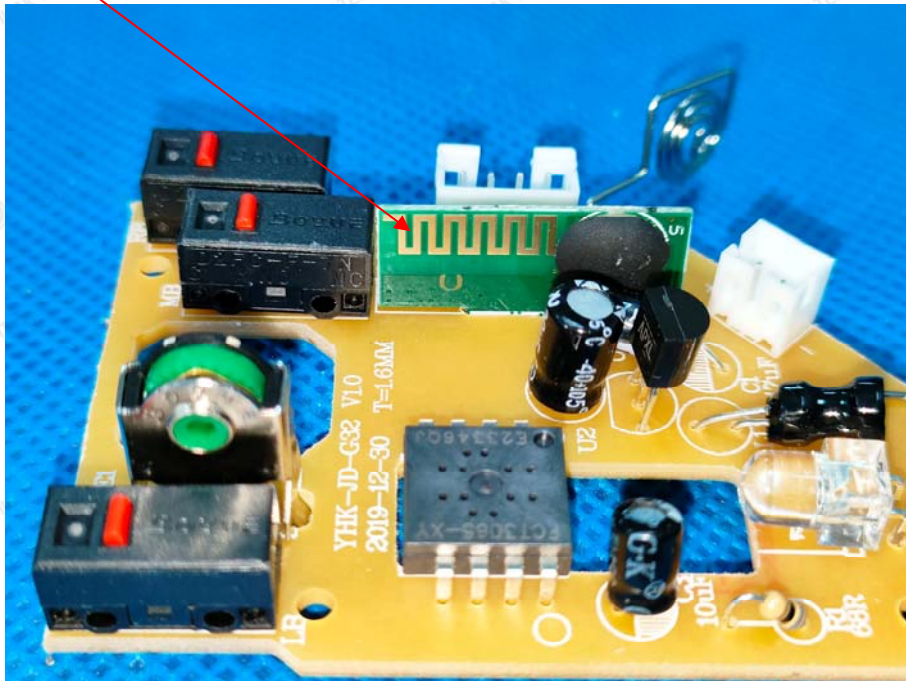



8. Photograph of Test

Radiated Emission

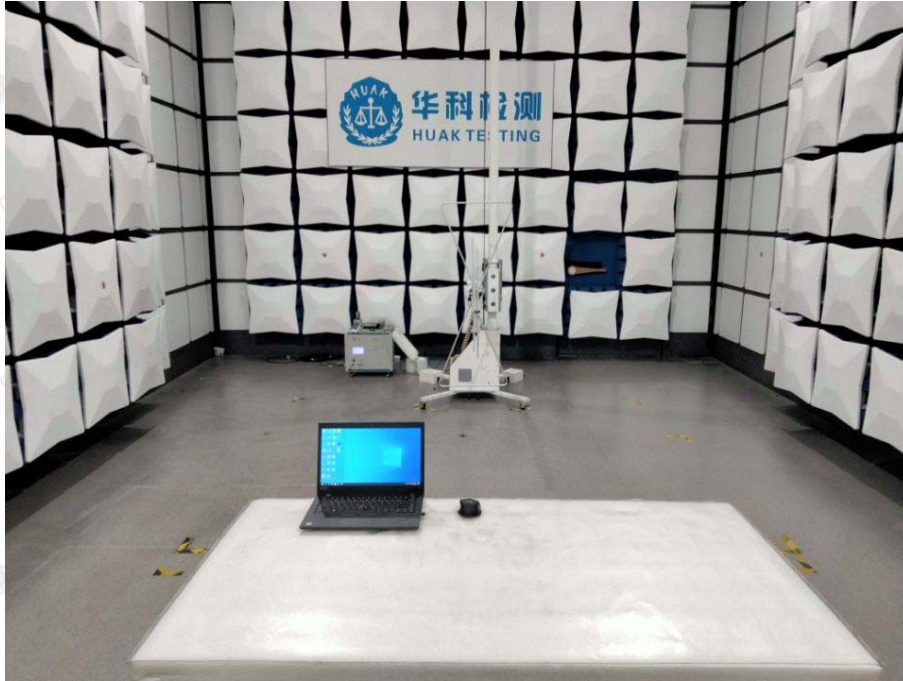

The results shown in this test report refer only to the sample(s) tested unless otherwise stated and the sample(s) are retained for 30 days only. The document is issued by HUAK, this document cannot be reproduced except in full with our prior written permission. The more details and the authenticity of the report will be confirmed at <http://www.cer-mark.com>.

TEL : +86-755 2302 9901 FAX : +86-755 2302 9901 E-mail : service@cer-mark.com

Addr: 1-2F., Building B2, Junfeng Zhongcheng Zhizao Innovation Park, Heping Community, Fuhai Street, Bao'an District, Shenzhen, Guangdong, China



9. Photos of the EUT

Reference to the report: ANNEX A of external photos and ANNEX B of internal photos.

-----End of test report-----