

CONFORMANCE TEST REPORT**FOR****Subpart C Part 15.247****Report No. : JNDL-23RI-0001**

Applicant: DAN-TECH Co., Ltd.
Manufacturer: DAN-TECH Co., Ltd.
Product: DSCAN-3
Model: DS3-100



Date of issue: December 11, 2023

ATTESTATION STATEMENT

This equipment has been tested in accordance with the standards identified in the referenced test report. To the best of my knowledge and belief, these tests were performed using the measurement procedures described in this report and demonstrate that the equipment complies with the appropriate standards.

All JNDL Laboratory. CO., LTD instrumentation and accessories used to test products for compliance to the indicated standards are calibrated regularly in accordance with ISO 17025 requirements.

Total number of pages of this test report : 34 pages

Test engineer	Report reviewed by
	
Eun Min, Lee	Byoung-Su, Shim

REPORT SUMMARY

Purpose of Test :	To demonstrate the EUT in compliance with FCC Part 15 Subpart C for DTS (Part 15 Digital Transmission System)
Disclaimer :	The test results relate only to the items tested.
Applicable Standards :	FCC 47 CFR PART 15 Subpart C (Section §15.247) KDB55804 D01v05r02, ANSI C63.10-2020

TEST ENVIRONMENT AND TEST SETUP

Test Facilities :	Test Firm Registration # : KR0153 3m chamber : B 113, 810 Kwanyang-Dong, dongan-Gu, Anyang-Si, Kyunggi-Do, 431-060, Korea
Laboratory Test Conditions :	3m chamber : Temperature 24 °C, Humidity : 46 %
Test Exercise :	The EUT was set in continuous transmit mode of operation unless stated otherwise.
Modification to the EUT :	No modification was made.
Supporting Accessories :	None

REVISION HISTORY

Revision	Date	Descriptions
0	December 11, 2023	Original release

Table of Contents

- 1. General Remarks**
- 2. Test Site**
 - 2.1 Location**
 - 2.2 List of Test equipment used for tests**
 - 2.3 Test Date**
- 3. Product Information**
 - 3.1 Manufacturers declarations**
 - 3.2 General Specification**
- 4. Measurement Uncertainty**
- 5. Description of Testes**
- 6. TEST CONDITION**
- 7. Test Results**
 - 7.1 Summary of Test Results**
 - 7.2 6 dB bandwidth**
 - 7.3 Output power**
 - 7.4 Power spectral density**
 - 7.5 Radiated restricted band and emission**
 - 7.6 Conducted spurious emission and band edge**
 - 7.7 AC Conducted emissions**

1. General Remarks

The test results in this report apply to the particular Equipment Under Test (EUT) as declared in this report.
The test results presented in this report relate only to the item tested.

2. Test Site

2.1 Location

JNDL Laboratory. CO., LTD. (Test Firm Registration # : KR0153)

3m chamber : B 113, 810 Kwanyang-Dong, dongan-Gu, Anyang-Si, Kyunggi-Do, Korea

2.2 List of Test equipment used for tests

No.	Instrument	Model No.	Due to Calibration	Manufacturer	Serial No.
<input checked="" type="checkbox"/>	EXA SPECTRUM ANALYZER (3 Hz ~ 26.5 GHz)	N9010A	2024-08-10	Keysight	MY55150134
<input checked="" type="checkbox"/>	SPECTRUM ANALYZER (9 KHz ~ 40 GHz)	FSP40	2024-08-10	Rohde & Schwarz	100308
<input checked="" type="checkbox"/>	SIGNAL GENERATOR (10 MHz ~ 40 GHz)	MG3694B	2024-08-11	Anritsu Corp	062513
<input checked="" type="checkbox"/>	POWER METER (DC ~ 67 GHz)	NRP2	2024-08-11	Rohde & Schwarz	100973
<input checked="" type="checkbox"/>	POWER SENSOR (50 MHz ~ 40 GHz)	NRP-Z85	2024-08-11	Rohde & Schwarz	101862
<input checked="" type="checkbox"/>	POWER SENSOR (9 KHz ~ 6 GHz)	NRP-Z92	2024-08-11	Rohde & Schwarz	100093
<input checked="" type="checkbox"/>	EMI TEST RECEIVER (9 KHz ~ 7 GHz)	ESR7	2023-12-09	Rohde & Schwarz	102639
<input checked="" type="checkbox"/>	AUTORAING POWER SUPPLY	E3630A	2024-08-10	Agilent Technologies	MY40005094
<input checked="" type="checkbox"/>	Active Loop Antenna	6502	2025-01-12	ETS-LINDGREN	00148046
<input checked="" type="checkbox"/>	BILOG ANTENNA (30 MHz ~ 1 GHz)	VULB 9168	2025-01-31	Schwarzbeck	9168-505
<input checked="" type="checkbox"/>	HORN ANTENNA (1 GHz ~ 18 GHz)	3117	2024-01-12	ETS-LINDGREN	00135889
<input type="checkbox"/>	HORN ANTENNA (1 GHz ~ 18 GHz)	3117	2024-01-12	ETS-LINDGREN	00135878
<input checked="" type="checkbox"/>	HORN ANTENNA (18 GHz ~ 40 GHz)	BBHA 9170	2024-01-12	Schwarzbeck	9170-499
<input type="checkbox"/>	HORN ANTENNA (18 GHz ~ 40 GHz)	BBHA 9170	2024-01-12	Schwarzbeck	9170-500
<input checked="" type="checkbox"/>	Low Noise Amplifier (10 MHz ~ 1 GHz)	ELNA06-43D	2023-12-09	EXYNOD	9148222
<input checked="" type="checkbox"/>	Low Noise Amplifier (1 GHz ~ 18 GHz)	ELNA18-45D	2024-02-02	EXYNOD	2301181
<input checked="" type="checkbox"/>	Low Noise Amplifier (18 GHz ~ 40 GHz)	AMF-6F-18004000-37-8P	2024-01-12	MITEQ	1814914

→ All equipment is calibrated with traceable calibrations.

Each calibration is traceable to the national or international standards.

2.3 Test Date

Date of Application: October 19, 2023

Date of Test: November 14, 2023 ~ November 30, 2023

3. Product Information

3.1 Manufacturers declarations

Manufacturer :	DAN-TECH Co., Ltd.
Product Description :	Wireless OBD Data Converter
FCC ID :	2BDSM-DS3-100
Model Name :	DS3-100
Multiple Model Name :	-
Operationg Frequency :	2 402 MHz to 2 480 MHz and Channel Spacing 1 MHz (40ch)
Type of Modulation :	GFSK (BLE)
Air Date Rate :	BLE (1 Mbps)
Antenna Type :	Internal Antenna (Chip Antenna)
Antenna Gain :	1.99 dBi max
RF Power :	4.5 mW
EUT Power Source :	Primary power – 12.0 Vdc, 500 mA (Not use AC adapter)
	Secondary Power – N/A

→All the testing were performed according to the procedures in FCC Parts 15.247
The EUT was operation in special test mode.

3.2 General Specification

Item	Specification	
CPU	IMXRT1172 ARM Cortex M7 800MHz	
Memory	CPU SRAM 2 MB + SDRAM 32 MB + Flash 16 MB + eMMC 8 GB	
Wireless	Bluetooth Low Energy 5.2	
	IEEE 802.11 b/g/n/ac/ax (WiFi6 5 GHz only)*	
Vehicle OBD Comm.	FD-CAN (2 Mbps), LS-CAN (125 Kbps), K-LINE (10.5 kbps)	
	DOIP (10/100BASE-1)	
Wire Protocol	HS USB, UART	
Operation	DC 7 ~ 20 V	
Operating Temperature	-10 °C ~ 65 °C (14 °F ~ 149 °F)	
	Noncondensing	-10 °C ~ 10 °C(14 °F ~ 50 °F)
	95 % RH	10 °C ~ 30 °C (50 °F ~ 86 °F)
	70 % RH	30° C ~ 65 °C (86 °F ~ 149 °F)
Sensor	6-axis (Acc. / Gyro.) Sensor	
Indicators	LED x 3ea (Blue/Green/Red color), Buzzer	
Power	0.5 A @DC 12 V	
Size (W x L x T)	86 x 56 x 28 mm	
Weight	90 g	

* Wi-Fi function is FCC-certified modules. (FCC ID : XPYMAYAW2A)

4. Measurement Uncertainty

The Measurement Uncertainties shown below were calculated in accordance with the requirements of ANSI C63.10-2020.

All measurement uncertainty values are shown with a coverage factor of $k=2$ to indicate a 95 % level of confidence.

The measurement data shown herein meets or exceeds the U_{CISPR} measurement uncertainty values specified in CISPER 16-4-2 and, thus, can be compared directly to specified limits to determine compliance.

Parameter	Expanded Uncertainty $U = kU_c (k = 2)$
Conducted Disturbance (150 kHz ~ 30 MHz)	2.68
Radiated Disturbance (9 kHz – 30 MHz)	1.72
Radiated Disturbance (30 MHz – 1 GHz)	3.32
Radiated Disturbance (1 GHz – 18 GHz)	4.30
Radiated Disturbance (18 GHz – 40 GHz)	4.76

5. Description of Test

The tests documented in this report were performed in accordance with ANSI C63.4-2014 and FCC CFR 47 2.1046, 2.1047, 2.1049, 2.1051, 2.1053, 2.1055, 2.1057, 15.207, 15.209 and 15.247.

5.1 Radiated Emission Measurement

Radiated emission measurements were made in accordance with § 13 in ANSI C63.4-2014 "Measurement of Intentional radiators" The measurements were performed over the frequency range of 30 MHz to 40 GHz using antenna as the input transducer to a Spectrum analyzer or a Field Intensity Meter. The measurements were made with the detector set for "Peak, Quasi-peak, Average" within a bandwidth of 120 kHz and above 1 GHz is 1 MHz.

Preliminary measurements were made at 3 m using broadband antennas, and spectrum analyzer to determine the frequency producing the maximum emission in shielded room. Appropriate precaution was taken to ensure that all emission from the EUT were maximized and investigated. The system configuration, mode of operation, turntable azimuth and height with respect to the antenna were noted for each frequency found. The spectrum was scanned from 30 MHz to 1 000 MHz using Log-Bicon antenna. Above 1 GHz, linearly polarized double ridge horn antennas were used. Final measurements were made open site or SVSWR chamber at 3 m. The test equipment was placed on a styrofoam table. Sufficient time for the EUT, support equipment, and test equipment was allowed in order for them to warm up to their normal operating condition. Each frequency found during pre-scan measurements was re-examined by manual. The EUT, support equipment and interconnecting cables were re-configured to the set-up producing the maximum emission for the frequency and were placed on top of a 0.8 m high nonmetallic 1.0 m x 1.5 m table. The EUT, support equipment, and interconnecting cables were re-arranged and manipulated to maximize each emission. The turntable containing the system was rotated; the antenna height was varied 1 m to 4 m and stopped at the azimuth or height producing the maximum emission.

Varying the mode of operating frequencies of the EUT maximized each emission. The system was tested in all the three orthogonal planes and changing the polarity of the antenna. The worst-case emissions are recorded in the data tables. If necessary, the radiated emission measurement could be performed at a closer distance to ensure higher accuracy and the results were extrapolated to the specified distance using an inverse linear distance extrapolation factor (20 dB/decade) as per section 15.31(f).

Photographs of the worst-case emission can be seen in Photographs of the worst-case emission test setup can be seen in Appendix B.

5.2 Conducted Emission Measurement

Conducted emissions measurements were made in accordance with section § 13 in ANSI C63.4-2014 "measurement of intentional radiators" The measurements were performed over the frequency range of 0.15 MHz to 30 MHz using a 50 Ω /50 μ H LISN as the input transducer to a Spectrum Analyzer or a Test Receiver. The measurements were made with the detector set for "Peak" amplitude within a bandwidth of 9 kHz or for "quasi-peak" within a bandwidth of 9 kHz.

The line-conducted emission test is conducted inside a shielded anechoic chamber room with 1 m x 1.5 m x 0.8 m wooden table which is placed 0.4 m away from the vertical wall and 1.5 m away from the side wall of the chamber room. Two LISN are bonded to the shielded room. The EUT is powered from the LISN and the support equipment is powered from the other LISN. Power to the LISNs are filtered by a noise cut power line filters. All electrical cables are shielded by braided tinned steel tubing with inner ϕ 1.2 cm. If the EUT is a DC-powered device, power will be derived from the source power supply it normally will be powered from and these supply lines will be connected to the LISN. Non-inductive bundling to a 1 m length shortened all interconnecting cables more than 1 m. Sufficient time for the EUT, support equipment, and test equipment was allowed in order for them to warm up to their normal operating condition. The RF output of the LISN was connected to the EMI Test Receiver to determine the frequency producing the maximum emission from the EUT. The frequency producing the maximum level was reexamined using to set Quasi-Peak mode by manual, after scanned by automatic Peak mode from 0.15 MHz to 30 MHz. The bandwidth of the spectrum analyzer was set to 9 kHz. The EUT, support equipment, and interconnecting cables were arranged and manipulated to maximize each emission.

Photographs of the worst-case emission can be seen in Photographs of the worst-case emission test setup can be seen in Appendix B.

5.3 FCC Part 15.205 Restricted Bands of Operations

(a) Except as shown in paragraph (d) of this section, only spurious emissions are permitted in any of the frequency bands listed below:

MHz	MHz	MHz	GHz
0.090 - 0.110	16.42 - 16.423	399.9 - 410	4.5 - 5.15
¹ 0.495 - 0.505	16.694 75 - 16.695 25	608 - 614	5.35 - 5.46
2.173 5 - 2.190 5	16.804 25 - 16.804 75	960 - 1 240	7.25 - 7.75
4.125 - 4.128	25.5 - 25.67	1 300 - 1 427	8.025 - 8.5
4.177 25 - 4.177 75	37.5 - 38.25	1 435 - 1 626.5	9.0 - 9.2
4.207 25 - 4.207 75	73 - 74.6	1 645.5 - 1 646.5	9.3 - 9.5
6.215 - 6.218	74.8 - 75.2	1 660 - 1 710	10.6 - 12.7
6.267 75 - 6.268 25	108 - 121.94	1 718.8 - 1 722.2	13.25 - 13.4
6.311 75 - 6.312 25	123 - 138	2 200 - 2 300	14.47 - 14.5
8.291 - 8.294	149.9 - 150.05	2 310 - 2 390	15.35 - 16.2
8.362 - 8.366	156.524 75 - 156.525 25	2 483.5 - 2 500	17.7 - 21.4
8.376 25 - 8.386 75	156.7 - 156.9	2 690 - 2 900	22.01 - 23.12
8.414 25 - 8.414 75	162.012 5 - 167.17	3 260 - 3 267	23.6 - 24.0
12.29 - 12.293	167.72 - 173.2	3 332 - 3 339	31.2 - 31.8
12.519 75 - 12.520 25	240 - 285	3 345.8 - 3 358	36.43 - 36.5
12.576 75 - 12.577 25	322 - 335.4	3 600 - 4 400	(²)
13.36 - 13.41			

¹ Until February 1, 1999, this restricted band shall be 0.490 MHz - 0.510 MHz.

² Above 38.6

(b) Except as provided in paragraphs (d) and (e), the field strength of emissions appearing within these frequency bands shall not exceed the limits shown in Section 15.209. At frequencies equal to or less than 1 000 MHz, compliance with the limits in Section 15.209 shall be demonstrated using measurement instrumentation employing a CISPR quasi-peak detector. Above 1 000 MHz, compliance with the emission limits in Section 15.209 shall be demonstrated based on the average value of the measured emissions. The provisions in Section 15.35 apply to these measurements.

6. Test Condition

6.1 Test Configuration

The device was configured for testing in a typical fashion (as a customer would normally use it). During the tests, the following conditions and configurations were used.

6.2 Description of Test modes

DSCAN-3 that has the control software.

6.3 The setup drawing(s)

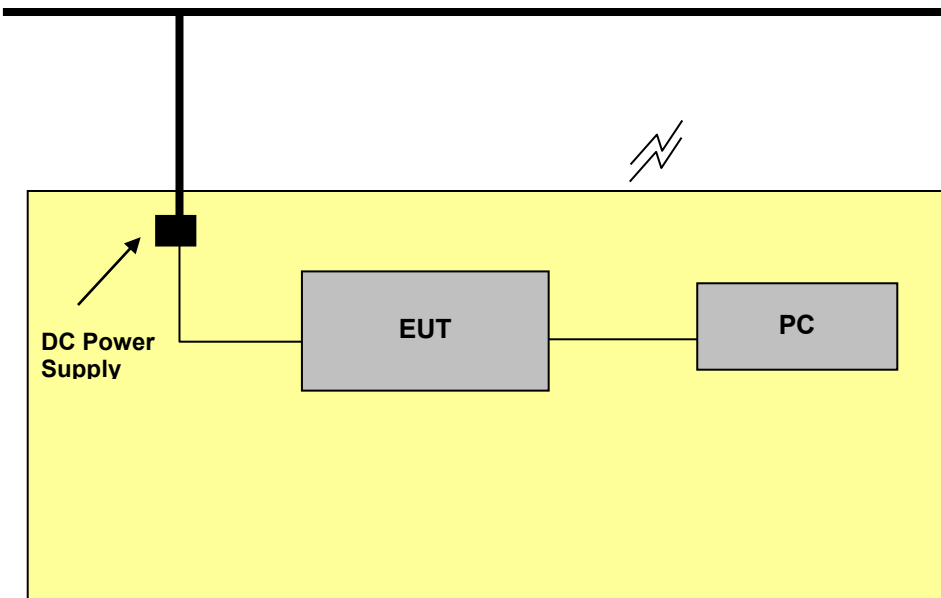

- : Signal line
- : Power line
- : DC Power Supply

7. Test Results

7.1 Summary of Test Results

The measurement results were obtained with the EUT tested in the conditions described in this report. Detailed measurement data and plots showing the maximum emission of the EUT are reported.

47 CFR Part 15, Subpart C	Measurement Required	Result
15.247(a)(2)	6 dB bandwidth	Pass
15.247(b)(3)	Output power	Pass
15.247(e)	Power spectral density	Pass
15.205 15.209	Radiated restricted band and emission	Pass
15.247(d)	Conducted spurious emission and band edge	Pass
15.207	AC Conducted emissions	N/A

The data collected shows that the **DAN-TECH Co., Ltd. / DSCAN-3 / DS3-100** complied with technical requirements of above rules part 15.207, 209 and 15.247 Limits.

The equipment is not modified anything, mechanical or circuits to improve EMI status during a measurement. No EMI suppression device(s) was added and/or modified during testing.

7.2 6 dB bandwidth

Limit

According to § 15.247(a)(2), systems using digital modulation techniques may operate 902 ~ 928 MHz, 2 400 ~ 2 483.5 MHz, and 5 725 ~ 5 850 MHz bands. The minimum 6 dB bandwidth shall be at least 500 kHz.

Test Data

Channel	Frequency [MHz]	6 dB bandwidth [MHz]	Limit
Low	2 402	0.653	≥ 0.500
Mid	2 440	0.646	
High	2 480	0.642	

Plots of 6 dB Bandwidth (LE 1 Mbps)

[2 402 MHz]

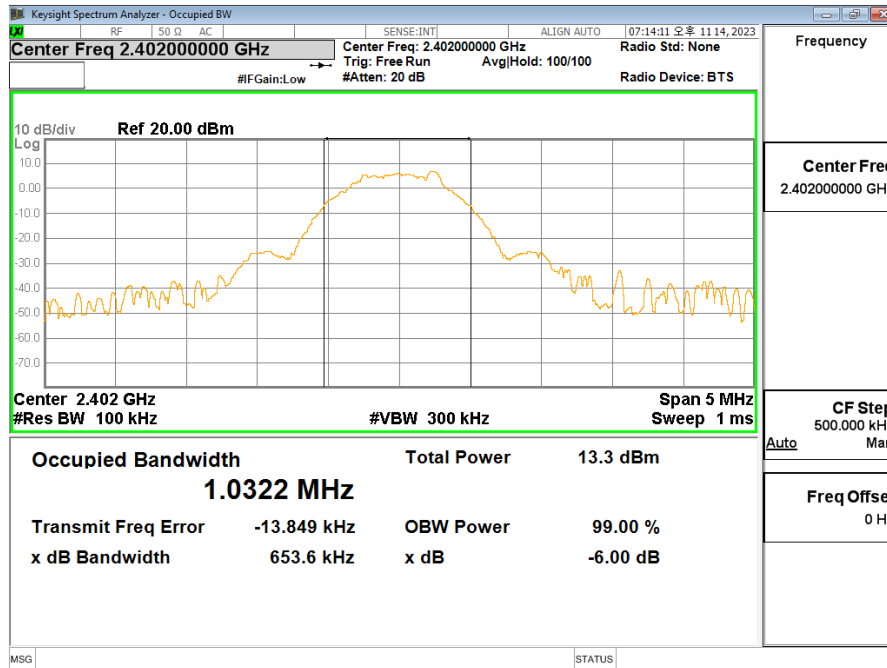

[2 440 MHz]

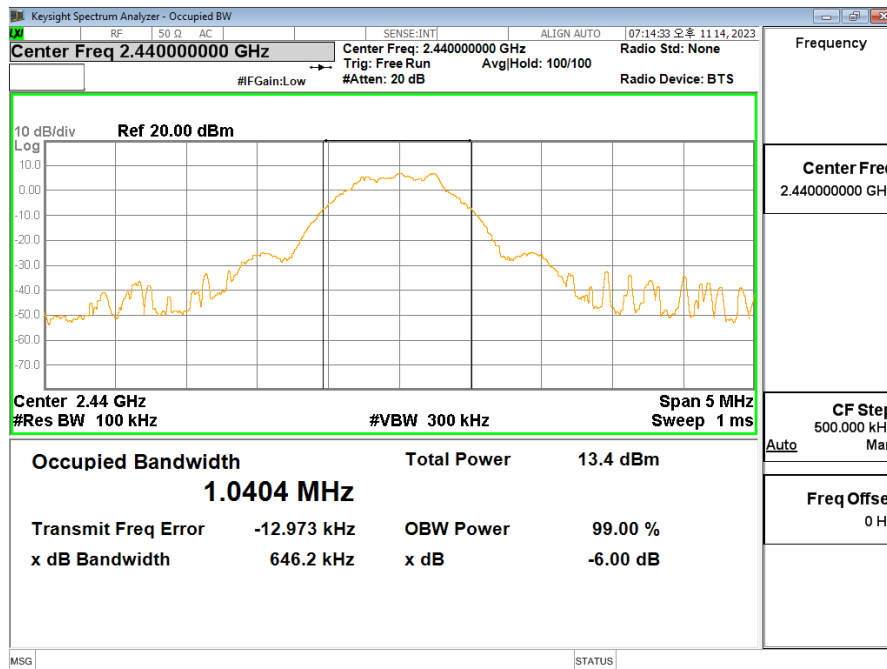

[2 480 MHz]

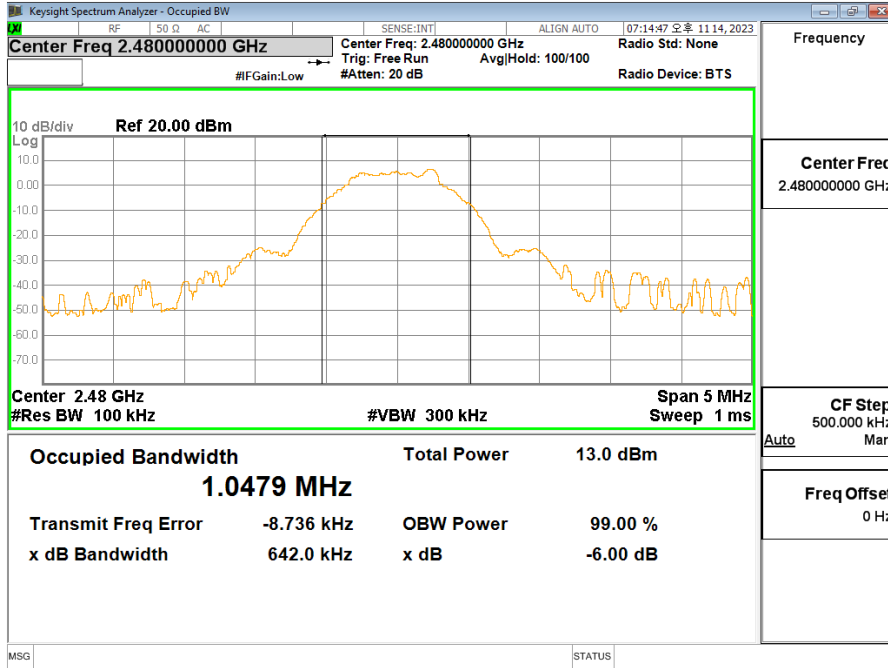

7.3 Output power

Limit

According to §15.247(b)(3), For systems using digital modulation in the 902~928 MHz, 2 400~2 483.5 MHz, and 5 725~5 850 MHz bands: 1 Watt. As an alternative to a peak power measurement, compliance with the one Watt limit can be based on a measurement of the maximum conducted out-put power. Maximum Conducted Out-put Power is defined as the total transmit power delivered to all antennas and antenna elements averaged across all symbols in the signaling alphabet when the transmitter is operating at its maximum power control level. Power must be summed across all antennas and antenna elements. The average must not include any time intervals during which the transmitter is off or is transmitting at a reduced power level. If multiple modes of operation are possible (e.g., alternative modulation methods), the maximum conducted output power is the highest total transmit power occurring in any mode.

Test Data

Mode	2 402 MHz		2 440 MHz		2 480 MHz	
	Average (dBm)	Peak (dBm)	Average (dBm)	Peak (dBm)	Average (dBm)	Peak (dBm)
LE 1 Mbps	5.72	6.48	5.73	6.49	5.21	6.20

NOTES:

1. Measure conducted Channel power of relevant channel using power sensor
2. Please see the measured plot in next page.

Plots of Output power (LE 1 Mbps)

[2 402 MHz]

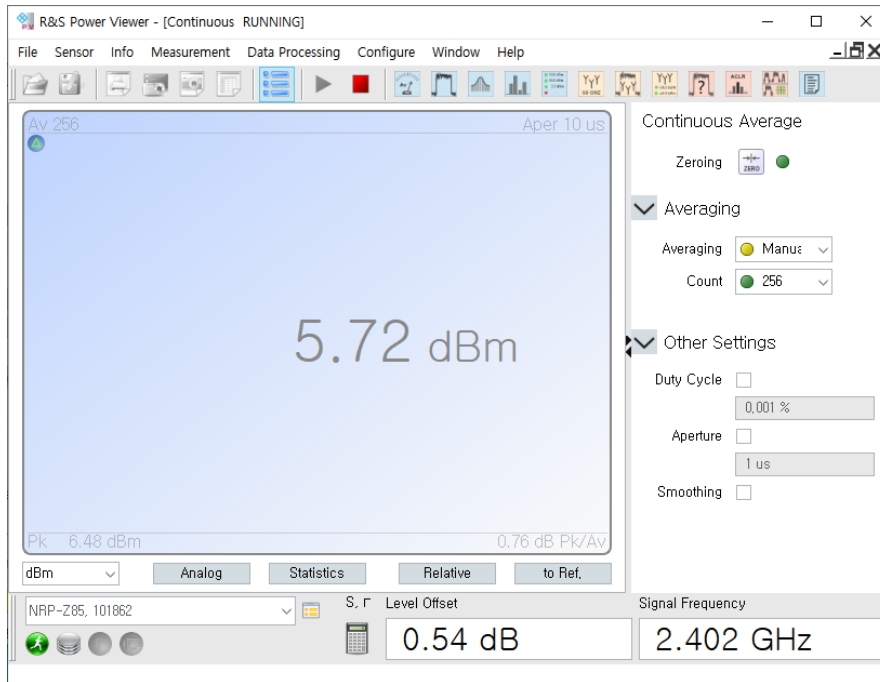

[2 440 MHz]

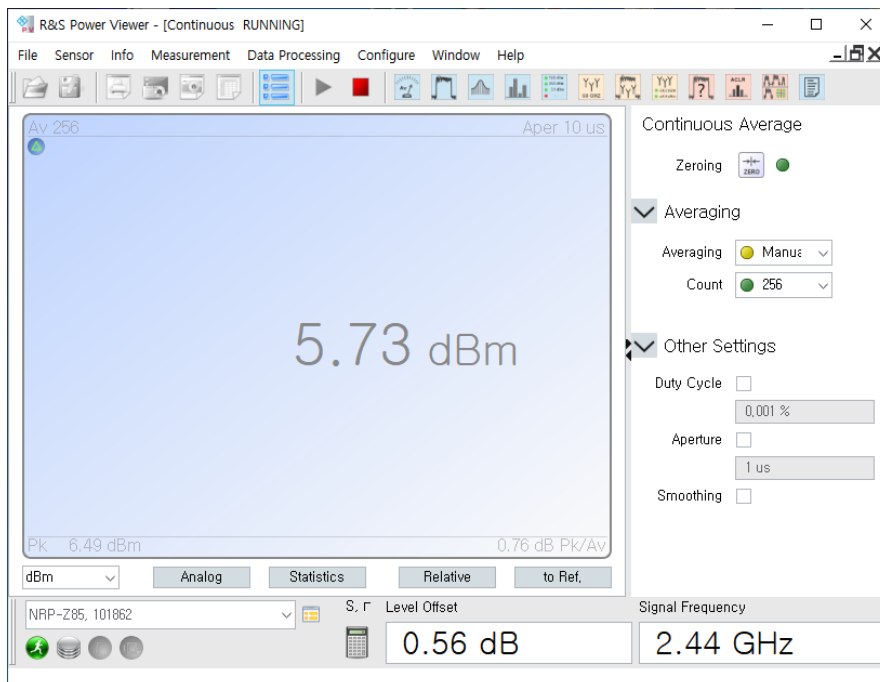

[2 480 MHz]

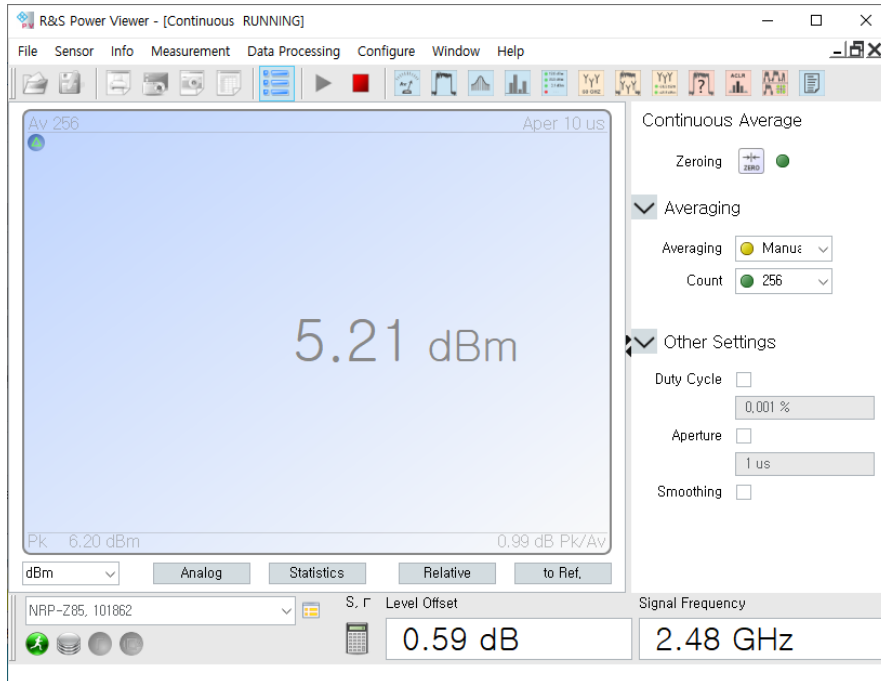

7.4 Power spectral density

Limit

According to §15.247(e), For digitally modulated systems, the power spectral density conducted from the intentional radiator to the antenna shall not be greater than 8 dB m in any 3 kHz band during any time interval of continuous transmission. This power spectral density shall be determined in accordance with the provisions of paragraph (b) of this section. The same method of determining the conducted output power shall be used to determine the power spectral density.

Test Results

Channel	Frequency [MHz]	PSD [dBm]	Limit[dBm]
Low	2 402	-11.290	8
Mid	2 440	-11.584	
High	2 480	-11.636	

Plots of Power spectral density (LE 1 Mbps)

[2 402 MHz]

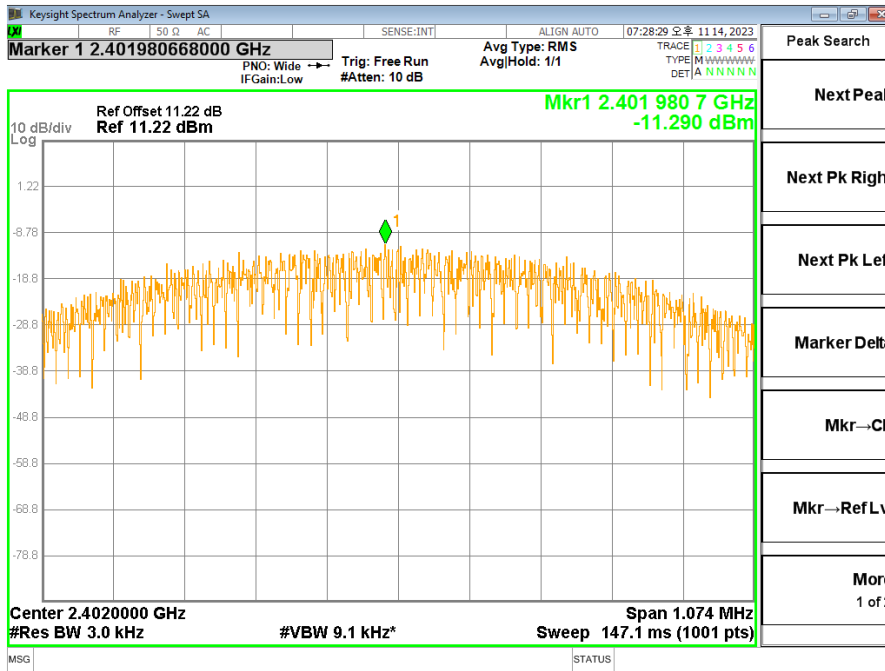

[2 440 MHz]

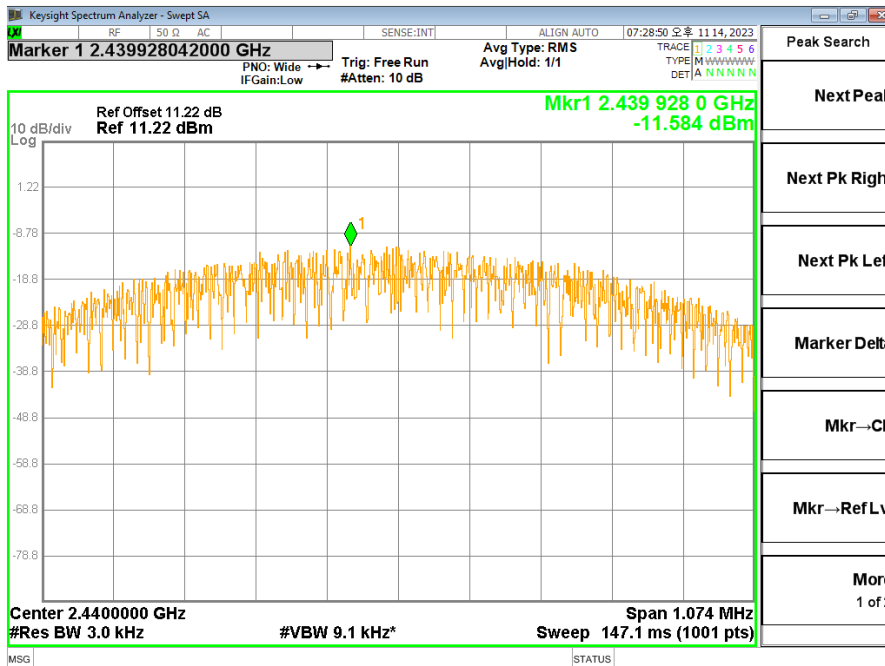

[2 480 MHz]

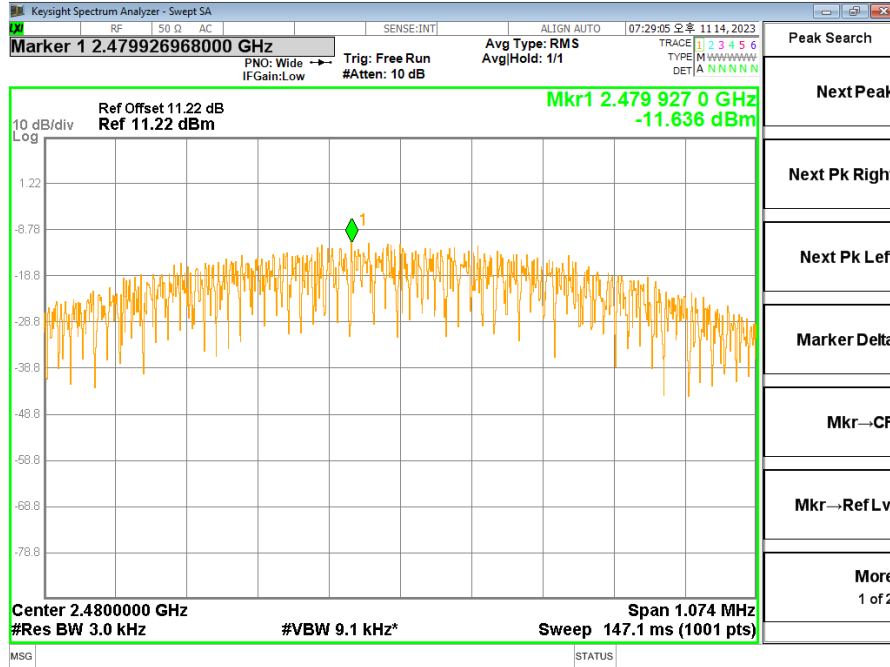

7.5 Spurious Emissions

Limit

Except as provided elsewhere in this Subpart, the emissions from an intentional radiator shall not exceed the field strength levels specified in the following table:

Frequencies [MHz]	Field Strength [$\mu\text{V/m}$]	Measurement Distance [m]
0.009 - 0.490	$2\,400/F(\text{kHz})$	300
0.490 - 1.705	$24\,000/F(\text{kHz})$	30
1.705 - 30.0	30	30
30 - 88	100	3
88 - 216	150	3
216 - 960	200	3
Above 960	500	3

* Except as provided in paragraph (g), fundamental emissions from intentional radiators operating under this Section shall not be located in the frequency bands 54 MHz - 72 MHz, 76 MHz - 88 MHz, 174 MHz - 216 MHz or 470 MHz - 806 MHz. However, operation within these frequency bands is permitted under other sections of this Part, e.g., Sections 15.231 and 15.241.

Test Setup

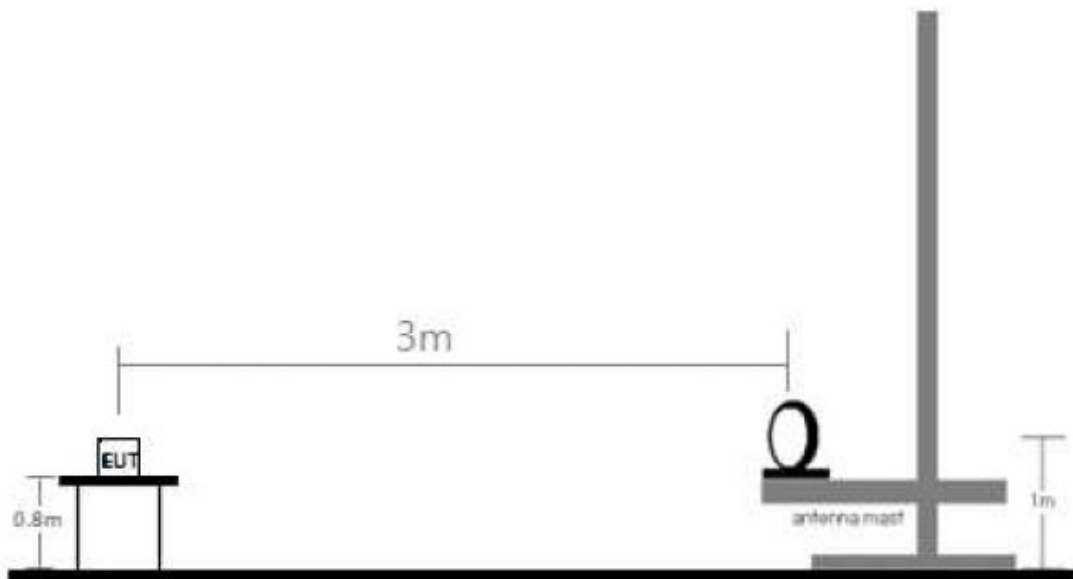

[Radiated Emission Test Setup Below 30 MHz]

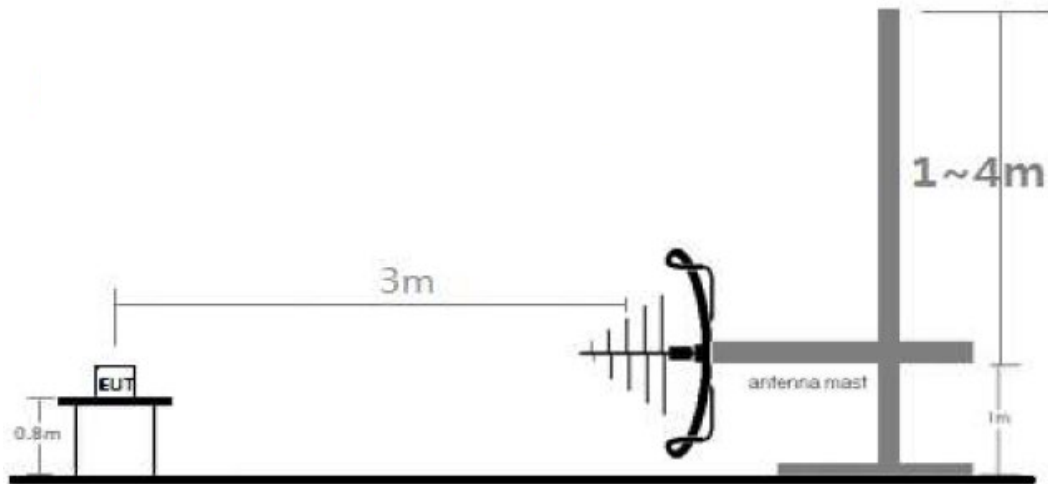

[Radiated Emission Test Setup Below 1 GHz]

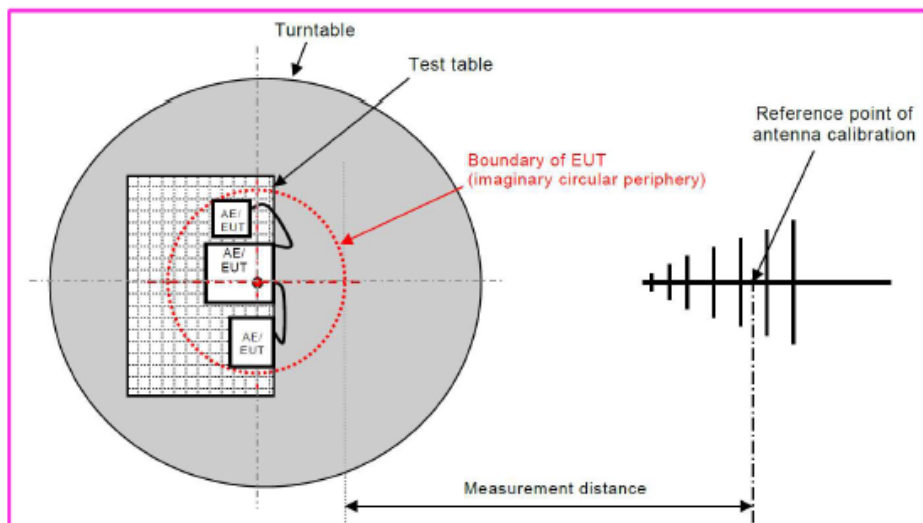
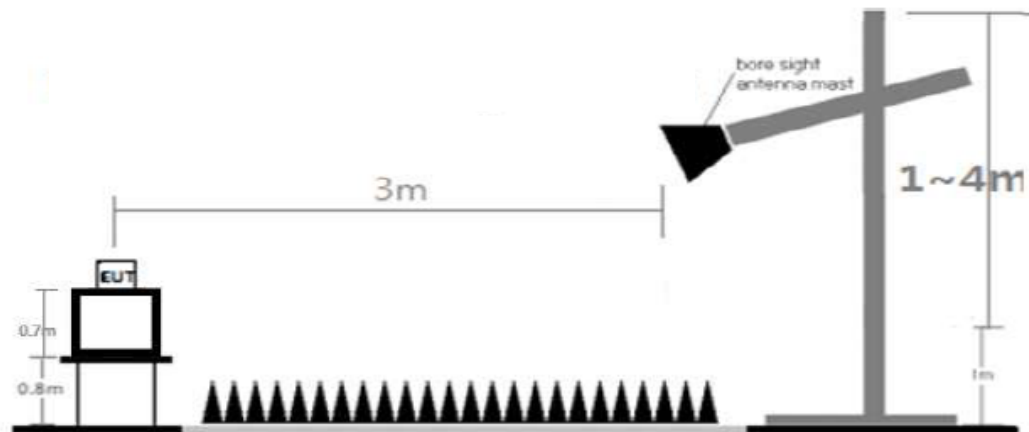

[Radiated Emission Test Setup Above 1 GHz]

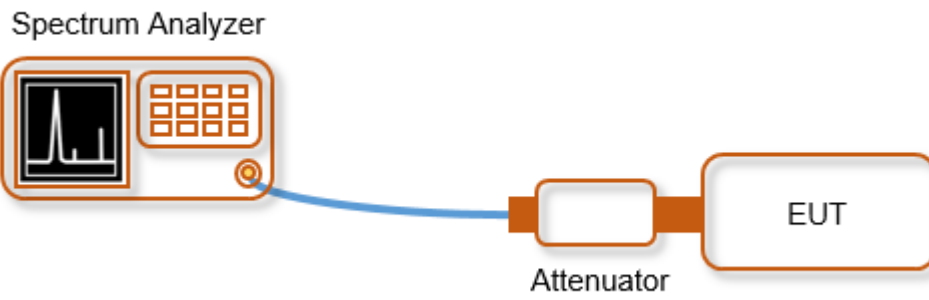

[Conducted Spurious Emission]

Duty cycle

Regarding to KDB 558074 D01_v05 r02, 6. Measurements of duty cycle and transmission duration shall be performed using one of the following techniques:

- a) A diode detector and an oscilloscope that together have sufficiently short response time to permit accurate measurements of the on- and off-times of the transmitted signal.
- b) The zero-span mode on a spectrum analyzer or EMI receiver if the response time and spacing between bins on the sweep are sufficient to permit accurate measurements of the on- and off-times of the transmitted signal.

T _{on} time [ms]	Period [ms]	Duty cycle [Linear]	Duty cycle [%]	Duty cycle correction factor [dB]
2.125	2.500	0.850	85.00	0.71

Duty cycle (Linear) = Ton time/Period

DCF(Duty cycle correction factor (dB)) = 10log(1/duty cycle)

[2 440 MHz]

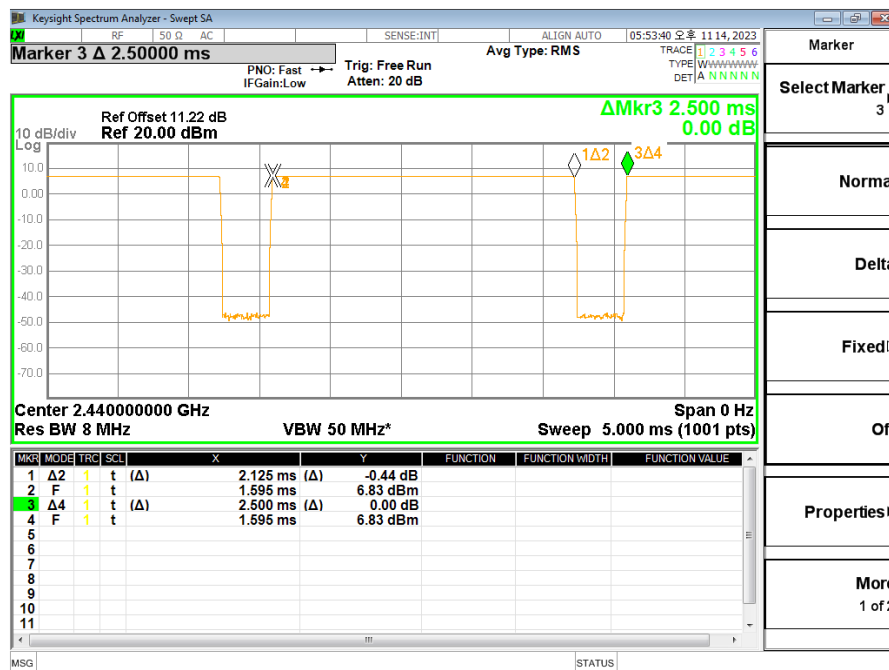

Radiated Emissions Test data

- 9 kHz to 30 MHz

The following table shows the highest levels of radiated emissions on both polarizations of horizontal and vertical.

Detector mode: CISPR Quasi-Peak mode

- Type of Modulation: LE 1 Mbps

Frequency [MHz]	Reading [dB(μV)]	Polarization (*H/**V)	Ant. Factor [dB/m]	Cable Loss [dB]	Result [dB(μV/m)]	Limit [dB(μV/m)]	Margin [dB]
	Emission attenuated more than 20 dB below the limit are not reported.						

Result: All emissions below noise floor of 20 dB(μV/m).

NOTES:

1. * H : Horizontal polarization , ** V : Vertical polarization
2. Result = Reading + Antenna factor + Cable loss
3. Margin = Limit - Result
4. The measurement was performed for the frequency range 9 kHz to 30 MHz according to FCC Part 15.209.

- Below 1 GHz (30 MHz to 1 GHz)

The following table shows the highest levels of radiated emissions on both polarizations of horizontal and vertical.
 Detector mode: CISPR Quasi-Peak mode

- Type of Modulation: LE 1Mbps_19 ch(Worst case)

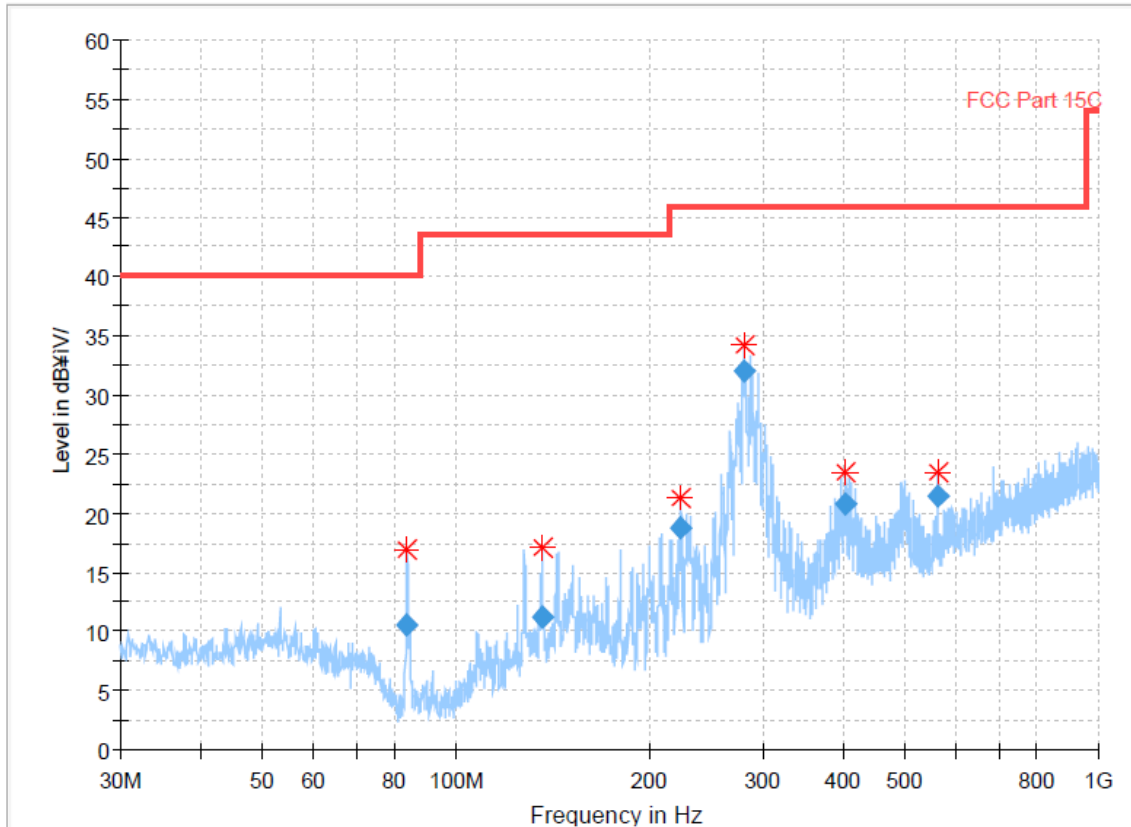

Final Result

Frequency (MHz)	QuasiPeak (dBµV/m)	Limit (dBµV/m)	Margin (dB)	Bandwidth (kHz)	Height (cm)	Pol	Azimuth (deg)	Corr. (dB/m)
83.932000	10.49	40.00	29.51	120.000	400.0	H	88.0	-34.3
135.924000	11.20	43.50	32.30	120.000	200.0	H	88.0	-29.3
223.709000	18.74	46.00	27.26	120.000	100.0	H	157.0	-31.9
280.551000	32.04	46.00	13.96	120.000	100.0	H	180.0	-28.4
404.711000	20.72	46.00	25.28	120.000	100.0	H	304.0	-25.6
562.530000	21.40	46.00	24.60	120.000	400.0	H	20.0	-22.4

NOTES:

1. * H : Horizontal polarization , ** V : Vertical polarization
2. Corr. = Reading + Antenna factor + Cable loss – Amp. Gain
3. Margin value = Limit - Result
4. The measurement was performed for the frequency range above 30 MHz according to FCC Part 15.209.

- Above 1 GHz

- Type of Modulation: LE 1 Mbps

1. Low CH

Frequency [MHz]	Reading [dB(μV)]	Detect Mode	Polarity (H*/V**)	DCF [dB]	CF [dB]	Field strength [dB(μV/m)]	Limit [dB(μV/m)]	Margin [dB]
2 389.90	65.23	Peak	V	-	-9.41	55.82	74.00	18.20
4 803.51	72.87	Peak	V	-	-6.07	66.80	74.00	7.20
7 206.65	51.39	Peak	V	-	-2.73	48.66	74.00	25.34
2 389.92	56.11	Peak	H	-	-9.41	46.69	74.00	27.31
4 804.21	61.09	Peak	H	-	-6.07	55.02	74.00	18.98
7 205.14	50.32	Peak	H	-	-2.73	47.59	74.00	26.41

2. Middle CH

Frequency [MHz]	Reading [dB(μV)]	Detect Mode	Polarity (H*/V**)	DCF [dB]	CF [dB]	Field strength [dB(μV/m)]	Limit [dB(μV/m)]	Margin [dB]
4 879.49	78.67	Peak	V	-	-6.02	72.65	74.00	1.35
7 319.53	54.39	Peak	V	-	-2.59	51.80	74.00	22.20
4 879.55	71.93	Peak	H	-	-6.02	65.90	74.00	8.10
7 320.64	48.63	Peak	H	-	-2.59	46.04	74.00	28.00

3. High CH

Frequency [MHz]	Reading [dB(μV)]	Detect Mode	Polarity (H*/V**)	DCF [dB]	CF [dB]	Field strength [dB(μV/m)]	Limit [dB(μV/m)]	Margin [dB]
2 483.55	73.40	Peak	V	-	-9.21	64.20	74.00	9.80
4 959.50	76.07	Peak	V	-	-5.98	70.09	74.00	3.91
7 439.30	50.04	Peak	V	-	-2.44	47.60	74.00	26.40
2 483.56	75.49	Peak	H	-	-9.21	66.28	74.00	7.70
4 959.48	69.53	Peak	H	-	-5.98	63.56	74.00	10.40
7 439.24	51.26	Peak	H	-	-2.44	48.82	74.00	25.20

NOTES:

1. * H : Horizontal polarization , ** V : Vertical polarization
2. CF = Cable loss + Antenna factor - Amp. Gain
3. Margin value = Limit - Result

Plots of Spurious Emissions (Conducted Measurement) (LE 1 Mbps)

[CH Low]

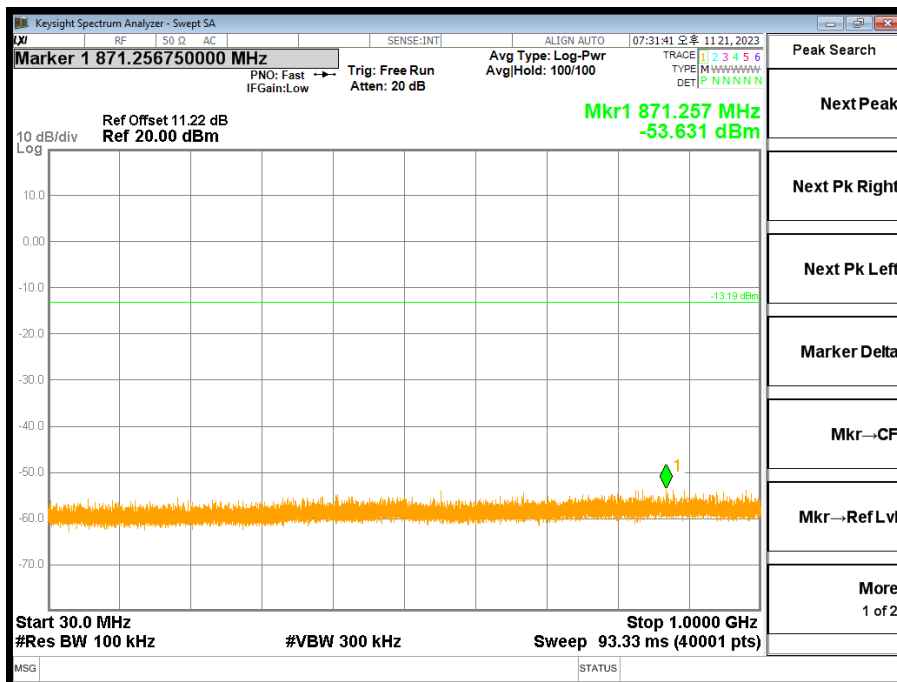
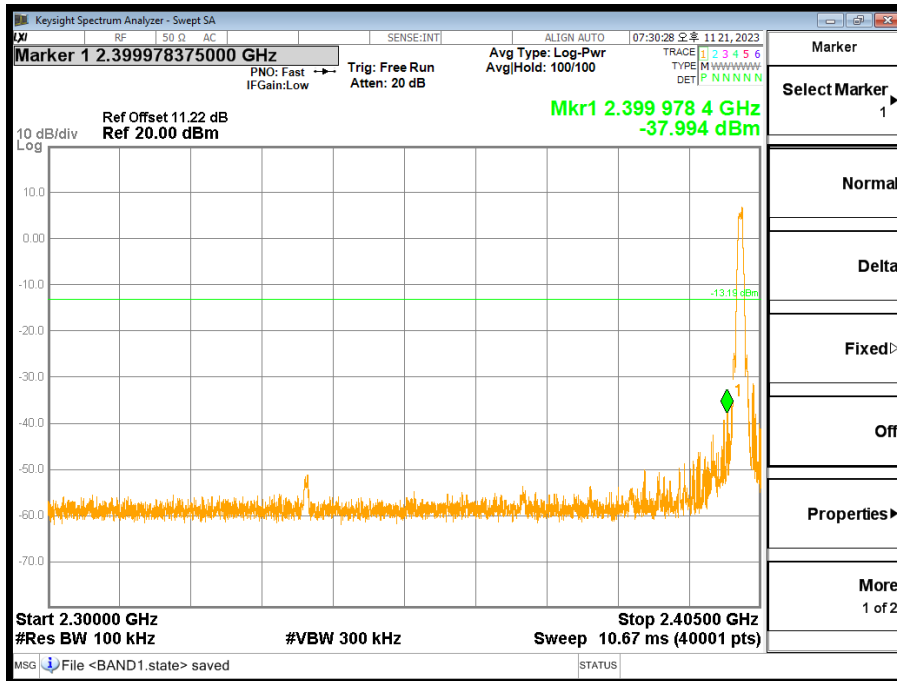

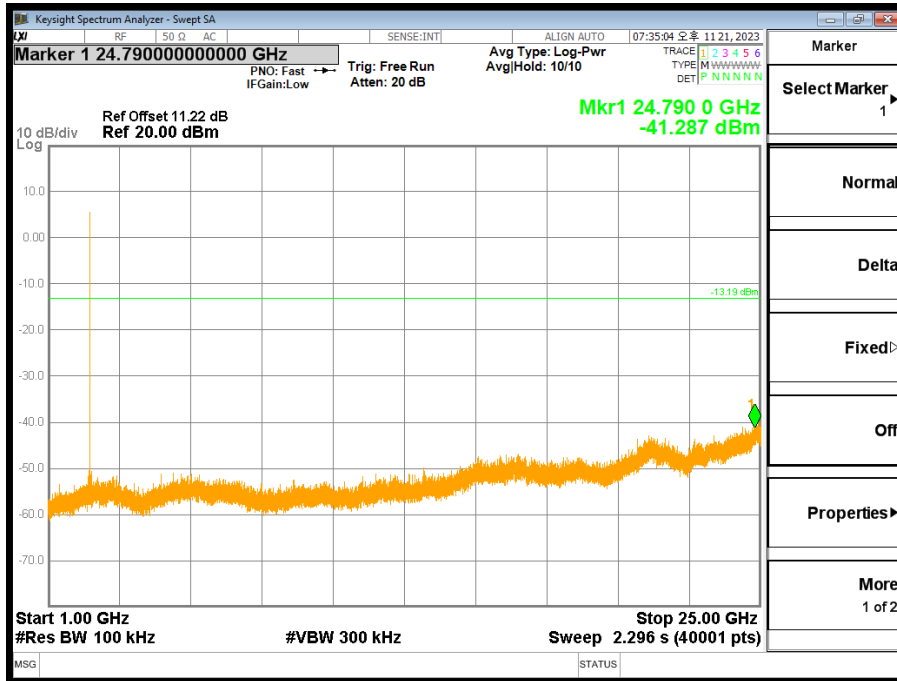

[CH Mid]

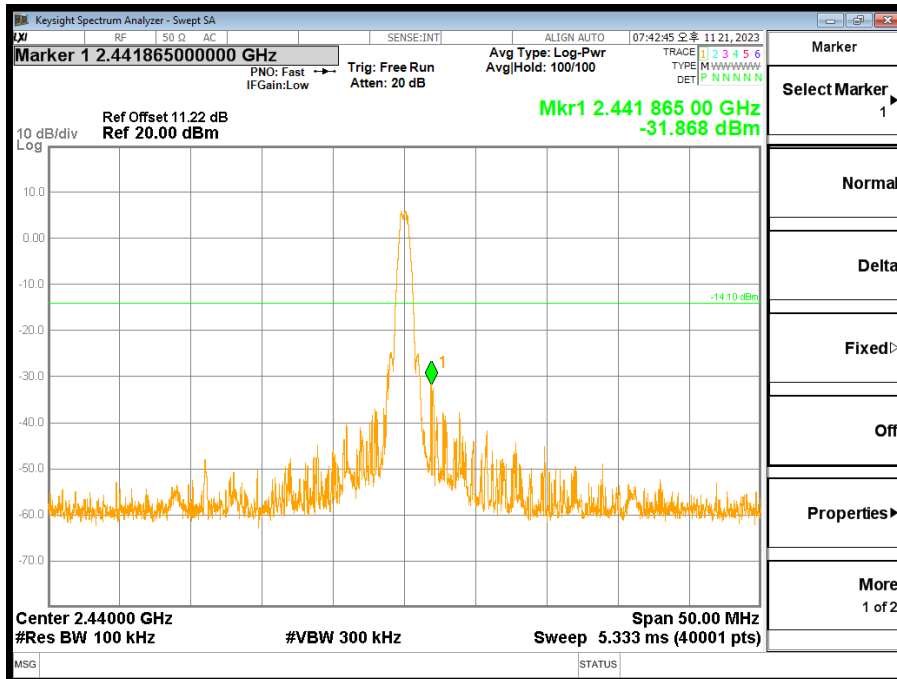

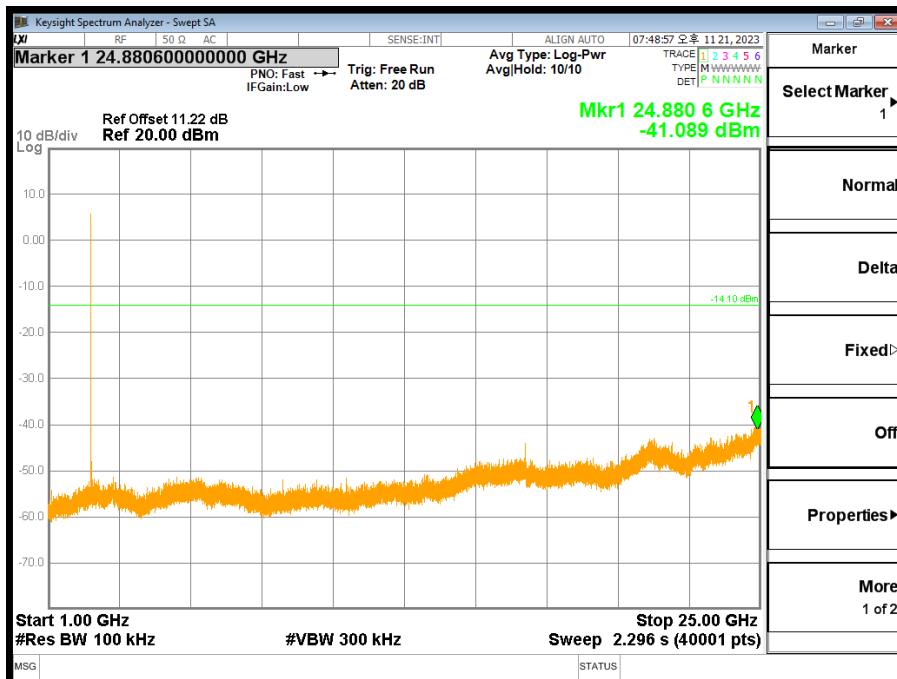
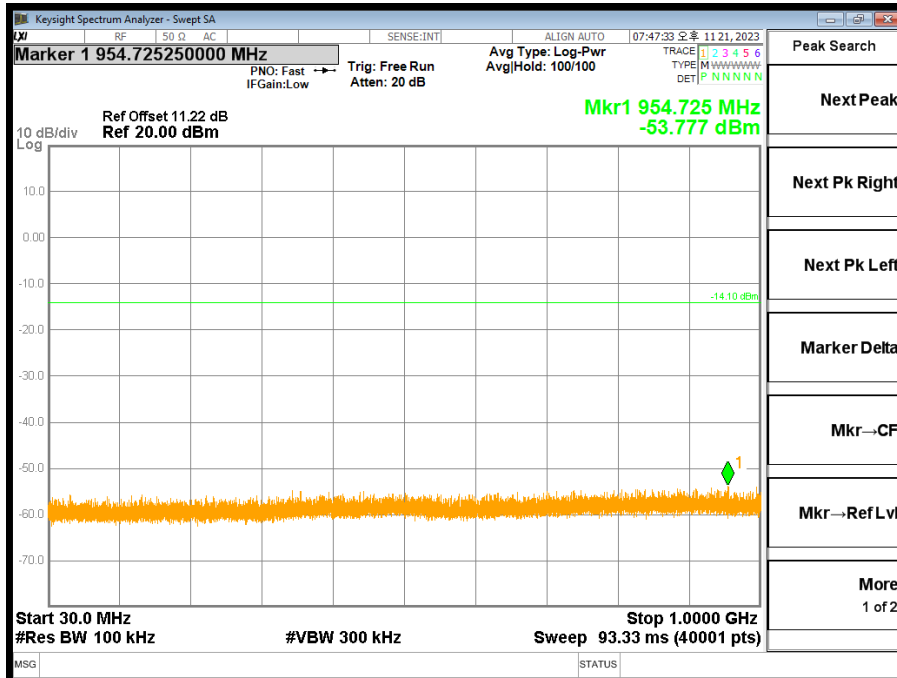

[CH High]

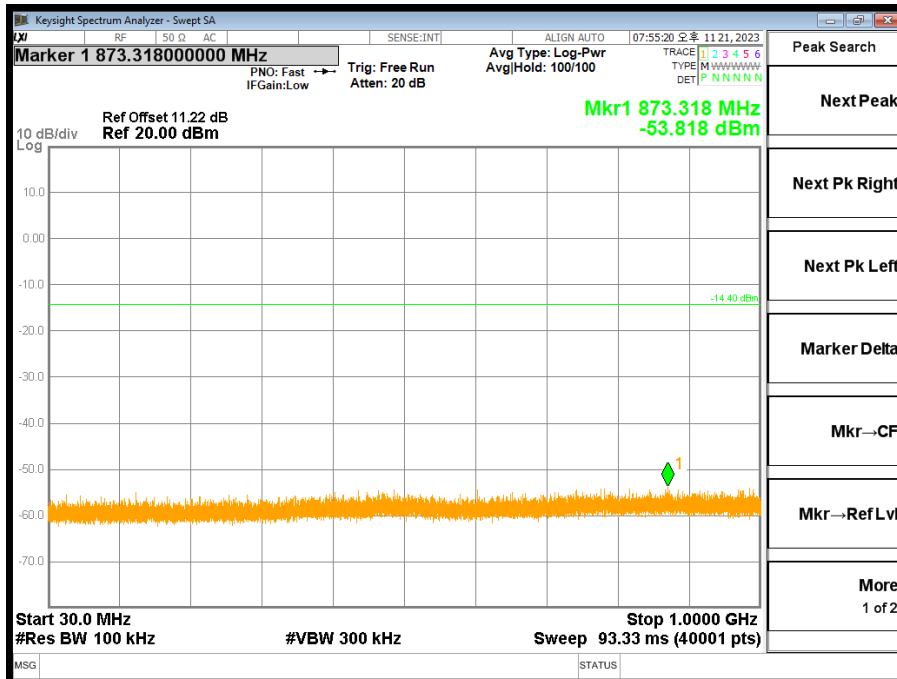
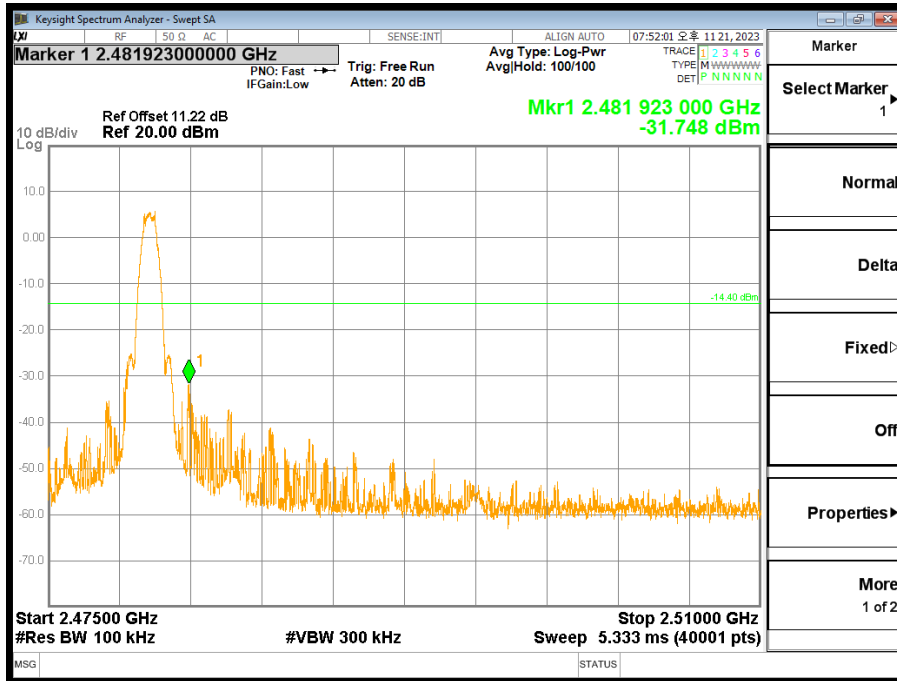

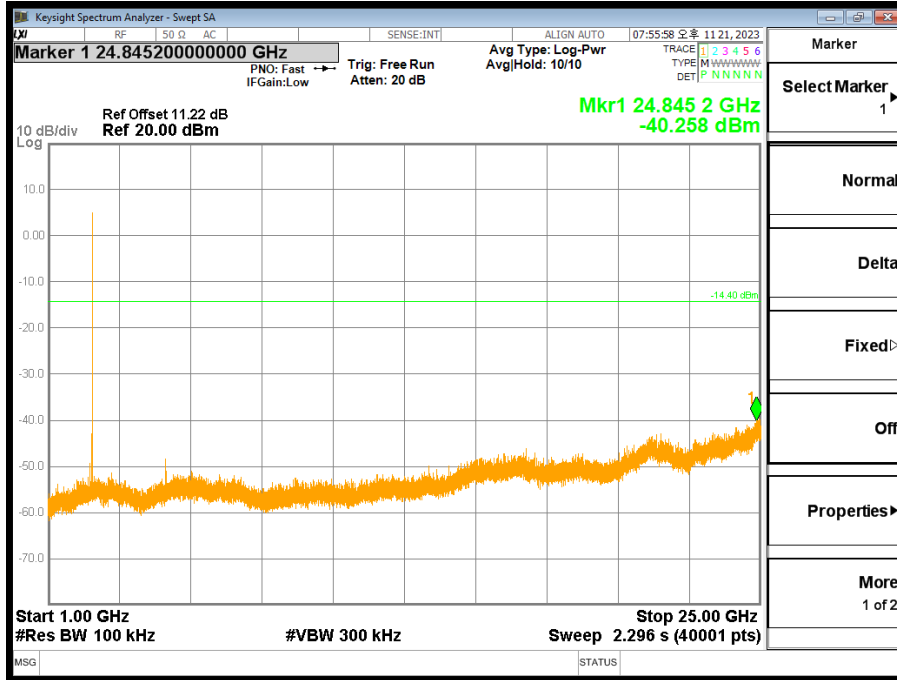

7.6 AC Conducted emissions

Limit

For an intentional radiator that is designed to be connected to the public utility (AC) power line, the radio frequency voltage that is conducted back onto the AC power line on any frequency or frequencies within the band 150 kHz to 30 MHz shall not exceed the limits in the following table, as measured using a 50 μ H/50 ohms line impedance stabilization network (LISN). Compliance with the provisions of this paragraph shall be based on the measurement of the radio frequency voltage between each power line and ground at the power terminal. The lower limit applies at the boundary between the frequencies ranges.

Frequency of Emission [MHz]	Conducted limit [dB(μ V)]	
	Quasi-peak	Average
0.15 - 0.5	66 to 56 *	56 to 46 *
0.5 - 5	56	46
5 - 30	60	50

* Decreases with the logarithm of the frequency.

Test Setup

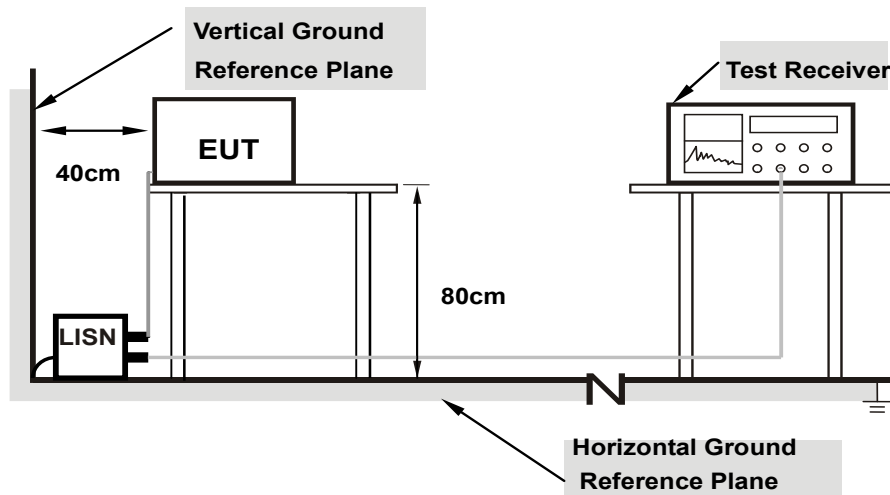

Test Results : N/A