

Antenna specification

►Company Name

Shenzhen Uwatch Technology Co., Ltd.

►Company address

A626, Gaoxinqi Technology Park, No. 2, Liuxian 1st Road,
Xingdong Community, Xin'an Street, Bao'an District, Shenzhen City

APPLications

※Bluetooth Home RF

※ISM band 2.4GHz applications

1. Dimensions

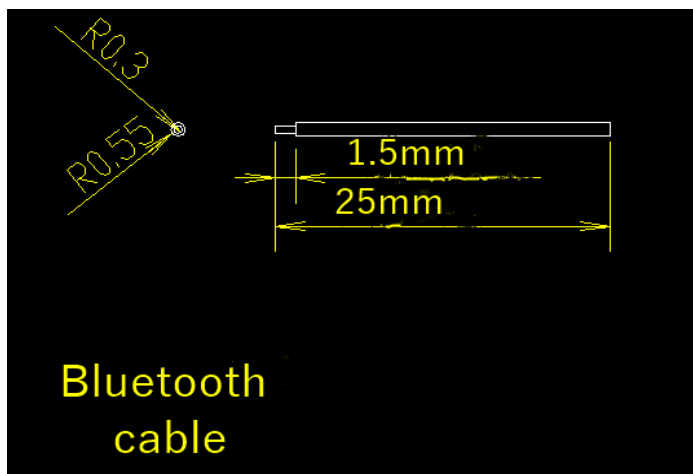

2. Specifications

number	Item	Specifications
1	Working Central Frequency	2441 MHz
2	Band Width	(2402-2480)MHz
3	Gain	0dBi
4	VSWR	≤2.0
5	Antenna type	PCB antenna
6	Azimuth Beam width	Omni - directional
7	Impedance	50ohm
8	Modulation mode	GFSK

3. simulation parameter

① VSWR

Mkr1: 2397MHz 1.47 Mkr2: 2450MHz 1.51 Mkr3: 2482 MHz 1.59

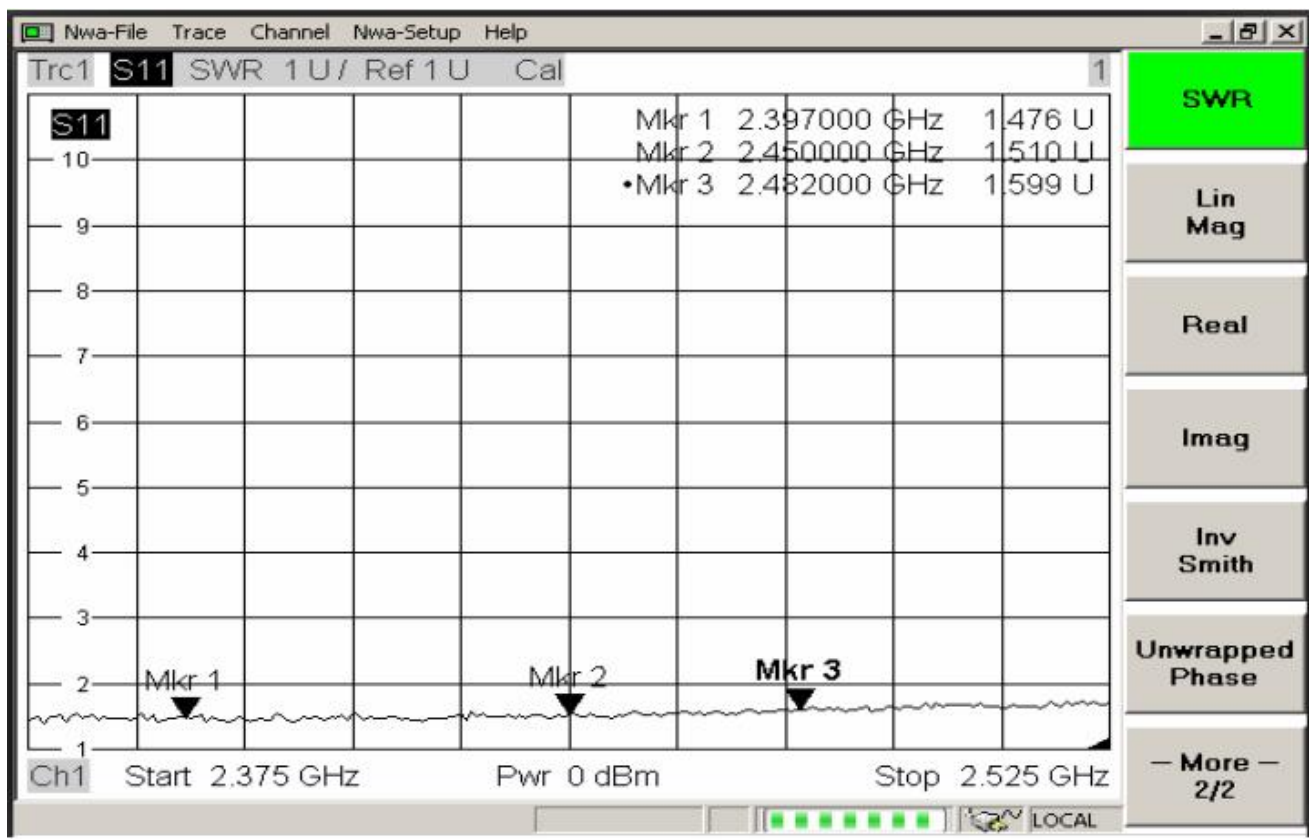

②Smith Char

Mkr1: 2397MHz 73.4 Mkr2: 2450MHz 62.7 Mkr3: 2482MHz 66.8

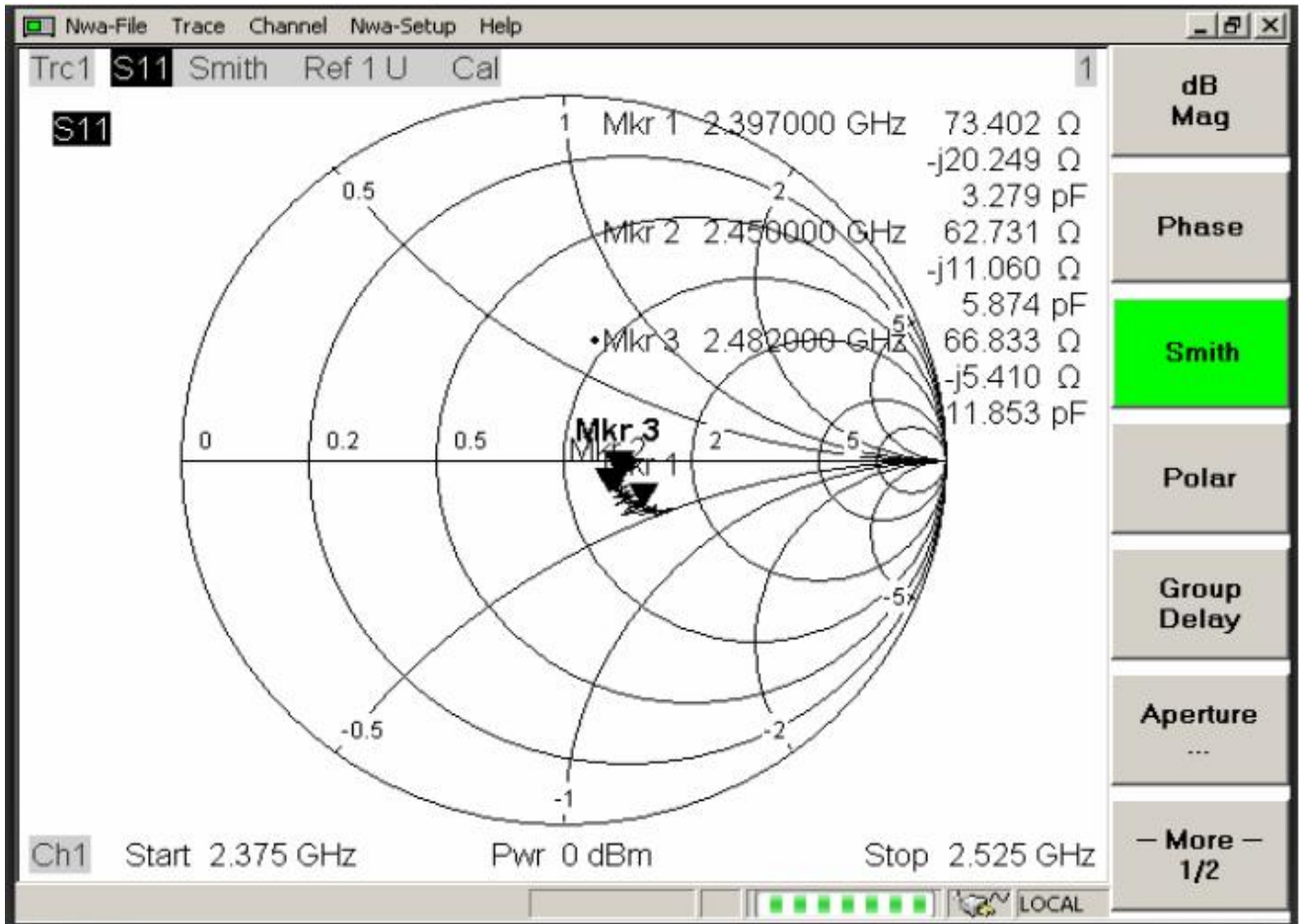

③Return Loss

Mkr1: 2397MHz -15 Mkr2: 2450MHz -18 Mkr3: 2482 MHz -16

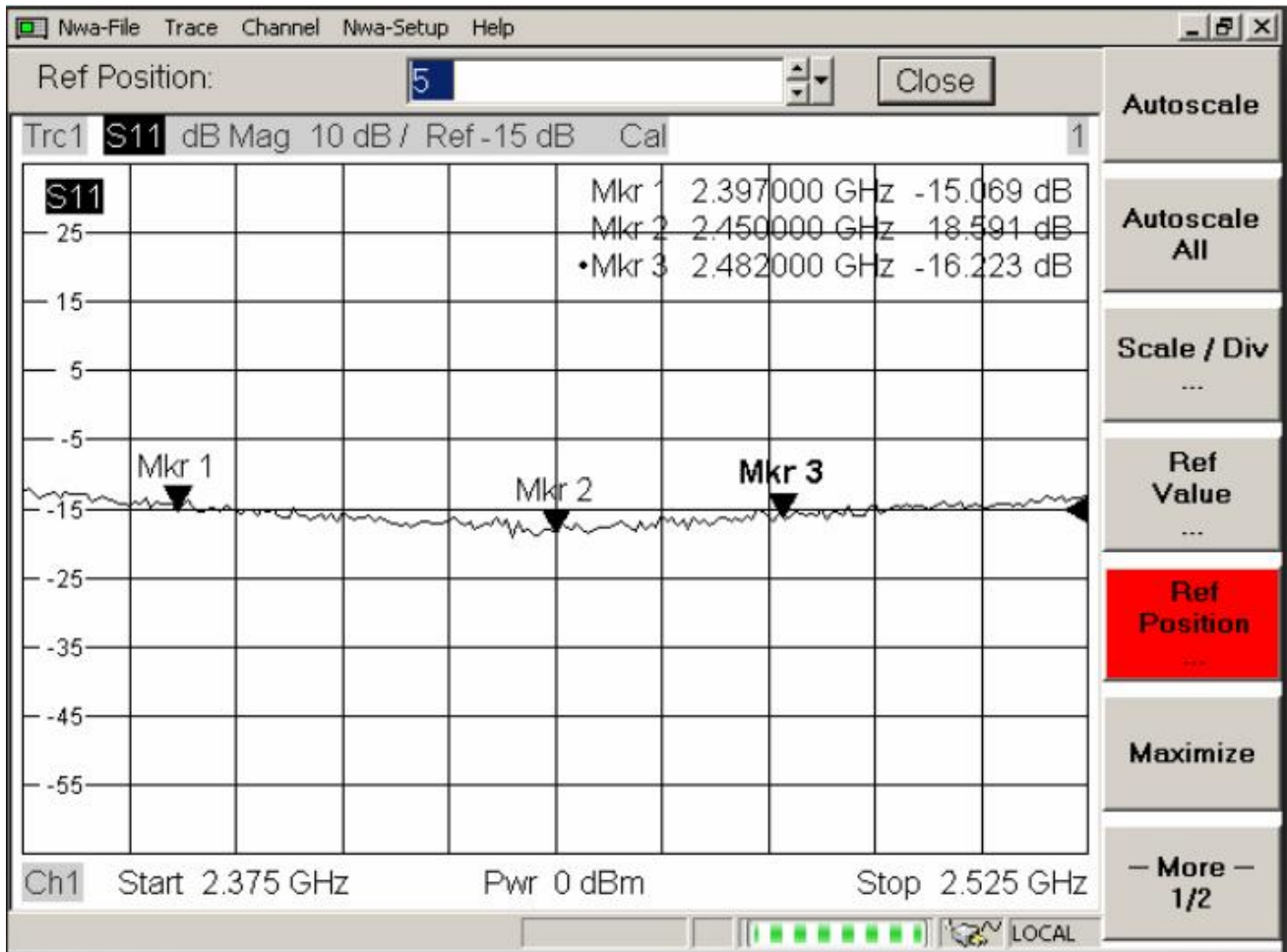

④Smith Char

Mkr1: 2400MHz 1.234 Mkr2: 2500MHz 1.051Mkr3: 2600MHz 1.322

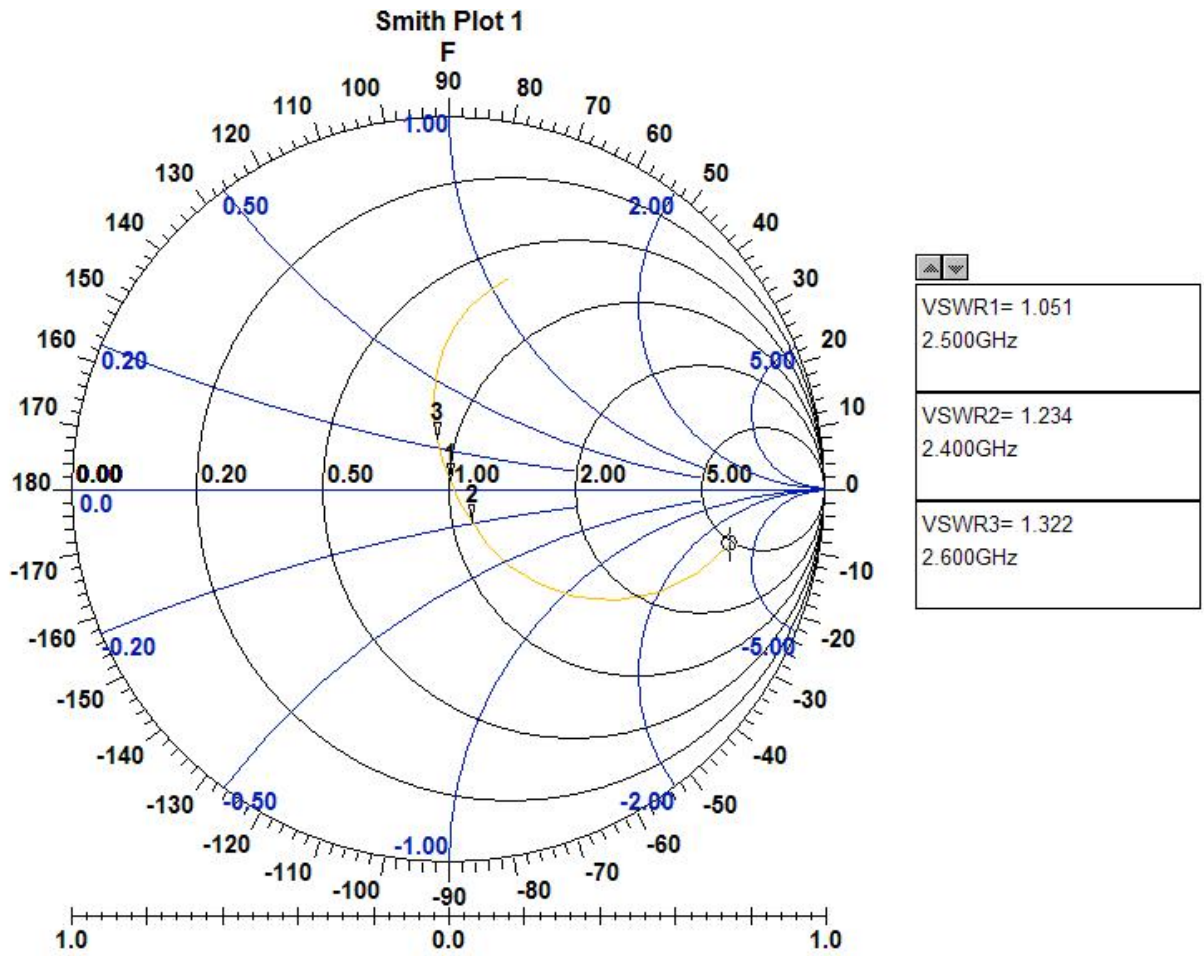

⑤Return Loss

Mkr1: 2400MHz -19.59 Mkr2: 2450MHz -27.70Mkr3: 2500MHz -31.97 Mkr4:
2550MHz -21.83

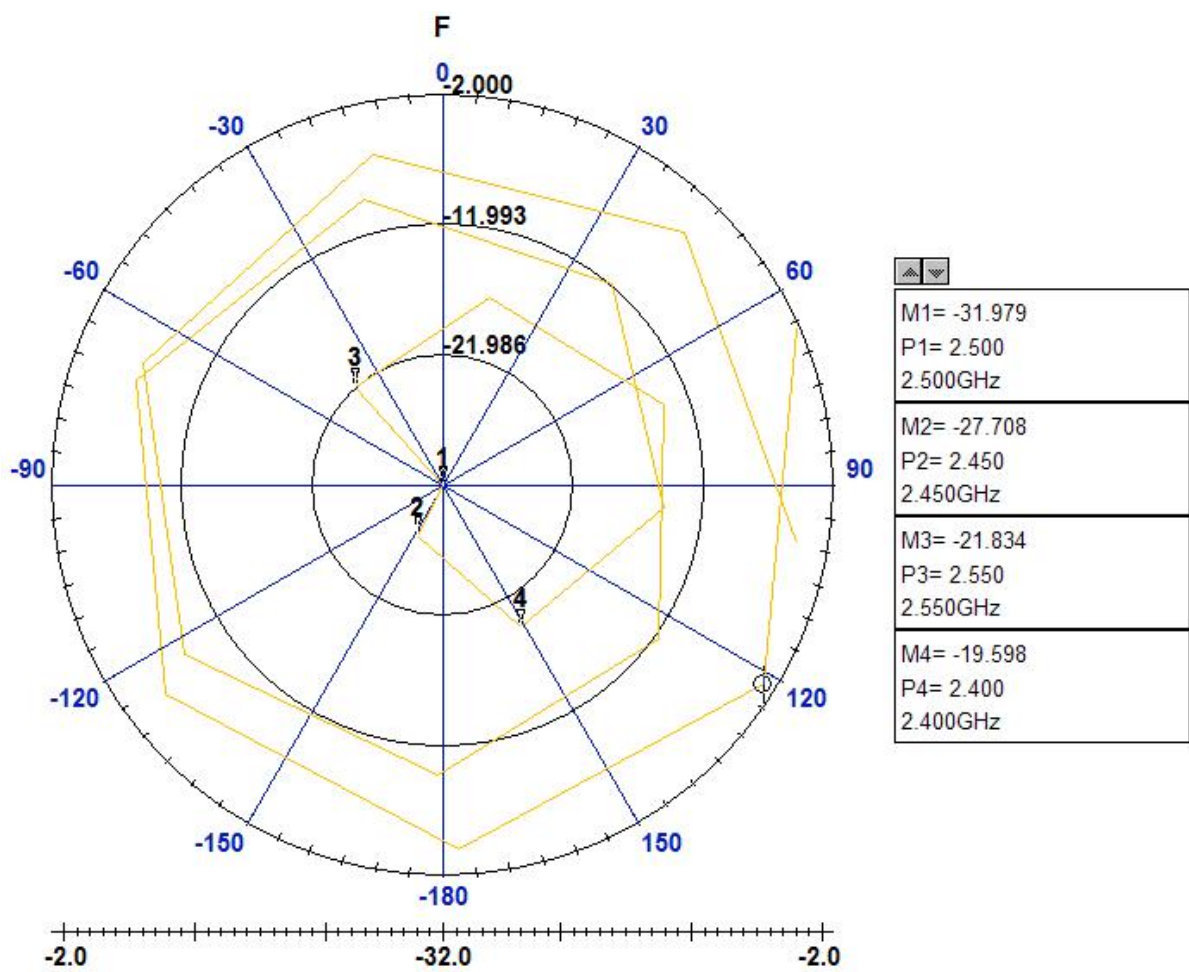

⑥Phase

Mkr1: 2400MHz -54.89 Mkr2: 2500MHz -82.03 Mkr3: 2600MHz -102.6

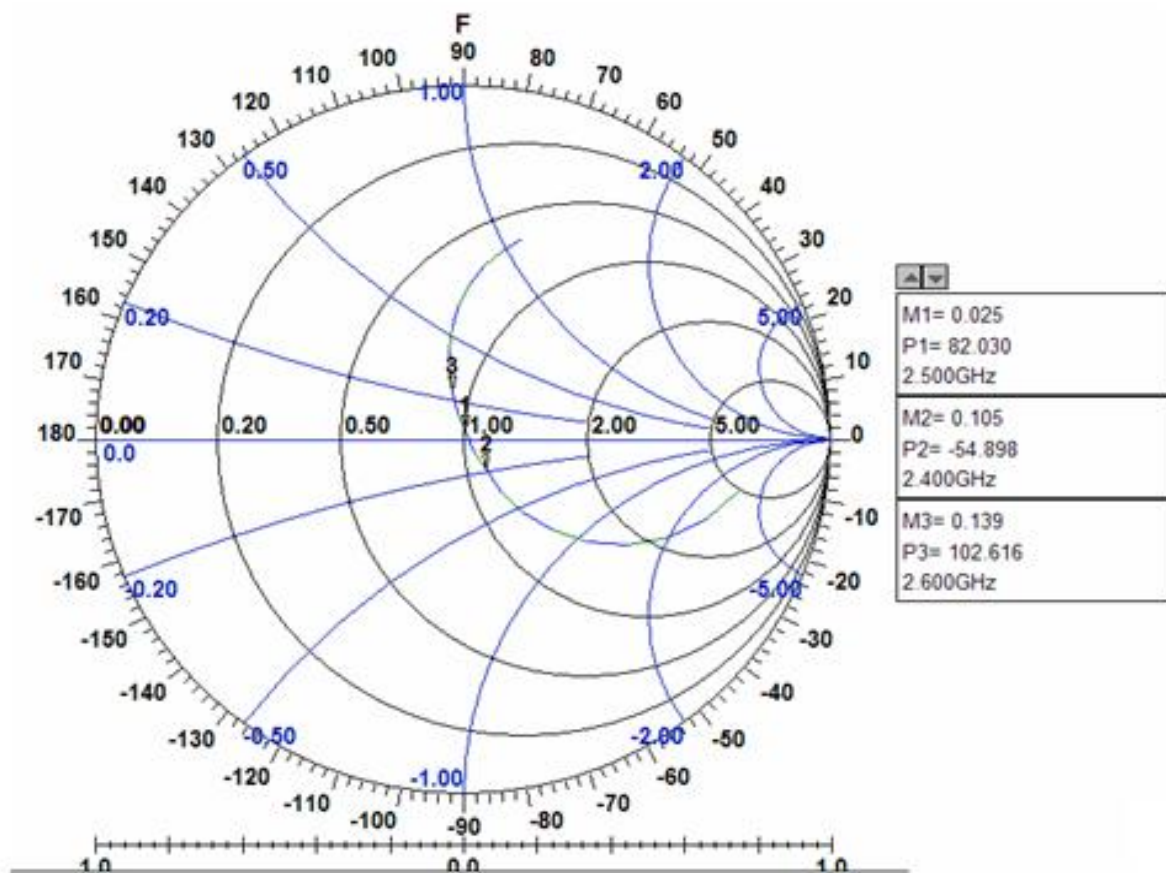

4. Radiation Patterns

XY-plane ————
XZ-plane ————
YZ-plane ————

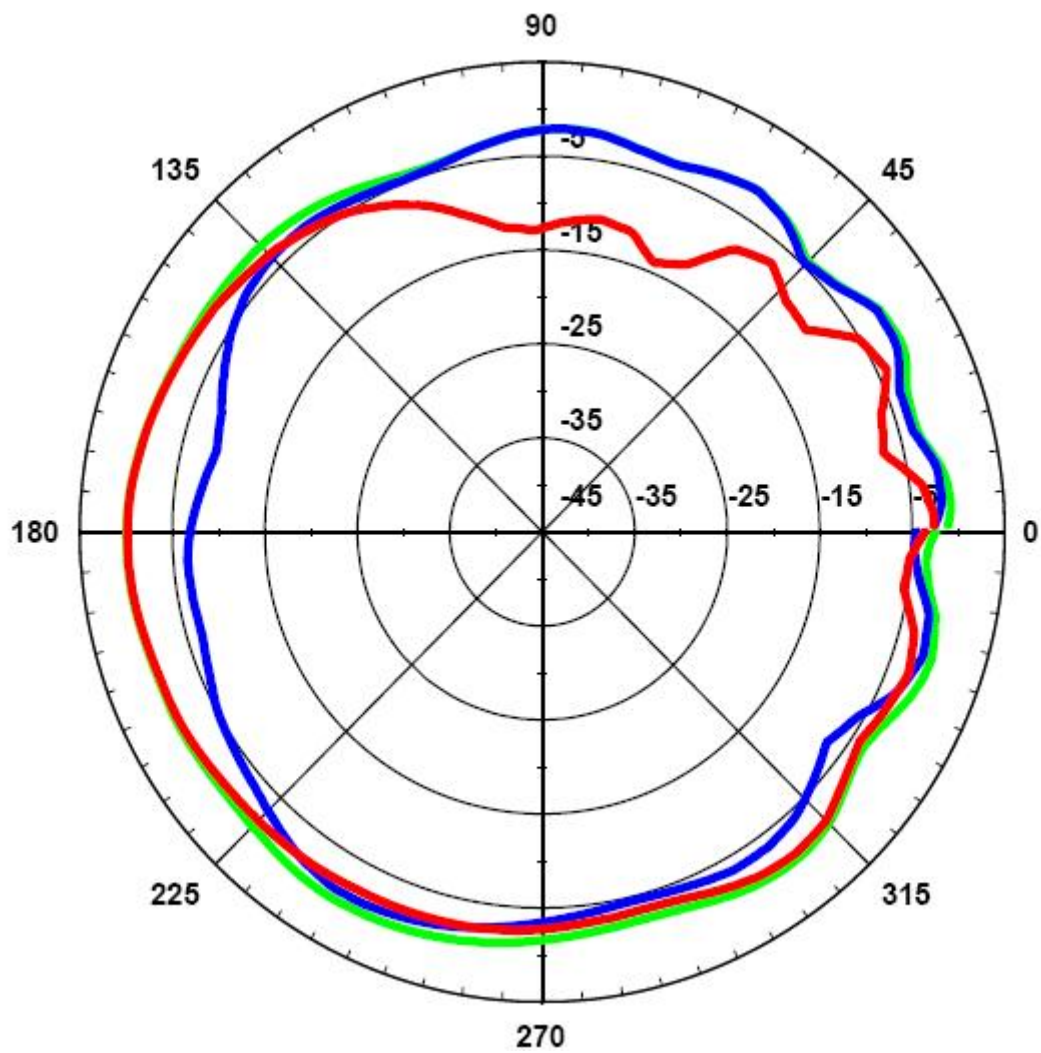

- 3DRadiation pattern

