

承认书

SPECIFICATION APPROVAL SHEET

客 户 :

CUSTOMER

客 户 料 号 :

CUS PART NO

版次:

REV

X4

品 名 / 规 格 :

SPECIFICATION

2.4~2.5/5.15~5.85GHz

WIFI MAIN Antenna L=305mm(Ø1.13+MHF)

单重:

weight

供 方 料 号 :

SUP PART NO

SLEingB244160305

日 期 :

DATE

2024.03.02

厂 商 核 准 :

SUP APPROVED

核准 APPROVED	结构审核 Structure audit	RF审核 RF CHECKED	品保审核 QA CHECKED	承办 DESIGNED
<i>Jiangpu</i>	HZU	JDM	LSY	<i>Jiangpu</i>

客 户 核 准 :

CUS APPROVED



核准 APPROVED	审核 CHECKED	品保审核 QA CHECKED	承办 DESIGNED

东莞市森岭智能科技有限公司

DONGGUAN CITY SLEing INTEL-TECH CO., LTD

中国广东省东莞市松山湖工业东路24号现代企业加速器6栋402

Room 402, No. 6 Plant, Accelerator of Modern Enterprise, No. 24 Industry
East Road Songshanlake District, Dongguan City, Guangdong

Tel: +86-076989208968

Fax: +86-0769-89208969

www.sleing.com

正本由承办单位保存



承认书项目表 (Spec Item)

序号 (NO.)	项目 (Project)	备注 (Remark)	页码 (Page)
1	承认书封面 (Spec Cover)		1
2	变更记录 (MODIFICATION RECORD SHEET)		2
3	承认书项目表 (Spec Item)		3
4	工程成品图 (Drawing)		4
5	电性测试报告 (Test Reports)		5
6	天线组装图 (Antenna assembly diagram)		6
7	S参数测试 (S Parameter Test)		7
8	测试设备 (Test Setup)		8
9	测试效率 (Test Efficiency)		9

Give clear indication of:

1. The contents of the acknowledgement shall be arranged in order according to the items in the check sheet.
2. The number of copies of the acceptance letter shall be printed according to the customer's requirements, and the SGS report shall be stamped with the engineering seal.
3. All materials shall be confirmed by the customer. Any material/process/changes that may affect product quality and environmental quality must be re-sent to the customer for confirmation before import.
4. SGS report is valid for one year.
5. According to the contents attached to the actual acknowledgement, check the check form: "Yes" is provided, "no" is provided according to customer requirements.

REV.	CONTENT	DATE
X1	First Sample	2023.12.13
X2	更改FPC	2024.01.16
X3	更改FPC	2024.02.22
X4	更改FPC	2024.03.02

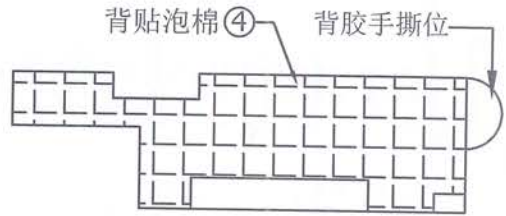
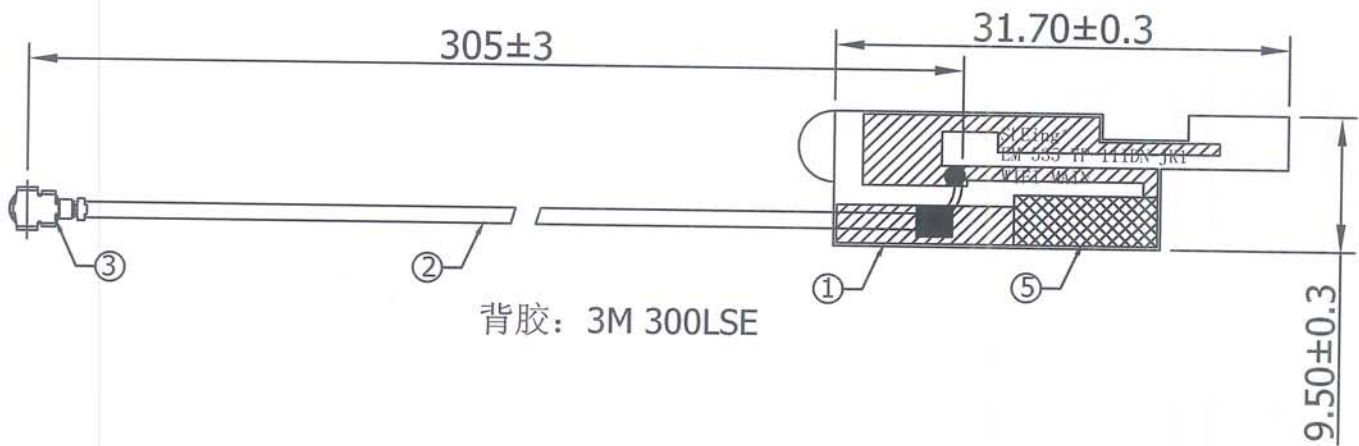

Specification:
 Frequency Rang: 2.4~2.5/5.15~7.10GHz(带机测试)
 Return Loss: -10dB or less
 VSWR: 1.92 Max

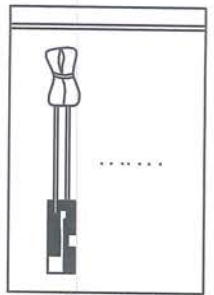

50pcs/Bundle
Packing: 100pcs/bag

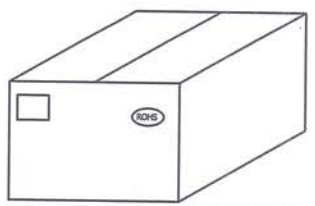

外箱须贴ROHS标签与物料标签各1PCS

NO	PART NAME	DESCRIPTION	REMARK	Q'TY
5	Foam	L10.0*W3.5*T2.0mm		1
4	Foam	L31.7*W9.5*T6.0mm		1
3	Connector	MHF Plug for $\Phi 1.13$ Cable	第四代端子	1
2	Cable	$\Phi 1.13$ mm Coaxial Cable White, 50 Ω		1
1	FPCB	FPC, L31.7*W9.5*T0.3mm, Color: Black	300LSE Adhesive	1

SLEing® 森岭
 东莞市森岭智能科技有限公司
 DONGGUAN SLEing INTEL-TECH CO., LTD

	TOLERANCE UNLESS OTHERWISE SPECIFIED		
	UNIT: mm	ANGLES $\pm 0.5^\circ$	X. ± 0.3
SHEET: 1/1	0.XX ± 0.05	XX. ± 0.5	
SCALE: 1/1		XXX. ± 2.0	

CUSTOMER		
PART NO		
TITLE		WIFI MAIN ANTENNA
S.L P/NO		SLEingB244160305
SIZE	DRAWN	CHECKED
	APPROVED	
A4		



东莞市森岭智能科技有限公司

DONGGUAN SLEing INTEL-TECH CO.,LTD



电性测试报告

Test Reports

Electrical Properties	
Frequency	2.4~2.5/5.15~7.10GHz(带机测试)
Impedance	50 Ohm Nominal
V.S.W.R	≤ 1.92
Return Loss	-10 dB Max
Radiation	Omni-directional
Gain (Peak)	2 \pm 0.5 dBi
Polarization	Linear, Vertical
Admitted Power	2 W
Connector	MHF
Physical Properties	
Antenna Material	FPCB
Cable Type	Φ 1.13mm White
Operating Temp.	-40~+85 °C
Storage Temp.	-5~+30 °C

天线组装图

Antenna Profile

<p style="text-align: center; font-size: 24px;"><i>Device</i></p>	<p>5、天线走线</p> <p>WiFi MAIN 天线走线如图红线所示，天线线长 305mm，直径 1.13mm，4 代端子，白色同轴线； WiFi AUX 天线走线如图蓝线所示，天线线长 510mm，直径 1.13mm，4 代端子，黑色同轴线</p> 
<p style="text-align: center; font-size: 24px;"><i>Antenna</i></p>	<p>2、WIFI MAIN 天线贴装：</p> <p>WIFI MAIN 天线粘贴方式如下图所示，注意天线粘贴过程中不能有偏移、起翘、鼓包和破损</p>  <p>1. 将天线靠近电池边角粘贴对齐</p> <p>2. 天线上方紧贴电池粘贴对齐</p> <p>3. 天线缺口居中对齐亮片卡扣</p>

S 参数测试 S Parameter Test

Agilent E5071C Network Analyzer



WiFi 回波损耗 Antenna (NO.1)

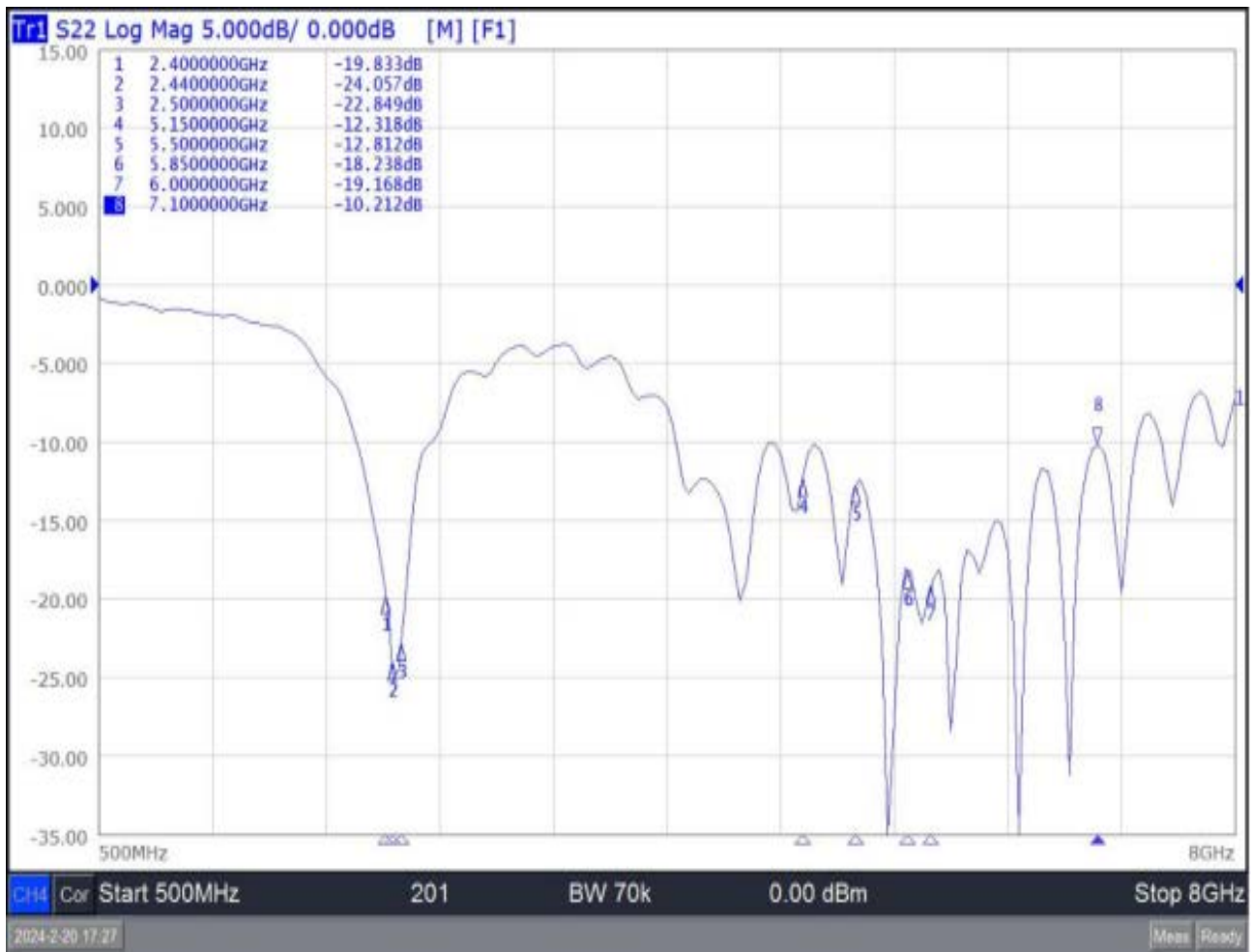

测试设备 Test Setup

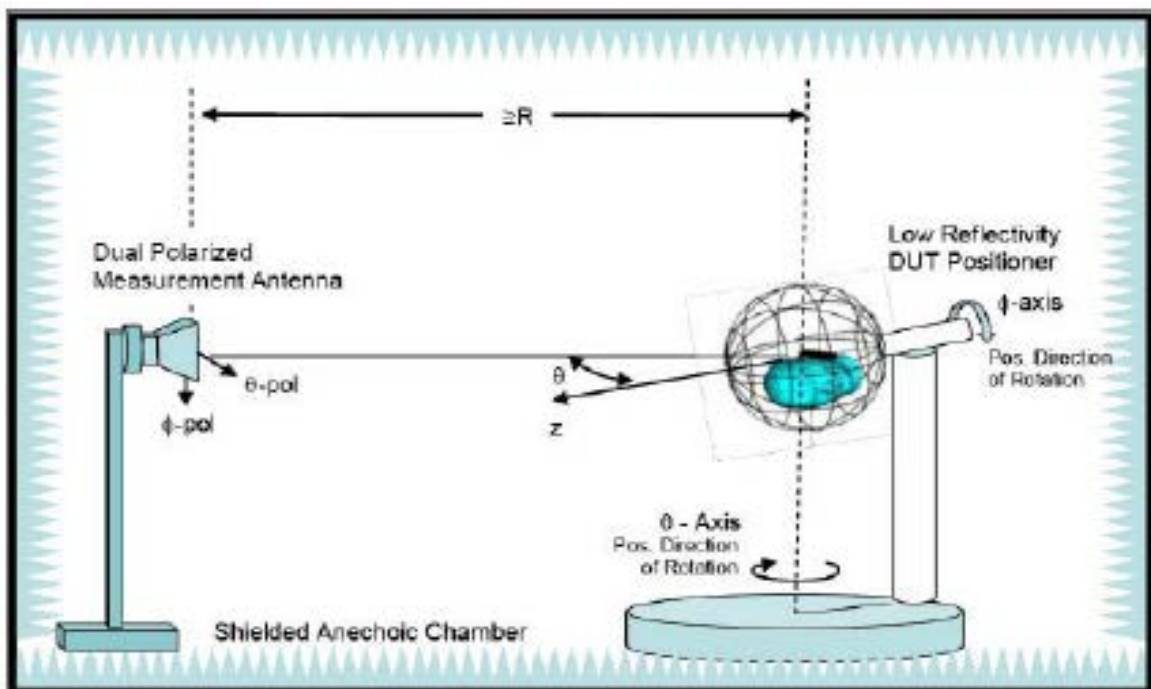
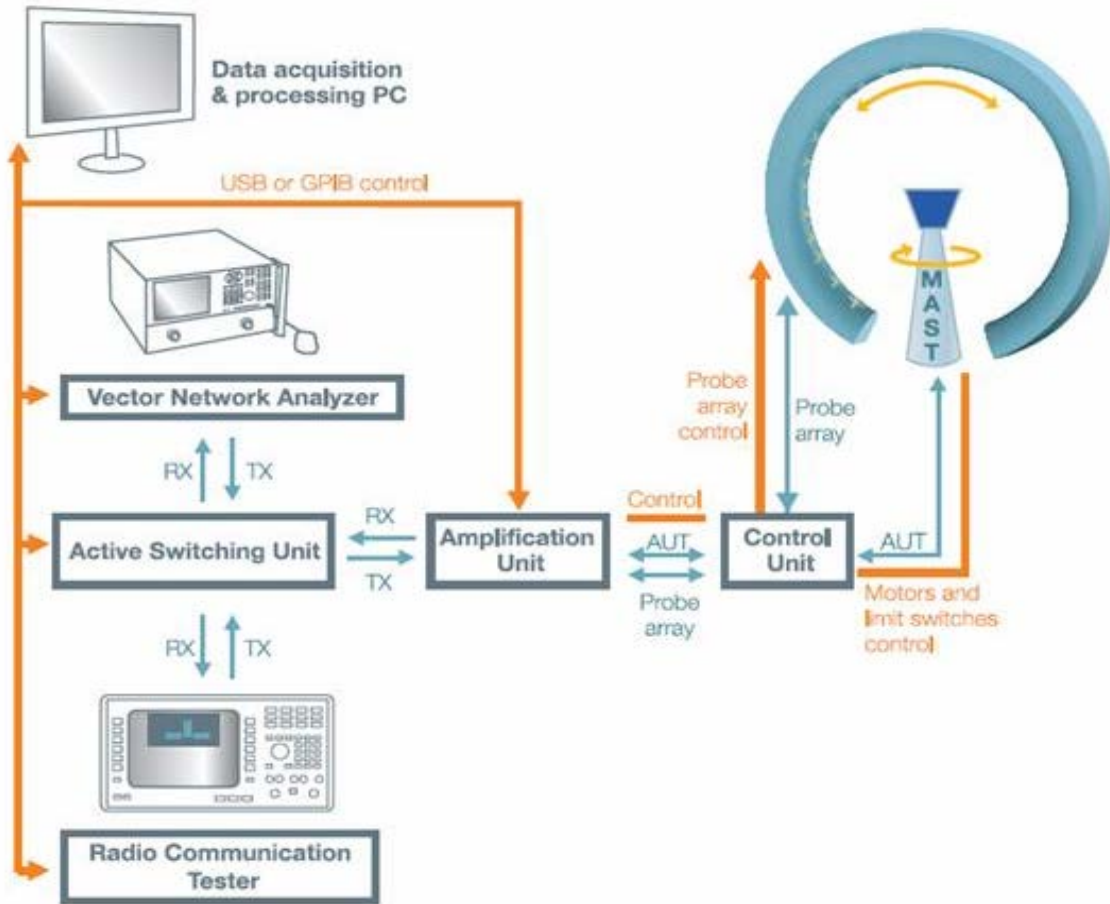

测试效率 Test Efficiency

EM-535-YP-11IDN-JK1 WiFi MAIN天线无源效率测试报告												
2.4G WiFi MAIN	Frequency ID	1	2	3	4	5	6	7	8	9	10	11
	Frequency (MHz)	2400.0	2410.0	2420.0	2430.0	2440.0	2450.0	2460.0	2470.0	2480.0	2490.0	2500.0
	Gain (dBi)	0.81	1.28	1.50	1.33	1.20	0.91	0.98	0.86	0.88	1.12	1.14
	Efficiency (%)	39.69	40.39	40.74	41.61	42.45	42.61	41.70	41.31	40.96	40.07	39.91
	<p>2450.0MHz H+V, Eff: 40.6%</p>											
5G WiFi MAIN	Frequency ID	1	2	3	4	5	6	7	8	9	10	11
	Frequency (MHz)	5150.0	5200.0	5250.0	5300.0	5350.0	5400.0	5450.0	5500.0	5550.0	5600.0	5650.0
	Gain (dBi)	0.98	1.32	1.20	0.92	0.87	1.49	0.85	1.20	0.97	1.02	1.36
	Efficiency (%)	42.68	43.96	44.43	42.72	43.54	42.85	44.01	43.65	42.79	44.11	42.49
	Frequency ID	12	13	14	15							
	Frequency (MHz)	5700.0	5750.0	5800.0	5850.0							
	Gain (dBi)	1.25	0.94	1.30	1.19							
	Efficiency (%)	41.81	41.39	41.38	41.55							
	<p>5600.0MHz H+V, Eff: 43.6%</p>											
	6G WiFi MAIN	Frequency ID	1	2	3	4	5	6	7	8	9	10
Frequency (MHz)		6000.0	6050.0	6100.0	6150.0	6200.0	6250.0	6300.0	6350.0	6400.0	6450.0	6500.0
Gain (dBi)		1.28	1.42	0.65	0.93	1.18	1.02	1.54	1.22	0.99	1.47	1.29
Efficiency (%)		43.97	43.47	44.61	42.66	44.42	45.41	44.59	45.73	42.33	44.98	42.67
Frequency ID		12	13	14	15	16	17	18	19	20	21	
Frequency (MHz)		6550.0	6600.0	6650.0	6700.0	6750	6800	6850	6900	6950	7000	
Gain (dBi)		1.27	1.33	1.19	1.08	0.92	0.97	1.09	1.39	1.28	1.43	
Efficiency (%)		43.90	42.80	44.92	44.96	45.34	44.06	44.01	43.98	44.61	44.03	
<p>6460.0MHz H+V, Eff: 48.0%</p>												