

Shenzhen jiashengjia Technology Co., Ltd

Antenna Test Report



日期：2023年11月24日



Report catalog:

- 1.Introduction to project debugging
- 2.Contact information for project leader
- 3.Test environment
- 4.Antenna matching circuit
- 5.Passive test data**
- 6.Antenna passive loss and standing wave**

1.Introduction to project debugging

Client name		Shenzhen Qimi Times Technology Co., Ltd.		Project name		ET07Aurora sunrise alarm clock	
Machine type		极光日出闹钟		Antenna material		Onboard antenna	
Antenna generalization	Main antenna	Antenna band		Antenna state	Antenna region	Antenna form	Whether the antenna configuration is changed
	Other antennas	Bluetooth antenna	2.4GHz-2.5GHz	sample			否

2.Contact information for project leader

Sales engineer	Wu Sheng	15013792335	1587676069@qq.com

3. Test environment

Integrated measuring instrument	CMW500
darkroom	Atenlab M3
Test engineer	刘俊
temperature	25°C

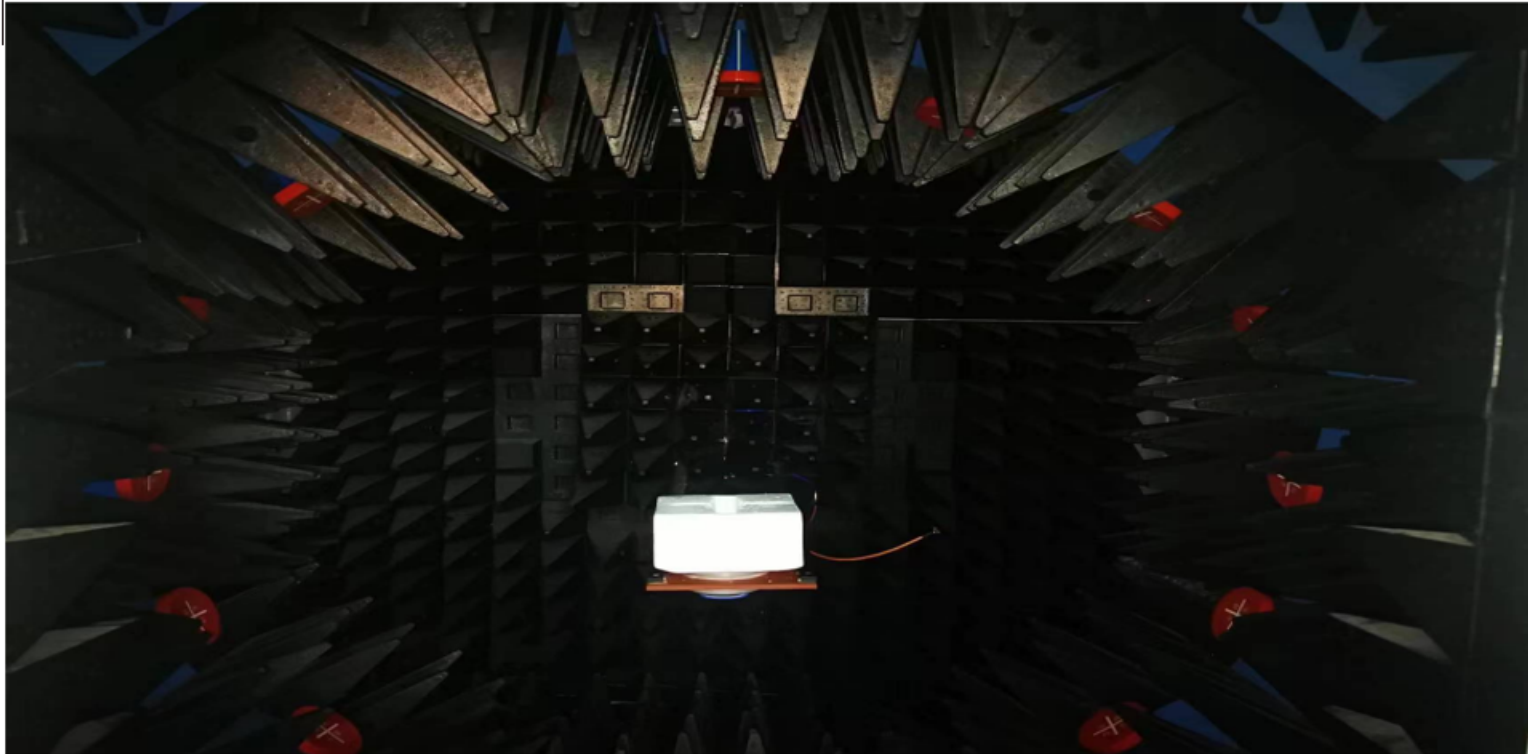

4. Antenna matching circuit

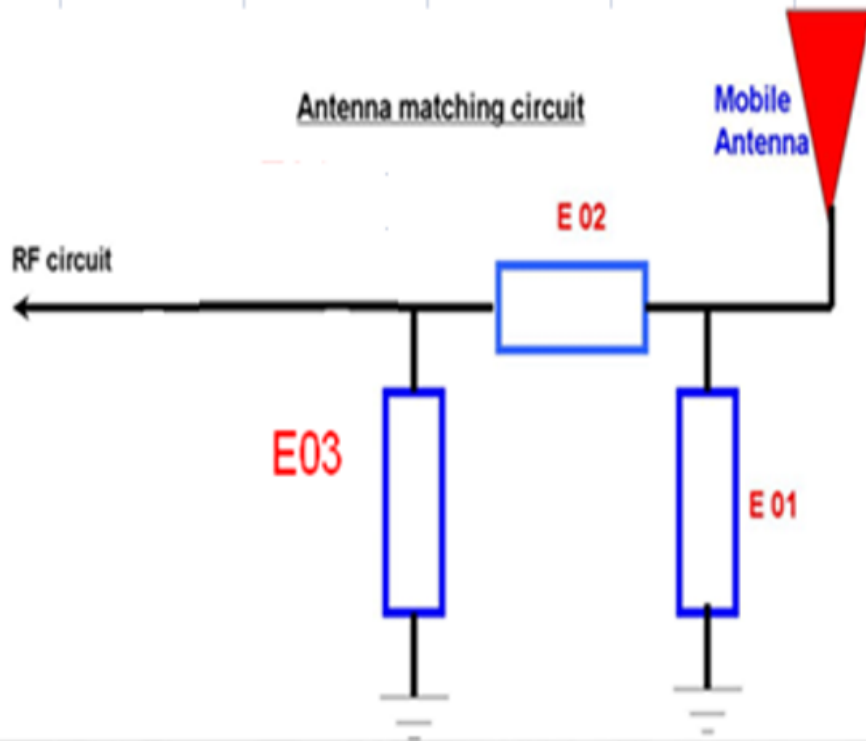

E01	
E02	
E03	

Antenna passive loss and standing wave

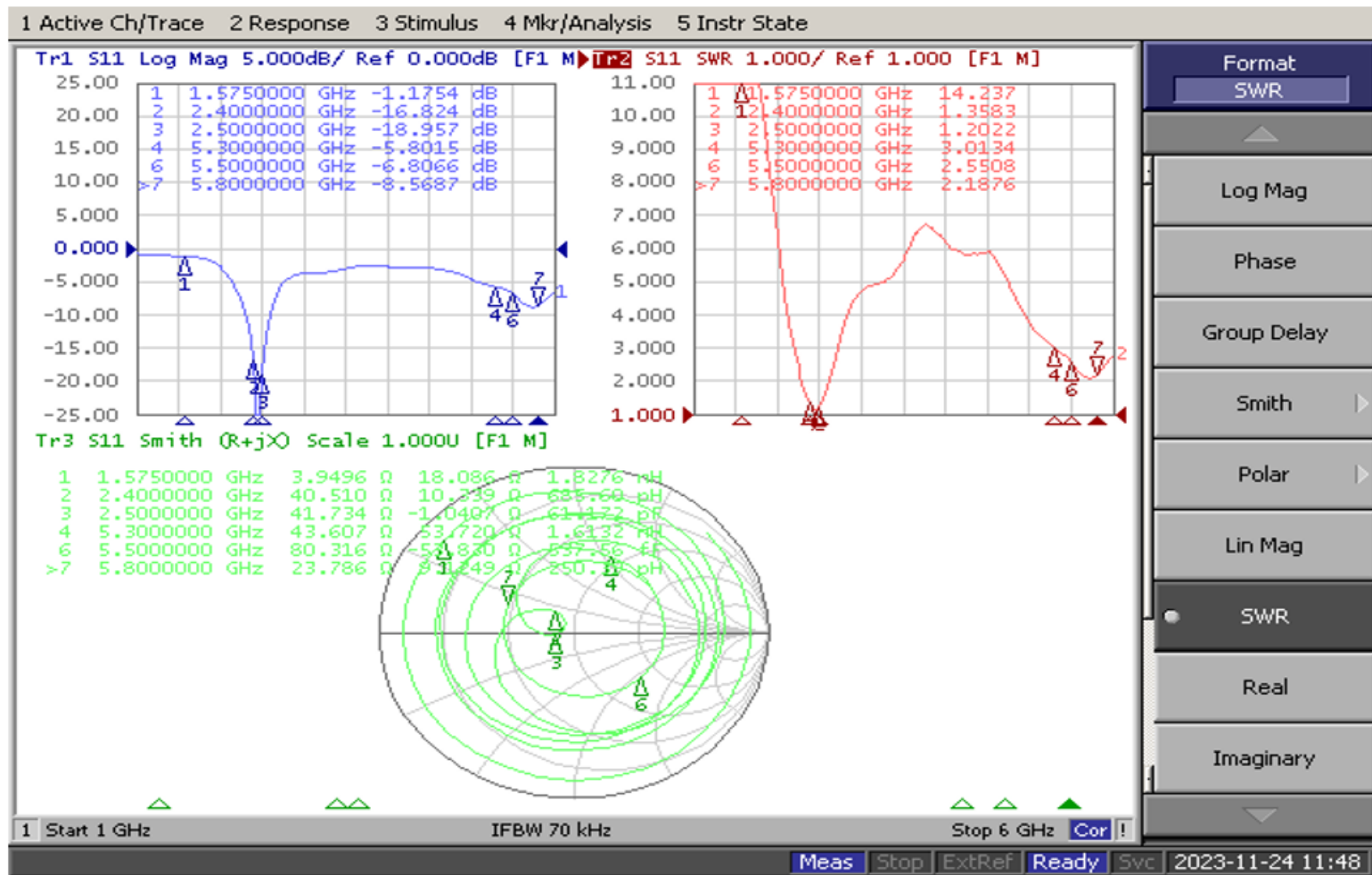

OTA Passive test data

Frequency (MHz)	Efficiency (dBi)	Efficiency (%)	Gain (dBi)
2400	-2.05	62.43	3.63
2410	-1.55	70.21	4.14
2420	-1.17	76.32	4.59
2430	-0.84	82.34	4.94
2440	-0.64	86.39	5.12
2450	-1.18	76.17	4.67
2460	-1.24	75.19	4.75
2470	-1.54	70.12	4.52
2480	-1.59	69.39	4.53
2490	-1.84	65.46	4.3
2500	-1.85	65.31	4.23

Antenna pattern

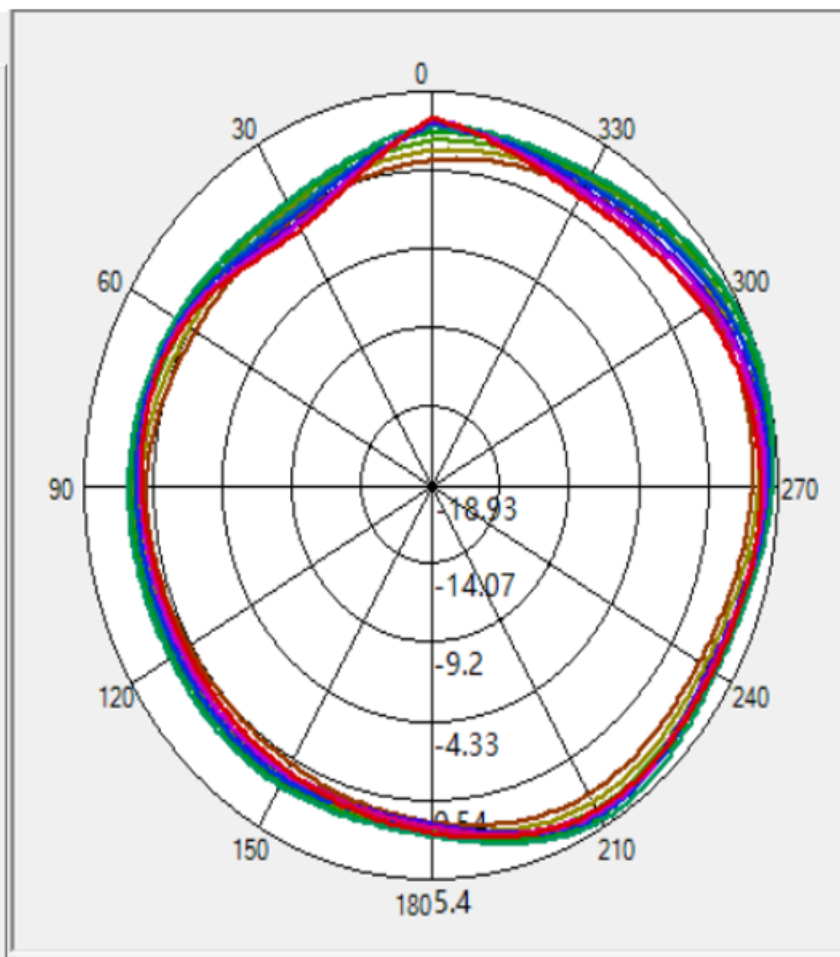
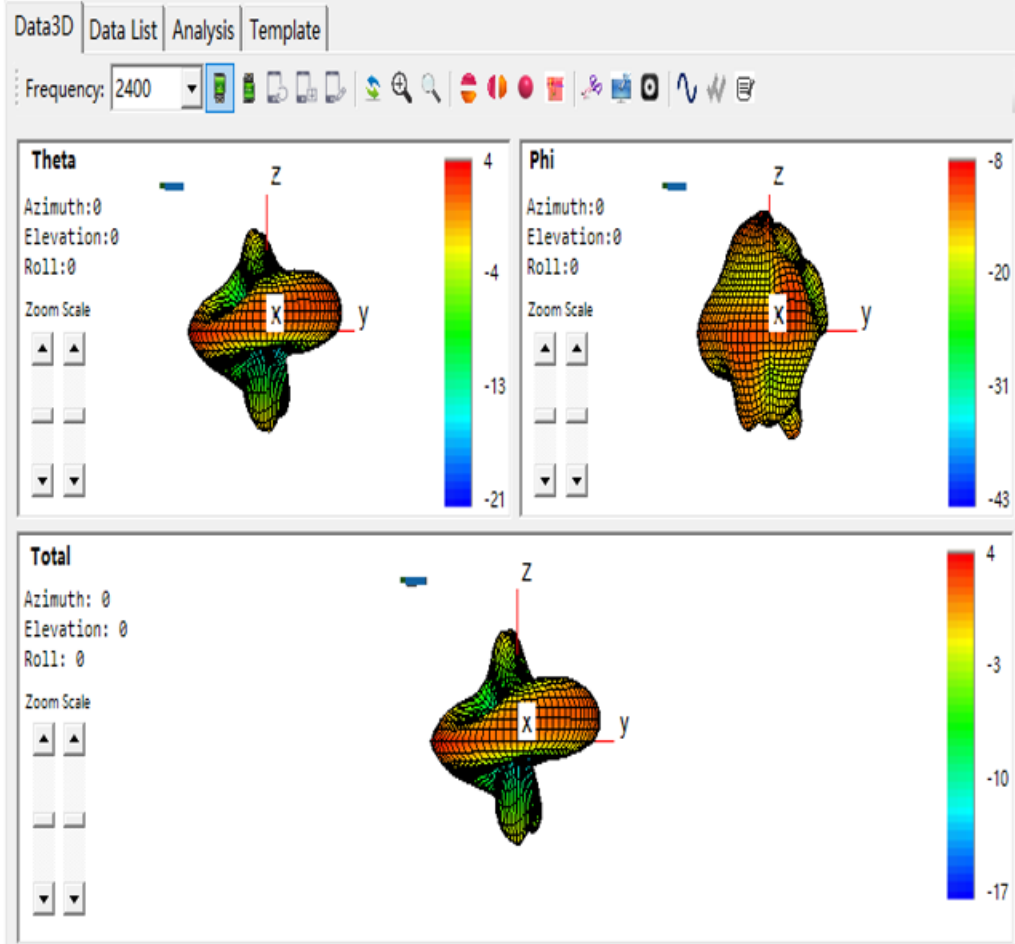

Antenna pattern

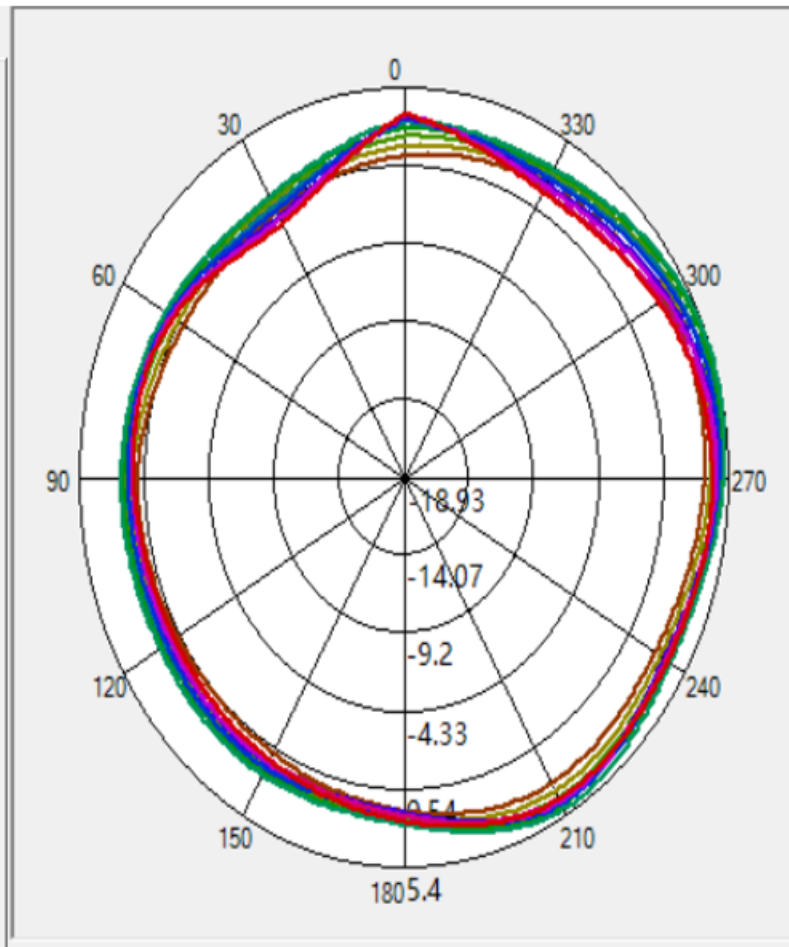
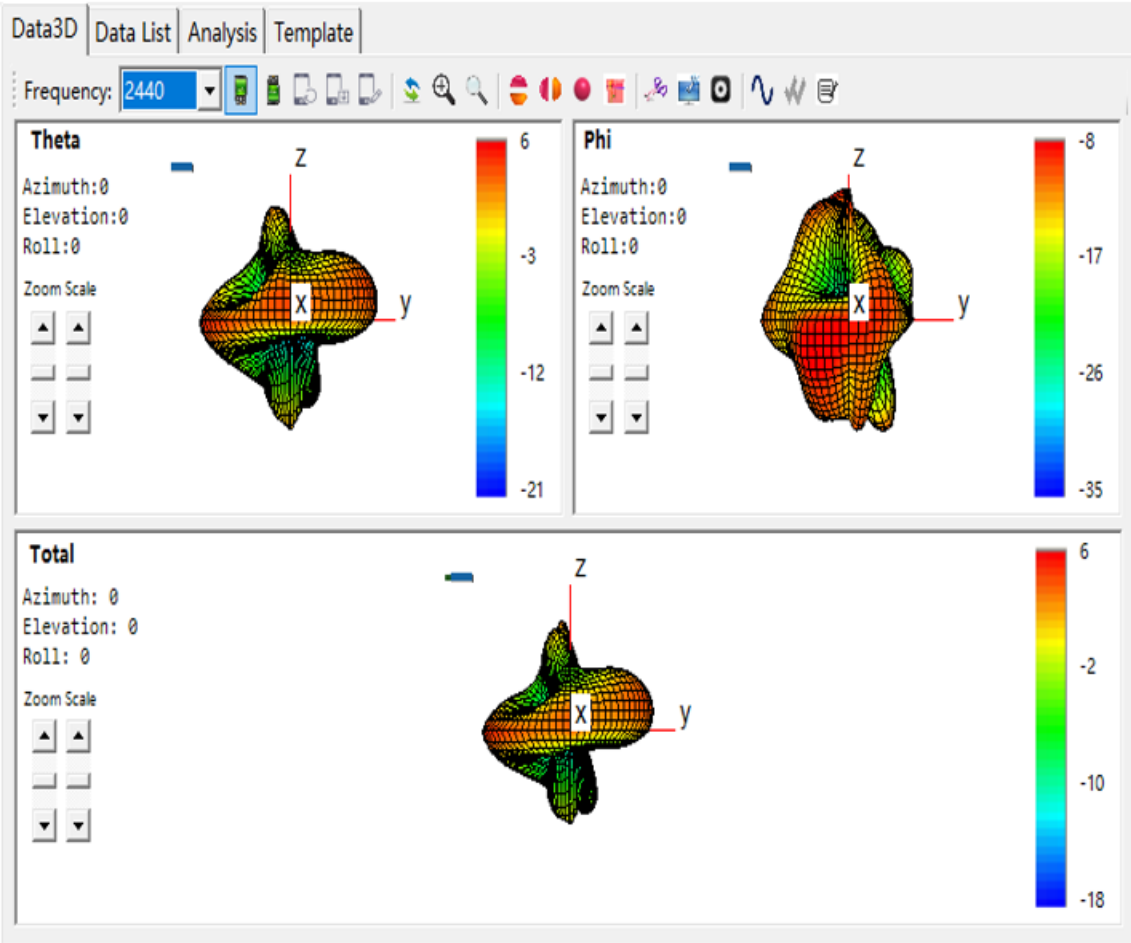

Antenna pattern

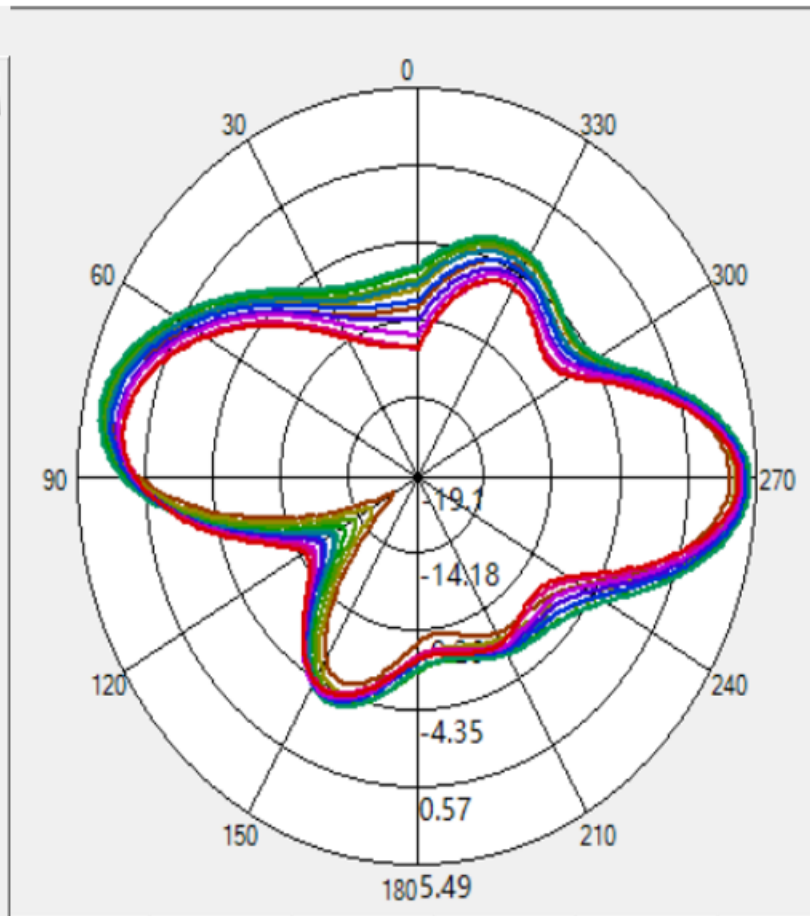
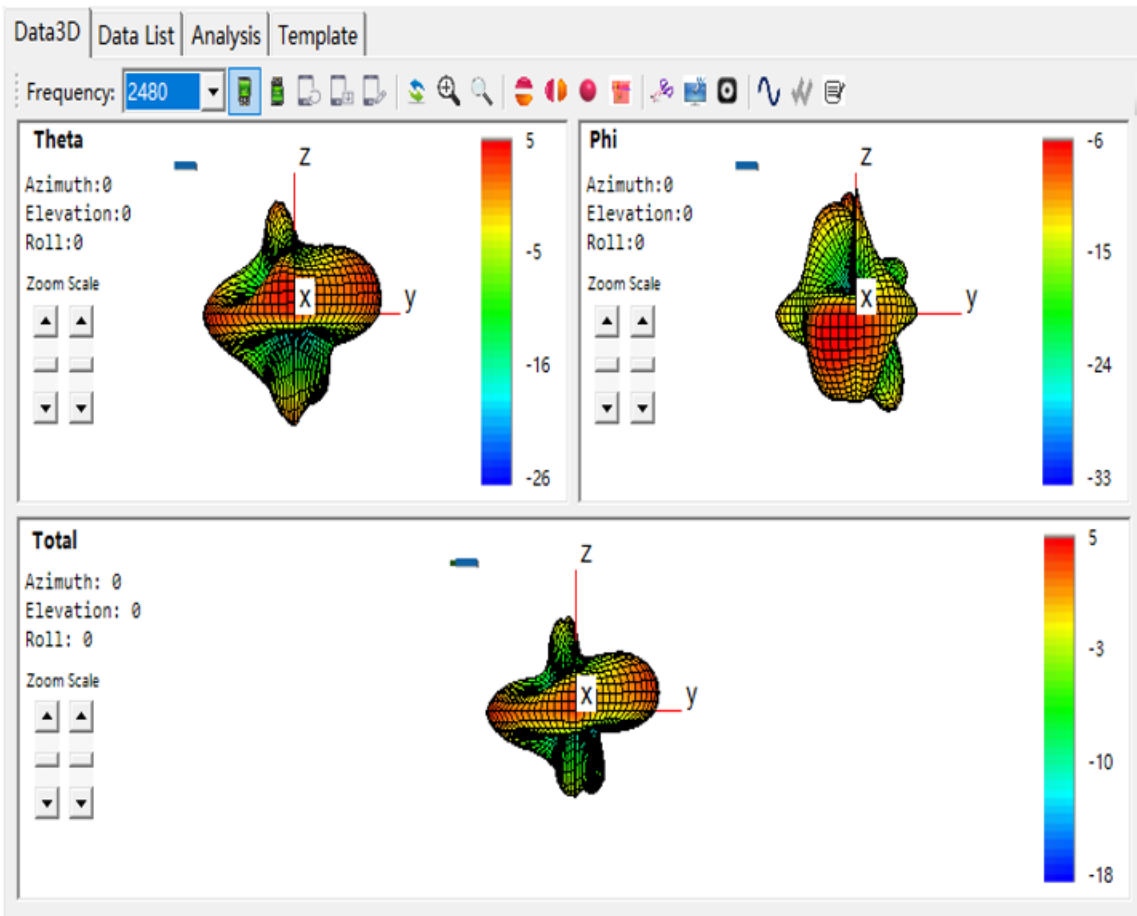

Antenna size specification

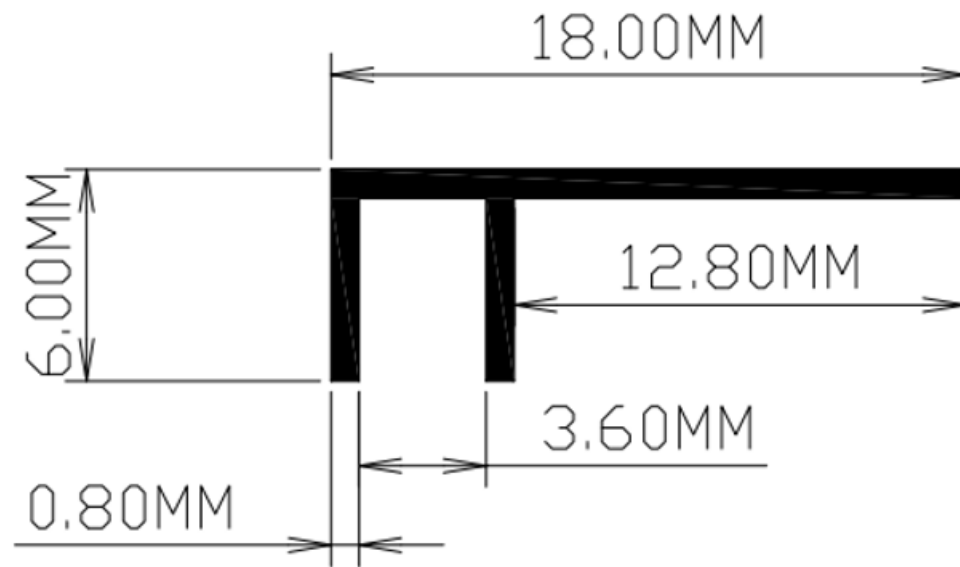

THANK YOU



Shenzhen jiashengjia Technology Co., Ltd

Contact person: wu sheng

Telephone: 15013792335

Address: Shenzhen baoan district xixiang street silver field creative park in 3 A building (zanty digital economy industrial park), room 211