

# Antenna Specification

## Specifications

### Summary

ITEM	SPEC.	
Model Name	IBM 2.4 GHz	
Center Frequency	2402 MHz	-2.10 dBi
	2441 MHz	-1.78 dBi
	2480 MHz	-1.52 dBi
MAX. GAIN	-1.52dBi	
Polarization	Horizontal	
Azimuth Beam Pattern	Omni-directional	
Impedance	50 $\Omega$	
Antenna Length	31.5cm	

Manufacturer : SHENZHEN STARWAVE INDUSTRIAL TECHNOLOGY CO.,LTD  
1505 Floor 15, Huaide International Building, No. 73, FuyongSection, Guangshen  
Road, Huaide Community, Fuyong Street, Bao'an District, Shenzhen

### Antenna Photo & Length

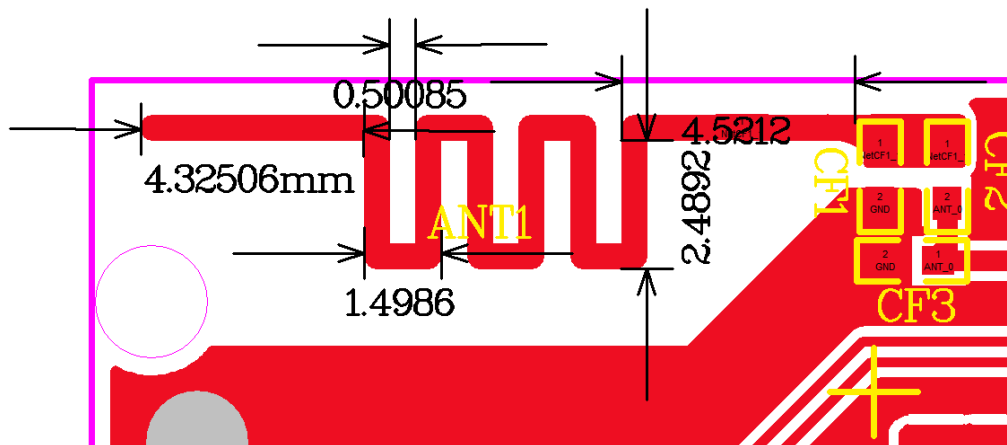

## 1. Main antenna : 2402 MHz

### 1.1 Horizontal

#### ◆ XY-plane

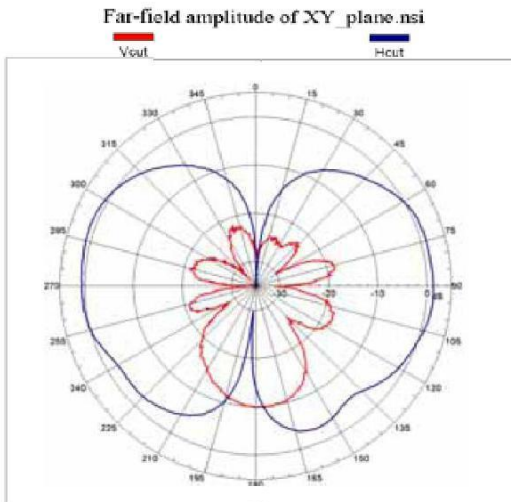

Unit : dBi

	Peak gain	Avg. gain
H cut	-2.93	-7.60
V cut	-6.85	-8.27
Total	-2.10	-5.33

### 1.2 Vertical

#### ◆ XZ-plane

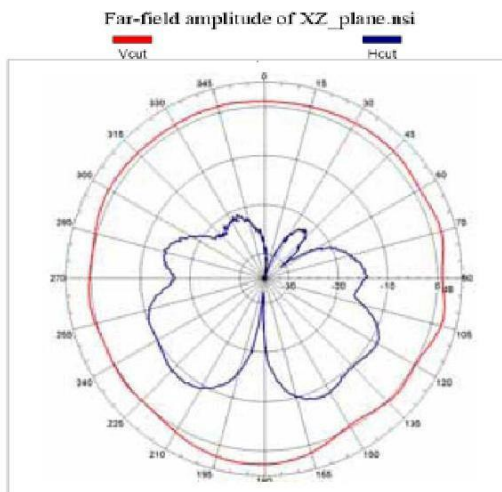

	Peak gain	Avg. gain
H cut	-5.83	-13.44
V cut	-7.04	-9.47
Total	-5.02	-7.25

## 2. Main antenna : 2441 MHz

### 2.1 Horizontal

## ◆ XY-plane

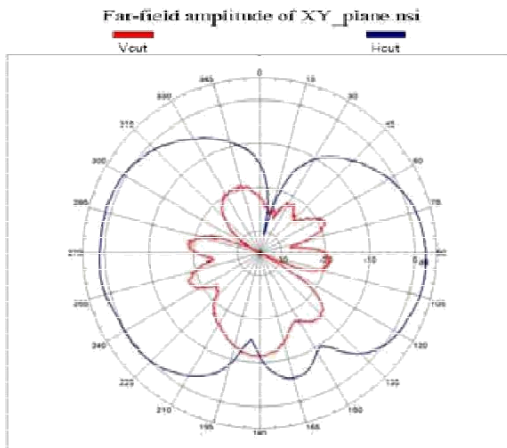

Unit : dBi

	Peak gain	Avg. gain
H cut	-2.36	-7.43
V cut	-11.01	-13.04
Total	-1.78	-8.05

## 2.2 Vertical

### ◆ XZ-plane

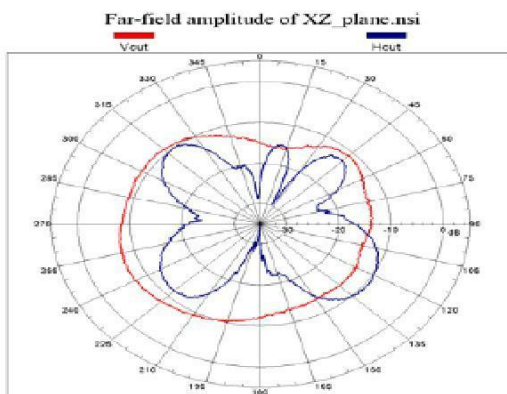

	Peak gain	Avg. gain
H cut	-7.85	-14.39
V cut	-7.02	-12.30
Total	-5.80	-8.78

## 3. Main antenna : 2480 MHz

### 3.1 Horizontal

#### ◆ YZ-plane

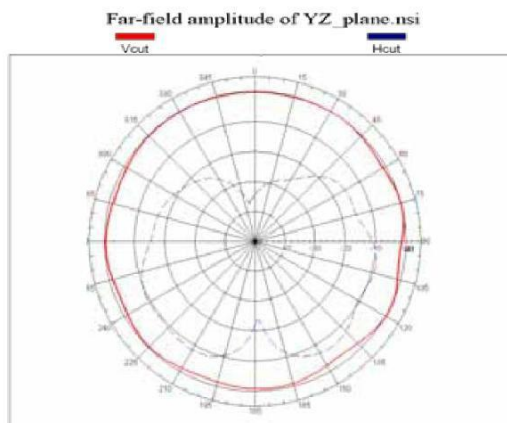

	Peak gain	Avg. gain
H cut	-4.74	-10.75
V cut	-6.47	-11.05
Total	-1.52	-7.49

### 3.2 Vertical

#### ◆YZ-plane

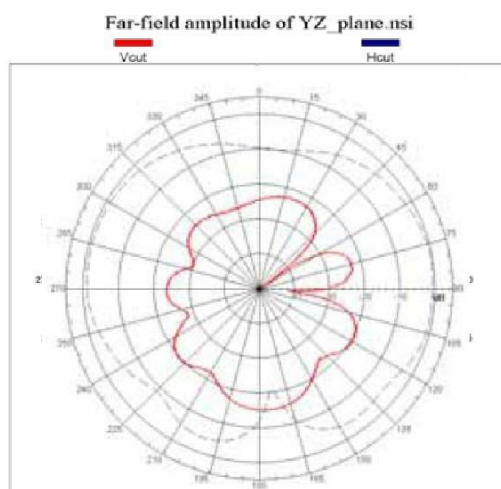

	Peak gain	Avg. gain
H cut	-5.75	-9.75
V cut	-12.47	-16.23
Total	-4.52	-8.72

### 4. Result

Center Frequency	Maximum Ant Gain	
2402MHz	H	-2.10 dBi
	V	-5.02 dBi
2441 MHz	H	-1.78 dBi
	V	-5.80 dBi
2480 MHz	H	-1.52 dBi
	V	-4.52 dBi