

FCC RADIO TEST REPORT

FCC ID: 2BDKC-AMA005986

Sample : Treadmill

Trade Mark : N/A

Main Model : AMA005986

Additional Model : JF-H-40W

Report No. : UNIA24010903ER-61

Prepared for

changsha jiuhui dianzishangwu youxiangongsi

Wangyueyuanjiedao furongzhongluyiduan466hao 1110-248hao

changshashi kaifuqu Changsha China

Prepared by

Shenzhen United Testing Technology Co., Ltd.

D101&D401, No. 107, Kaicheng High-Tech Park, Taoyuan Community,
Dalang Sub-District, Longhua District, Shenzhen, Guangdong, China

TEST RESULT CERTIFICATION

Applicant : changsha jiuhui dianzishangwu youxiangongsi
Address : Wangyueyuanjiedao furongzhongluyiduan466hao 1110-248hao
changshashi kaifuqu Changsha China

Manufacturer : Ningbo Jiufeng Electrical Appliance Co.,Ltd.
Address : No.268 Binhai road,Binhai New Area,FengHua economic
development zone,Ningbo,Zhejiang,China

Product description

Product : Treadmill
Trade Mark : N/A
Model Name : AMA005986, JF-H-40W

Test Methods : FCC Rules and Regulations Part 15 Subpart C Section 15.249,
ANSI C63.10: 2013

This device described above has been tested by Shenzhen United Testing Technology Co., Ltd., and the test results show that the equipment under test (EUT) is in compliance with the FCC requirements. And it is applicable only to the tested sample identified in the report.

This report shall not be reproduced except in full, without the written approval, this document may be altered or revised by Shenzhen United Testing Technology Co., Ltd., personnel only, and shall be noted in the revision of the document.

Date of Test

Date (s) of performance of tests : Jan. 09, 2024 ~ Jan. 16, 2024
Date of Issue : Jan. 18, 2024
Test Result : Pass

Prepared by:

Jason Ye/Editor

Reviewer:

Kelly Cheng/Supervisor

Approved & Authorized Signer:

Liuze/Manager

Table of Contents

Pages

| | |
|---|----|
| 1 TEST SUMMARY | 4 |
| 1.1 TEST PROCEDURES AND RESULTS | 4 |
| 1.2 TEST FACILITY | 5 |
| 1.3 MEASUREMENT UNCERTAINTY | 6 |
| 1.4 ENVIRONMENTAL CONDITIONS | 6 |
| 2 GENERAL INFORMATION | 7 |
| 2.1 GENERAL DESCRIPTION OF EUT | 7 |
| 2.2 CARRIER FREQUENCY OF CHANNELS | 8 |
| 2.3 DESCRIPTION OF TEST MODES | 8 |
| 2.4 TEST SETUP | 9 |
| 2.5 EQUIPMENT USED IN TESTED SYSTEM | 9 |
| 2.6 MEASUREMENT INSTRUMENTS LIST | 10 |
| 3 CONDUCTED EMISSION | 11 |
| 3.1 TEST LIMIT | 11 |
| 3.2 TEST SETUP | 11 |
| 3.3 TEST PROCEDURE | 12 |
| 3.4 TEST RESULT | 12 |
| 4 RADIATED EMISSION | 15 |
| 4.1 TEST LIMIT | 15 |
| 4.2 TEST SETUP | 16 |
| 4.3 TEST PROCEDURE | 17 |
| 4.4 TEST RESULT | 17 |
| 5 BAND EDGE | 23 |
| 5.1 TEST LIMIT | 23 |
| 5.2 TEST SETUP | 23 |
| 5.3 MEASUREMENT EQUIPMENT USED | 23 |
| 5.4 TEST PROCEDURE | 23 |
| 5.5 TEST RESULT | 23 |
| 6 20dB Bandwidth | 26 |
| 6.1 TEST SETUP (BLOCK DIAGRAM OF CONFIGURATION) | 26 |
| 6.2 MEASUREMENT EQUIPMENT USED | 26 |
| 6.3 TEST PROCEDURE | 26 |
| 6.4 TEST RESULT | 26 |
| 7 ANTENNA REQUIREMENT | 29 |
| 8 PHOTO OF TEST | 30 |

1 TEST SUMMARY

1.1 TEST PROCEDURES AND RESULTS

| Item | FCC Rules | Description Of Test | Result |
|------|------------------------|---------------------|--------|
| 1 | FCC Part 15.207 | Conducted Emission | Pass |
| 2 | FCC Part 15.209/15.249 | Radiated Emission | Pass |
| 3 | FCC Part 15.249/15.205 | Band Edge | Pass |
| 4 | FCC Part 15.215 | 20dB Bandwidth | Pass |
| 5 | FCC Part 15.203 | Antenna Requirement | Pass |

Note:

“N/A” denotes test is not applicable in this Test Report.



1.2 TEST FACILITY

Test Firm : Shenzhen United Testing Technology Co., Ltd.
Address : D101&D401, No. 107, Kaicheng High-Tech Park, Taoyuan Community,
Dalang Sub-District, Longhua District, Shenzhen, Guangdong, China

The testing quality ability of our laboratory meet with "Quality Law of People's Republic of China" Clause 19. The testing quality system of our laboratory meets with ISO/IEC-17025 requirements. This approval result is accepted by MRA of APLAC.

Our test facility is recognized, certified, or accredited by the following organizations:

A2LA Certificate Number: 4747.01

The EMC Laboratory has been accredited by A2LA, and in compliance with ISO/IEC 17025:2017 General Requirements for testing Laboratories.

FCC Registration Number: 674885

The EMC Laboratory has been registered and fully described in a report filed with the (FCC) Federal Communications commission.

IC Registration Number: 31584

The EMC Laboratory has been registered and fully described in a report filed with the (IC) Industry Canada.

1.3 MEASUREMENT UNCERTAINTY

The reported uncertainty of measurement $y \pm U$, where expanded uncertainty U is based on a standard uncertainty multiplied by a coverage factor of $k=2$, providing a level of confidence of approximately 95 %.

A. Conducted Measurement:

| Test Site | Method | Measurement Frequency Range | U, (dB) | NOTE |
|-----------|--------|-----------------------------|---------|------|
| UNI | ANSI | 9kHz ~ 150kHz | 2.96 | |
| | | 150kHz ~ 30MHz | 2.44 | |

B. Radiated Measurement:

| Test Site | Method | Measurement Frequency Range | U, (dB) | NOTE |
|-----------|--------|-----------------------------|---------|------|
| UNI | ANSI | 9kHz ~ 30MHz | 2.50 | |
| | | 30MHz ~ 1000MHz | 4.80 | |
| | | Above 1000MHz | 4.13 | |

C. RF Conducted Method:

| Item | Measurement Uncertainty |
|--|-------------------------|
| Uncertainty of total RF power, conducted | $U_c = \pm 0.8$ dB |
| Uncertainty of RF power density, conducted | $U_c = \pm 2.6$ dB |
| Uncertainty of spurious emissions, conducted | $U_c = \pm 2$ % |
| Uncertainty of Occupied Channel Bandwidth | $U_c = \pm 2$ % |

1.4 ENVIRONMENTAL CONDITIONS

During the measurement the environmental conditions were within the listed ranges:

| | NORMAL CONDITIONS | EXTREME CONDITIONS |
|-------------------------|-------------------|--------------------|
| Temperature range (°C) | 15 - 35 | -20 - 50 |
| Relative humidity range | 20 % - 75 % | 20 % - 75 % |
| Pressure range (kPa) | 86 - 106 | 86 - 106 |

Note: The Extreme Temperature and Extreme Voltages declared by the manufacturer.

2 GENERAL INFORMATION

2.1 GENERAL DESCRIPTION OF EUT

| | |
|--------------------------------|--|
| Product: | Treadmill |
| Trade Mark: | N/A |
| Main Model: | AMA005986 |
| Additional Model: | JF-H-40W |
| Model Difference: | All model's the function, software and electric circuit are the same, only with a product color and model named different. Test sample model: AMA005986. |
| FCC ID: | 2BDKC-AMA005986 |
| Operation Frequency: | 2402MHz~2480MHz |
| Number of Channels: | 40CH |
| Field Strength of Fundamental: | 95.3dBuV/m(Peak)@3m |
| Modulation Type: | GFSK |
| Antenna Type: | PCB Antenna |
| Antenna Gain: | 0dBi |
| Battery: | N/A |
| Adapter: | N/A |
| Power Source: | AC 120V, 60Hz |

2.2 CARRIER FREQUENCY OF CHANNELS

| Channel List | | | | | | | |
|--------------|-----------------|---------|-----------------|---------|-----------------|---------|-----------------|
| Channel | Frequency (MHz) | Channel | Frequency (MHz) | Channel | Frequency (MHz) | Channel | Frequency (MHz) |
| 00 | 2402 | 10 | 2422 | 20 | 2442 | 30 | 2462 |
| 01 | 2404 | 11 | 2424 | 21 | 2444 | 31 | 2464 |
| 02 | 2406 | 12 | 2426 | 22 | 2446 | 32 | 2466 |
| 03 | 2408 | 13 | 2428 | 23 | 2448 | 33 | 2468 |
| 04 | 2410 | 14 | 2430 | 24 | 2450 | 34 | 2470 |
| 05 | 2412 | 15 | 2432 | 25 | 2452 | 35 | 2472 |
| 06 | 2414 | 16 | 2434 | 26 | 2454 | 36 | 2474 |
| 07 | 2416 | 17 | 2436 | 27 | 2456 | 37 | 2476 |
| 08 | 2418 | 18 | 2438 | 28 | 2458 | 38 | 2478 |
| 09 | 2420 | 19 | 2440 | 29 | 2460 | 39 | 2480 |

2.3 DESCRIPTION OF TEST MODES

| No. | Test Mode Description |
|---|-----------------------|
| 1 | Low channel TX |
| 2 | Middle channel TX |
| 3 | High channel TX |
| <p>Note: 1. For Radiated Emission, 3axis were chosen for testing for each applicable mode.</p> <p>2.For Conducted Test method,at emporary antenna connector is provided by the manufacture.</p> | |

2.4 TEST SETUP

Operation of EUT during Conducted and Radiation testing:



Operation of EUT during RF Conducted testing:

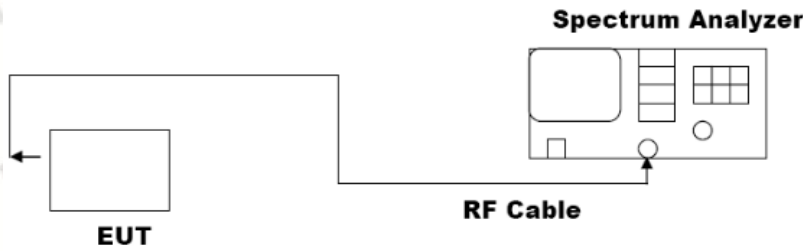

2.5 EQUIPMENT USED IN TESTED SYSTEM

| Item | Equipment | Model/Type No. | Cable Length(m) | Note |
|------|-----------|----------------|-----------------|------|
| 1 | Treadmill | AMA005986 | -- | EUT |

Note:1. The support equipment was authorized by Declaration of Confirmation.

2. All the above equipment/cables were placed in worse case positions to maximize emission signals during emission test.

2.6 MEASUREMENT INSTRUMENTS LIST

| Item | Equipment | Manufacturer | Model No. | Serial No. | Calibrated until |
|----------------------------------|-------------------------------------|---------------|----------------|---------------|------------------|
| Conduction Emissions Measurement | | | | | |
| 1 | Conducted Emission Test Software | EZ-EMC | Ver.CCS-3A1-CE | N/A | N/A |
| 2 | AMN | Schwarzbeck | NNLK8121 | 8121370 | 2024.06.11 |
| 3 | AAN | TESEQ | T8-Cat6 | 38888 | 2024.06.11 |
| 4 | Pulse Limiter | CYBRTEK | EM5010 | E115010056 | 2024.06.11 |
| 5 | EMI Test Receiver | Rohde&Schwarz | ESCI | 101210 | 2024.06.11 |
| Radiated Emissions Measurement | | | | | |
| 1 | Radiated Emission Test Software | EZ-EMC | Ver.CCS-03A1 | N/A | N/A |
| 2 | Horn Antenna | Sunol | DRH-118 | A101415 | 2025.07.14 |
| 3 | Broadband Hybrid Antenna | Sunol | JB1 | A090215 | 2025.07.28 |
| 4 | PREAMP | HP | 8449B | 3008A00160 | 2024.06.11 |
| 5 | PREAMP | HP | 8447D | 2944A07999 | 2024.06.11 |
| 6 | EMI TEST RECEIVER | Rohde&Schwarz | ESR3 | 101891 | 2024.06.11 |
| 7 | VECTOR Signal Generator | Rohde&Schwarz | SMU200A | 101521 | 2024.06.11 |
| 8 | Signal Generator | Agilent | E4421B | MY4335105 | 2024.06.11 |
| 9 | MXA Signal Analyzer | Agilent | N9020A | MY50510140 | 2024.06.11 |
| 10 | MXA Signal Analyzer | Keysight | N9020A | MY51110104 | 2024.06.11 |
| 11 | RF Power sensor | DARE | RPR3006W | 15I00041SNO88 | 2024.06.11 |
| 12 | RF Power sensor | DARE | RPR3006W | 15I00041SNO89 | 2024.06.11 |
| 13 | RF power divider | Anritsu | K241B | 992289 | 2024.06.11 |
| 14 | Wideband radio communication tester | Rohde&Schwarz | CMW500 | 154987 | 2024.06.11 |
| 15 | Active Loop Antenna | Com-Power | AL-130R | 10160009 | 2024.06.11 |
| 16 | Broadband Hybrid Antennas | Schwarzbeck | VULB9163 | VULB9163#958 | 2024.09.22 |
| 17 | Horn Antenna | Schwarzbeck | BBHA9120D | 9120D-1680 | 2025.07.14 |
| 18 | Horn Antenna | A-INFOMW | LB-180400-KF | J211060660 | 2024.07.14 |
| 19 | Microwave Broadband Preamplifier | Schwarzbeck | BBV 9721 | 100472 | 2024.09.22 |
| 20 | Signal Generator | Agilent | N5183A | MY47420153 | 2024.09.22 |
| 21 | Spectrum Analyzer | Rohde&Schwarz | FSP 40 | 100501 | 2024.09.22 |
| 22 | Power Meter | KEYSIGHT | N1911A | MY50520168 | 2024.09.22 |
| 23 | Frequency Meter | VICTOR | VC2000 | 997406086 | 2024.09.22 |
| 24 | DC Power Source | HYELEC | HY5020E | 055161818 | 2024.09.22 |

3 CONDUCTED EMISSION

3.1 TEST LIMIT

For unintentional device, according to § 15.207(a) Line Conducted Emission Limits is as following

| Frequency (MHz) | Maximum RF Line Voltage (dB μ V) | | | |
|-----------------|--------------------------------------|------|---------|--------|
| | CLASS A | | CLASS B | |
| | Q.P. | Ave. | Q.P. | Ave. |
| 0.15~0.50 | 79 | 66 | 66~56* | 56~46* |
| 0.50~5.00 | 73 | 60 | 56 | 46 |
| 5.00~30.0 | 73 | 60 | 60 | 50 |

* Decreasing linearly with the logarithm of the frequency.

For intentional device, according to §15.207(a) Line Conducted Emission Limit is same as above table.

3.2 TEST SETUP

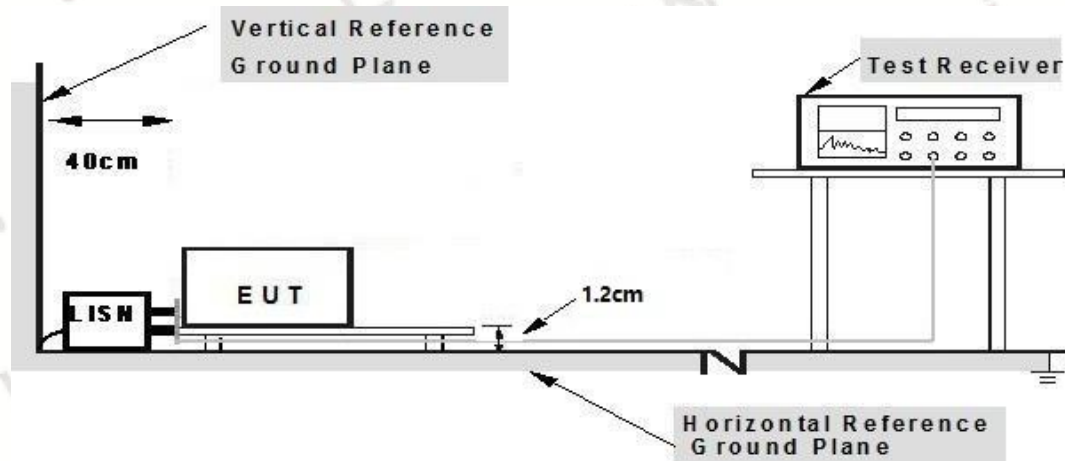

- Note: 1. Support units were connected to second LISH.**
2. Both of LISHs (AMN) are 80 cm from EUT and at least 80 from other units and other metal planes

3.3 TEST PROCEDURE

1. The equipment was set up as per the test configuration to simulate typical actual usage per the user's manual. The EUT is placed on a wooden table with a height of 1.2cm is used and is placed on the ground plane as per ANSI C63.10.
2. Support equipment, if needed, was placed as per ANSI C63.10.
3. All I/O cables were positioned to simulate typical actual usage as per ANSI C63.10.
4. If a EUT received DC power from the USB Port of adapter, the adapter received AC120V/60Hz power through a Line Impedance Stabilization Network (LISN) which supplied power source and was grounded to the ground plane.
5. All support equipments received AC power from a second LISN, if any.
6. The EUT test program was started. Emissions were measured on each current carrying line of the EUT using a spectrum Analyzer / Receiver connected to the LISN powering the EUT. The LISN has two monitoring points: Line 1 (Hot Side) and Line 2 (Neutral Side). Two scans were taken: one with Line 1 connected to Analyzer / Receiver and Line 2 connected to a 50 ohm load; the second scan had Line 1 connected to a 50 ohm load and Line 2 connected to the Analyzer / Receiver.
7. Analyzer / Receiver scanned from 150 kHz to 30MHz for emissions in each of the test modes.

3.4 TEST RESULT

PASS

Remark:

1. All modes were tested at AC 120V and 240V, only the worst result of AC 120V was reported.
2. All modes were test at Low, Middle, and High channel, only the worst result of GFSK Low Channel was reported.

| | | | |
|---------------|-----------------------------------|--------------------|---------|
| Temperature: | 24°C | Relative Humidity: | 48% |
| Test Date: | Jan. 12, 2024 | Pressure: | 1010hPa |
| Test Voltage: | AC 120V, 60Hz | Phase: | Line |
| Test Mode: | Transmitting mode of GFSK 2402MHz | | |

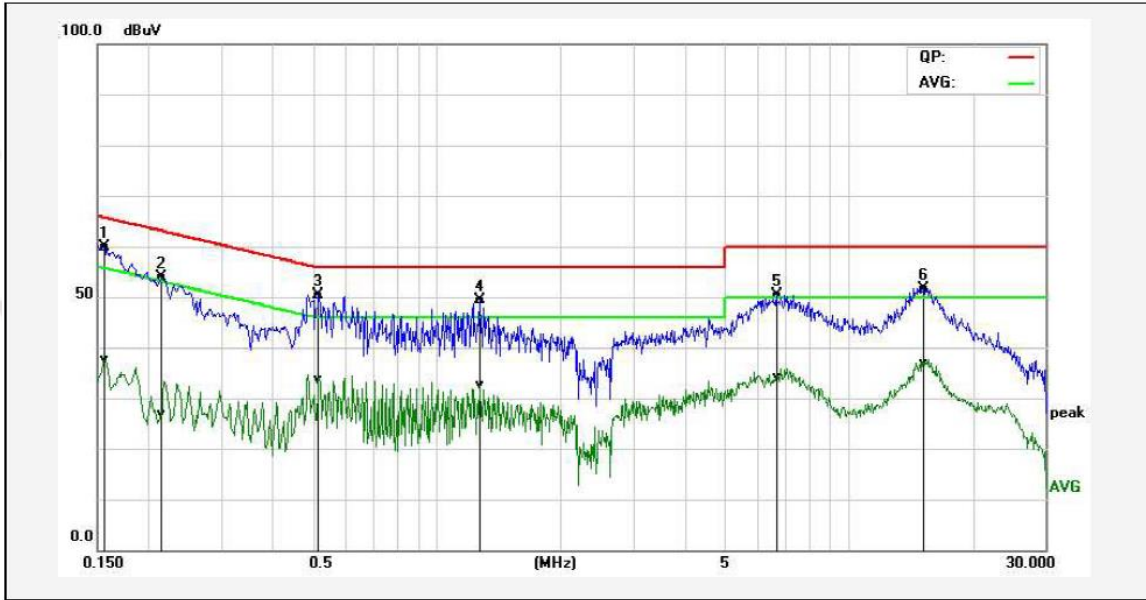

| No. | Frequency (MHz) | QuasiPeak reading (dBuV) | Average reading (dBuV) | Correction factor (dB) | QuasiPeak result (dBuV) | Average result (dBuV) | QuasiPeak limit (dBuV) | Average limit (dBuV) | QuasiPeak margin (dB) | Average margin (dB) | Remark |
|-----|-----------------|--------------------------|------------------------|------------------------|-------------------------|-----------------------|------------------------|----------------------|-----------------------|---------------------|--------|
| 1P | 0.1557 | 48.83 | 26.39 | 11.12 | 59.95 | 37.51 | 65.68 | 55.69 | -5.73 | -18.18 | Pass |
| 2P | 0.2140 | 43.14 | 16.17 | 10.78 | 53.92 | 26.95 | 63.04 | 53.05 | -9.12 | -26.10 | Pass |
| 3* | 0.5180 | 39.61 | 22.70 | 10.83 | 50.44 | 33.53 | 56.00 | 46.00 | -5.56 | -12.47 | Pass |
| 4P | 1.2700 | 38.49 | 21.59 | 10.93 | 49.42 | 32.52 | 56.00 | 46.00 | -6.58 | -13.48 | Pass |
| 5P | 6.6820 | 38.21 | 21.98 | 12.27 | 50.48 | 34.25 | 60.00 | 50.00 | -9.52 | -15.75 | Pass |
| 6P | 15.1460 | 35.52 | 20.74 | 16.19 | 51.71 | 36.93 | 60.00 | 50.00 | -8.29 | -13.07 | Pass |

Remark: Factor = Insertion Loss + Cable Loss, Result = Reading + Factor, Margin = Result – Limit.

| | | | |
|---------------|-----------------------------------|--------------------|---------|
| Temperature: | 24°C | Relative Humidity: | 48% |
| Test Date: | Jan. 12, 2024 | Pressure: | 1010hPa |
| Test Voltage: | AC 120V, 60Hz | Phase: | Neutral |
| Test Mode: | Transmitting mode of GFSK 2402MHz | | |

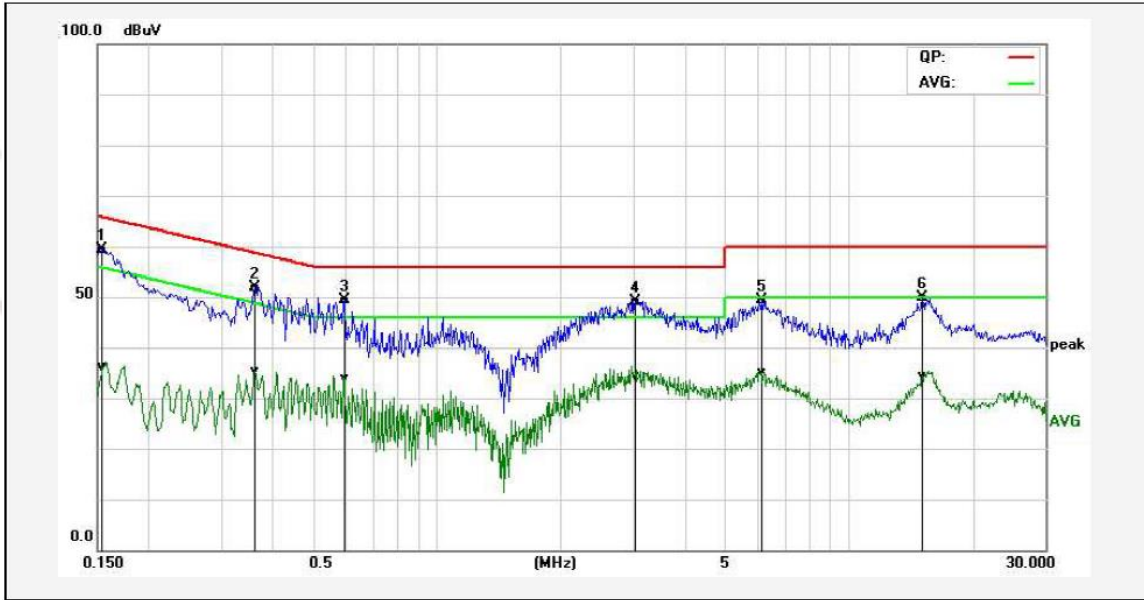

| No. | Frequency (MHz) | QuasiPeak reading (dBuV) | Average reading (dBuV) | Correction factor (dB) | QuasiPeak result (dBuV) | Average result (dBuV) | QuasiPeak limit (dBuV) | Average limit (dBuV) | QuasiPeak margin (dB) | Average margin (dB) | Remark |
|-----|-----------------|--------------------------|------------------------|------------------------|-------------------------|-----------------------|------------------------|----------------------|-----------------------|---------------------|--------|
| 1* | 0.1540 | 48.31 | 25.07 | 11.13 | 59.44 | 36.20 | 65.78 | 55.78 | -6.34 | -19.58 | Pass |
| 2P | 0.3620 | 41.19 | 24.59 | 10.78 | 51.97 | 35.37 | 58.68 | 48.68 | -6.71 | -13.31 | Pass |
| 3P | 0.5947 | 38.47 | 23.19 | 10.81 | 49.28 | 34.00 | 56.00 | 46.00 | -6.72 | -12.00 | Pass |
| 4P | 3.0260 | 37.90 | 22.96 | 11.33 | 49.23 | 34.29 | 56.00 | 46.00 | -6.77 | -11.71 | Pass |
| 5P | 6.1340 | 37.27 | 23.16 | 12.09 | 49.36 | 35.25 | 60.00 | 50.00 | -10.64 | -14.75 | Pass |
| 6P | 15.0900 | 33.63 | 18.10 | 16.20 | 49.83 | 34.30 | 60.00 | 50.00 | -10.17 | -15.70 | Pass |

Remark: Factor = Insertion Loss + Cable Loss, Result = Reading + Factor, Margin = Result – Limit.

4 RADIATED EMISSION

4.1 TEST LIMIT

For unintentional device, according to § 15.209(a), except for Class B digital devices, the field strength of radiated emissions from unintentional radiators at a distance of 3 meters shall not exceed the following values:

| Frequency | Field strength (microvolt/meter) | Limit (dBuV/m) | Remark | Measurement distance (m) |
|-------------------|----------------------------------|-----------------|------------|--------------------------|
| 0.009MHz-0.490MHz | 2400/F (kHz) | - | Quasi-peak | 300 |
| 0.490MHz-1.705MHz | 24000/F (kHz) | - | Quasi-peak | 30 |
| 1.705MHz-30MHz | 30 | - | Quasi-peak | 30 |
| 30MHz-88MHz | 100 | 40.0 | Quasi-peak | 3 |
| 88MHz-216MHz | 150 | 43.5 | Quasi-peak | 3 |
| 216MHz-960MHz | 200 | 46.0 | Quasi-peak | 3 |
| 960MHz-1GHz | 500 | 54.0 | Quasi-peak | 3 |
| Above 1GHz | 500 | 54.0 | Average | 3 |
| | | 74.0 | Peak | 3 |

For intentional device, according to § 15.209(a), the general requirement of field strength of radiated emissions from intentional radiators at a distance of 3 meters shall not exceed the above table.

Limit: (Field strength of the fundamental signal)

| Frequency | Limit (dBuV/m @3m) | Remark |
|-------------------|--------------------|---------------|
| 2400MHz-2483.5MHz | 94.0 | Average Value |
| | 114.0 | Peak Value |

4.2 TEST SETUP

1. Radiated Emission Test-Up Frequency Below 30MHz

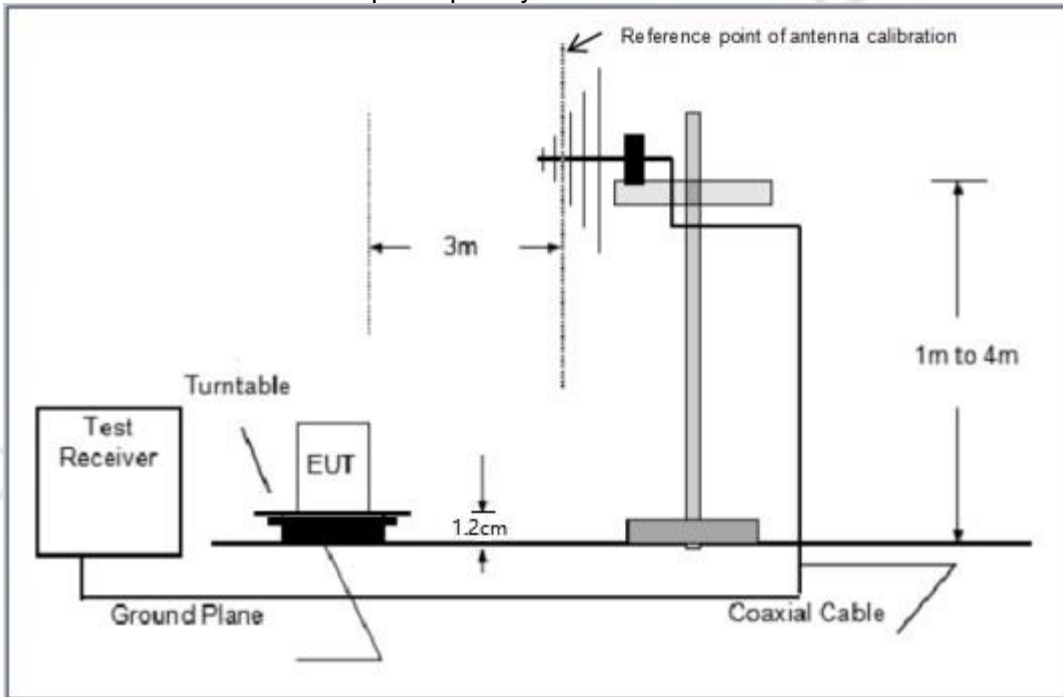

2. Radiated Emission Test-Up Frequency 30MHz~1GHz

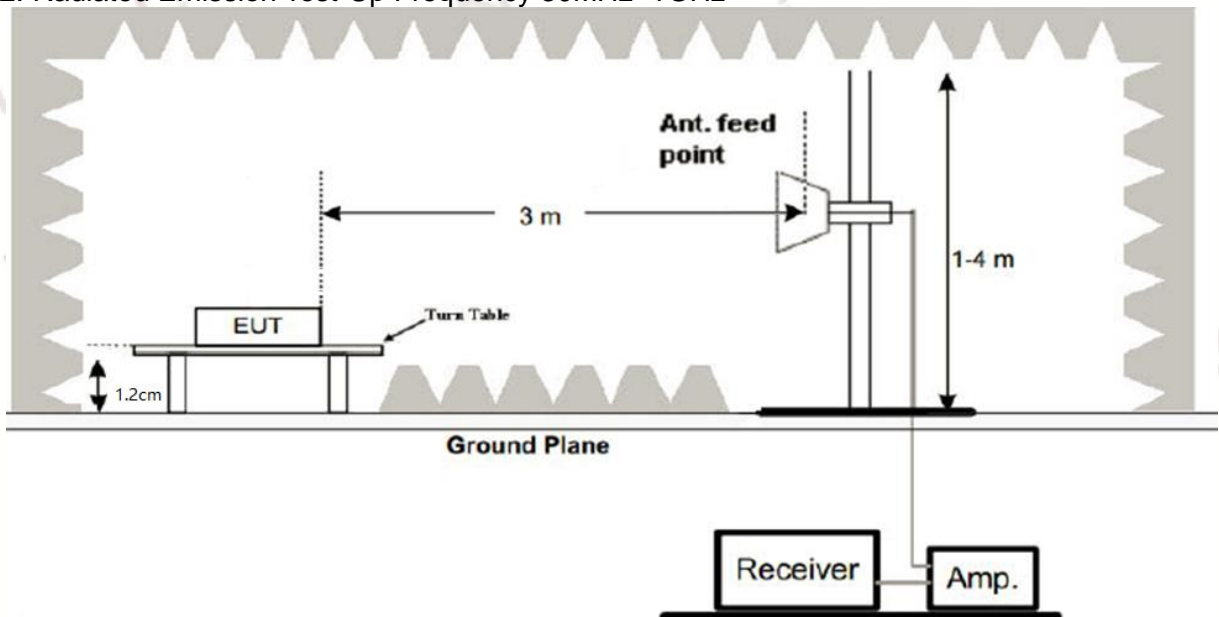

3. Radiated Emission Test-Up Frequency Above 1GHz

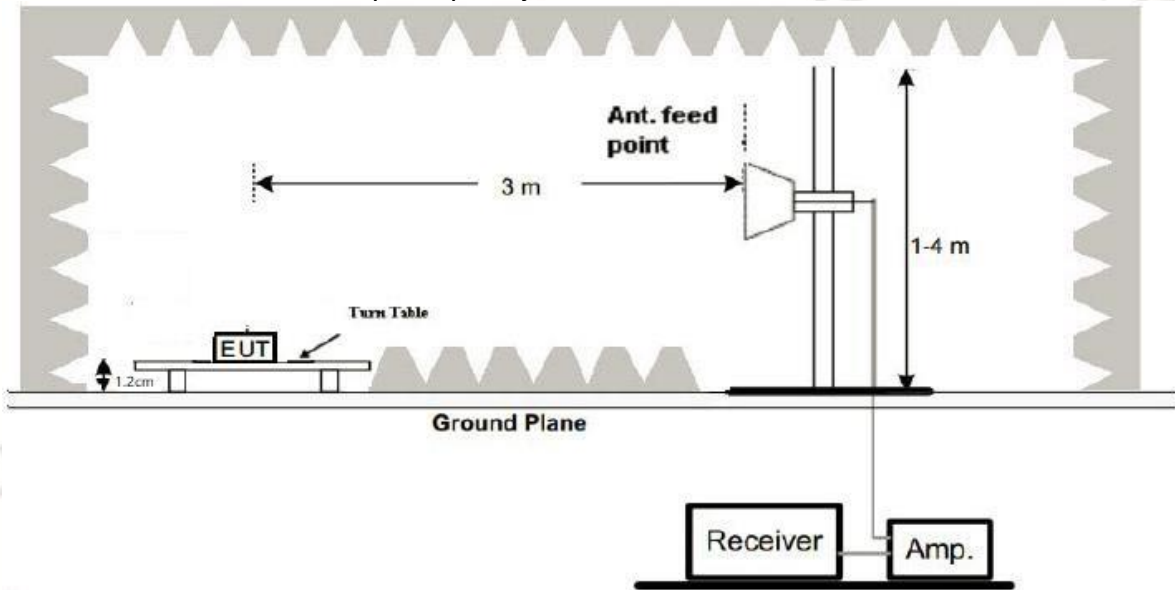

4.3 TEST PROCEDURE

1. Below 1GHz measurement the EUT is placed on turntable which is 1.2cm above ground plane. And above 1GHz measurement EUT was placed on low permittivity and low tangent turn table which is 1.5m above ground plane.
2. The turntable shall be rotated for 360 degrees to determine the position of maximum emission level.
3. EUT is set 3m away from the receiving antenna, which is varied from 1m to 4m to find out the highest emissions.
4. Maximum procedure was performed on the six highest emissions to ensure EUT compliance.
5. And also, each emission was to be maximized by changing the polarization of receiving antenna both horizontal and vertical.
6. Repeat above procedures until the measurements for all frequencies are complete.
7. The test frequency range from 9kHz to 25GHz per FCC PART 15.33(a).

Note: For battery operated equipment, the equipment tests shall be performed using a new battery.

4.4 TEST RESULT

PASS

Remark:

1. All modes were test at Low, Middle, and High channel, only the worst result of GFSK Low Channel was reported for below 1GHz test.
2. By preliminary testing and verifying three axis (X, Y and Z) position of EUT transmitted status, it was found that "X axis" position was the worst, and test data recorded in this report.
3. Radiated emission test from 9kHz to 10th harmonic of fundamental was verified, and no emission found except system noise floor in 9kHz to 30MHz and not recorded in this report.

Below 1GHz Test Results:

| | | | |
|---------------|-----------------------------------|--------------------|------------|
| Temperature: | 24°C | Relative Humidity: | 48% |
| Test Date: | Jan. 12, 2024 | Pressure: | 1010hPa |
| Test Voltage: | AC 120V, 60Hz | Phase: | Horizontal |
| Test Mode: | Transmitting mode of GFSK 2402MHz | | |

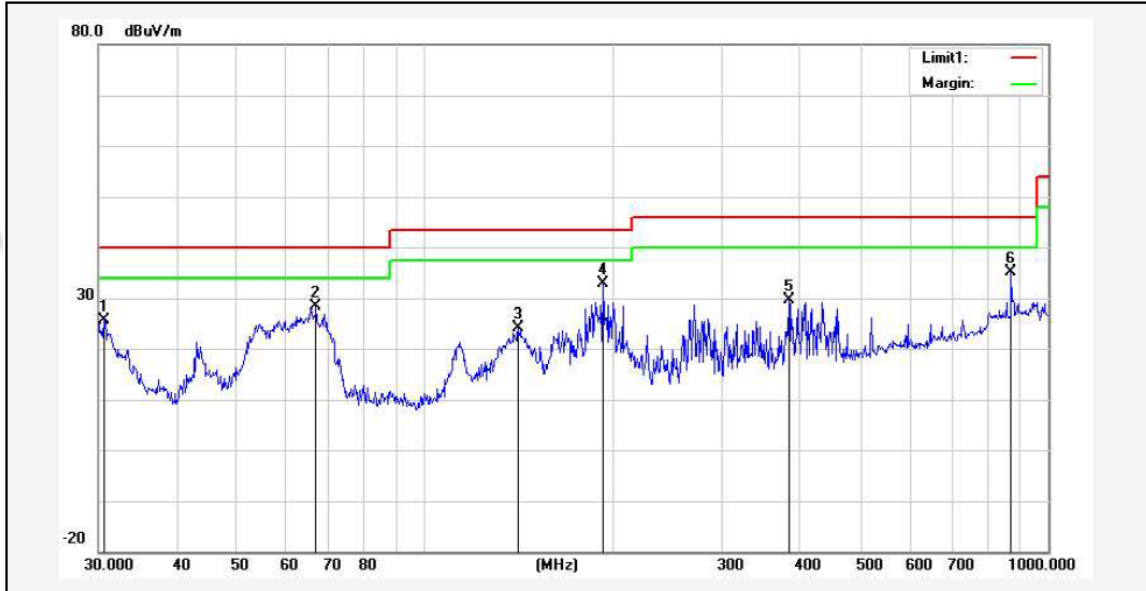

| No. | Frequency (MHz) | Reading (dBuV) | Correction factor(dB/m) | Result (dBuV/m) | Limit (dBuV/m) | Margin (dB) | Degree (deg.) | Height (cm) | Remark |
|-----|-----------------|----------------|-------------------------|-----------------|----------------|-------------|---------------|-------------|--------|
| 1 | 30.6378 | 38.82 | -13.24 | 25.58 | 40.00 | -14.42 | 122 | 100 | peak |
| 2 | 66.9668 | 49.27 | -21.00 | 28.27 | 40.00 | -11.73 | 175 | 100 | peak |
| 3 | 141.3298 | 38.79 | -14.70 | 24.09 | 43.50 | -19.41 | 64 | 100 | peak |
| 4* | 193.0945 | 49.25 | -16.36 | 32.89 | 43.50 | -10.61 | 38 | 100 | peak |
| 5 | 383.9318 | 42.10 | -12.36 | 29.74 | 46.00 | -16.26 | 79 | 100 | peak |
| 6 | 872.1832 | 40.65 | -5.45 | 35.20 | 46.00 | -10.80 | 116 | 100 | peak |

Remark: Result = Reading Level + Factor, Margin = Result – Limit
 Factor = Ant. Factor + Cable Loss – Pre-amplifier

| | | | |
|---------------|-----------------------------------|--------------------|----------|
| Temperature: | 24°C | Relative Humidity: | 48% |
| Test Date: | Jan. 12, 2024 | Pressure: | 1010hPa |
| Test Voltage: | AC 120V, 60Hz | Phase: | Vertical |
| Test Mode: | Transmitting mode of GFSK 2402MHz | | |

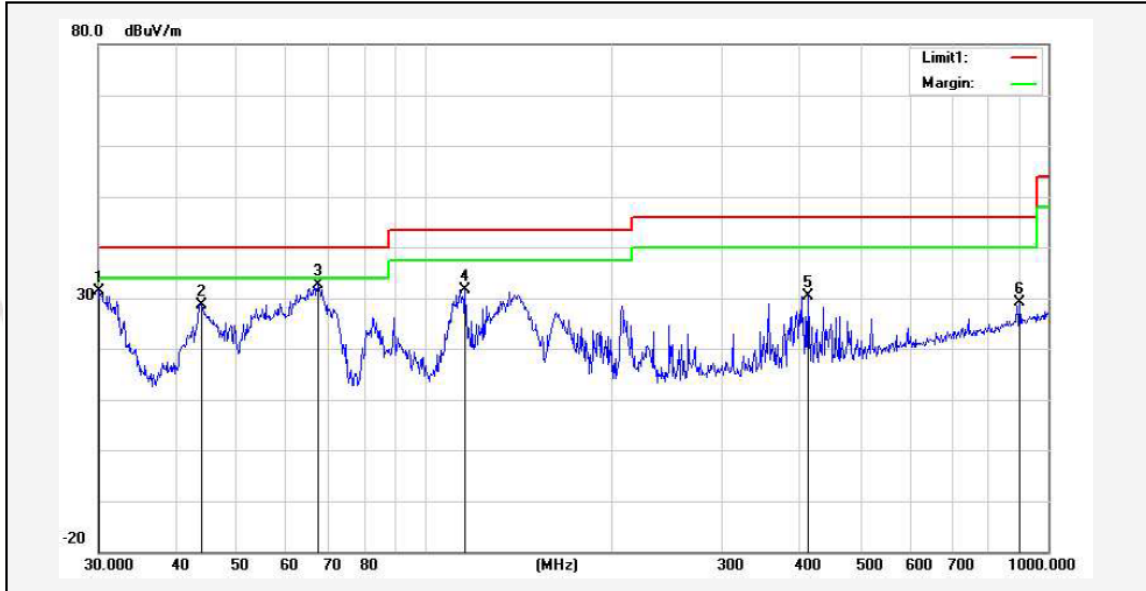

| No. | Frequency (MHz) | Reading (dBuV) | Correction factor(dB/m) | Result (dBuV/m) | Limit (dBuV/m) | Margin (dB) | Degree (deg.) | Height (cm) | Remark |
|-----|-----------------|----------------|-------------------------|-----------------|----------------|-------------|---------------|-------------|--------|
| 1 | 30.1054 | 44.04 | -12.67 | 31.37 | 40.00 | -8.63 | 146 | 100 | peak |
| 2 | 43.8120 | 46.14 | -17.53 | 28.61 | 40.00 | -11.39 | 137 | 100 | peak |
| 3* | 67.4381 | 53.66 | -20.96 | 32.70 | 40.00 | -7.30 | 118 | 100 | peak |
| 4 | 116.1321 | 47.74 | -16.05 | 31.69 | 43.50 | -11.81 | 112 | 100 | peak |
| 5 | 411.8240 | 42.18 | -11.73 | 30.45 | 46.00 | -15.55 | 49 | 100 | peak |
| 6 | 900.1474 | 34.30 | -5.10 | 29.20 | 46.00 | -16.80 | 105 | 100 | peak |

Remark: Result = Reading Level + Factor, Margin = Result – Limit
 Factor = Ant. Factor + Cable Loss – Pre-amplifier

Remark:

1. Measuring frequencies from 9 kHz to the 1 GHz, Radiated emission test from 9kHz to 30MHz was verified, and no any emission was found except system noise floor.
2. * denotes emission frequency which appearing within the Restricted Bands specified in provision of 15.205, then the general radiated emission limits in 15.209 apply.
3. The IF bandwidth of EMI Test Receiver between 30MHz to 1GHz was 120kHz, 1 MHz for measuring above 1 GHz, below 30MHz was 10kHz.

Above 1 GHz Test Results:

CH00 (2402MHz)

Horizontal:

| Frequency (MHz) | Reading Result (dBμV) | Factor (dB) | Emission Level (dBμV/m) | Limits (dBμV/m) | Margin (dB) | Detector Type |
|--------------------|--------------------------|----------------|----------------------------|--------------------|----------------|---------------|
| 2402 | 101.14 | -5.84 | 95.3 | 114 | -18.7 | PK |
| 2402 | 80.85 | -5.84 | 75.01 | 94 | -18.99 | AV |
| 4804 | 58.08 | -3.64 | 54.44 | 74 | -19.56 | PK |
| 4804 | 37.96 | -3.64 | 34.32 | 54 | -19.68 | AV |
| 7206 | 55.09 | -0.95 | 54.14 | 74 | -19.86 | PK |
| 7206 | 34.68 | -0.95 | 33.73 | 54 | -20.27 | AV |

Remark: Factor = Antenna Factor + Cable Loss – Pre-amplifier. Margin = Emission Level – Limit

Vertical:

| Frequency (MHz) | Reading Result (dBμV) | Factor (dB) | Emission Level (dBμV/m) | Limits (dBμV/m) | Margin (dB) | Detector Type |
|--------------------|--------------------------|----------------|----------------------------|--------------------|----------------|---------------|
| 2402 | 100.79 | -5.84 | 94.95 | 114 | -19.05 | PK |
| 2402 | 80.49 | -5.84 | 74.65 | 94 | -19.35 | AV |
| 4804 | 57.86 | -3.64 | 54.22 | 74 | -19.78 | PK |
| 4804 | 37.6 | -3.64 | 33.96 | 54 | -20.04 | AV |
| 7206 | 54.49 | -0.95 | 53.54 | 74 | -20.46 | PK |
| 7206 | 34.02 | -0.95 | 33.07 | 54 | -20.93 | AV |

Remark: Factor = Antenna Factor + Cable Loss – Pre-amplifier. Margin = Emission Level – Limit



CH19 (2440MHz)

Horizontal:

| Frequency (MHz) | Reading Result (dBμV) | Factor (dB) | Emission Level (dBμV/m) | Limits (dBμV/m) | Margin (dB) | Detector Type |
|--------------------|--------------------------|----------------|----------------------------|--------------------|----------------|---------------|
| 2440 | 100.53 | -5.71 | 94.82 | 114 | -19.18 | PK |
| 2440 | 80.36 | -5.71 | 74.65 | 94 | -19.35 | AV |
| 4880 | 57.59 | -3.51 | 54.08 | 74 | -19.92 | PK |
| 4880 | 37.47 | -3.51 | 33.96 | 54 | -20.04 | AV |
| 7320 | 54.46 | -0.82 | 53.64 | 74 | -20.36 | PK |
| 7320 | 34.16 | -0.82 | 33.34 | 54 | -20.66 | AV |

Remark: Factor = Antenna Factor + Cable Loss – Pre-amplifier. Margin = Emission Level – Limit

Vertical:

| Frequency (MHz) | Reading Result (dBμV) | Factor (dB) | Emission Level (dBμV/m) | Limits (dBμV/m) | Margin (dB) | Detector Type |
|--------------------|--------------------------|----------------|----------------------------|--------------------|----------------|---------------|
| 2440 | 100.36 | -5.71 | 94.65 | 114 | -19.35 | PK |
| 2440 | 80.06 | -5.71 | 74.35 | 94 | -19.65 | AV |
| 4880 | 57.43 | -3.51 | 53.92 | 74 | -20.08 | PK |
| 4880 | 37.17 | -3.51 | 33.66 | 54 | -20.34 | AV |
| 7320 | 54.06 | -0.82 | 53.24 | 74 | -20.76 | PK |
| 7320 | 33.59 | -0.82 | 32.77 | 54 | -21.23 | AV |

Remark: Factor = Antenna Factor + Cable Loss – Pre-amplifier. Margin = Emission Level – Limit

Horizontal:

| Frequency (MHz) | Reading Result (dB μ V) | Factor (dB) | Emission Level (dB μ V/m) | Limits (dB μ V/m) | Margin (dB) | Detector Type |
|--------------------|--------------------------------|----------------|----------------------------------|--------------------------|----------------|---------------|
| 2480 | 100.24 | -5.65 | 94.59 | 114 | -19.41 | PK |
| 2480 | 80.02 | -5.65 | 74.37 | 94 | -19.63 | AV |
| 4960 | 57.34 | -3.43 | 53.91 | 74 | -20.09 | PK |
| 4960 | 37.22 | -3.43 | 33.79 | 54 | -20.21 | AV |
| 7440 | 54.21 | -0.75 | 53.46 | 74 | -20.54 | PK |
| 7440 | 33.91 | -0.75 | 33.16 | 54 | -20.84 | AV |

Remark: Factor = Antenna Factor + Cable Loss – Pre-amplifier. Margin = Emission Level – Limit

Vertical:

| Frequency (MHz) | Reading Result (dB μ V) | Factor (dB) | Emission Level (dB μ V/m) | Limits (dB μ V/m) | Margin (dB) | Detector Type |
|--------------------|--------------------------------|----------------|----------------------------------|--------------------------|----------------|---------------|
| 2480 | 99.94 | -5.63 | 94.31 | 114 | -19.69 | PK |
| 2480 | 79.84 | -5.65 | 74.19 | 94 | -19.81 | AV |
| 4960 | 57.19 | -3.43 | 53.76 | 74 | -20.24 | PK |
| 4960 | 36.95 | -3.43 | 33.52 | 54 | -20.48 | AV |
| 7440 | 53.84 | -0.75 | 53.09 | 74 | -20.91 | PK |
| 7440 | 33.37 | -0.75 | 32.62 | 54 | -21.38 | AV |

Remark: Factor = Antenna Factor + Cable Loss – Pre-amplifier. Margin = Emission Level – Limit

Remark:

1. Measuring frequencies from 1 GHz to the 25 GHz.
2. "F" denotes fundamental frequency; "H" denotes spurious frequency. "E" denotes band edge frequency.
3. * denotes emission frequency which appearing within the Restricted Bands specified in provision of 15.205, then the general radiated emission limits in 15.209 apply.
4. Data of measurement within this frequency range shown "---" in the table above means the reading of emissions are attenuated more than 20dB below the permissible limits or the field strength is too small to be measured.
5. The IF bandwidth of EMI Test Receiver between 30MHz to 1GHz was 120kHz, 1 MHz for measuring above 1 GHz, below 30MHz was 10kHz. The resolution bandwidth of test receiver/spectrum analyzer is 1MHz and video bandwidth is 3MHz for peak measurement with peak detector at frequency above 1GHz. The resolution bandwidth of test receiver/spectrum analyzer is 1MHz and video bandwidth is 10Hz for Average measurement with peak detection at frequency above 1GHz.
6. When the test results of Peak Detected below the limits of Average Detected, the Average Detected is not need completed. For example: Top Channel at Fundamental 73.16dBuV/m(PK Value) <93.98(AV Limit), at harmonic 53.20 dBuV/m(PK Value) <54 dBuV/m(AV Limit), the Average Detected not need to completed.
7. For fundamental frequency, RBW >20dB BW, VBW>=3XRBW, PK detector for PK value, AV detector for AV value.

5 BAND EDGE

5.1 TEST LIMIT

FCC PART 15.249(d) Emissions radiated outside of the specified frequency bands, except for harmonics, shall be attenuated by at least 50 dB below the level of the fundamental or to the general radiated emission limits in §15.209, whichever is the lesser attenuation.

5.2 TEST SETUP

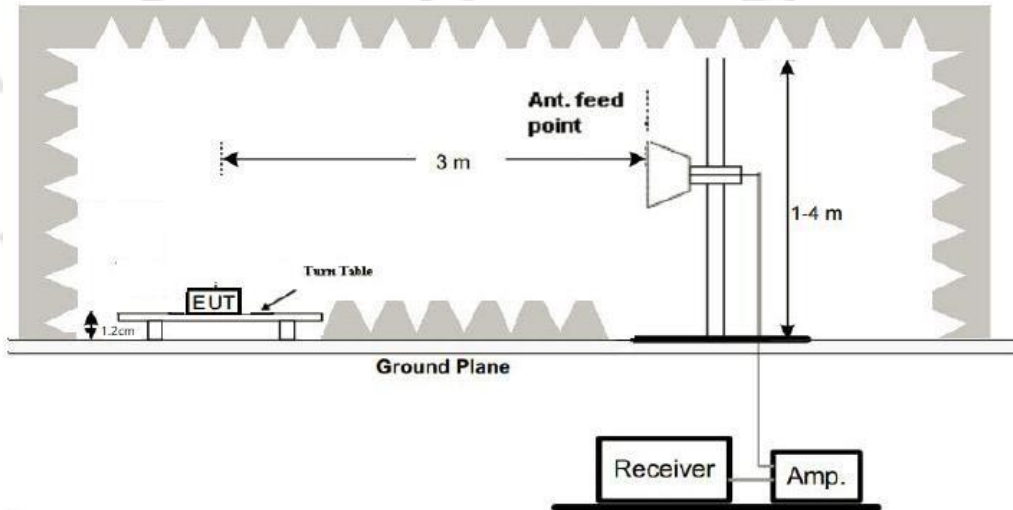

5.3 MEASUREMENT EQUIPMENT USED

Refer to Section 2.6.

5.4 TEST PROCEDURE

1. The EUT operates at transmitting mode. The operate channel is tested to verify the largest transmission and spurious emissions power at the continuous transmission mode. The band edge compliance of RF radiated emission should be measured by following the guidance in ANSI C63.10 with respect to maximizing the emission by rotating the EUT, measuring the emission while the EUT is situated in three orthogonal planes (if appropriate), adjusting the measurement antenna height and polarization etc.
2. Set the spectrum analyzer in the following setting in order to capture the lower and upper band-edges of the emission: (a) PEAK: RBW=1MHz, VBW=3MHz / Sweep=AUTO
(b) AVERAGE: RBW=1MHz ; VBW=3MHz / Sweep=AUTO

5.5 TEST RESULT

PASS

Operation Mode: TX CH00 (2402MHz)

Horizontal:

| Frequency (MHz) | Reading Result (dBμV) | Factor (dB) | Emission Level (dBμV/m) | Limits (dBμV/m) | Margin (dB) | Detector Type |
|--------------------|--------------------------|----------------|----------------------------|--------------------|----------------|------------------|
| 2310 | 57.25 | -5.81 | 51.44 | 74 | -22.56 | PK |
| 2310 | / | -5.81 | / | 54 | / | AV |
| 2390 | 57.37 | -5.84 | 51.53 | 74 | -22.47 | PK |
| 2390 | / | -5.84 | / | 54 | / | AV |
| 2400 | 57.22 | -5.84 | 51.38 | 74 | -22.62 | PK |
| 2400 | / | -5.84 | / | 54 | / | AV |

Remark: Factor = Antenna Factor + Cable Loss – Pre-amplifier.

Vertical:

| Frequency (MHz) | Reading Result (dBμV) | Factor (dB) | Emission Level (dBμV/m) | Limits (dBμV/m) | Margin (dB) | Detector Type |
|--------------------|--------------------------|----------------|----------------------------|--------------------|----------------|------------------|
| 2310 | 56.99 | -5.81 | 51.18 | 74 | -22.82 | PK |
| 2310 | / | -5.81 | / | 54 | / | AV |
| 2390 | 57.16 | -5.84 | 51.32 | 74 | -22.68 | PK |
| 2390 | / | -5.84 | / | 54 | / | AV |
| 2400 | 57.32 | -5.84 | 51.48 | 74 | -22.52 | PK |
| 2400 | / | -5.84 | / | 54 | / | AV |

Remark: Factor = Antenna Factor + Cable Loss – Pre-amplifier.

Operation Mode: TX CH39 (2480MHz)

Horizontal:

| Frequency (MHz) | Reading Result (dBμV) | Factor (dB) | Emission Level (dBμV/m) | Limits (dBμV/m) | Margin (dB) | Detector Type |
|--------------------|--------------------------|----------------|----------------------------|--------------------|----------------|------------------|
| 2483.5 | 55.89 | -5.65 | 50.24 | 74 | -23.76 | PK |
| 2483.5 | / | -5.65 | / | 54 | / | AV |
| 2500 | 57.01 | -5.72 | 51.29 | 74 | -22.71 | PK |
| 2500 | / | -5.72 | / | 54 | / | AV |

Remark: Factor = Antenna Factor + Cable Loss – Pre-amplifier.

Vertical:

| Frequency (MHz) | Reading Result (dBμV) | Factor (dB) | Emission Level (dBμV/m) | Limits (dBμV/m) | Margin (dB) | Detector Type |
|--------------------|--------------------------|----------------|----------------------------|--------------------|----------------|------------------|
| 2483.5 | 57.47 | -5.65 | 51.82 | 74 | -22.18 | PK |
| 2483.5 | / | -5.65 | / | 54 | / | AV |
| 2500 | 56.98 | -5.72 | 51.26 | 74 | -22.74 | PK |
| 2500 | / | -5.72 | / | 54 | / | AV |

Remark: Factor = Antenna Factor + Cable Loss – Pre-amplifier.

Note:

1. Since the peak value is less than the average limit, the average value does not reflected in the report.

6 20dB Bandwidth

6.1 TEST SETUP (BLOCK DIAGRAM OF CONFIGURATION)

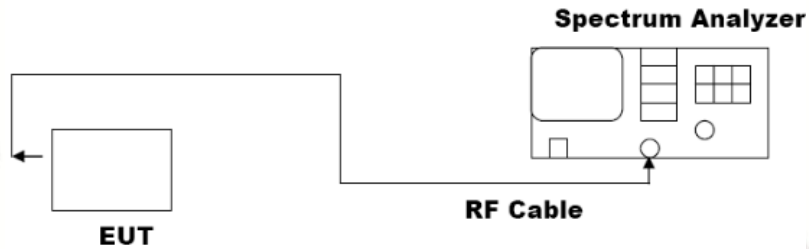

6.2 MEASUREMENT EQUIPMENT USED

Refer to Section 2.6.

6.3 TEST PROCEDURE

1. The RF output of EUT was connected to the spectrum analyzer by RF cable. The path loss was compensated to the results for each measurement.
2. Set to the maximum power setting and enable the EUT transmit continuously.
3. Make the measurement with the spectrum analyzer's resolution bandwidth (RBW) = 30 kHz. Set the Video bandwidth (VBW) = 100 kHz. In order to make an accurate measurement.
4. For 20dB Bandwidth Measurement, the spectrum analyzer's resolution bandwidth (RBW) is set 1-5% of the emission bandwidth and set the Video bandwidth (VBW) $\geq 3 * RBW$.
5. Measure and record the results in the test report.

6.4 TEST RESULT

PASS

GFSK Modulation:

| Channel | Frequency (MHz) | 20dB Bandwidth (MHz) | Result |
|---------|-----------------|----------------------|--------|
| CH00 | 2402 | 1.173 | PASS |
| CH19 | 2440 | 1.187 | PASS |
| CH39 | 2480 | 1.178 | PASS |

CH00: 2402MHz

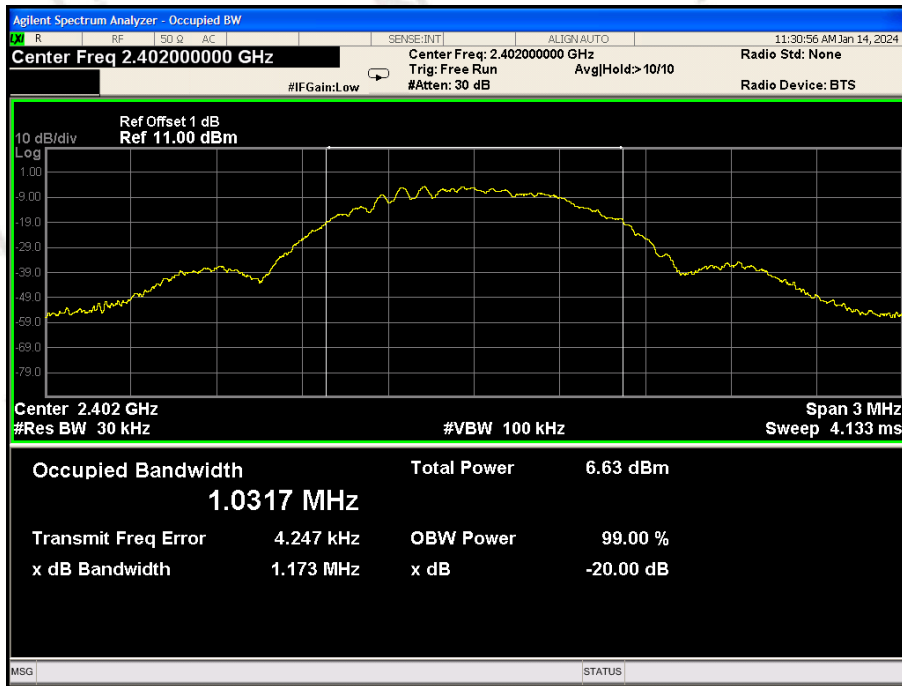



CH19: 2440MHz

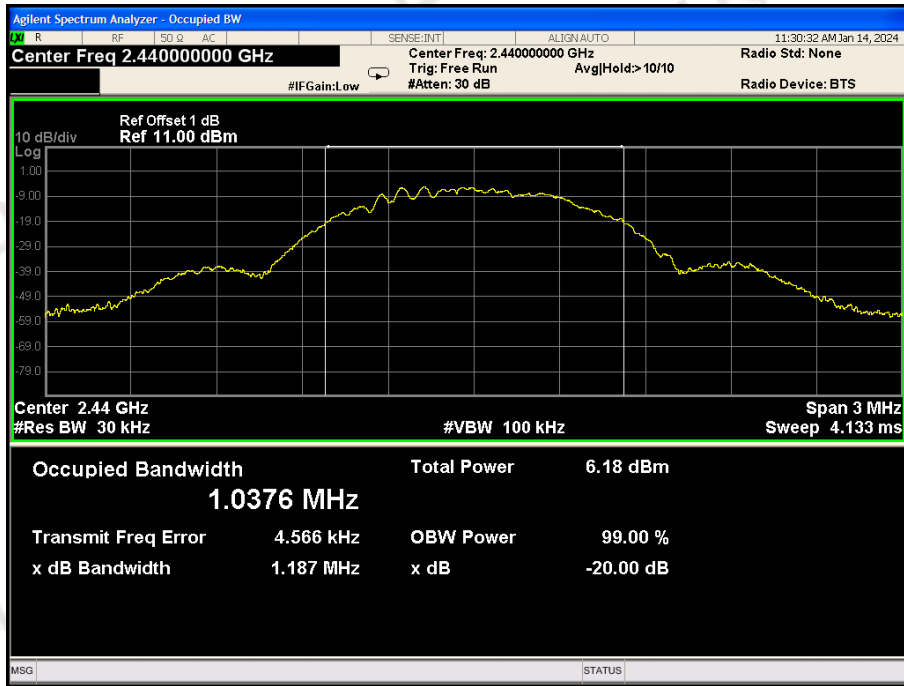

CH39: 2480MHz

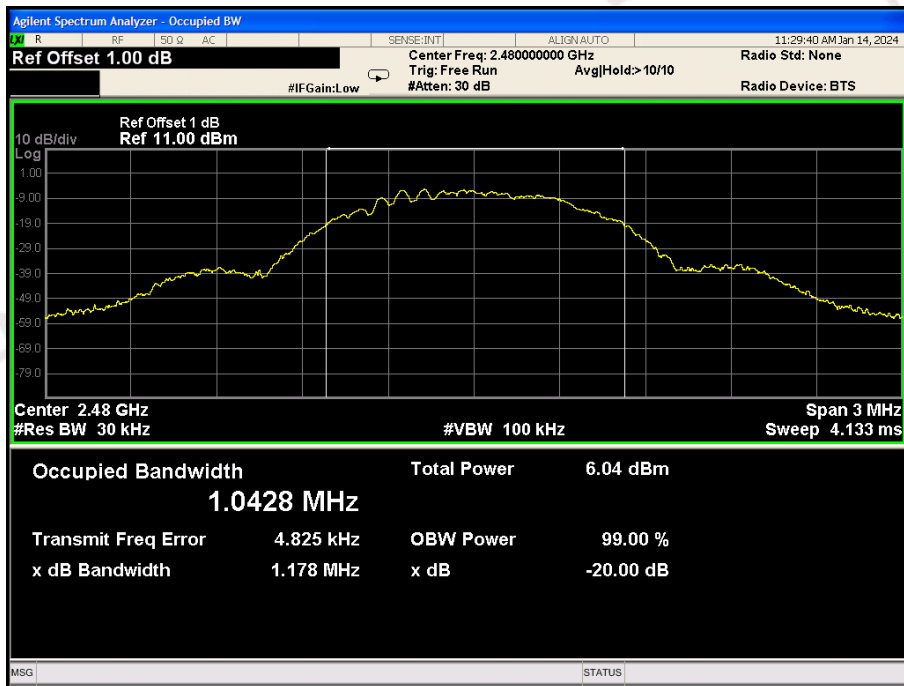

7 ANTENNA REQUIREMENT

Standard Applicable:

For intentional device, according to FCC 47 CFR Section 15.203, an intentional radiator shall be designed to ensure that no antenna other than that furnished by the responsible party shall be used with the device.

Antenna Conncted Construction

The antenna used in this product is a PCB Antenna, The directional gains of antenna used for transmitting is 0dBi.

ANTENNA:

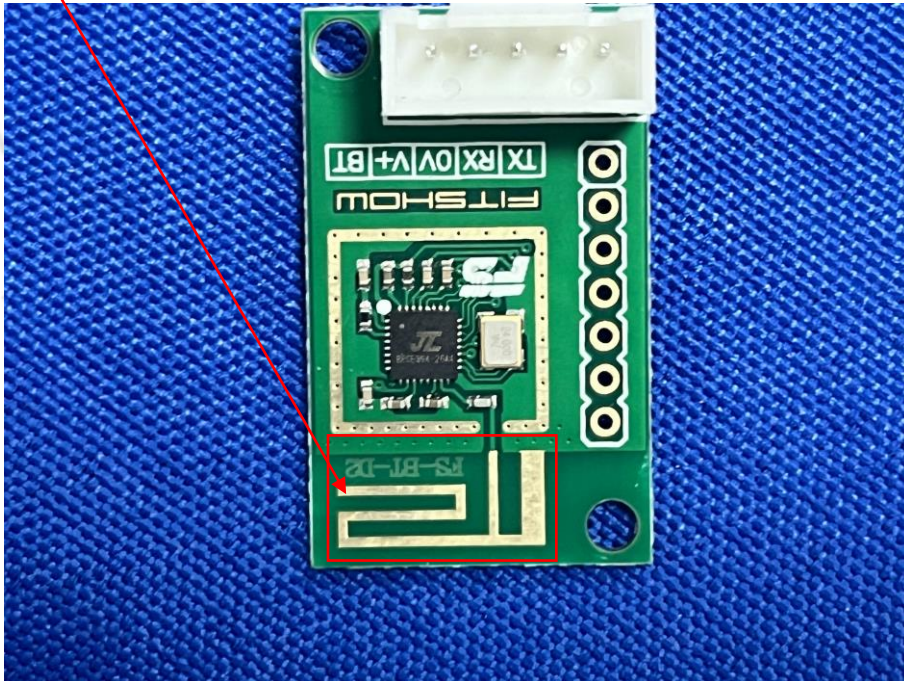

8 PHOTO OF TEST

RADIATED EMISSION

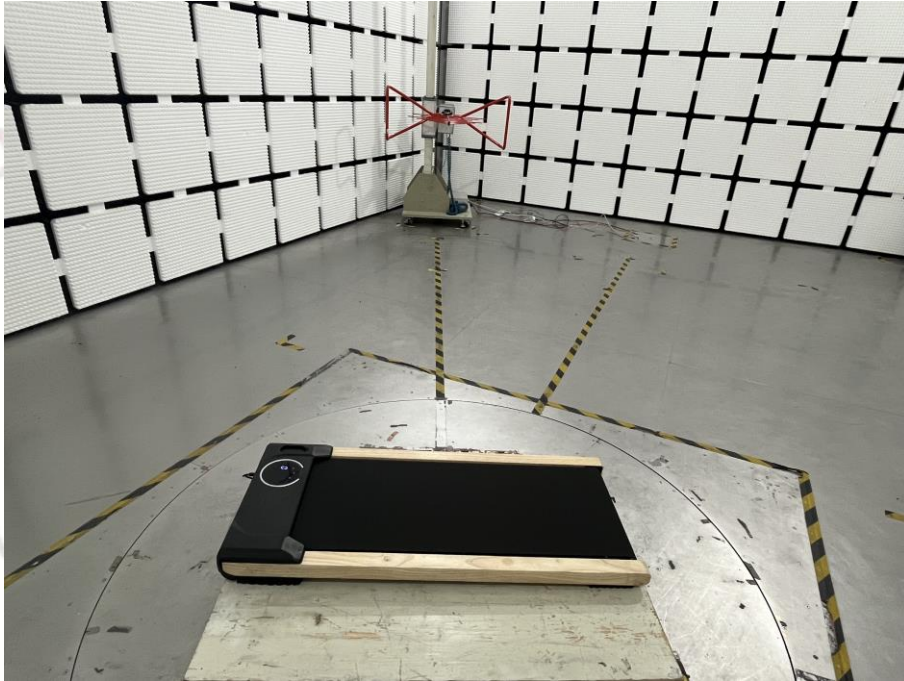

30MHz-1000MHz

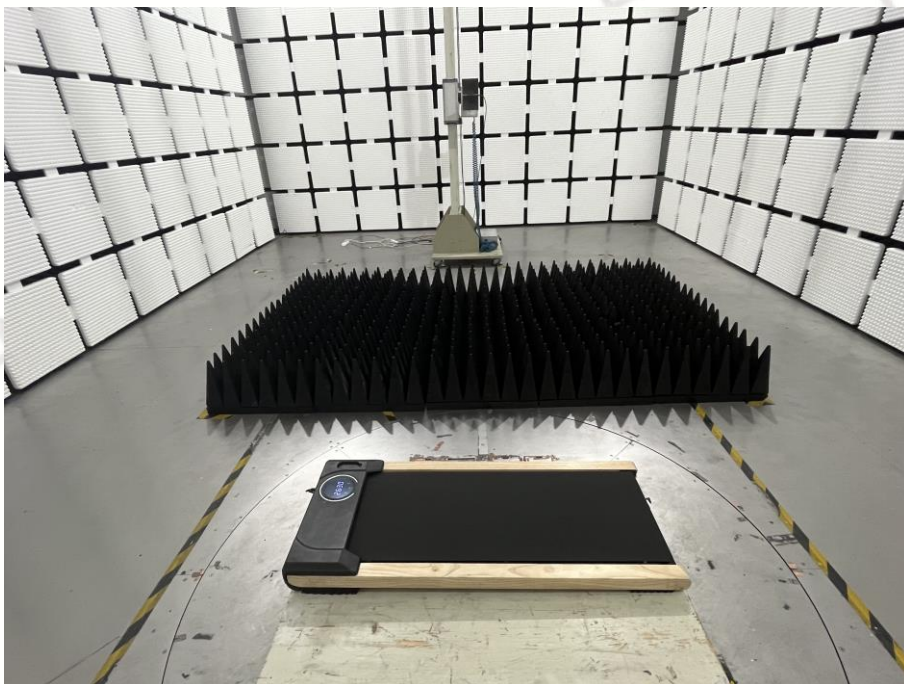

Above 1GHz

CONDUCTED EMISSION

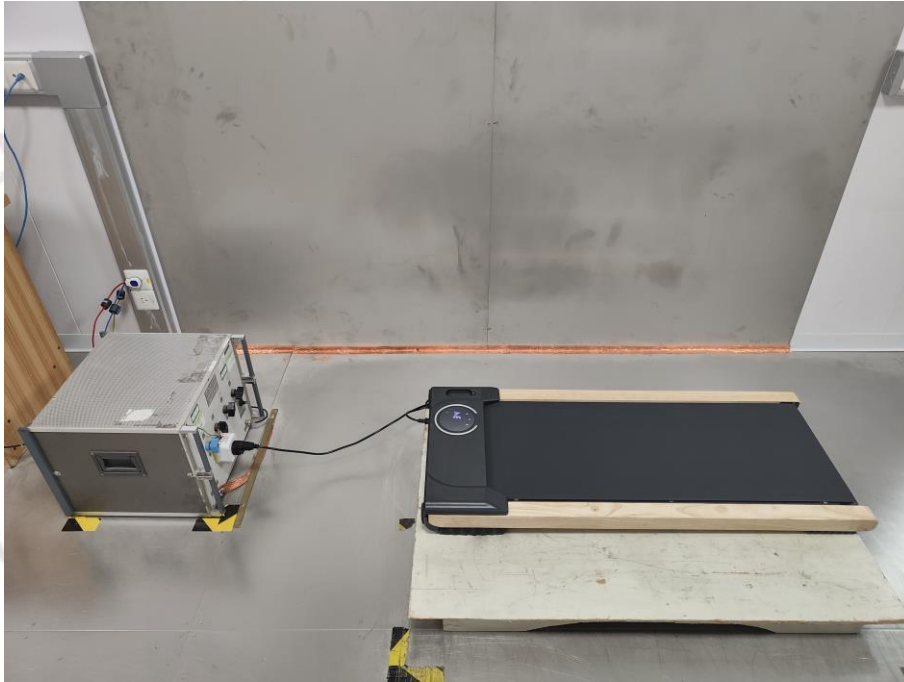

RF CONDUCTED

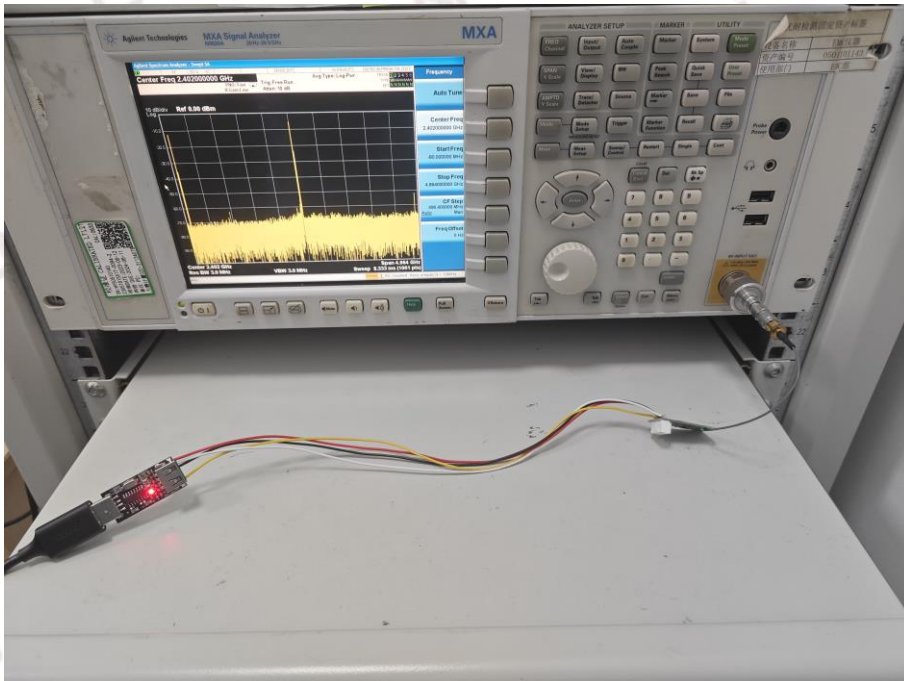

End of Report