

# Antenna Specification

## Specifications

### Summary

ITEM	SPEC.	
Model Name	ISM 2.4 GHz	
Center Frequency	2403.65 MHz 2441.65 MHz 2479.65 MHz	2.03dBi 1.58 dBi 0.49 dBi
MAX. GAIN	2.03 dBi	
Polarization	Horizontal	
Azimuth Beam Pattern	Omni-directional	
Impedance	50 $\Omega$	
Antenna Length	16.46MM	
Manufacturer:	SHENZHEN HENGSHANG ELECTRONIC CO., LTD	

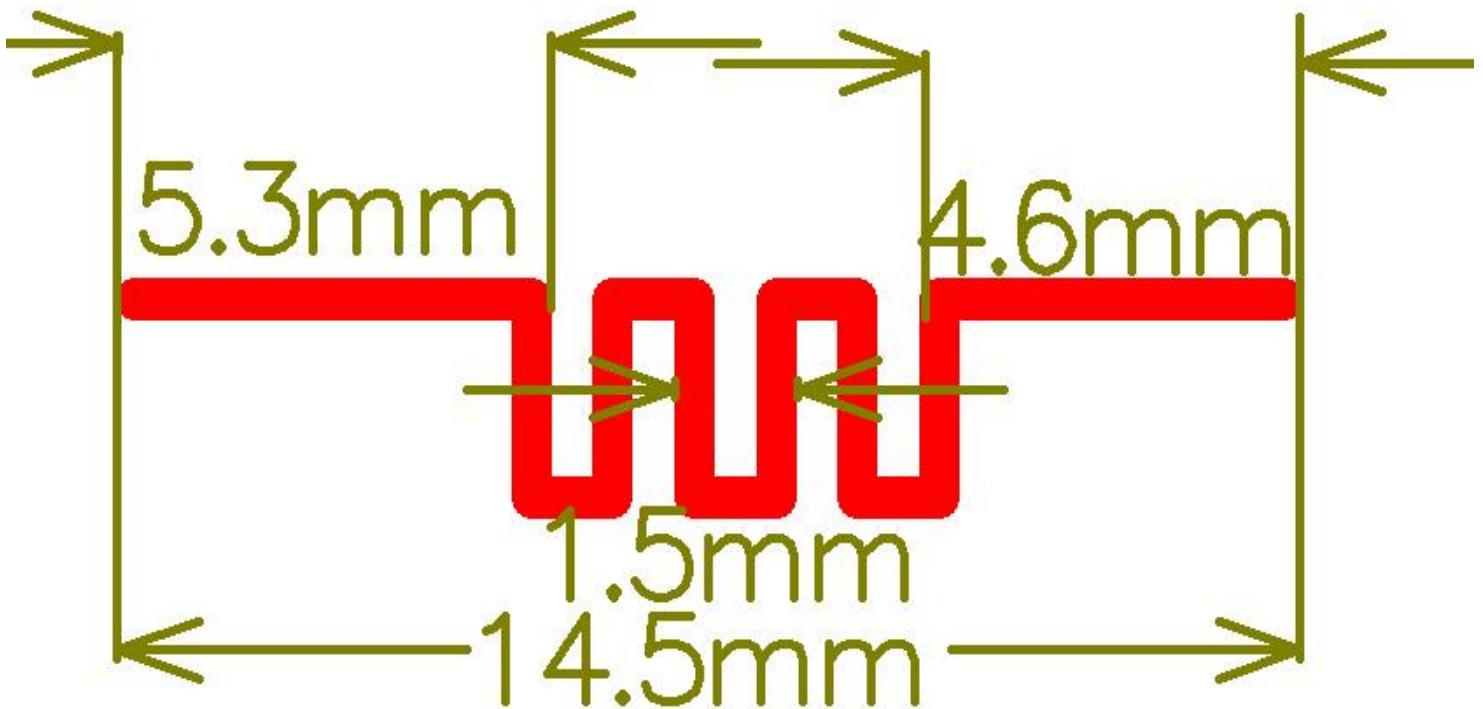

# 1. Main antenna : 2403.65 MHz

## 1.1 Horizontal

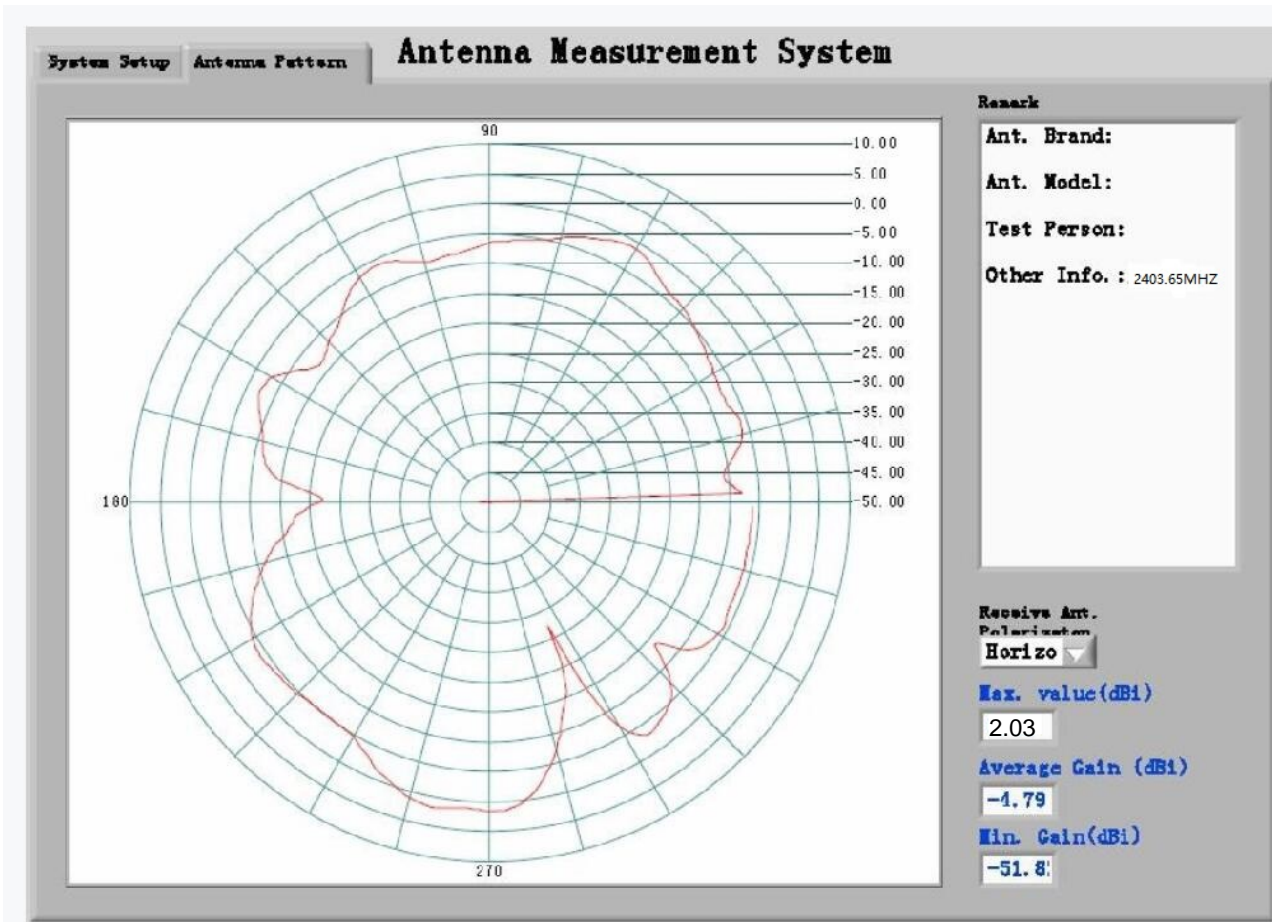

## 1.2 Vertical

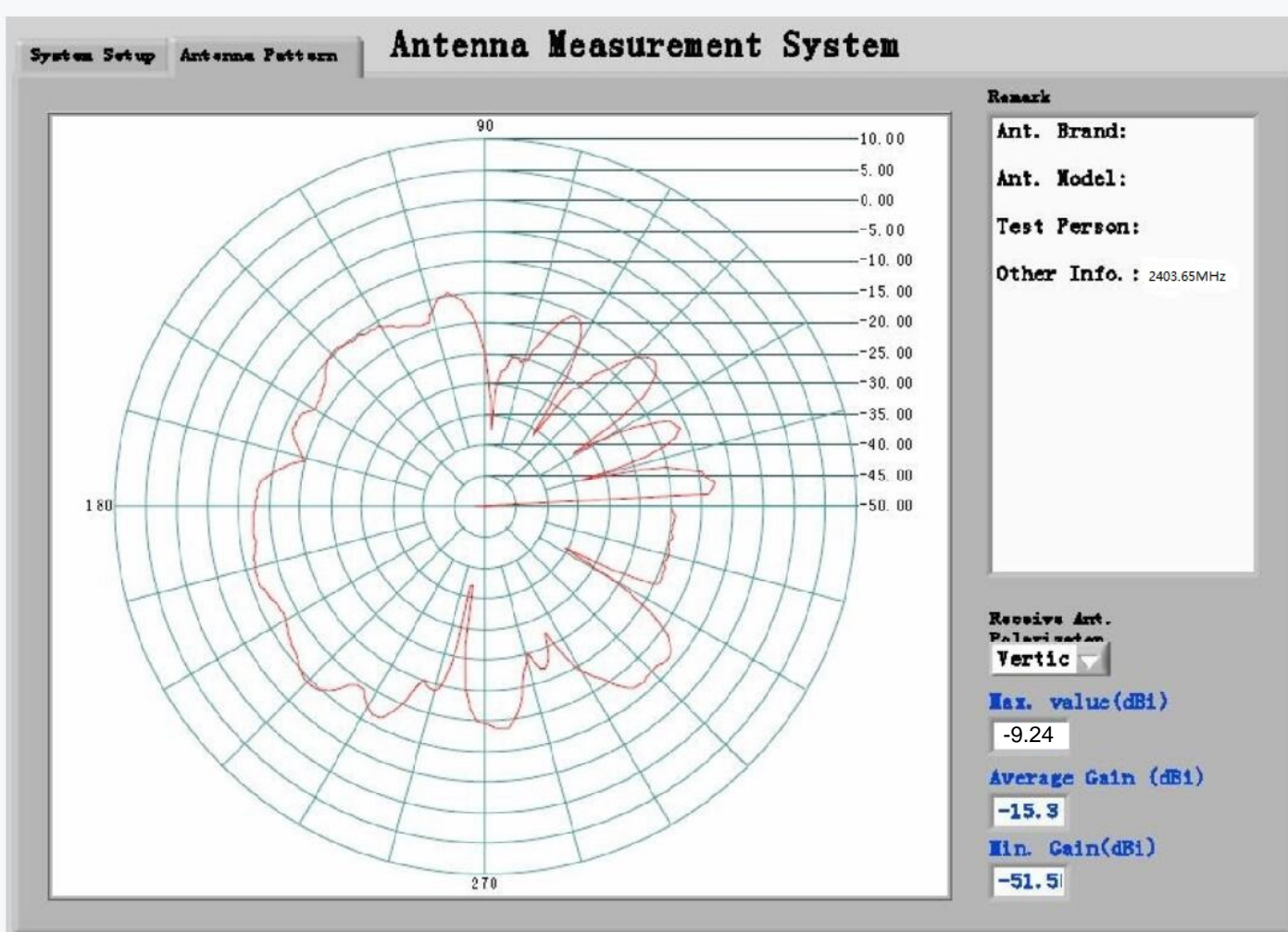

## 2. Main antenna : 2441.65 MHz

### 2.1 Horizontal

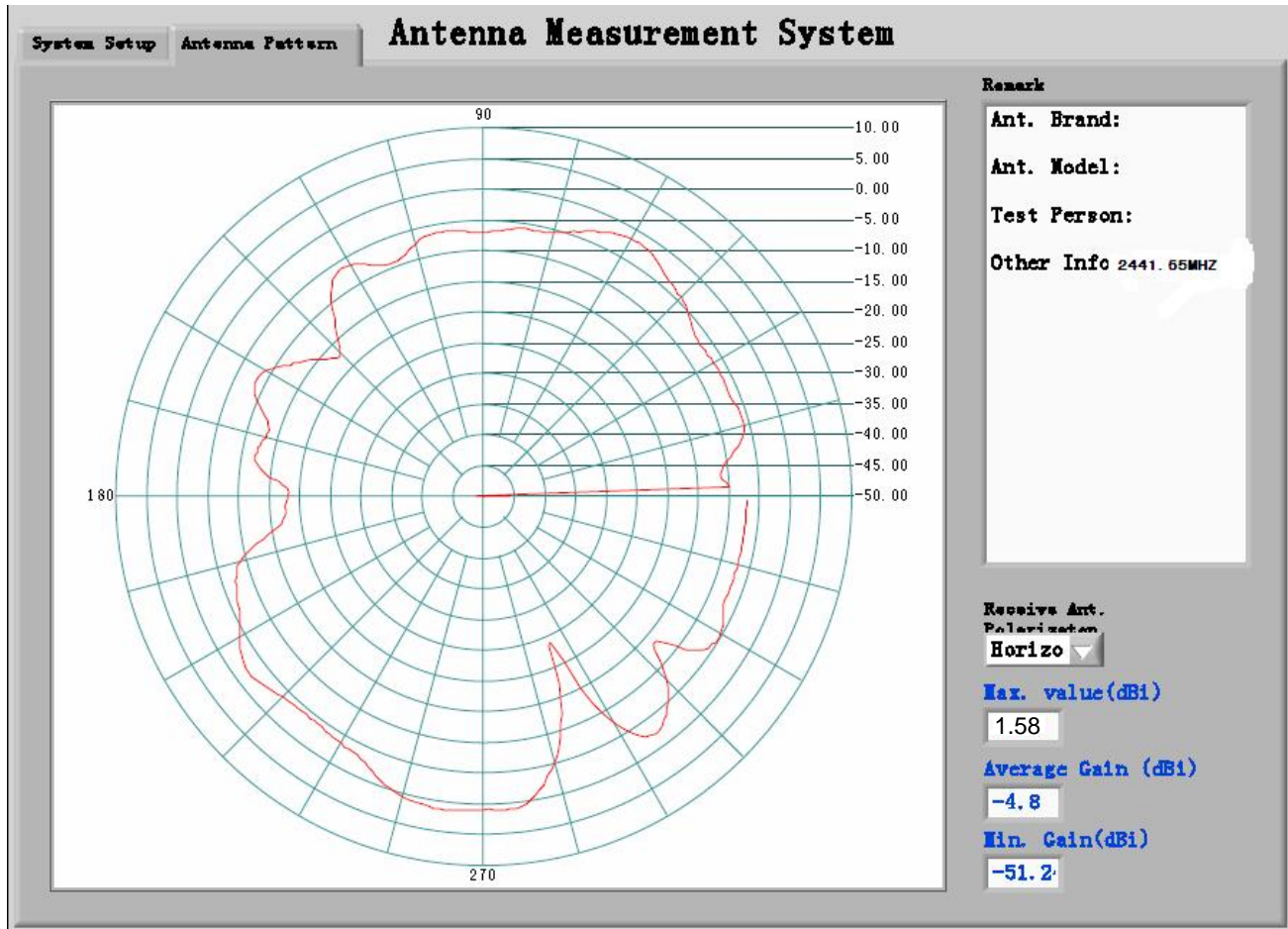

### 2.2 Vertical

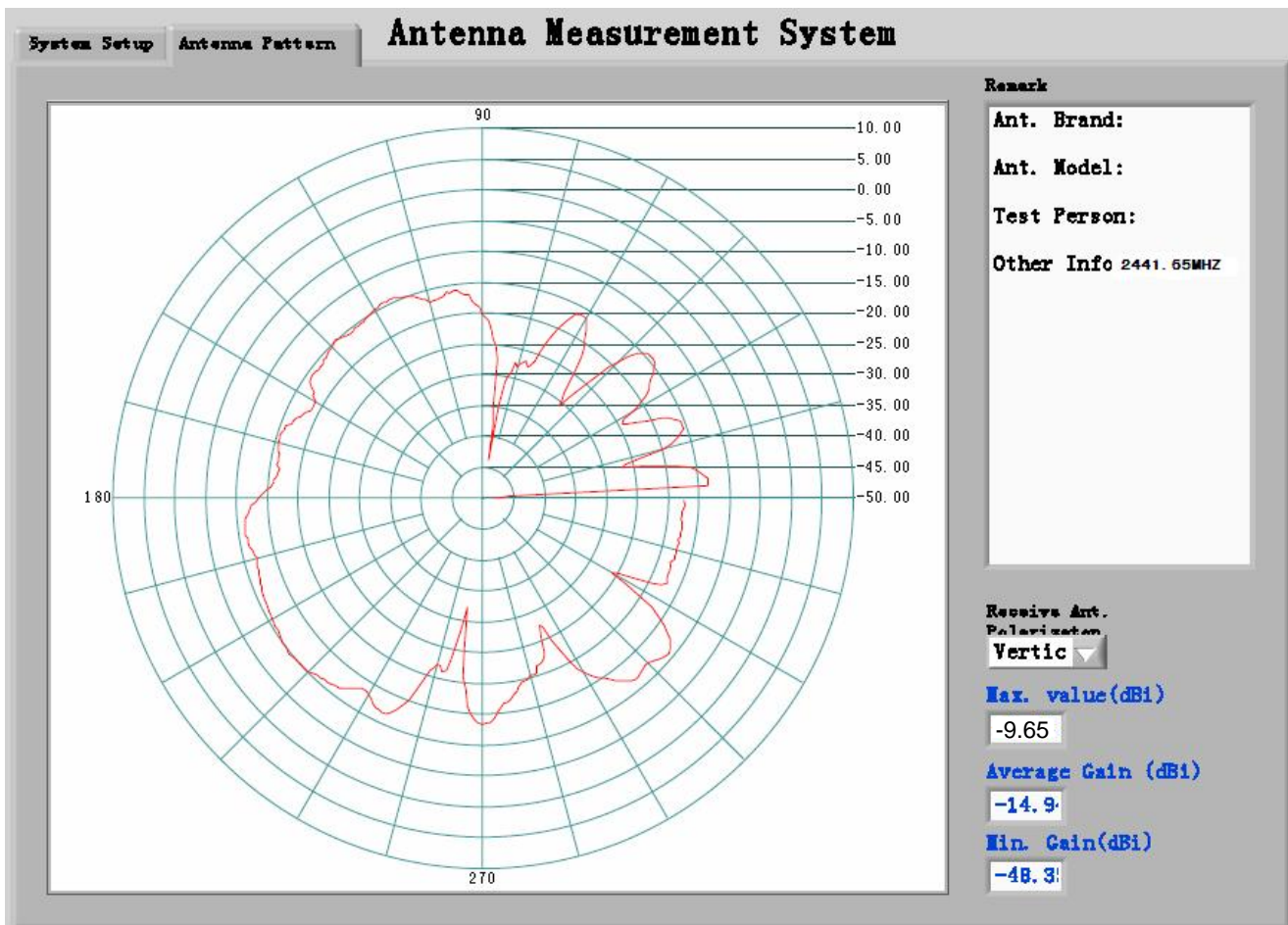

### 3.Main antenna : 2479.65 MHz

#### 3.1 Horizontal

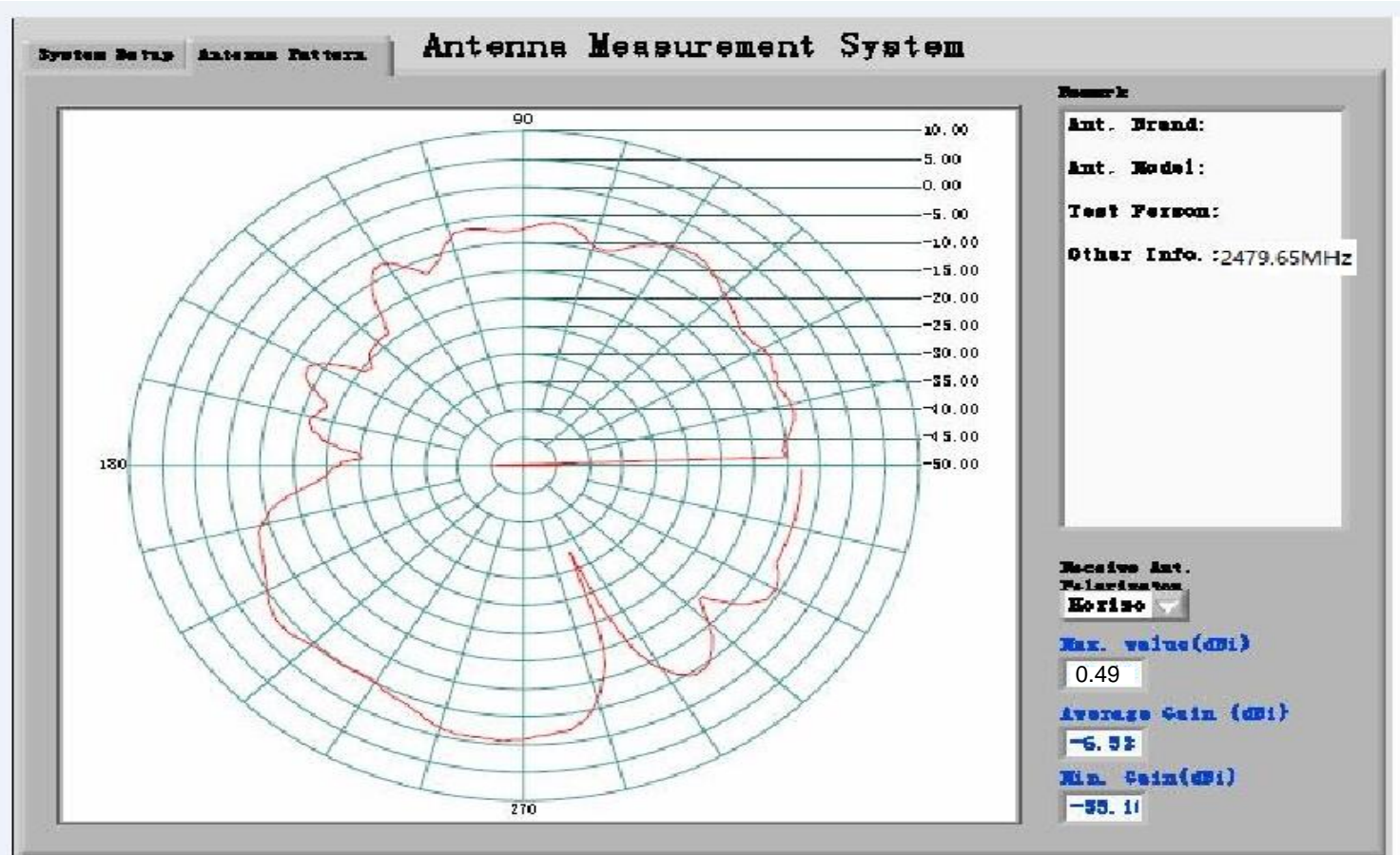

#### 3.2 Vertical

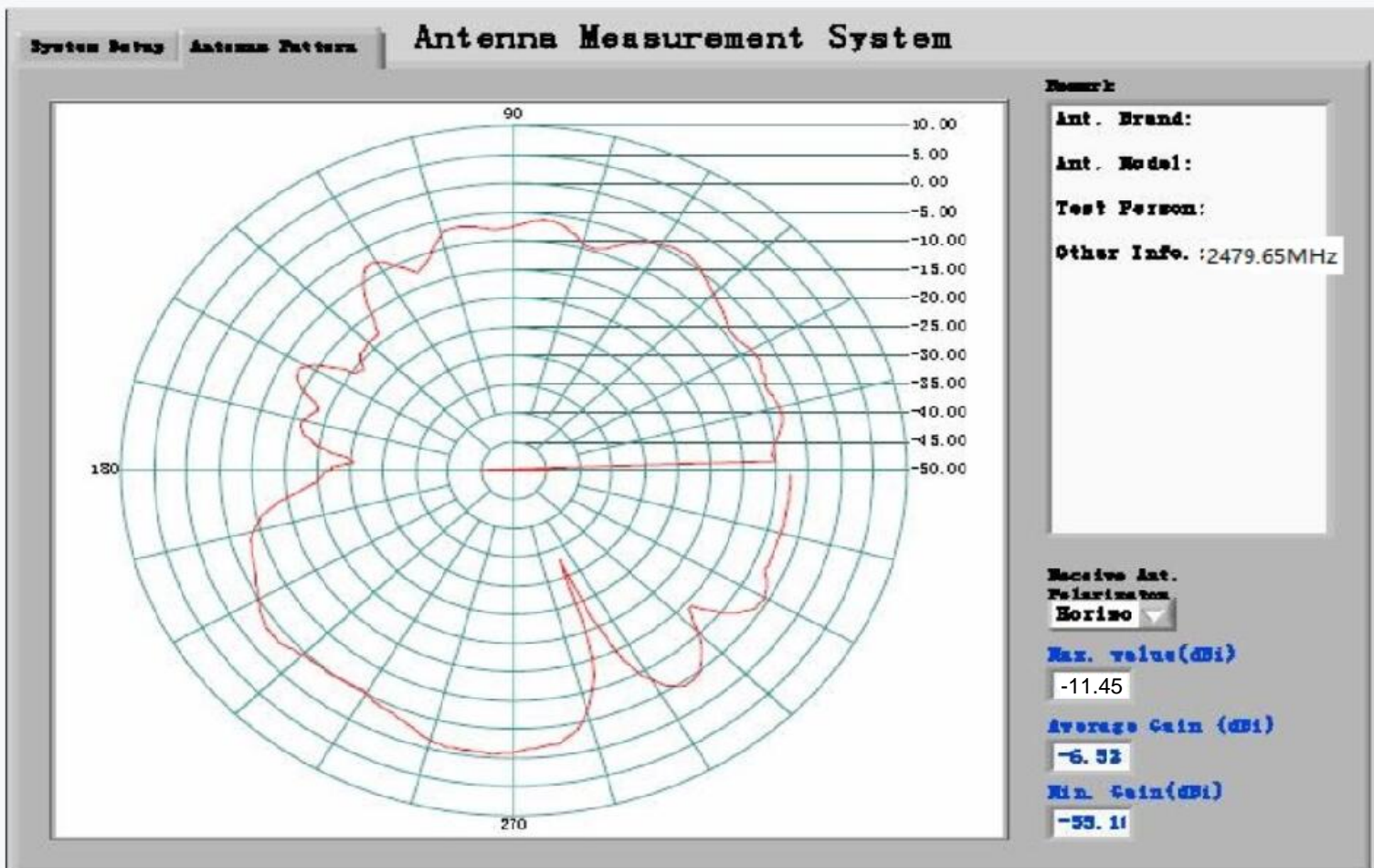

#### 4. Result

<b>Center Frequency</b>		<b>Maximum Ant Gain</b>
<b>2403.65 MHz</b>	<b>H</b>	<b>2.03 dBi</b>
	<b>V</b>	<b>-9.24 dBi</b>
<b>2441.65 MHz</b>	<b>H</b>	<b>1.61 dBi</b>
	<b>V</b>	<b>-9.65 dBi</b>
<b>2479.65 MHz</b>	<b>H</b>	<b>0.49 dBi</b>
	<b>V</b>	<b>-11.45 dBi</b>