



Shenzhen CTA Testing Technology Co., Ltd.

Room 106, Building 1, Yibaolai Industrial Park, Qiaotou Community, Fuhai Street, Bao'an District, Shenzhen, China

**TEST REPORT
FCC Rules and Regulations Part PART 15.249**

Report Reference No.....: CTA23102301101

FCC ID.....: 2BDF3-XHY-JZG01

Compiled by
(position+printed name+signature.. File administrators Zoey Cao

Zoey Cao

Supervised by
(position+printed name+signature.. Project Engineer Amy Wen

Approved by
(position+printed name+signature.. RF Manager Eric Wang

Eric Wang

Date of issue..... Oct. 31, 2023

Testing Laboratory Name Shenzhen CTA Testing Technology Co., Ltd.

Address Room 106, Building 1, Yibaolai Industrial Park, Qiaotou Community, Fuhai Street, Bao'an District, Shenzhen, China

Applicant's name Shenzhen Xinhaoyuan Technology Co,Ltd

Address 401, Building D, No. 95-1, Botanical Garden Road, Nanlian Community, Longgang Street, Longgang District, Shenzhen, China

Standard **FCC Rules and Regulations Part PART 15.249**

Shenzhen CTA Testing Technology Co., Ltd. All rights reserved.

This publication may be reproduced in whole or in part for non-commercial purposes as long as the Shenzhen CTA Testing Technology Co., Ltd. is acknowledged as copyright owner and source of the material. Shenzhen CTA Testing Technology Co., Ltd. takes no responsibility for and will not assume liability for damages resulting from the reader's interpretation of the reproduced material due to its placement and context.

Test item description virtual drum kit

Trade Mark N/A

Manufacturer Dongguan Lejun Plastic Products Co., Ltd.

Model/Type reference..... XHY-JZG01

Listed Models XHY-JZG002, XHY-JZG003, XHY-JZG004, XHY-JZG005, XHY-JZG006, XHY-JZG007, XHY-JZG008, XHY-JZG009, XHY-JZG010

Modulation GFSK

Frequency..... 2402-2480MHz

Ratings DC 3.7V From battery and DC 5.0V From external circuit

Result..... **PASS**

TEST REPORT

Equipment under Test : virtual drum kit

Model /Type : XHY-JZG01

Listed Models : XHY-JZG002, XHY-JZG003, XHY-JZG004, XHY-JZG005,
XHY-JZG006, XHY-JZG007, XHY-JZG008, XHY-JZG009,
XHY-JZG010

Applicant : **Shenzhen Xinhaoyuan Technology Co,Ltd**

Address : 401, Building D, No. 95-1, Botanical Garden Road, Nanlian
Community, Longgang Street, Longgang District, Shenzhen,
China

Manufacturer : **Dongguan Lejun Plastic Products Co., Ltd.**

Address : Room 501, Building 4, No. 1 Senhu Second Road, Fenggang
Town, Dongguan City, Guangdong Province, China

Test Result:	PASS
---------------------	-------------

The test report merely corresponds to the test sample.
It is not permitted to copy extracts of these test result without the written permission of the test laboratory.

Contents

1.	<u>..TEST STANDARDS</u>	4
2.	<u>..SUMMARY</u>	5
2.1.	General Remarks	5
2.2.	Product Description	5
2.3.	Equipment Under Test	5
2.4.	Short description of the Equipment under Test (EUT)	5
2.5.	EUT operation mode	5
2.6.	Block Diagram of Test Setup	6
2.7.	Modifications	6
3.	<u>..TEST ENVIRONMENT</u>	7
3.1.	Address of the test laboratory	7
3.2.	Test Facility	7
3.3.	Environmental conditions	7
3.4.	Summary of measurement results	8
3.5.	Statement of the measurement uncertainty	8
3.6.	Equipments Used during the Test	8
4.	<u>..TEST CONDITIONS AND RESULTS</u>	10
4.1.	AC Power Conducted Emission	10
4.2.	Radiated Emission and Band Edges	13
4.3.	20dB Bandwidth Measurement	19
4.4.	Antenna Requirement.....	21
5.	<u>..TEST SETUP PHOTOS OF THE EUT</u>	22
6.	<u>..TEST PHOTOS OF THE EUT</u>	23

1. TEST STANDARDS

The tests were performed according to following standards:

FCC Rules Part 15.249: Operation within the bands 902 - 928 MHz, 2400 - 2483.5 MHz, 5725 - 5875 MHz, and 24.0 - 24.25 GHz.

ANSI C63.10:2013 : American National Standard for Testing Unlicensed Wireless Devices

ANSI C63.4: 2014: –American National Standard for Methods of Measurement of Radio-Noise Emissions from Low-Voltage Electrical and Electronic Equipment in the Range of 9 kHz to 40GHz
Range of 9 kHz to 40GHz

2. SUMMARY

2.1. General Remarks

Date of receipt of test sample	:	Oct. 23, 2023
Testing commenced on	:	Oct. 23, 2023
Testing concluded on	:	Oct. 31, 2023

2.2. Product Description

Name of EUT	virtual drum kit
Model Number	XHY-JZG01
Power Rating	DC 3.7V From battery and DC 5.0V From external circuit
Adapter information (Auxiliary test supplied by test Lab)	Model: HW-120100C02 Input: AC 200-240V 50/60Hz 0.5A Output: DC 12.0V 1.0A
Sample ID:	CTA231023011-1#(Engineer sample) CTA231023011-2#(Normal sample)
Operation frequency	2402-2480MHz
Modulation	GFSK
Antenna Type	Internal Antenna
Antenna Gain	0.83 dBi

2.3. Equipment Under Test

Power supply system utilised

Power supply voltage	:	<input type="radio"/> 230V / 50 Hz	<input type="radio"/> 120V / 60Hz
		<input type="radio"/> 12 V DC	<input type="radio"/> 24 V DC
		<input checked="" type="radio"/> Other (specified in blank below)	

DC 3.7V From battery and DC 5.0V From external circuit

2.4. Short description of the Equipment under Test (EUT)

This is a virtual drum kit

For more details, refer to the user's manual of the EUT.

2.5. EUT operation mode

The Applicant use Key to control the EUT for staying in continuous transmitting and receiving mode for testing. There is 3 channels provided to the EUT. Channel Low, Mid and High was selected to test.

Channel	Frequency (MHz)
01	2402
02	2426
03	2480

Test frequency:

Channel	Frequency (MHz)
Low	2402
Mid	2426
High	2480

2.6. Block Diagram of Test Setup

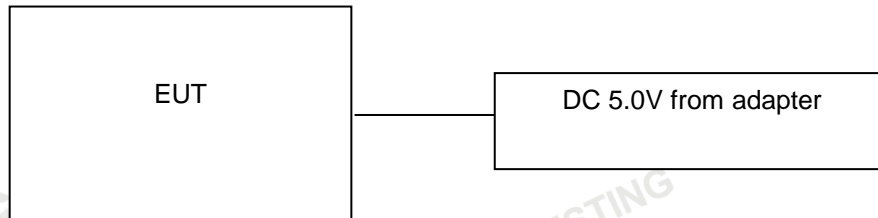

2.7. Modifications

No modifications were implemented to meet testing criteria.

3. TEST ENVIRONMENT

3.1. Address of the test laboratory

Shenzhen CTA Testing Technology Co., Ltd.

Room 106, Building 1, Yibaolai Industrial Park, Qiaotou Community, Fuhai Street, Bao'an District, Shenzhen, China

3.2. Test Facility

The test facility is recognized, certified, or accredited by the following organizations:

FCC-Registration No.: 517856 Designation Number: CN1318

Shenzhen CTA Testing Technology Co., Ltd. has been listed on the US Federal Communications Commission list of test facilities recognized to perform electromagnetic emissions measurements.

Industry Canada Registration Number. Is: 27890 CAB identifier: CN0127

The Laboratory has been registered by Certification and Engineering Bureau of Industry Canada for radio equipment testing.

A2LA-Lab Cert. No.: 6534.01

Shenzhen CTA Testing Technology Co., Ltd. has been listed by American Association for Laboratory Accreditation to perform electromagnetic emission measurement.

The 3m-Semi anechoic test site fulfils CISPR 16-1-4 according to ANSI C63.10 and CISPR 16-1-4:2010.

3.3. Environmental conditions

During the measurement the environmental conditions were within the listed ranges:

Radiated Emission:

Temperature:	23 ° C
Humidity:	48 %
Atmospheric pressure:	950-1050mbar

AC Main Conducted testing:

Temperature:	24 ° C
Humidity:	45 %
Atmospheric pressure:	950-1050mbar

Conducted testing:

Temperature:	24 ° C
Humidity:	45 %
Atmospheric pressure:	950-1050mbar

3.4. Summary of measurement results

FCC PART 15.249		
FCC Part 15.249(a)	Field Strength of Fundamental	PASS
FCC Part 15.209	Spurious Emission	PASS
FCC Part 15.209	Band edge	PASS
FCC Part 15.215(c)	20dB bandwidth	PASS
FCC Part 15.207	Conducted Emission	PASS
FCC Part 15.203	Antenna Requirement	PASS

3.5. Statement of the measurement uncertainty

Measurement Uncertainty

Conducted Emission Expanded Uncertainty = 2.23dB, k=2

Radiated emission expanded uncertainty(9kHz-30MHz) = 3.08dB, k=2

Radiated emission expanded uncertainty(30MHz-1000MHz) = 4.42dB, k=2

Radiated emission expanded uncertainty(Above 1GHz) = 4.06dB, k=2

3.6. Equipments Used during the Test

Test Equipment	Manufacturer	Model No.	Equipment No.	Calibration Date	Calibration Due Date
LISN	R&S	ENV216	CTA-308	2023/08/02	2024/08/01
LISN	R&S	ENV216	CTA-314	2023/08/02	2024/08/01
EMI Test Receiver	R&S	ESPI	CTA-307	2023/08/02	2024/08/01
EMI Test Receiver	R&S	ESCI	CTA-306	2023/08/02	2024/08/01
Spectrum Analyzer	Agilent	N9020A	CTA-301	2023/08/02	2024/08/01
Spectrum Analyzer	R&S	FSP	CTA-337	2023/08/02	2024/08/01
Vector Signal generator	Agilent	N5182A	CTA-305	2023/08/02	2024/08/01
Analog Signal Generator	R&S	SML03	CTA-304	2023/08/02	2024/08/01
Universal Radio Communication	CMW500	R&S	CTA-302	2023/08/02	2024/08/01
Temperature and humidity meter	Chigo	ZG-7020	CTA-326	2023/08/02	2024/08/01
Ultra-Broadband Antenna	Schwarzbeck	VULB9163	CTA-310	2023/10/17	2024/10/16
Horn Antenna	Schwarzbeck	BBHA 9120D	CTA-309	2023/10/13	2024/10/12
Loop Antenna	Zhinan	ZN30900C	CTA-311	2023/10/17	2024/10/16
Horn Antenna	Beijing Hangwei Dayang	OBH100400	CTA-336	2021/08/07	2024/08/06
Amplifier	Schwarzbeck	BBV 9745	CTA-312	2023/08/02	2024/08/01
Amplifier	Taiwan chengyi	EMC051845B	CTA-313	2023/08/02	2024/08/01

Directional coupler	NARDA	4226-10	CTA-303	2023/08/02	2024/08/01
High-Pass Filter	XingBo	XBLBQ-GTA18	CTA-402	2023/08/02	2024/08/01
High-Pass Filter	XingBo	XBLBQ-GTA27	CTA-403	2023/08/02	2024/08/01
Automated filter bank	Tonscend	JS0806-F	CTA-404	2023/08/02	2024/08/01
Power Sensor	Agilent	U2021XA	CTA-405	2023/08/02	2024/08/01
Amplifier	Schwarzbeck	BBV9719	CTA-406	2023/08/02	2024/08/01

4. TEST CONDITIONS AND RESULTS

4.1. AC Power Conducted Emission

TEST CONFIGURATION

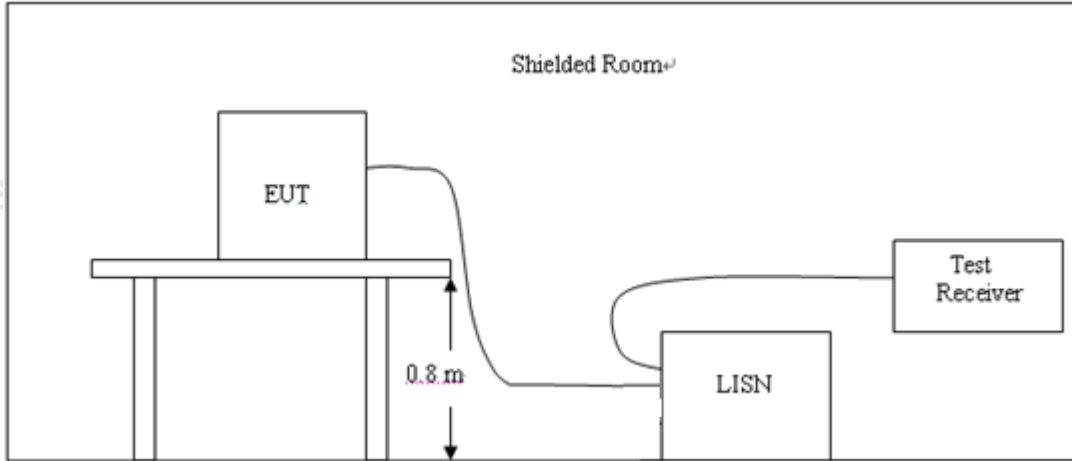

TEST PROCEDURE

- 1, The equipment was set up as per the test configuration to simulate typical actual usage per the user's manual. The EUT is a tabletop system, a wooden table with a height of 0.8 meters is used and is placed on the ground plane as per ANSI C63.10.
- 2, Support equipment, if needed, was placed as per ANSI C63.10.
- 3, All I/O cables were positioned to simulate typical actual usage as per ANSI C63.10.
- 4, If a EUT received DC power from the USB Port of Notebook PC, the PC's adapter received power through a Line Impedance Stabilization Network (LISN) which supplied power source and was grounded to the ground plane.
- 5, All support equipments received AC power from a second LISN, if any.
- 6, The EUT test program was started. Emissions were measured on each current carrying line of the EUT using a spectrum Analyzer / Receiver connected to the LISN powering the EUT. The LISN has two monitoring points: Line 1 (Hot Side) and Line 2 (Neutral Side). Two scans were taken: one with Line 1 connected to Analyzer / Receiver and Line 2 connected to a 50 ohm load; the second scan had Line 1 connected to a 50 ohm load and Line 2 connected to the Analyzer / Receiver.
- 7, Analyzer / Receiver scanned from 150 KHz to 30MHz for emissions in each of the test modes.

AC Power Conducted Emission Limit

For intentional device, according to § 15.207(a) AC Power Conducted Emission Limits is as following :

Frequency range (MHz)	Limit (dBuV)	
	Quasi-peak	Average
0.15-0.5	66 to 56*	56 to 46*
0.5-5	56	46
5-30	60	50

* Decreases with the logarithm of the frequency.

TEST RESULTS

Remark:

1. BLE 1Mbps was tested at Low, Middle, and High channel; only the worst result of BLE 1Mbps High channel was reported as below:
2. Both 120 VAC, 50/60 Hz and 240 VAC, 50/60 Hz power supply have been tested, only the worst result of 120 VAC, 60 Hz was reported as below:

Power supply:	DC 5.0V from Adapter AC 120V/60Hz	Polarization	L
---------------	-----------------------------------	--------------	---

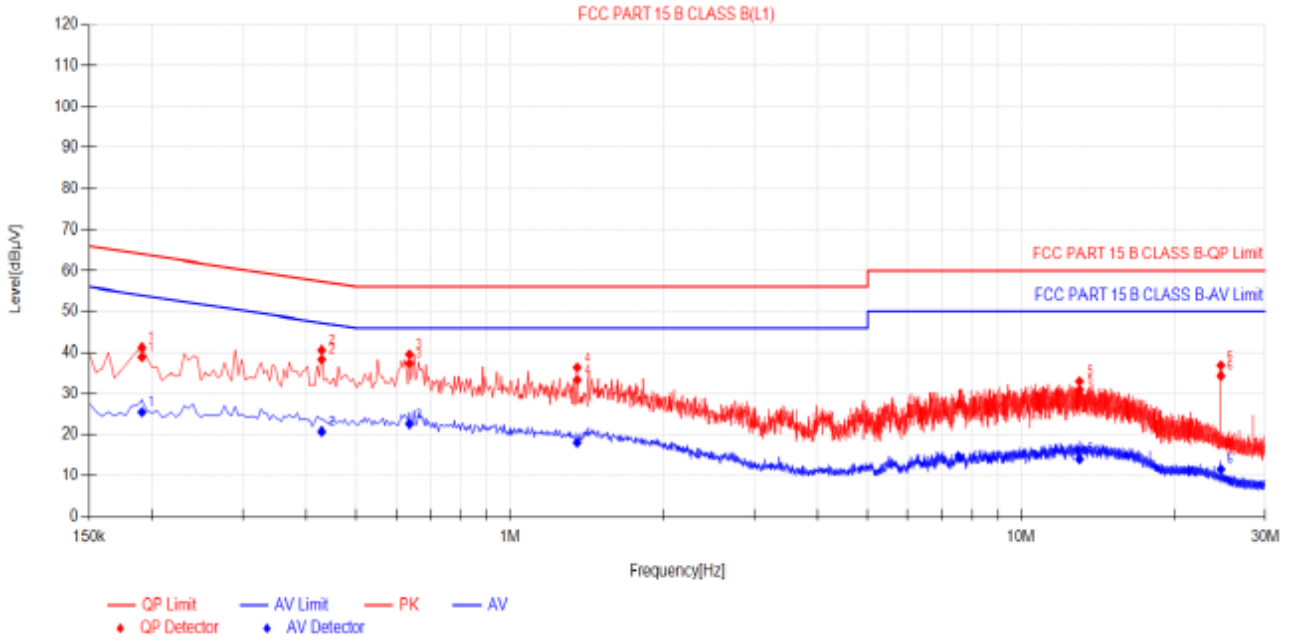

Final Data List											
NO.	Freq. [MHz]	Factor [dB]	QP Reading [dBµV]	QP Value [dBµV]	QP Limit [dBµV]	QP Margin [dB]	AV Reading [dBµV]	AV Value [dBµV]	AV Limit [dBµV]	AV Margin [dB]	Verdict
1	0.1905	10.05	28.88	38.93	64.01	25.08	15.48	25.51	54.01	28.50	PASS
2	0.429	9.91	28.43	38.34	57.27	18.93	10.85	20.76	47.27	26.51	PASS
3	0.636	10.00	27.32	37.32	56.00	18.68	12.55	22.55	48.00	23.45	PASS
4	1.356	9.90	23.50	33.40	56.00	22.60	8.14	18.04	48.00	27.96	PASS
5	13.029	10.29	20.82	30.91	60.00	29.09	3.79	14.08	50.00	35.92	PASS
6	24.54	10.50	23.89	34.39	60.00	25.61	1.05	11.55	50.00	38.45	PASS

- Note:1). QP Value (dBµV) = QP Reading (dBµV) + Factor (dB)
 2). Factor (dB) = insertion loss of LISN (dB) + Cable loss (dB)
 3). QPMargin (dB) = QP Limit (dBµV) - QP Value (dBµV)
 4). AVMargin (dB) = AV Limit (dBµV) - AV Value (dBµV)

Power supply:	DC 5.0V from Adapter AC 120V/60Hz	Polarization	N
---------------	-----------------------------------	--------------	---

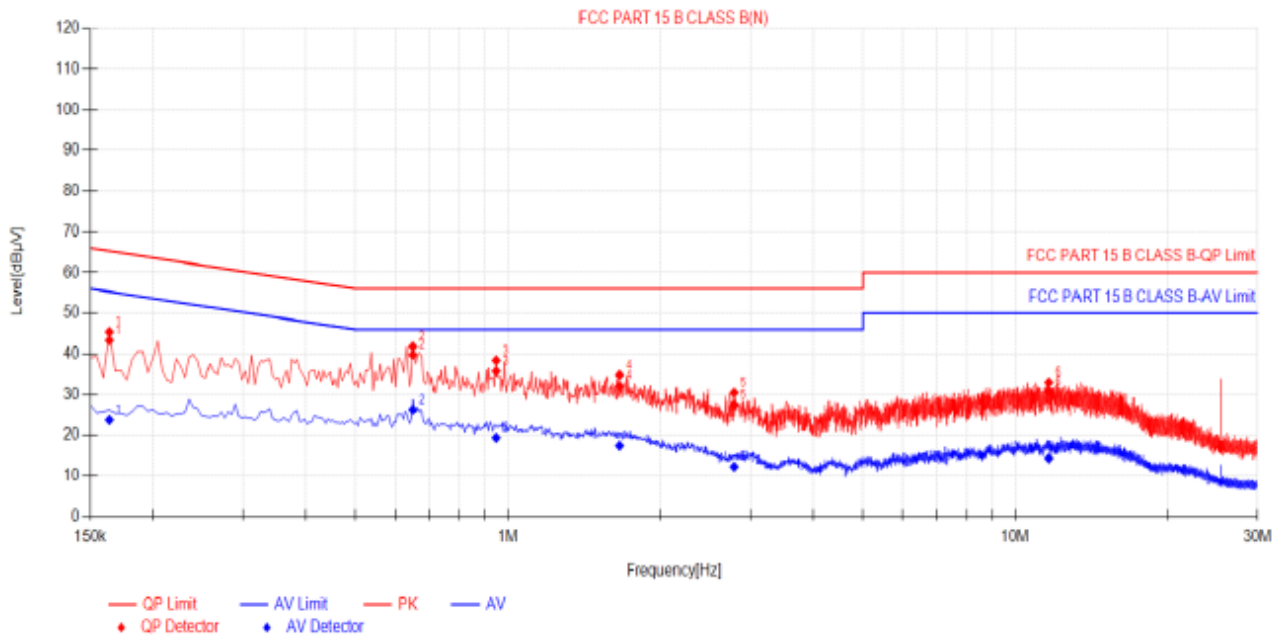

Final Data List											
NO.	Freq. [MHz]	Factor [dB]	QP Reading[dB µV]	QP Value [dBµV]	QP Limit [dBµV]	QP Margin [dB]	AV Reading [dBµV]	AV Value [dBµV]	AV Limit [dBµV]	AV Margin [dB]	Verdict
1	0.1635	10.05	33.28	43.33	65.28	21.95	13.70	23.75	55.28	31.53	PASS
2	0.6495	10.11	29.64	39.75	56.00	16.25	16.21	26.32	46.00	19.68	PASS
3	0.9465	10.12	25.61	35.73	56.00	20.27	9.29	19.41	46.00	26.59	PASS
4	1.6575	10.15	22.00	32.15	56.00	23.85	7.27	17.42	46.00	28.58	PASS
5	2.787	10.19	17.32	27.51	56.00	28.49	2.08	12.27	46.00	33.73	PASS
6	11.652	10.41	20.44	30.85	60.00	29.15	3.96	14.37	50.00	35.63	PASS

- Note:1). QP Value (dBµV) = QP Reading (dBµV) + Factor (dB)
 2). Factor (dB) = insertion loss of LISN (dB) + Cable loss (dB)
 3). QPMargin(dB) = QP Limit (dBµV) - QP Value (dBµV)
 4). AVMargin(dB) = AV Limit (dBµV) - AV Value (dBµV)

4.2. Radiated Emission and Band Edges

TEST CONFIGURATION

Frequency range 9 KHz – 30MHz

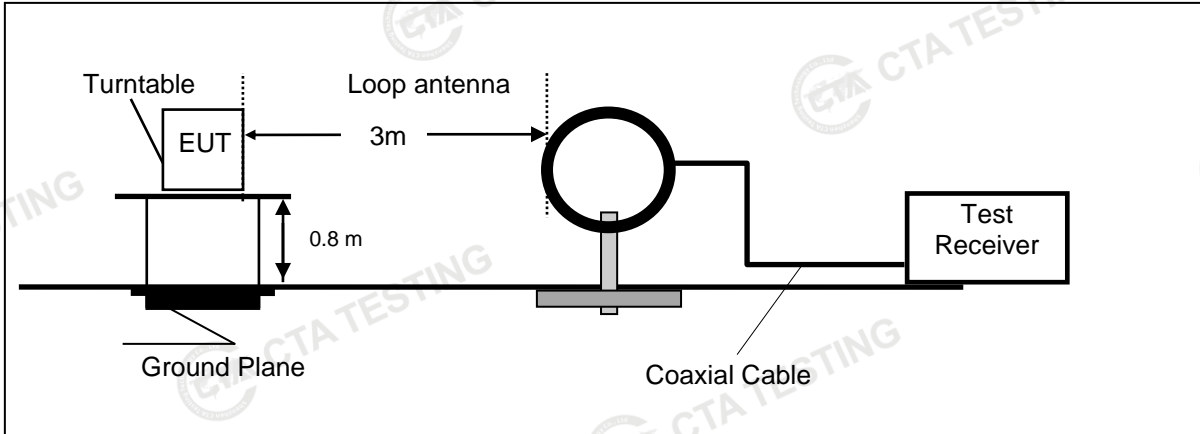

Frequency range 30MHz – 1000MHz

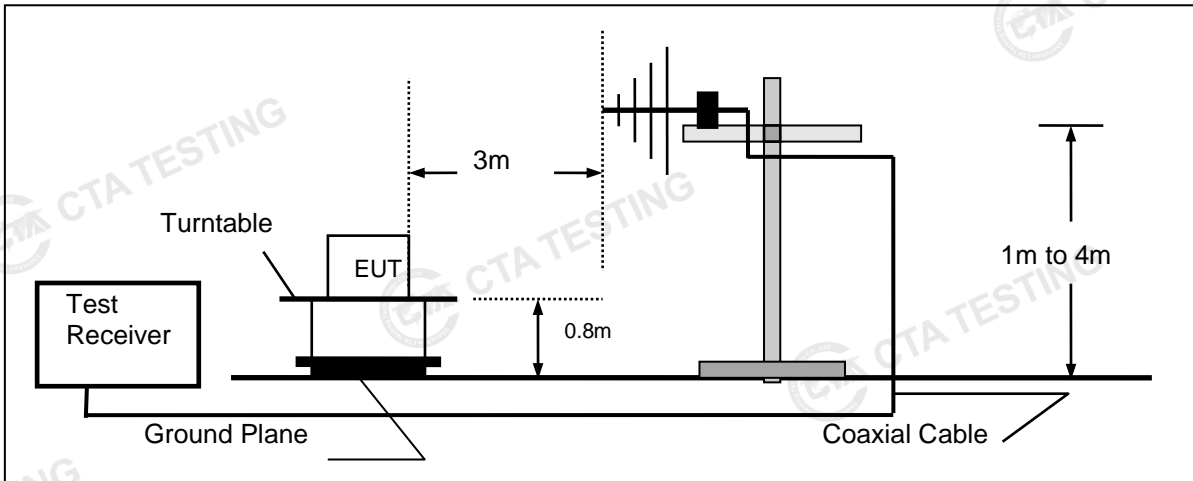

Frequency range above 1GHz-25GHz

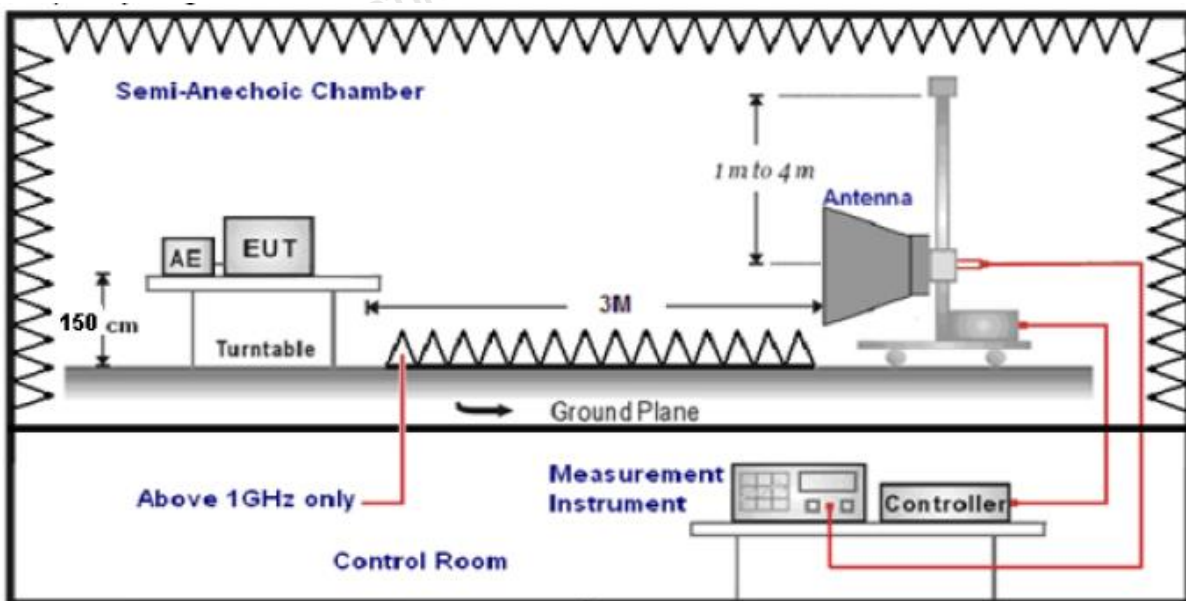

TEST PROCEDURE

1. The EUT was placed on a turn table which is 0.8m above ground plane when testing frequency range 9 KHz –25GHz.
2. Maximum procedure was performed by raising the receiving antenna from 1m to 4m and rotating the turn table from 0°C to 360°C to acquire the highest emissions from EUT.
3. And also, each emission was to be maximized by changing the polarization of receiving antenna both horizontal and vertical.
4. Repeat above procedures until all frequency measurements have been completed.
5. The EUT minimum operation frequency was 26MHz and maximum operation frequency was 1910MHz.so radiated emission test frequency band from 9KHz to 25GHz.
6. The distance between test antenna and EUT as following table states:

Test Frequency range	Test Antenna Type	Test Distance
9KHz-30MHz	Active Loop Antenna	3
30MHz-1GHz	Ultra-Broadband Antenna	3
1GHz-18GHz	Double Ridged Horn Antenna	3
18GHz-25GHz	Horn Antenna	1

7. Setting test receiver/spectrum as following table states:

Test Frequency range	Test Receiver/Spectrum Setting	Detector
9KHz-150KHz	RBW=200Hz/VBW=3KHz, Sweep time=Auto	QP
150KHz-30MHz	RBW=9KHz/VBW=100KHz, Sweep time=Auto	QP
30MHz-1GHz	RBW=120KHz/VBW=1000KHz, Sweep time=Auto	QP
1GHz-40GHz	Peak Value: RBW=1MHz/VBW=3MHz, Sweep time=Auto Average Value: RBW=1MHz/VBW=10Hz, Sweep time=Auto	Peak

Field Strength Calculation

The field strength is calculated by adding the Antenna Factor and Cable Factor and subtracting the Amplifier Gain and Duty Cycle Correction Factor(if any) from the measured reading. The basic equation with a sample calculation is as follows:

FS = RA + AF + CL - AG

Where FS = Field Strength	CL = Cable Attenuation Factor (Cable Loss)
RA = Reading Amplitude	AG = Amplifier Gain
AF = Antenna Factor	

Transd=AF +CL-AG

RADIATION LIMIT

According 15.249, the field strength of emissions from intentional radiators operated within 2400MHz-2483.5 MHz shall not exceed 94dBµV/m (50mV/m):

FCC PART 15.249(d) Emissions radiated outside of the specified frequency bands, except for harmonics, shall be attenuated by at least 50 dB below the level of the fundamental or to the general radiated emission limits in §15.209, whichever is the lesser attenuation.

In addition, radiated emissions which fall in the restricted bands, as defined in §15.205(a), must also comply with the radiated emission limits specified in §15.209(a)

Radiated emission limits

Frequency (MHz)	Distance (Meters)	Radiated (dBµV/m)	Radiated (µV/m)
0.009-0.49	3	20log(2400/F(KHz))+40log(300/3)	2400/F(KHz)
0.49-1.705	3	20log(24000/F(KHz))+ 40log(30/3)	24000/F(KHz)
1.705-30	3	20log(30)+ 40log(30/3)	30
30-88	3	40.0	100
88-216	3	43.5	150
216-960	3	46.0	200
Above 960	3	54.0	500

TEST RESULTS

Remark:

1. This test was performed with EUT in X, Y, Z position and the worse case was found when EUT in X position.
2. Both modes of GFSK were tested at Low, Middle, and High channel and recorded worst mode at GFSK
3. Radiated emission test from 9 KHz to 10th harmonic of fundamental was verified, and no emission found except system noise floor in 9 KHz to 30MHz and not recorded in this report.

For 30MHz-1GHz

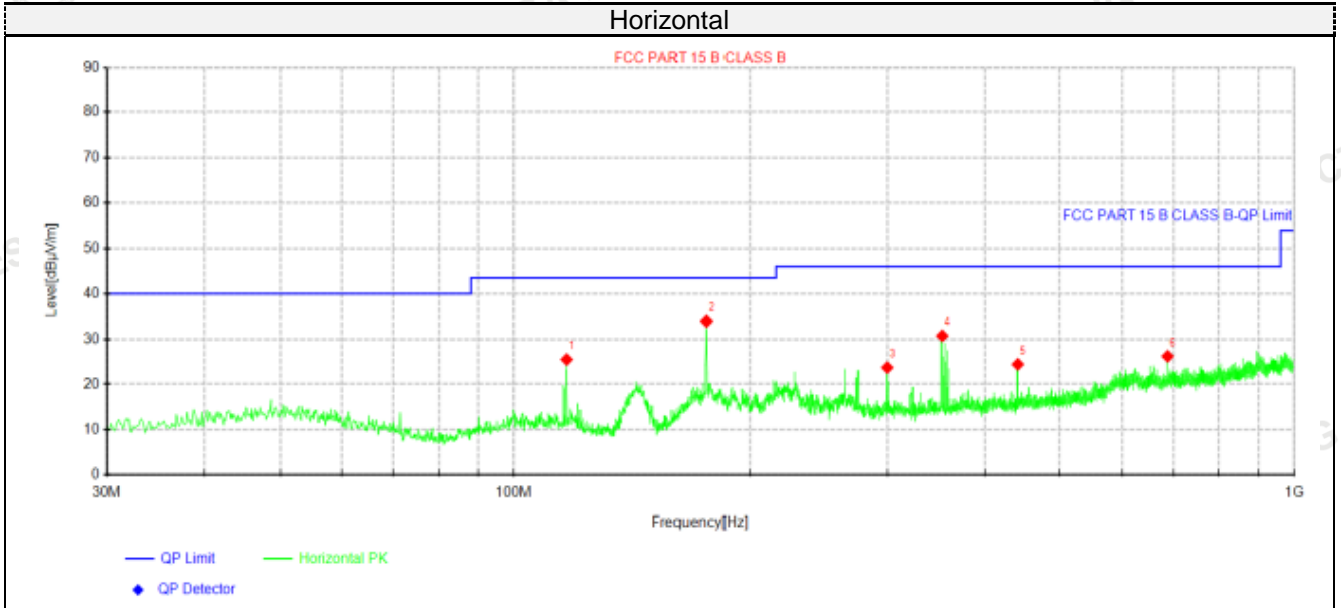

Suspected Data List

NO.	Freq. [MHz]	Reading [dBµV]	Level [dBµV/m]	Factor [dB/m]	Limit [dBµV/m]	Margin [dB]	Height [cm]	Angle [°]	Polarity
1	116.693	39.60	25.49	-14.11	43.50	18.01	100	338	Horizontal
2	176.47	49.17	33.92	-15.25	43.50	9.58	100	20	Horizontal
3	299.902	35.07	23.70	-11.37	46.00	22.30	100	31	Horizontal
4	353.373	41.90	30.75	-11.15	46.00	15.25	100	147	Horizontal
5	441.28	34.52	24.42	-10.10	46.00	21.58	100	0	Horizontal
6	687.538	31.45	26.21	-5.24	46.00	19.79	100	124	Horizontal

- Note: 1). Level (dBµV/m) = Reading (dBµV) + Factor (dB/m)
 2). Factor (dB/m) = Antenna Factor (dB/m) + Cable loss (dB) - Pre Amplifier gain (dB)
 3). Margin (dB) = Limit (dBµV/m) - Level (dBµV/m)

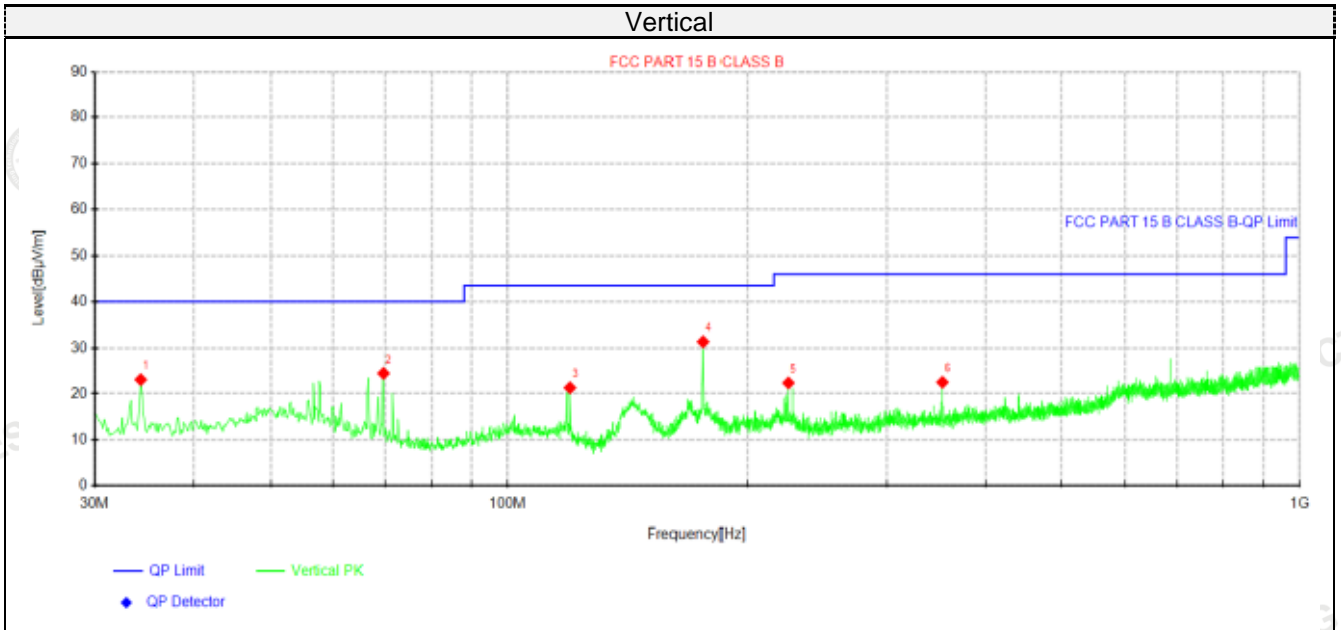

Suspected Data List

NO.	Freq. [MHz]	Reading [dBµV]	Level [dBµV/m]	Factor [dB/m]	Limit [dBµV/m]	Margin [dB]	Height [cm]	Angle [°]	Polarity
1	34.2438	37.17	23.07	-14.10	40.00	16.93	100	359	Vertical
2	69.6488	39.29	24.45	-14.84	40.00	15.55	100	3	Vertical
3	119.725	35.54	21.29	-14.25	43.50	22.21	100	292	Vertical
4	176.47	46.61	31.36	-15.25	43.50	12.14	100	166	Vertical
5	225.455	35.33	22.35	-12.98	46.00	23.65	100	144	Vertical
6	353.373	33.64	22.49	-11.15	46.00	23.51	100	132	Vertical

Note:1).Level (dBµV/m)= Reading (dBµV)+ Factor (dB/m)

2). Factor(dB/m)=Antenna Factor (dB/m) + Cable loss (dB) - Pre Amplifier gain (dB)

3). Margin(dB) = Limit (dBµV/m) - Level (dBµV/m)

For 1GHz to 25GHz

GFSK (above 1GHz)

Frequency(MHz):			2402		Polarity:		HORIZONTAL		
Frequency (MHz)	Emission Level (dBuV/m)		Limit (dBuV/m)	Margin (dB)	Raw Value (dBuV)	Antenna Factor (dB/m)	Cable Factor (dB)	Pre-amplifier (dB)	Correction Factor (dB/m)
2402.00	98.67	PK	114.00	15.33	109.94	27.48	3.43	42.18	-11.27
2402.00	81.27	AV	94.00	12.73	92.54	27.48	3.43	42.18	-11.27
4804.00	48.59	PK	74.00	25.41	52.86	32.34	5.12	41.73	-4.27
4804.00	39.72	AV	54.00	14.28	43.99	32.34	5.12	41.73	-4.27
7206.00	49.61	PK	74.00	24.39	50.13	36.61	6.49	43.62	-0.52
7206.00	37.85	AV	54.00	16.15	38.37	36.61	6.49	43.62	-0.52

Frequency(MHz):			2402		Polarity:		VERTICAL		
Frequency (MHz)	Emission Level (dBuV/m)		Limit (dBuV/m)	Margin (dB)	Raw Value (dBuV)	Antenna Factor (dB/m)	Cable Factor (dB)	Pre-amplifier (dB)	Correction Factor (dB/m)
2402.00	96.13	PK	114.00	17.87	107.40	27.48	3.43	42.18	-11.27
2402.00	78.34	AV	94.00	15.66	89.61	27.48	3.43	42.18	-11.27
4804.00	46.49	PK	74.00	27.51	50.76	32.34	5.12	41.73	-4.27
4804.00	37.76	AV	54.00	16.24	42.03	32.34	5.12	41.73	-4.27
7206.00	47.26	PK	74.00	26.74	47.78	36.61	6.49	43.62	-0.52
7206.00	35.49	AV	54.00	18.51	36.01	36.61	6.49	43.62	-0.52

Frequency(MHz):			2426		Polarity:		HORIZONTAL		
Frequency (MHz)	Emission Level (dBuV/m)		Limit (dBuV/m)	Margin (dB)	Raw Value (dBuV)	Antenna Factor (dB/m)	Cable Factor (dB)	Pre-amplifier (dB)	Correction Factor (dB/m)
2426.00	97.93	PK	114.00	16.07	109.19	27.5	3.44	42.2	-11.26
2426.00	76.91	AV	94.00	17.09	88.17	27.5	3.44	42.2	-11.26
4852.00	56.24	PK	74.00	17.76	60.40	32.42	5.19	41.77	-4.16
4852.00	44.88	AV	54.00	9.12	49.04	32.42	5.19	41.77	-4.16
7278.00	49.37	PK	74.00	24.63	49.70	36.65	6.63	43.61	-0.33
7278.00	38.81	AV	54.00	15.19	39.14	36.65	6.63	43.61	-0.33

Frequency(MHz):			2426		Polarity:		VERTICAL		
Frequency (MHz)	Emission Level (dBuV/m)		Limit (dBuV/m)	Margin (dB)	Raw Value (dBuV)	Antenna Factor (dB/m)	Cable Factor (dB)	Pre-amplifier (dB)	Correction Factor (dB/m)
2426.00	95.71	PK	114.00	18.29	106.97	27.5	3.44	42.2	-11.26
2426.00	75.33	AV	94.00	18.67	86.59	27.5	3.44	42.2	-11.26
4852.00	53.79	PK	74.00	20.21	57.95	32.42	5.19	41.77	-4.16
4852.00	41.70	AV	54.00	12.30	45.86	32.42	5.19	41.77	-4.16
7278.00	46.86	PK	74.00	27.14	47.19	36.65	6.63	43.61	-0.33
7278.00	36.32	AV	54.00	17.68	36.65	36.65	6.63	43.61	-0.33

Frequency(MHz):			2480		Polarity:		HORIZONTAL		
Frequency (MHz)	Emission Level (dBuV/m)		Limit (dBuV/m)	Margin (dB)	Raw Value (dBuV)	Antenna Factor (dB/m)	Cable Factor (dB)	Pre-amplifier (dB)	Correction Factor (dB/m)
2480.00	96.56	PK	114.00	17.44	106.67	27.7	4.47	42.28	-10.11
2480.00	82.37	AV	94.00	11.63	92.48	27.7	4.47	42.28	-10.11
4960.00	51.95	PK	74.00	22.05	55.03	32.73	5.66	41.47	-3.08
4960.00	46.79	AV	54.00	7.21	49.87	32.73	5.66	41.47	-3.08
7440.00	51.84	PK	74.00	22.16	51.39	37.04	7.25	43.84	0.45
7440.00	40.83	AV	54.00	13.17	40.38	37.04	7.25	43.84	0.45

Frequency(MHz):			2480		Polarity:		VERTICAL		
Frequency (MHz)	Emission Level (dBuV/m)		Limit (dBuV/m)	Margin (dB)	Raw Value (dBuV)	Antenna Factor (dB/m)	Cable Factor (dB)	Pre-amplifier (dB)	Correction Factor (dB/m)
2480.00	94.33	PK	114.00	19.67	104.44	27.7	4.47	42.28	-10.11
2480.00	80.14	AV	94.00	13.86	90.25	27.7	4.47	42.28	-10.11
4960.00	49.86	PK	74.00	24.14	52.94	32.73	5.66	41.47	-3.08
4960.00	44.12	AV	54.00	9.88	47.20	32.73	5.66	41.47	-3.08
7440.00	49.37	PK	74.00	24.63	48.92	37.04	7.25	43.84	0.45
7440.00	38.90	AV	54.00	15.10	38.45	37.04	7.25	43.84	0.45

REMARKS:

1. Emission level (dBuV/m) =Raw Value (dBuV)+Correction Factor (dB/m)
2. Correction Factor (dB/m) = Antenna Factor (dB/m)+Cable Factor (dB)- Pre-amplifier
3. Margin value = Limit value- Emission level.
4. -- Mean the PK detector measured value is below average limit.
5. The other emission levels were very low against the limit.

Results of Band Edges Test (Radiated)

Frequency(MHz):			2402		Polarity:		HORIZONTAL		
Frequency (MHz)	Emission Level (dBuV/m)		Limit (dBuV/m)	Margin (dB)	Raw Value (dBuV)	Antenna Factor (dB/m)	Cable Factor (dB)	Pre-amplifier (dB)	Correction Factor (dB/m)
2390.00	61.49	PK	74	12.51	71.91	27.42	4.31	42.15	-10.42
2390.00	42.21	AV	54	11.79	52.63	27.42	4.31	42.15	-10.42
Frequency(MHz):			2402		Polarity:		VERTICAL		
Frequency (MHz)	Emission Level (dBuV/m)		Limit (dBuV/m)	Margin (dB)	Raw Value (dBuV)	Antenna Factor (dB/m)	Cable Factor (dB)	Pre-amplifier (dB)	Correction Factor (dB/m)
2390.00	59.67	PK	74	14.33	70.09	27.42	4.31	42.15	-10.42
2390.00	40.44	AV	54	13.56	50.86	27.42	4.31	42.15	-10.42
Frequency(MHz):			2480		Polarity:		HORIZONTAL		
Frequency (MHz)	Emission Level (dBuV/m)		Limit (dBuV/m)	Margin (dB)	Raw Value (dBuV)	Antenna Factor (dB/m)	Cable Factor (dB)	Pre-amplifier (dB)	Correction Factor (dB/m)
2483.50	60.63	PK	74	13.37	70.74	27.7	4.47	42.28	-10.11
2483.50	43.22	AV	54	10.78	53.33	27.7	4.47	42.28	-10.11
Frequency(MHz):			2480		Polarity:		VERTICAL		
Frequency (MHz)	Emission Level (dBuV/m)		Limit (dBuV/m)	Margin (dB)	Raw Value (dBuV)	Antenna Factor (dB/m)	Cable Factor (dB)	Pre-amplifier (dB)	Correction Factor (dB/m)
2483.50	58.61	PK	74	15.39	68.72	27.7	4.47	42.28	-10.11
2483.50	40.85	AV	54	13.15	50.96	27.7	4.47	42.28	-10.11

Note:

- 1) Emission level (dBuV/m) = Meter Reading+ antenna Factor+ cable loss- preamp factor.
- 2) Margin value = Limits-Emission level.
- 3) -- Mean the PK detector measured value is below average limit.
- 4) The other emission levels were very low against the limit.
- 5) RBW1MHz VBW3MHz Peak detector is for PK value; RBW 1MHz VBW10Hz Peak detector is for AV value.

4.3. 20dB Bandwidth Measurement

TEST CONFIGURATION



TEST PROCEDURE

The transmitter output was connected to the spectrum analyzer through an attenuator. The bandwidth of the fundamental frequency was measured by spectrum analyzer with 30KHz RBW and 300KHz VBW.

The 20dB bandwidth is defined as the total spectrum the power of which is higher than peak power minus 20dB.

LIMIT

N/A

TEST RESULTS

Modulation	Channel	20dB bandwidth (MHz)	Result
GFSK	Low	1.214	PASS
	Mid	1.210	
	High	1.212	

Note: 1.The test results including the cable lose.

GFSK



Low



Mid



High

4.4. Antenna Requirement

Standard Applicable

For intentional device, according to FCC 47 CFR Section 15.203, an intentional radiator shall be designed to ensure that no antenna other than that furnished by the responsible party shall be used with the device.

And according to FCC 47 CFR Section 15.247 (c), if transmitting antennas of directional gain greater than 6dBi are used, the power shall be reduced by the amount in dB that the directional gain of the antenna exceeds 6dBi.

Antenna Information

The maximum gain of antenna was 0.83 dBi.

Remark: The antenna gain is provided by the customer, if the data provided by the customer is not accurate, Shenzhen CTA Testing Technology Co., Ltd. does not assume any responsibility.

5. Test Setup Photos of the EUT



6. Test Photos of the EUT

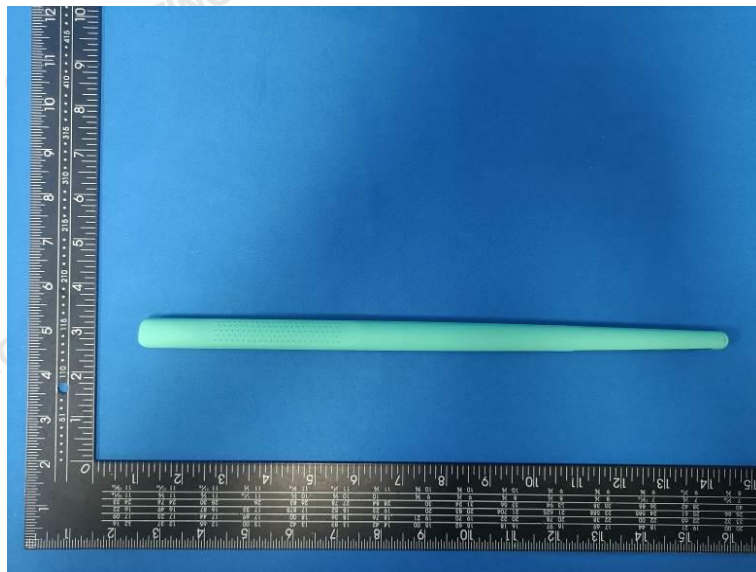

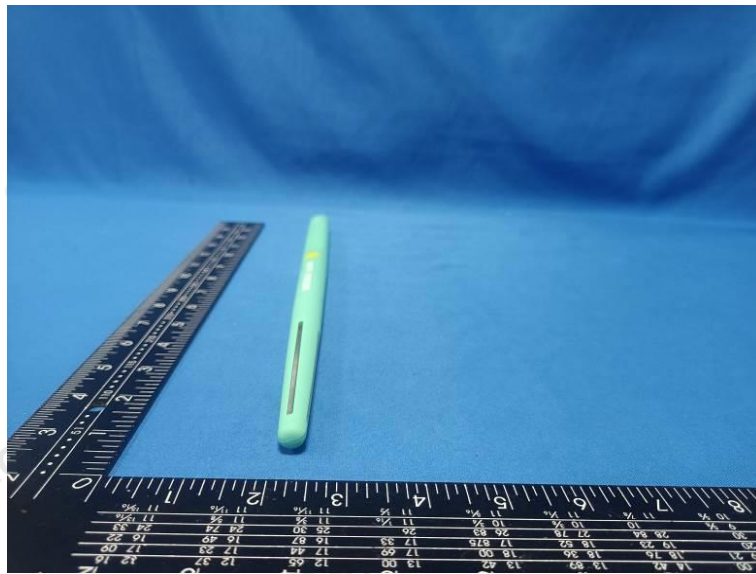
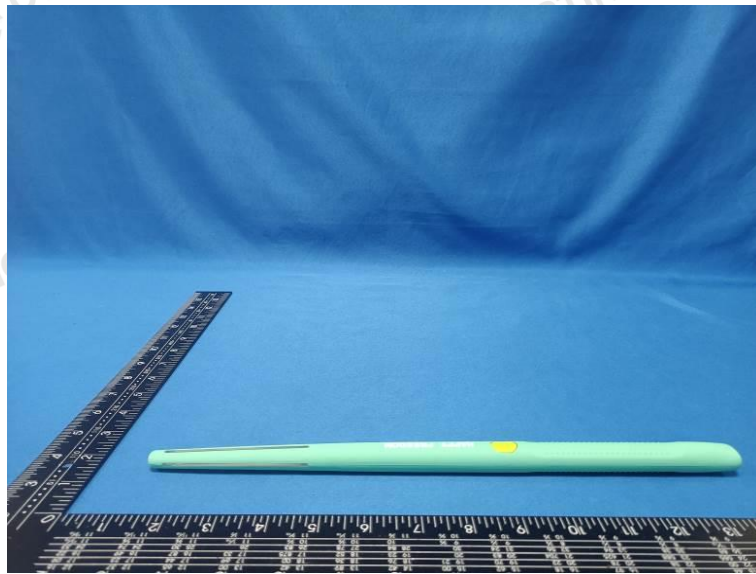
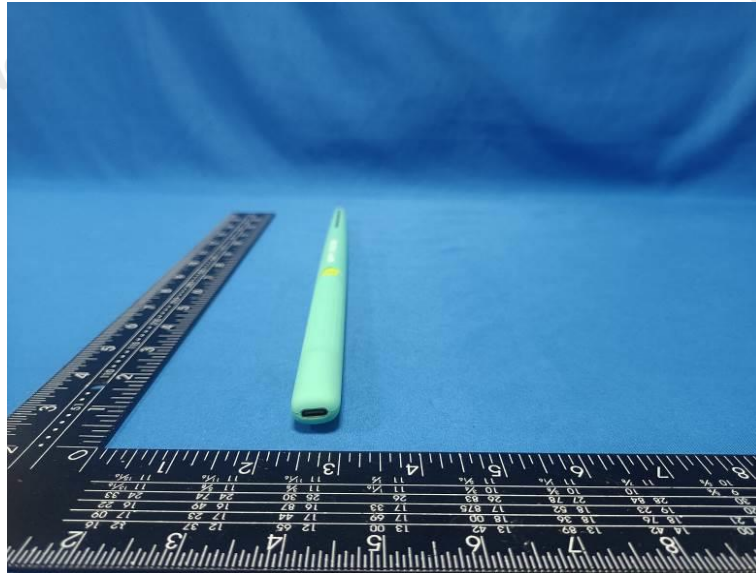

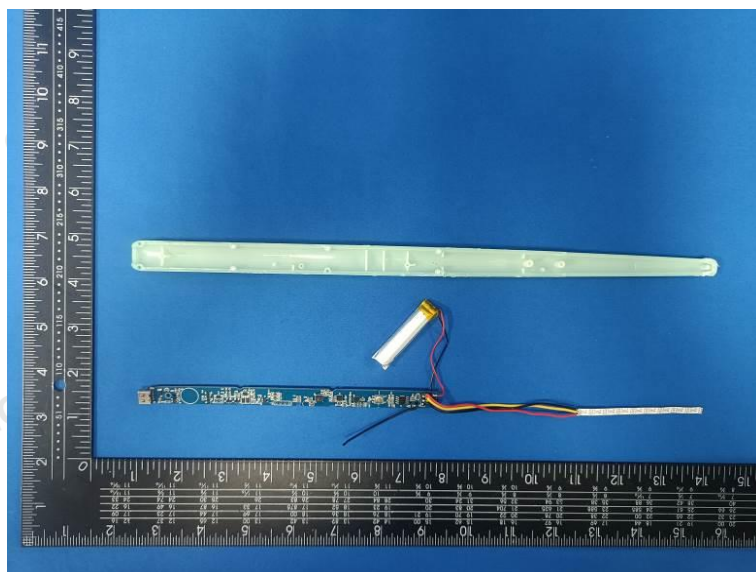
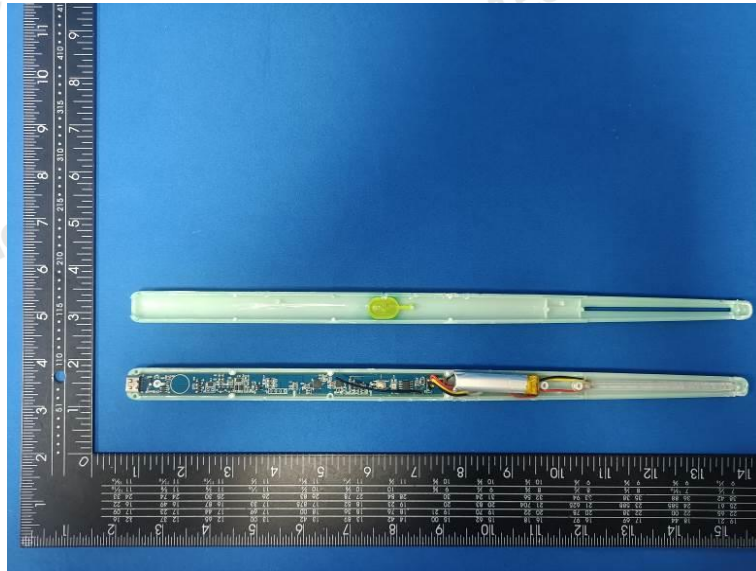
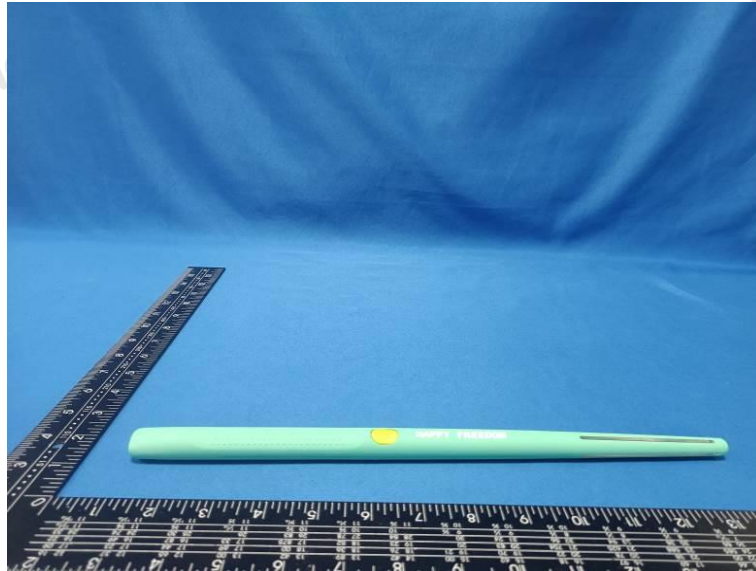

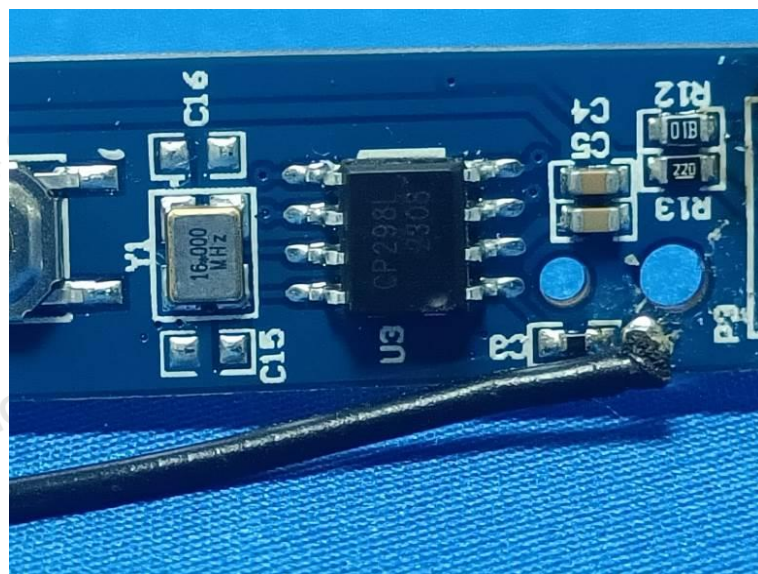
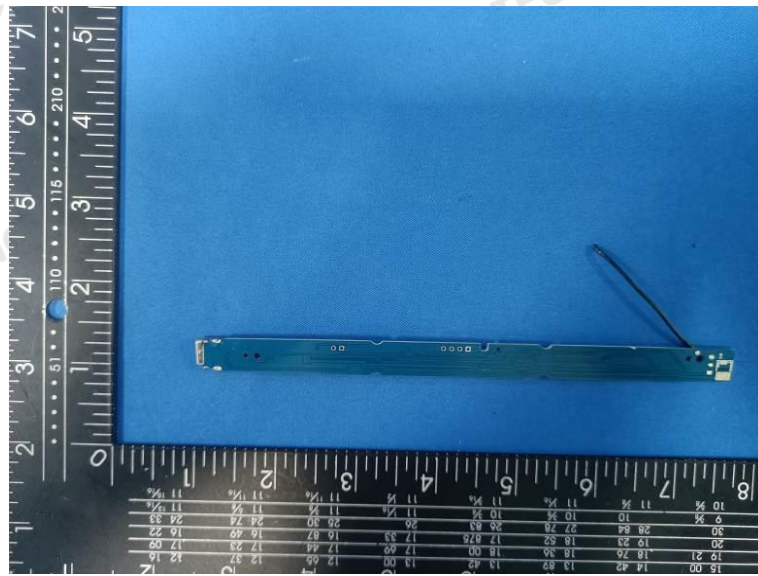
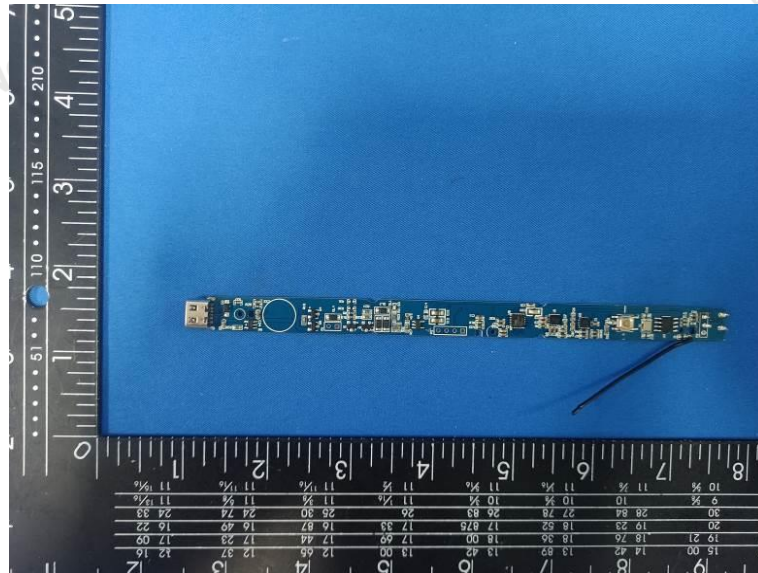

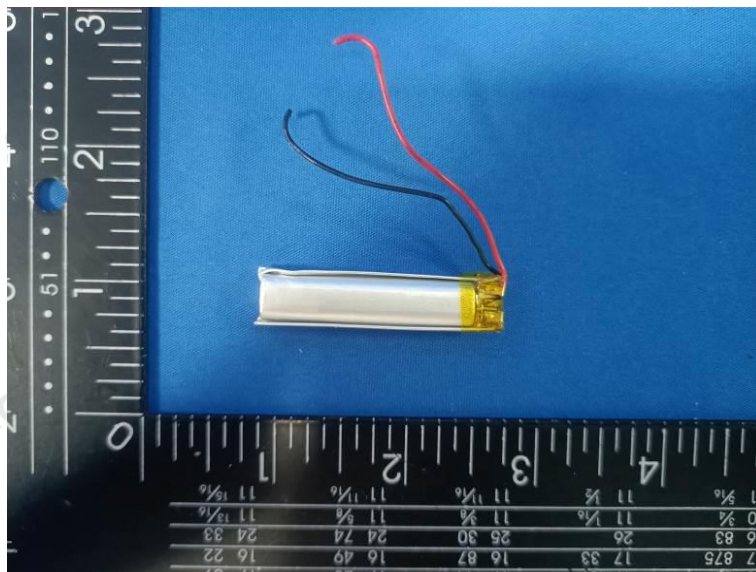
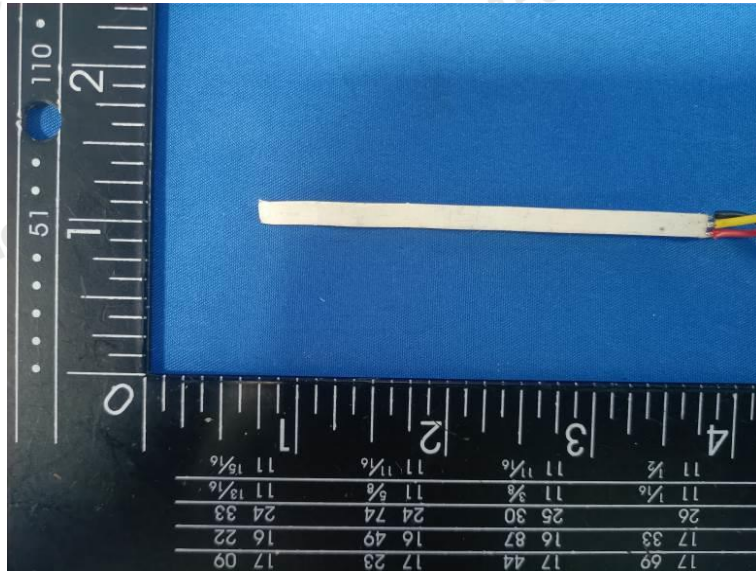
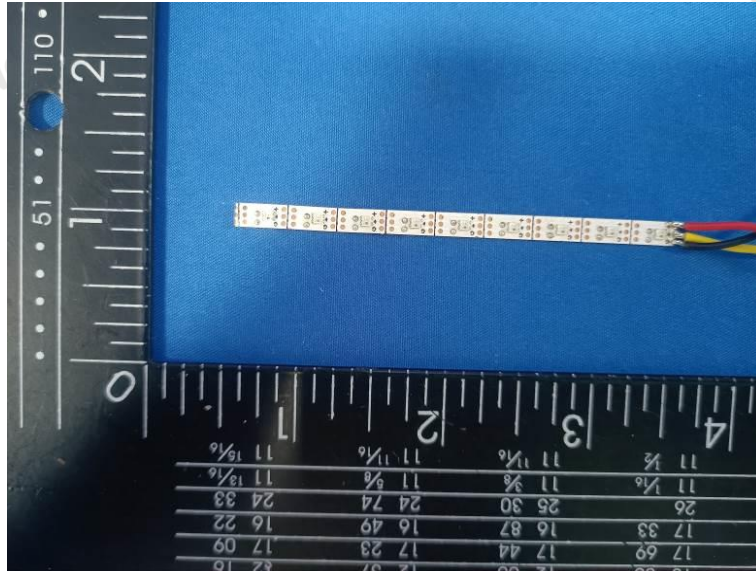

.....End of Report.....