

CONTENTS AND BATTERY INSTALLATION

Contents

1 Phantom Crawler 1 Remote Control 1 USB-C Cable

Battery Installation

CAUTION:

If the rechargeable battery leaks fluid, dispose of the vehicle immediately. Do not allow fluid to come in contact with skin or eyes.

Vehicle:

1. Disconnect the "try me" cable from the bottom of the vehicle and make sure the power switch located on the bottom of the vehicle is in the off position (o).
2. Remove the included demo batteries before first use.
3. Insert the USB-C charging cable into the port located at the back of the vehicle.
IMPORTANT: Do not use excessive force when connecting the USB-C cable.
4. Connect the other end of the USB-C charging cable into your charging source.
Note: The average charging time is approximately 150 minutes (2.5 hours) via 5V/2A USB wall charger. Includes rechargeable 1300mAh 7.4V battery (non-replaceable).

Remote control:

1. Use a tool to press and hold the battery release button on the back of the remote control.
2. Slide down the battery cover.
3. Insert batteries as indicated in the diagram.
4. Insert 3 AAA 1.5V batteries (not included) as indicated in the diagram.
5. Slide the battery cover back into place securely.

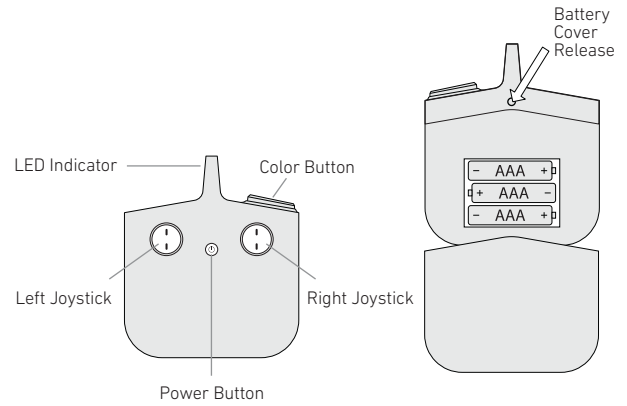
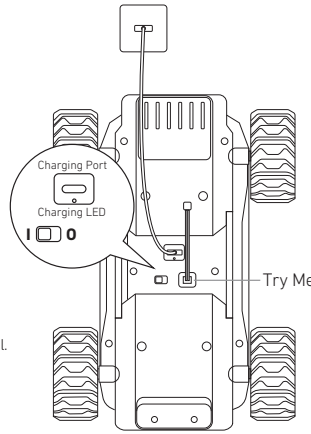

HOW TO PLAY

Pairing

1. Make sure both the vehicle and the remote control are powered off.
2. Power on the remote control by pressing the power button. The remote control will enter pairing mode and the power LED will slowly flash.
3. Power on the vehicle by flipping the power switch and set the vehicle down on a flat surface. The vehicle's LED lights will slowly flash when the car is in pairing mode.
4. The vehicle's LED lights and remote power LED will remain lit once paired.
5. If pairing is unsuccessful within 60 seconds, please power both the vehicle and the remote control before repeating steps 2 to 4.
6. Start Driving.

Multiple Drivers

The vehicle uses an automatic 2.4GHz digital channel selection system that allows up to 10 drivers to race side by side in the same wireless range without interference.

Color-changing Lights

Choose between 3 vibrant colors to light the road the way you want. Press the color button repeatedly to choose your color (green, blue, or green). The Headlights, vehicle roof lights and body on your vehicle will light up in your selected color.

Expanding Tires

Take on any challenge with oversized expanding tires. The tires will expand automatically when the vehicle is driven.

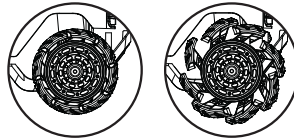

SAFETY PRECAUTIONS

- Do not sit, step, stand, or place objects on the vehicle. It is not designed to support extra weight.
- Adult supervision is recommended when operating the vehicle.
- Always drive responsibly and make sure driving paths are clear. Never drive towards or in close proximity to people or animals.
- Never submerge the vehicle in water and avoid driving the vehicle through water. The vehicle can handle minor splashes of mud and moisture, but it is not waterproof.
- Keep fingers, hair, and loose clothing away from tires and all moving parts while the vehicle is in motion.
- Do not expose to extreme temperatures.
- Do not leave vehicle or remote control near sources of heat or under direct sunlight for long periods of time.
- Thoroughly inspect products before every use. If the product appears worn, frayed, splintered, cracked, or broken in any manner, discontinue use and discard immediately.

RECHARGEABLE BATTERY WARNINGS: NON-REPLACEABLE BATTERY

- This product contains batteries that are non-replaceable.
- There is a risk of fire and personal injury if battery is punctured, damaged, or misused.
- Do not dismantle, crush, incinerate or short-circuit battery.
- Never expose battery to extreme temperatures or moisture.
- Keep away from flammable materials and direct sunlight.
- Only charge using the provided charger, cable, and/or adapters.
- Rechargeable battery is only to be charged by an adult.
- Adult supervision is required while charging the battery.
- Allow battery to cool to room temperature before charging.
- Charge on a non-flammable surface and keep away from flammable products.
- Discontinue charging if battery becomes hot, swells, smokes, or gives off a strong odor.
- Battery chargers used with the product are to be regularly examined for damage to the cord, plug, enclosure, and other parts. In the event of such damage, chargers must not be used until the damage has been repaired.
- Recycle or dispose of battery according to federal, state, and local laws.
- Keep these instructions for future reference.

BATTERY WARNINGS

- Do not mix old and new batteries.
- Do not mix alkaline, standard (carbon-zinc), or rechargeable batteries.
- Alkaline batteries are recommended. Use only the specified voltage.
- Insert batteries using the correct polarity. Always use, replace, and recharge (if applicable) batteries under adult supervision.
- Do not attempt to charge non-rechargeable batteries.
- Do not short-circuit the battery supply terminals.
- Do not dispose of batteries in fire: batteries may explode or leak.
- Remove batteries before storing.
- Recycle or dispose of batteries according to federal, state, and local laws.
- Keep these instructions for future reference.

This device complies with Part 15 of the FCC Rules. Operation is subject to the following two conditions: (1) this device may not cause harmful interference, and (2) this device must accept any interference received, including interference that may cause undesired operation.

NOTE: This equipment has been tested and found to comply with the limits for a Class B digital device, pursuant to Part 15 of the FCC Rules. These limits are designed to provide reasonable protection against harmful interference in a residential installation. This equipment generates, uses and can radiate radio frequency energy and, if not installed and used in accordance with the instructions, may cause harmful interference to radio communications.

However, there is no guarantee that interference will not occur in a particular installation. If this equipment does cause harmful interference to radio or television reception, which can be determined by turning the equipment off and on, the user is encouraged to try to correct the interference by one or more of the following measures:

- Reorient or relocate the receiving antenna.
- Increase the separation between the equipment and receiver.
- Connect the equipment into an outlet on a circuit different from that to which the receiver is connected.
- Consult the dealer or an experienced radio/TV technician for help.

Warning: Changes or modifications to this unit not expressly approved by the party responsible for compliance could void the user's authority to operate the equipment.

Sharper Image® name and logos (including the 77 logo) are trademarks or registered trademarks. Distributed by and © 2023 MerchSource, LLC, Irvine, CA 92618.

All rights reserved.

Model No.: 1017326

WARNING:
CHOKING HAZARD – Small Parts.
Not for children under 3 years of age.

BC

KEEP THIS INSTRUCTION MANUAL AS IT CONTAINS IMPORTANT INFORMATION FOR FUTURE REFERENCE.

Due to continuous product improvements, the pictures on this manual may differ slightly from the actual product.

Printed in China

**FOR CUSTOMER SUPPORT,
PLEASE CALL**

1-800-374-2744

Forward / Reverse

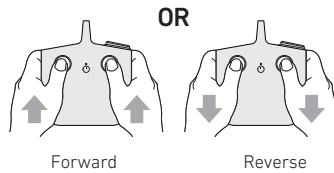
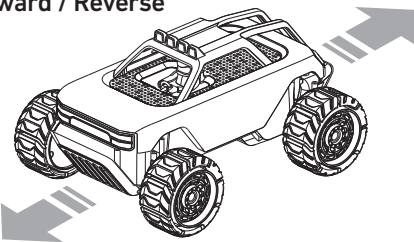

Left Turn / Right Turn

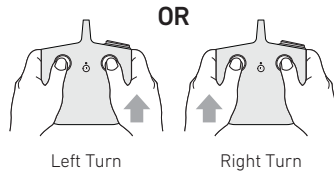
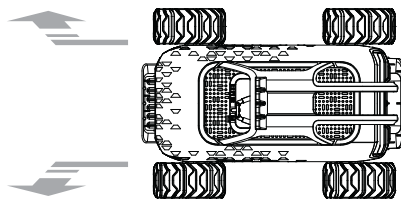

Right 360°

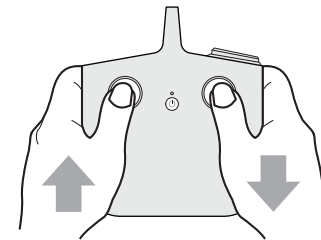
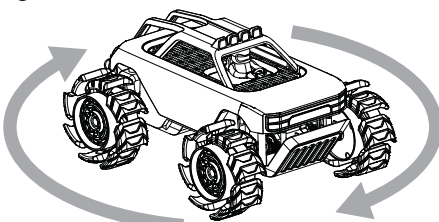

Left 360°

