

AK61 The instruction of Smart Bracelet



Please read the instructions before use

I. Product parameters

a. Compatible mobile phone system: Android5.0 (inclusive) or higher, iOS9.0 (inclusive) or higher

b. Screen: 1.43 Round Screen Resolution: 360*360

II. Operating instructions

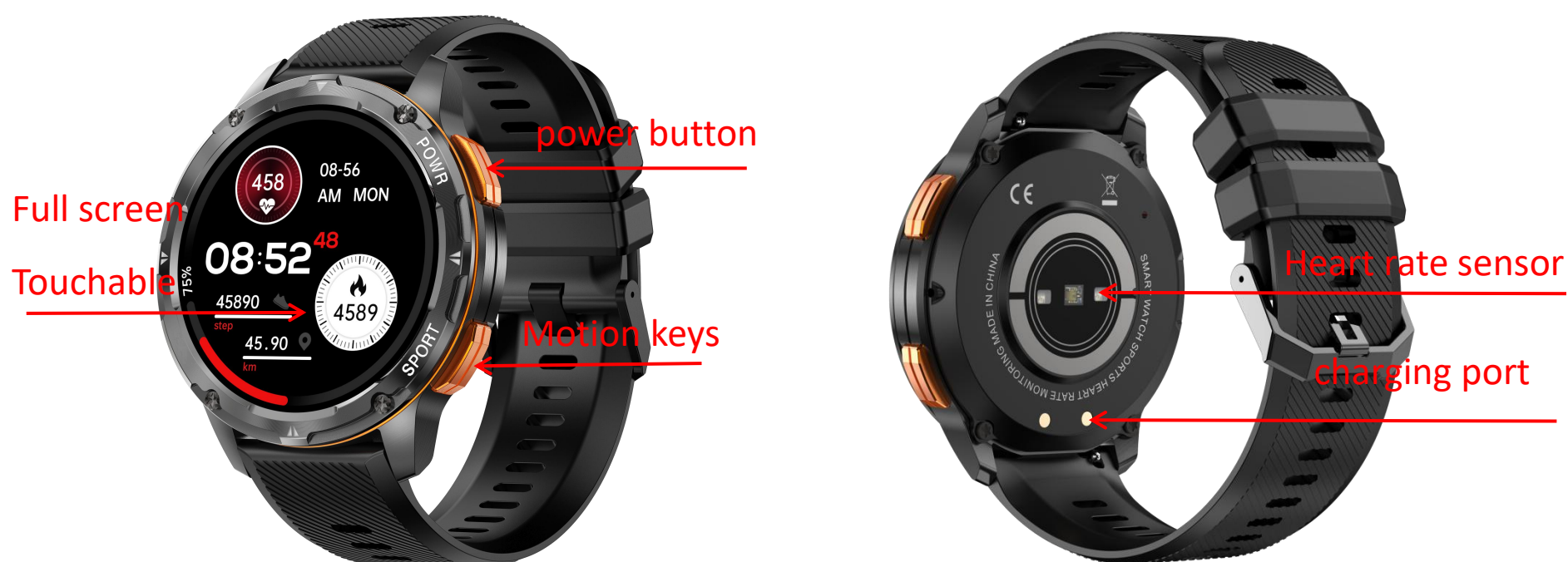

1. Button operation

Status/Operation	Function
power button: power off/long press for 3 seconds	power on
power button: power on/long press for 3 seconds	power off
power button: screen off/short press	screen on
power button: screen on/short press	screen off
power button: function interface/short press	back to Home page
Motion keys: short press	enter sport mode

2. Screen operation

Status/Operation	Function
single click	Select / OK
home page/long press for 3 seconds	switch dial
home page/slide up	message list
home page/slide down	Shortcut menu
home page/slide left	Call interface - voice assistant - activity center - sleep mode - heart rate - blood pressure - blood oxygen - stress test - weather - music control
home page/slide right	enter home page

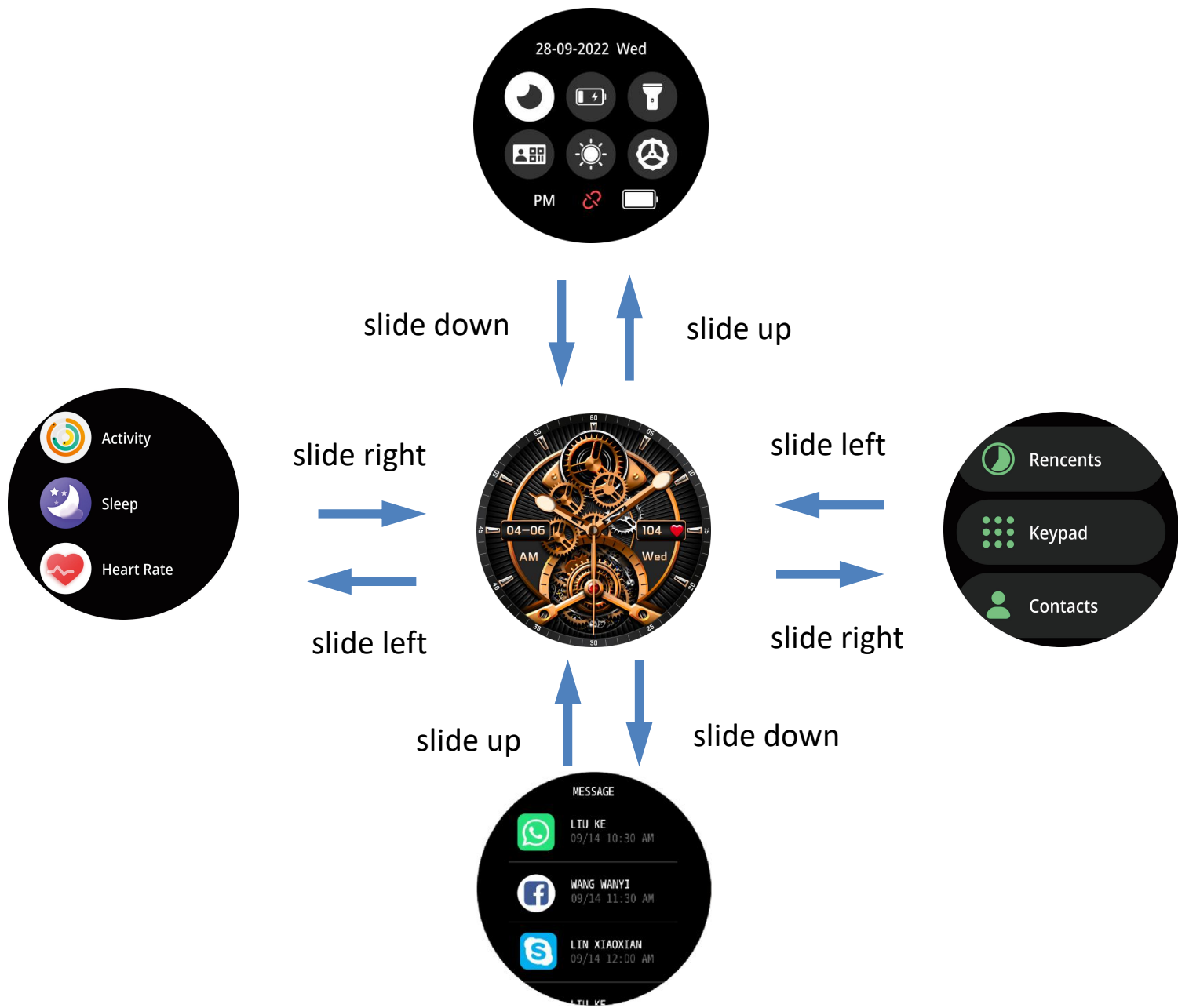

3. Charging instructions

a. Please use the charging cradle equipped with the product to align the contacts on the back of the host to charge (please ensure that the battery is sufficient for the first use. If the battery cannot be turned on normally at low power, please charge it before operating. Please charge correctly as shown in the right picture)

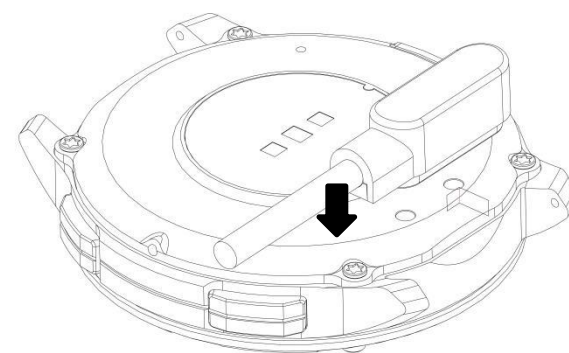

b. Do not use a power adapter with an output current of more than 2A to charge

4. Download and install the "Da Fit" APP

1).Scan to download and install "Da Fit" by scanning the QR code on the right

2).Download and install through the app market:

Android system: search for "Da Fit" through App Store, Google play, Android Market and other app markets to download and install; IOS system: search for "Da Fit" through the App Store to download and install



5. APP connection

(make sure mobile phone Bluetooth is turned on and not connected with other devices) shortcut menu→settings→about interface, the MAC address of the watch will be displayed, and your device can be determined by the MAC address in the device table. After the watch is successfully bound, the watch will be automatically connected with the mobile phone every time the client is opened in the future. You can synchronize data by pulling down the data page of the client.

Open the mobile client app to set personal



Switch to the device page and click bind



Click your device (AK61) in the scanned



Binding complete

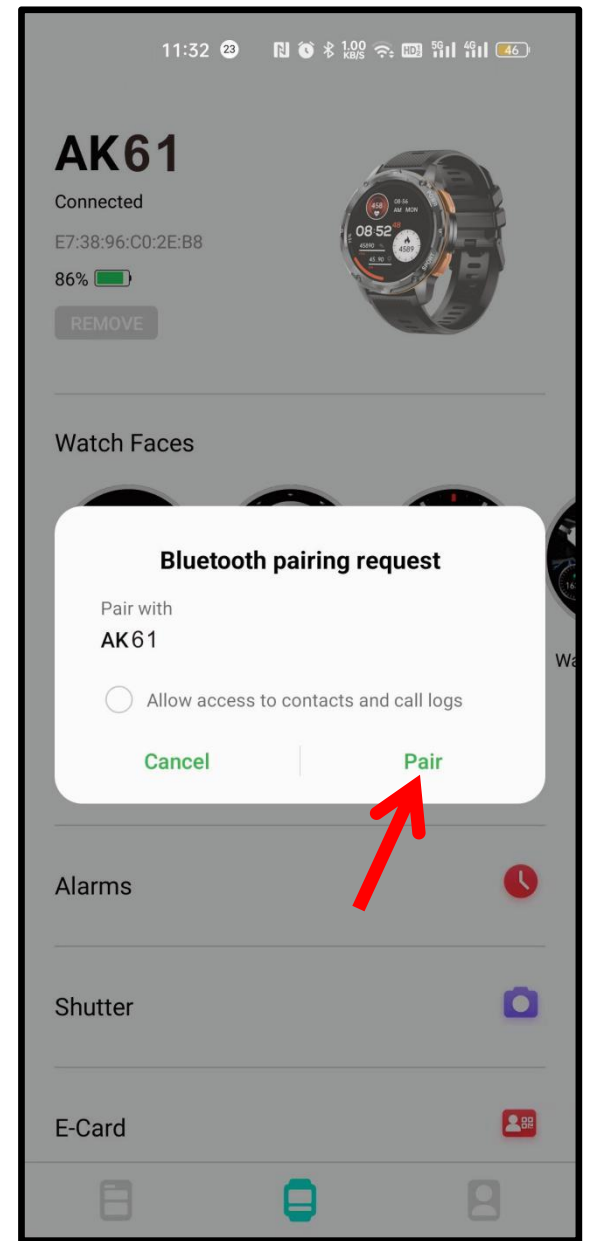
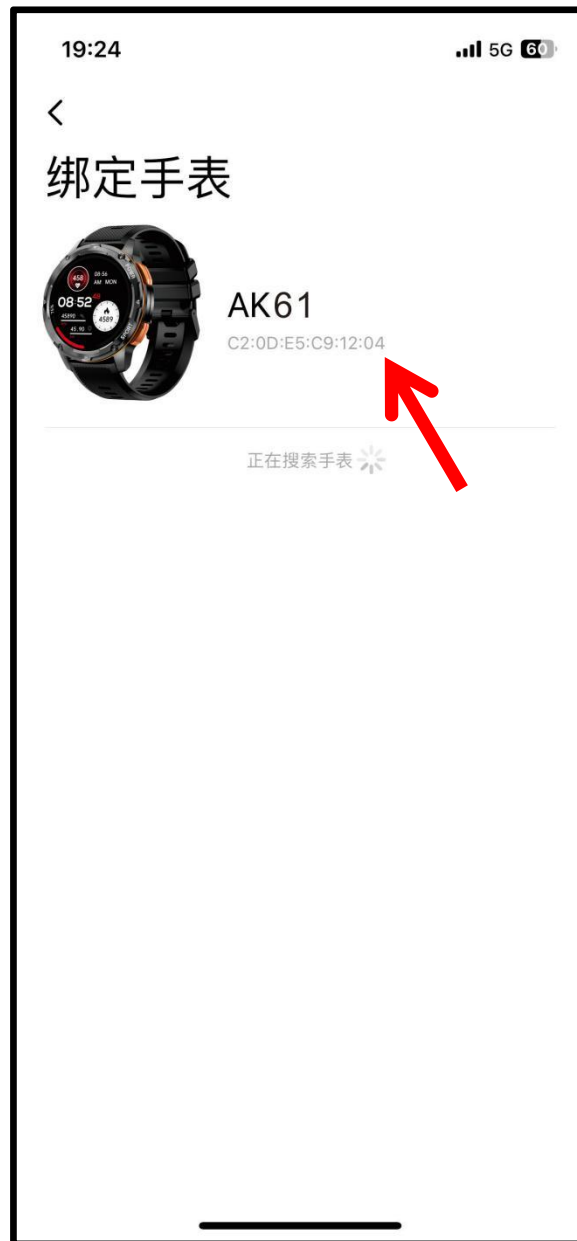
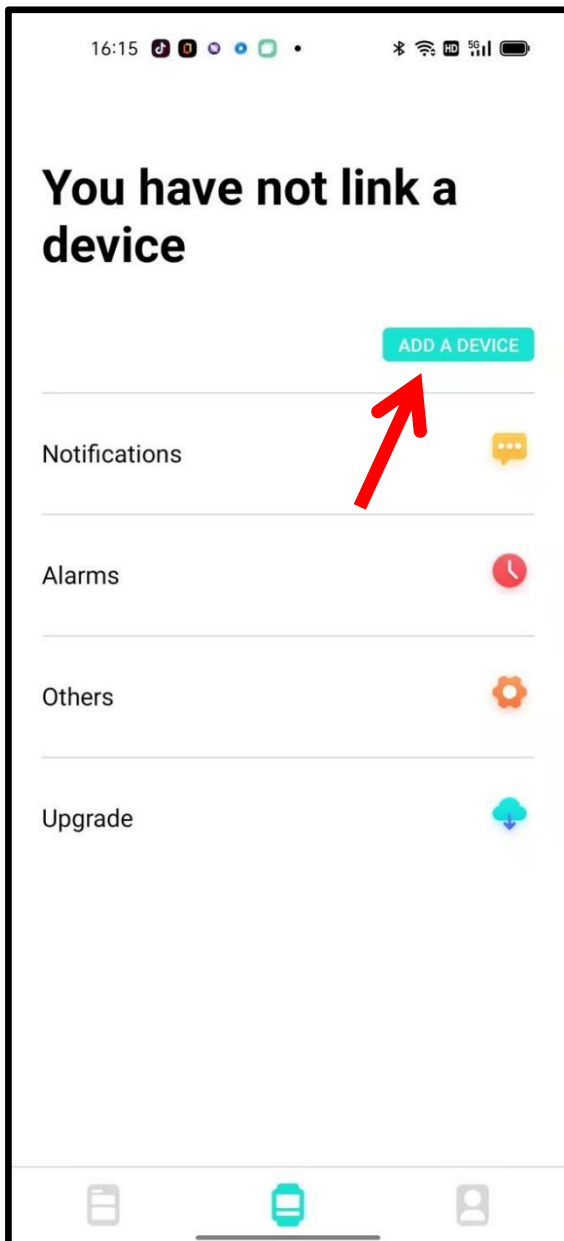

6.Call Bluetooth connection: turn on the watch "TURN ON", and the "AK61" Bluetooth pairing will pop up automatically in the mobile phone. Click pairing. When Bluetooth is connected to the mobile phone, you can use the watch to dial, control the mobile phone to make a call, listen to music, and view the call record information of the watch.If you click Unpair, when you need to pair the Bluetooth for a call again, open the watch "Enable call function", open the phone settings → Bluetooth option, view all devices, and click "AK61" to connect.



Click to turn on the call function

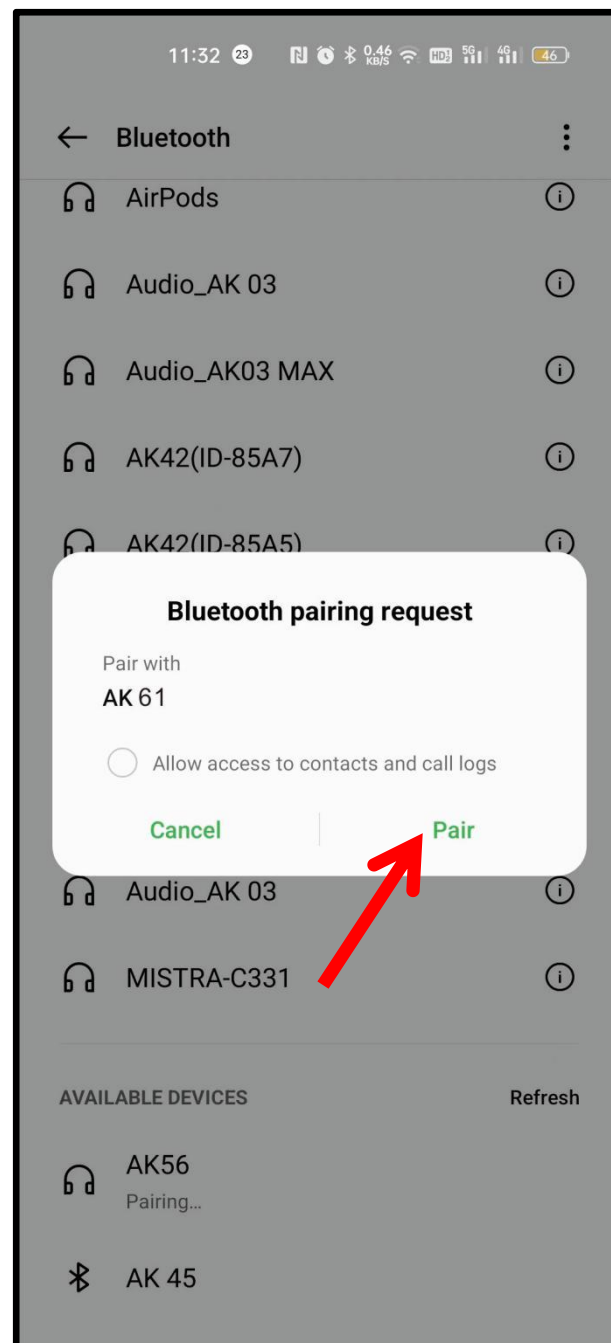
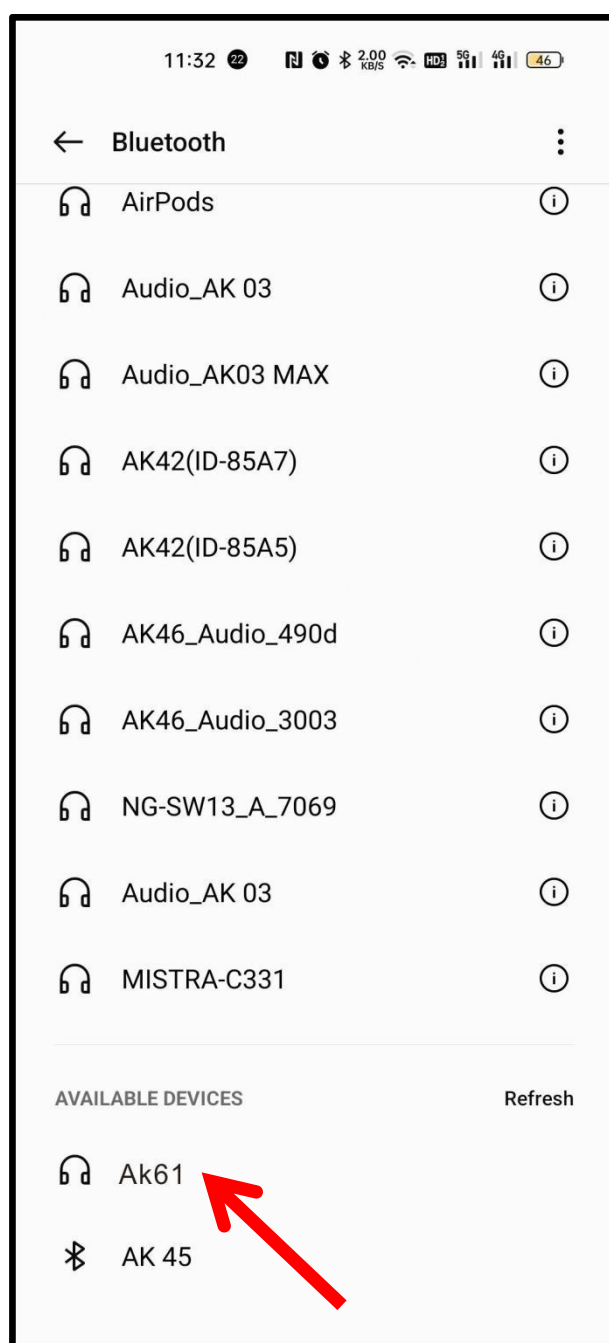

Add contacts: enter the "Da fit" app, click "quick communication" → select contacts to add (at present, up to 8 contacts can be added)

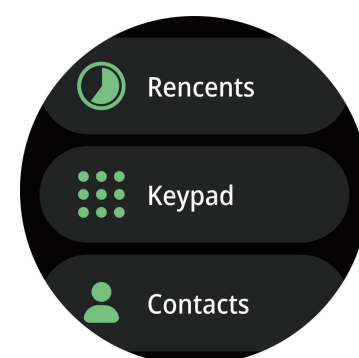

7. Watch function mode

a. Main interface switching: long press the main interface for 3 seconds to enter the selection dial interface, slide left and right to select the main interface, Click to confirm



Custom dial: enter the "Da fit" app and click - > dial selection - > Edit to select the dial you want.

Find more dials: enter the "Da fit" app and click "dial selection" - > more dial settings.

b. The voice assistant is a smart mobile phone application, open it and you can command your mobile phone through smart dialogue, such as sending a message to make a call.



c. Activity Center: wear the watch normally, and the watch displays the current exercise steps, distance and calories (the data of the day before 0:00 a.m. every day)



d. Sleep monitoring: wear a watch to sleep. The watch will automatically monitor the length of deep sleep, light sleep and total time yesterday. The detailed data is displayed on the app side, and the user can view the sleep quality and sleep duration distribution map in the app.



e. **Heart rate measurement:** click the screen in the heart rate interface to measure the current heart rate value. It can also be measured manually on the heart rate interface of APP end **(the data is only for reference and not for medical use)**

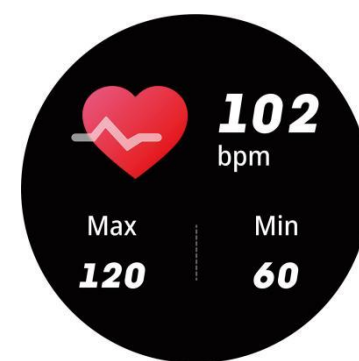

f. **Blood pressure:** click the screen in the blood pressure interface to measure the current blood pressure value. The icon flashes as in the test and slides right to exit. It can also be measured manually on the app side blood pressure interface **(the data is only for reference and not for medical use)**

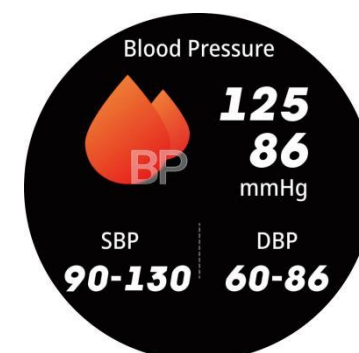

g. **Blood oxygen:** click the screen in the blood oxygen interface to measure the current blood oxygen value. The flashing icon indicates that the test is in progress, or it can be measured manually on the app end blood oxygen interface **(the data is for reference only, not for medical use)**

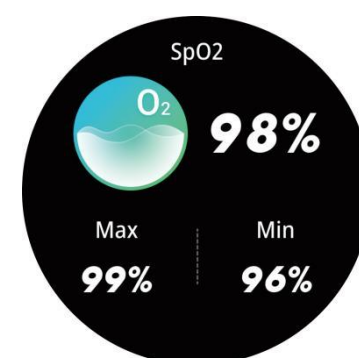

h. **Pressure:** Tap the screen on the pressure interface to measure the current blood oxygen value. The icon flashes for the test, or you can manually measure the blood oxygen interface on the APP **(the data is for reference only and is not for medical use)**



i. **Exercise mode:** 100+ sports modes to choose from: walking, running, cycling, basketball, football, badminton, skipping rope..., after turning on the sports mode, swipe left to select pause/end exercise, if you want To add a sport mode, slide down to the end and click Add to select the desired sport mode.



j. Weather: the current weather and air quality information will be displayed on the weather interface. Slide up the weather interface to view the weather conditions in the next 6 days. The weather information can only be obtained after the app is connected. If the connection is disconnected for a long time, the weather information will not be updated.



k. Camera control: after connecting the mobile phone, the watch can be used as the remote control of the mobile phone camera. Open the "camera control" on the app side and click on the watch camera control page to trigger the snap shot of the mobile camera.

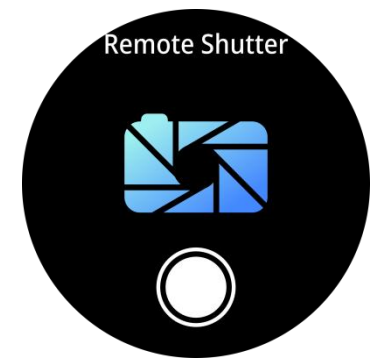

l. Music control: after connecting the mobile phone, the watch can control the pause / play of mobile phone music, the previous song and the next song.



m. Breathing exercise: Sucking function exercise is to carry out effective breathing and strengthen the respiratory muscles. Deep breathing can help you relieve stress.



n. game: FlyingBird/2048/Whack-A-Mole/Thunder Fighter

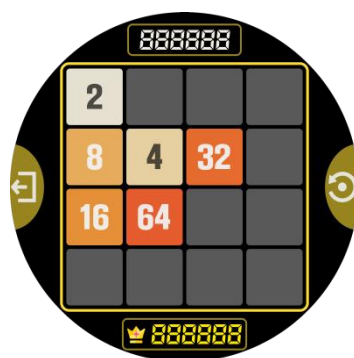
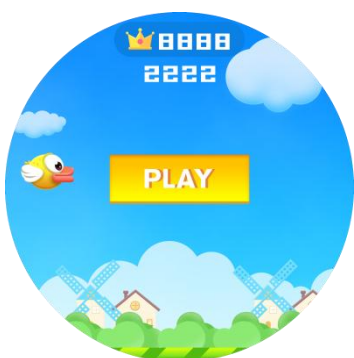

o. Information push: this watch supports phone / SMS / wechat / Facebook /Twitter/WhatsApp/Skype /other application information push. This page only saves the last 5 information records, and you can turn on the corresponding switch according to your needs. (note that when the Android mobile phone opens the information reminder, it must set the notification right of the app to the mobile phone, otherwise the watch will not receive the reminder)



p. Other function interfaces: Other functions of the watch include: stopwatch, alarm clock, timer, phone switch, call reset, menu view, brightness adjustment, vibration switch, theater mode, factory reset, shutdown, about



Menu view: divided into two modes: grid view and list view

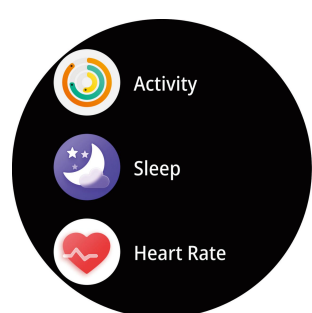

List view



Crescent view



Cellular view

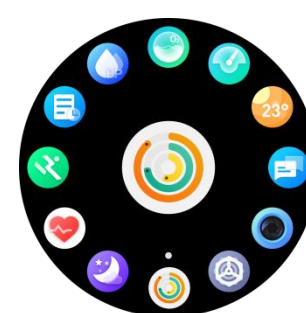

Rudder view

Note: more detailed analysis and data records can be viewed in the app

Frequently asked questions and answers

Why does the blood pressure value deviate from the sphygmomanometer?

The deviation between the measurement values of the watch and the sphygmomanometer is determined by many factors. The measurement part of the sphygmomanometer is in the brachial artery, and the measurement part of the watch is in the two main public branches of the micro artery. Under normal circumstances, the measurement value of aortic blood pressure and micro arterial blood pressure will differ by 30 to 40. If you use a watch and a

sphygmomanometer to measure at the same time, since the blood flowing in the artery is in the centrifugal direction, when the sphygmomanometer measures, the lower part of your elbow is under pressure, and the blood cannot branch smoothly to the artery below. Flow, increased vascular tension, will make the upper and lower blood pressure measurements more deviations.

Why can't user take a hot bath with the watch?

The ambient temperature during bathing is relatively high, which will produce a lot of water vapor, and the water vapor is gaseous, its molecular radius is small, and it is easy to seep into the gap of the watch. When the temperature drops, it will condense into liquid water droplets again, which is easy to cause The internal circuit of the watch is short-circuited, destroying the circuit board, and then destroying the watch.

Frequently asked questions and answers

Why can't the watch receive the message push

Android phone settings;

Confirm that the message push switch is turned on on the mobile client

The confirmation message can be displayed normally in the mobile phone notification bar. The watch message push is pushed by reading the message in the mobile phone notification bar. If there is no message in the mobile phone bar, the watch will not be able to receive the push. (You need to find the notification settings in the phone settings, and turn on the notification switch of WeChat, QQ, phone, SMS, and mobile client)Open the accessibility settings of the bracelet client(Find the accessibility in the phone settings, open the accessibility settings of the bracelet client)iPhone settings Confirm that the message push switch is turned on on the mobile client The confirmation message can be displayed normally in the notification bar of the phone (You need to find the notification settings in the phone settings, and turn on the notification switch of WeChat, QQ, phone, SMS, and mobile client)

Precautions

Do not throw this product into the fire to avoid explosion

This product is waterproof only for cold water. If it is used for hot water, it may cause white fog in the lens

The battery life of this product varies with the use environment and use mode

Disclaimer:

This product is not a medical device. The bracelet and its application program are not used for diagnosis, treatment, or prevention of diseases and diseases. If you want to change your habits such as exercise and sleep, you must consult qualified professional medical personnel first to avoid serious casualties. Our company guarantees that without prior notice, The right to modify and improve any function described in this manual, and the company maintains the right to constantly update the product content. All contents shall be subject to the real object

FCC Statement

This device complies with part 15 of the FCC rules. Operation is subject to the following two conditions: (1) this device may not cause harmful interference, and (2) this device must accept any interference received, including interference that may cause undesired operation.

Changes or modifications not expressly approved by the party responsible for compliance could void the user's authority to operate the equipment.

NOTE: This equipment has been tested and found to comply with the limits for a Class B digital device, pursuant to part 15 of the FCC Rules. These limits are designed to provide reasonable protection against harmful interference in a residential installation. This equipment generates uses and can radiate radio frequency energy and, if not installed and used in accordance with the instructions, may cause harmful interference to radio communications. However, there is no guarantee that interference will not occur in a particular installation. If this equipment does cause harmful interference to radio or television reception, which can be determined by turning the equipment off and on, the user is encouraged to try to correct the interference by one or more of the following measures:

- Reorient or relocate the receiving antenna.
- Increase the separation between the equipment and receiver.
- Connect the equipment into an outlet on a circuit different from that to which the receiver is connected.
- Consult the dealer or an experienced radio/TV technician for help.

The device has been evaluated to meet general RF exposure requirement. The device can be used in portable exposure condition without restriction.