

ILIFE-A20

Robotic vacuum cleaner

User Manual

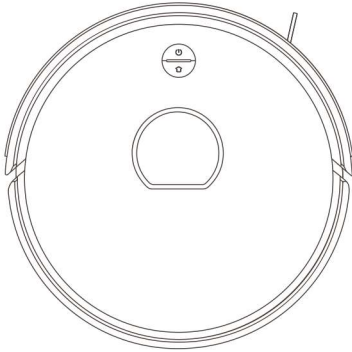

English
Español

For more detailed information,
please visit: www.iliferobot.com | **ILIFE**

Dear Customer,

Thank you for purchasing ILIFE A20 robotic vacuum cleaner!
You've joined the millions of people who clean with robots - the smarter way to get it done.

Please take a few moments to read this manual and get acquainted with your robot, to get the best performance from your robot. If you have any problems with your robot please do not hesitate to contact our customer service or visit our website at www.iliferobot.com for more information. Stay connected with us on Facebook and Twitter to enjoy these exclusive benefits:

- Get support tailored to your specific robot, including answers to questions, maintenance tips, video demos, live chat and more.
- Get product updates and other valuable information among the first to find out about new robots, exclusive discounts and special promotions.

Connect with us right now at

Facebook: <https://www.facebook.com/ilifeglobal>

Twitter: https://twitter.com/ilife_global

Enjoy a thorough cleaning every day!

Best regards,

ILIFE Innovation

ILIFE Customer Service



1-800-631-9676 (Toll free for North America)

Mon-Fri: 8:00 am - 7:00 pm CST



service_us_ca@iliferobot.com

Table of Contents

Safety Instructions	3
Product Composition	5
List of accessories	5
Host Introduction	6
Indicator status	6
Sensor and structure	7
Dust bin assembly	8
Charging dock	8
Product specifications	9
Product Operating	10
Attentions	10
Charging dock	12
Select cleaning modes	15
Water tank operation	16
APP Connection	18
Preparation before connection	18
Hotspot networking (compatible mode)	19
Connect with Amazon Alexa or Google Assistant	20
Maintenance	21
Clean up dustbin and filters	21
Cleaning of water tank components	22
Clean up the side brushes	23
Check side wheels	23
Other spare parts	23
Troubleshooting	25
Error codes	25

Safety Instructions

Warnings

1. This robot should not be used by children under 8 or people with mentally challenged, unless they are under supervision. Do not let children sit on the robot or use it as a toy.
2. Attend to the robot promptly if an error occurs during cleaning. Before using the robot, remove all power cords and small objects on the floor. Roll up carpet tassels and make sure curtains and table cloth are not in contact with the floor.
3. If there are hanging steps or stairs, please test if the robot can detect them before use. If not, please set up barriers to avoid falling down, and make sure that the barriers cause no harm to people.
4. Follow the instructions in this user manual. Use factory authorized or recommended accessories only.
5. Make sure the voltage of the charging dock is compatible with the voltage of power supply.
6. Use the robot indoor and in a home environment only. Do not use it outdoor, or in commercial or industrial spaces.
7. Use factory authorized adaptor and charging dock only. Do not use non-rechargeable battery. Refer to “Product Specifications” section for details about battery standards.
8. Do not soak the robot in water and do not rinse the robot under the faucet.
9. Do not clean the robot with dripping wet cloth.
10. Do not use the robot on floors with ponding water.
11. Do not use the robot near fire or fragile objects.
12. Do not make the cloth, humans hair, finger, or other parts of the body close to the open or the running mechanism of the robot.
13. Do not use the robot on floors with stones or paper to avoid being stuck.
14. Do not use the robot in areas with any flammables, such as gasoline, toner and so on. Or use the robot to clean any burning objects, like cigarettes, ashes or matches, or anything that may cause a fire.
15. Do not use damaged charging dock.
16. Do not lift up the robot or the charging dock by the power cord, and keep the power cords away from heat and avoid it being trapped around doors, sharp edges or corners.

Safety Instructions

17. Damaged power cords must be repaired by manufacturer's repair service or certified technicians.
18. Install dustbin and filters properly before using the robot.
19. Do not use the robot in rooms where babies are sleeping.
20. Do not use damaged power cords or charging dock to recharge the robot.
Do not use the robot if it's damaged by falling down, or soaking in water.
21. Turn off the power switch if the robot will not be used for a long time.
22. Turn off the power switch before cleaning or maintaining the robot.
23. Unplug power cords from the charging dock before cleaning or maintaining the robot.
24. Remove battery before discarding the robot.
25. Robot and battery are to be disposed of according to local safety regulations.
26. Do not cremate the robot to avoid the explosion.
27. Follow the instructions in this user manual.
Manufacturer is not responsible for any damages caused by improper use.

Product Composition

List of accessories



Main Body

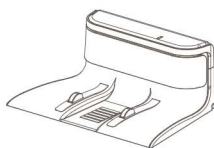

Charging Dock

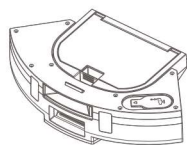

2 in 1 Dustbin & water tank

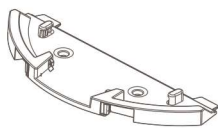

Mopping Support

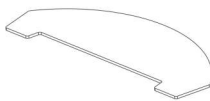

Mop Cloth



Extra Side Brush

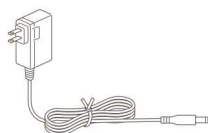

Power Adapter



Cleaning tool



High Performance Filter



User Manual

Product Composition

Host Introduction

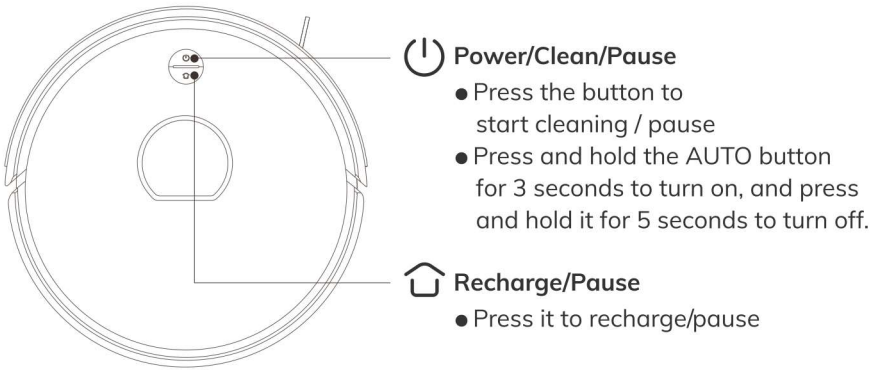

🔌 + 🏠 Indicator status

Status	light
Cleaning	Green light on
Recharging	Green light flickering
Charging	Orange light flickering
Low power	Orange light flickering
Fullycharged	The green light stays on and then goes out
Alarming	Red light flickering
Standby	Off

Product Composition

Sensor and structure

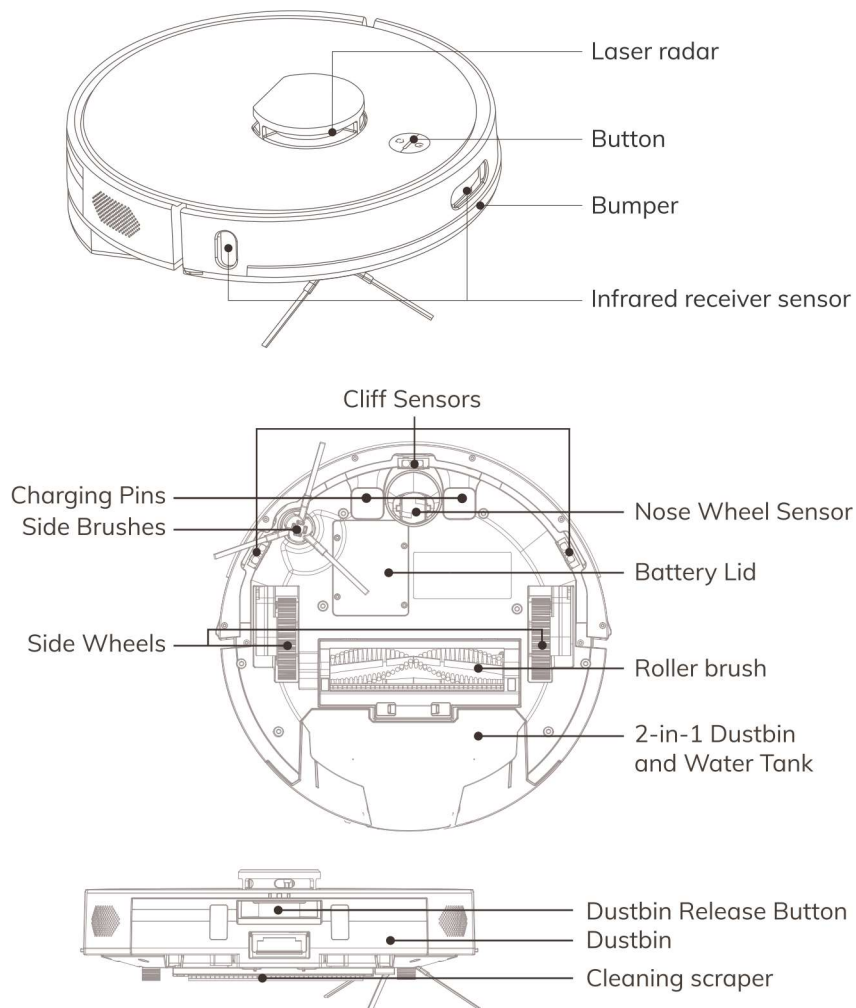

Product Composition

Dust bin assembly

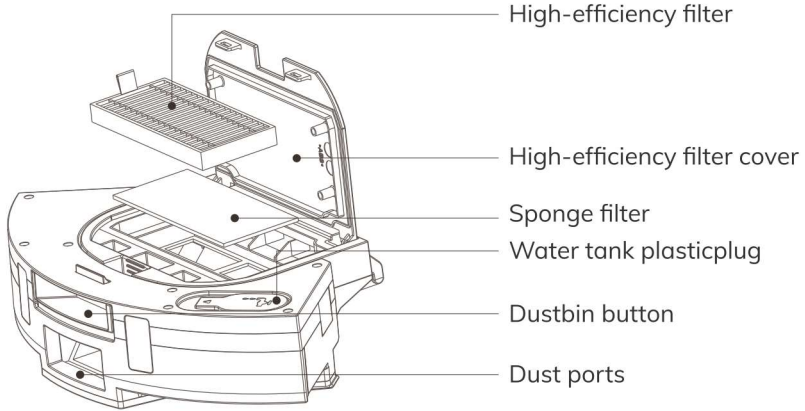

Note:

When the water tank is filled with water, the robot's ability to overcome obstacles and climb hills may be affected.

Charging dock

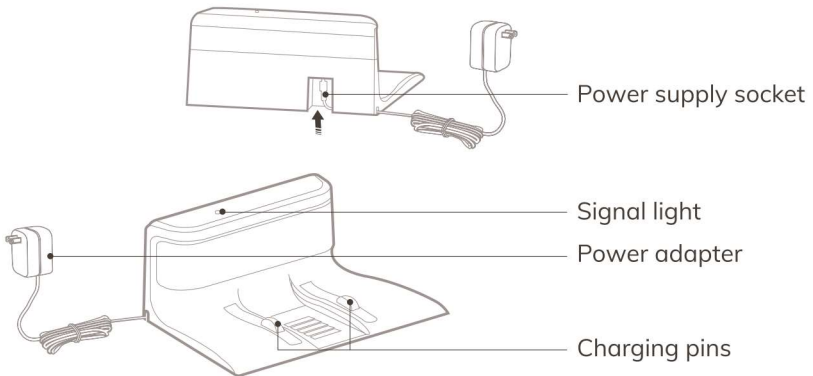

Product Composition

Product specifications

Item	Specification
Diameter	335mm
Height	95mm
Weight	3kg
Power	35W
Battery type	Li-ion
Charging type	Auto Charging / Manual Charging
Dustbin capacity	0.3L
Water tank	0.2L
Cleaning mode	Auto, Spot, Edge, Daily Schedule
Charging time	<360mins
Cleaning time	≥120mins
Main body button type	Mechanical Button



Note:

The company reserves the right of final decision on the interpretation of these terms and conditions.

Product Operation

Attentions

The robot may skip over some areas due to the complexity of the home environment. To achieve the best result, we suggest using it as daily routine and clearing up the obstructions on the floor before starting the robot.

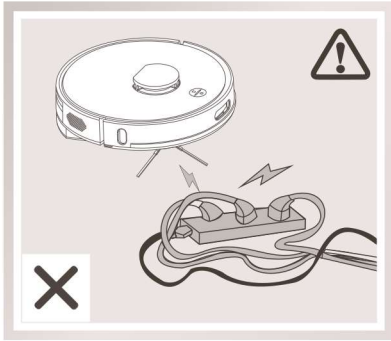

Please move away the power cords and other objects that may tangle the robot before cleaning.

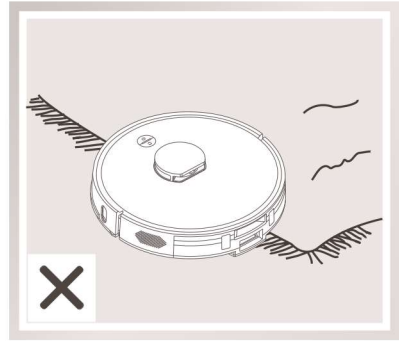

Please fold up the edges of the carpets before cleaning.

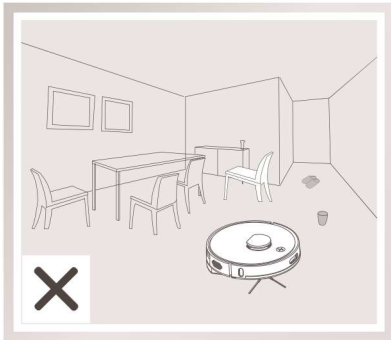

To avoid being stuck during cleaning, please arrange the furniture neatly.

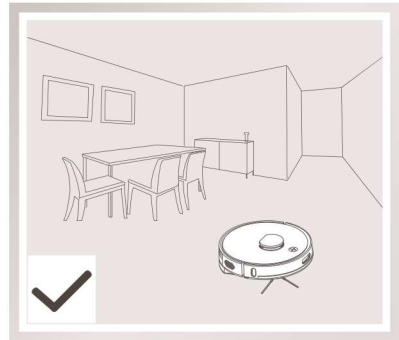

Product Operation

Attentions

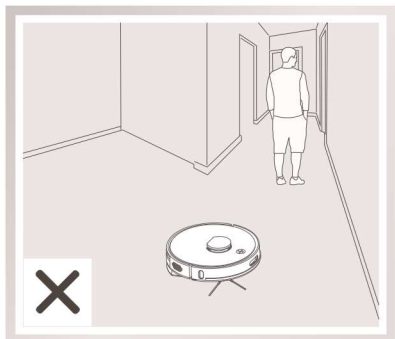

Please do not stand at somewhere with narrow space like the door sill or hallway in case of blocking the robot and skipping over some areas.

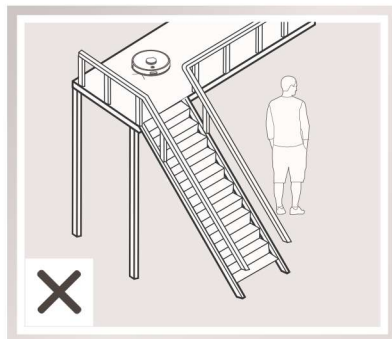

Please do not stand by downstairs when the robot is working upstairs in case of getting injured by any fallen objects.

Product Operation

Charging dock

1 Placement of charging dock

- Connect the adapter with the charging dock.
- Placement of the charging dock: place the charging dock against the wall horizontally and there must be no object on the left and right side within one meter and in the front within two meters. There must also be no reflective object such as a mirror around the dock.
- Connect the power.

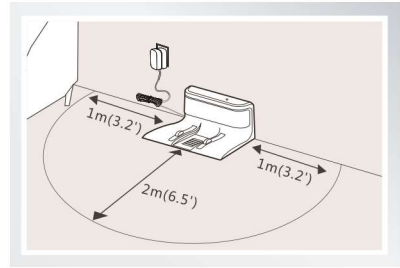
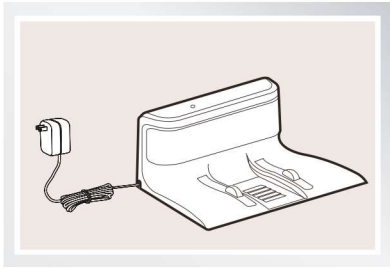

Reminder: When the charging dock is connected to the adapter, the signal light of the dock will light up.

2 Turn on the robot

- Press and hold the AUTO button for 3 seconds to turn on, and press and hold it for 5 seconds to turn off.

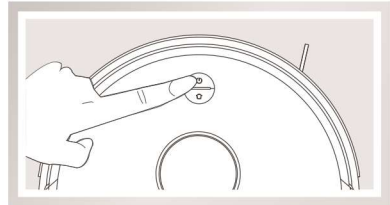

Note:

- After the robot finishes its work, please do not turn it off, and fully recharge it for the next run.
- If the robot pauses working for more than ten minutes, it will enter sleeping mode. If you need to wake up the robot again, you need to press the AUTO button once.

Product Operation

3 Robot charging

1. Please place the robot on the charging dock.
2. If the AUTO button is flashing in orange, the robot is charging. The button will change to green when it is fully charged. Then the light off and the device goes into sleep mode.
3. Charge for 6 hours for the first time.

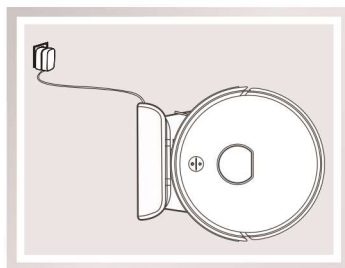

Reminder:

1. Please keep the charging pins clean in daily use to ensure a good connection.
2. Please leave the robot on the charging dock for daily use and make sure that the charging dock is connected to the power and the switch is on.
3. If you won't use the robot for a long time, please fully charge it, turn off the power and keep it in a well-ventilated dry place.

4 Start cleaning

After waking up the robot, you can press the AUTO button once, and the robot will start the automatic cleaning.

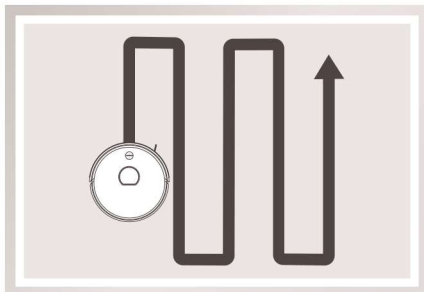
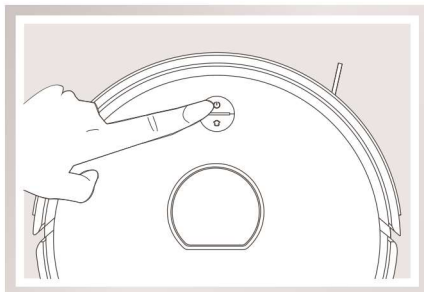

Product Operation

- * Before starting cleaning, you need to make sure that the lights of the robot's AUTO button and HOME button are flashing at the same time, and that the robot is in a wake-up state. If the robot is sleeping, please press the AUTO button once to wake up the robot.
- * If you want to choose other modes, please operate on the APP.
- * The robot performs path planning autonomously during the working process. If it is manually moved or operated by the APP (except pause), the robot will re-plan the path and may re-clean the cleaned area. To ensure the working efficiency of the robot, please do not manipulate the robot. (If the machine is lifted, it will alarm and stop cleaning, and you need to press the Auto button or operate the APP to restart cleaning)

5 Pause

When the robot is working, you can pause the robot by pressing the robot's AUTO button or the "standby" button in the APP.

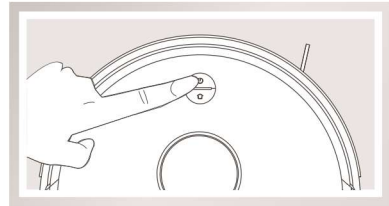

Reminder:

1. The Robot will automatically enter the Sleep Mode if no action is taken for 10 minutes. If you want to start the robot again, please press the AUTO button once to wake up the robot.
2. The robot will work out a new cleaning path, and will clean the areas again which have been cleaned before.

Note: After the sleeping robot in pause mode is woken up again, it needs to be restarted to start cleaning, and the robot will not resume the last unfinished cleaning.

6 Sleep mode

- The Robot will automatically enter the Sleep Mode if no action is taken for 10 minutes.

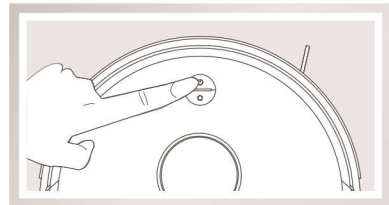

Product Operation

Select cleaning modes

This product can set a variety of cleaning modes through the APP to adapt to different ground conditions and achieve deep cleaning.

1 Auto cleaning

It is the most commonly used cleaning model that the robot automatically cleans according to the planned path. During the cleaning process, it can automatically detect the missing areas and intelligently fill the gaps, making cleaning more efficient.

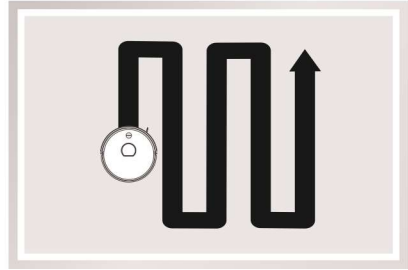

2 Auto charge

The robot can sense lower power during the cleaning process and automatically activate Self-charge Mode and search for the charging dock.

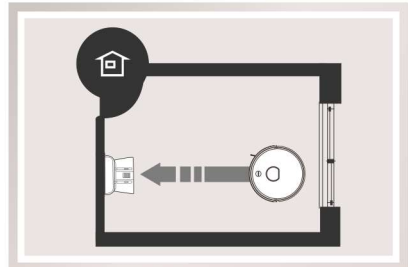

3 Local cleaning

Users can click on the positioning icon on the map on the APP to determine the cleaning location, and then click to clean. The robot will clean a 1.5m*1.5m area with the designated point as the center and an arc shape.

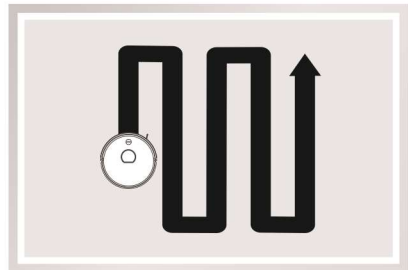

Product Operation

Water tank operation

The water tank with a mopping cloth is installed into the device. Please kindly add water to the water tank before mopping. It is recommended to vacuum the floor before mopping. For daily maintenance, please check out the tips on the corresponding chapter in this manual.



Note:

1. Please do not use water tank components on the carpet .
2. Please pay attention during the mopping mode, timely add water or clean the mopping pad. The water tank needs to be removed when adding water.
3. Be sure to remove the water tank components when charging.

1 Remove the water tank components

Slide back to remove the water tank components.

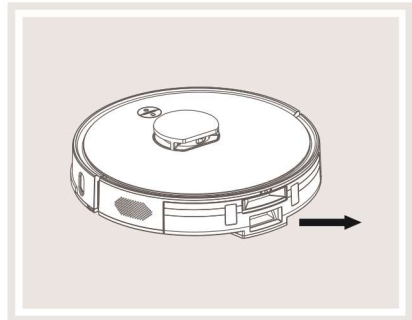

2 Add water

Open the water injection cap and fill it with water. Tightly close the cap once finish water injecting.

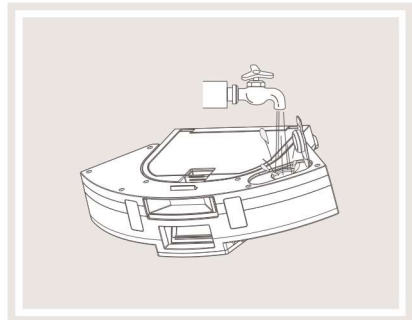

Product Operation

3 Place the mop cloth

Paste a mop cloth.

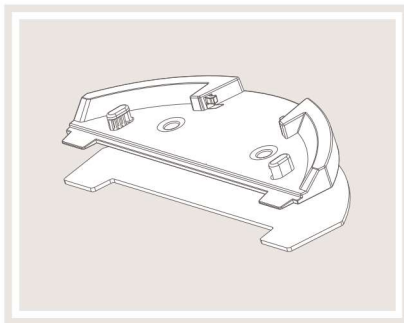

4 Install water tank components

Slide it forward, align it with the clip, and when you hear a "click" sound, it is installed in place, and then you can press the sweep button to automatically execute the corresponding mopping mode.

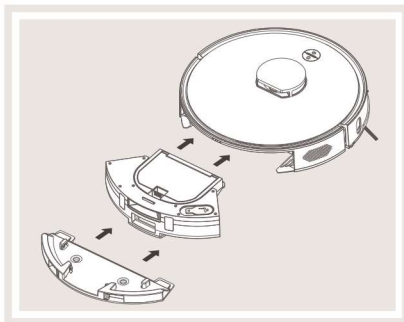

APP Connection

Preparation before connection



 ILIFE Clean

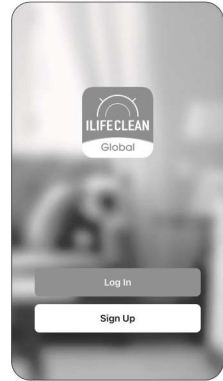

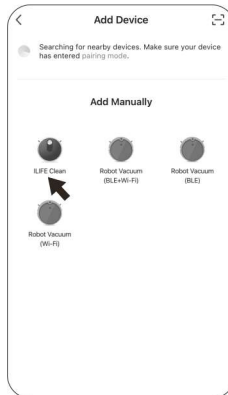
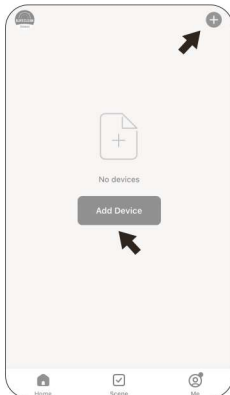

- 1 Scan the QR code to install the app.
- 2 Or search "ILIFE Clean" in the mobile app store to download the APP.
- 3 Register and log into the APP.



- 4 Click "Add a device" or "+" in the top right corner.
- 5 Select ILIFE Clean appliance.
- 6 Select 2.4GHz Wi-Fi network and enter the password.

APP Connection

Hotspot networking (compatible mode)

- 1 First start the robot vacuum cleaner, press and hold the  and  keys on the main unit at the same time for 3 seconds, and when you hear the voice prompt of “AP mode” and the WiFi indicator light flashes slowly, it means that the machine has entered the networking mode.

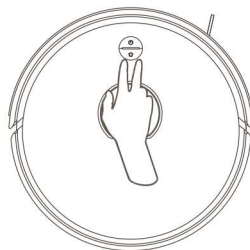

- 2 Select hotspot networking mode and confirm that the WiFi indicator light on the robot vacuum cleaner flashes slowly.

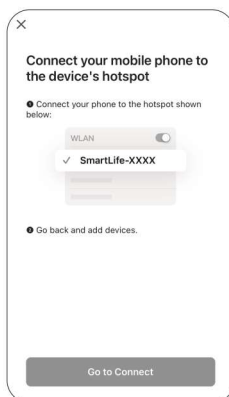

- 3 Read the instructions for hotspot connection carefully and select to connect.



- 4 Select the robot vacuum cleaner hotspot with the beginning of SmartLife, and after connecting successfully, return to the APP.

APP Connection

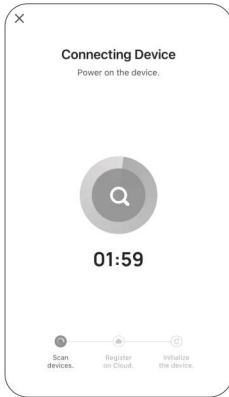

- 5 Wait for the APP to connect to the robot vacuum cleaner.



- 6 After connecting successfully, enter the operation interface.

Connect with Amazon Alexa or Google Assistant

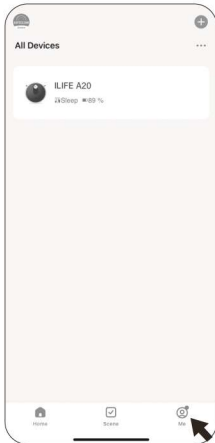

- 1 The robot vacuum cleaner connects to the app first. Click "Me" in the bottom right corner.

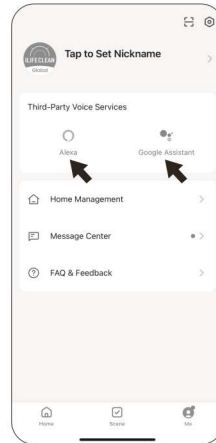

- 2 Click "Alexa" or "google Assistant" to enter the operation interface.

Maintenance

Clean up dustbin and filters

* Please turn off the robot before cleaning any spare parts, and remember to cut off the power.

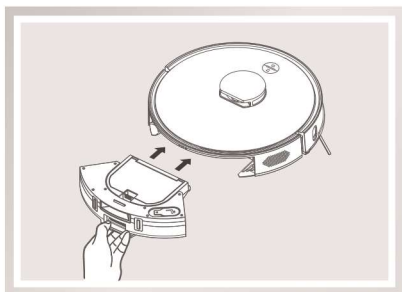
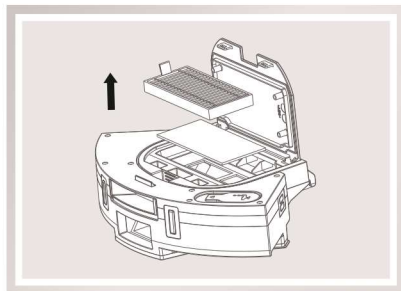
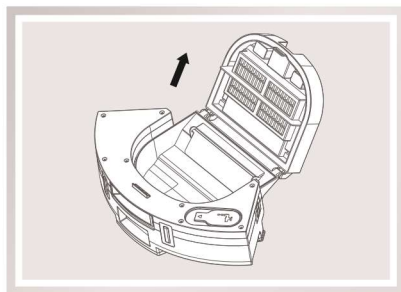
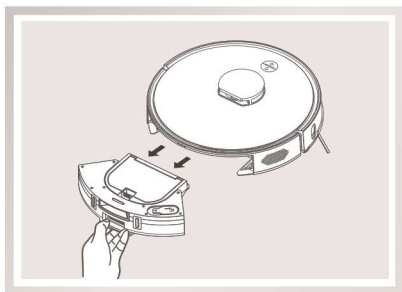

1. Take out the two-in-one water tank from the robot, open the upper cover of the garbage bin, pour out the garbage, and then wipe the garbage bin clean.
2. Open the lid of the trash can, and take out the high-performance filter and dust-proof sponge, then slightly pat the garbage inside, clean it up, put the high-performance filter and dust-proof sponge back in the trash can, and install the trash can back to the robot.

Maintenance

Cleaning of water tank components

1 Clean the mop cloth

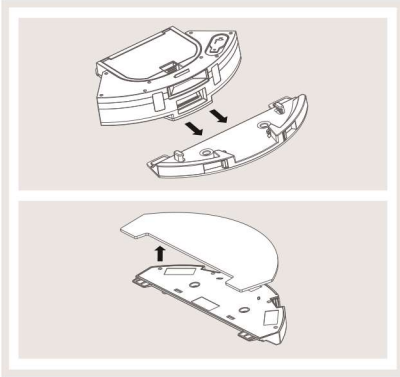

Remove: after mopping, please remove the water tank components and the mop cloth.

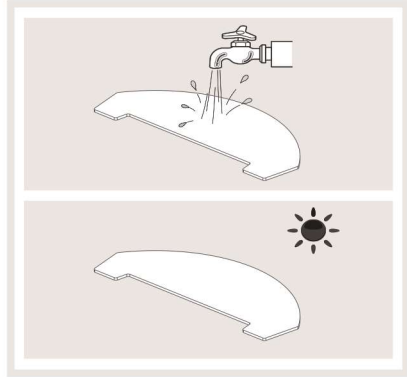

Maintenance: rinse and air dry the mop cloth.

2 Clean the water tank

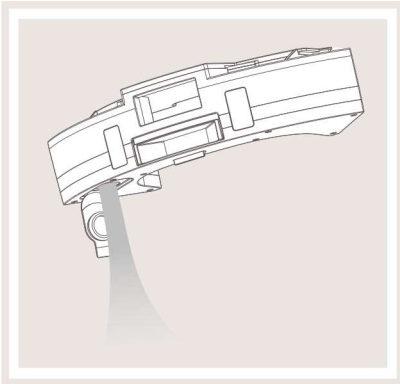

Remove: after mopping, remove the mop cloth and the components, drain the remaining water in the water tank.

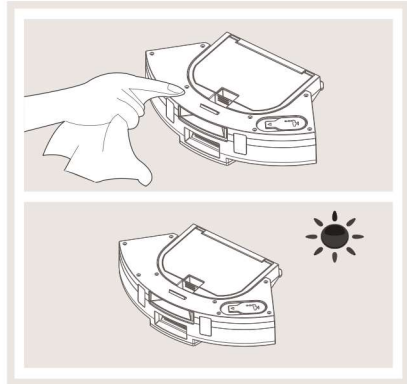

Maintenance: dry the water tank by hand and then air dry it.

Maintenance

Clean up the side brushes

- Remove side brushes. Wipe clean with a clean cloth.

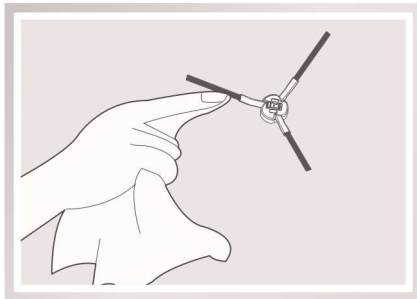
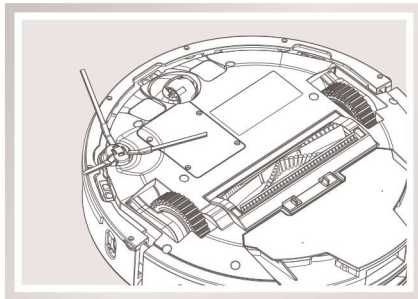

Check side wheels

When a buzzer sounds, turn off the power, and then clear any objects blocking the side wheels.

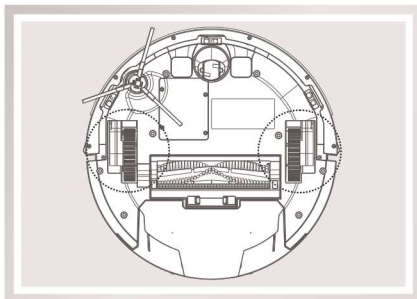

Other spare parts

Please turn off the robot first, then pull out the nose wheel vertically, clean off the hair and foreign objects tangled in the nose wheel, and wipe it with a clean cleaning cloth.

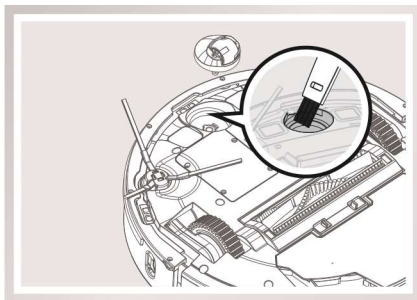

Maintenance

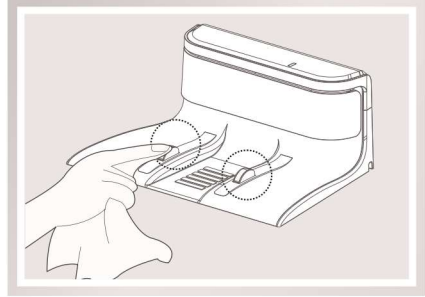
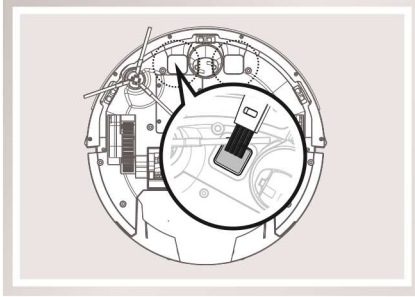

Clean the charging pins on the robot and the charging dock regularly with dry cloth.

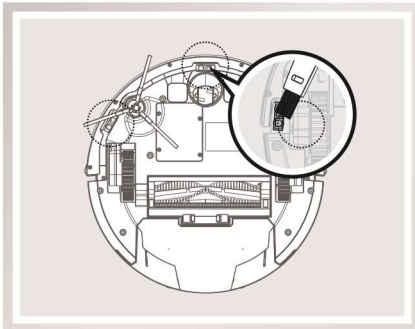

Periodically wipe the sensor with a dry cloth to keep it clean.

- * When the battery is in the depth of discharge state or not in use for a long time, its capacity will be reduced. In this case, we suggest you to activate it again. Charge the robot on the charging dock for 3mins, and repeat 3 times, then fully charge the robot for 5-6hours.
- * The robot uses long cyclic life batteries. There is no need to replace it frequently. Please contact our support team if necessary.

Troubleshooting

Error codes

The robot will remind you by flashing a red light and sounding prompt when it malfunctions.

NO.	Voice content	Trouble cause	What to do
01	The ground sensor is blocked.	The ground sensor is faulty.	Check the ground sensor.
02	The robot gets stuck, please move the robot.	The robot cleans small areas for a long time.	Move the robot.

**Note:**

If the solutions above don't resolve the issue, please try the following:

1. First, press and hold the AUTO button for 5 seconds to turn off the robot, then press and hold the AUTO button for 3 seconds to turn on the robot.
2. If restarting the robot still does not solve the problem, please send the machine to the after-sales center for repair.

FCC Information

NOTE:

This equipment has been tested and found to comply with the limits for a Class B digital device, pursuant to part 15 of the FCC Rules. These limits are designed to provide reasonable protection against harmful interference in a residential installation. This equipment should be installed and operated with minimum distance of 20 cm between the radiator and your body. This equipment generates,uses and can radiate radio frequency energy and, if not installed and used in accordance with the instructions, may cause harmful interference to radio communications. However, there is no guarantee that interference will not occur in a particular installation. If this equipment does cause harmful interference to radio or television reception, which can be determined by turning the equipment off and on, the user is encouraged to try to correct the interference by one or more of the following measures:

- Reorient or relocate the receiving antenna.
- Increase the separation between the equipment and receiver.
- Connect the equipment into an outlet on a circuit different from that to which the receiver is connected.
- Consult the dealer or an experienced radio/TV technician for help.

MODIFICATION:

Any changes or modifications not expressly approved by the grantee of this device could void the user's authority to operate the device.

This device complies with Part 15 of the FCC Rules. Operation is subject to the following two conditions:

- (1) this device may not cause harmful interference,
- and (2) this device must accept any interference received, including interference that may cause undesired operation.