



东莞市一佳电子通讯科技有限公司

Dongguan YiJia Electronics Communication Technology Co.,Ltd.

规格承认书

SPECIFICATION FOR APPROVAL

| | |
|----------------|------------|
| 日期 Date | 2023/06/26 |
| 编号 File No | 23062601 |
| 版本 Revision | 1.0 |

客户
CUSTOMER: 方位

客户料号
CUSTOMER NO: EADA100038A0

品名
PART NAME: WIFI Antenna L=90mm MHF

供方料号
SUPPLIER NO: YJL01.106.052.301A

送样日期Date: 送样数量Q “TY:

| 客户确认CUSTOMER APPROVED BY | | |
|--------------------------|-------|------------|
| APPROVAL | CHIEF | SUPERVISOR |
| | | |

| 供方确认 SUPPLIER SIGNATURE | | |
|---|-------|------------|
| APPROVAL | CHECK | DESIGN |
|  ChenGuoqiang | XieLi | ChenXingyi |

YJ-RD-F04-A

add: 东莞市长安镇沙头社区木鱼路59号元富工业区 Tel:0769-82586086 Fax:0769-82586086
Yuanfu Industrial Zone, No. 59 Muyu Road, Shatou Community, Changan Town, Dongguan City, China



承认书项目表

| NO | 内容 (Contents) | 页数 (Number of Page) | 页码 (Page Code) |
|----|------------------------------|------------------------|-------------------|
| 1 | 承认书封面 (Spec Cover) | 1 | 1 |
| 2 | 承认书项目表 (Spec Item) | 1 | 2 |
| 3 | 工程成品图 (Drawing) | 1 | 3 |
| 4 | 天线规格 (Antenna Specification) | 1 | 4 |
| 5 | S参数测试 (S Parameter) | 1 | 5 |
| 6 | 无源测试 (Passive Test) | 3 | 6 ~ 8 |
| 7 | 有源测试 (Active Test) | 2 | 9 ~ 10 |
| 8 | 天线装配图 (Antenna Profile) | 5 | 11 ~ 15 |
| 9 | 材质证明 (Material Certificate) | 36 | 16 ~ 51 |
| 10 | RoHS报告 (RoHS Test Report) | ** | ** |
| 11 | N/A | N/A | N/A |
| 12 | - | - | - |
| 13 | - | - | - |

RoHS
Compatible

| | |
|----------|--|
| CUSTOMER | |
| PART NO | |

| REV. | DESCRIPTION | DATE |
|------|-------------|------------|
| △ | 首次发行 | 2023-03-09 |
| △ | 修改线材,添加端子 | 2023-04-07 |
| △ | 修改FPC | 2023-05-16 |

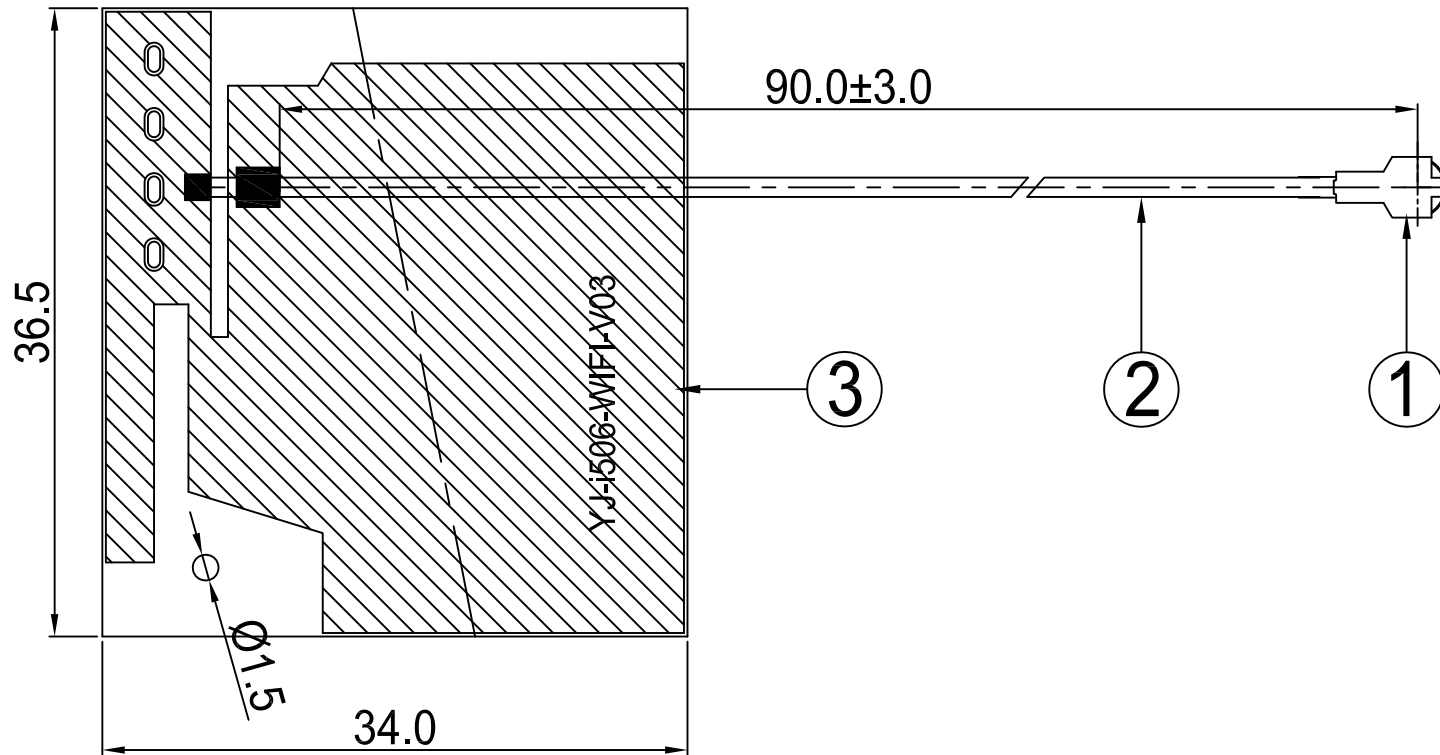

东莞市一佳电子通讯科技有限公司
Dongguan YiJia Electronics Communication Technology Co.,Ltd. Tel:0769-82586086 Fax:0769-82586086

| | | | |
|--|------------|-------------|---|
| PART NAME: WIFI Antenna L=90mm MHF | | | |
| PART NO.: YJL01.106.052.301A | | | DATE: 2023-05-16 |
| APPROVED BY | CHECKED BY | DESIGNED BY | Tolerance X.X ±0.50 X.XX±0.15 X° ±3° |
| 何清军 | 邓磊 | 廖光喜 | |
| UNITS: mm SCALE: 1/1 REVISION: C | | | |

| NO | PART NAME | DESCRIPTION | Material | Part Number | Q.TY |
|----|----------------|----------------|----------|---------------|------|
| 3 | FPC | 36.5*34.0mm | FPC | FPC11XXA.P01 | 1 |
| 2 | Coaxial Cable | O.D.0.81 Black | O.D.0.81 | COA100XXA.P01 | 1 |
| 1 | Mini Connector | Au Plated 3代 | Cu | TER100XXA.P01 | 1 |



天线规格

Antenna Specification

| Electrical Properties | |
|------------------------------|--|
| Frequency | 2.4-2.5GHz 5.15-5.85MHz |
| Impedance | 50 Ohm Nominal |
| V.S.W.R | 2.0 Max |
| Gain | 6.6 dBi@2.4-2.5GHz 5.7 dBi@5.15-5.85MHz |
| Radiation | Omni-directional |
| Polarization | Linear |
| Physical Properties | |
| Connector | 3代IPEX |
| Cable Type | O.D.0.81mm |
| Cable Length | 90mm |
| Cable Color | Black |
| Operating Temp. | -40 ~ +85 °C |
| Storage Temp / Humidity | 25±5°C / <70% |



Agilent E5071B

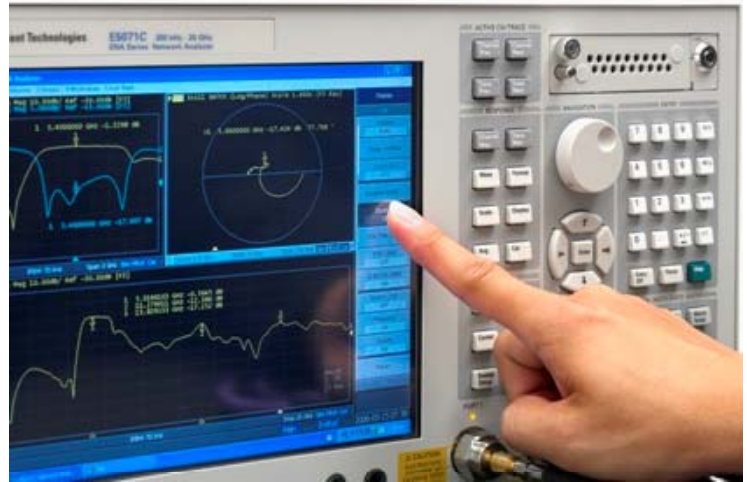

S Parameter Test // WiFi Antenna

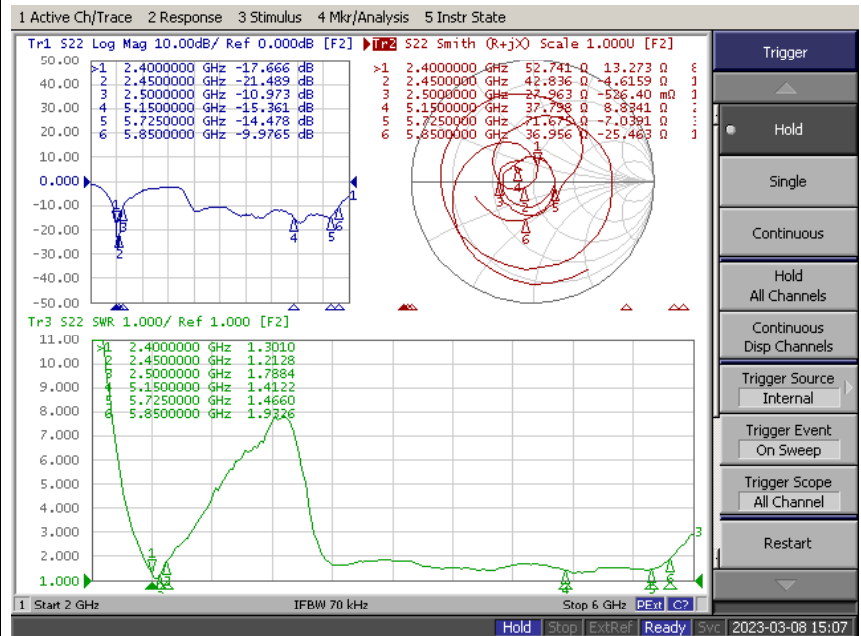



Antenna Passive Test

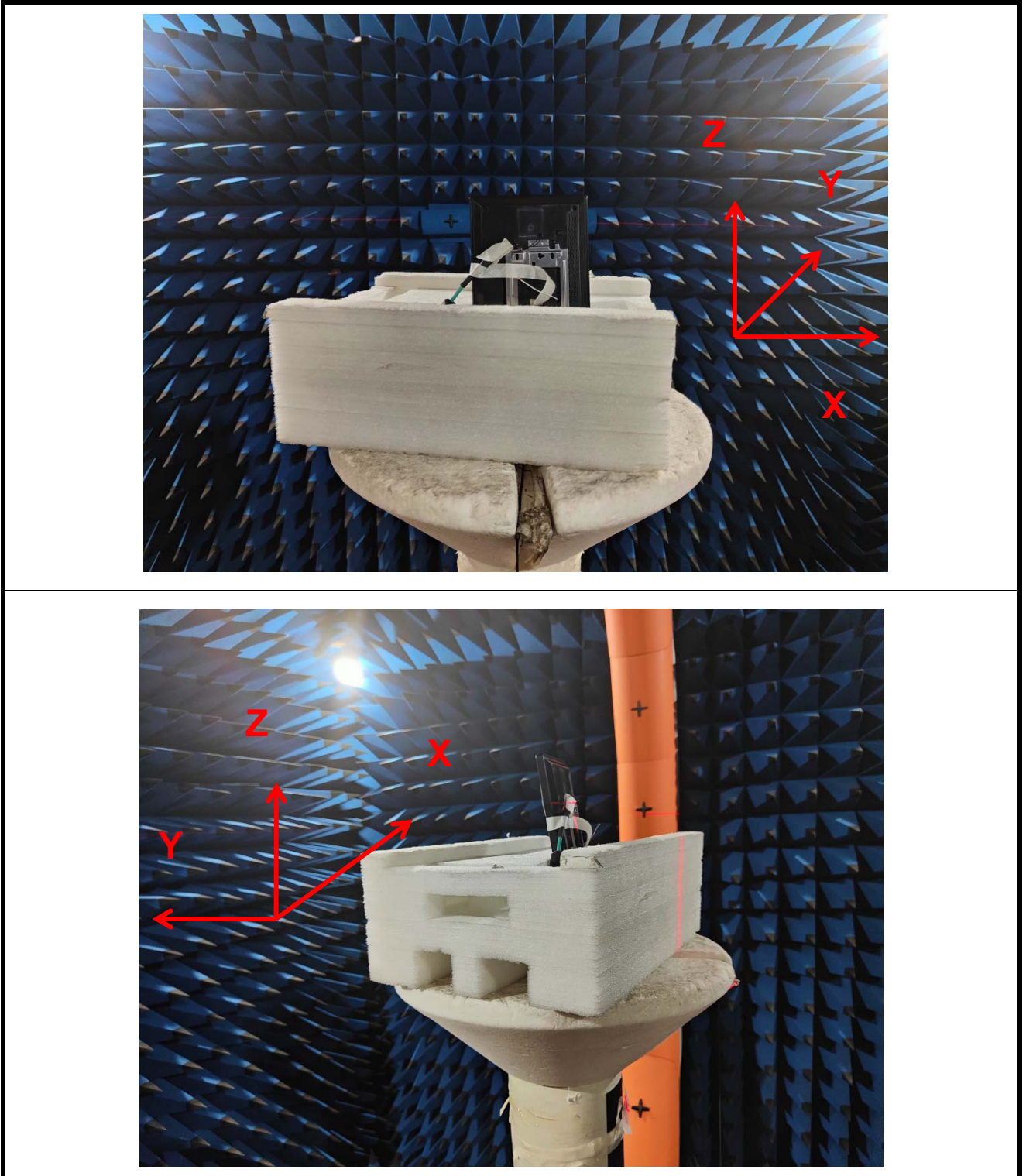



Passive Test For WiFi Antenna (2.4G)

| Freq (MHz) | Effi (%) | Effi (dB) | Gain (dBi) |
|------------|----------|-----------|------------|
| 2400 | 64.6 | -1.9 | 6.0 |
| 2410 | 65.3 | -1.9 | 6.1 |
| 2420 | 64.4 | -1.9 | 5.9 |
| 2430 | 64.4 | -1.9 | 6.1 |
| 2440 | 64.1 | -1.9 | 5.9 |
| 2450 | 65.8 | -1.8 | 6.2 |
| 2460 | 63.8 | -2.0 | 6.2 |
| 2470 | 65.9 | -1.8 | 6.6 |
| 2480 | 63.5 | -2.0 | 6.5 |
| 2490 | 62.7 | -2.0 | 6.5 |
| 2500 | 59.2 | -2.3 | 6.2 |



Passive Test For WiFi Antenna (5.8G)

| Freq (MHz) | Effi (%) | Effi (dB) | Gain (dBi) |
|------------|----------|-----------|------------|
| 5150 | 58.3 | -2.3 | 4.2 |
| 5200 | 63.8 | -2.0 | 4.6 |
| 5250 | 63.2 | -2.0 | 4.6 |
| 5300 | 62.4 | -2.1 | 4.7 |
| 5350 | 61.2 | -2.1 | 4.7 |
| 5400 | 66.4 | -1.8 | 5.3 |
| 5450 | 62.5 | -2.0 | 5.0 |
| 5500 | 56.6 | -2.5 | 4.9 |
| 5550 | 64.4 | -1.9 | 5.7 |
| 5600 | 65.2 | -1.9 | 5.6 |
| 5650 | 57.8 | -2.4 | 5.0 |
| 5700 | 59.2 | -2.3 | 5.0 |
| 5750 | 60.4 | -2.2 | 4.9 |
| 5800 | 53.1 | -2.8 | 4.4 |
| 5850 | 51.2 | -2.9 | 3.9 |



Antenna Active Test

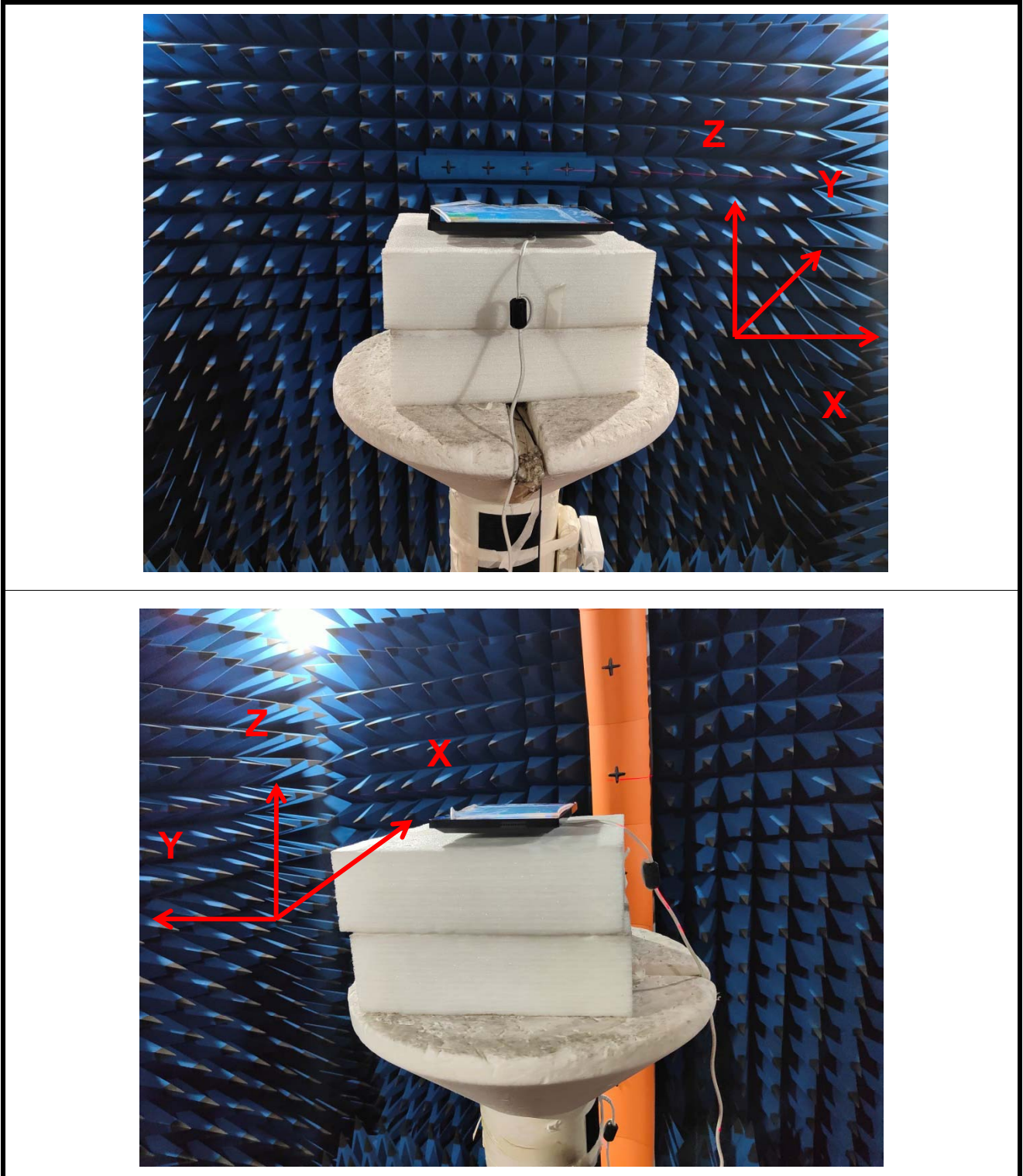



| Active Test For WiFi Antenna | | | | | | | |
|------------------------------|---------|-----------|------|------|-----------|-------|-------|
| Band | Channel | Data Rate | TRP | EIRP | Data Rate | TIS | EIS |
| WiFi 2.4G 802.11b | 1 | 11Mbps | 16.9 | 23.3 | 11Mbps | -79.1 | -86.6 |
| | 7 | | 17.5 | 23.6 | | -82.9 | -89.7 |
| | 13 | | 16.7 | 23.8 | | -82.7 | -89.7 |
| WiFi 5.8G 802.11a | 149 | 6Mbps | 15.0 | 22.4 | 54Mbps | -72.9 | -80.4 |
| | 157 | | 15.1 | 22.7 | | -73.0 | -80.6 |
| | 165 | | 15.7 | 23.2 | | -72.6 | -80.4 |

add: 东莞市长安镇沙头社区木鱼路59号元富工业区 Tel:0769-82586086 Fax:0769-82586086
Yuanfu Industrial Zone, No. 59 Muyu Road, Shatou Community, Changan Town, Dongguan City, China



Device





WiFi Antenna

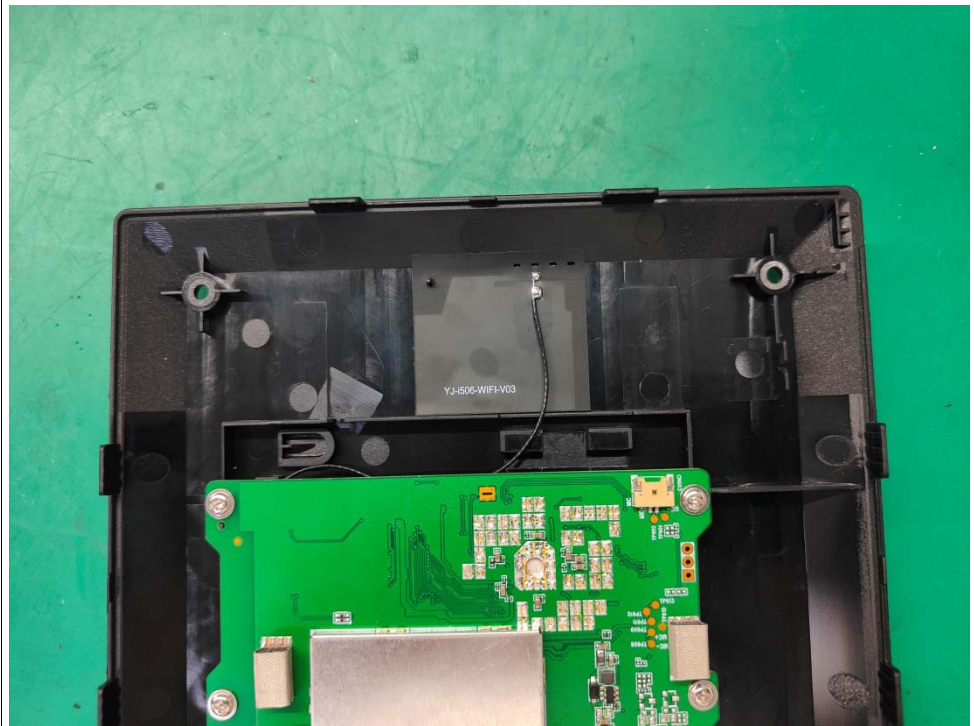



433MHz Antenna

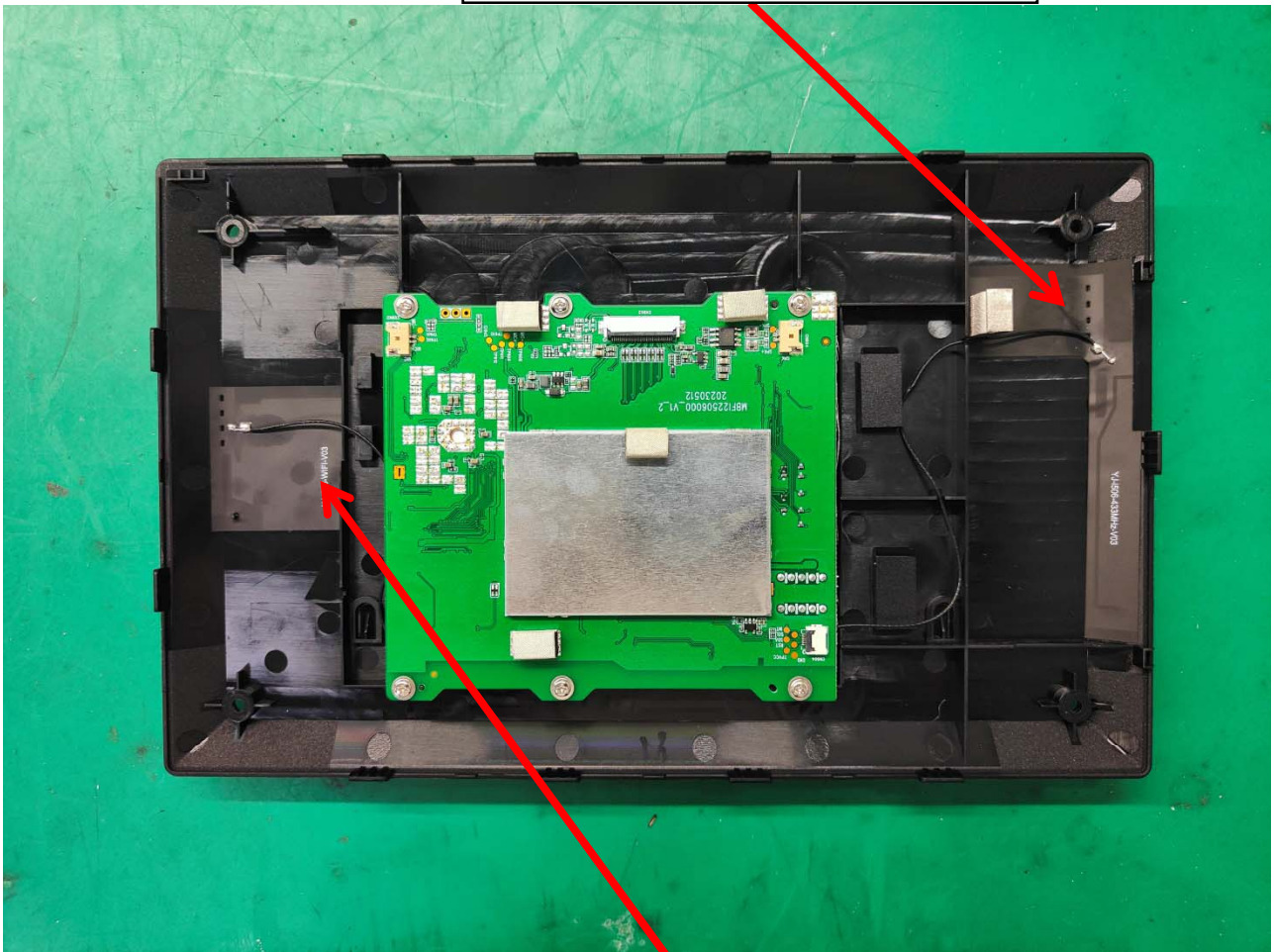

WiFi Antenna



贴导电泡棉将主板
与屏接地

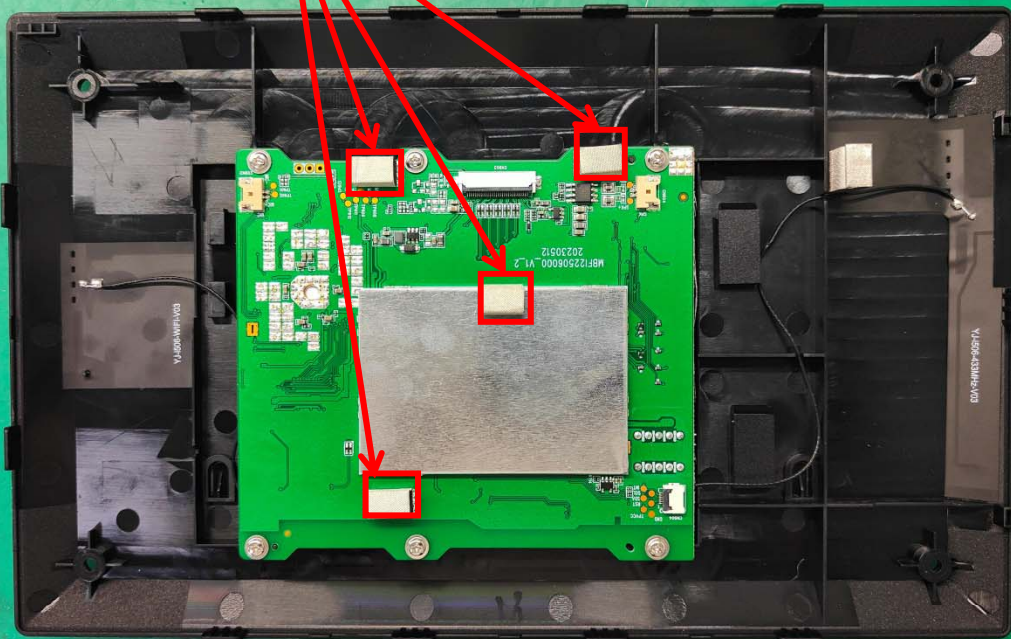



排线贴导电布做屏蔽处理

贴导电布将排线屏蔽并接地

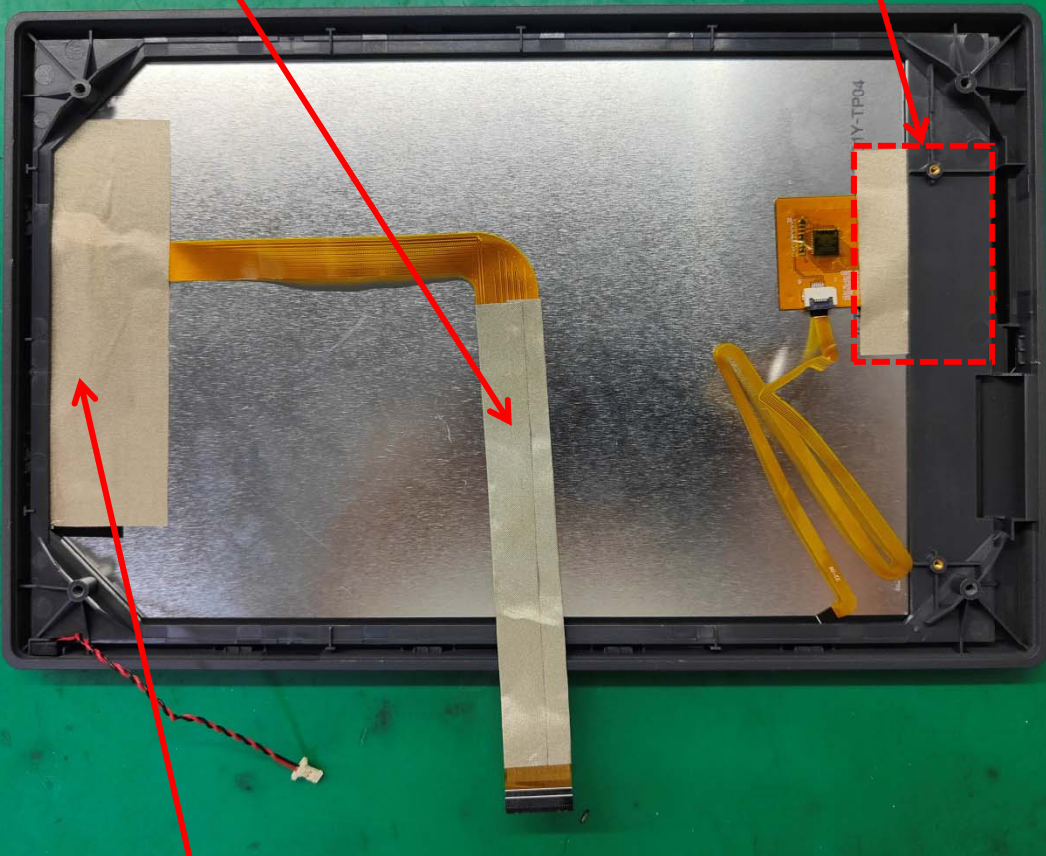

贴导电布将排线做屏蔽并接地

First, chemical products and materials for business

| |
|--|
| Chemical name: PSM-800FSDM-A/SMH-800 liquid solid plate ink |
| Other names: |
| Use and restricted use of construction: flexible printed circuit board (PI/Cu), hand machine roof board |
| Name, address and address of the creator, entrant or supplier: Creator: Yueli Reachability Co., Ltd. Address: No.22 Jingjian Fourth Road, Guanyin District, Taoyuan City: 886-3-4836651 |
| Urgent/true: 886-3-4836651, true: 886-3-4837487 |

Second, the hazard identification of resources and materials

| |
|--|
| Hazard classification of chemical products: |
| Health and environmental hazards: Acute toxicity (swallowing) 4, rot/skin irritation 2, heavy weight/eye irritation 2, skin Pass sensitive substance first, carcinogenic substance second, and hazardous substance second (acute toxicity). |
| Indication of content: |
| Symbol number: |
|  |
| Warning language: |
| Warning hazard |
| warning interest: |
| <p>Harmful to swallow Cause skin irritation Causing severe eye irritation may cause skin hypersensitivity and suspected carcinogenesis Toxic to aquatic organisms</p> |
| Hazard prevention measures: |
| <p>Put the container in a place with good ventilation far away from the high temperature Do not eat or drink when using Remove the blindfold/face mask immediately when your clothes are contaminated If you touch your eyes, wash them with plenty of water immediately, and then ask the mud to wear suitable gloves Do not inhale gas/gas/steam gas/gas before use Place it in the upper lock Do not place until you know all safety precautions Avoid releasing release in the environment</p> |
| Other hazards:- |



安全資料表

版權 2021-01-10

capital mixture:

| Liquid solid plate ink PSM-800FSDM-A/SMH-800 | | |
|---|--|---|
| Chemical geology: | | |
| Chinese and English names of hazardous components | Register number of Chemical Digest Service (CAS No.) | Degree or degree (percentage of components) |
| Oxygen acrylate oligmer Epoxy acrylate oligmer | 28064-14-4 | 50% |
| Silicon dioxide Fused silica | 7631-86-9 | 13% |
| Aromatic solution | 64742-94-5 | 4% |



安全資料表

版權 2021-01-10

| | | |
|-------------------------------|------------|------|
| Methyl dipropylene glycol | 34590-94-8 | 4% |
| Carbon black | 1333-86-4 | 3.5% |
| BaSO4 sulfate | 13462-86-7 | 24% |
| Photoinitiator and the others | 5495-84-1 | 1.5% |

Fourth, first aid measures

| |
|---|
| <p>First aid methods for the same road:</p> <p>Inhalation: 1. Take self-protection measures before rescue.</p> <p>2. Remove pollution sources or move patients to new places.</p> <p>3. If a patient stops breathing, artificial respiration should be given immediately by the person who has been adalmed. If the heart stops, cardiopulmonary resuscitation should be given. When the patient inhales and swallows toxic substances, mouth-to-mouth artificial respiration should be used directly, and pocket masks and other medical equipment should be used for artificial respiration.</p> <p>4. Maintain the patient's safety and normal temperature. 6. Treat the cure quickly.</p> <p>Pi Mo: Wash the contaminated area with harmonious water for at least 20 minutes, and remove contaminated clothes, shoes and leather products before water. Eye touching: Immediately open the eyelids and wash the contaminated eyes with water for at least 20 minutes, and immediately take care of them.</p> <p>Intake: 1. If the patient will be frustrated, or has been frustrated, he can feed anything.</p> <p>2. It can induce vomiting and give 240-300ml of water.</p> <p>3. If you vomit spontaneously, rinse your mouth and supply water repeatedly.</p> |
| The most important diseases and harmful effects:- |
| Protection against first aid workers:- |
| Tips for doctors:- |

V. Fire measures

| |
|--|
| Suitable for fire: chemical dry powder, wine foam, carbon dioxide, water, fire: water, water, foam water. |
| <p>Special hazards that may be encountered during fire;</p> <p>1. Its steam gas and decomposition products are burning and toxic.</p> <p>2. Its steam gas is heavier than its empty gas, and it can spread to distant fire sources and give birth to tempering.</p> <p>3. The combination of steam and big gas may lead to explosion.</p> <p>4. When this object is indoors, outdoors or in sewers, it is in danger of steam explosion.</p> |
| <p>Special Fire Procedure:</p> <p>1. In a safe distance from the place of fire, keep in the upwind position.</p> <p>2. You can use water containers to disperse steam gas to wash the leakage and sparse the leakage, so as to protect the rescue staff.</p> <p>3. Water in the flame of the container around, so that the container is cold, until the fire is cold. Keep the bottom of the container safe.</p> <p>4. Poker or move all ignition sources.</p> |
| Special protection of firefighters: Firefighters must wear air respirators, fire clothing and protection gloves. |

VI. Leakage and management methods

| |
|---|
| <p>Things people should pay attention to:</p> <p>1. Restrict personnel from entering until the spillover area is completely cleaned up.</p> <p>2. The work of cleaning up by the person who is negated.</p> <p>3. Wear appropriate civil air defense.</p> |
| <p>Attention to matters in the environment:</p> <p>1. Remove the ignition source.</p> <p>2. Maintain ventilation in the leakage area.</p> <p>3. Be in the upper wind and avoid going into the lower place.</p> <p>4. Remove or separate burning and combustible materials under conditions that endanger the safety of people.</p> <p>5. At least 100 to 200 meters away from the pollution source.</p> |
| <p>Cleaning method:</p> <p>1. You can touch the leaked materials.</p> |

2. Avoid leakage entering sewers or dense spaces.
3. Where safety permits, prevent or reduce spills.
4. Block the leakage with soil, sand or similar and combustible objects that will respond to the leakage.
5. When there is a small amount of spill, it should be absorbed by the reaction with the leakage. Contaminated absorbed and discharged materials have the same model
6. Harmfulness must be placed in the appropriate container that is covered and indicated. Wash the spill area with water.
7. When there is a large amount of spill: fire fighting, emergency management and business response to seek help.

VII. Safe Location and Storage Methods

Place:

1. It is stored in a place where it is dry and ventilated, and avoids direct light and ignition source.
2. Far away things such as strong oxides, strong acids and water.
3. Use grounding, use the device without spark, and ventilate the wind system.
4. Store a small amount in the refrigerator, and use the explosion-proof refrigerator.
5. Department of police reports leaked outside the city.
6. It is necessary to separate the storage area from the work area, restrict people from entering and leaving the storage area, and show warnings.
7. Avoid collision, and the nearest fire system.
8. You can work alone, and another person needs to be on standby for rescue.
9. In the work area, use the containers that can be used to burn the liquid body, and all the barrels and slots should be grounded, and the containers must be connected to each other.
10. Use the smallest possible amount, and use a suitable ventilation system in the designated area.
11. The target indication container should be covered when in use.

Storage:

1. It is stored in a place where it is dry and ventilated, and avoids direct light and ignition source.
2. Store a small amount in the refrigerator, and use the explosion-proof refrigerator.
3. It is necessary to separate the storage area from the work area, restrict people from entering and leaving the storage area, and show warnings.
4. The target indication container should be covered when in use.

Eight, the preventive measures

Engineering control:

1. The wind system of the single use of the step to generate sparks and grounding.
2. The discharge port leads directly to the outside, and the important measures for protection are taken.
3. When using this object in large quantities, it may be necessary to install local gas and process dense.
4. Supply fully new and fresh air gas to supplement the air gas drawn out by filling and discharging the air gas system.

Control number:-

Average capacitance of eight small hours/average capacitance of short hours/maximum capacitance:-

Biological fingerprint:-

Civil air defense:

- :: Breathing protection: 1. Chemical materials containing machine vapor poison cans or self-made breathing protection equipment.
2. Constant quantity type gas supply type breathing protection device, animation type breathing protection device containing machine steamed gas pot, mask containing machine steamed gas pot, comprehensive self-galvanizing breathing protection device, comprehensive gas supply type breathing protection device, and comprehensive chemical school poison breathing protection device containing machine steam poison pot. 3. Positive full-blown breathing protection equipment or positive full-blown gas-supplied breathing protection equipment with auxiliary positive self-blown breathing protection equipment.
4. There is a mask for steaming gas canister, and an escape type self-breathing protection tool.
- Hand protection: Butyl rubber is the best, chlorinated polyethylene, polyvinyl acid, fluorinated cortex, butyl rubber/chloroprene rubber, fluorinated rubber, chloroprene rubber/natural rubber galaxy cover, fluorinated cortex/chloroprene rubber are also good anti-scorching gloves.
- Eye protection: 1. Anti-chemical safety eye protection.
2. Full cover.
3. Don't wear shaped eyes.
1. Work shoes and body clothes.
2. There should be a bath/wash in the work area.

The measures for living:

1. Remove contaminated clothes quickly after work, and then wear them after washing them.



安全資料表

版權 2021-01-10

- 2. The work place is forbidden to smoke cigarettes or eat.
- 3. After taking care of this thing, you must wash your hands.
- 4. Keep the property clean.

IX. Physical and Chemical Geology

| | |
|--|---|
| Outside (physical state, color, etc.): black cream | Gas flavor: bad smell |
| Olfactory value:- | Melting level:-25 °C |
| PH value:- | Boiling/boiling: 218-219 °C |
| Combustibility (solid and gas):- | Fire: > 75 °C |
| Decomposition temperature:- | The method of wearing a cup: () carrying a cup (V) wearing a cup |
| Spontaneous combustion temperature: spontaneous combustion | Explosion boundary:- |
| Steaming gas:- | Steaming density: 6.07 |
| Density: 1.24 ~ 1.26 (water = 1) | Solubility: Slightly soluble in water |
| Octanol/water partition number (log Kow):- | Dispersion rate:- |

X. Stability and Reaction

| |
|---|
| Stability: Stability under sealed dry container. |
| Possible hazard response under special conditions:- |
| Types to be avoided: leakage, flame and other ignition sources. |
| Things to avoid: acid, oxidation |
| Hazardous decomposition: carbon monoxide |

XI. Toxic Materials

| |
|---|
| The road: leather, inhalation, eyes, food |
| Symptoms: irritation, drowsiness, dizziness, tiredness, pain, nausea, difficulty breathing and |
| Acute toxicity: Inhalation: 1. Steaming gas will irritate nose, throat and lungs. Pi Fou: 1. Liquid body or solution will cause heavy irritation and burning pain. 2. Steaming gas can cause irritation. 3. After being picked up by the skin, the liquid will be absorbed to the poisoned amount. Eyes: 1. Steaming gas will irritate eyes and stimulate them. 2. Liquid body will cause heavy burning and injury to eyes. Intake: 1. It will cause bright local irritation to the mouth and digestive tract. |
| Chronic toxicity or long-term toxicity:- |

Twelve, raw materials

| |
|---|
| Raw toxicity:- |
| Persistence and degradation: Avoid entering the water source inlet and waterway, which is harmful to aquatic organisms. |
| Bioaccumulability:- |
| Reactionality in soil:- |
| Other good effects:- |

XIII. Methods of abandoning and abandoning places

| |
|--|
| Discarding method: 1. Examining the principle of phase method. 2. According to the pieces of the store to be disposed of waste materials. 3. Specific incineration or burial can be used. |
|--|

Fourteen, Dictate to send materials

| |
|------------------------|
| Lian He Guo Bian No.:- |
|------------------------|



安全資料表

版權 2021-01-10

| |
|---|
| The name of the joint country is:- |
| Classification of the hazards of Dirk: It is judged as ordinary goods according to Fujian Commercial Report 0128227 |
| Packaging and fitting: It can be arranged according to ordinary goods |
| Marine pollutants (yes/no): no |
| Special delivery methods and precautions:- |

XV. French Materials

| |
|---|
| Suitable usage: |
| 1. If you work safely, you will be able to apply it |
| 2. Road traffic safety rules |
| 3. Methods and standards for the storage and removal of waste materials |
| 4. Harmful academic products and general knowledge |
| 5. What you can do in your work, what you can do, and what you can do |

XVI. Other materials

| | | |
|-----------------------|--|---------------------------|
| Take part in the text | 1. RTECS Materials, TOMES PLUS CD-ROM, Vol. 41, 1999 2. HSDB Materials, TOMES PLUS CD-ROM, Vol. 41, 1999 | |
| Superficial site | Mingjia: Youli Lian Lian Co., Ltd. Address/: No.22, Jingjian Fourth Road, Guanyin District, Taoyuan City: 886-3-4836651 | |
| Table person | Calling for: the principle of science and technology | Name (Seal): Huang Zhihui |
| Table date | 2021.01 1.10 | |
| Per | Among the above-mentioned materials, "-" means that there is no related materials at present, while the symbol number "/" means that this person is compatible with the material and is suitable for use | |

The above-mentioned materials are provided by our company, which is correct for the above-mentioned materials, but it is still difficult to avoid them. The materials and materials of each project are only for reference, and users should judge their availability according to their corresponding needs.

SECTION 1 PRODUCT AND COMPANY IDENTIFICATION

- 1.1 Material Name: Flexible Copper-Clad Polyimide Laminates
1.2 Part Number: LPI-HF
1.3 Use of Material: Printed Circuit Boards
1.4 Date of Prepared: April 22nd, 2021
1.5 Company Identification: Jiu Jiang Flex Co., Ltd.
1210Qianjin Road (E) Jiujiang, Jiangxi, China 332006
1.6 Emergency Telephone Number: 86-792-8358899
1.7 Telephone Number for Information: 86-792-8358899, 8355813

SECTION 2 COMPOSITION/INFORMATION ON INGREDIENTS

| Composition / substance | | CAS# | % |
|-------------------------|------------------------------------|-------------|-------------|
| PI | polyimide | 25038-81-7 | 2.93~28.11 |
| Adhesive | Epoxy resin | 25036-25-3 | 2.42~6.81 |
| | Flame Retardant (additive type) | 225789-38-8 | 0.49~1.36 |
| | Rubber | 9003-18-3 | 1.45~3.99 |
| Copper foil | Copper | 7440-50-8 | 92.66~59.72 |

SECTION 3 HAZARDOUS IDENTIFICATION

Dust, soot, combustion gases produced when burning, of inhaled, ingested or absorbed through skin it will be harmful or irritating to the eyes, skin, mucous membrane, respiratory system, allergies can be caused to skin, flammable irritating and sensitive.

SECTION 4 FIRST-AID MEASURES (on Dust)

Inhalation:

Remove to fresh air. Obtain medical attention if symptoms persist.

Eye Contact:

Flush immediately with large amounts of water. Do not rub eyes. Obtain medical attention if symptoms persist.

Skin Contact:

Wash area of contact thoroughly with soap and water. Do not rub or scratch. Obtain medical attention if symptoms persist.

Ingestion: Drinking water as much as possible, emetic, and see doctor.

SECTION 5 FIRE FIGHTING MEASURES

Extinguishing Agents

Following extinguishing media can be used:

Carbon dioxide extinguisher

Dry powder fire extinguisher

Water Pump

Foam fire extinguisher

Hazards of Unusual burning and Explosion:

The material produces carbon monoxide, carbon dioxide, nitrogen, oxides of nitrogen, smoke and dust when extremely high temperature or burning.

Personal Protective Equipment

As in any burning, wear self-contained breathing apparatus and full protective gear.

Upper limit of Flammability: not ascertained

SECTION 6 EMERGENCY HANDLING OF LEAKAGE

Emergency handling:

Block the leakage area to avoid dust flying and wear protective equipment, use vacuum cleaner to clean the leakage.

SECTION 7 HANDLING AND STORAGE

Handling: Wear cotton gloves to protect product damage and hand lacerated.

Storage conditions

The material should be stored in dry, ambient temperature wrapped with PE film.

Environment: Keep away from heat, ignition sources, and direct sunlight.

Other conditions: Keep cartons tightly closed when not in use.

SECTION 8 EXPOSURE CONTROLS / PERSONAL PROTECTION

Respiratory protection:

No general requirements. If the occurrence of dust, gas or smoke processing or processing, is stimulating to employees, to use NIOSH/MSHA approved respiratory protection measures. Engineering control should be excluded from the need for respiratory support.

Ventilation:

Once air exhaust exposure exceeds limits, or visible smoke, dust, exhaust gas, the ventilation at site should be accompanied by all the heat process at the same time.

Mechanical operations:

Optimize and follow good industrial operation as possible as you can.

Eye Contact:

With eye-glasses on during all process

SECTION 9 PHYSICAL AND CHEMICAL PROPERTIES

| | |
|---|--|
| Appearance | PI film Copper-Clad Laminate with adhesive |
| Physical State: | solid |
| PH: | Not Applicable |
| Melting point: | no data |
| Relative density (water =1): | more than 1 |
| Boiling point: | no data |
| The relative vapor density (air =1): | more than 1 |
| Saturated vapor pressure (kPa): | Not Applicable |
| Heat of combustion (kJ/mol): | no data |
| The critical temperature (c): | Not Applicable |
| The critical pressure (MPa): | Not Applicable |
| The octanol / water partition coefficient of numerical: | Not Applicable |
| Flash point (°C): | Not Applicable |
| Upper explosive limit% (V/V): | Not Applicable |
| Ignition temperature (c): | no data |
| The lower limit of explosion% (V/V): | Not Applicable |
| Solubility: | insoluble |
| Application: | used for making printed circuit board |

SECTION 10 STABILITY AND REACTIVITY

Stability:

Storage for one year at 5°C to 30°C and RH less than 75%

Conditions to Avoid:

High Humidity, direct sunlight,

The copper side may have violent reaction with followings:

Acetylene, ammonium nitrate, bromide, chlorate, iodic acid, chlorine, ClF₃, Pb (N₃)₂, (Cl₂+OF₂), ethylene oxide, fluoride, hydrogen peroxide, nitric acid hydrazide, hydrazoic acid, H₂S, K₂O₂, NaN₃, Na₂O₂.

SECTION 11 TOXICOLOGICAL INFORMATION

Sensitization: Long time skin contact may cause dermatitis

Acute Poisoning: Inhalation of dust may cause thirst, fever, headache, weakness, symptom of respiratory disorders.

SECTION 12 ECOLOGICAL INFORMATION

Normal condition: No big influence may caused to ecology.

Waste Disposal Method

To dispose based on local, state or national laws.

Tank treatment: Not applicable.

SECTION 13 DISPOSAL CONSIDERATION

Hazardous wastage: NO.

Waste Disposal Method

To bury or burn at specified place based on national laws.

SECTION 14 TRANSPORTATION INFORMATION

No special regulation on this product for domestic or international transportation.

SECTION 15 REGULATORY INFORMATION

Must be complied with domestic or local regulation

SECTION 16 REGULATORY INFORMATION

14.1 INTERNATIONAL REGULATIONS:

EU Directive 2011/65/EU (RoHS): Compliant

SECTION 17 OTHER INFORMATION

Issued by: QC Department of Jiu Jiang Flex Co., Ltd

Disclaimer:

The data sheet information is true and accurate, but all statements and recommendations do not contain any guarantee. The consequence of the material shall be from practice. This report does not include all the circumstances that the user may encounter during operation. Each aspect of the operation may be increased or decreased during operation. All health and safety information contained in this report shall be submitted to you employees and customers. Users are responsible to take appropriate measures in practical operations.

MATERIAL SAFETY DATA SHEET

产品安全资料

Section 1 Preparation Identification and Company 样品标公司

Preparation Identification 标记: 防氧化原液DX-808HT

Manufacturers Name 公司名称: 深圳市东方星化工科技有限公司

Manufacturers Address 地址: 东莞市虎门镇大宁村大板地工业区

Emergency Telephone Number 联系电话: 0769-85015502

Emergency Tex Number 传真: 0769-85015500

Postal code 邮政编码: 523900

Section 2 Composition information on Ingredients

成份组成

学名

化学文摘社登记号码

浓度(%)

(Chemical Name)

(CASNO)

(Concentration)

苯并咪唑 Benzimidazole

95-14-7

1%

甲酸 Formic acid

64-18-6

3%

添加剂 Additives

0.05%

DI 水DI water

7732-18-5

95.95%

Section 3 Hazards Identification

危险性概述

Safety and Risk 安全和危险性: DX-808HT contain formic acid which may cause severe burns. 含有甲酸可能导致灼伤

Section 4 First Aid Measures

急救措施

Eyes 眼睛: flush with plenty of clean, cool water for 15 minutes and get immediate medical attention 大量清水冲洗并尽快就医

Skin 皮肤: flush with plenty of clean, cool water for 15 minutes 大量清水冲洗15 分钟

Ingestion 食入: get immediate medical attention 尽快就医

Section 5 Fire Fighting Measures

消防措施

不可燃

Section 6 Accidental Release Measures

泄漏应急措施

Personal Precautions 个人防护: wears protective clothing, chemical safety goggles, respirator, face shield and rubber gloves 穿戴耐酸防护服, 护目镜、面罩和橡胶手套

Clean-up Procedure 清洗: flush with plenty of clean, cool water 用大量清水冲洗

Section 7 Handling and Storage

操作与储存

Ventilation 通风: Store indoors in a cool dry area

阴凉干燥处

Temperature 温度: Store indoors in a cool dry area

阴凉干燥处

Containers 容器: Keep containers tightly closed. Loosen closure cautiously when opening. 保持容器密封, 打开时慎重

Incompatible Materials 不相容物质: alkalis and oxidizers 碱性和氧化物

Pot Life 有效期: six months 6 个月

Section 8 Exposure Controls /Personal Protection 接触控制与个人防护

Ventilation 通风: Exhaust ventilation is recommended 推荐抽出式通风

Respiration 呼吸: respirator。Avoid breathing vapors or mist。防毒面具
避免吸入蒸汽或烟雾

Eyes and Face 眼睛和脸: chemical safety goggles and face shield 护目镜
和脸罩

Hands and Skin 手和皮肤: rubber gloves 橡胶手套

Clothing : protective clothing 耐酸防护服

Section 9 Physical and Chemical Properties 物理和化学特性

Appearance 外观: 浅蓝色液体

Odour 气味: 淡醋酸味

PH: 2.7±0.3

Section 10: Stability and Reactivity 稳定性和反应活性

Chemical Stability 化学稳定性: 弱的反应能力

Incompatible Materials 不相容物质: alkalis and oxidizers 碱性和氧化物

Section 11 Toxicological Information 毒性资料

NDA 无毒

Section 12 Disposal Consideration 废弃处理

Dispose of material in approved sites 中和后过滤排放, 过滤物交当地合法
批准单位。

Section 13 生态资料

生态毒性: 无

生物降解性: 无

非生物降解性: 无

其它有害作用: 无

Section 14 法规信息

通用法规:

劳工安全卫生规则

特定化学物预防标准

Section 15 运送资料

国内运输规定: 依道路交通安全规则第84 条

Section 16 其他资料

制表单位: 深圳市东方星化工科技有限公司

制表地址: 东莞市虎门镇大宁村大板地工业区

制表部门: 品质部

制表日期: 2017 年 1 月

CHUNG YU INDUSTRY CORPORATION

Material Safety Data Sheet

Section 1 : Chemical Product and Company Identification

| | |
|---|---|
| Product name | Thermal curable two-component marking ink |
| Other means of identification | ZSR-150 ZM-400WF |
| Recommended use of the chemical and restrictions on use | Use in PCB fabrication. |
| Manufacturer/Supplier identification | CHUNG YU INDUSTRY COPORATION |
| Manufacturer/Supplier address | 618 Yen-Ping Rd., sec. 3, Ping-Jeng, Tao-Yuan, Taiwan |
| Emergency telephone No. | (886-3)4641205 |
| FAX No. | (886-3)4644839 |

Section 2 : Hazards Identification Information

| | |
|---------------------------------------|--|
| Hazard classifications of the product | Inflammable liquids(II),Carcinogens, (II), Inhalation of hazardous substances (I) |
| Label elements |  Hazard symbols: Fire Caution catchwords: Danger Hazard messages: Inflammable liquids and vapor Harmful to swallow Skin irritation Eye irritation |
| Other hazards | — |

Section 3 : Composition, Information on Ingredients

Mixture :

| Chemical name | Concentration(% of contents) | CAS. NO. |
|------------------|------------------------------|------------|
| Epoxy resin | 50 | 25085-99-8 |
| Barium sulfate | 15 | 7727-43-7 |
| Titanium dioxide | 30 | 13463-67-7 |
| Naphtha | 5 | 8030-30-6 |

Section 4 : First-aid Measures

| | |
|---|--|
| The first-aid measures for different exposure routes: | |
| Eyes contact | Immediately flush eyes with plenty of water for at least 15 minutes, occasionally lifting the upper and lower eyelids. |
| Skin contact | Flush skin with plenty of soap and water for at least 15 minutes while removing contaminated clothing and shoes. |
| Swallow | Do not induce vomiting. If conscious and alert, rinse mouth and drink 2-4 cupfuls of milk or water. |
| Inhalation | Remove from exposure to fresh air immediately. |
| The most important symptoms and hazardous effects | Headache, nausea |
| Notes to Physicians | Please provide the MSDS for physicians. |

Section 5 : Fire-fighting Measures

| | |
|-----------------------------------|--|
| Suitable fire extinguishing media | Chemical dry powders, chemical foam, carbon dioxide |
| General information | As in any fire, wear a self-contained breathing apparatus in pressure-demand, MSHA/NIOSH (approved or equivalent), and full protective gear. During a fire, irritating and highly toxic gases may be generated by thermal decomposition or combustion. |
| Specific fire-fighting methods | It's not suitable to use water extinguish. |

Section 6 : Accidental Release Measures

| | |
|---------------------------------------|--|
| Person-related precautionary measures | Do not inhale vapors / aerosols. Ensure supply of fresh air in enclosed rooms. |
| Environmental-protection measures | Do not allow to enter sewerage system. |
| Procedures for cleaning / absorption | Take up with liquid-absorbent material. Forward for disposal. Clean up affected area |

Section 7 : Safe Handling and Storage Measures

| | |
|----------|--|
| Handling | Wash thoroughly after handling. Remove contaminated clothing and wash before reuse. Avoid contact with eyes, skin, and clothing. Avoid ingestion and inhalation. |
| Storage | Store in a cool(15~25°C), dry place. Keep container closed when not in use. |

Section 8 : Exposure Controls Measures

| | | | | | |
|----------------------|--|---|------------------------------------|---------------------------|------------------------------|
| Engineering controls | Use adequate general or local exhaust ventilation to keep airborne concentrations below the permissible exposure limits. Use process enclosure, local exhaust ventilation, or other engineering controls to control airborne levels. | | | | |
| Control parameters | Term | 8 hours time weighted average exposure limits TWA | Short-term exposure limits STEL | Maximum limits CEILING | Biological standards BEIs |
| | Solvent | 100ppm | 125ppm | — | — |
| | Personal protective equipment | <p>Eye protection: Wear safety glasses and chemical goggles if splashing is possible.</p> <p>Skin protection: Wear appropriate protective gloves and clothing to prevent skin exposure.</p> <p>Clothing: Wear appropriate protective clothing to minimize contact with skin.</p> <p>Respirators: Wear a NIOSH/MSHA or European Standard EN 149 approved full-facepiece airline respirator in the positive pressure mode with emergency escape provisions.</p> | | | |

Section 9 : Physical and Chemical Properties

| | |
|--|-------------------------------------|
| Physical state : paste | Color : white |
| Odor threshold : — | Odor : slightly pungent |
| pH value : — | Melting point : — |
| Decomposition temperature : — | Boiling point : 110-190°C (solvent) |
| Flammability(solid, gas) : — | Flash point : 38-43°C (solvent) |
| Autoignition temperature : — | Test methods : — |
| Vapor pressure : <5 mmHg @ 25°C (solvent) | Explosion limits : — |
| Specific gravity/Density : 1.45~1.55 g/cm ³ (water=1) | Solubility in water : insoluble |

Section 10 : Stability and Reactivity

| | |
|--|---|
| Chemical stability | Stable under normal temperatures and pressures. |
| Conditions to avoid | Fire. |
| Incompatibilities with other materials | Strong oxidants. |
| Hazardous decomposition products | Irritating and toxic fumes and gases. |
| Hazardous polymerization | Has not been reported. |

Section 11 : Toxicological Information

| | |
|--|--|
| Information on the likely routes of exposure | Skins, swallow, inhale, eyes |
| Symptoms | Nausea, vertigo, irritation |
| Acute toxicity | Skins: Slight irritation Swallow: Nausea, vomit, and the other symptoms same as inhale Inhale: Cause the respiratory tract irritation, nausea, vomit, headache Eyes: The vapor cause eyes irritation LD50(solvent): >5000mg/kg (mouse, swallow) LC50: — |
| Further information | Further hazardous properties cannot be excluded. The product should be handled with the usual when dealing with chemicals |

Section 12 : Ecological Information

| | |
|-----------------------|---|
| Ecotoxic effect | Quantitative data on the ecologic effect of this product are not available. |
| Further ecologic data | No ecological problems are to be expected when the product is handled and due care and attention. |

Section 13 - Disposal Considerations

Dispose of in a manner consistent with federal, state, and local regulations.

Section 14 - Transport Information

1. United Nation number (UN No.): 1866
2. UN proper shipping name: —
3. Transport hazard classes: 3
4. Packing group: —
5. Marine pollutant (Yes/No): No
6. Specific transport measures and precautionary conditions: —

Section 15 - Regulatory Information

1. European / International Regulations : European labeling in accordance with EC Directives.
2. Other using condition should follow local regulations.

Section 16 - Additional Information

| | | | |
|-------------------------------------|--|---------------------|--|
| Organization that prepared the MSDS | Name: R&D | TEL: (886-3)4641205 | |
| | Address: 618 Yen-Ping Rd., sec. 3, Ping-Jeng, Tao-Yuan, Taiwan | | |
| Person who prepared the MSDS | Job: manager | Name: Wan-Hua Lee | |
| Date the MSDS was prepared | 2018/12/20 | | |

The information above is believed to be accurate and represents the best information currently available to us. However, we make no warranty of merchantability or any other warranty, express or implied, with respect to such information, and we assume no liability resulting from its use. Users should make their own investigations to determine the suitability of the information for their particular purposes. In no way shall the company be liable for any claims, losses, or damages of any third party or for lost profits or any special, indirect, incidental, consequential or exemplary damages, howsoever arising, even if the company has been advised of the possibility of such damages.



Material Safety Data Sheet

Copyright, 2003, 3M Company. All rights reserved. Copying and/or downloading of this information for the purpose of properly utilizing 3M products is allowed provided that: (1) the information is copied in full with no changes unless prior written agreement is obtained from 3M, and (2) neither the copy nor the original is resold or otherwise distributed with the intention of earning a profit thereon.

This material safety data sheet (MSDS) is provided as a courtesy in response to a customer request. This product is not regulated under, and a MSDS is not required for this product by the OSHA Hazard Communication Standard (29 CFR 1910.1200) because, when used as recommended or under ordinary conditions, it should not present a health and safety hazard. However, use or processing of the product not in accordance with the product's recommendations or not under ordinary conditions may affect the performance of the product and may present potential health and safety hazards.

SECTION 1: PRODUCT AND COMPANY IDENTIFICATION

PRODUCT NAME: 3M(TM) Laminating Adhesives 9471LE, 9472LE, 9671LE, 9672LE, 9653LE, 9453LE
MANUFACTURER: 3M
DIVISION: Industrial Adhesives and Tapes
ADDRESS: 3M Center
St. Paul, MN 55144-1000

EMERGENCY PHONE: 1-800-364-3577 or (651) 737-6501 (24 hours)

Issue Date: 06/20/2003
Supersedes Date: 05/22/2001

Document Group: 08-9111-9

Product Use:

Specific Use: Laminating Adhesive

SECTION 2: INGREDIENTS

| <u>Ingredient</u> | <u>C.A.S. No.</u> | <u>% by Wt</u> |
|----------------------------|-------------------|----------------|
| TACKIFIED ACRYLATE POLYMER | None | 100 |

SECTION 3: HAZARDS IDENTIFICATION

3.1 EMERGENCY OVERVIEW

Specific Physical Form: Roll of Tape

Odor, Color, Grade: Tan, Acrylate odor when unrolled.

General Physical Form: Solid

Immediate health, physical, and environmental hazards: This product, when used under reasonable conditions and in accordance with the 3M directions for use, should not present a health hazard. However, use or processing of the product in a manner not in accordance with the product's directions for use may affect the performance of the product and may present potential health and safety hazards.

3.2 POTENTIAL HEALTH EFFECTS

Eye Contact:

No health effects are expected.

Skin Contact:

No health effects are expected.

Inhalation:

No health effects are expected. This product may have a characteristic odor; however, no adverse health effects are anticipated.

Ingestion:

No health effects are expected.

SECTION 4: FIRST AID MEASURES

4.1 FIRST AID PROCEDURES

The following first aid recommendations are based on an assumption that appropriate personal and industrial hygiene practices are followed.

Eye Contact: No need for first aid is anticipated.

Skin Contact: No need for first aid is anticipated.

Inhalation: No need for first aid is anticipated.

If Swallowed: No need for first aid is anticipated.

SECTION 5: FIRE FIGHTING MEASURES

5.1 FLAMMABLE PROPERTIES

| | |
|--------------------------|--------------------------|
| Autoignition temperature | <i>No Data Available</i> |
| Flash Point | <i>Not Applicable</i> |
| Flammable Limits - LEL | <i>Not Applicable</i> |
| Flammable Limits - UEL | <i>Not Applicable</i> |

5.2 EXTINGUISHING MEDIA

Use fire extinguishers with class B extinguishing agents (e.g., dry chemical, carbon dioxide).

5.3 PROTECTION OF FIRE FIGHTERS

Special Fire Fighting Procedures: Wear full protective clothing, including helmet, self-contained, positive pressure or pressure demand breathing apparatus, bunker coat and pants, bands around arms, waist and legs, face mask, and protective covering for exposed areas of the head.

Unusual Fire and Explosion Hazards: No unusual fire or explosion hazards are anticipated.

Note: See STABILITY AND REACTIVITY (SECTION 10) for hazardous combustion and thermal decomposition information.

SECTION 6: ACCIDENTAL RELEASE MEASURES

Accidental Release Measures: Not applicable.

SECTION 7: HANDLING AND STORAGE

7.1 HANDLING

Avoid prolonged or repeated skin contact. This product is considered to be an article which does not release or otherwise result in exposure to a hazardous chemical under normal use conditions.

7.2 STORAGE

Not applicable.

SECTION 8: EXPOSURE CONTROLS/PERSONAL PROTECTION

8.1 ENGINEERING CONTROLS

Not applicable.

8.2 PERSONAL PROTECTIVE EQUIPMENT (PPE)

8.2.1 Eye/Face Protection

Avoid eye contact.

8.2.2 Skin Protection

Avoid prolonged or repeated skin contact. Gloves not normally required.

8.2.3 Respiratory Protection

Under normal use conditions, airborne exposures are not expected to be significant enough to require respiratory protection.

8.2.4 Prevention of Swallowing

Not applicable.

8.3 EXPOSURE GUIDELINES

None Established

SECTION 9: PHYSICAL AND CHEMICAL PROPERTIES

Specific Physical Form:

Roll of Tape

Odor, Color, Grade:

Tan, Acrylate odor when unrolled.

General Physical Form:

Solid

Autoignition temperature

No Data Available

Flash Point

Not Applicable

Flammable Limits - LEL

Not Applicable

Flammable Limits - UEL

Not Applicable

Boiling point

Not Applicable

| | |
|--------------------------------|---------------------------------------|
| Vapor Density | Not Applicable |
| Vapor Pressure | Not Applicable |
| Specific Gravity | Approximately 1.01 [Ref Std: WATER=1] |
| pH | Not Applicable |
| Melting point | No Data Available |
| Solubility in Water | Nil |
| Evaporation rate | Not Applicable |
| Volatile Organic Compounds | No Data Available |
| Percent volatile | No Data Available |
| VOC Less H2O & Exempt Solvents | No Data Available |
| Viscosity | Not Applicable |

SECTION 10: STABILITY AND REACTIVITY

Stability: Stable.

Materials and Conditions to Avoid: None known

Hazardous Polymerization: Hazardous polymerization will not occur.

Hazardous Decomposition or By-Products

| <u>Substance</u> | <u>Condition</u> |
|------------------|-------------------|
| Hydrocarbons | During Combustion |
| Carbon monoxide | During Combustion |
| Carbon dioxide | During Combustion |

Hazardous Decomposition: Under recommended usage conditions, hazardous decomposition products are not expected. Hazardous decomposition products may occur as a result of oxidation, heating, or reaction with another material.

SECTION 11: TOXICOLOGICAL INFORMATION

Please contact the address listed on the first page of the MSDS for Toxicological Information on this material and/or its components.

SECTION 12: ECOLOGICAL INFORMATION

ECOTOXICOLOGICAL INFORMATION

Not applicable.

CHEMICAL FATE INFORMATION

Not applicable.

SECTION 13: DISPOSAL CONSIDERATIONS

Waste Disposal Method: Dispose of waste product in a sanitary landfill. As a disposal alternative, incinerate in an industrial or

commercial facility.

Since regulations vary, consult applicable regulations or authorities before disposal.

SECTION 14: TRANSPORT INFORMATION

Please contact the emergency numbers listed on the first page of the MSDS for Transportation Information for this material.

SECTION 15: REGULATORY INFORMATION

US FEDERAL REGULATIONS

Contact 3M for more information.

311/312 Hazard Categories:

Fire Hazard - No Pressure Hazard - No Reactivity Hazard - No Immediate Hazard - No Delayed Hazard - No

STATE REGULATIONS

Contact 3M for more information.

CHEMICAL INVENTORIES

This product is an article as defined by TSCA regulations, and is exempt from TSCA Inventory listing requirements.

Contact 3M for more information.

INTERNATIONAL REGULATIONS

Contact 3M for more information.

This MSDS has been prepared to meet the U.S. OSHA Hazard Communication Standard, 29 CFR 1910.1200.

SECTION 16: OTHER INFORMATION

NFPA Hazard Classification

Health: 0 Flammability: 1 Reactivity: 0 Special Hazards: None

National Fire Protection Association (NFPA) hazard ratings are designed for use by emergency response personnel to address the hazards that are presented by short-term, acute exposure to a material under conditions of fire, spill, or similar emergencies. Hazard ratings are primarily based on the inherent physical and toxic properties of the material but also include the toxic properties of combustion or decomposition products that are known to be generated in significant quantities.

Reason for Reissue: The MSDS has been revised because 3M has adopted the 16-section ANSI/ISO format. The potential hazards of the product have not changed. We encourage you to reread the MSDS and review the information.

DISCLAIMER: The information in this Material Safety Data Sheet (MSDS) is believed to be correct as of the date issued. 3M MAKES NO WARRANTIES, EXPRESSED OR IMPLIED, INCLUDING, BUT NOT LIMITED TO, ANY IMPLIED WARRANTY OF MERCHANTABILITY OR FITNESS FOR A PARTICULAR PURPOSE OR COURSE OF PERFORMANCE OR USAGE OF TRADE. User is responsible for determining whether the 3M product is fit for a particular purpose and suitable for user's method of use or application. Given the variety of factors that can affect the use and application of a 3M product, some of which are uniquely within the user's knowledge and control, it is essential that the user evaluate the 3M product to determine whether it is fit for a particular purpose and suitable for user's method of use or application.

3M provides information in electronic form as a service to its customers. Due to the remote possibility that electronic transfer may have resulted in errors, omissions or alterations in this information, 3M makes no representations as to its completeness or accuracy. In addition, information obtained from a database may not be as current as the information in the MSDS available directly from 3M.

3M MSDSs are available at www.3M.com

江阴凯博通信科技有限公司
JIANGYIN KAIBO COMMUNICATION TECHNOLOGY CO., LTD.
Material Safety Data Sheet (物质安全资料表)

一、 物品与厂商资料

物品名称：同轴高频线

物品编号：RF081 系列

制造商或供货商名称、地址：江阴市凯博通信科技有限公司/江苏省江阴市澄江镇梅园大街 391 号

紧急联络电话/传真电话：0510-86070001/86070020

二、 成分辨识资料

纯物质：

中英文名称：聚全氟乙丙烯 FLUORINATED PROPYLENE ETHYLENE/镀锡线 TINNED COPPER/镀银铜线

Cu-silver plated 同义名称：FEP/TX/SC

有害物质成分(成分百分比)：无

危害物质：

| 危害物质 | 浓度或浓度范围 (单位: ppm) | |
|------------|-------------------|-----------------|
| 铅及其化合物 Pb | ≤90 | |
| 镉及其化合物 Cd | ≤75 | |
| 汞及其化合物 Hg | ≤1000 | |
| 六价铬及化合物 | ≤1000 | |
| 卤素 | 氯 Cl ≤900 | 氯 Cl+溴 Br ≤1500 |
| | 溴 Br ≤900 | |
| SVHC15 种物质 | 禁止使用 | |

三、 危害辨识数据

| | |
|---------------------------------|---|
| 最 重 要 危 害 效 应 | 健康危害效应：在 260℃ 以上，可能会有吸入分解气体的危险。一定要安装排气装置。 |
| | 环境影响：要按废弃物处理及清扫法律法规处理，绝对不可燃烧。 |
| | 物理性及化学性危害：物理化学性能及其稳定，不易降解，不得擅自填埋。 |
| | 特殊危害： 无 |
| 主要症状： 对人的神经系统产生损害 | |
| 物品危害分类： 大气和水源 | |

四、 急救措施

| |
|----------------|
| 不同暴露途径之急救方法： |
| · 吸入：到空气流通处换气。 |
| · 皮肤接触：无 |
| · 眼睛接触：无 |
| · 食入：不消化，排出。 |
| 最重要症状及危害效应：无 |

对急救人员之防护：对流换气

对医师之提示：吸氧

五、灭火措施

适用灭火剂：通用

灭火时可能遭遇之特殊危害：避免分解气体吸入

特殊灭火程序：无

消防人员之特殊防护设备：防毒面罩

六、泄漏处理方法

个人应注意事项：粉状树脂

环境注意事项：不可填埋

清理方法：要按废弃物处理及清扫法律法规处理, 绝对不可燃烧.

七、安全处置与储存方法

处置：避免与高温和火源接触.

储存：通风干燥处.

八、暴露预防措施

工程控制：无

控制参数：

· 八小时日时量平均容许浓度/短时间时量平均容许浓度/最高容许浓度：

· 生物指标：

个人防护设备：

· 呼吸防护：安装排气装置

· 手部防护：无

· 眼睛防护：无

· 皮肤及身体防护：无

卫生措施：应将衣服上附着的灰尘抖落, 手脸洗净, 不要让其附着于香烟上.

九、物理及化学性质

| | |
|------------|-----------|
| 物质状态：固体 | 形状：透明颗粒 |
| 颜色：透明 | 气味：无 |
| pH 值：7 | 沸点/沸点范围：/ |
| 分解温度：360°C | 闪火点：/ |
| 自燃温度：/ | 爆炸界限：/ |
| 蒸气压：/ | 蒸气密度：/ |
| 密度：2.2 | 溶解度：/ |

十、安定性及反应性

安定性：很稳定

特殊状况下可能之危害反应：高温或燃烧分解气体对人体神经系统的损害.

应避免之状况：绝对不可燃烧.

应避免之物质：金属钠及其强酸的混合物 .

危害分解物： 气体及粉尘.

十一、毒性资料

急毒性： /

局部效应： /

致敏感性： /

慢毒性或长期毒性： /

特殊效应： /

十二、生态资料

可能之环境影响/环境流布： 不降解, 禁填埋

十三、废弃处置方法

废弃处置方法： 按废弃物处理及清扫法律法规要求送专业资质处理公司处置.

十四、运送资料

国际运送规定： /

联合国编号： /

国内运送规定： 无

特殊运送方法及注意事项： 无

十五、法规资料

适用法规： 遵循欧盟 REACH 法规相关要求。

十六、其它数据

| | |
|-------|--|
| 参考文献 | 杜邦产品说明/SONY 限用物资标准 |
| 制窗体位 | 名称： 江阴凯博通信科技有限公司 |
| | 地址/电话： 江阴市澄江街道梅园大街 391 号/0510-86070017 |
| 制 表 人 | 姓名(签章)： 庄科洁 |
| 制表日期 | 2012/11/12 |

MATERIAL SAFETY DATA SHEET (MSDS)

Issued: Dec 20, 2007

Revised: Dec 20, 2007

File No. 2302

1. CHEMICAL PRODUCT & COMPANY IDENTIFICATION

CHEMICAL PRODUCT NAME : DURANEX XFR4840
NAME OF COMPANY : WinTech Polymer Ltd.
SECTION IN CHARGE : Quality Assurance Dept.
ADDRESS : 2-18-1 Konan, Minato-ku, Tokyo,108-8280 Japan
TELEPHONE NUMBER : 03-6711-8605
FACSIMILE NUMBER : 03-6711-8616

2. COMPOSITION/INFORMATION ON INGREDIENTS

SUBSTANCE/PREPARATION : Preparation
RATION

COMMON CHEMICAL NAME : Polybutyleneterephthalate

SYNONYMS : Polybutyleneterephthalate(PBT)

INGREDIENTS AND COMPOSITION : PBT \geq 80%, Phosphorus Flame retardant and others \leq 20%

CHEMICAL FORMULA : $\{ \text{C}_{10}\text{H}_{16}\text{O}_2 \}_n$

SERIAL No IN OFFICIAL GAZETTE : 7-1039 (base resin)
(Law Concerning Examination and Regulation of Manufacture, etc., of Chemical Substances)

CAS No : 2 4 9 6 8 - 1 2 - 5 (base resin)

3. HAZARDS IDENTIFICATION

PHYSICAL AND CHEMICAL HAZARDS : Not applicable

HUMAN HEALTH EFFECTS : Not applicable

ENVIRONMENTAL EFFECTS : Not applicable

PHYSICAL AND CHEMICAL HAZARDS : It is inflammable substance and combustible if an igniting source is existent. Neither dangerous reaction, fire nor explosion can be caused under normal conditions.

THE CLASSIFICATION : Not applicable

4. FIRST-AID MEASURES

INGESTION : Help to vomit as much as possible. If sick feeling continues, and ask a physician for advice.

INHALATION : When a gas generated from the molten polymer, especially fume generated during combustion or heat, has been inhaled, remove fresh air without delay and wait until the victim is recovered. If sick feeling continues, ask a physician for advice.

SKIN CONTACT : Cool the contacted skin with clean water without delay, if a contact with the polymer in a molten form. Do not force to remove the solid resin on the skin. If any burns are observed on the skin, ask a physician for advice.

EYE CONTACT : Cool and rinse the eye with clean water for at least 15 minutes when the eyes had contact with molten polymer. In case of wearing contact lenses,remove the lenses as soon as possible,and ask a physician for advice. When the eye had contact with the polymer in an ordinary solid form,rinse the eye with clean water without delay. If the discomfort persists,ask a physician for advice.

5. FIRE-FIGHTING MEASURES

EXTINGUISHING MEDIA : Water,form fire-extinguishing agent,powder fire-extinguishing agent,and carbon dioxide gas.

SPECIFIC METHODS : Extinguish the fire with water. A method of extinguishing an ordinary fire may be applied. Do not apply water directly to processing machines.

SPECIFIC HAZARDS : Incomplete combustion leads to generation of toxic gases such as carbon monoxide or tetrahydrofuran,in addition to carbonic acid gas and water.

SPECIAL EQUIPMENT FOR THE PROTECTION OF FIREFIGHTERS : In case the fire gained force,use a gas mask or other protective equipment.

6. ACCIDENTAL LEAKAGE MEASURES

PERSONAL PRECAUTIONS : When pellets were spilled on the road or floor,wipe them off with a besom or cleaner not to cause slipping.

ENVIRONMENTAL PRECAUTION : Handle the spillage in accordance with provisions given in the "Resin pellet spillage preventive manual",in order to prevent intakes by marine animals and birds.

7. HANDLING AND STORAGE

HANDLING : This resin in a pellet form will neither ignite nor explode at room temperatures.

HANDLING 2 : For molding work,effective means for local exhaust are required to discharge gases generated by melt processing.

HANDLING 3 : Avoid inhaling of gases generated in moulding work. Do not directly touch resin of high temperature.

HANDLING 4 : Avoid retaining hot resin in the processing machines for many hours.

HANDLING 5 : This pellets spilled on the floor are likely to cause slipping. Remove such spillage at any times.

STORAGE : Keep the substance away from any fire or heat sources for the sake of safe storage.

RECOMMENDED PACKAGING MATERIALS : No information.

8. EXPOSURE CONTROL / PERSONAL PROTECTION

CONTROL CONCENTRATION : None at present

PERMISSIBLE CONCENTRATION : OSHA PEL/1985
Max. permissible concentration of inactive powder 15mg/m³
- ditto - (Aspiration) 5 mg/m³
ACGIH TLV/1992 1993
Exposure limit of the powder TWA 10 mg/m³

ENGINEERING MEASURE : When handling dust: Use totally enclosed containers resisting dust explosion.
When heat melted in molding: Effective local ventilation must be provided.

| | | |
|-------------------------------|---|---|
| PERSONAL PROTECTIVE EQUIPMENT | : | |
| RESPIRATORY PROTECTION | : | Wear a dust-proof mask. |
| EYE PROTECTION | : | Wear protective glasses or goggles. |
| HAND PROTECTION | : | Wear heat-resisting gloves against burns, when handling molten polymer. |
| SKIN & BODY PROTECTION | : | Wear long sleeve clothes against burns, when handling molten polymer. |

9. PHYSICAL AND CHEMICAL PROPERTIES

| | | |
|-----------------------|---|---|
| APPEARANCE etc. | : | Pellet |
| BOILING POINT | : | Not applicable |
| VAPOUR PRESSURE | : | Not applicable |
| VOLATILITY | : | Not applicable |
| SUBLIMATION | : | None |
| MELTING POINT | : | 228°C |
| DENSITY | : | 1.32g/cm ³ |
| SOLUBILITY | : | Insoluble in water |
| FLASH POINT | : | 300°C or higher |
| IGNITION POINT | : | 300°C or higher |
| EXPLOSION PROPERTY | : | Not applicable |
| INFLAMMABILITY | : | None |
| REACTIVITY WITH WATER | : | None |
| OXIDIZABILITY | : | None |
| SELF-REACTIVITY | : | None |
| DUST EXPLOSIVENESS | : | Upper explosion limit : Not applicable. Lower explosion limit : 35g/m ³ |

10. STABILITY AND REACTIVITY

| | | |
|--------------------------|---|--|
| STABILITY AND REACTIVITY | : | Stable for normal storage or handling. |
|--------------------------|---|--|

11. TOXICOLOGICAL INFORMATION

| | | |
|---------------------------------|---|--|
| SKIN CORROSIVE PROPERTIES | : | No finding. |
| SENSITIZING & IRRITANT EFFECTS | : | Gas generated in drying or melting is irritating eyes and skins. |
| ACUTE TOXICITY (INCLUDING LD50) | : | No finding. |
| SUBACUTE TOXICITY | : | No finding. |
| CHRONIC TOXICITY | : | No finding. |

CARCINOGENECITY : No finding.

MUTAGENECITY(Mi : No finding.
cro
organisms,chromoso
mal aberration)

REPRODUCTIVE : No finding.
TOXICITY

TERATOGENICITY : No finding.

OTHERS(Including : No finding in this report means that there will be no hazard in
generation of general,but no proving data available at the time of reporting.
hazardous gases by
reaction with
water,for ezample)

OTHER CAUTIONS : With regard to dust,the maximum permissible concentration and limits
are fixed by OSHA and ACGIH.

12. ECOLOGICAL INFORMATION

BIODEGRADABILITY : No finding.

BIOACCUMULATION : No finding.

FISH TOXICITY : No finding.

13. DISPOSAL CONSIDERATION

WASTE FROM : This is designated as waste plastics among industrial wastes by the
RESIDUES Wastes Disposal Law. Disposal waste pellets through licensed wastes
handlers or local autonomous bodies if they are handling wastes
disposal.

WASTE FROM : When disposed by incineration,use the well controlled incinerators in
RESIDUES 2 accordance with the Wastes Disposal Law,Air Pollution Control Law and
Water Pollution Prevention Law.

14. TRANSPORT CONSIDERATION

UN : Not applicable
CLASSIFICATION
NUMBER

OTHER CAUSIONS : Handle with care so as not to give damages to containers or not to be
subjected to wetting.

OTHER CAUSIONS : Secure the containers firmly so as not to cause collapsing.
2

15. REGULATORY INFORMATION

WASTE DISPOSAL : Waste plastics among industrial wastes.
LAW

16. OTHER INFORMATION

HANDLING OF THE : This MSDS is the English version translated from the Japanese MSDS
DETAILS GIVEN which is prepared for domestic use.
ABOVE Details given above are based on references, information and data
available at this moment, but no warranty can be made on exactness of
these details. They are also prepared on the assumption that the
product will be handled in a normal way. For special handling, adequate
safety and environmental measures should be taken in respect to its
applications. Our products are not specifically intended for implants for
medical and dental applications, and therefore they are not
recommended for such applications.
"No finding" in this report means that there will be no hazard in general,
but no proving data is available at the time of reporting.

MATERIAL SAFETY DATA SHEET

MSDS FILE No. (KURAMI WORKS) : 05-1225

(based on Form OSHA-174)

IDENTITY (AS Used on Label and List)

Product Class : Phosphor Bronze Strip
 Trade Name : JIS H3130 C5210R (Equivalent to ASTM B103 C52100)
 CAS No. : Copper: 7440-50-8, Tin: 7440-31-5, Phosphor: 7723-14-0
 Chemical Composition

| | Content(wt-%) | CAS No. |
|-------------|---------------|-----------|
| Tin(Sn) | 7.0~9.0 | 7440-31-5 |
| Phosphor(P) | 0.03~0.35 | 7723-14-0 |
| Copper(Cu) | Balance | 7440-50-8 |
| Sn+P+Cu | 99.7 \leq | - |

Section I

| | |
|---|---|
| Manufacturer's Name NIKKO METAL MANUFACTURING CO., LTD. KURAMI WORKS | Date Prepared May 24th, 2005 |
| Address 3 Kurami Samukawa-cho Kouza-gun Kanagawa prefecture 253-0101 JAPAN | Signature of Person in Charge <i>Chihiro Izumi</i> IZUMI, Chihiro Senior Technical Supervisor, Quality Assurance |
| Telephone Number for Information (Quality Assurance) +81-467-75-7285 | Signature of Person Responsible <i>Hiroaki Watanabe</i> |
| Facsimile Number for Information (Quality Assurance) +81-467-74-6971 | WATANABE, Hiroaki Manager, Quality Assurance Section |

Section II Hazardous Ingredients / Identity Information

Hazardous Components (Specific Chemical Identity : Names OSHA PeI ACGIH TLV)

Nothing for ordinary service condition

Section III Physical / Chemical Characteristics

| | | | |
|-------------------------|---------------------------------------|--------------------------------------|--|
| Boiling Point | 2630 °C for Copper 2275 °C for Tin | Specific Gravity (H2O = 1) | 8.80 |
| Vapor Pressure (mmHg) | N/A | Melting Point | 1025 deg. centi. for C5210 Phosphor Bronze |
| Vapor Density (Air = 1) | N/A | Evaporation Rate (Butyl Acetate = 1) | N/A |
| Solubility in Water | N/A | | |
| Appearance and Odor | Brown - Red (solid) : Odor - None | | |

Section IV Fire and Explosion Hazard Data

| | | | | | | | |
|------------------------------------|--|------------------|-----|-----|-----|-----|-----|
| Flash Point (Method Used) | N/A | Flammable Limits | N/A | LEL | N/A | UEL | N/A |
| Extinguishing Media | N/A (stable , nonflammable substance) | | | | | | |
| Special Fire Fighting Procedures | Not specified | | | | | | |
| Unusual Fire and Explosion Hazards | Metal products do not present fire or explosion hazards under normal conditions. | | | | | | |

Section V Reactivity Data

| | | | |
|-----------|----------|---|---------------------|
| Stability | Unstable | | Conditions to Avoid |
| | Stable | X | |

Incompatibility (Materials to Avoid)

Nothing

Hazardous Decomposition or Byproducts

Nothing

| | | | |
|--------------------------|----------------|---|---------------------|
| Hazardous Polymerization | May Occur | | Conditions to Avoid |
| | Will Not Occur | X | |

Section VI Health Hazard Data

| | | | |
|---------------------|--------------|--------|-------------|
| Route(s) of Entry : | Inhalation ? | Skin ? | Ingestion ? |
| | N/A | N/A | N/A |

Health Hazardous (Acute and Chronic)

N/A

| | | | |
|-------------------|-------|-------------------|------------------|
| Carcinogenicity : | NTP ? | IARC Monographs ? | OSHA Regulated ? |
| | N/A | N/A | N/A |

Signs and Symptoms of Exposure

N/A

Medical Conditions

Generally Aggravated by Exposure

N/A

Emergency and First Aid Procedures

N/A

Section VII Precautions for State Handling and Use

Steps to Be Taken in Case Material Is Released or Spilled

N/A

Waste Disposal Method

Collect scrap for remelting.

Precautions to Be Taken in Handling and storing

For Handling

- Put safety gloves on to protect your hands from edges of coils which might cut your hands.
- Wear safety glasses when metal powders or chips are expected to be generated in the work.
- Put safety shoes on when handling heavy coils.

For Storing

- The environment of stocking area should be free from acid, alkali, chloride, sulfide and other corrosive chemicals to prevent from rusting or corrosion.

Other Precautions

No special requirements

Section VIII Control Measures

Respiratory Protection (Specify Type)

Wearing a mask be recommended in the work such as abrasion and buffing which generates metal powders or chips.

| | | |
|-------------|-----------------------|---------|
| Ventilation | Local Exhaust | Special |
| | None | None |
| | Mechanical (General) | Other |
| | None | None |

Protective Gloves

Put safety gloves on to protect your hands from edges of coils which might cut your hands.

Eye Protection

Wear safety glasses when metal powder is expected to be generated in the work.

Other Protective Clothing or Equipment

Put safety shoes on when handling heavy coils.

Work / Hygienic Practices

None

Influence to environments

Fish on toxicity : TLm 48 hr. on CuSO4

Salmogairdeneri : 0.038 ~ 0.8 ppm

Oryzias Latipes : 2.1 ~ 24ppm

Material Safety Data Sheet

1. Manufacturer

- Company HARADA Metal Industry Co., Ltd.
- Address 10-18 Sasamekitamati, Toda, Saitama 335-0033, Japan
TEL 048-422-1588
FAX 048-449-6303
- Counter The domestic business department business primary and second section
TEL 048-441-5115
FAX 048-444-9104
The domestic business department OSAKA service office
TEL 06-531-8094
FAX 06-531-8096
The domestic business department NAGOYA service office
TEL 052-821-9778
FAX 052-822-7500
The overseas business department export section
TEL 048-441-5115
FAX 048-444-9104
- Urgent place to contact
The quality assurance department
TEL 048-422-1588
FAX 048-449-6303

2. Products

- Phosphor bronze plates and strips for springs
- Phosphor bronze plates and strips

3. Specification of the material

- The division of mixture or single product : Single product
- The chemical name : Copper alloy
- Chemical composition and content rate(wt.%)

| Element | Percent | | | | | CAS No. |
|------------|-----------|-----------|-----------|-----------|-----------|-----------|
| | C5210 | C5212 | C5191 | C5102 | C5111 | |
| Copper | rem. | rem. | rem. | rem. | rem. | 7440-50-8 |
| Tin | 7.0~9.0 | 7.0~9.0 | 5.5~7.0 | 4.5~5.5 | 3.5~4.5 | 7440-31-5 |
| Phosphorus | 0.03~0.35 | 0.03~0.35 | 0.03~0.35 | 0.03~0.35 | 0.03~0.35 | 7723-14-0 |
| Lead | 0.05 max | 0.05 max | 0.05 max | 0.05 max | 0.05 max | 7439-92-1 |
| Iron | 0.1 max | 0.1 max | 0.1 max | 0.1 max | 0.1 max | 7439-89-6 |
| Zinc | 0.2 max | 0.2 max | 0.2 max | 0.2 max | 0.2 max | 7440-66-6 |

4. Classification of harmfulness

- The name of classification : Not classified into the dangerous harmfulness material.
- The danger : No knowledge
- The harmfulness : No knowledge
- The effect for the environment : No knowledge

5. First aid

- Eyes : Flush the water. Consult the doctor, when the simulation of the eye continues.
- Skin : Flush the water.
- Inhalation : Consult the doctor, when it was large inhaled.

6. The treatment in the fire

- Nonflammable.

7. Leakage

- Not applied (because of solid)

8. Attention in handling and storage

- Stored at the ordinary—temperature and usual humidity.
- Prohibition of the rapid temperature and humidity change.

9. Treatment on the exposure prevention

- Standard control concentration : Not regulated.
- Allowable temperature : Not regulated.
- Facility countermeasure : The whole ventilation is desirable.
- Protector : For lung ,the wear of protection mask is desirable for the power handling.
For hand ,the wear of protective glove is desirable.
For eyes ,the wear of safety goggles is desirable for the power handling.
For body , the wear of protective clothing is desirable.

10. Physical and chemical characteristic

- Appearance and smell : The solid with the metallic luster. Odoless.
- Boiling point : The indistinctness.
- Solubility : Dissolves in the inorganic acid.

| | C5210 | C5212 | C5191 | C5102 | C5111 |
|------------------|--------|--------|--------|--------|--------|
| Specific gravity | 8.82 | 8.82 | 8.85 | 8.88 | 8.90 |
| Melting point | 1020°C | 1020°C | 1045°C | 1050°C | 1060°C |

11. Information for danger

- Fire point : The indistinctness.
- Stability : Show the stability at room temperature and in the air.
- The situation to be avoided : —

12. Information for harmfulness

- The powder stimulates eyes , skin and bronchi.
- Produce the ulcer and the hepatic disorder rarely.

13. Information for environment

- No knowledge.

14. Attention for scrapping

- Possible to deal with ,as an industrial waste.

15. Attention for transportation

- No damage transportation is desirable.

16. Applying act

- —