



**WINDHORSE**

**Dingo** | **ELECTRIC  
BICYCLE**  
**RIDING GUIDE**

IMPORTANT, RETAIN FOR FUTURE  
REFERENCE: READ CAREFULLY

[www.windhorse.com](http://www.windhorse.com)

# TABLE OF CONTENTS

---

Dingo Specifications	2
Packaging	3
Assembly (Handlebar installation, Fender installation, Front wheel installation, Headlight installation, Install the Basket, Install the pedal)	4
Display Instruction	7
Error Code	9
Charging	10
Charging and Battery Safety Tips	11
Usage of the Dingo	12
Safety Information	13
Care & Maintenance	15

# DINGO SPECIFICATIONS

- Max Supported Weight: 330 lbs
- Min. Supported Weight: 48 lbs
- Max Speed: 20 mph
- Max Range: 60 miles
- Motor Power: 1000W
- Battery Voltage: 48V DC Lithium Battery
- Battery Capacity: 21Ah
- Shifter Throttle: Yes
- Power Requirement: Shenzhen Fuyuanlian Power Co., Ltd.  
FY1695463000 Input: 100–240V/50–60Hz 2.5A  
Output: 42.0–58.8Vdc, 0.001–4.000A, 168.0W Max
- Front Fork: Rigid Steel Fork
- Tire Size: 20” Front & Rear
- Brake Type: Hydraulic Brake
- APP: WINDHORSE App



The following instructions are applicable to the basic user manual. Please pay special attention to Warnings or Notes as published in this manual. For your cycling safety, please read this manual carefully before using your DINGO electric bicycle to make sure you can ride comfortably and correctly.

# PACKAGING

- 01 Bike 
- 02 Fender 
- 03 Pedal 
- 04 Front Wheel 
- 05 Headlight 
- 06 Basket 
- 07 Charger Cable 
- 08 Charger 
- 09 Quick dismantling rod 
- 10 Tools 

# ASSEMBLY

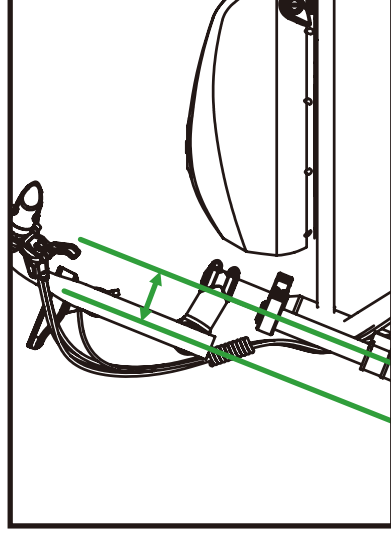
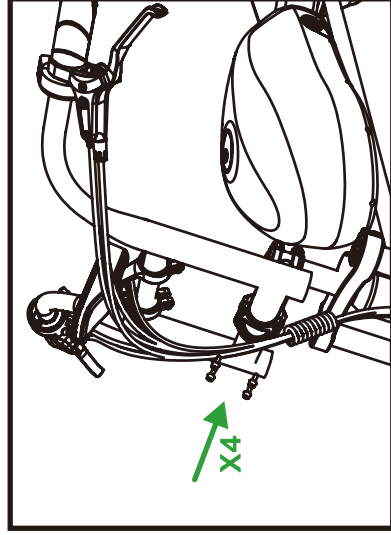

- **Handlebar installation**  
Put the handlebar on the stem  
Move in the right direction  
Screw on and Tighten  
Keep balance with the Front fork

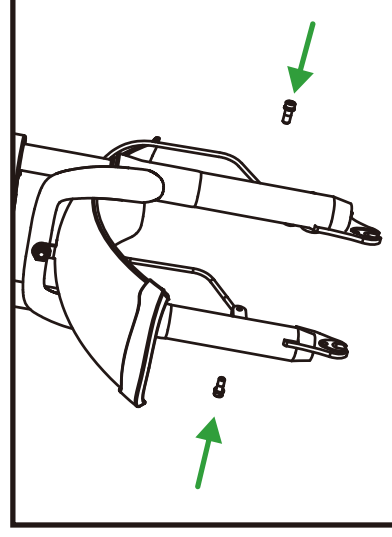
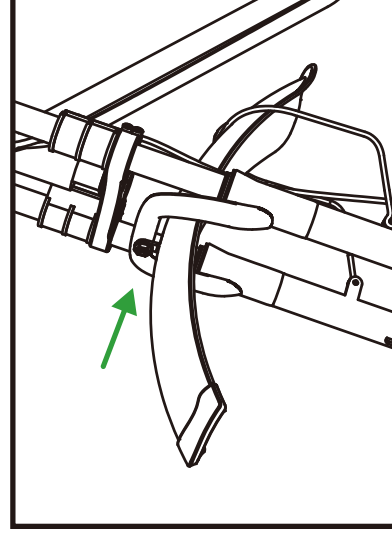

- **Fender installation**  
Put the fender on the front fork  
Screw the middle screw  
Screw on right and left sides

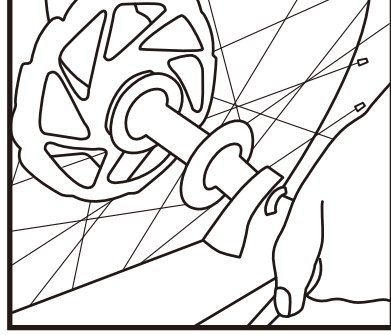
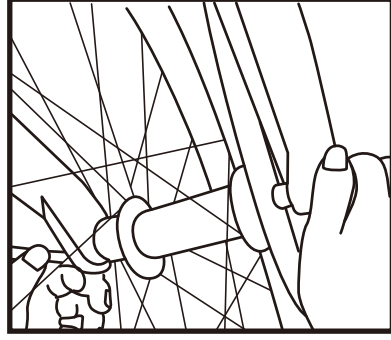

### • Front Wheel Installation

- Put the front wheel on the front fork
- Assembly quick release lever
- Screw on and tightened

### • Headlight Installation

- Stick a EVA
- Choose the right hole
- Screw on and tightened

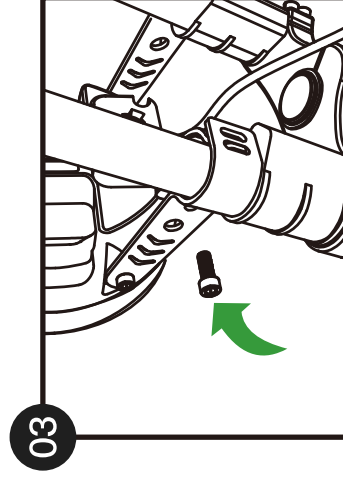
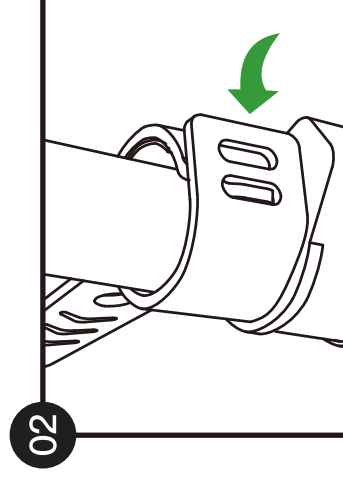
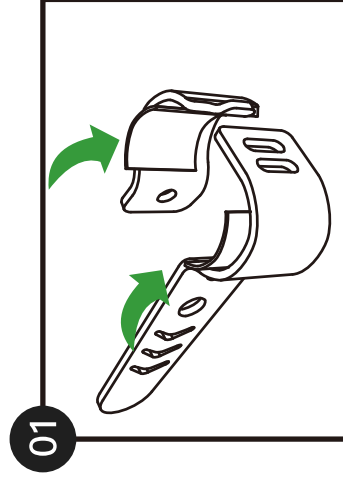

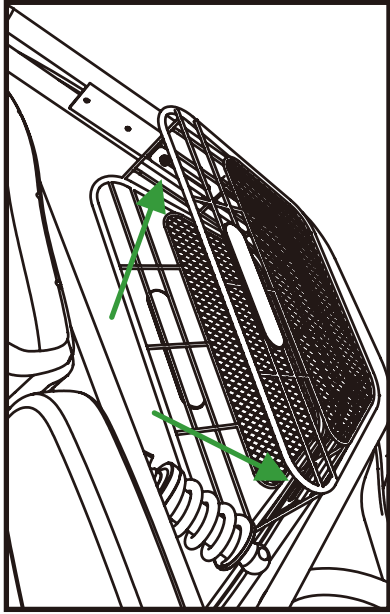

• **Basket Installation**

Put the basket on the middle part  
Screw on and tightened

01

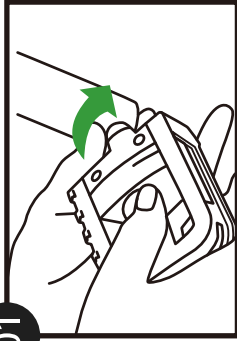

02



03

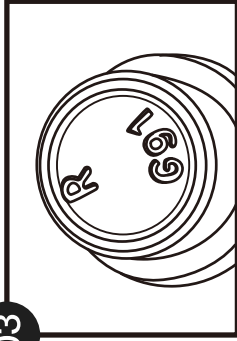

04

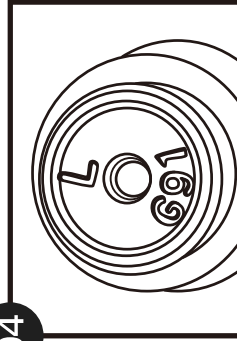

05

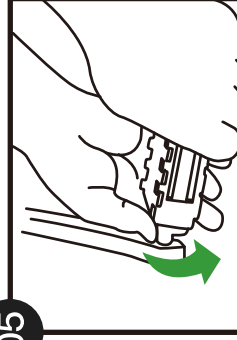



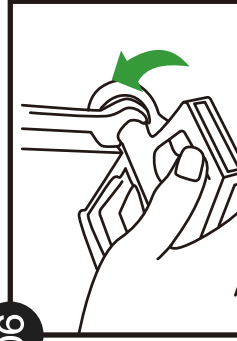









06



• **Install the Pedals**

Rotate clockwise to tighten  
Installed on the chainwheel side crank  
Looking for "R" mark  
Looking for "L" mark  
Rotate counterclockwise  
Tighten

• Display Instruction

	Lock Motor Indicator		Fault Indicator
	Cruise Control		Headlight Indicator
	Walk Mode		BLE Connection Status
	Brake indicator		Throttle
	Error Indicator		Turning State
	Gear		
	Battery Indicator		

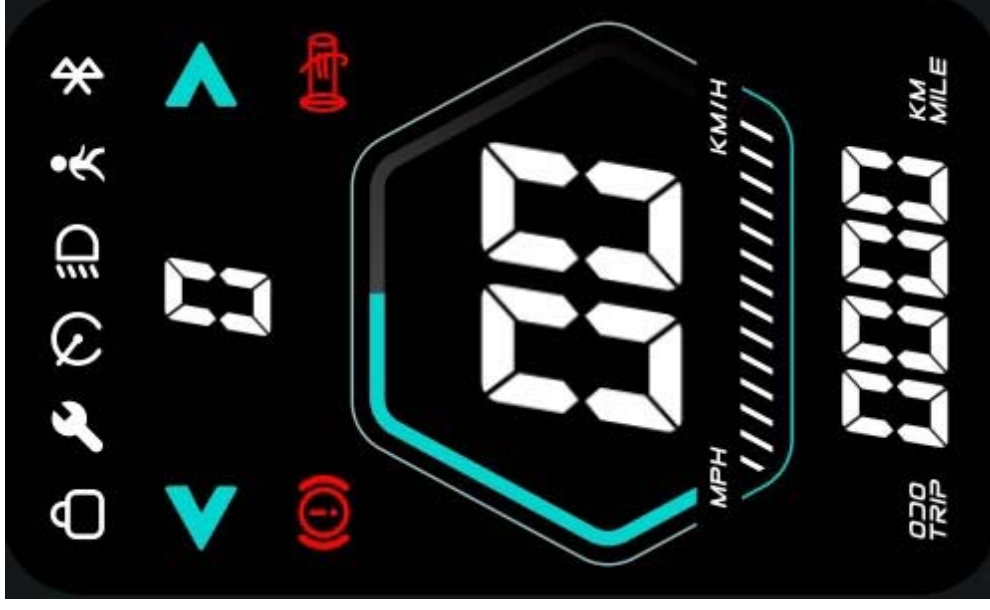



• Key Operation

Function Name	Operation Method
Power on/off	Long press the button for more than 2S
Trip and ODO switching	In the power-on state, press the button once
Turn on/off headlights	In the power-on state, press the button twice quickly
Toggle kilometer units	In the power-on state, press the button thrice quickly
Gyroscope sensor ON/OFF	In the power-on state, press button quartic quickly
Release/Set speed limit (only for final gear)	Hold the brake handle tightly, press and hold the button to turn on the machine, release the brake handle after turning the throttle 5 times, and the speed limit is set/released successfully with a beep
Motor Unlock	Hold the brake handle tightly, press and hold the button to turn on the power, turn the throttle twice and then release the brake handle, the motor will be unlocked with a beep, only for motor was locked
Up shift gear	Press the “▲”key
Down shift gear	Press the “▼”key

# Error Code

No.	Error code	Fault point
E1	Motor hall error	check Motor and motor cable
E2	Controller MOS Over current protection error	check controller
E3	Brake signal error	check brake cabel
E4	Throttle signal error	check throttle cabel
E5	Low voltage protection error	check controller cable if is it short and battery error
E6	Communication failure	check m-bus between the displaier and controller
E7	Overvoltage protection error	check controller and battery
E8	Controller MCU error	check controller
E9	Stall protection error	check Motor and motor cable

# CHARGING

- The charging port is located under the frame
- Plug the charging cable into the charging port.  
(Make sure the connection is dry)
- The indicator LED of the charging adapter turns red when charging and turns green when the battery is full. Please stop charging when it is full to prevent battery life from deteriorating. Please use the batteries, chargers and cables supplied by the original manufacturer to prevent the battery from being overcharged.
- When finished charging, close the charging flap to prevent any damage to the port.

**WARNING: UN-PLUG BEFORE TURNING ON IGNITION.**



**Note:** Please be sure to keep the port covered and free of dirt and water.

# CHARGING & BATTERY SAFETY TIPS

**WARNING:** The DINGO is not waterproof, and therefore should always be kept away from any source of water—NEVER allow the charging block, cables or cable ends to touch water. Do not handle with wet hands as it may cause electric shock. If any failure occurs during charging, unplug immediately. Do not yank or pull on the plug to the DINGO or pull from an electrical socket in an abrasive manner.

- Check battery level before the first use.
- It is recommended that the battery be recharged after each use.
- To maximize the battery life, please charge once per month or after at least 2 days of operation.
- Recharge the battery pack at least once per month as all batteries of every type will slowly discharge energy when left idle for extended periods of time.

Try to keep the battery from being exposed to excessive heat or very hot temperatures.

- Please use the batteries, chargers and cables supplied by the original manufacturer to prevent the battery from being overcharged.
- Do not allow the charger or cable to contact sharp or hot items.
- Perform a visual inspection of the charger and charging cables regularly.
- If the charging cable has obvious damage – do not use the charger to avoid injury or electrical damage.
- Please do not repair the battery, the charger, or the cable independently.
- Please ensure that the charger and charging cables are connected correctly and are free of dust, dirt, and water.
- Prolonged exposure to UV rays, rain and elements may damage the enclosure materials, store indoors when not in use.
- The charging range and use range are 0°–40°C.
- Please do not disassemble parts by yourself.

**Please contact us if you experience any problems or issues.**

# USAGE OF THE 1 SCOOTER

- The DINGO is a one-person mobility product – anyone who is under 12 years old needs to be assisted when riding.
- The DINGO is only for daily recreational use and is not designed for extreme sports.
- Check that the parts of the bicycle are installed correctly and not damaged.
- Check that folding mechanism is locked.
- Check the battery – is the battery charged?
- Check the brakes – do they function for both front and rear wheels?
- Check the tire – make sure there are no punctures or bubbles.
- Ride with caution and always wear a helmet.
- Make sure to follow maintenance protocols. Lack of proper maintenance may void warranty.
- **WARNING – Risk of Fire – No User Serviceable Parts.**
- **AVERTISSEMENT – Risque d’incendie – Aucune des pièces ne peut être réparée par l’utilisateur**



## Handbrakes

Squeeze each brake slowly to avoid stopping abruptly and losing control.

# SAFETY INFORMATION

Your electric bicycle can provide many years of service and fun — if you are safe and responsible when riding.

## **Always Wear a Helmet**

Helmets significantly reduce the number and severity of head injuries. Always wear a helmet that complies with your local and state laws when riding any electric bicycle for that matter. Check with your local police department for requirements in your community. DO NOT wear loose fitting clothing as they can get tangled in the moving parts of the electric bicycle. Wear close-toed shoes. Always wear a helmet and appropriate apparel when riding. If you are unsure, check with your local state laws concerning other protective gear that may be required when riding the electric bicycle.

## **Know Your DINGO ELECTRIC bicycle**

Your new DINGO bicycle incorporates many features and functions that you may not be familiar with. Read this manual thoroughly to understand how its features can enhance your riding experience.

## **Ride Defensively!**

One of the most frequent cycling accidents occurs when the driver of a parked car opens his door into a rider's path. Another common occurrence is when a car or another cyclist moves suddenly into your path. Always be aware of vehicles around you. Do not assume that surrounding drivers or pedestrians see you. Be prepared to take evasive action or stop suddenly.

## **Make Sure You Are Visible to Others!**

Make yourself more visible by wearing bright reflective clothing. Keep your reflectors clean and properly aligned. Use your headlights in reduced lighting conditions. Signal your intentions so that drivers and other cyclists can anticipate your actions. Use your bell when needed to make your presence known.

### **Ride Within Your Limits!**

Take it slow until you are familiar with your local riding conditions. Be especially careful in wet conditions as traction can be greatly reduced and brakes become less effective. Never ride faster than conditions warrant or beyond your riding abilities. Remember that alcohol, drugs, fatigue, and distractions can significantly reduce your ability to make good judgments and ride safely.

**Do not use your mobile phone when riding - this can cause you to be distracted - stay alert!**

### **Make Sure Your bicycle is Well-Maintained**

Follow the inspection and maintenance guidelines. Check critical safety equipment before every ride.

### **Know the Law**

Cyclists are required to follow the rules of the road. Additionally, some communities regulate the use of motorized vehicles with minimum age, requirements and necessary equipment. Check with your local police department for specific details.

### **Off-road Riding**

Off-road riding is not recommended as the bicycle tires are for street-use only. Dust and extreme impacts from off-road riding can cause electrical system problems.

# CARE & MAINTENANCE

## Storage

- Avoid storing the bicycle in direct sunlight. Hot temperatures can cause damage to the battery and function of the bicycle.
- Avoid storing electric bicycle in wet conditions.
- When the bicycle is not being used, the battery can lose power. You should test the battery at least once a month, to ensure the battery maintains full charging capabilities.
- Avoid leaving the bicycle [and battery] idle for long periods of time, as this can cause battery failure.
- In winter, the batteries may lose power faster because of low temperatures.
- Inappropriate storage can shorten the life of the lithium battery life or cause other mechanical problems. Please store the electric bicycle indoors in a cool and dry place.

## Cleaning

Before cleaning, make sure the bicycle is turned off, unplug the charging line and cover the charging port. During the cleaning process, be careful keep the water and moisture out of charging port. Use a dry cloth or a damp cloth to clean the cables – do not spray water on the bicycle or battery. During the cleaning process, be careful to keep water out of the charging port. Do not immerse the electric bicycle in water as it will cause permanent damage.

## Battery Recycling

Help keep the environment free of litter and harmful pollution by recycling the battery correctly – do not throw batteries in the trash – please recycle your battery responsibly. Please consult your local sanitation department guidelines for safe disposal of batteries and parts.

## Tire Maintenance

Make sure the pressure of the two tires inflated correctly – do not overinflate tires and try to keep the two tires at the same pressure. The default tire pressure both tires is 36/PSI. It is recommended that any flat tires be changed by an experienced bicycle shop mechanic.



**FCC Statement:**

This device complies with part 15 of the FCC Rules. Operation is subject to the following two conditions:

- (1) This device may not cause harmful interference, and
- (2) this device

must accept any interference received, including interference that may cause undesired operation.

This equipment has been tested and found to comply with the limits for a Class B digital device, pursuant to part 15 of the FCC Rules.

These limits are designed to provide reasonable protection against harmful interference in a residential installation. This equipment generates, uses and can radiate radio frequency energy and, if not installed and used in accordance with the instructions, may cause harmful interference to radio communications. However, there is no guarantee that interference will not occur in a particular installation. If this equipment does cause harmful interference to radio or television reception, which can be determined by turning the equipment off and on, the user is encouraged to try to correct the interference by one or more of the following measures:

- Reorient or relocate the receiving antenna.
- Increase the separation between the equipment and receiver.
- Connect the equipment into an outlet on a circuit different from that to which the receiver is connected.
- Consult the dealer or an experienced radio/TV technician for help.

Caution: Any changes or modifications not expressly approved by the party responsible for compliance could void the user's authority to operate the equipment.

This equipment complies with FCC radiation exposure limits set forth for an uncontrolled environment. This transmitter must not be co-located or operating in conjunction with any other antenna or transmitter.

**IC Statement:**

This device complies with Industry Canada's licence - exempt RSSs. Operation is subject to the following two conditions:

- (1) This device may not cause interference; and
- (2) This device must accept any interference, including interference that may cause undesired operation of the device.

Le présent appareil est conforme aux CNR d'Industrie Canada applicables aux appareils radio exempts de licence. L'exploitation est autorisée aux deux conditions suivantes : (1) l'appareil ne doit pas produire de brouillage, et (2) l'utilisateur de l'appareil doit accepter tout brouillage radioélectrique subi, même si le brouillage est susceptible d'en compromettre le fonctionnement.

[www.windhorse.com](http://www.windhorse.com)



Made in China



WINDHORSE APP  
Android / IOS