

天线规格书

Antenna specification for approval

客户名称 Customer name	慧为智能		
机型 Model	TVI8310X-金属壳盒子-AX201D2W 模块		
天线频段 Antenna frequency	2.4GHZ&5GHz		
天线功能 Antenna function	WIFI&BT&5Gwifi(主) 天线		
天线材质 Antenna material	FPC	FPC 颜色 FPC color	黑色
型号 model	SF2238A-1B2-A		
料号 Material number	SF2238A-1L24B-116-A		
客户料号 Customer Part Number			
索沃德承认签章 Ward accepted the signature		客户承认签章 Client acknowledges signature	
结构 structure	采购 Purchase		
文控 Document control	结构 structure		
射频 radio frequency	工程 engineering		
审核 To examine	品质 QC		
承办人 Responsible	审核 To examine		
日期 date 2023.07.25	盖章区 Seal area	日期 date 2023.07.25	盖章区 Seal area

序号	认证编号	材质类型	发证日期	备注
1	A2230173541101001E	镀锡铜线	2023-04-24	一年
2	CANEC2227657302	卤素	2022-12-28	一年
3	CANEC2227657303	背胶	2022-12-28	一年
4	SHAEC23000346911	FEP 护套	2023-01-13	一年
5	SHAEC22004639301	FEP 绝缘	2022-12-15	一年
6	SZXEC2203054804	锡线	2022-09-19	一年
7	SZXEC2203054808	锡条	2022-09-19	一年
8	ETR22800844	印刷油墨	2022-08-09	一年
9	A2230173918101001E	基材	2023-04-18	一年
10	CANEC2227574118	EVA 泡棉	2023-01-03	一年
11	SZXEC2202709609	导电布	2022-08-16	一年
12	CANEC2218227002	金镀层	2022-08-30	一年

目录

一:设备支持&可测试天线类型..... 1

二:概述..... 2

三:匹配电路图&机器图片&天线图片..... 3

四:天线驻波比&天线效率 (VSWR) 4

五:吞吐量测试&有源数据..... 5

六:信号强度..... 6

七:3D pattern..... 7

八:结构图纸..... 8

一:设备支持&可测试天线类型

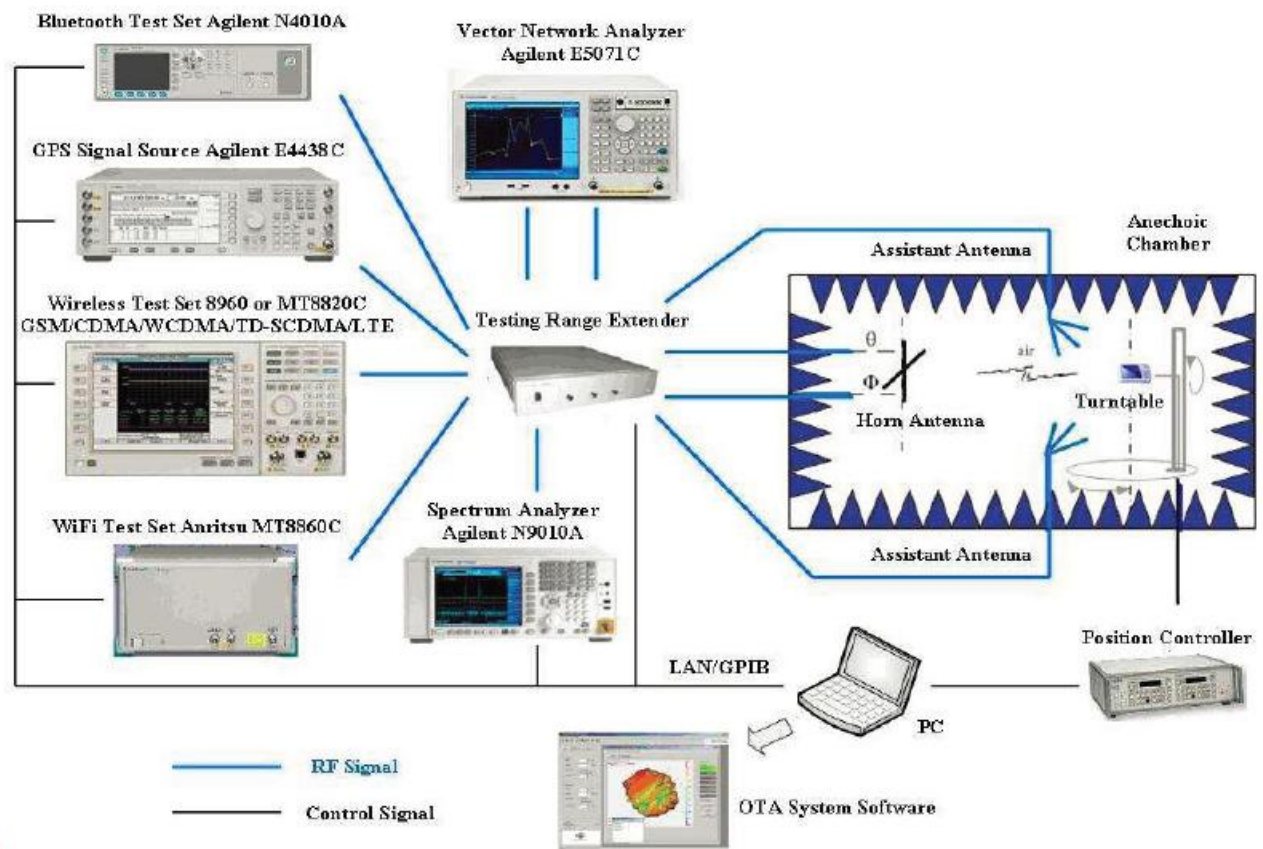

天线功能	频率范围	测试仪器	测试方式	测试标准
2G天线 (GSM)	824MHz-960MHz, 1710MHz-1990MHz	5071B、8960、 OTA暗室	有源测试、无源测试	索沃德标准、客户要求
3G天线 (WCDMA/TDSCDMA/CDMA-EVDO/2000)	824MHz-960MHz, 1710MHz-2170MHz	5071B、8960、 OTA暗室	有源测试、无源测试	索沃德标准、客户要求
4G天线 (LTE-FDD/LTE-TDD)		5071B、CMW500、 SP8011、OTA暗室	有源测试、无源测试	索沃德标准、客户要求
WIFI天线	2.4GHz-2.48GHz, 5.15GHz-5.35GHz, 5.725GHz-5.825GHz	5071B、CMW500、 OTA暗室、路由器 、PC	有源测试、无源测试 、APK实测、吞吐量 测试	索沃德标准、客户要求
BT天线	2.4GHz-2.48GHz	5071B、OTA暗室 、蓝牙音箱	无源测试、实测	索沃德标准、客户要求
定位天线 (GPS、GLONASS、北斗、伽利略)	1575.42MHz±10MHz 1602MHz+0.5625MHz 1561MHz+2.046MHz	5071B、OTA暗室 、APK	无源测试、实测	索沃德标准、客户要求
NFC天线	13.56MHz	5071B、专用测试 治具、OTA暗室、 APK	无源测试、实测	索沃德标准、客户要求
遥控天线	433MHz	5071B、OTA暗室	无源测试、实测	索沃德标准、客户要求

二:概述

(1)Antenna performance

1. This approval sheet supports for MID project. FPC antennas include in this project. This report is for the performance of WIFI&BT antenna.
2. Antenna shape size: Meet the requirement of MID
3. Antenna band: 2.4GHz~5GHz
4. Antenna material: Antenna material meet the requirement of MID
5. Adhesive performance: Adhesive performance meet the requirement of MID
6. Antenna performance meet the spec below:

Description	2.4GHz~5GHz	Units
VSWR	≤2.0	
Average Antenna Gain	≥-4.5	dB
Feed Impedance	50 ohms	
Operating Temperature	-40 to +85 deg C	
Polarization / Azimuth	Linear / Omni-directional	

(2)Mechanical Information

Mechanical Dimension	
Cable Length	116mm/BLACK
Description	WIFI&BT antenna
Material	FPC
Coaxial Cable	50Ω/O. D. 0.81mm
Environmental	
Operation Temperature	-40 to +85 deg C
Storage Temperature	-40 to +85 deg C

三: 匹配电路图&机器图片&天线图片

(1) 匹配电路

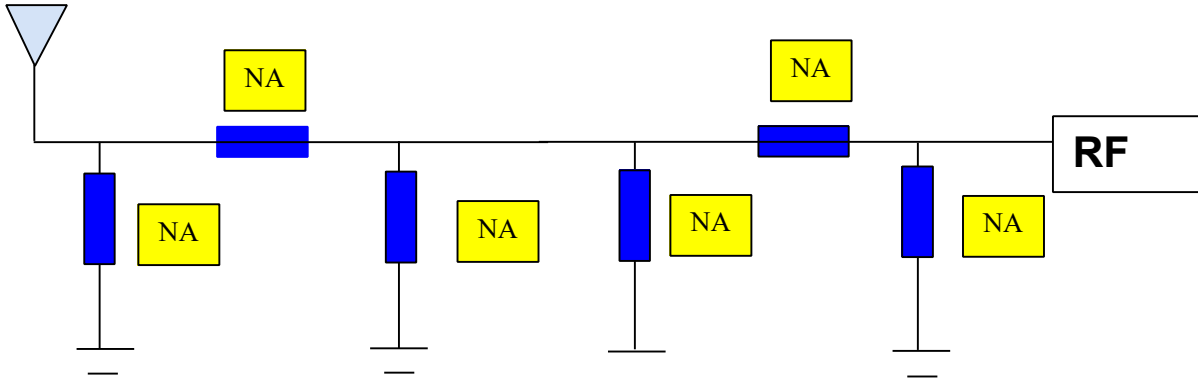

(2) 机器图片&天线图片

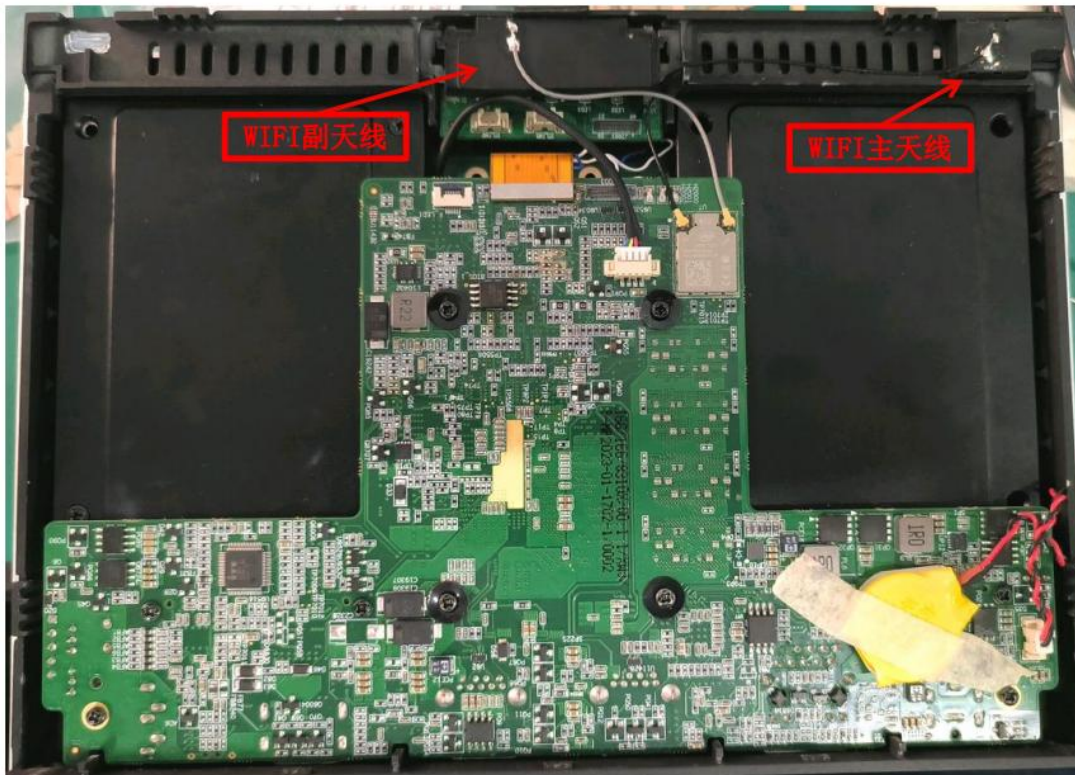

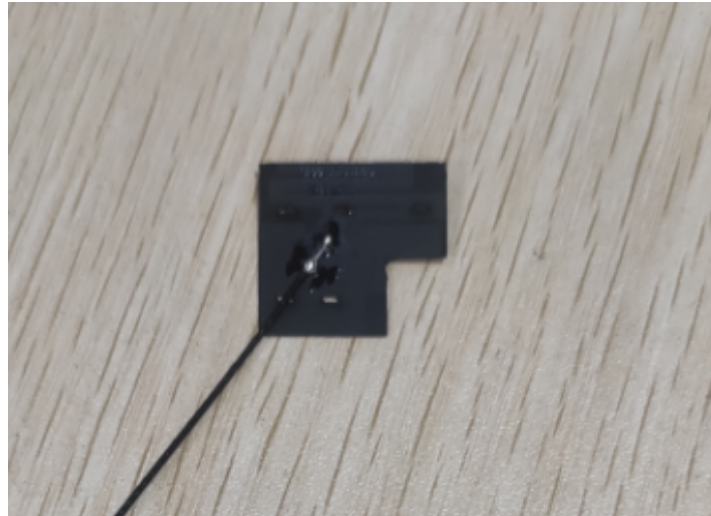

四: 天线驻波比&天线效率 (VSWR)



Passive Test For 2.4Gwifi								
Freq	Effi	Effi	Gain	Gain	UHS	DHS	Max	Min
(MHz)	(%)	(dB)	(dBi)	(dBd)	(%)	(%)	(dB)	(dB)
2400	38.84	-4.11	3.56	1.41	19.102	19.735	3.56	-13.51
2410	42.7	-3.7	4.27	2.12	21.859	20.845	4.27	-11.91
2420	42.92	-3.67	4.22	2.07	22.61	20.311	4.22	-12.09
2430	44.93	-3.47	4.29	2.14	24.421	20.511	4.29	-11.52
2440	50.42	-2.97	4.65	2.5	27.972	22.45	4.65	-10.51
2450	53.88	-2.69	4.8	2.65	30.395	23.486	4.8	-9.92
2460	55.59	-2.55	4.81	2.66	31.794	23.799	4.81	-9.89
2470	53.79	-2.69	4.53	2.38	31.158	22.634	4.53	-10.46
2480	54.6	-2.63	4.44	2.29	31.951	22.65	4.44	-11.68
2490	58.23	-2.35	4.53	2.38	34.396	23.829	4.53	-12.37
2500	61.57	-2.11	4.45	2.3	36.468	25.099	4.45	-12.74

Passive Test For 5Gwifi								
Freq	Effi	Effi	Gain	Gain	UHS	DHS	Max	Min
(MHz)	(%)	(dB)	(dBi)	(dBd)	(%)	(%)	(dB)	(dB)
5000	34.21	-4.66	1.53	-0.62	19.275	14.935	1.53	-17.75
5100	47.54	-3.23	3.64	1.49	26.142	21.399	3.64	-14.75
5200	58.13	-2.36	5.19	3.04	29.871	28.254	5.19	-16.93
5300	54.53	-2.63	3.65	1.5	29.913	24.619	3.65	-14.3
5400	53.22	-2.74	3.94	1.79	32.034	21.183	3.94	-13.55
5500	41.29	-3.84	2.29	0.14	26.541	14.747	2.29	-15.48
5600	46.08	-3.36	2.36	0.21	28.701	17.379	2.36	-16.31
5700	41.81	-3.79	2.45	0.3	28.829	12.977	2.45	-13.1
5800	31.08	-5.07	1.17	-0.98	20.796	10.289	1.17	-17.44
5900	41.71	-3.8	1.97	-0.18	26.241	15.47	1.97	-13.95
6000	57.59	-2.4	3.33	1.18	34.03	23.565	3.33	-13.1

五:吞吐量测试&有源数据

Iperf吞吐量测试						
机型	TVI8310X	模块	AX201D2W模块	软件版本	Magic_Iperf	
机型编号	频段	距离	测试角度	测试数据 (TX) 1min均值	测试数据 (RX) 1min均值	备注 (掉包次数)
1	2.4G	2.4G WIFI (研发测试15m)	0°	33.1 Mbps	122 Mbps	0
			90°	39.5 Mbps	173 Mbps	0
			180°	41.3 Mbps	153 Mbps	0
			270°	44.8 Mbps	166 Mbps	0
	5G	5F WIFI (研发测试15m)	0°	542 Mbps	692 Mbps	0
			90°	506 Mbps	706 Mbps	0
			180°	530 Mbps	633 Mbps	0
			270°	562 Mbps	620 Mbps	0

测试数据2.4Gwifi/5.8Gwifi (对应连接速率为 117 / 1201 Mbps)

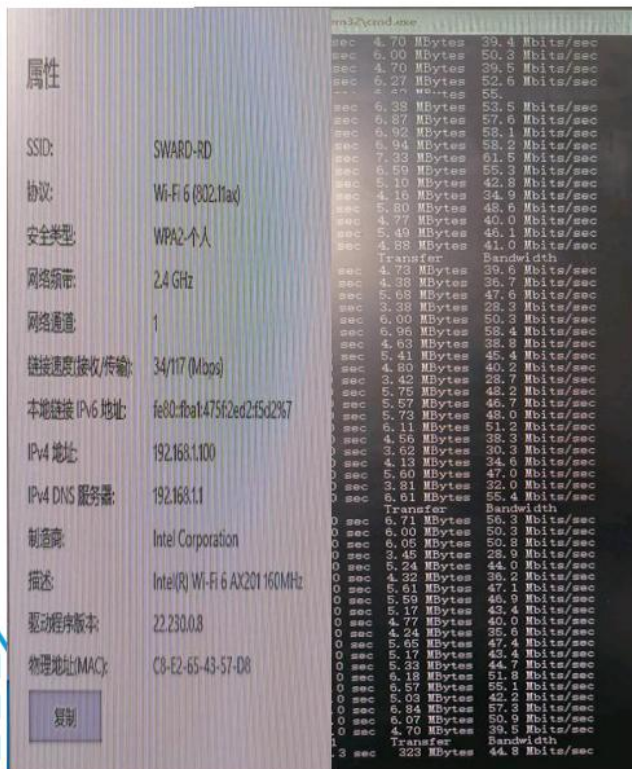

测试数据 2.4Gwifi/5.8Gwifi (对应连接速率为 117 / 1201 Mbps)

```

iperf -s
Server listening on TCP port 5001
TCP window size: 64.0 KByte (default)
-----
OpenSSL Manager failed - 拒绝访问。 (0x5)
[400] local 192.168.1.100 port 5001 connected with 192.168.1.114 port 49926
[ ID ] Interval Transfer Bandwidth
[400] 0.0-60.0 sec 4.83 GBytes 692 Mbits/sec
[ ID ] Interval Transfer Bandwidth
[404] local 192.168.1.100 port 5001 connected with 192.168.1.114 port 49947
[ ID ] Interval Transfer Bandwidth
[404] 0.0-60.0 sec 4.93 GBytes 706 Mbits/sec
[420] local 192.168.1.100 port 5001 connected with 192.168.1.114 port 49960
[ ID ] Interval Transfer Bandwidth
[420] 0.0-60.0 sec 4.42 GBytes 633 Mbits/sec
[412] local 192.168.1.100 port 5001 connected with 192.168.1.114 port 49974
[ ID ] Interval Transfer Bandwidth
[412] 0.0-20.3 sec 1.47 GBytes 620 Mbits/sec
[408] local 192.168.1.100 port 5001 connected with 192.168.1.114 port 49985
[ ID ] Interval Transfer Bandwidth
[408] 0.0-60.0 sec 795 MBytes 111 Mbits/sec
[412] local 192.168.1.100 port 5001 connected with 192.168.1.114 port 49997
[ ID ] Interval Transfer Bandwidth
[412] 0.0-60.1 sec 874 MBytes 122 Mbits/sec
[440] local 192.168.1.100 port 5001 connected with 192.168.1.114 port 50017
[ ID ] Interval Transfer Bandwidth
[440] 0.0-60.0 sec 1.21 GBytes 173 Mbits/sec
[444] local 192.168.1.100 port 5001 connected with 192.168.1.114 port 50032
[ ID ] Interval Transfer Bandwidth
[444] 0.0-60.0 sec 1.07 GBytes 153 Mbits/sec
[436] local 192.168.1.100 port 5001 connected with 192.168.1.114 port 50061
[ ID ] Interval Transfer Bandwidth
[436] 0.0-60.0 sec 1.16 GBytes 166 Mbits/sec
[348] local 192.168.1.100 port 5001 connected with 192.168.1.114 port 50075
[ ID ] Interval Transfer Bandwidth
[348] 0.0-60.0 sec 989 MBytes 138 Mbits/sec
    
```

```

C:\>iperf_s.exe -s
Server listening on TCP port 5001
TCP window size: 64.0 KByte (default)
-----
[376] local 192.168.1.114 port 5001 connected with 192.168.1.100 port 54615
[ ID ] Interval Transfer Bandwidth
[376] 0.0-60.1 sec 237 MBytes 33.1 Mbits/sec
[428] local 192.168.1.114 port 5001 connected with 192.168.1.100 port 54616
[ ID ] Interval Transfer Bandwidth
[428] 0.0-60.1 sec 283 MBytes 39.5 Mbits/sec
[412] local 192.168.1.114 port 5001 connected with 192.168.1.100 port 54617
[ ID ] Interval Transfer Bandwidth
[412] 0.0-60.2 sec 296 MBytes 41.3 Mbits/sec
[436] local 192.168.1.114 port 5001 connected with 192.168.1.100 port 54618
[ ID ] Interval Transfer Bandwidth
[436] 0.0-60.3 sec 323 MBytes 44.8 Mbits/sec
[428] local 192.168.1.114 port 5001 connected with 192.168.1.100 port 54622
[ ID ] Interval Transfer Bandwidth
[428] 0.0-60.0 sec 3.79 GBytes 542 Mbits/sec
[440] local 192.168.1.114 port 5001 connected with 192.168.1.100 port 64850
[ ID ] Interval Transfer Bandwidth
[440] 0.0-60.0 sec 3.54 GBytes 506 Mbits/sec
[424] local 192.168.1.114 port 5001 connected with 192.168.1.100 port 64851
[ ID ] Interval Transfer Bandwidth
[424] 0.0-60.0 sec 3.71 GBytes 530 Mbits/sec
[436] local 192.168.1.114 port 5001 connected with 192.168.1.100 port 64852
[ ID ] Interval Transfer Bandwidth
[436] 0.0-60.0 sec 3.93 GBytes 562 Mbits/sec
    
```

有源数据

机型编号	信道	b模式 (11MHz)		g模式 (54MHz)		n模式 (MCS7)		a模式 (54MHz)	
		TRP	TIS	TRP	TIS	TRP	TIS	TRP	TIS
1	1	10.25	-63.04	11.83	-53.48	12.29	-53.5	NA	NA
	7	11.45	-66.44	11.79	-53.53	12.22	-53.6	NA	NA
	13	11.75	-65.92	6.84	-53.01	6.8	-53.4	NA	NA
	36	NA	NA	NA	NA	14.59		14.29	-69.78
	149	NA	NA	NA	NA	13.96		13.63	-69.9
	165	NA	NA	NA	NA	15.51	-69.77	15.19	-69.15

六:信号强度

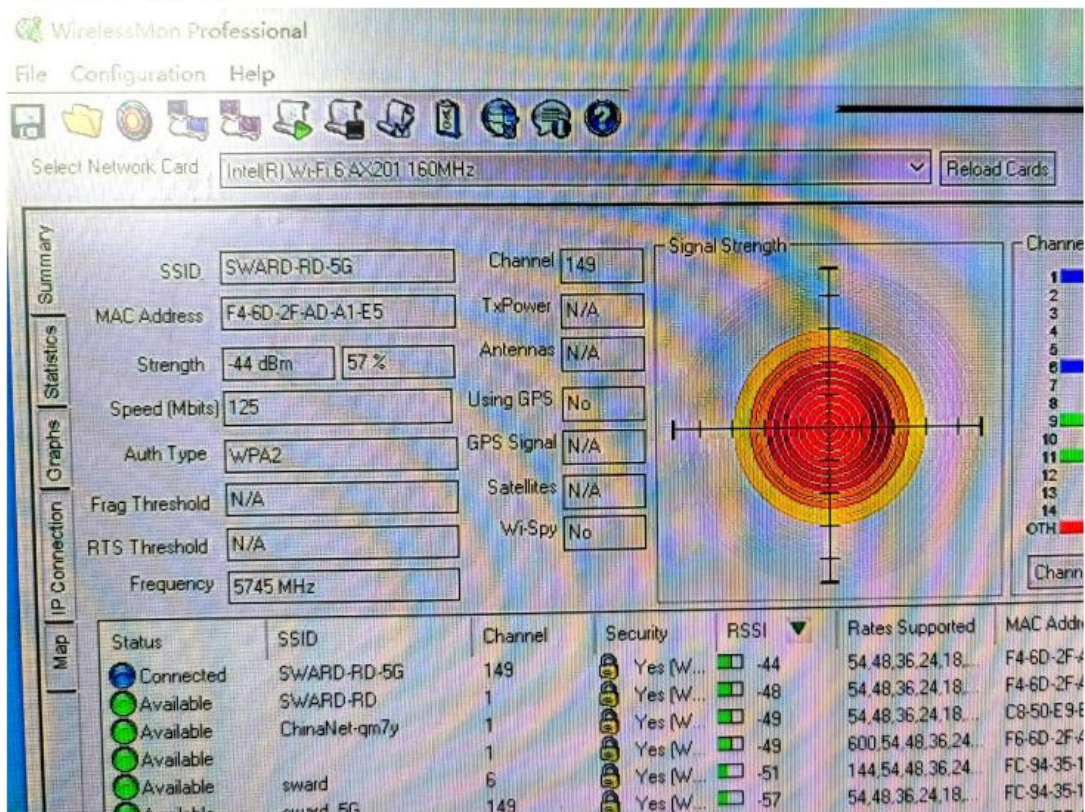
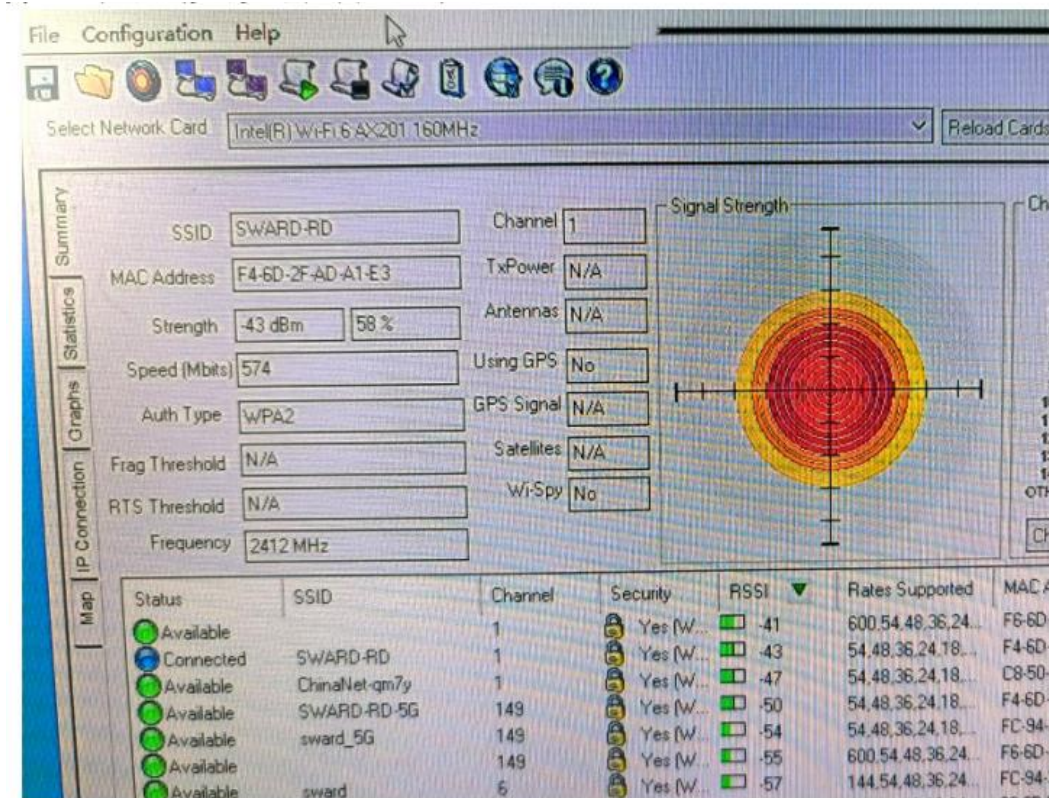

七:3D pattern

2400.000MHz

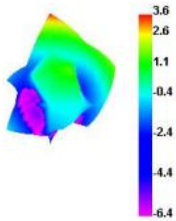

2450.000MHz

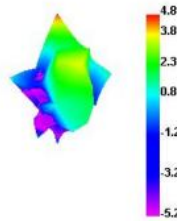

2500.000MHz

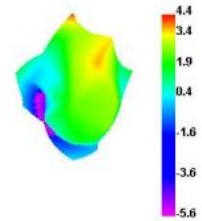

5500.000MHz

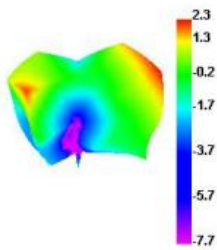

5000.000MHz

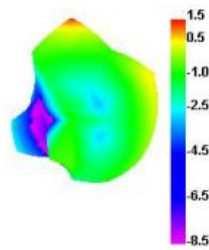

6000.000MHz

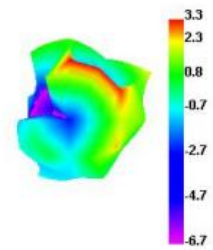

八:结构图纸

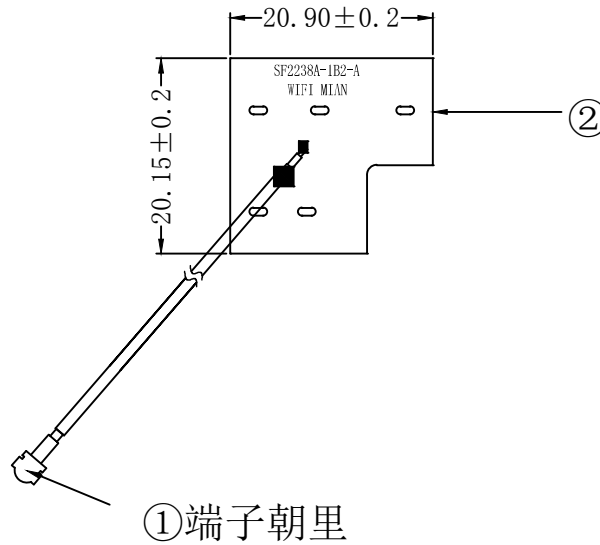
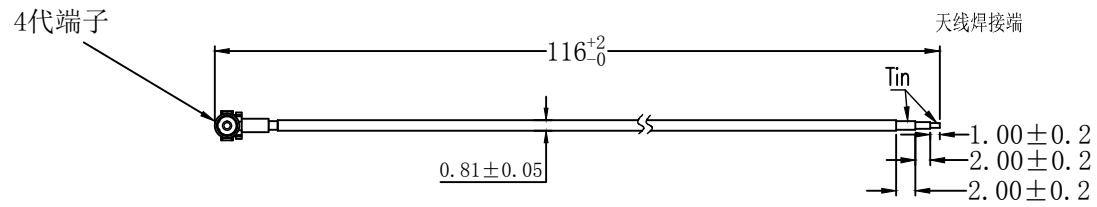

技术要求:

1. 打*为重点尺寸;
2. 尺寸符合图纸要求;
3. 焊点无虚焊、假焊。要求圆润、饱满。
4. 网分测试通过 (出现指定波形)。
5. 线形尺寸未注公差按照SJ/T 10628 1995 6级, 公差值由上下偏差均分;

5												SWARD	索沃德通讯技术有限公司	
4													SF2238A-1L24B-116-A	
3						签名	年月日	量产	签名	年月日	阶段标记		比例	
2	FPC		黑色	1	SF2238A-1B2-A	RD	YWD	2023.07.24	QC		1	A	1:1	ROHS
1	同轴线	4代端子	黑色	1	φ=0.81mm	RF					共 1 张 第 1 张			
序号	名称	材料	颜色	数量	描述	审核			批准					