



FCC TEST REPORT

FCC ID:2BCM7-X58

| | |
|--|--|
| Report Number | : ZHT-240521010E |
| Date of Test..... | : May 21, 2024 to May 30, 2024 |
| Date of issue..... | : May 30, 2024 |
| Test Result | : PASS |
| Testing Laboratory | : Guangdong Zhonghan Testing Technology Co., Ltd. |
| Address | : Room 104, Building 1, Yibaolai Industrial Park, Qiaotou Community, Fuhai Street, Bao'an District, Shenzhen, Guangdong, China |
| Applicant's name | : Shenzhen Chaoyin Electronics Co.,Ltd |
| Address | : 515, 5th Floor, Building 405, Sanda Industrial Zone, Zhenxing Road,Licun Community, Huaqiangbei Street, Futian District, Shenzhen |
| Manufacturer's name | : Shenzhen Chaoyin Electronics Co.,Ltd |
| Address | : 515, 5th Floor, Building 405, Sanda Industrial Zone, Zhenxing Road,Licun Community, Huaqiangbei Street, Futian District, Shenzhen |
| Test specification: | |
| Standard | : FCC CFR Title 47 Part 15 Subpart C Section 15.247 |
| Test procedure..... | : KDB558074 D01 15.247 Meas Guidance v05r02 ANSI C63.10:2013 |
| Non-standard test method | : N/A |
| <p>This device described above has been tested by ZHT, and the test results show that the equipment under test (EUT) is in compliance with the FCC requirements. And it is applicable only to the tested sample identified in the report.</p> <p>This report shall not be reproduced except in full, without the written approval of ZHT, this document may be altered or revised by ZHT, personal only, and shall be noted in the revision of the document.</p> | |
| Product name | : Wireless Headset |
| Trademark | : / |
| Model/Type reference | : X58, TWS, X1, X2, X3, X4, X5, X6, X7, X8, X9, X10, X11, X12, X13, X14, X15, X16, X17, X18, X19, X20, X21, X22, X23, X24, X25, X26, X27, X28, X29, X30, X31, X32, X33, X34, X35, X36, X37, X38, X39, X50, X51, X52, X53, X54, X55, X56, X57, X59, X60, X61, X62, X63, X64, X65, X66, X67, X68, X69, X70, X71, X72, X73, X74, X75, X76, X77, X78, X79, X80, X81, X82, X83, X84, X85, X86, X87, X88, X89, X90, X91, X92, X93, X94, X95, X96, X97, X98, X99, DX-25, DX-26, DX-21, DX-22, DX-27, DX-23 |
| Model Difference..... | : X58 is tested model, other models are derivative models .The model is exactly the same in circuit, PCB layout, RF Chip, appearance. So the test data of X58 can represent the remaining models |
| Ratings..... | : Input: 5 V $\overline{\text{---}}$ 0.2 A |



Testing procedure and testing location:

Testing Laboratory: Guangdong Zhonghan Testing Technology Co., Ltd.

Address: Room 104, Building 1, Yibaolai Industrial Park, Qiaotou Community, Fuhai Street, Bao'an District, Shenzhen, Guangdong, China

Tested by (name + signature): Kevin Yang

Reviewer (name + signature): Baret Wu

Approved (name + signature): Levi Lee



Table of Contents

| | Page |
|---|-----------|
| 2.1 TEST FACILITY | 7 |
| 2.2 MEASUREMENT UNCERTAINTY | 7 |
| 3. GENERAL INFORMATION | 8 |
| 3.1 GENERAL DESCRIPTION OF EUT | 8 |
| 3.3 Support Equipment | 10 |
| 3.4 Test Mode | 10 |
| 3.5 EQUIPMENTS LIST FOR ALL TEST ITEMS | 11 |
| 4. EMC EMISSION TEST | 13 |
| 4.1 Conducted emissions | 13 |
| 4.1.1 POWER LINE CONDUCTED EMISSION Limits | 13 |
| 4.1.2 TEST PROCEDURE | 13 |
| 4.1.3 DEVIATION FROM TEST STANDARD | 13 |
| 4.1.4 TEST SETUP | 14 |
| 4.1.5 EUT OPERATING CONDITIONS | 14 |
| 4.1.6 TEST RESULTS | 14 |
| 4.2 Radiated emissions | 15 |
| 4.2.1 Radiated Emission Limits | 15 |
| 4.2.2 TEST PROCEDURE | 15 |
| 4.2.3 DEVIATION FROM TEST STANDARD | 16 |
| 4.2.4 TEST SETUP | 16 |
| 4.2.5 EUT OPERATING CONDITIONS | 17 |
| 4.2.6 TEST RESULTS | 18 |
| 5.1 Test Requirement: | 28 |
| 5.2 TEST PROCEDURE | 28 |
| 5.3 DEVIATION FROM TEST STANDARD | 29 |
| 5.4 TEST SETUP | 29 |
| 5.5 EUT OPERATING CONDITIONS | 29 |
| 6. CONDUCTED BAND EDGE AND SPURIOUS EMISSION | 33 |
| 6.1 Limit | 33 |
| 6.2 Test Setup | 33 |
| 6.3 Test procedure | 33 |
| 6.4 DEVIATION FROM STANDARD | 33 |
| 6.5 Test Result | 33 |
| 7. 20DB BANDWIDTH | 34 |
| 7.1 Test Setup | 34 |
| 7.2 Limit | 34 |
| 7.3 Test procedure | 34 |
| 7.4 DEVIATION FROM STANDARD | 34 |
| 7.5 Test Result | 34 |
| 8. MAXIMUM PEAK OUTPUT POWER | 35 |
| 8.1 Block Diagram Of Test Setup | 35 |
| 8.2 Limit | 35 |
| 8.3 Test procedure | 35 |
| 8.4 DEVIATION FROM STANDARD | 35 |
| 8.5 Test Result | 35 |
| 9. HOPPING CHANNEL SEPARATION | 36 |
| 9.1 Test Setup | 36 |
| 9.2 Test procedure | 36 |
| 9.3 DEVIATION FROM STANDARD | 36 |
| 10. NUMBER OF HOPPING FREQUENCY | 37 |
| 10.1 Test Setup | 37 |
| 10.2 Test procedure | 37 |
| 10.3 DEVIATION FROM STANDARD | 37 |
| 10.4 Test Result | 37 |
| 11. DWELL TIME | 38 |



11.1 Test Setup.....38

11.2 Test procedure.....38

11.3 DEVIATION FROM STANDARD.....38

11.4 Test Result.....38

12. ANTENNA REQUIREMENT39

13.APPENDIX BT40

13.1 Dwell Time40

13.2 Maximum Peak Conducted Output Power50

13.3 -20dB Bandwidth.....51

13.4 Occupied Channel Bandwidth57

13.5 Carrier Frequencies Separation.....63

13.6 Number of Hopping Channel69

13.7 Band Edge74

13.9 Conducted RF Spurious Emission.....86

14. TEST SETUP PHOTO96

15. EUT CONSTRUCTIONAL DETAILS96



1. Version

| Report No. | Version | Description | Approved |
|----------------|---------|-------------------------|--------------|
| ZHT-240521010E | Rev.01 | Initial issue of report | May 30, 2024 |
| | | | |

**2. TEST SUMMARY**

Test procedures according to the technical standards:

| FCC Part15 (15.247) , Subpart C | | | |
|---------------------------------|--|--------|--------|
| Standard Section | Test Item | Result | Remark |
| FCC part 15.203/15.247 (b)(4) | Antenna Requirement | PASS | |
| 15.207 | AC Power Line Conducted Emission | N/A | |
| 15.247 (b)(1) | Conducted Output Power | PASS | |
| 15.247 (a)(1) | 20dB Occupied Bandwidth | PASS | |
| 15.247 (a)(1) | Carrier Frequencies Separation | PASS | |
| 15.247 (a)(1)(iii) | Hopping Channel Number | PASS | |
| 15.247 (a)(1)(iii) | Dwell Time | PASS | |
| 15.205/15.209 | Radiated Emission and Restricted Band | PASS | |
| 15.247(d) | Conducted Unwanted emissions and Band Edge | PASS | |

The RF chips of the left and right earphones are the same, with differences in circuit layout. The RF output power of the left and right earphones is not significantly different, while the RF output power of the left earphone is slightly larger than that of the right earphone. So chose the left earphone for all the tests, while the right earphone was tested for radiation emissions and radiation spurious tests.

NOTE:

- (1) " N/A" denotes test is not applicable in this Test Report
- (2) The EUT was programmed to be in continuously transmitting mode and the transmit duty cycle is not less than 98%.



2.1 TEST FACILITY

Guangdong Zhonghan Testing Technology Co., Ltd.
Add. : Room 104, Building 1, Yibaolai Industrial Park, Qiaotou Community, Fuhai Street, Bao'an District, Shenzhen, Guangdong, China

FCC Registration Number:255941
Designation Number: CN0325
IC Registered No.: 29832
CAB identifier: CN0143

2.2 MEASUREMENT UNCERTAINTY

The reported uncertainty of measurement $y \pm U$, where expanded uncertainty U is based on a standard uncertainty multiplied by a coverage factor of $k=2$, providing a level of confidence of approximately 95 %.

| No. | Item | Uncertainty |
|-----|----------------------------------|-------------------------|
| 1 | Conducted Emission Test | $\pm 1.38\text{dB}$ |
| 2 | RF power conducted | $\pm 0.16\text{dB}$ |
| 3 | Spurious emissions conducted | $\pm 0.21\text{dB}$ |
| 4 | All emissions radiated(9k-30MHz) | $\pm 4.68\text{dB}$ |
| 5 | All emissions radiated(<1G) | $\pm 4.68\text{dB}$ |
| 6 | All emissions radiated(>1G) | $\pm 4.89\text{dB}$ |
| 7 | Temperature | $\pm 0.5^\circ\text{C}$ |
| 8 | Humidity | $\pm 2\%$ |
| 9 | Occupied Bandwidth | $\pm 4.96\%$ |



3. GENERAL INFORMATION

3.1 GENERAL DESCRIPTION OF EUT

| | |
|------------------------|----------------------------|
| Product Name: | Wireless Headset |
| Test Model No.: | TWS |
| Hardware Version: | V1.0 |
| Software Version: | V1.0 |
| Sample(s) Status: | Engineer sample |
| Channel numbers: | 79 |
| Channel separation: | 1 MHz |
| Modulation technology: | GFSK, $\pi/4$ DQPSK, 8DPSK |
| Antenna Type: | Chip antenna |
| Antenna gain: | 2.7dBi |



| Operation Frequency each of channel | | | | | | | |
|-------------------------------------|-----------|---------|-----------|---------|-----------|---------|-----------|
| Channel | Frequency | Channel | Frequency | Channel | Frequency | Channel | Frequency |
| 1 | 2402MHz | 21 | 2422MHz | 41 | 2442MHz | 61 | 2462MHz |
| 2 | 2403MHz | 22 | 2423MHz | 42 | 2443MHz | 62 | 2463MHz |
| 3 | 2404MHz | 23 | 2424MHz | 43 | 2444MHz | 63 | 2464MHz |
| 4 | 2405MHz | 24 | 2425MHz | 44 | 2445MHz | 64 | 2465MHz |
| 5 | 2406MHz | 25 | 2426MHz | 45 | 2446MHz | 65 | 2466MHz |
| 6 | 2407MHz | 26 | 2427MHz | 46 | 2447MHz | 66 | 2467MHz |
| 7 | 2408MHz | 27 | 2428MHz | 47 | 2448MHz | 67 | 2468MHz |
| 8 | 2409MHz | 28 | 2429MHz | 48 | 2449MHz | 68 | 2469MHz |
| 9 | 2410MHz | 29 | 2430MHz | 49 | 2450MHz | 69 | 2470MHz |
| 10 | 2411MHz | 30 | 2431MHz | 50 | 2451MHz | 70 | 2471MHz |
| 11 | 2412MHz | 31 | 2432MHz | 51 | 2452MHz | 71 | 2472MHz |
| 12 | 2413MHz | 32 | 2433MHz | 52 | 2453MHz | 72 | 2473MHz |
| 13 | 2414MHz | 33 | 2434MHz | 53 | 2454MHz | 73 | 2474MHz |
| 14 | 2415MHz | 34 | 2435MHz | 54 | 2455MHz | 74 | 2475MHz |
| 15 | 2416MHz | 35 | 2436MHz | 55 | 2456MHz | 75 | 2476MHz |
| 16 | 2417MHz | 36 | 2437MHz | 56 | 2457MHz | 76 | 2477MHz |
| 17 | 2418MHz | 37 | 2438MHz | 57 | 2458MHz | 77 | 2478MHz |
| 18 | 2419MHz | 38 | 2439MHz | 58 | 2459MHz | 78 | 2479MHz |
| 19 | 2420MHz | 39 | 2440MHz | 59 | 2460MHz | 79 | 2480MHz |
| 20 | 2421MHz | 40 | 2441MHz | 60 | 2461MHz | | |

Note:

In section 15.31(m), regards to the operating frequency range over 10 MHz, the Lowest frequency, the middle frequency, and the highest frequency of channel were selected to perform the test, and the selected channel see below:

| Test channel | Frequency |
|---------------------|-----------|
| The lowest channel | 2402MHz |
| The middle channel | 2441MHz |
| The Highest channel | 2480MHz |



3.2 Test Setup Configuration

Radiated Emission

EUT

3.3 Support Equipment

The EUT has been tested as an independent unit together with other necessary accessories or support units. The following support units or accessories were used to form a representative test configuration during the tests.

| Item | Equipment | Mfr/Brand | Model/Type No. | Series No. | Note |
|------|-----------|-----------|----------------|------------|------|
| | | | | | |
| | | | | | |

| Item | Shielded Type | Ferrite Core | Length | Note |
|------|---------------|--------------|--------|------|
| | | | | |
| | | | | |

Note:

- (1) The support equipment was authorized by Declaration of Confirmation.
- (2) For detachable type I/O cable should be specified the length in cm in 『Length』 column.

3.4 Test Mode

| | |
|---|---|
| Transmitting mode | Keep the EUT in continuously transmitting mode. |
| Remark: During the test, the test voltage was tuned from 85% to 115% of the nominal rated supply voltage, and found that the worst case was under the nominal rated supply condition. So the report just shows that condition's data. | |



3.5 EQUIPMENTS LIST FOR ALL TEST ITEMS

Radiation Test equipment

| Item | Equipment | Manufacturer | Model | Last Cal. | Next Cal. |
|------|------------------------------------|--------------|--------------|---------------|---------------|
| 1 | Receiver | R&S | ESCI | May 10, 2024 | May 09, 2025 |
| 2 | Loop antenna | EMCI | LAP600 | May 10, 2024 | May 09, 2025 |
| 3 | Amplifier | Schwarzbeck | BBV 9743 B | May 10, 2024 | May 09, 2025 |
| 4 | Amplifier | Schwarzbeck | BBV 9718 B | May 10, 2024 | May 09, 2025 |
| 5 | Bilog Antenna | Schwarzbeck | VULB9162 | Aug. 04, 2023 | Aug. 03, 2024 |
| 6 | Horn Antenna | Schwarzbeck | BBHA9120D | May 16, 2024 | May 15, 2025 |
| 7 | Horn Antenna | A.H.SYSTEMS | SAS574 | May 10, 2024 | May 09, 2025 |
| 8 | Amplifier | AEROFLEX | 100KHz-40GHz | May 10, 2024 | May 09, 2025 |
| 9 | Spectrum Analyzer | R&S | FSV40 | May 16, 2024 | May 15, 2025 |
| 11 | 966 Anechoic Chamber | EMToni | 9m6m6m | Nov. 25, 2021 | Nov. 24, 2024 |
| 12 | Spectrum Analyzer | KEYSIGHT | N9020A | May 10, 2024 | May 09, 2025 |
| 13 | WIDBAND RADIO COMMUNICATION TESTER | R&S | CMW500 | May 10, 2024 | May 09, 2025 |
| 14 | Single Generator | Agilent | N5182A | May 10, 2024 | May 09, 2025 |
| 15 | Power Sensor | MWRftest | MW100-RFCB | May 10, 2024 | May 09, 2025 |
| 16 | Audio analyzer | R&S | UPL | May 10, 2024 | May 09, 2025 |
| 17 | Single Generator | R&S | SMB100A | May 10, 2024 | May 09, 2025 |
| 18 | Power Amplifier Shielding Room | EMToni | 2m3m3m | Nov. 25, 2021 | Nov. 24, 2024 |



Conduction Test equipment

| Equipment | Manufacturer | Model | Last Cal. | Next Cal. |
|---------------------------|--------------|------------|---------------|---------------|
| Receiver | R&S | ESCI | May 10, 2024 | May 09, 2025 |
| LISN | R&S | ENV216 | May 10, 2024 | May 09, 2025 |
| ISN CAT 6 | Schwarzbeck | NTFM 8158 | May 10, 2024 | May 09, 2025 |
| ISN CAT 5 | Schwarzbeck | CAT5 8158 | May 10, 2024 | May 09, 2025 |
| Capacitive Voltage Probe | Schwarzbeck | CVP 9222 C | May 10, 2024 | May 09, 2025 |
| Current Transformer Clamp | Schwarzbeck | SW 9605 | May 10, 2024 | May 09, 2025 |
| CE Shielding Room | EMToni | 9m4m3m | Nov. 25, 2021 | Nov. 24, 2024 |



4. EMC EMISSION TEST

4.1 Conducted emissions

| | |
|-----------------------|--------------------------------------|
| Test Requirement: | FCC Part15 C Section 15.207 |
| Test Method: | ANSI C63.10:2013 |
| Test Frequency Range: | 150KHz to 30MHz |
| Receiver setup: | RBW=9KHz, VBW=30KHz, Sweep time=auto |

4.1.1 POWER LINE CONDUCTED EMISSION Limits

| FREQUENCY (MHz) | Limit (dBuV) | | Standard |
|-----------------|--------------|-----------|----------|
| | Quasi-peak | Average | |
| 0.15 -0.5 | 66 - 56 * | 56 - 46 * | FCC |
| 0.50 -5.0 | 56.00 | 46.00 | FCC |
| 5.0 -30.0 | 60.00 | 50.00 | FCC |

Note:

(1) *Decreases with the logarithm of the frequency.

4.1.2 TEST PROCEDURE

- a. The EUT was placed 0.8 meters from the horizontal ground plane with EUT being connected to the power mains through a line impedance stabilization network (LISN). All other support equipments powered from additional LISN(s). The LISN provide 50 Ohm/ 50uH of coupling impedance for the measuring instrument.
- b. Interconnecting cables that hang closer than 40 cm to the ground plane shall be folded back and forth in the center forming a bundle 30 to 40 cm long.
- c. I/O cables that are not connected to a peripheral shall be bundled in the center. The end of the cable may be terminated, if required, using the correct terminating impedance. The overall length shall not exceed 1 m.
- d. LISN at least 80 cm from nearest part of EUT chassis.
- e. For the actual test configuration, please refer to the related Item –EUT Test Photos.

4.1.3 DEVIATION FROM TEST STANDARD

No deviation

4.1.4 TEST SETUP

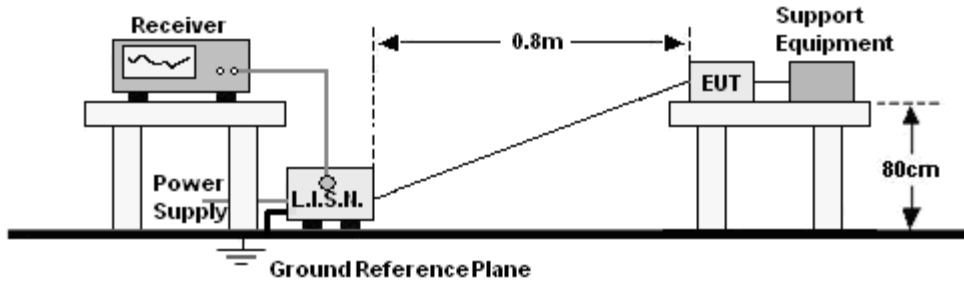

4.1.5 EUT OPERATING CONDITIONS

The EUT was configured for testing in a typical fashion (as a customer would normally use it). The EUT has been programmed to continuously transmit during test. This operating condition was tested and used to collect the included data.

4.1.6 TEST RESULTS

N/A

The charging and Bluetooth functions of this product cannot be started at the same time



4.2 Radiated emissions

| | | | | | |
|-----------------------|-----------------------------|------------|--------|---------|------------|
| Test Requirement: | FCC Part15 C Section 15.209 | | | | |
| Test Method: | ANSI C63.10:2013 | | | | |
| Test Frequency Range: | 9kHz to 25GHz | | | | |
| Test site: | Measurement Distance: 3m | | | | |
| Receiver setup: | Frequency | Detector | RBW | VBW | Value |
| | 9KHz-150KHz | Quasi-peak | 200Hz | 600Hz | Quasi-peak |
| | 150KHz-30MHz | Quasi-peak | 9KHz | 30KHz | Quasi-peak |
| | 30MHz-1GHz | Quasi-peak | 100KHz | 300KHz | Quasi-peak |
| | Above 1GHz | Peak | 1MHz | 3MHz | Peak |
| Peak | | 1MHz | 10Hz | Average | |

4.2.1 Radiated Emission Limits

| Frequencies (MHz) | Field Strength (microvolt/meter) | Measurement Distance (meters) |
|-------------------|----------------------------------|-------------------------------|
| 0.009~0.490 | 2400/F(KHz) | 300 |
| 0.490~1.705 | 24000/F(KHz) | 30 |
| 1.705~30.0 | 30 | 30 |
| 30~88 | 100 | 3 |
| 88~216 | 150 | 3 |
| 216~960 | 200 | 3 |
| Above 960 | 500 | 3 |

LIMITS OF RADIATED EMISSION MEASUREMENT

| FREQUENCY (MHz) | Limit (dBuV/m) (at 3M) | |
|-----------------|------------------------|---------|
| | PEAK | AVERAGE |
| Above 1000 | 74 | 54 |

Notes:

- (1) The limit for radiated test was performed according to FCC PART 15C.
- (2) The tighter limit applies at the band edges.
- (3) Emission level (dBuV/m)=20log Emission level (uV/m).

4.2.2 TEST PROCEDURE

30MHz- 1GHz test procedure as below:

- a. The EUT was placed on the top of a rotating table 0.8 meters above the ground at a 3 meter semi-anechoic chamber. The table was rotated 360 degrees to determine the position of the highest radiation.
- b. The EUT was set 3 meters away from the interference-receiving antenna, which was mounted on the top of a variable-height antenna tower.
- c. The antenna height is varied from one meter to four meters above the ground to determine the maximum value of the field strength. Both horizontal and vertical polarizations of the antenna are set to make the measurement.

- d. For each suspected emission, the EUT was arranged to its worst case and then the antenna was tuned to heights from 1 meter to 4 meters (for the test frequency of below 30MHz, the antenna was tuned to heights 1 meter) and the rotatable table was turned from 0 degrees to 360 degrees to find the maximum reading.
- e. The test-receiver system was set to Peak Detect Function and Specified Bandwidth with Maximum Hold Mode.
- f. If the emission level of the EUT in peak mode was 10dB lower than the limit specified, then testing could be stopped and the peak values of the EUT would be reported. Otherwise the emissions that did not have 10dB margin would be re-tested one by one using peak, quasi-peak or average method as specified and then reported in a data sheet.

Above 1GHz test procedure as below:

- g. Different between above is the test site, change from Semi- Anechoic Chamber to fully Anechoic Chamber and change form table 0.8 metre to 1.5 metre(Above 18GHz the distance is 1 meter and table is 1.5 metre).
- h. Test the EUT in the lowest channel ,the middle channel ,the Highest channel

Note:

Both horizontal and vertical antenna polarities were tested and performed pretest to three orthogonal axis. The worst case emissions were reported

4.2.3 DEVIATION FROM TEST STANDARD

No deviation

4.2.4 TEST SETUP

(A) Radiated Emission Test-Up Frequency Below 30MHz

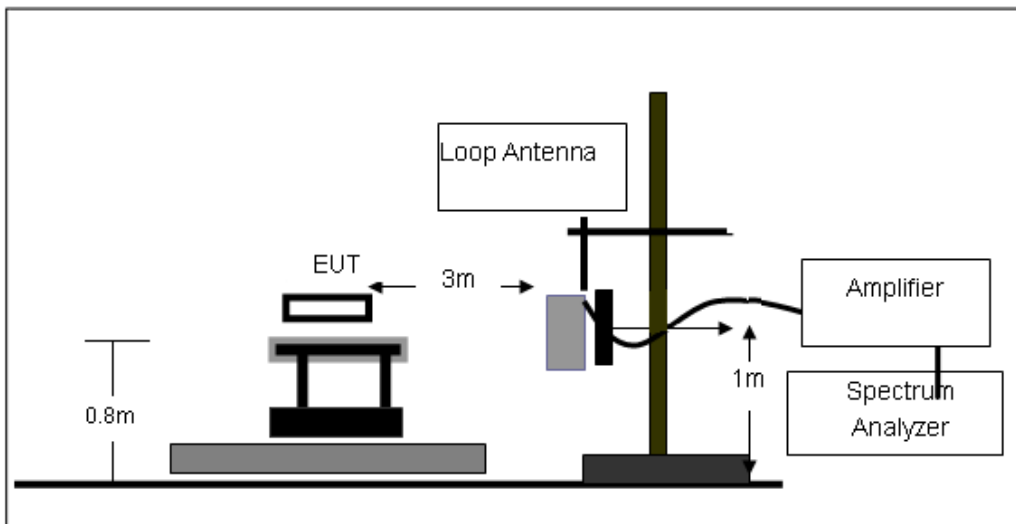

(B) Radiated Emission Test-Up Frequency 30MHz~1GHz

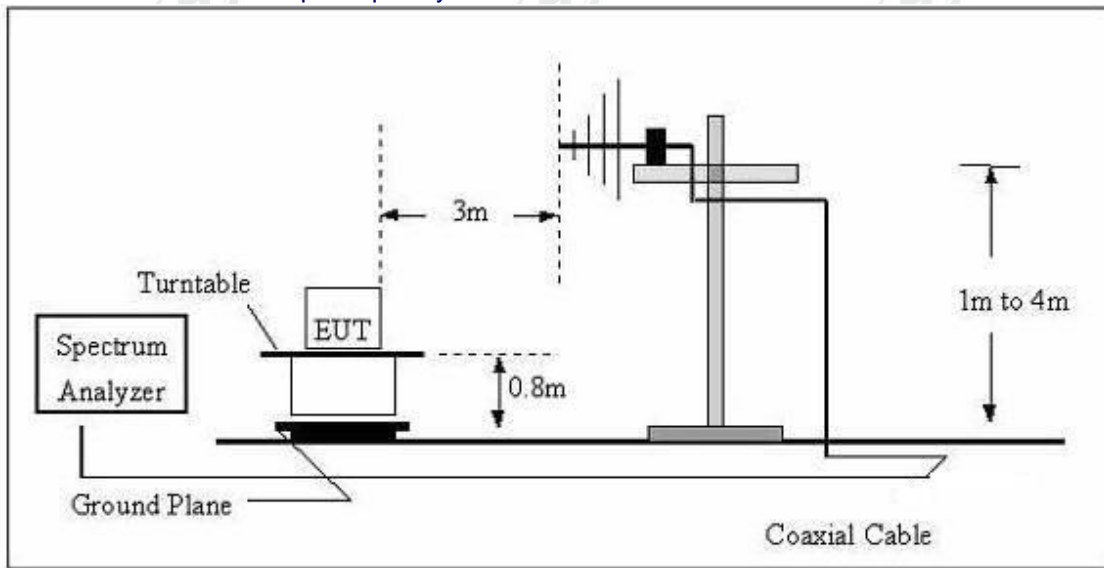

(C) Radiated Emission Test-Up Frequency Above 1GHz

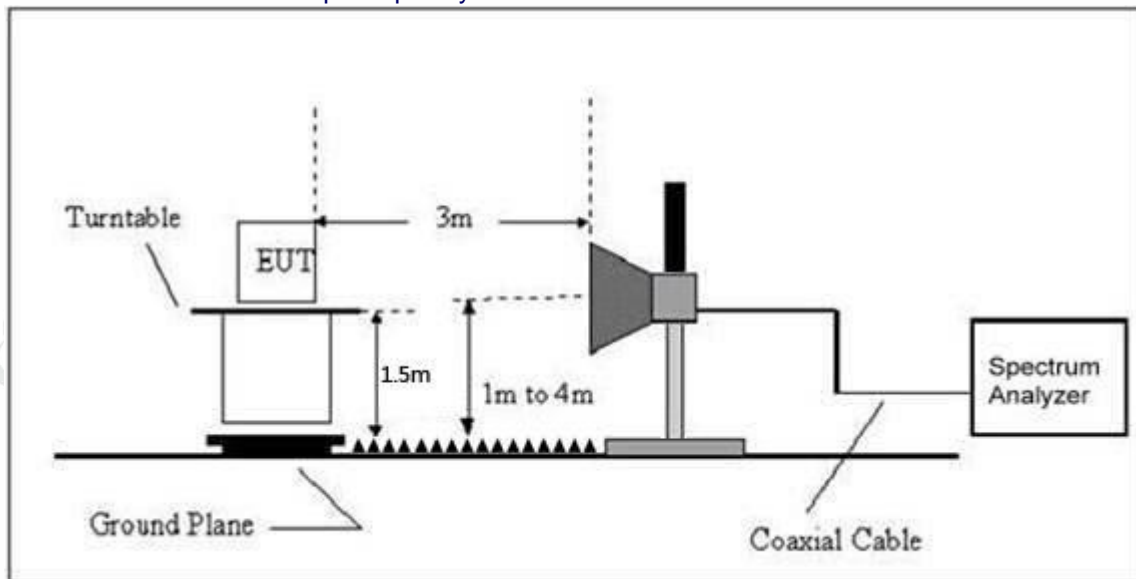

4.2.5 EUT OPERATING CONDITIONS

The EUT tested system was configured as the statements of 2.4 Unless otherwise a special operating condition is specified in the follows during the testing.



4.2.6 TEST RESULTS

Between 9KHz – 30MHz

The emission from 9 kHz to 30MHz was pre-tested and found the result was 20dB lower than the limit, and according to 15.31(o), the test result no need to reported.

Between 30MHz – 1GHz (Left earphone)

| | | | |
|---------------|---------|--------------------|------------|
| Temperature: | 25.6°C | Relative Humidity: | 47% |
| Pressure: | 101 kPa | Polarization: | Horizontal |
| Test Voltage: | DC 3.7V | | |

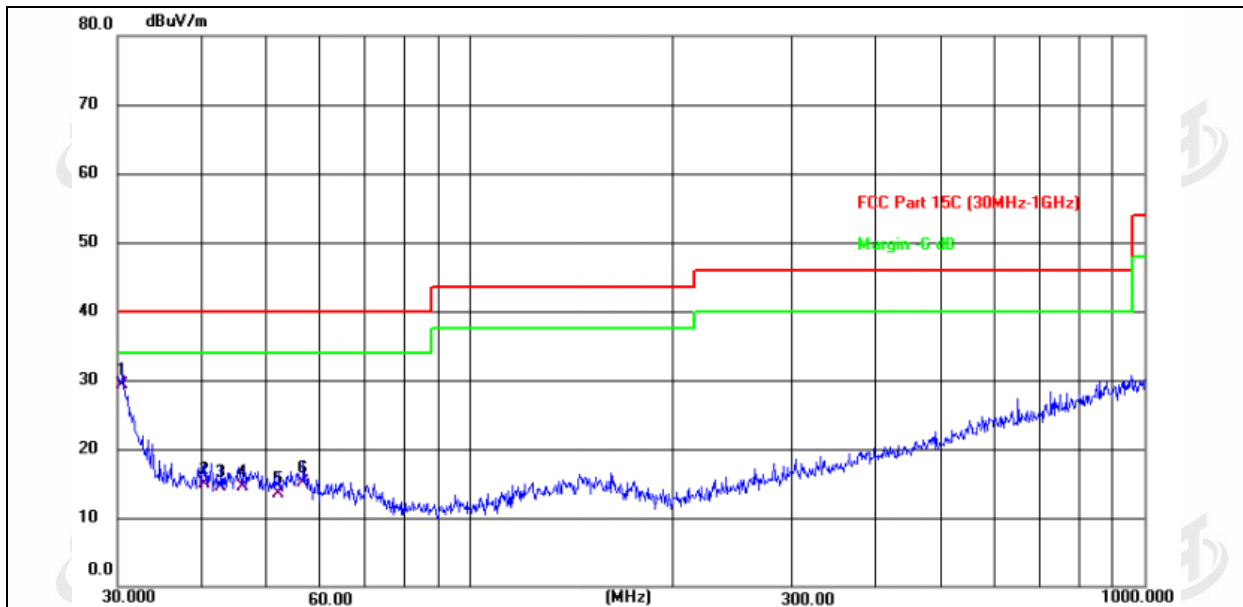

| No. | Frequency (MHz) | Reading (dBuV) | Factor (dB/m) | Level (dBuV/m) | Limit (dBuV/m) | Margin (dB) | Detector |
|-----|-----------------|----------------|---------------|----------------|----------------|-------------|----------|
| 1 * | 30.5304 | 38.97 | -9.67 | 29.30 | 40.00 | -10.70 | QP |
| 2 | 40.4170 | 23.24 | -8.32 | 14.92 | 40.00 | -25.08 | QP |
| 3 | 42.7494 | 22.91 | -8.44 | 14.47 | 40.00 | -25.53 | QP |
| 4 | 46.1779 | 23.10 | -8.63 | 14.47 | 40.00 | -25.53 | QP |
| 5 | 52.0251 | 22.58 | -9.05 | 13.53 | 40.00 | -26.47 | QP |
| 6 | 56.5930 | 24.61 | -9.56 | 15.05 | 40.00 | -24.95 | QP |



| | | | |
|---------------|---------|--------------------|----------|
| Temperature: | 25.6°C | Relative Humidity: | 47% |
| Pressure: | 101kPa | Polarization: | Vertical |
| Test Voltage: | DC 3.7V | | |

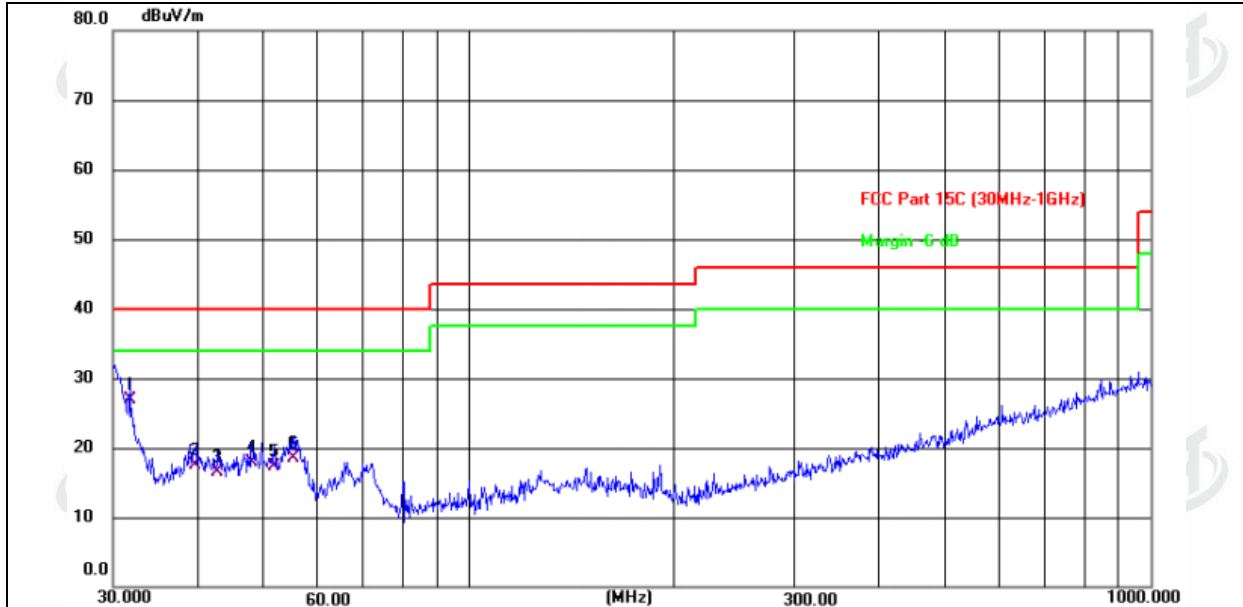

| No. | Frequency (MHz) | Reading (dBuV) | Factor (dB/m) | Level (dBuV/m) | Limit (dBuV/m) | Margin (dB) | Detector |
|-----|-----------------|----------------|---------------|----------------|----------------|-------------|----------|
| 1 * | 31.7312 | 36.36 | -9.50 | 26.86 | 40.00 | -13.14 | QP |
| 2 | 39.7146 | 25.84 | -8.33 | 17.51 | 40.00 | -22.49 | QP |
| 3 | 42.7495 | 24.85 | -8.44 | 16.41 | 40.00 | -23.59 | QP |
| 4 | 47.9940 | 26.64 | -8.73 | 17.91 | 40.00 | -22.09 | QP |
| 5 | 51.6615 | 26.31 | -9.01 | 17.30 | 40.00 | -22.70 | QP |
| 6 | 55.2207 | 28.01 | -9.41 | 18.60 | 40.00 | -21.40 | QP |

Remarks:

1. Final Level = Receiver Read level + Antenna Factor + Cable Loss – Preamplifier Factor
2. The emission levels of other frequencies are very lower than the limit and not show in test report.
3. The test data shows only the worst case Low Channel: 2402MHz)



Between 30MHz – 1GHz (Right earphone)

| | | | |
|---------------|---------|--------------------|------------|
| Temperature: | 25.6°C | Relative Humidity: | 47% |
| Pressure: | 101 kPa | Polarization: | Horizontal |
| Test Voltage: | DC 3.7V | | |

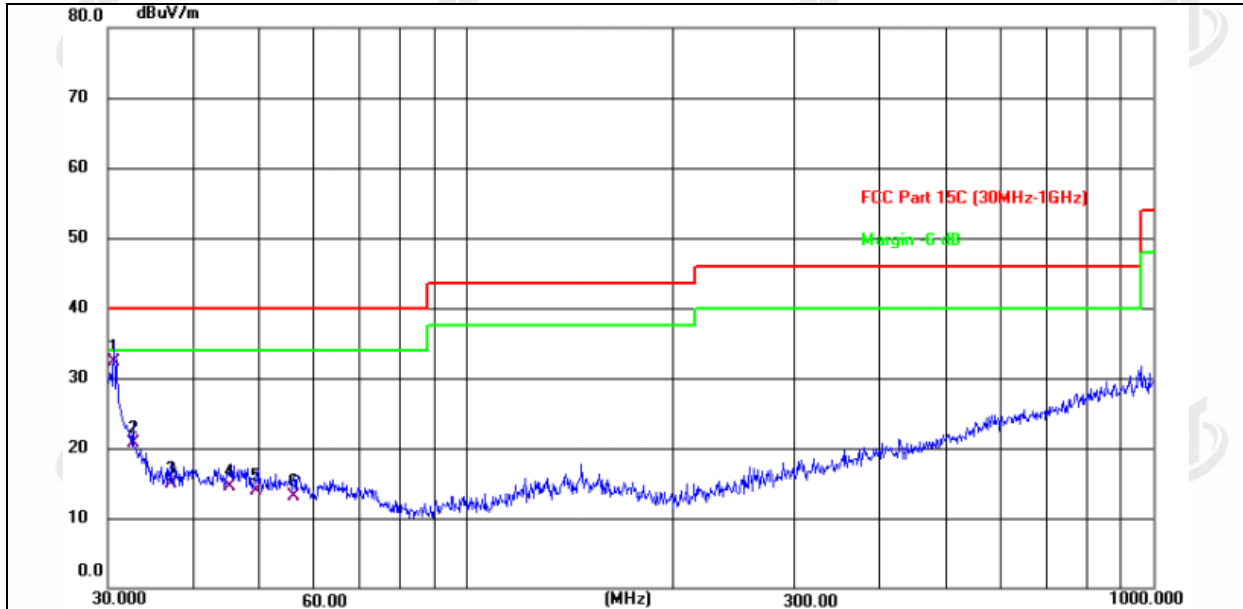

| No. | Frequency (MHz) | Reading (dBuV) | Factor (dB/m) | Level (dBuV/m) | Limit (dBuV/m) | Margin (dB) | Detector |
|-----|-----------------|----------------|---------------|----------------|----------------|-------------|----------|
| 1 * | 30.6378 | 42.02 | -9.65 | 32.37 | 40.00 | -7.63 | QP |
| 2 | 32.6340 | 30.06 | -9.35 | 20.71 | 40.00 | -19.29 | QP |
| 3 | 37.0250 | 23.70 | -8.73 | 14.97 | 40.00 | -25.03 | QP |
| 4 | 45.2166 | 23.13 | -8.58 | 14.55 | 40.00 | -25.45 | QP |
| 5 | 49.3594 | 22.81 | -8.81 | 14.00 | 40.00 | -26.00 | QP |
| 6 | 56.0007 | 22.68 | -9.49 | 13.19 | 40.00 | -26.81 | QP |



| | | | |
|---------------|---------|--------------------|----------|
| Temperature: | 25.6°C | Relative Humidity: | 47% |
| Pressure: | 101kPa | Polarization: | Vertical |
| Test Voltage: | DC 3.7V | | |

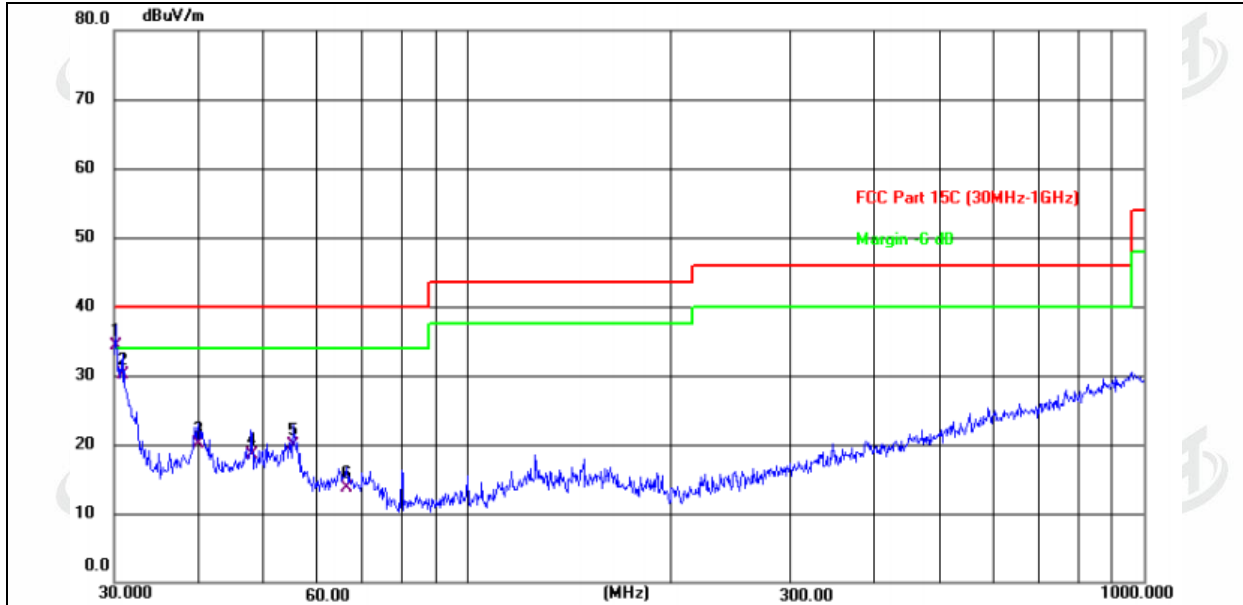

| No. | Frequency (MHz) | Reading (dBuV) | Factor (dB/m) | Level (dBuV/m) | Limit (dBuV/m) | Margin (dB) | Detector |
|-----|-----------------|----------------|---------------|----------------|----------------|-------------|----------|
| 1 * | 30.2111 | 43.98 | -9.72 | 34.26 | 40.00 | -5.74 | QP |
| 2 | 30.9618 | 39.66 | -9.61 | 30.05 | 40.00 | -9.95 | QP |
| 3 | 39.9942 | 28.48 | -8.29 | 20.19 | 40.00 | -19.81 | QP |
| 4 | 47.9940 | 27.33 | -8.73 | 18.60 | 40.00 | -21.40 | QP |
| 5 | 55.2207 | 29.29 | -9.41 | 19.88 | 40.00 | -20.12 | QP |
| 6 | 66.2661 | 24.30 | -10.62 | 13.68 | 40.00 | -26.32 | QP |

Remarks:

1. Final Level = Receiver Read level + Antenna Factor + Cable Loss – Pre-amplifier Factor
2. The emission levels of other frequencies are very lower than the limit and not show in test report.
3. The test data shows only the worst case Low Channel: 2402MHz)



1GHz~25GHz (Left earphone)

GFSK

| Polar (H/V) | Frequency (MHz) | Meter Reading (dBuV) | Pre-amplifier (dB) | Cable Loss (dB) | Antenna Factor (dB) | Emission Level (dBuV/m) | Limits (dBuV/m) | Margin (dB) | Detector Type |
|------------------------|-----------------|----------------------|--------------------|-----------------|---------------------|-------------------------|-----------------|-------------|---------------|
| Low Channel:2402MHz | | | | | | | | | |
| V | 4804 | 58.57 | 30.55 | 5.77 | 24.66 | 58.45 | 74 | -15.55 | Pk |
| V | 4804 | 43.56 | 30.55 | 5.77 | 24.66 | 43.44 | 54 | -10.56 | AV |
| V | 7206 | 55.6 | 30.33 | 6.32 | 24.55 | 56.14 | 74 | -17.86 | Pk |
| V | 7206 | 43.86 | 30.33 | 6.32 | 24.55 | 44.4 | 54 | -9.6 | AV |
| H | 4804 | 58.26 | 30.55 | 5.77 | 24.66 | 58.14 | 74 | -15.86 | Pk |
| H | 4804 | 41.8 | 30.55 | 5.77 | 24.66 | 41.68 | 54 | -12.32 | AV |
| H | 7206 | 56.09 | 30.33 | 6.32 | 24.55 | 56.63 | 74 | -17.37 | Pk |
| H | 7206 | 41.48 | 30.33 | 6.32 | 24.55 | 42.02 | 54 | -11.98 | AV |
| Middle Channel:2441MHz | | | | | | | | | |
| V | 4882 | 57.01 | 30.55 | 5.77 | 24.66 | 56.89 | 74 | -17.11 | Pk |
| V | 4882 | 41.3 | 30.55 | 5.77 | 24.66 | 41.18 | 54 | -12.82 | AV |
| V | 7323 | 57.45 | 30.33 | 6.32 | 24.55 | 57.99 | 74 | -16.01 | Pk |
| V | 7323 | 43.9 | 30.33 | 6.32 | 24.55 | 44.44 | 54 | -9.56 | AV |
| H | 4882 | 57.11 | 30.55 | 5.77 | 24.66 | 56.99 | 74 | -17.01 | Pk |
| H | 4882 | 41.05 | 30.55 | 5.77 | 24.66 | 40.93 | 54 | -13.07 | AV |
| H | 7323 | 57.25 | 30.33 | 6.32 | 24.55 | 57.79 | 74 | -16.21 | Pk |
| H | 7323 | 41.19 | 30.33 | 6.32 | 24.55 | 41.73 | 54 | -12.27 | AV |
| High Channel:2480MHz | | | | | | | | | |
| V | 4960 | 58.38 | 30.55 | 5.77 | 24.66 | 58.26 | 74 | -15.74 | Pk |
| V | 4960 | 41.37 | 30.55 | 5.77 | 24.66 | 41.25 | 54 | -12.75 | AV |
| V | 7440 | 56.11 | 30.33 | 6.32 | 24.55 | 56.65 | 74 | -17.35 | Pk |
| V | 7440 | 41.43 | 30.33 | 6.32 | 24.55 | 41.97 | 54 | -12.03 | AV |
| H | 4960 | 57.46 | 30.55 | 5.77 | 24.66 | 57.34 | 74 | -16.66 | Pk |
| H | 4960 | 43.66 | 30.55 | 5.77 | 24.66 | 43.54 | 54 | -10.46 | AV |
| H | 7440 | 55 | 30.33 | 6.32 | 24.55 | 55.54 | 74 | -18.46 | Pk |
| H | 7440 | 43.71 | 30.33 | 6.32 | 24.55 | 44.25 | 54 | -9.75 | AV |



$\pi/4$ DQPSK

| Polar (H/V) | Frequency | Meter Reading | Pre-amplifier | Cable Loss | Antenna Factor | Emission Level | Limits | Margin | Detector Type |
|------------------------|-----------|---------------|---------------|------------|----------------|----------------|----------|--------|---------------|
| | (MHz) | (dBuV) | (dB) | (dB) | (dB) | (dBuV/m) | (dBuV/m) | (dB) | |
| Low Channel:2402MHz | | | | | | | | | |
| V | 4804 | 57.21 | 30.55 | 5.77 | 24.66 | 57.09 | 74 | -16.91 | Pk |
| V | 4804 | 41.8 | 30.55 | 5.77 | 24.66 | 41.68 | 54 | -12.32 | AV |
| V | 7206 | 59.15 | 30.33 | 6.32 | 24.55 | 59.69 | 74 | -14.31 | Pk |
| V | 7206 | 41.19 | 30.33 | 6.32 | 24.55 | 41.73 | 54 | -12.27 | AV |
| H | 4804 | 57.31 | 30.55 | 5.77 | 24.66 | 57.19 | 74 | -16.81 | Pk |
| H | 4804 | 43.15 | 30.55 | 5.77 | 24.66 | 43.03 | 54 | -10.97 | AV |
| H | 7206 | 59.58 | 30.33 | 6.32 | 24.55 | 60.12 | 74 | -13.88 | Pk |
| H | 7206 | 43.49 | 30.33 | 6.32 | 24.55 | 44.03 | 54 | -9.97 | AV |
| Middle Channel:2441MHz | | | | | | | | | |
| V | 4882 | 59.19 | 30.55 | 5.77 | 24.66 | 59.07 | 74 | -14.93 | Pk |
| V | 4882 | 41.87 | 30.55 | 5.77 | 24.66 | 41.75 | 54 | -12.25 | AV |
| V | 7323 | 56.5 | 30.33 | 6.32 | 24.55 | 57.04 | 74 | -16.96 | Pk |
| V | 7323 | 44.88 | 30.33 | 6.32 | 24.55 | 45.42 | 54 | -8.58 | AV |
| H | 4882 | 58.6 | 30.55 | 5.77 | 24.66 | 58.48 | 74 | -15.52 | Pk |
| H | 4882 | 41.84 | 30.55 | 5.77 | 24.66 | 41.72 | 54 | -12.28 | AV |
| H | 7323 | 59.72 | 30.33 | 6.32 | 24.55 | 60.26 | 74 | -13.74 | Pk |
| H | 7323 | 41.87 | 30.33 | 6.32 | 24.55 | 42.41 | 54 | -11.59 | AV |
| High Channel:2480MHz | | | | | | | | | |
| V | 4960 | 57.06 | 30.55 | 5.77 | 24.66 | 56.94 | 74 | -17.06 | Pk |
| V | 4960 | 41.67 | 30.55 | 5.77 | 24.66 | 41.55 | 54 | -12.45 | AV |
| V | 7440 | 57.93 | 30.33 | 6.32 | 24.55 | 58.47 | 74 | -15.53 | Pk |
| V | 7440 | 41.55 | 30.33 | 6.32 | 24.55 | 42.09 | 54 | -11.91 | AV |
| H | 4960 | 58.41 | 30.55 | 5.77 | 24.66 | 58.29 | 74 | -15.71 | Pk |
| H | 4960 | 43.89 | 30.55 | 5.77 | 24.66 | 43.77 | 54 | -10.23 | AV |
| H | 7440 | 55.2 | 30.33 | 6.32 | 24.55 | 55.74 | 74 | -18.26 | Pk |
| H | 7440 | 44.15 | 30.33 | 6.32 | 24.55 | 44.69 | 54 | -9.31 | AV |



8DPSK

| Polar (H/V) | Frequency | Meter Reading | Pre-ampli fier | Cable Loss | Antenna Factor | Emission Level | Limits | Margin | Detector Type |
|------------------------|-----------|------------------|-------------------|---------------|-------------------|-------------------|----------|--------|------------------|
| | (MHz) | (dBuV) | (dB) | (dB) | (dB) | (dBuV/m) | (dBuV/m) | (dB) | |
| Low Channel:2402MHz | | | | | | | | | |
| V | 4804 | 57.48 | 30.55 | 5.77 | 24.66 | 57.36 | 74 | -16.64 | Pk |
| V | 4804 | 44.24 | 30.55 | 5.77 | 24.66 | 44.12 | 54 | -9.88 | AV |
| V | 7206 | 56.54 | 30.33 | 6.32 | 24.55 | 57.08 | 74 | -16.92 | Pk |
| V | 7206 | 42.73 | 30.33 | 6.32 | 24.55 | 43.27 | 54 | -10.73 | AV |
| H | 4804 | 59.05 | 30.55 | 5.77 | 24.66 | 58.93 | 74 | -15.07 | Pk |
| H | 4804 | 44.05 | 30.55 | 5.77 | 24.66 | 43.93 | 54 | -10.07 | AV |
| H | 7206 | 55.93 | 30.33 | 6.32 | 24.55 | 56.47 | 74 | -17.53 | Pk |
| H | 7206 | 42.2 | 30.33 | 6.32 | 24.55 | 42.74 | 54 | -11.26 | AV |
| Middle Channel:2441MHz | | | | | | | | | |
| V | 4882 | 58.21 | 30.55 | 5.77 | 24.66 | 58.09 | 74 | -15.91 | Pk |
| V | 4882 | 41.13 | 30.55 | 5.77 | 24.66 | 41.01 | 54 | -12.99 | AV |
| V | 7323 | 59.92 | 30.33 | 6.32 | 24.55 | 60.46 | 74 | -13.54 | Pk |
| V | 7323 | 43.39 | 30.33 | 6.32 | 24.55 | 43.93 | 54 | -10.07 | AV |
| H | 4882 | 58.18 | 30.55 | 5.77 | 24.66 | 58.06 | 74 | -15.94 | Pk |
| H | 4882 | 41.13 | 30.55 | 5.77 | 24.66 | 41.01 | 54 | -12.99 | AV |
| H | 7323 | 59.72 | 30.33 | 6.32 | 24.55 | 60.26 | 74 | -13.74 | Pk |
| H | 7323 | 41.88 | 30.33 | 6.32 | 24.55 | 42.42 | 54 | -11.58 | AV |
| High Channel:2480MHz | | | | | | | | | |
| V | 4960 | 56.34 | 30.55 | 5.77 | 24.66 | 56.22 | 74 | -17.78 | Pk |
| V | 4960 | 41.26 | 30.55 | 5.77 | 24.66 | 41.14 | 54 | -12.86 | AV |
| V | 7440 | 59.46 | 30.33 | 6.32 | 24.55 | 60 | 74 | -14 | Pk |
| V | 7440 | 42.71 | 30.33 | 6.32 | 24.55 | 43.25 | 54 | -10.75 | AV |
| H | 4960 | 59.63 | 30.55 | 5.77 | 24.66 | 59.51 | 74 | -14.49 | Pk |
| H | 4960 | 43.18 | 30.55 | 5.77 | 24.66 | 43.06 | 54 | -10.94 | AV |
| H | 7440 | 55.57 | 30.33 | 6.32 | 24.55 | 56.11 | 74 | -17.89 | Pk |
| H | 7440 | 43.48 | 30.33 | 6.32 | 24.55 | 44.02 | 54 | -9.98 | AV |

Remark:

1. Emission Level = Meter Reading + Antenna Factor + Cable Loss – Pre-amplifier,
Margin= Emission Level - Limit
2. If peak below the average limit, the average emission was no test.
3. The amplitude of spurious emissions which are attenuated by more than 20dB below the permissible value has no need to be reported.



1GHz~25GHz (Right earphone)

GFSK

| Polar (H/V) | Frequency | Meter Reading | Pre-amplifier | Cable Loss | Antenna Factor | Emission Level | Limits | Margin | Detector Type |
|------------------------|-----------|---------------|---------------|------------|----------------|----------------|----------|--------|---------------|
| | (MHz) | (dBuV) | (dB) | (dB) | (dB) | (dBuV/m) | (dBuV/m) | (dB) | |
| Low Channel:2402MHz | | | | | | | | | |
| V | 4804 | 56.47 | 30.55 | 5.77 | 24.66 | 56.35 | 74 | -17.65 | Pk |
| V | 4804 | 44.33 | 30.55 | 5.77 | 24.66 | 44.21 | 54 | -9.79 | AV |
| V | 7206 | 58.84 | 30.33 | 6.32 | 24.55 | 59.38 | 74 | -14.62 | Pk |
| V | 7206 | 41.6 | 30.33 | 6.32 | 24.55 | 42.14 | 54 | -11.86 | AV |
| H | 4804 | 59.57 | 30.55 | 5.77 | 24.66 | 59.45 | 74 | -14.55 | Pk |
| H | 4804 | 42.79 | 30.55 | 5.77 | 24.66 | 42.67 | 54 | -11.33 | AV |
| H | 7206 | 59.24 | 30.33 | 6.32 | 24.55 | 59.78 | 74 | -14.22 | Pk |
| H | 7206 | 42.25 | 30.33 | 6.32 | 24.55 | 42.79 | 54 | -11.21 | AV |
| Middle Channel:2441MHz | | | | | | | | | |
| V | 4882 | 57.12 | 30.55 | 5.77 | 24.66 | 57 | 74 | -17 | Pk |
| V | 4882 | 41.62 | 30.55 | 5.77 | 24.66 | 41.5 | 54 | -12.5 | AV |
| V | 7323 | 56.5 | 30.33 | 6.32 | 24.55 | 57.04 | 74 | -16.96 | Pk |
| V | 7323 | 44.23 | 30.33 | 6.32 | 24.55 | 44.77 | 54 | -9.23 | AV |
| H | 4882 | 58.7 | 30.55 | 5.77 | 24.66 | 58.58 | 74 | -15.42 | Pk |
| H | 4882 | 41.35 | 30.55 | 5.77 | 24.66 | 41.23 | 54 | -12.77 | AV |
| H | 7323 | 59.71 | 30.33 | 6.32 | 24.55 | 60.25 | 74 | -13.75 | Pk |
| H | 7323 | 41.72 | 30.33 | 6.32 | 24.55 | 42.26 | 54 | -11.74 | AV |
| High Channel:2480MHz | | | | | | | | | |
| V | 4960 | 59.82 | 30.55 | 5.77 | 24.66 | 59.7 | 74 | -14.3 | Pk |
| V | 4960 | 41.38 | 30.55 | 5.77 | 24.66 | 41.26 | 54 | -12.74 | AV |
| V | 7440 | 55.44 | 30.33 | 6.32 | 24.55 | 55.98 | 74 | -18.02 | Pk |
| V | 7440 | 44.24 | 30.33 | 6.32 | 24.55 | 44.78 | 54 | -9.22 | AV |
| H | 4960 | 58.05 | 30.55 | 5.77 | 24.66 | 57.93 | 74 | -16.07 | Pk |
| H | 4960 | 43.1 | 30.55 | 5.77 | 24.66 | 42.98 | 54 | -11.02 | AV |
| H | 7440 | 57.71 | 30.33 | 6.32 | 24.55 | 58.25 | 74 | -15.75 | Pk |
| H | 7440 | 44.94 | 30.33 | 6.32 | 24.55 | 45.48 | 54 | -8.52 | AV |



π/4DQPSK

| Polar (H/V) | Frequency | Meter Reading | Pre-amplifier | Cable Loss | Antenna Factor | Emission Level | Limits | Margin | Detector Type |
|------------------------|-----------|---------------|---------------|------------|----------------|----------------|----------|--------|---------------|
| | (MHz) | (dBuV) | (dB) | (dB) | (dB) | (dBuV/m) | (dBuV/m) | (dB) | |
| Low Channel:2402MHz | | | | | | | | | |
| V | 4804 | 56.04 | 30.55 | 5.77 | 24.66 | 55.92 | 74 | -18.08 | Pk |
| V | 4804 | 41.47 | 30.55 | 5.77 | 24.66 | 41.35 | 54 | -12.65 | AV |
| V | 7206 | 59.87 | 30.33 | 6.32 | 24.55 | 60.41 | 74 | -13.59 | Pk |
| V | 7206 | 42.2 | 30.33 | 6.32 | 24.55 | 42.74 | 54 | -11.26 | AV |
| H | 4804 | 59.73 | 30.55 | 5.77 | 24.66 | 59.61 | 74 | -14.39 | Pk |
| H | 4804 | 44.21 | 30.55 | 5.77 | 24.66 | 44.09 | 54 | -9.91 | AV |
| H | 7206 | 57.44 | 30.33 | 6.32 | 24.55 | 57.98 | 74 | -16.02 | Pk |
| H | 7206 | 44.97 | 30.33 | 6.32 | 24.55 | 45.51 | 54 | -8.49 | AV |
| Middle Channel:2441MHz | | | | | | | | | |
| V | 4882 | 56.04 | 30.55 | 5.77 | 24.66 | 55.92 | 74 | -18.08 | Pk |
| V | 4882 | 41.47 | 30.55 | 5.77 | 24.66 | 41.35 | 54 | -12.65 | AV |
| V | 7323 | 59.87 | 30.33 | 6.32 | 24.55 | 60.41 | 74 | -13.59 | Pk |
| V | 7323 | 42.2 | 30.33 | 6.32 | 24.55 | 42.74 | 54 | -11.26 | AV |
| H | 4882 | 59.73 | 30.55 | 5.77 | 24.66 | 59.61 | 74 | -14.39 | Pk |
| H | 4882 | 44.21 | 30.55 | 5.77 | 24.66 | 44.09 | 54 | -9.91 | AV |
| H | 7323 | 57.44 | 30.33 | 6.32 | 24.55 | 57.98 | 74 | -16.02 | Pk |
| H | 7323 | 44.97 | 30.33 | 6.32 | 24.55 | 45.51 | 54 | -8.49 | AV |
| High Channel:2480MHz | | | | | | | | | |
| V | 4960 | 56.65 | 30.55 | 5.77 | 24.66 | 56.53 | 74 | -17.47 | Pk |
| V | 4960 | 41.14 | 30.55 | 5.77 | 24.66 | 41.02 | 54 | -12.98 | AV |
| V | 7440 | 59.46 | 30.33 | 6.32 | 24.55 | 60 | 74 | -14 | Pk |
| V | 7440 | 42.95 | 30.33 | 6.32 | 24.55 | 43.49 | 54 | -10.51 | AV |
| H | 4960 | 59.01 | 30.55 | 5.77 | 24.66 | 58.89 | 74 | -15.11 | Pk |
| H | 4960 | 42.26 | 30.55 | 5.77 | 24.66 | 42.14 | 54 | -11.86 | AV |
| H | 7440 | 56.19 | 30.33 | 6.32 | 24.55 | 56.73 | 74 | -17.27 | Pk |
| H | 7440 | 41.47 | 30.33 | 6.32 | 24.55 | 42.01 | 54 | -11.99 | AV |



8DPSK

| Polar (H/V) | Frequency | Meter Reading | Pre-ampli fier | Cable Loss | Antenna Factor | Emission Level | Limits | Margin | Detector Type |
|------------------------|-----------|------------------|-------------------|---------------|-------------------|-------------------|----------|--------|------------------|
| | (MHz) | (dBuV) | (dB) | (dB) | (dB) | (dBuV/m) | (dBuV/m) | (dB) | |
| Low Channel:2402MHz | | | | | | | | | |
| V | 4804 | 58.86 | 30.55 | 5.77 | 24.66 | 58.74 | 74 | -15.26 | Pk |
| V | 4804 | 43.59 | 30.55 | 5.77 | 24.66 | 43.47 | 54 | -10.53 | AV |
| V | 7206 | 58.56 | 30.33 | 6.32 | 24.55 | 59.1 | 74 | -14.9 | Pk |
| V | 7206 | 41.56 | 30.33 | 6.32 | 24.55 | 42.1 | 54 | -11.9 | AV |
| H | 4804 | 57.67 | 30.55 | 5.77 | 24.66 | 57.55 | 74 | -16.45 | Pk |
| H | 4804 | 42.97 | 30.55 | 5.77 | 24.66 | 42.85 | 54 | -11.15 | AV |
| H | 7206 | 57.77 | 30.33 | 6.32 | 24.55 | 58.31 | 74 | -15.69 | Pk |
| H | 7206 | 41.75 | 30.33 | 6.32 | 24.55 | 42.29 | 54 | -11.71 | AV |
| Middle Channel:2441MHz | | | | | | | | | |
| V | 4882 | 57.96 | 30.55 | 5.77 | 24.66 | 57.84 | 74 | -16.16 | Pk |
| V | 4882 | 41.49 | 30.55 | 5.77 | 24.66 | 41.37 | 54 | -12.63 | AV |
| V | 7323 | 59.68 | 30.33 | 6.32 | 24.55 | 60.22 | 74 | -13.78 | Pk |
| V | 7323 | 41.65 | 30.33 | 6.32 | 24.55 | 42.19 | 54 | -11.81 | AV |
| H | 4882 | 57.48 | 30.55 | 5.77 | 24.66 | 57.36 | 74 | -16.64 | Pk |
| H | 4882 | 41.87 | 30.55 | 5.77 | 24.66 | 41.75 | 54 | -12.25 | AV |
| H | 7323 | 57.91 | 30.33 | 6.32 | 24.55 | 58.45 | 74 | -15.55 | Pk |
| H | 7323 | 41.27 | 30.33 | 6.32 | 24.55 | 41.81 | 54 | -12.19 | AV |
| High Channel:2480MHz | | | | | | | | | |
| V | 4960 | 55.2 | 30.55 | 5.77 | 24.66 | 55.08 | 74 | -18.92 | Pk |
| V | 4960 | 41.58 | 30.55 | 5.77 | 24.66 | 41.46 | 54 | -12.54 | AV |
| V | 7440 | 58.87 | 30.33 | 6.32 | 24.55 | 59.41 | 74 | -14.59 | Pk |
| V | 7440 | 41.2 | 30.33 | 6.32 | 24.55 | 41.74 | 54 | -12.26 | AV |
| H | 4960 | 57.76 | 30.55 | 5.77 | 24.66 | 57.64 | 74 | -16.36 | Pk |
| H | 4960 | 41.72 | 30.55 | 5.77 | 24.66 | 41.6 | 54 | -12.4 | AV |
| H | 7440 | 56.48 | 30.33 | 6.32 | 24.55 | 57.02 | 74 | -16.98 | Pk |
| H | 7440 | 44.17 | 30.33 | 6.32 | 24.55 | 44.71 | 54 | -9.29 | AV |

Remark:

1. Emission Level = Meter Reading + Antenna Factor + Cable Loss – Pre-amplifier,
Margin= Emission Level - Limit
2. If peak below the average limit, the average emission was no test.
3. The amplitude of spurious emissions which are attenuated by more than 20dB below the permissible value has no need to be reported.

5. RADIATED BAND EMISSION MEASUREMENT

5.1 Test Requirement:

| | | | | | |
|-----------------------|--|----------|------|------|---------|
| Test Requirement: | FCC Part15 C Section 15.209 and 15.205 | | | | |
| Test Method: | ANSI C63.10: 2013 | | | | |
| Test Frequency Range: | All of the restrict bands were tested, only the worst band's (2310MHz to 2500MHz) data was showed. | | | | |
| Test site: | Measurement Distance: 3m | | | | |
| Receiver setup: | Frequency | Detector | RBW | VBW | Value |
| | Above 1GHz | Peak | 1MHz | 3MHz | Peak |
| | | Average | 1MHz | 3MHz | Average |

LIMITS OF RADIATED EMISSION MEASUREMENT (Above 1000MHz)

| FREQUENCY (MHz) | Limit (dBuV/m) (at 3M) | |
|-----------------|------------------------|---------|
| | PEAK | AVERAGE |
| Above 1000 | 74 | 54 |

Notes:

- (1) The limit for radiated test was performed according to FCC PART 15C.
- (2) The tighter limit applies at the band edges.
- (3) Emission level (dBuV/m)=20log Emission level (uV/m).

| Spectrum Parameter | Setting |
|---------------------------------------|--|
| Attenuation | Auto |
| Start Frequency | 2300MHz |
| Stop Frequency | 2520 |
| RB / VB (emission in restricted band) | 1 MHz / 1 MHz for Peak, 1 MHz / 10Hz for Average |

5.2 TEST PROCEDURE

Above 1GHz test procedure as below:

- a. 1. The EUT was placed on the top of a rotating table 1.5 meters above the ground at a 3 meter camber. The table was rotated 360 degrees to determine the position of the highest radiation.
- b. The EUT was set 3 meters away from the interference-receiving antenna, which was mounted on the top of a variable-height antenna tower.
- c. The antenna height is varied from one meter to four meters above the ground to determine the maximum value of the field strength. Both horizontal and vertical polarizations of the antenna are set to make the measurement.
- d. For each suspected emission, the EUT was arranged to its worst case and then the antenna was tuned to heights from 1 meter to 4 meters and the rota table was turned from 0 degrees to 360 degrees to find the maximum reading.
- e. The test-receiver system was set to Peak Detect Function and Specified Bandwidth with Maximum Hold Mode.
- f. If the emission level of the EUT in peak mode was 10dB lower than the limit specified, then testing could be stopped and the peak values of the EUT would be reported. Otherwise the emissions that did not have 10dB margin would be re-tested one by one using peak, quasi-peak or average method as specified and then reported in a data sheet.
- g. Test the EUT in the lowest channel,the Highest channel

Note:

Both horizontal and vertical antenna polarities were tested and performed pretest to three orthogonal axis. The worst case emissions were reported

5.3 DEVIATION FROM TEST STANDARD

No deviation

5.4 TEST SETUP

Radiated Emission Test-Up Frequency Above 1GHz

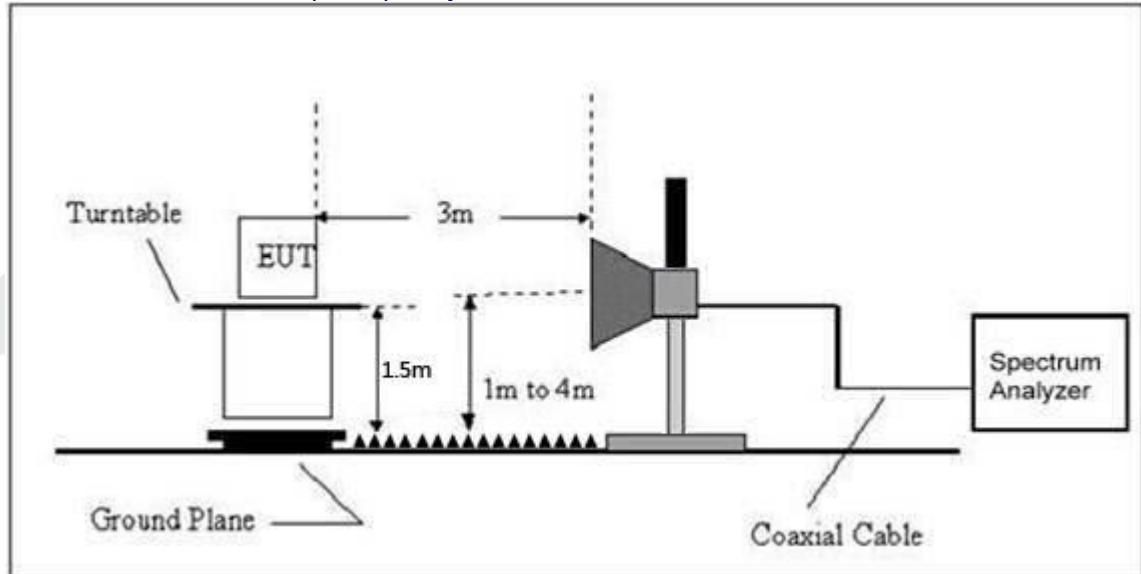

5.5 EUT OPERATING CONDITIONS

The EUT tested system was configured as the statements of 2.3 Unless otherwise a special operating condition is specified in the follows during the testing.



5.6 TEST RESULT

| Left earphone | | | | | | | | | | | |
|---------------|-----------------------|-----------------|----------------------|--------------------|-----------------|-----------------------|-------------------------|----------------|-------------|---------------|--------|
| | Polar (H/V) | Frequency (MHz) | Meter Reading (dBuV) | Pre-amplifier (dB) | Cable Loss (dB) | Antenna Factor (dB/m) | Emission level (dBuV/m) | Limit (dBuV/m) | Margin (dB) | Detector Type | Result |
| GFSK | Low Channel: 2402MHz | | | | | | | | | | |
| | H | 2390.00 | 62.23 | 30.22 | 4.85 | 23.98 | 60.84 | 74.00 | -13.16 | Pk | PASS |
| | H | 2390.00 | 48.93 | 30.22 | 4.85 | 23.98 | 47.54 | 54.00 | -6.46 | AV | PASS |
| | H | 2400.00 | 61.43 | 30.22 | 4.85 | 23.98 | 60.04 | 74.00 | -13.96 | Pk | PASS |
| | H | 2400.00 | 47.85 | 30.22 | 4.85 | 23.98 | 46.46 | 54.00 | -7.54 | AV | PASS |
| | V | 2390.00 | 61.63 | 30.22 | 4.85 | 23.98 | 60.24 | 74.00 | -13.76 | Pk | PASS |
| | V | 2390.00 | 46.11 | 30.22 | 4.85 | 23.98 | 44.72 | 54.00 | -9.28 | AV | PASS |
| | V | 2400.00 | 59.19 | 30.22 | 4.85 | 23.98 | 57.80 | 74.00 | -16.20 | Pk | PASS |
| | V | 2400.00 | 47.71 | 30.22 | 4.85 | 23.98 | 46.32 | 54.00 | -7.68 | AV | PASS |
| | High Channel: 2480MHz | | | | | | | | | | |
| | H | 2483.50 | 62.64 | 30.22 | 4.85 | 23.98 | 61.25 | 74.00 | -12.75 | PK | PASS |
| | H | 2483.50 | 48.72 | 30.22 | 4.85 | 23.98 | 47.33 | 54.00 | -6.67 | AV | PASS |
| | H | 2500.00 | 60.70 | 30.22 | 4.85 | 23.98 | 59.31 | 74.00 | -14.69 | PK | PASS |
| | H | 2500.00 | 46.54 | 30.22 | 4.85 | 23.98 | 45.15 | 54.00 | -8.85 | AV | PASS |
| | V | 2483.50 | 62.09 | 30.22 | 4.85 | 23.98 | 60.70 | 74.00 | -13.30 | PK | PASS |
| | V | 2483.50 | 48.84 | 30.22 | 4.85 | 23.98 | 47.45 | 54.00 | -6.55 | AV | PASS |
| V | 2500.00 | 62.05 | 30.22 | 4.85 | 23.98 | 60.66 | 74.00 | -13.34 | PK | PASS | |
| V | 2500.00 | 47.96 | 30.22 | 4.85 | 23.98 | 46.57 | 54.00 | -7.43 | AV | PASS | |
| π/4DQPSK | Low Channel: 2402MHz | | | | | | | | | | |
| | H | 2390.00 | 62.47 | 30.22 | 4.85 | 23.98 | 61.08 | 74.00 | -12.92 | PK | PASS |
| | H | 2390.00 | 47.72 | 30.22 | 4.85 | 23.98 | 46.33 | 54.00 | -7.67 | AV | PASS |
| | H | 2400.00 | 62.05 | 30.22 | 4.85 | 23.98 | 60.66 | 74.00 | -13.34 | PK | PASS |
| | H | 2400.00 | 48.74 | 30.22 | 4.85 | 23.98 | 47.35 | 54.00 | -6.65 | AV | PASS |
| | V | 2390.00 | 61.47 | 30.22 | 4.85 | 23.98 | 60.08 | 74.00 | -13.92 | PK | PASS |
| | V | 2390.00 | 47.47 | 30.22 | 4.85 | 23.98 | 46.08 | 54.00 | -7.92 | AV | PASS |
| | V | 2400.00 | 61.50 | 30.22 | 4.85 | 23.98 | 60.11 | 74.00 | -13.89 | PK | PASS |
| | V | 2400.00 | 46.52 | 30.22 | 4.85 | 23.98 | 45.13 | 54.00 | -8.87 | AV | PASS |
| | High Channel: 2480MHz | | | | | | | | | | |
| | H | 2483.50 | 60.94 | 30.22 | 4.85 | 23.98 | 59.55 | 74.00 | -14.45 | PK | PASS |
| | H | 2483.50 | 48.78 | 30.22 | 4.85 | 23.98 | 47.39 | 54.00 | -6.61 | AV | PASS |
| | H | 2500.00 | 62.05 | 30.22 | 4.85 | 23.98 | 60.66 | 74.00 | -13.34 | PK | PASS |
| | H | 2500.00 | 46.76 | 30.22 | 4.85 | 23.98 | 45.37 | 54.00 | -8.63 | AV | PASS |
| | V | 2483.50 | 59.80 | 30.22 | 4.85 | 23.98 | 58.41 | 74.00 | -15.59 | PK | PASS |
| | V | 2483.50 | 47.70 | 30.22 | 4.85 | 23.98 | 46.31 | 54.00 | -7.69 | AV | PASS |
| V | 2500.00 | 59.77 | 30.22 | 4.85 | 23.98 | 58.38 | 74.00 | -15.62 | PK | PASS | |
| V | 2500.00 | 47.55 | 30.22 | 4.85 | 23.98 | 46.16 | 54.00 | -7.84 | AV | PASS | |
| 8DPSK | Low Channel: 2402MHz | | | | | | | | | | |
| | H | 2390.00 | 62.44 | 30.22 | 4.85 | 23.98 | 61.05 | 74.00 | -12.95 | PK | PASS |
| | H | 2390.00 | 48.40 | 30.22 | 4.85 | 23.98 | 47.01 | 54.00 | -6.99 | AV | PASS |
| | H | 2400.00 | 62.81 | 30.22 | 4.85 | 23.98 | 61.42 | 74.00 | -12.58 | PK | PASS |
| | H | 2400.00 | 46.35 | 30.22 | 4.85 | 23.98 | 44.96 | 54.00 | -9.04 | AV | PASS |
| | V | 2390.00 | 59.44 | 30.22 | 4.85 | 23.98 | 58.05 | 74.00 | -15.95 | PK | PASS |
| | V | 2390.00 | 47.69 | 30.22 | 4.85 | 23.98 | 46.30 | 54.00 | -7.70 | AV | PASS |
| | V | 2400.00 | 61.11 | 30.22 | 4.85 | 23.98 | 59.72 | 74.00 | -14.28 | PK | PASS |
| | V | 2400.00 | 48.92 | 30.22 | 4.85 | 23.98 | 47.53 | 54.00 | -6.47 | AV | PASS |
| | High Channel: 2480MHz | | | | | | | | | | |
| | H | 2483.50 | 62.67 | 30.22 | 4.85 | 23.98 | 61.28 | 74.00 | -13.45 | PK | PASS |
| | H | 2483.50 | 46.40 | 30.22 | 4.85 | 23.98 | 45.01 | 54.00 | -6.95 | AV | PASS |
| H | 2500.00 | 59.90 | 30.22 | 4.85 | 23.98 | 58.51 | 74.00 | -14.81 | PK | PASS | |



| | | | | | | | | | | | |
|----------|---|---------|-------|-------|------|-------|-------|-------|--------|----|------|
| ZHONGHAN | H | 2500.00 | 46.44 | 30.22 | 4.85 | 23.98 | 45.05 | 54.00 | -7.46 | AV | PASS |
| | V | 2483.50 | 60.44 | 30.22 | 4.85 | 23.98 | 59.05 | 74.00 | -15.30 | PK | PASS |
| | V | 2483.50 | 47.05 | 30.22 | 4.85 | 23.98 | 45.66 | 54.00 | -6.94 | AV | PASS |
| | V | 2500.00 | 62.19 | 30.22 | 4.85 | 23.98 | 60.80 | 74.00 | -15.73 | PK | PASS |
| | V | 2500.00 | 47.75 | 30.22 | 4.85 | 23.98 | 46.36 | 54.00 | -8.73 | AV | PASS |

Remark:

1. Emission Level = Meter Reading + Antenna Factor + Cable Loss – Pre-amplifier, Margin= Emission Level - Limit

| Right earphone | | | | | | | | | | | |
|----------------|-----------------------|-----------------|----------------------|--------------------|-----------------|-----------------------|-------------------------|----------------|-------------|---------------|--------|
| | Polar (H/V) | Frequency (MHz) | Meter Reading (dBuV) | Pre-amplifier (dB) | Cable Loss (dB) | Antenna Factor (dB/m) | Emission level (dBuV/m) | Limit (dBuV/m) | Margin (dB) | Detector Type | Result |
| GFSK | Low Channel: 2402MHz | | | | | | | | | | |
| | H | 2390.00 | 62.79 | 30.22 | 4.85 | 23.98 | 61.40 | 74.00 | -12.60 | Pk | PASS |
| | H | 2390.00 | 46.39 | 30.22 | 4.85 | 23.98 | 45.00 | 54.00 | -9.00 | AV | PASS |
| | H | 2400.00 | 62.28 | 30.22 | 4.85 | 23.98 | 60.89 | 74.00 | -13.11 | Pk | PASS |
| | H | 2400.00 | 47.90 | 30.22 | 4.85 | 23.98 | 46.51 | 54.00 | -7.49 | AV | PASS |
| | V | 2390.00 | 61.19 | 30.22 | 4.85 | 23.98 | 59.80 | 74.00 | -14.20 | Pk | PASS |
| | V | 2390.00 | 48.57 | 30.22 | 4.85 | 23.98 | 47.18 | 54.00 | -6.82 | AV | PASS |
| | V | 2400.00 | 60.71 | 30.22 | 4.85 | 23.98 | 59.32 | 74.00 | -14.68 | Pk | PASS |
| | V | 2400.00 | 47.08 | 30.22 | 4.85 | 23.98 | 45.69 | 54.00 | -8.31 | AV | PASS |
| | High Channel: 2480MHz | | | | | | | | | | |
| | H | 2483.50 | 59.02 | 30.22 | 4.85 | 23.98 | 57.63 | 74.00 | -16.37 | PK | PASS |
| | H | 2483.50 | 47.53 | 30.22 | 4.85 | 23.98 | 46.14 | 54.00 | -7.86 | AV | PASS |
| | H | 2500.00 | 61.11 | 30.22 | 4.85 | 23.98 | 59.72 | 74.00 | -14.28 | PK | PASS |
| | H | 2500.00 | 47.88 | 30.22 | 4.85 | 23.98 | 46.49 | 54.00 | -7.51 | AV | PASS |
| | V | 2483.50 | 60.26 | 30.22 | 4.85 | 23.98 | 58.87 | 74.00 | -15.13 | PK | PASS |
| | V | 2483.50 | 48.43 | 30.22 | 4.85 | 23.98 | 47.04 | 54.00 | -6.96 | AV | PASS |
| V | 2500.00 | 60.06 | 30.22 | 4.85 | 23.98 | 58.67 | 74.00 | -15.33 | PK | PASS | |
| V | 2500.00 | 48.02 | 30.22 | 4.85 | 23.98 | 46.63 | 54.00 | -7.37 | AV | PASS | |



| Low Channel: 2402MHz | | | | | | | | | | | | |
|---|-----------------------|---------|-------|-------|-------|-------|-------|--------|--------|------|------|--|
| π/4DQPS K | H | 2390.00 | 62.51 | 30.22 | 4.85 | 23.98 | 61.12 | 74.00 | -12.88 | PK | PASS | |
| | H | 2390.00 | 46.16 | 30.22 | 4.85 | 23.98 | 44.77 | 54.00 | -9.23 | AV | PASS | |
| | H | 2400.00 | 60.46 | 30.22 | 4.85 | 23.98 | 59.07 | 74.00 | -14.93 | PK | PASS | |
| | H | 2400.00 | 47.59 | 30.22 | 4.85 | 23.98 | 46.20 | 54.00 | -7.80 | AV | PASS | |
| | V | 2390.00 | 60.65 | 30.22 | 4.85 | 23.98 | 59.26 | 74.00 | -14.74 | PK | PASS | |
| | V | 2390.00 | 47.48 | 30.22 | 4.85 | 23.98 | 46.09 | 54.00 | -7.91 | AV | PASS | |
| | V | 2400.00 | 60.85 | 30.22 | 4.85 | 23.98 | 59.46 | 74.00 | -14.54 | PK | PASS | |
| | V | 2400.00 | 48.54 | 30.22 | 4.85 | 23.98 | 47.15 | 54.00 | -6.85 | AV | PASS | |
| | High Channel: 2480MHz | | | | | | | | | | | |
| | H | 2483.50 | 60.88 | 30.22 | 4.85 | 23.98 | 59.49 | 74.00 | -14.51 | PK | PASS | |
| | H | 2483.50 | 48.01 | 30.22 | 4.85 | 23.98 | 46.62 | 54.00 | -7.38 | AV | PASS | |
| | H | 2500.00 | 60.69 | 30.22 | 4.85 | 23.98 | 59.30 | 74.00 | -14.70 | PK | PASS | |
| | H | 2500.00 | 46.37 | 30.22 | 4.85 | 23.98 | 44.98 | 54.00 | -9.02 | AV | PASS | |
| | V | 2483.50 | 59.48 | 30.22 | 4.85 | 23.98 | 58.09 | 74.00 | -15.91 | PK | PASS | |
| | V | 2483.50 | 46.08 | 30.22 | 4.85 | 23.98 | 44.69 | 54.00 | -9.31 | AV | PASS | |
| | V | 2500.00 | 61.71 | 30.22 | 4.85 | 23.98 | 60.32 | 74.00 | -13.68 | PK | PASS | |
| V | 2500.00 | 48.61 | 30.22 | 4.85 | 23.98 | 47.22 | 54.00 | -6.78 | AV | PASS | | |
| 8DPSK | Low Channel: 2402MHz | | | | | | | | | | | |
| | H | 2390.00 | 60.84 | 30.22 | 4.85 | 23.98 | 59.45 | 74.00 | -14.55 | PK | PASS | |
| | H | 2390.00 | 48.34 | 30.22 | 4.85 | 23.98 | 46.95 | 54.00 | -7.05 | AV | PASS | |
| | H | 2400.00 | 62.32 | 30.22 | 4.85 | 23.98 | 60.93 | 74.00 | -13.07 | PK | PASS | |
| | H | 2400.00 | 47.72 | 30.22 | 4.85 | 23.98 | 46.33 | 54.00 | -7.67 | AV | PASS | |
| | V | 2390.00 | 59.65 | 30.22 | 4.85 | 23.98 | 58.26 | 74.00 | -15.74 | PK | PASS | |
| | V | 2390.00 | 47.33 | 30.22 | 4.85 | 23.98 | 45.94 | 54.00 | -8.06 | AV | PASS | |
| | V | 2400.00 | 59.37 | 30.22 | 4.85 | 23.98 | 57.98 | 74.00 | -16.02 | PK | PASS | |
| | V | 2400.00 | 47.59 | 30.22 | 4.85 | 23.98 | 46.20 | 54.00 | -7.80 | AV | PASS | |
| | High Channel: 2480MHz | | | | | | | | | | | |
| | H | 2483.50 | 60.62 | 30.22 | 4.85 | 23.98 | 59.23 | 74.00 | -14.77 | PK | PASS | |
| | H | 2483.50 | 47.65 | 30.22 | 4.85 | 23.98 | 46.26 | 54.00 | -7.74 | AV | PASS | |
| | H | 2500.00 | 62.28 | 30.22 | 4.85 | 23.98 | 60.89 | 74.00 | -13.11 | PK | PASS | |
| | H | 2500.00 | 48.20 | 30.22 | 4.85 | 23.98 | 46.81 | 54.00 | -7.19 | AV | PASS | |
| | V | 2483.50 | 62.02 | 30.22 | 4.85 | 23.98 | 60.63 | 74.00 | -13.37 | PK | PASS | |
| | V | 2483.50 | 48.03 | 30.22 | 4.85 | 23.98 | 46.64 | 54.00 | -7.36 | AV | PASS | |
| V | 2500.00 | 61.30 | 30.22 | 4.85 | 23.98 | 59.91 | 74.00 | -14.09 | PK | PASS | | |
| V | 2500.00 | 46.75 | 30.22 | 4.85 | 23.98 | 45.36 | 54.00 | -8.64 | AV | PASS | | |
| Remark: | | | | | | | | | | | | |
| 1. Emission Level = Meter Reading + Antenna Factor + Cable Loss – Pre-amplifier, Margin= Emission Level - Limit | | | | | | | | | | | | |



6. CONDUCTED BAND EDGE AND SPURIOUS EMISSION

| | |
|-------------------|---|
| Test Requirement: | FCC Part15 C Section 15.247 (d) |
| Test Method: | KDB558074 D0115.247 Meas Guidancev05r02 |

6.1 Limit

Regulation 15.247 (d), In any 100 kHz bandwidth outside the frequency band in which the spread spectrum or digitally modulated intentional radiator is operating, the radio frequency power that is produced by the intentional radiator shall be at least 20 dB below that in the 100 kHz bandwidth within the band that contains the highest level of the desired power, based on either an RF conducted or a radiated measurement, provided the transmitter demonstrates compliance with the peak conducted power limits. If the transmitter complies with the conducted power limits based on the use of RMS averaging over a time interval, as permitted under paragraph (b)(3) of this section, the attenuation required under this paragraph shall be 30 dB instead of 20 dB. Attenuation below the general limits specified in §15.209(a) is not required. In addition, radiated emissions which fall in the restricted bands, as defined in §15.205(a), must also comply with the radiated emission limits specified in §15.209(a) (see §15.205(c)).

6.2 Test Setup

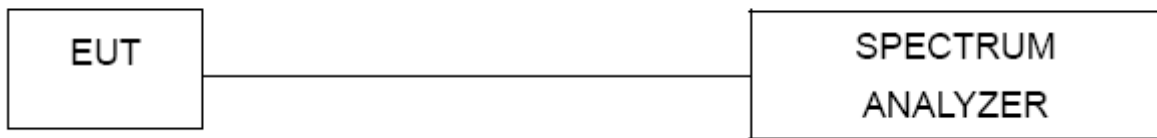

6.3 Test procedure

Using the following spectrum analyzer setting:

- A) Set the RBW = 100KHz.
- B) Set the VBW = 300KHz.
- C) Sweep time = auto couple.
- D) Detector function = peak.
- E) Trace mode = max hold.
- F) Allow trace to fully stabilize.

6.4 DEVIATION FROM STANDARD

No deviation.

6.5 Test Result

Please refer to the Appendix BT



7. 20DB BANDWIDTH

| | |
|-------------------|------------------------------------|
| Test Requirement: | FCC Part15 C Section 15.247 (a)(1) |
| Test Method: | ANSI C63.10:2013 |

7.1 Test Setup



7.2 Limit
N/A

7.3 Test procedure

1. Set RBW = 30 kHz.
2. Set the video bandwidth (VBW) $\geq 3 \times$ RBW.
3. Detector = Peak.
4. Trace mode = max hold.
5. Sweep = auto couple.
6. Allow the trace to stabilize.
7. Measure the maximum width of the emission that is constrained by the frequencies associated with the two outermost amplitude points (upper and lower frequencies) that are attenuated by 6 dB relative to the maximum level measured in the fundamental emission.

7.4 DEVIATION FROM STANDARD

No deviation.

7.5 Test Result

Please refer to the Appendix BT



8. Maximum Peak Output Power

| | |
|-------------------|------------------------------------|
| Test Requirement: | FCC Part15 C Section 15.247 (b)(1) |
| Test Method: | ANSI C63.10:2013 |

8.1 Block Diagram Of Test Setup

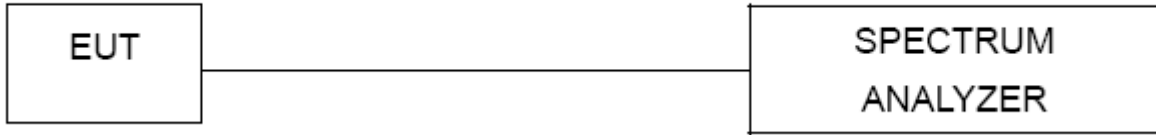

8.2 Limit

For frequency hopping systems operating in the 2400-2483.5 MHz band employing at least 75 non-overlapping hopping channels, and all frequency hopping systems in the 5725-5850 MHz band: 1 watt. For all other frequency hopping systems in the 2400-2483.5 MHz band: 0.125 watts.

For FHSs operating in the band 2400-2483.5 MHz, the maximum peak conducted output power shall not exceed 1.0 W if the hopset uses 75 or more hopping channels; the maximum peak conducted output power shall not exceed 0.125 W if the hopset uses less than 75 hopping channels. The e.i.r.p. shall not exceed 4 W.

8.3 Test procedure

The EUT was directly connected to the SPECTRUMANALYZER

8.4 DEVIATION FROM STANDARD

No deviation.

8.5 Test Result

Please refer to the Appendix BT



9. HOPPING CHANNEL SEPARATION

| | |
|-------------------|--|
| Test Requirement: | FCC Part15 C Section 15.247 (a)(1) |
| Test Method: | ANSI C63.10:2013 |
| Receiver setup: | RBW=30KHz, VBW=100KHz, detector=Peak |
| Limit: | 0.025MHz or 2/3 of the 20dB bandwidth (whichever is greater) |

9.1 Test Setup

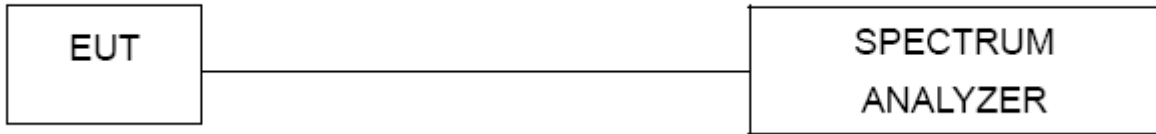

9.2 Test procedure

1. Remove the antenna from the EUT and then connect a low RF cable from the antenna port to the spectrum.
2. Set the spectrum analyzer: RBW = 30kHz. VBW = 100kHz , Span = 2.0MHz. Sweep = auto; Detector Function = Peak. Trace = Max hold.
3. Allow the trace to stabilize. Use the marker-delta function to determine the separation between the peaks of the adjacent channels. The limit is specified in one of the subparagraphs of this Section Submit this plot.

9.3 DEVIATION FROM STANDARD

No deviation.

9.4 Test Result

Please refer to the Appendix BT



10. NUMBER OF HOPPING FREQUENCY

| | |
|-------------------|--|
| Test Requirement: | FCC Part15 C Section 15.247 (a)(1)(iii) |
| Test Method: | ANSI C63.10:2013 |
| Receiver setup: | RBW=100kHz, VBW=300kHz, Frequency range=2400MHz-2483.5MHz, Detector=Peak |
| Limit: | 15 channels |

10.1 Test Setup



10.2 Test procedure

1. Remove the antenna from the EUT and then connect a low RF cable from the antenna port to the spectrum.
2. Set the spectrum analyzer: RBW = 100kHz. VBW = 300kHz. Sweep = auto; Detector Function = Peak. Trace = Max hold.
3. Allow the trace to stabilize. It may prove necessary to break the span up to sections. in order to clearly show all of the hopping frequencies. The limit is specified in one of the subparagraphs of this Section.
4. Set the spectrum analyzer: Start Frequency = 2.4GHz, Stop Frequency = 2.4835GHz. Sweep=auto;

10.3 DEVIATION FROM STANDARD

No deviation.

10.4 Test Result

Please refer to the Appendix BT



11. DWELL TIME

| | |
|-------------------|---|
| Test Requirement: | FCC Part15 C Section 15.247 (a)(1)(iii) |
| Test Method: | ANSI C63.10:2013 |
| Receiver setup: | RBW=1MHz, VBW=3MHz, Span=0Hz, Detector=Peak |
| Limit: | 0.4 Second |

11.1 Test Setup

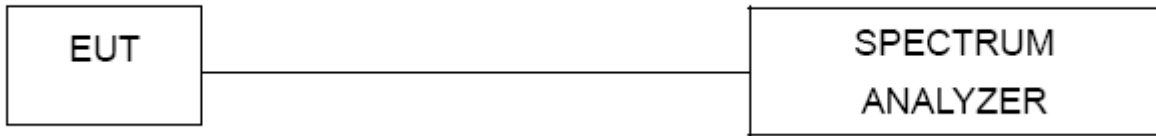

11.2 Test procedure

1. Remove the antenna from the EUT and then connect a low RF cable from the antenna port to the spectrum.
2. Set spectrum analyzer span = 0Hz;
3. Set RBW = 1MHz and VBW = 3MHz. Sweep = as necessary to capture the entire dwell time per hopping channel. Set the EUT for DH5, DH3 and DH1 packet transmitting.
4. Use the marker-delta function to determine the dwell time. If this value varies with different modes of operation (e.g.. data rate. modulation format. etc.). repeat this test for each variation. The limit is specified in one of the subparagraphs of this Section. Submit this plot(s).

11.3 DEVIATION FROM STANDARD

No deviation.

11.4 Test Result

Please refer to the Appendix BT



12. ANTENNA REQUIREMENT

| | |
|--|--|
| Standard requirement: | FCC Part15 C Section 15.203 /247(b)(4) |
| 15.203 requirement: An intentional radiator shall be designed to ensure that no antenna other than that furnished by the responsible party shall be used with the device. The use of a permanently attached antenna or of an antenna that uses a unique coupling to the intentional radiator, the manufacturer may design the unit so that a broken antenna can be replaced by the user, but the use of a standard antenna jack or electrical connector is prohibited. | |
| 15.247(b) (4) requirement: (4) The conducted output power limit specified in paragraph (b) of this section is based on the use of antennas with directional gains that do not exceed 6 dBi. Except as shown in paragraph (c) of this section, if transmitting antennas of directional gain greater than 6 dBi are used, the conducted output power from the intentional radiator shall be reduced below the stated values in paragraphs (b)(1), (b)(2), and (b)(3) of this section, as appropriate, by the amount in dB that the directional gain of the antenna exceeds 6 dBi. | |
| EUT Antenna: | |
| The antenna is Chip antenna, the best case gain of the antenna is 2.7dBi, reference to the appendix II for details | |



13.APPENDIX BT

13.1 Dwell Time

| Mode | Frequency (MHz) | Pulse Time (ms) | Total Dwell Time (ms) | Burst Count | Period Time (ms) | Limit (ms) | Verdict |
|-------|-----------------|-----------------|-----------------------|-------------|------------------|------------|---------|
| 1-DH1 | 2441 | 0.401 | 127.919 | 319 | 31600 | 400 | Pass |
| 1-DH3 | 2441 | 1.657 | 246.893 | 149 | 31600 | 400 | Pass |
| 1-DH5 | 2441 | 2.904 | 333.96 | 115 | 31600 | 400 | Pass |
| 2-DH1 | 2441 | 0.411 | 130.698 | 318 | 31600 | 400 | Pass |
| 2-DH3 | 2441 | 1.662 | 267.582 | 161 | 31600 | 400 | Pass |
| 2-DH5 | 2441 | 2.889 | 338.013 | 117 | 31600 | 400 | Pass |
| 3-DH1 | 2441 | 0.411 | 130.287 | 317 | 31600 | 400 | Pass |
| 3-DH3 | 2441 | 1.662 | 259.272 | 156 | 31600 | 400 | Pass |
| 3-DH5 | 2441 | 2.912 | 256.256 | 88 | 31600 | 400 | Pass |

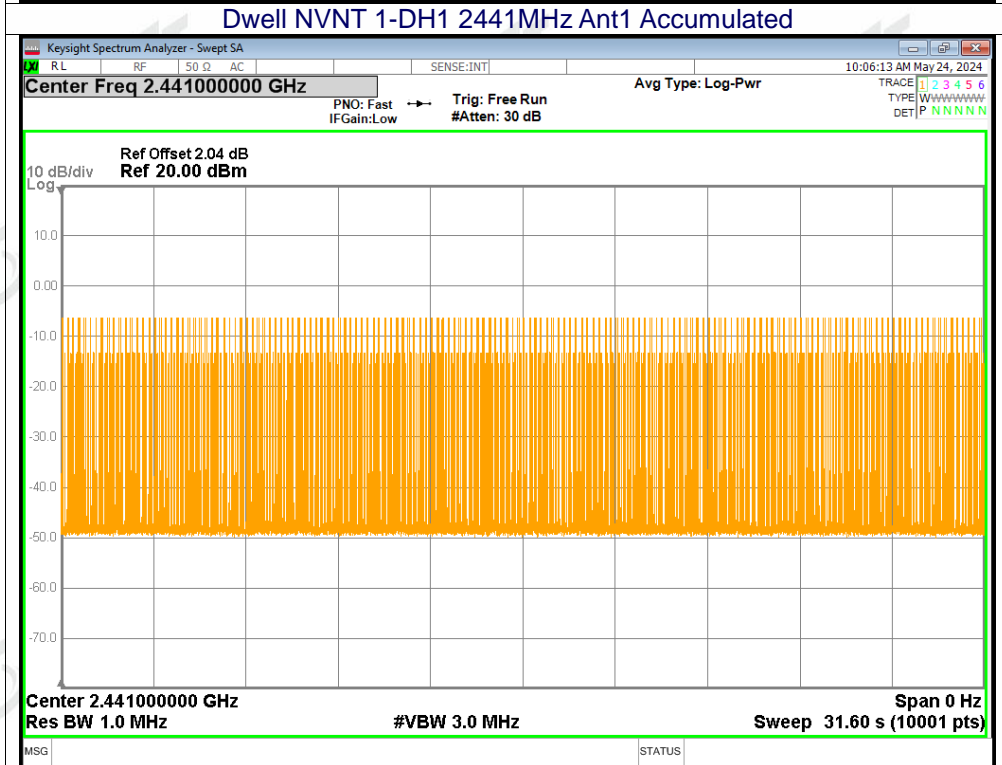
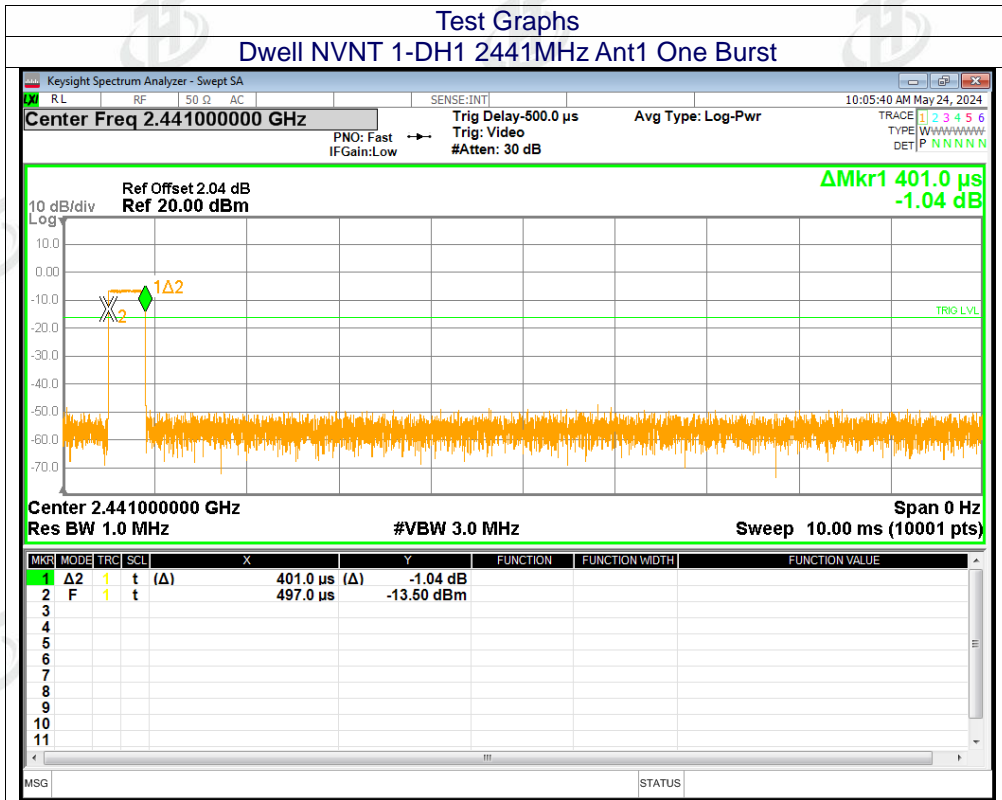

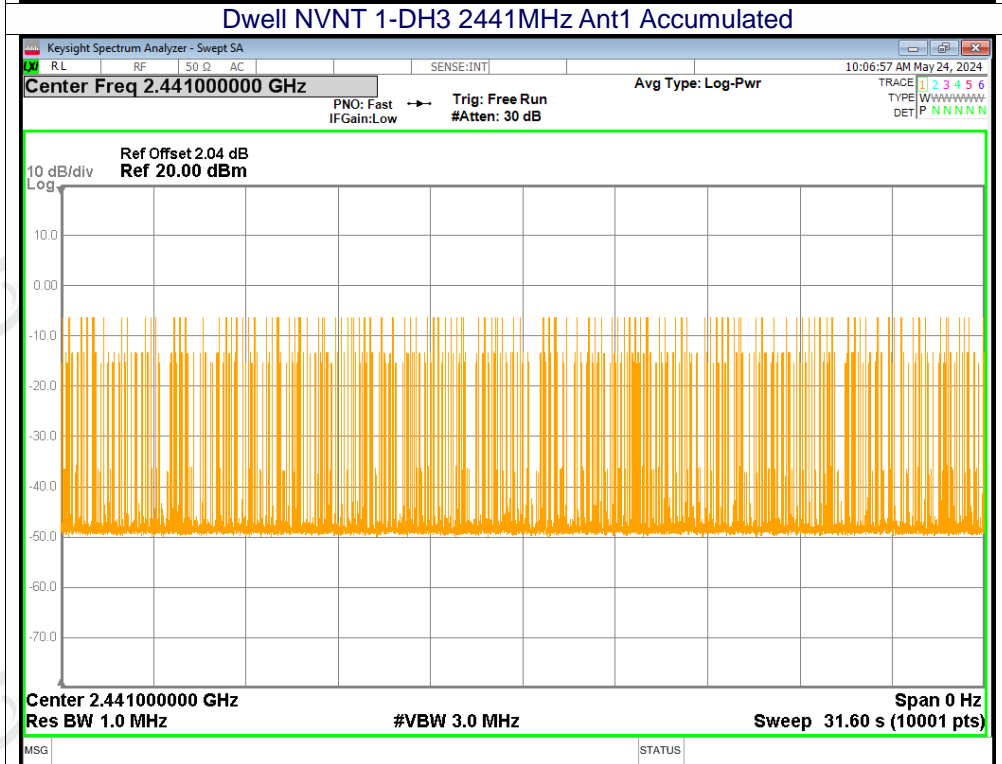
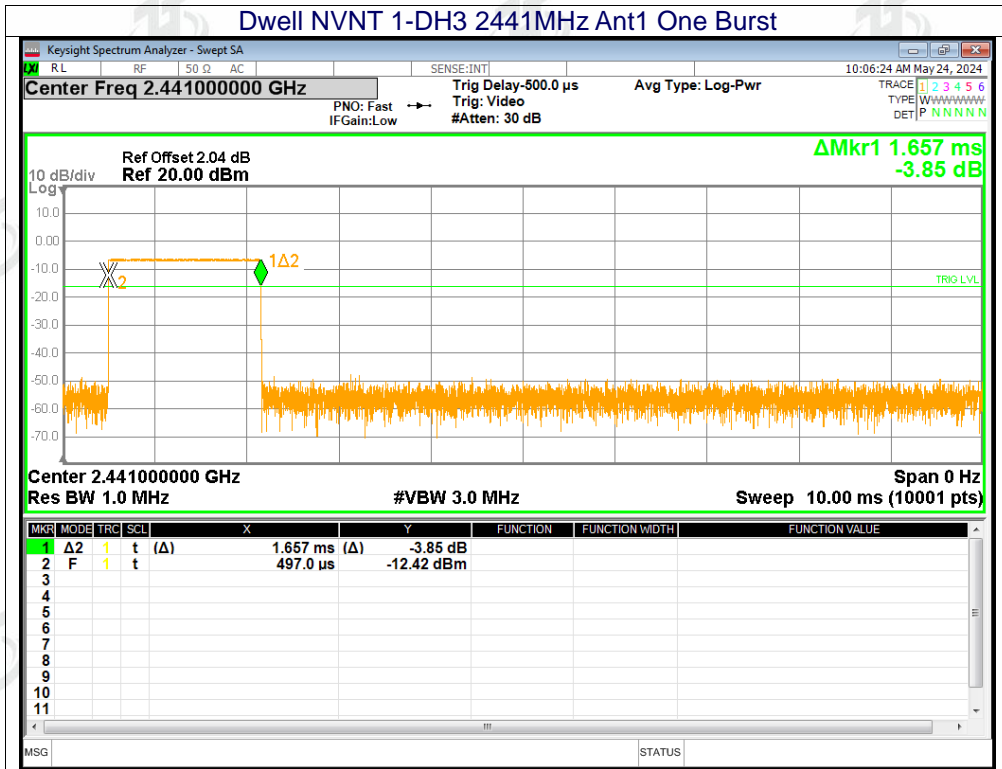

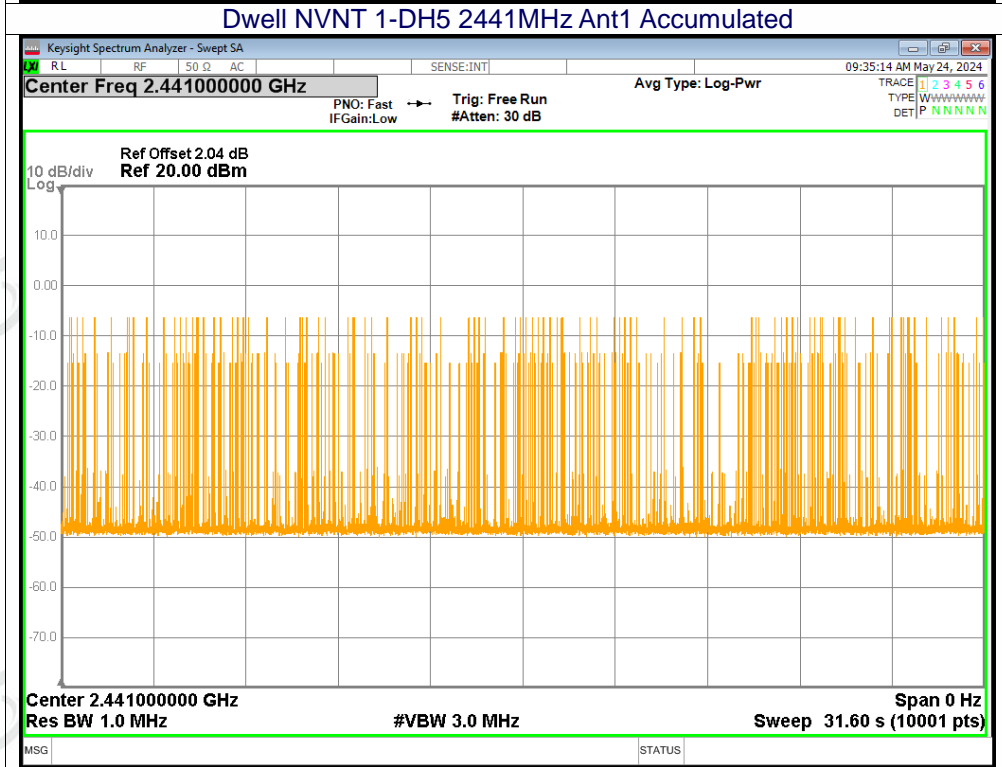
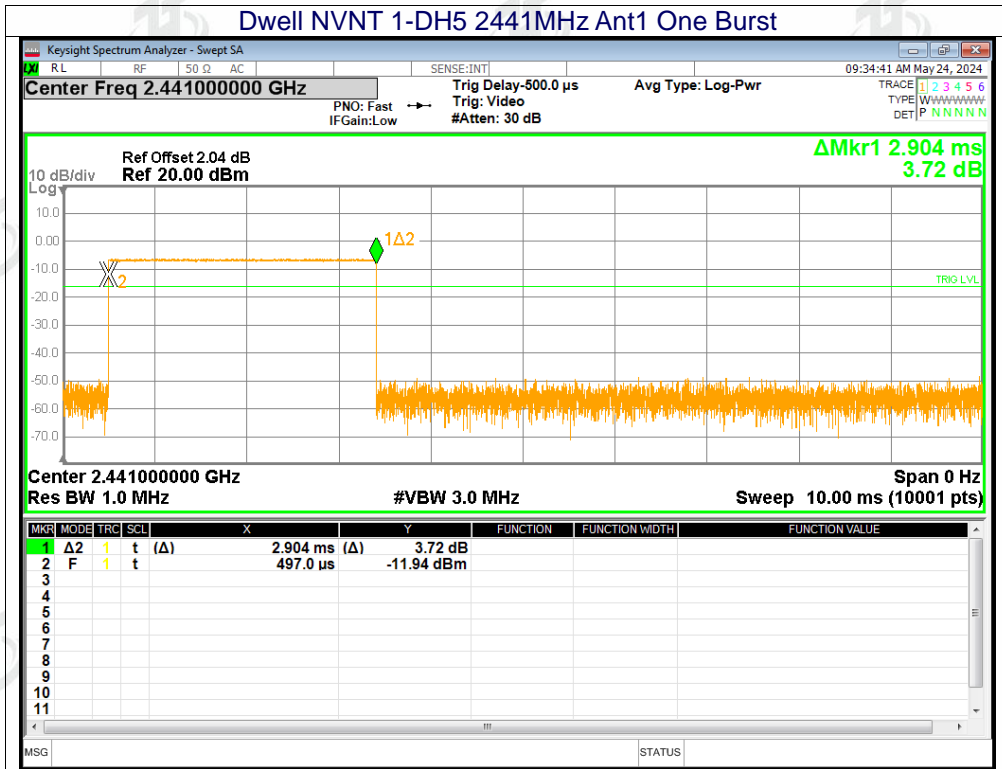

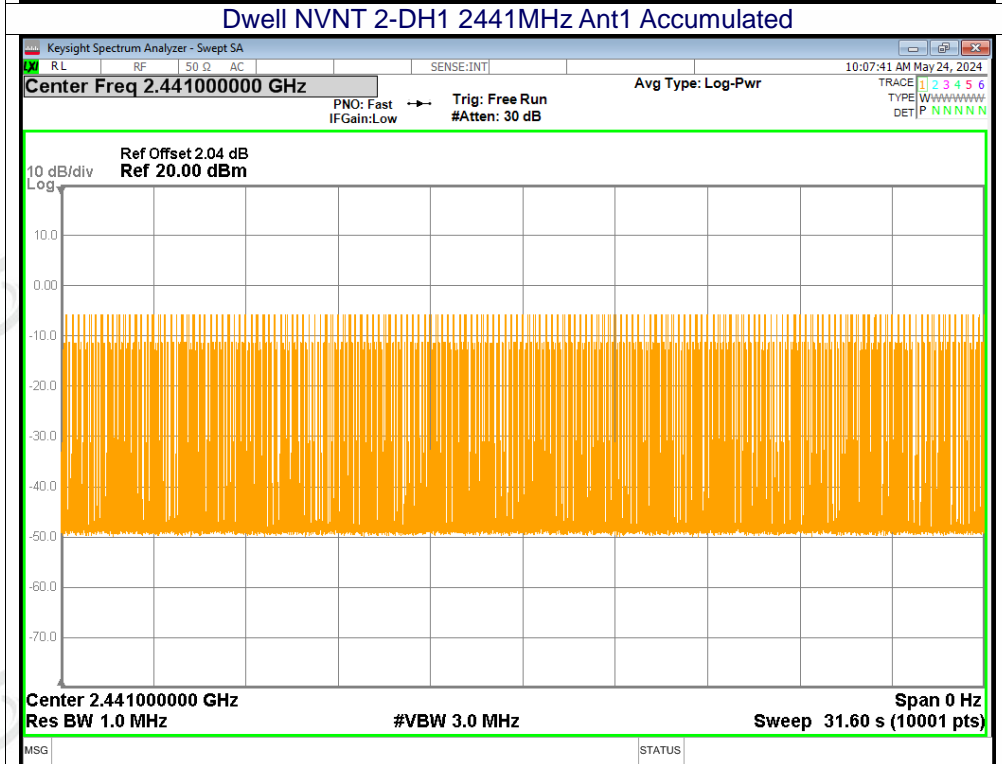
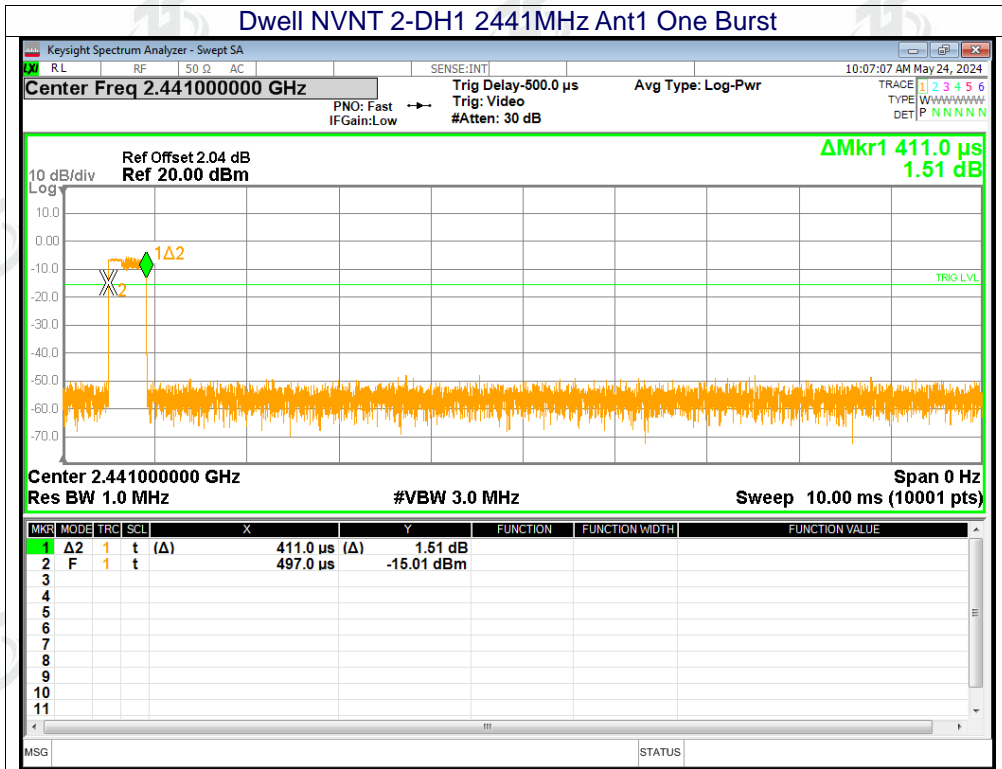

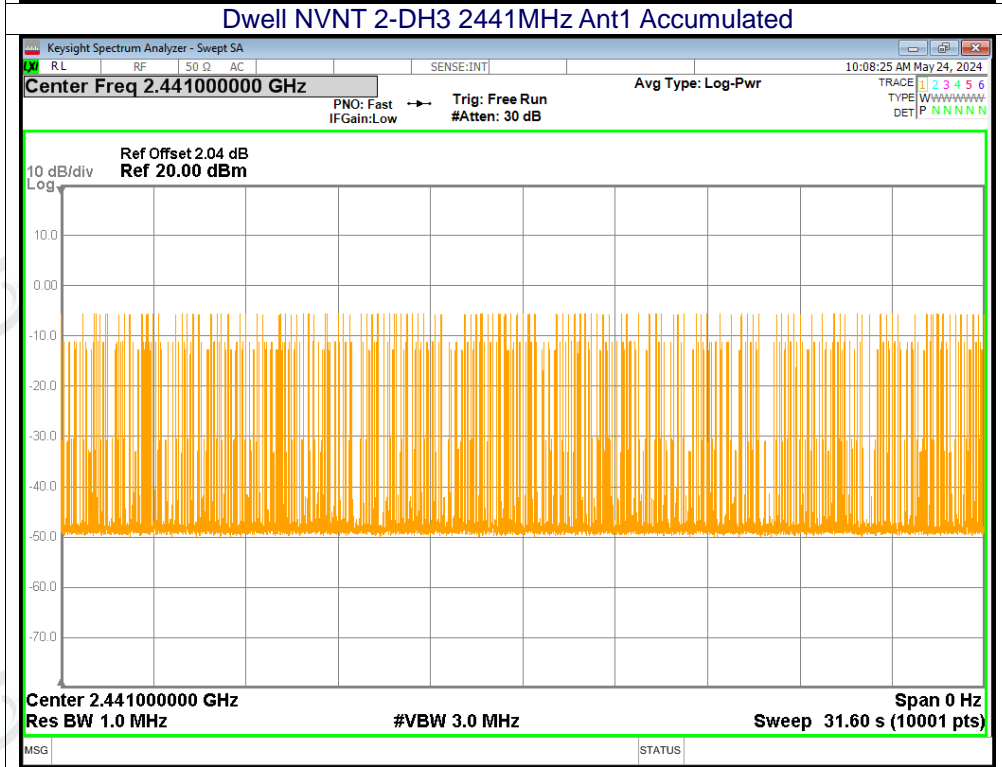
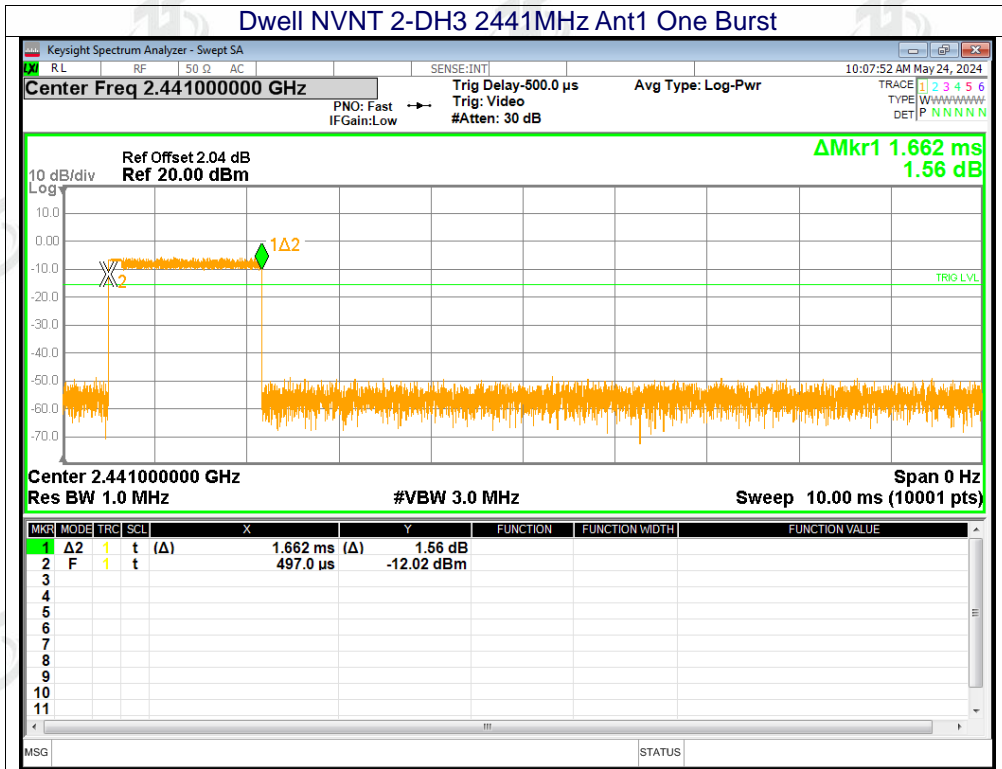

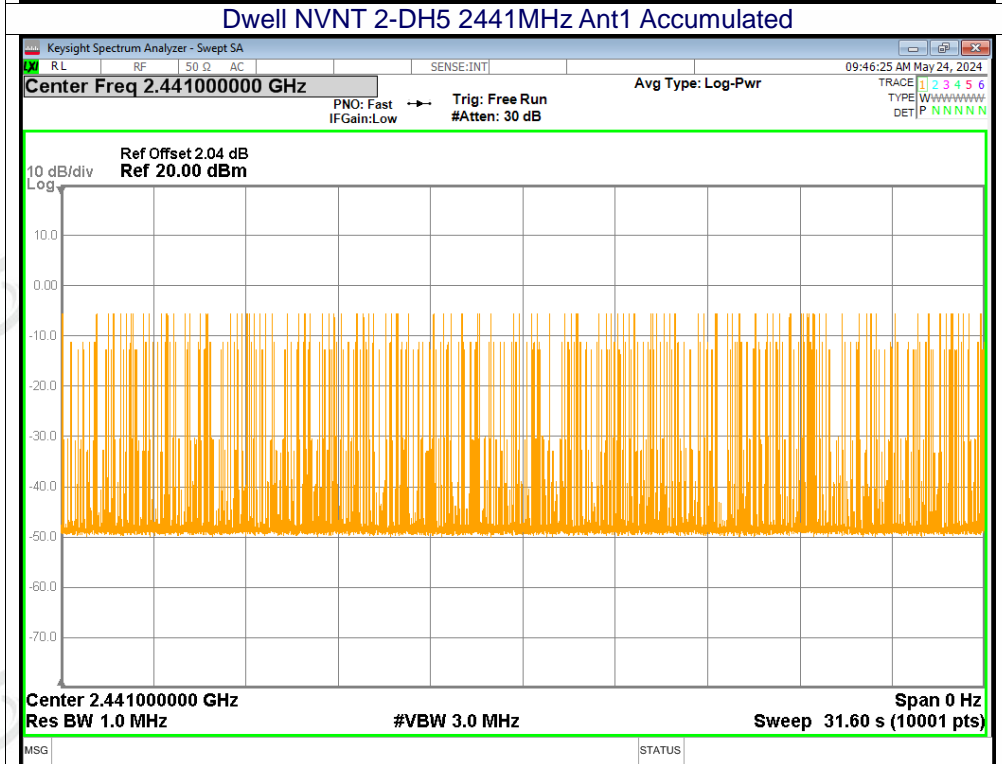
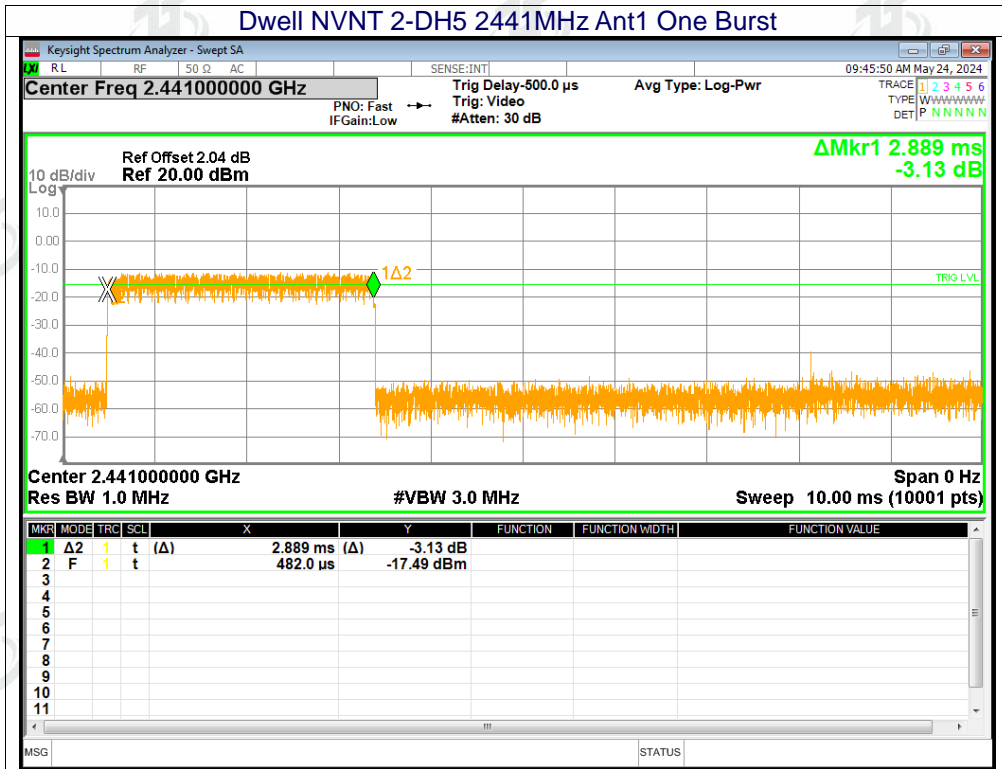

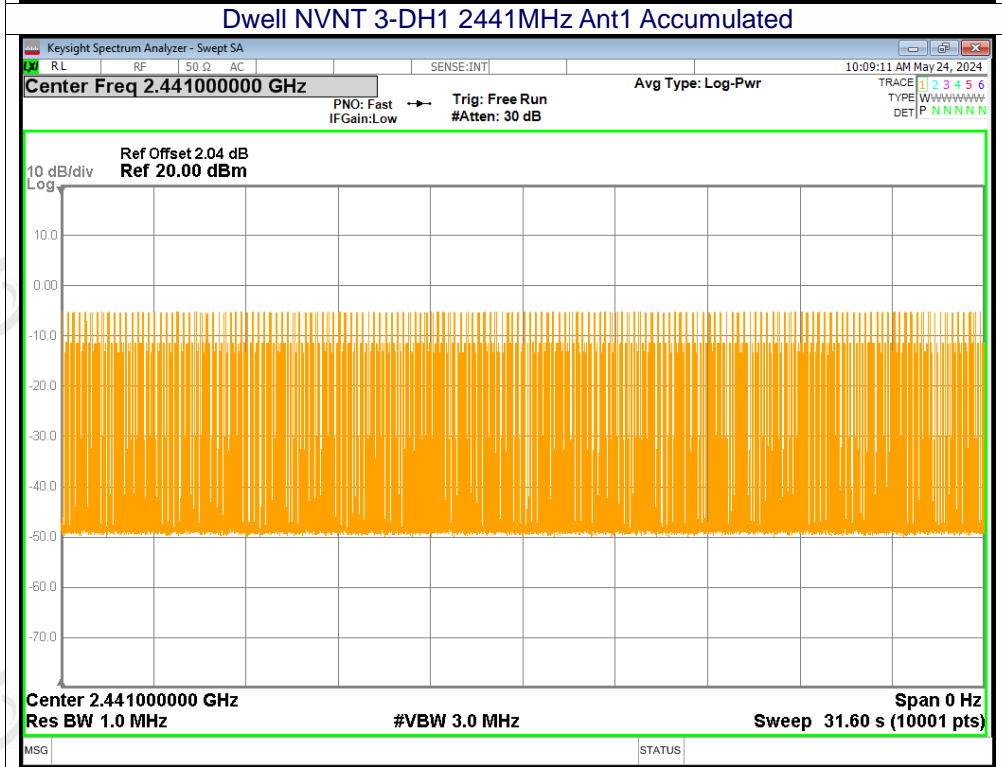
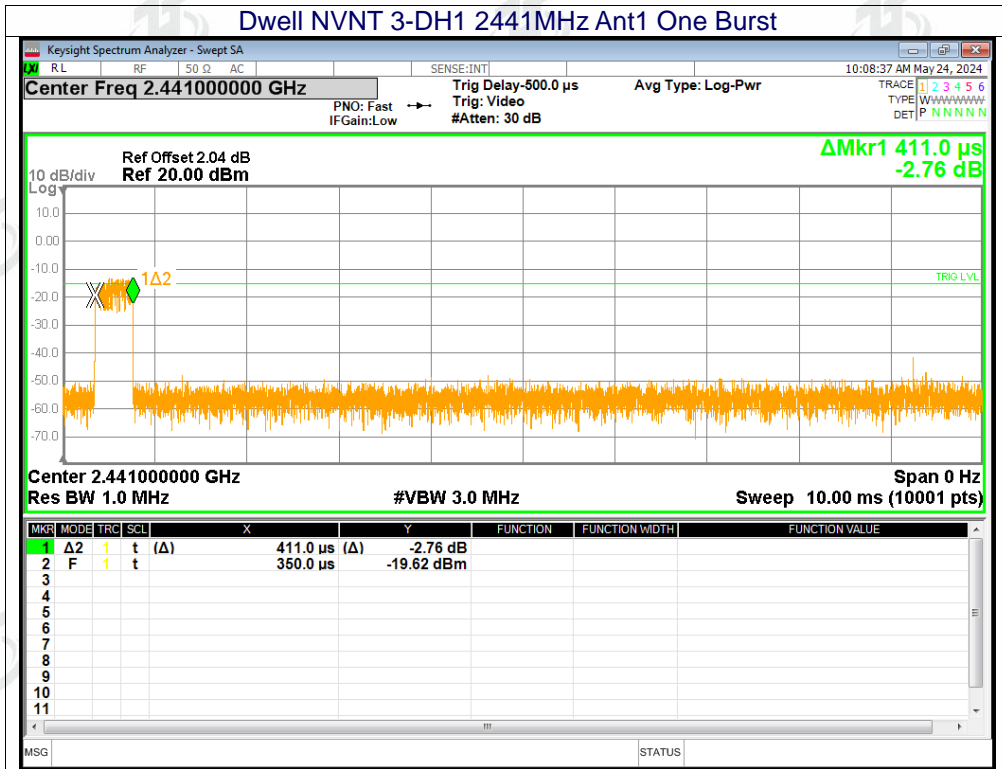

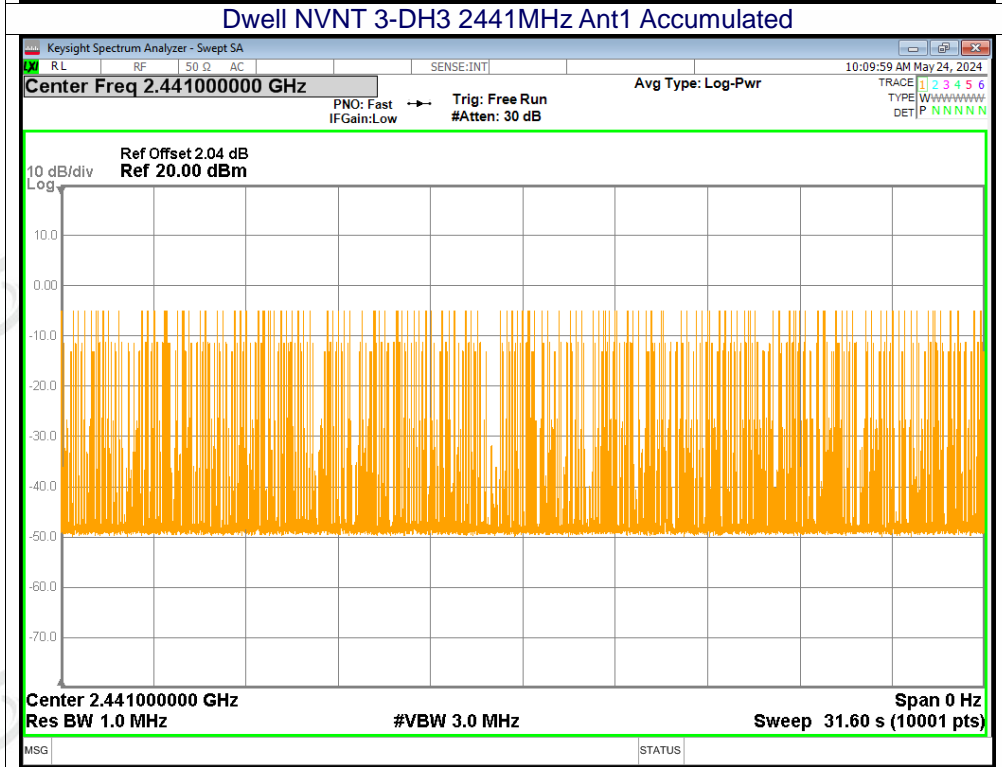
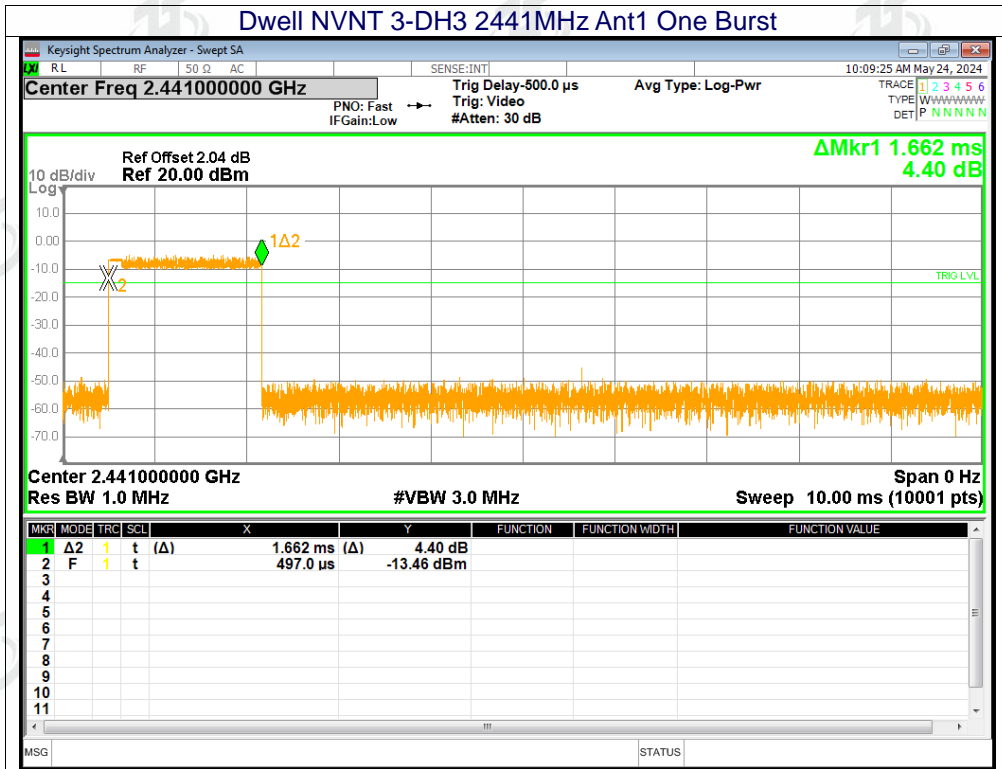

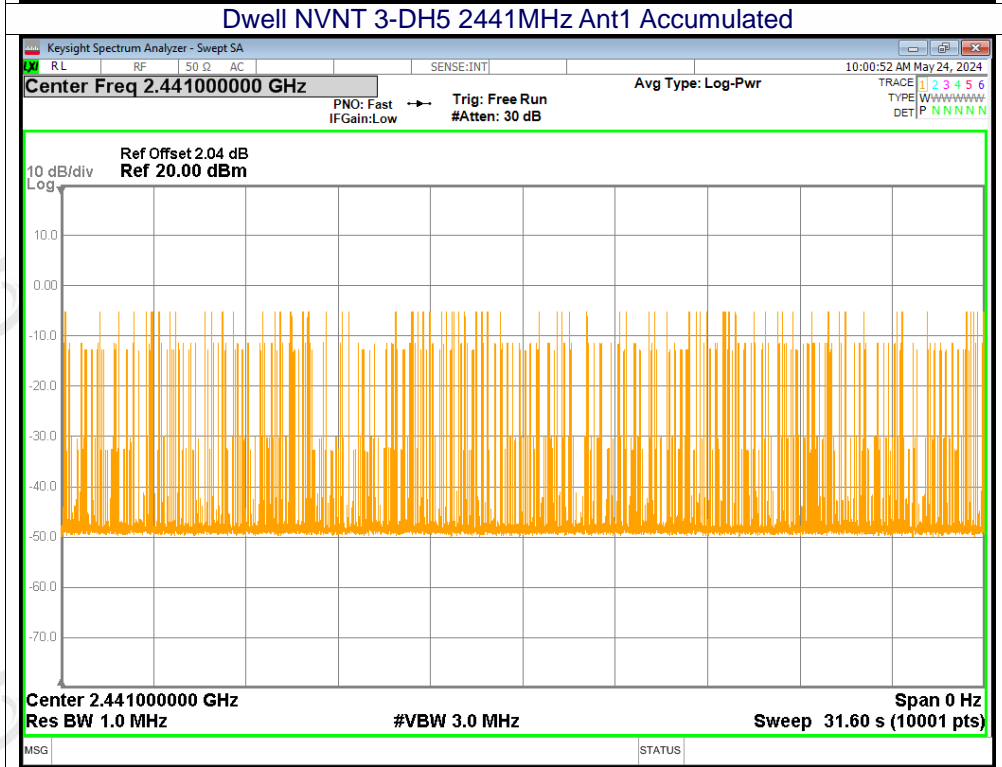
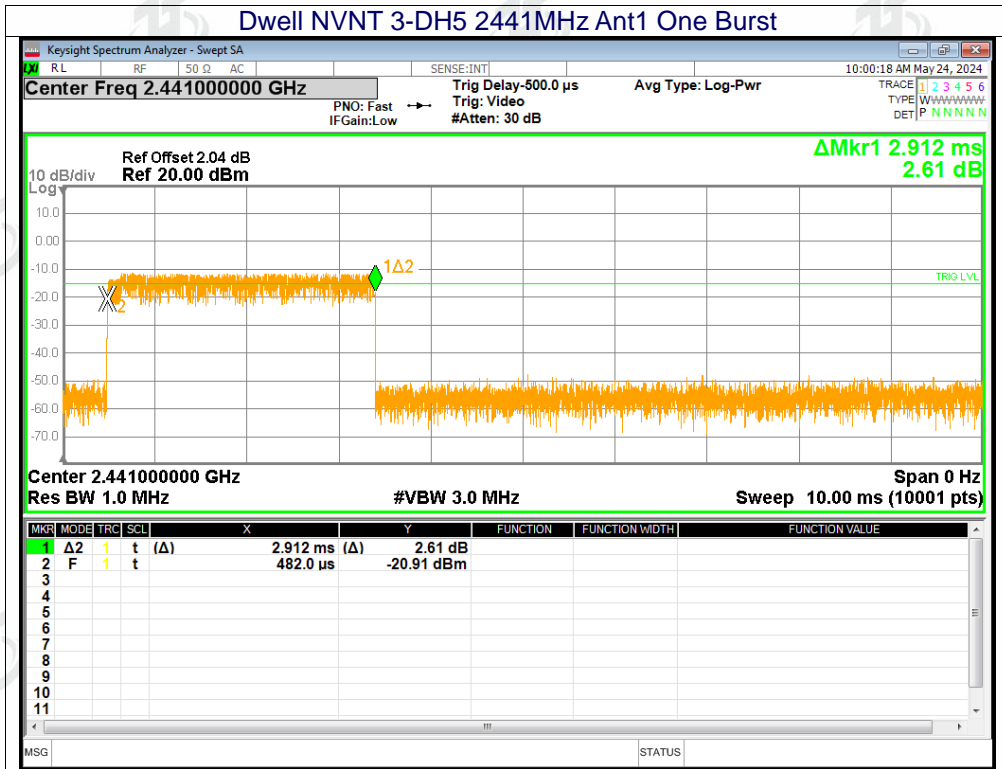



13.2 Maximum Peak Conducted Output Power

| Left earphone | | | | |
|---------------|-----------------|-----------------------|-------------|---------|
| Mode | Frequency (MHz) | Conducted Power (dBm) | Limit (dBm) | Verdict |
| 1-DH5 | 2402 | -8.34 | 30 | Pass |
| 1-DH5 | 2441 | -6.29 | 30 | Pass |
| 1-DH5 | 2480 | -4.72 | 30 | Pass |
| 2-DH5 | 2402 | -7.2 | 21 | Pass |
| 2-DH5 | 2441 | -5.06 | 21 | Pass |
| 2-DH5 | 2480 | -3.51 | 21 | Pass |
| 3-DH5 | 2402 | -6.69 | 21 | Pass |
| 3-DH5 | 2441 | -4.59 | 21 | Pass |
| 3-DH5 | 2480 | -3.03 | 21 | Pass |

| Right earphone | | | | |
|----------------|-----------------|-----------------------|-------------|---------|
| Mode | Frequency (MHz) | Conducted Power (dBm) | Limit (dBm) | Verdict |
| 1-DH5 | 2402 | -8.11 | 30 | Pass |
| 1-DH5 | 2441 | -6.23 | 30 | Pass |
| 1-DH5 | 2480 | -4.74 | 30 | Pass |
| 2-DH5 | 2402 | -7.28 | 21 | Pass |
| 2-DH5 | 2441 | -5.25 | 21 | Pass |
| 2-DH5 | 2480 | -3.41 | 21 | Pass |
| 3-DH5 | 2402 | -6.59 | 21 | Pass |
| 3-DH5 | 2441 | -4.44 | 21 | Pass |
| 3-DH5 | 2480 | -3.18 | 21 | Pass |



13.3 -20dB Bandwidth

| Mode | Frequency (MHz) | -20 dB Bandwidth (MHz) | Verdict |
|-------|-----------------|------------------------|---------|
| 1-DH5 | 2402 | 0.949 | Pass |
| 1-DH5 | 2441 | 0.936 | Pass |
| 1-DH5 | 2480 | 0.943 | Pass |
| 2-DH5 | 2402 | 1.29 | Pass |
| 2-DH5 | 2441 | 1.286 | Pass |
| 2-DH5 | 2480 | 1.212 | Pass |
| 3-DH5 | 2402 | 1.274 | Pass |
| 3-DH5 | 2441 | 1.272 | Pass |
| 3-DH5 | 2480 | 1.221 | Pass |

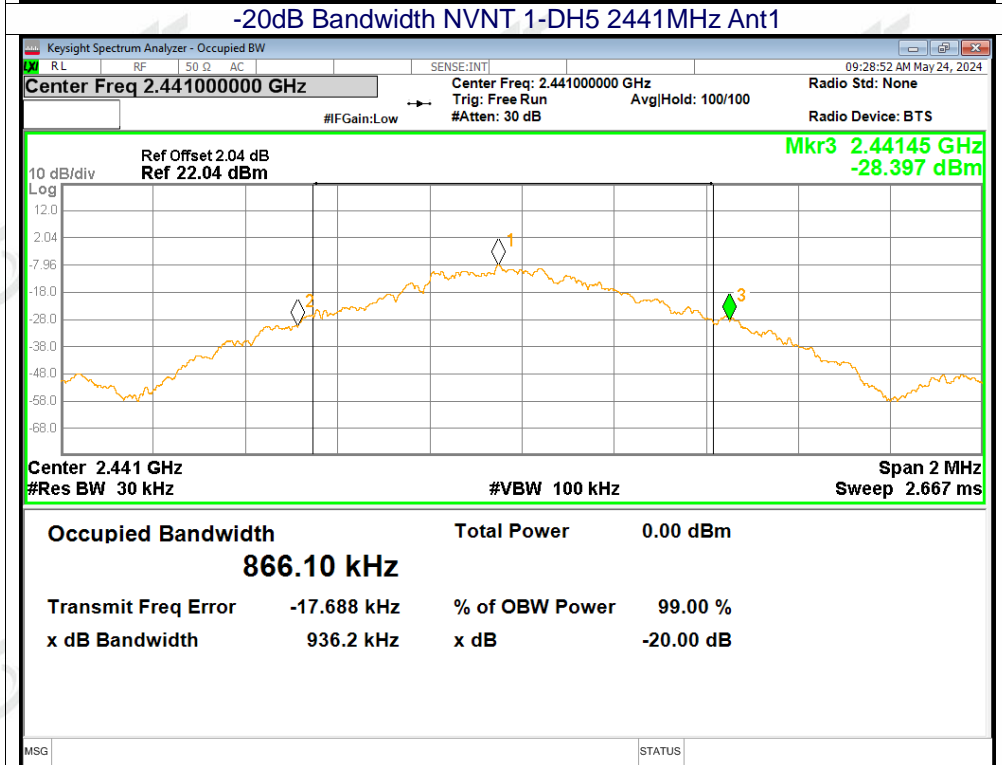
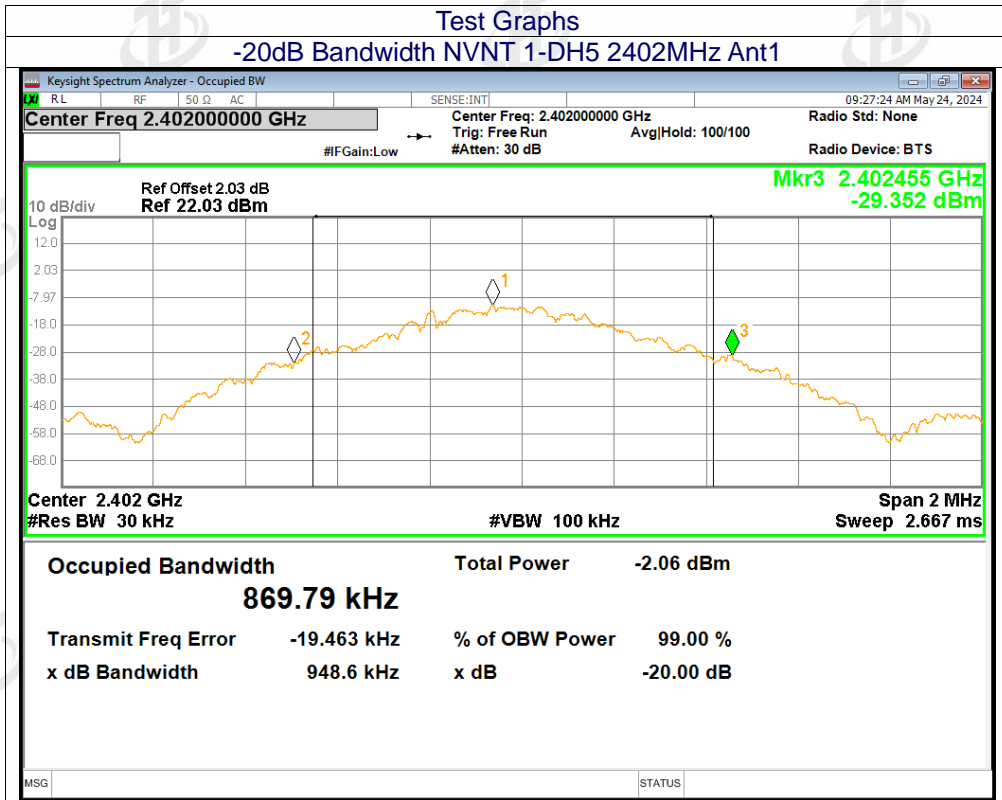

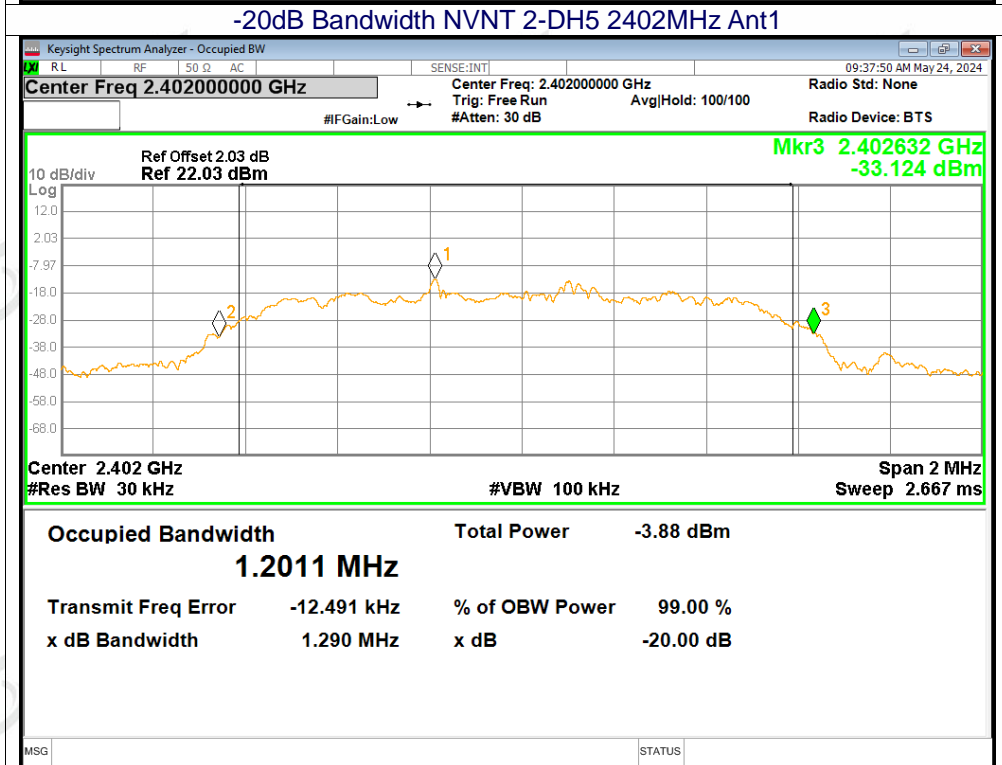
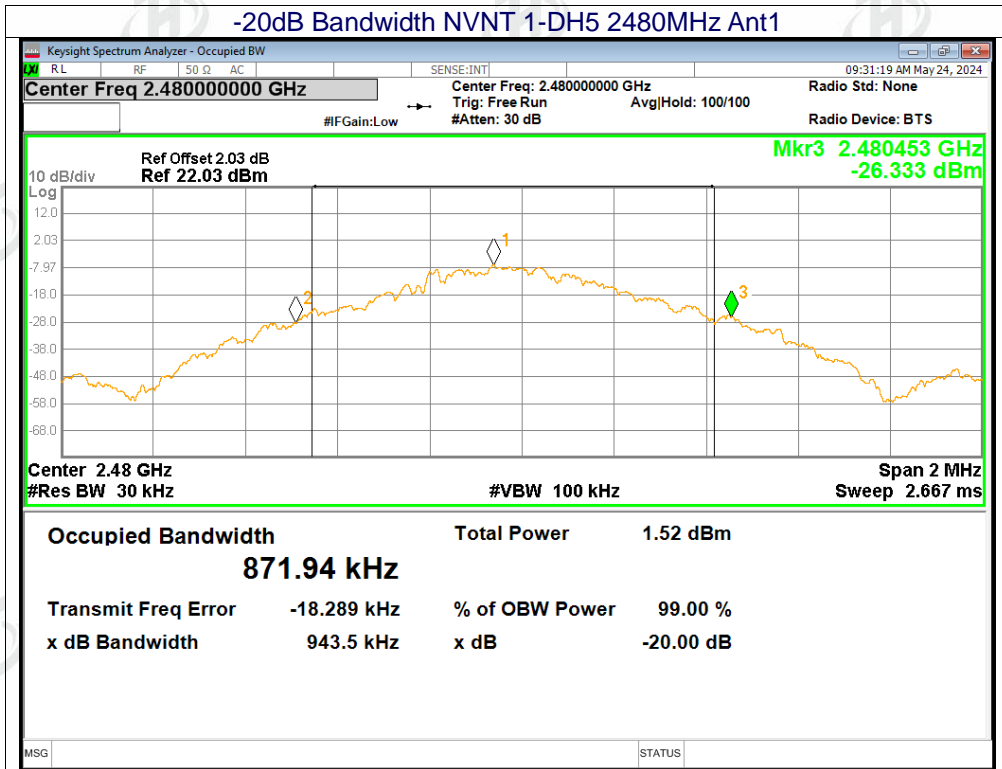

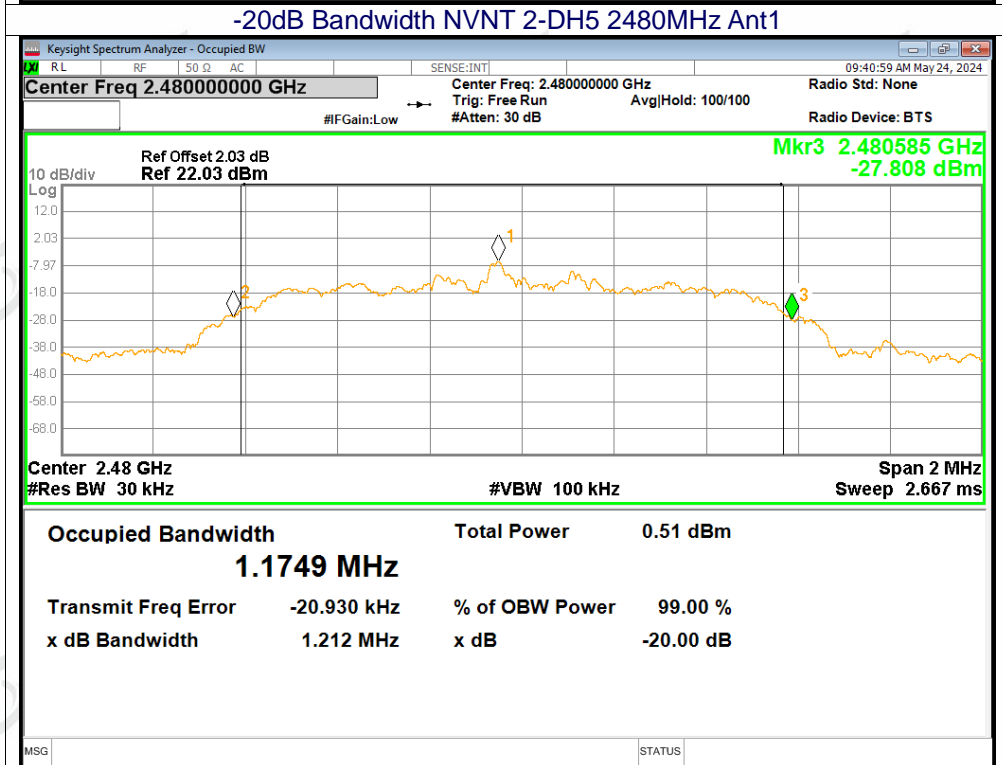
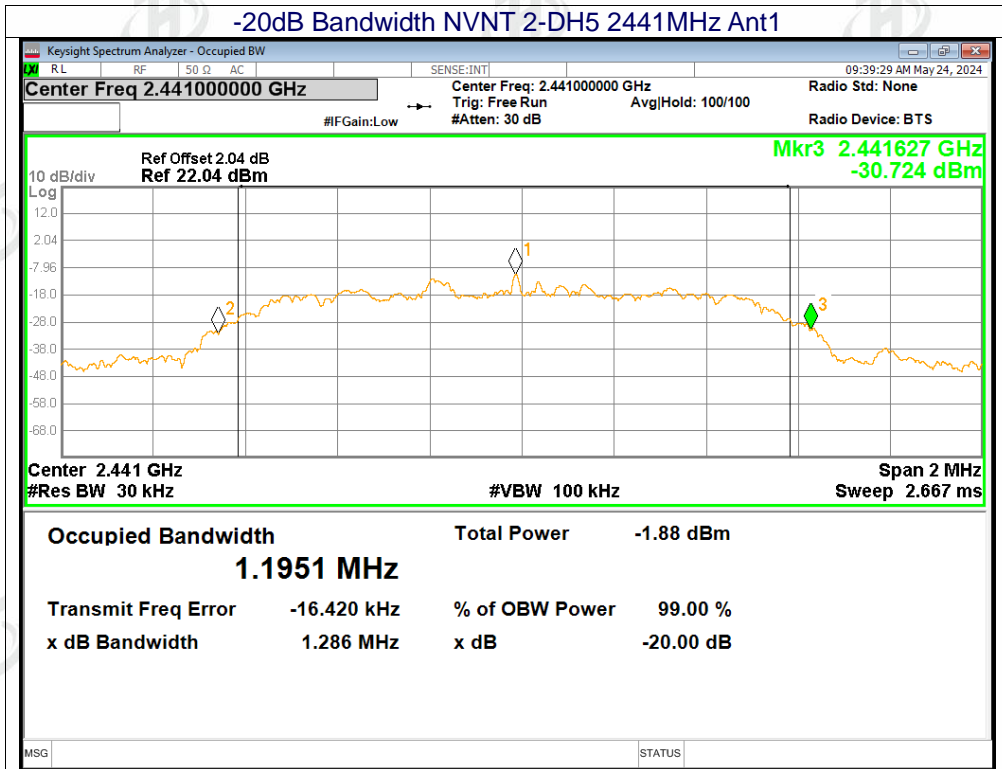

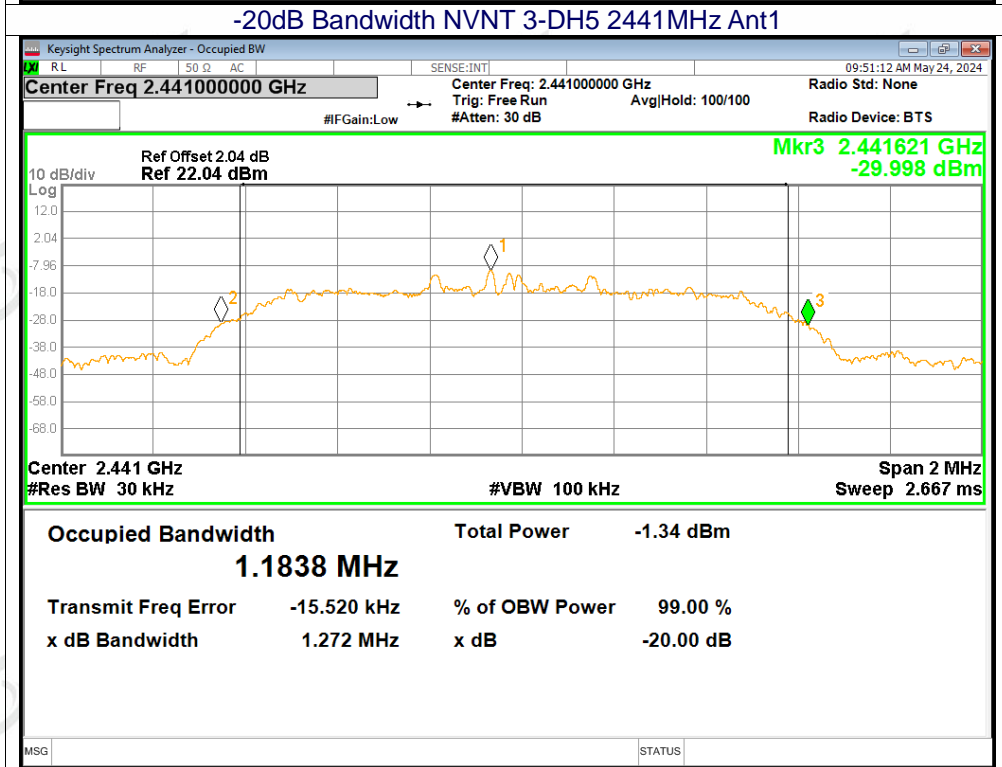
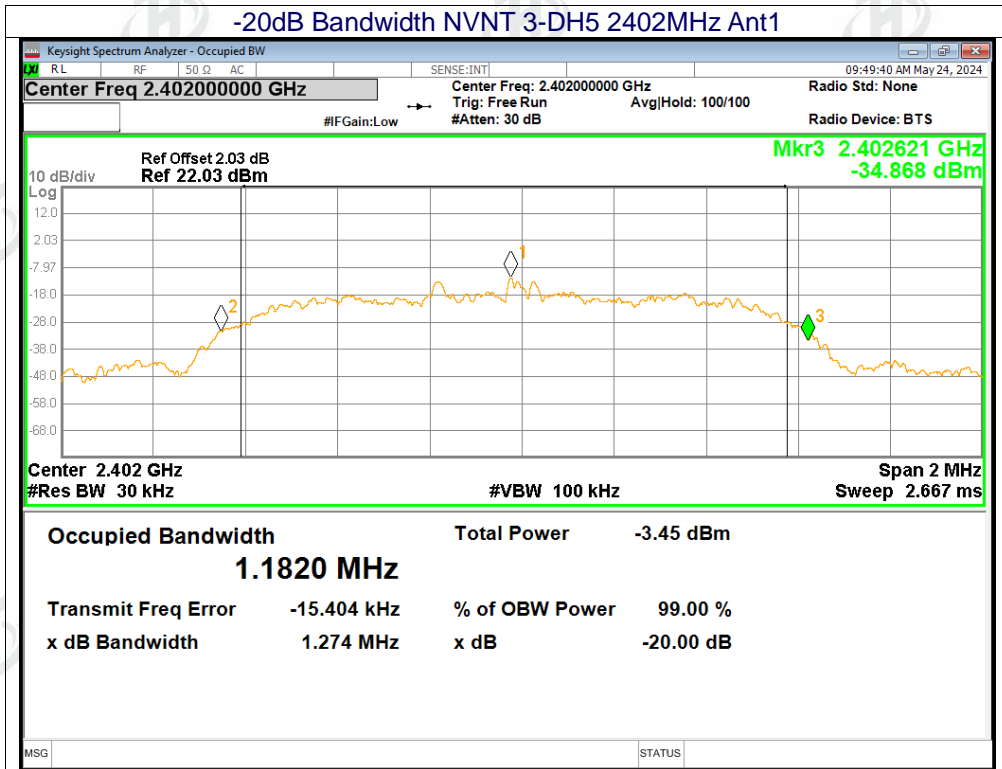

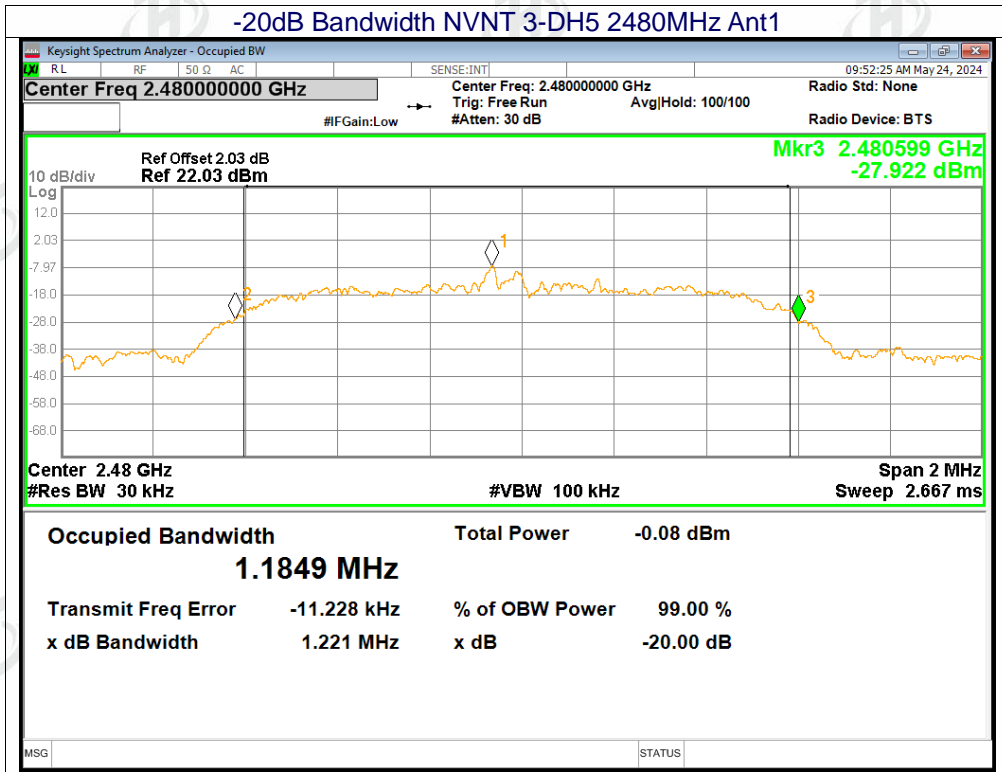



13.4 Occupied Channel Bandwidth

| Mode | Frequency (MHz) | 99% OBW (MHz) |
|-------|-----------------|---------------|
| 1-DH5 | 2402 | 0.864 |
| 1-DH5 | 2441 | 0.864 |
| 1-DH5 | 2480 | 0.873 |
| 2-DH5 | 2402 | 1.197 |
| 2-DH5 | 2441 | 1.196 |
| 2-DH5 | 2480 | 1.208 |
| 3-DH5 | 2402 | 1.182 |
| 3-DH5 | 2441 | 1.178 |
| 3-DH5 | 2480 | 1.184 |

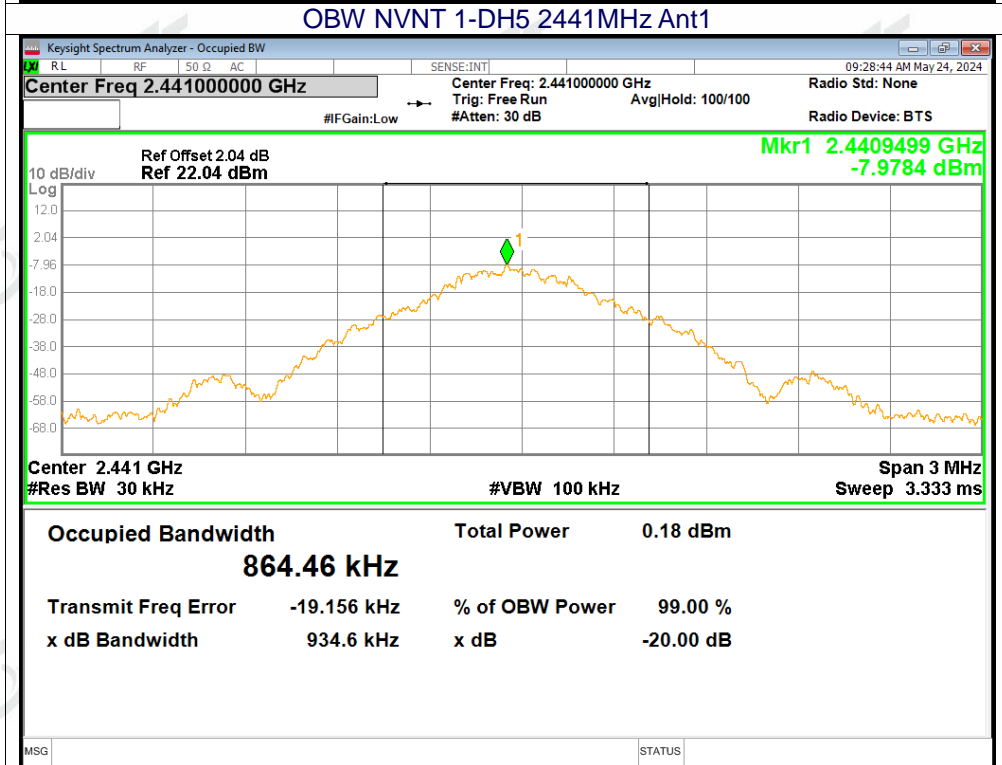
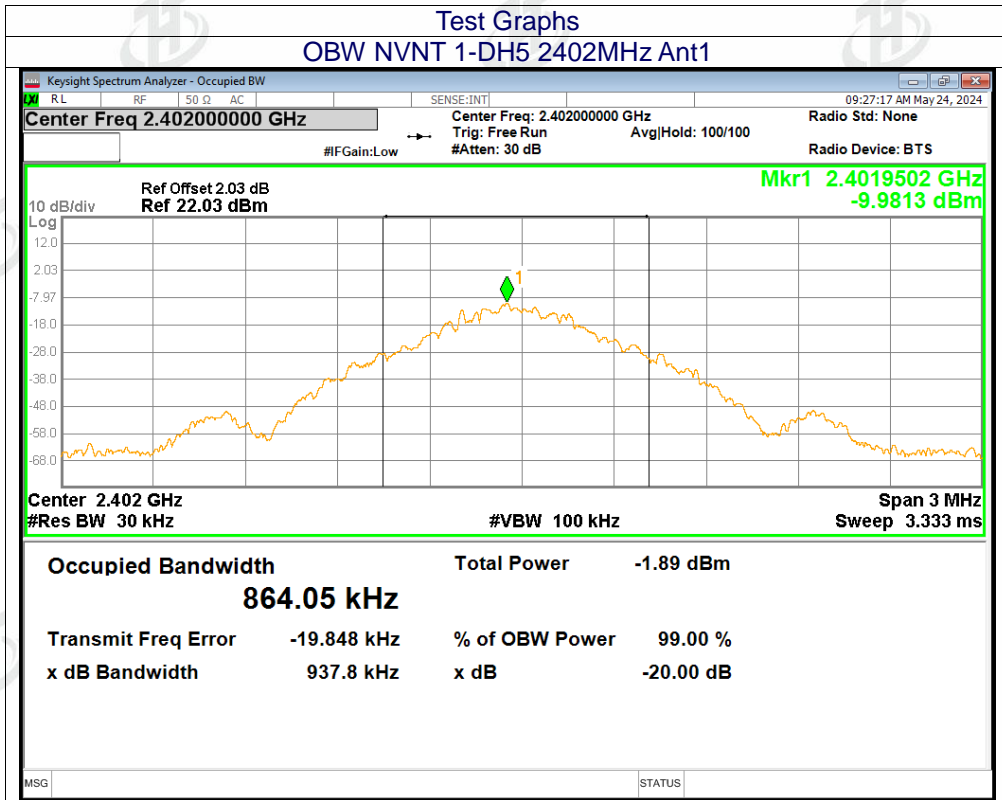

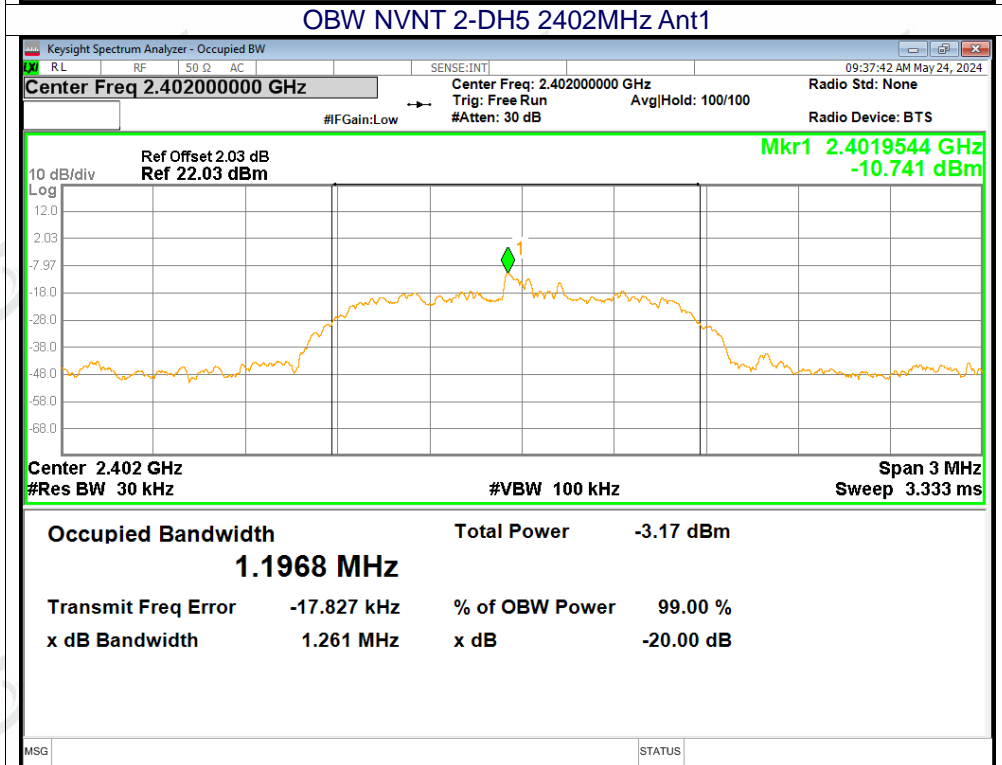
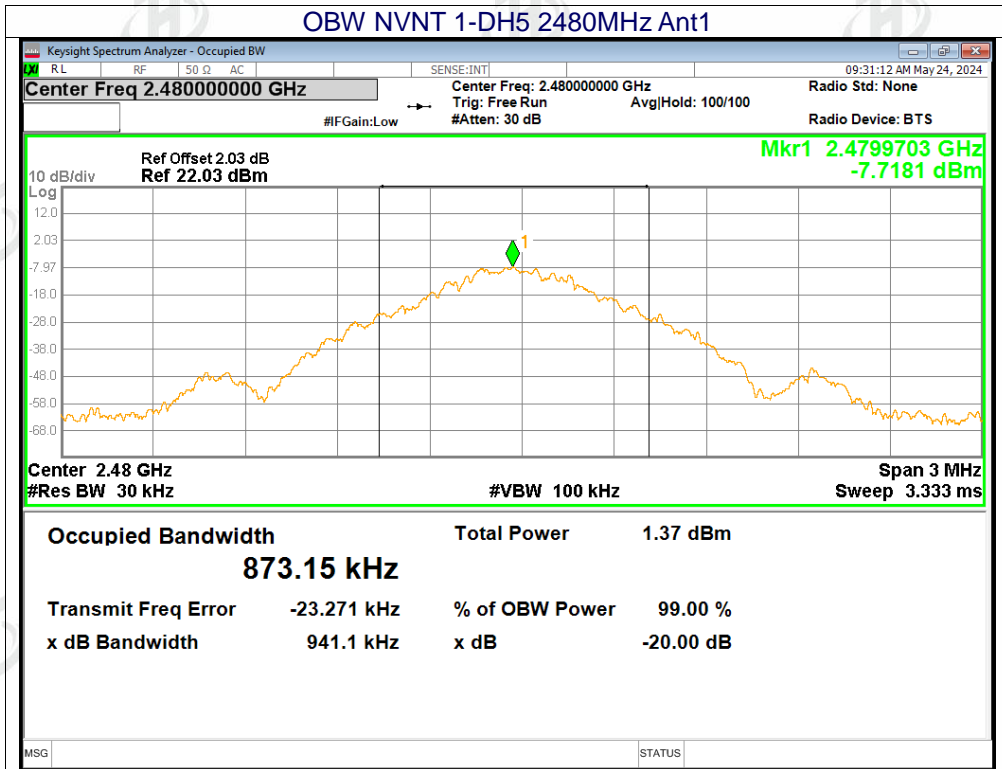

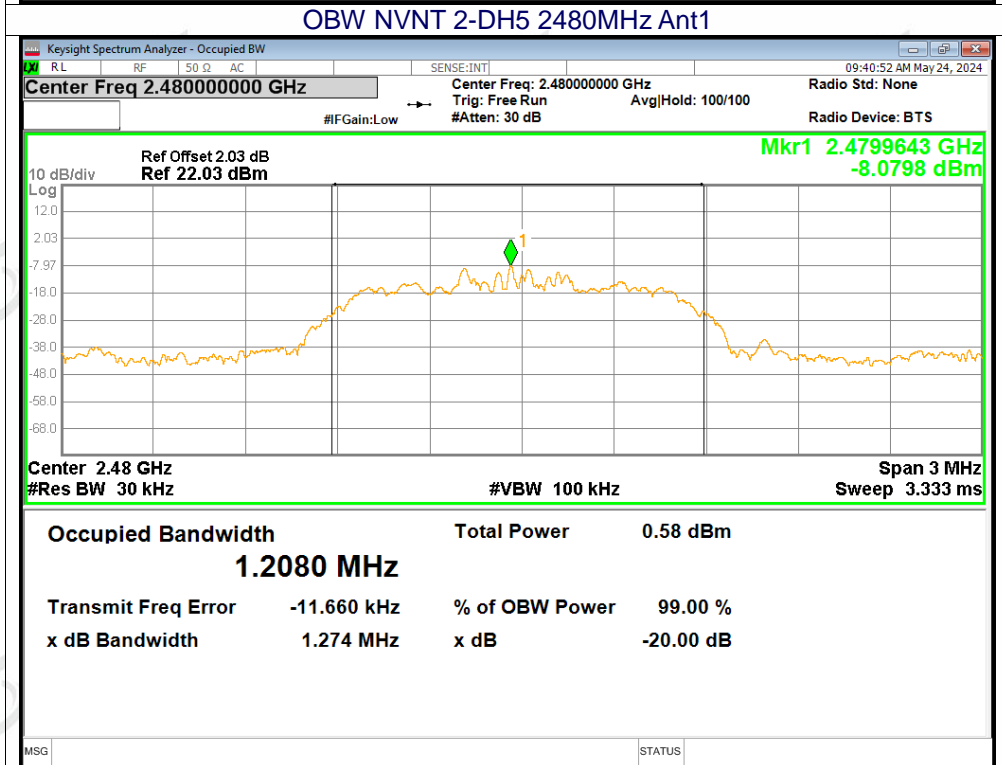
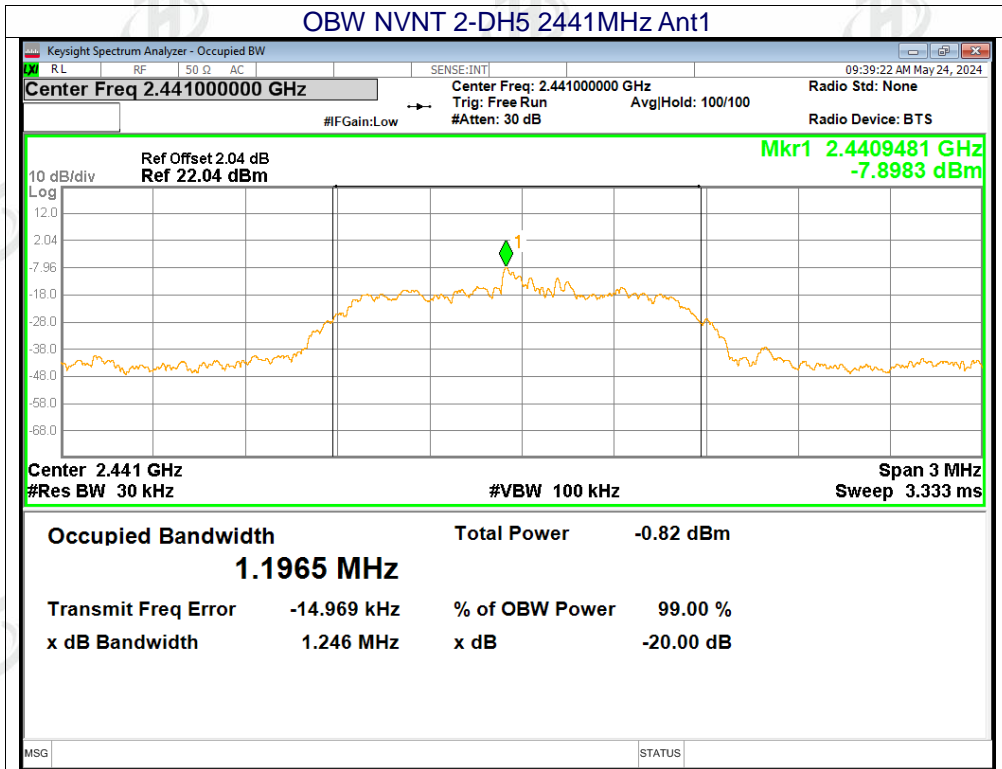

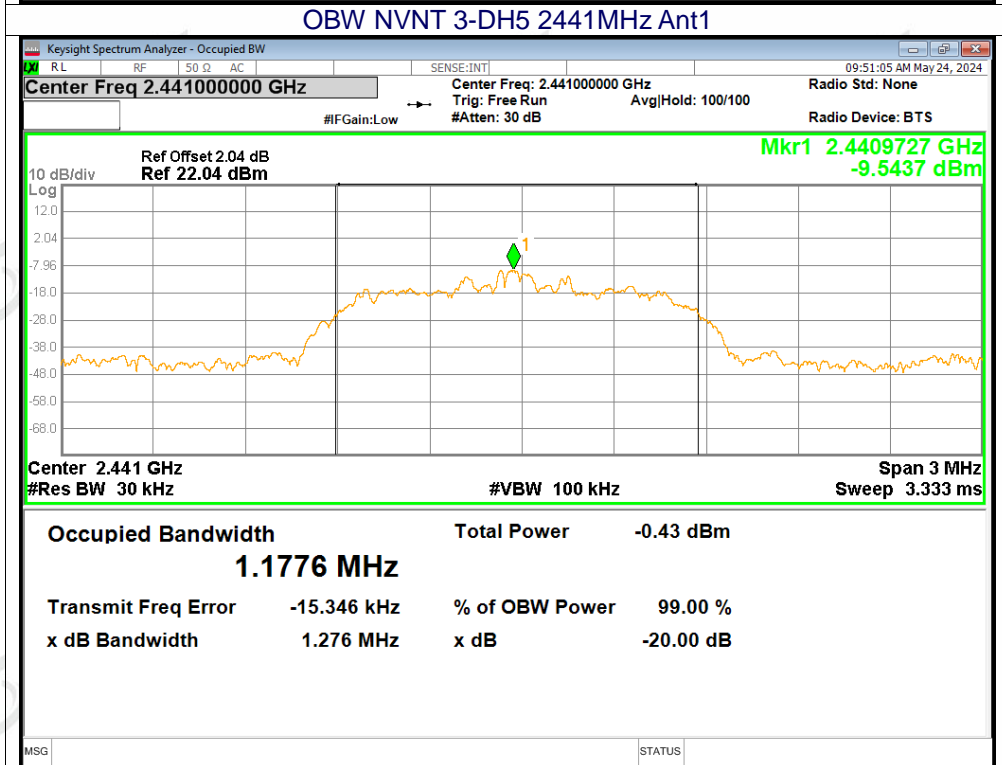
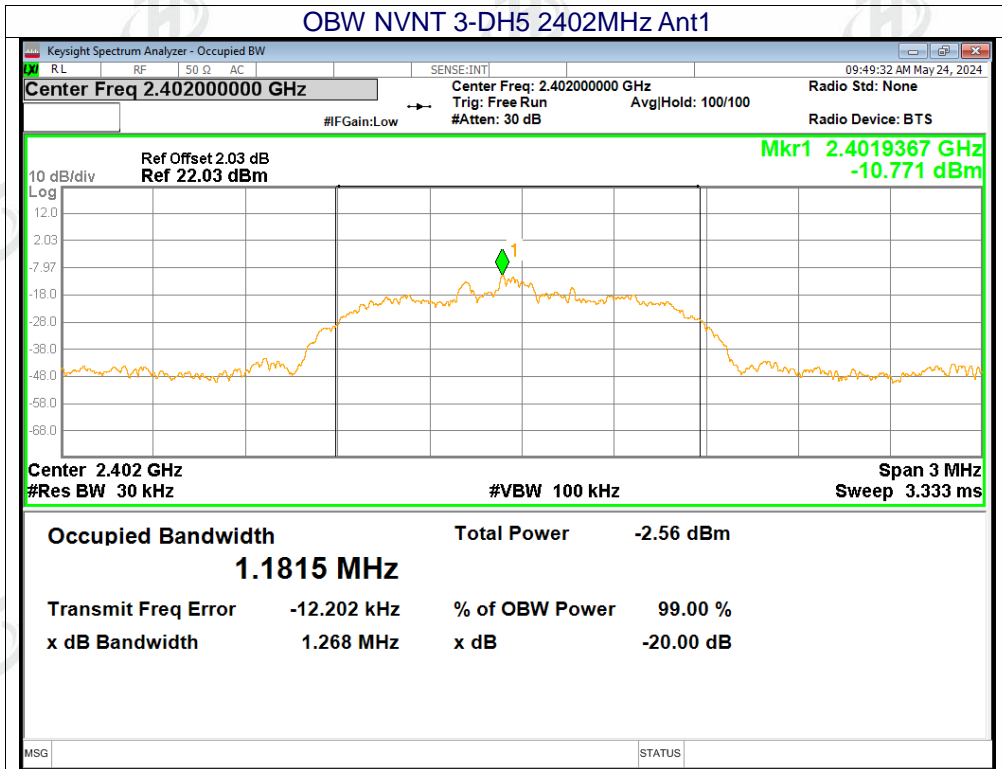

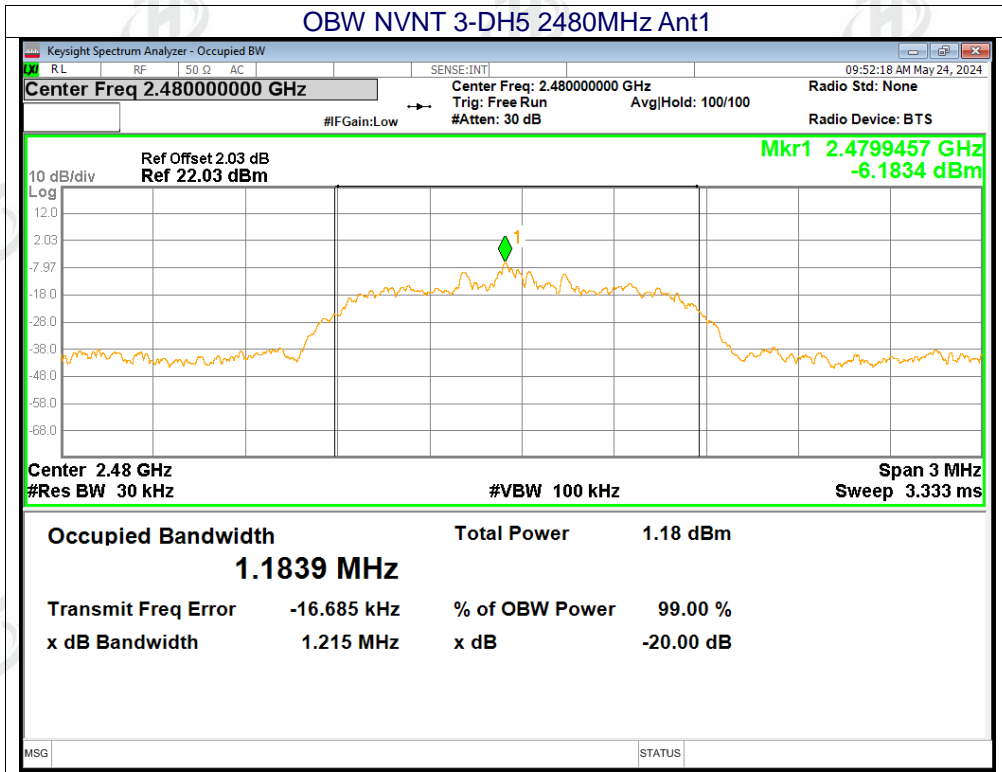



13.5 Carrier Frequencies Separation

| Mode | Hopping Freq1 (MHz) | Hopping Freq2 (MHz) | HFS (MHz) | Limit (MHz) | Verdict |
|-------|---------------------|---------------------|-----------|-------------|---------|
| 1-DH5 | 2401.992 | 2403.04 | 1.048 | 0.949 | Pass |
| 1-DH5 | 2440.902 | 2442.034 | 1.132 | 0.936 | Pass |
| 1-DH5 | 2478.974 | 2479.944 | 0.97 | 0.943 | Pass |
| 2-DH5 | 2401.954 | 2402.948 | 0.994 | 0.86 | Pass |
| 2-DH5 | 2440.988 | 2441.956 | 0.968 | 0.857 | Pass |
| 2-DH5 | 2478.954 | 2479.976 | 1.022 | 0.808 | Pass |
| 3-DH5 | 2401.948 | 2402.934 | 0.986 | 0.849 | Pass |
| 3-DH5 | 2440.932 | 2441.952 | 1.02 | 0.848 | Pass |
| 3-DH5 | 2478.954 | 2479.962 | 1.008 | 0.814 | Pass |

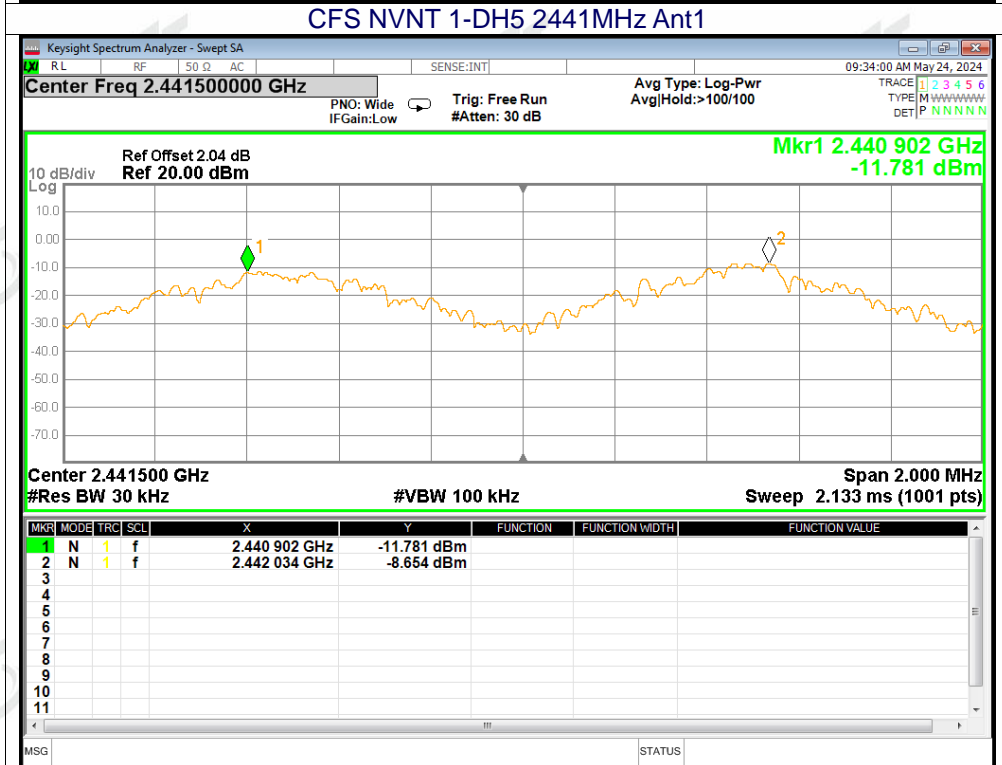
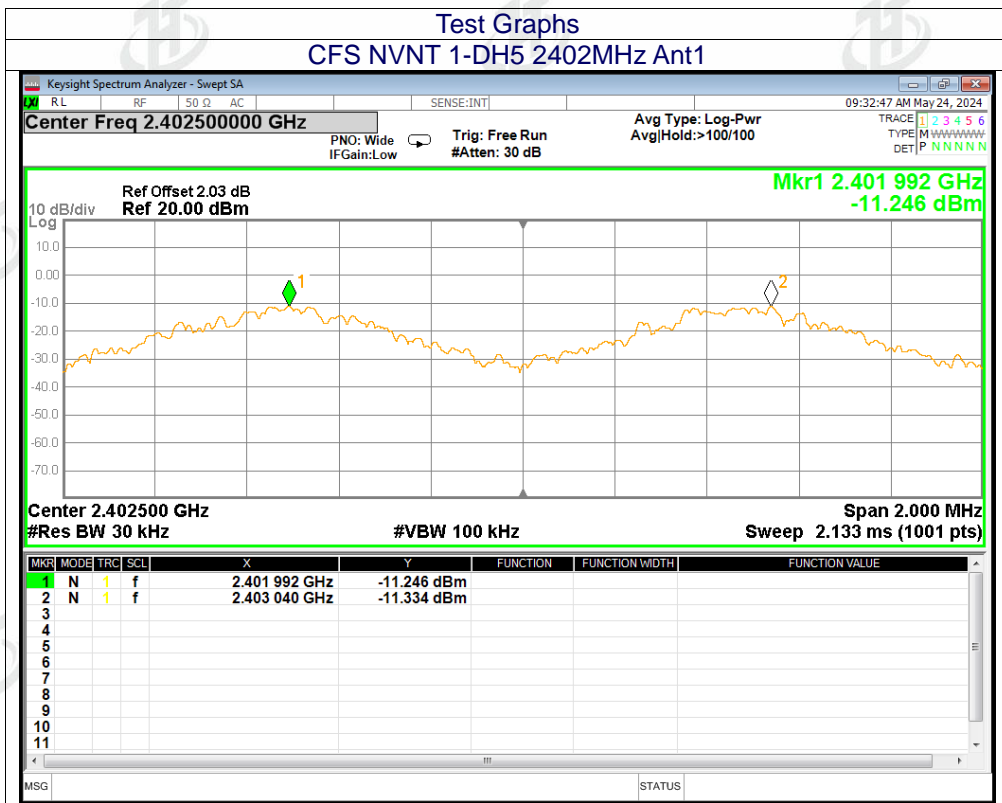



CFS NVNT 1-DH5 2480MHz Ant1

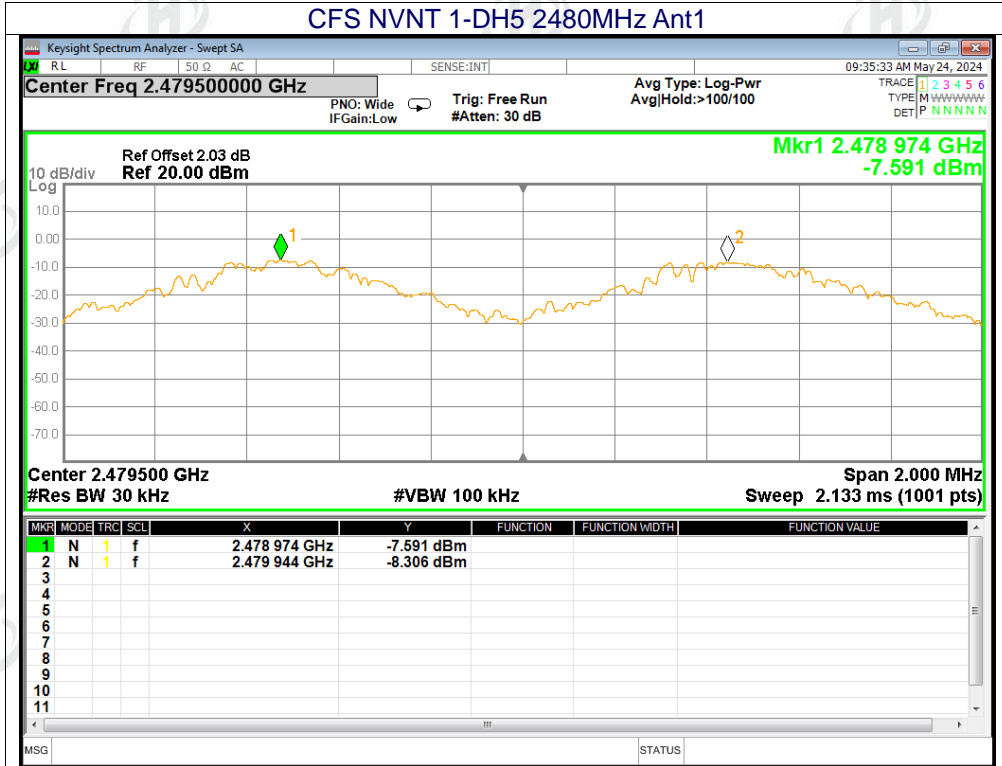

CFS NVNT 2-DH5 2402MHz Ant1

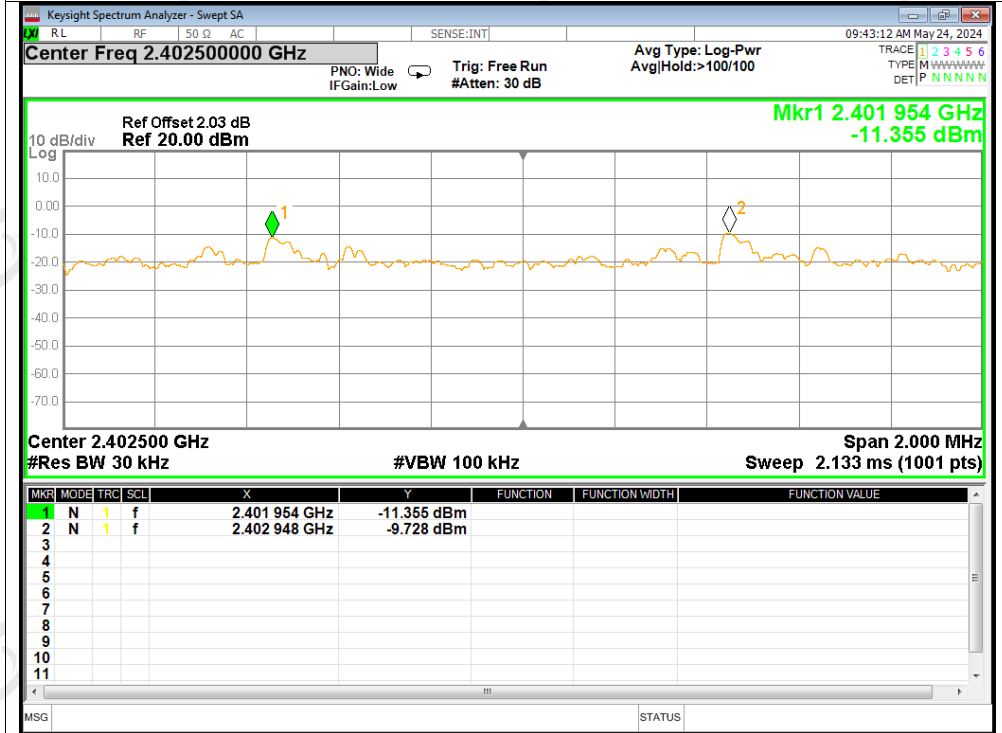



CFS NVNT 2-DH5 2441MHz Ant1

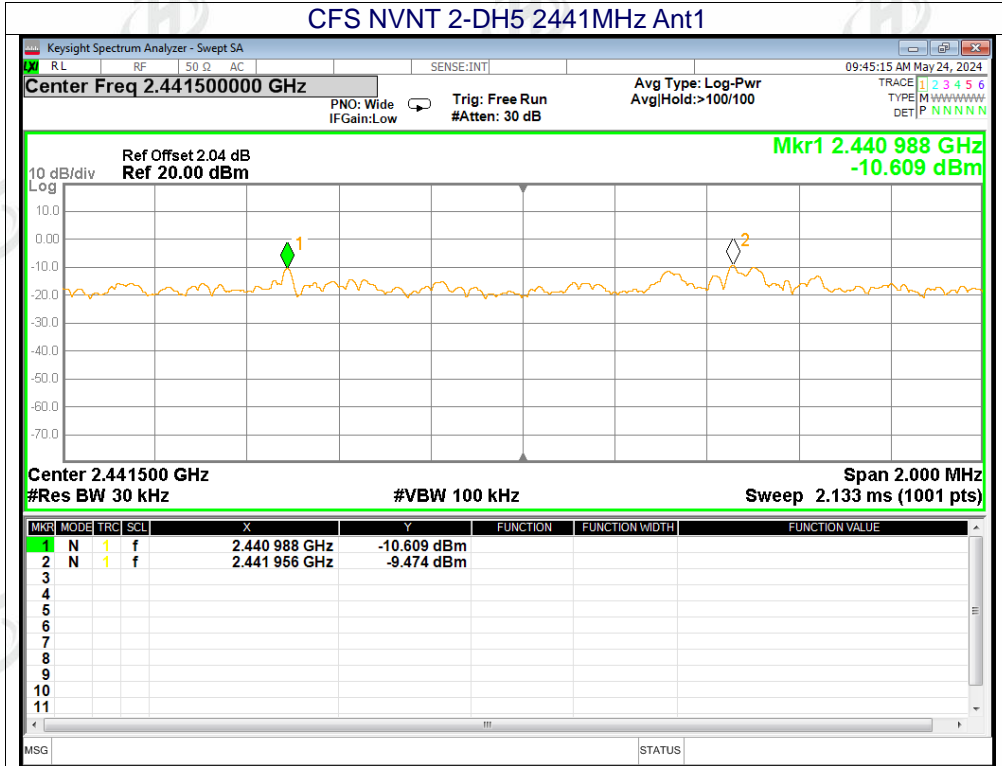

CFS NVNT 2-DH5 2480MHz Ant1

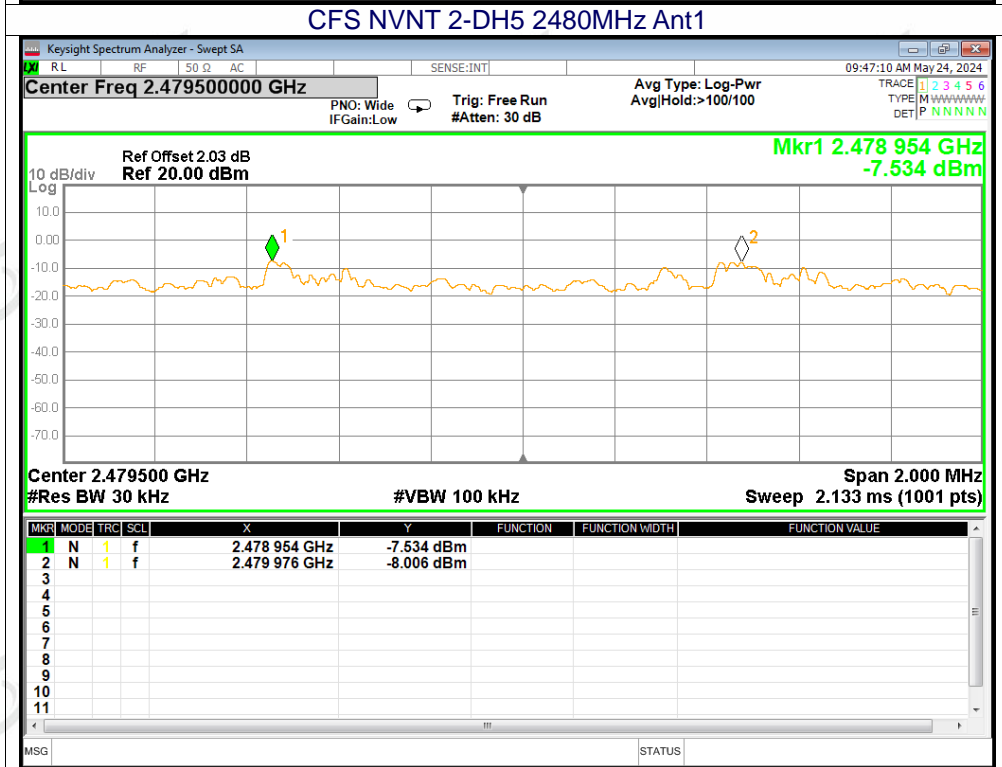



CFS NVNT 3-DH5 2402MHz Ant1

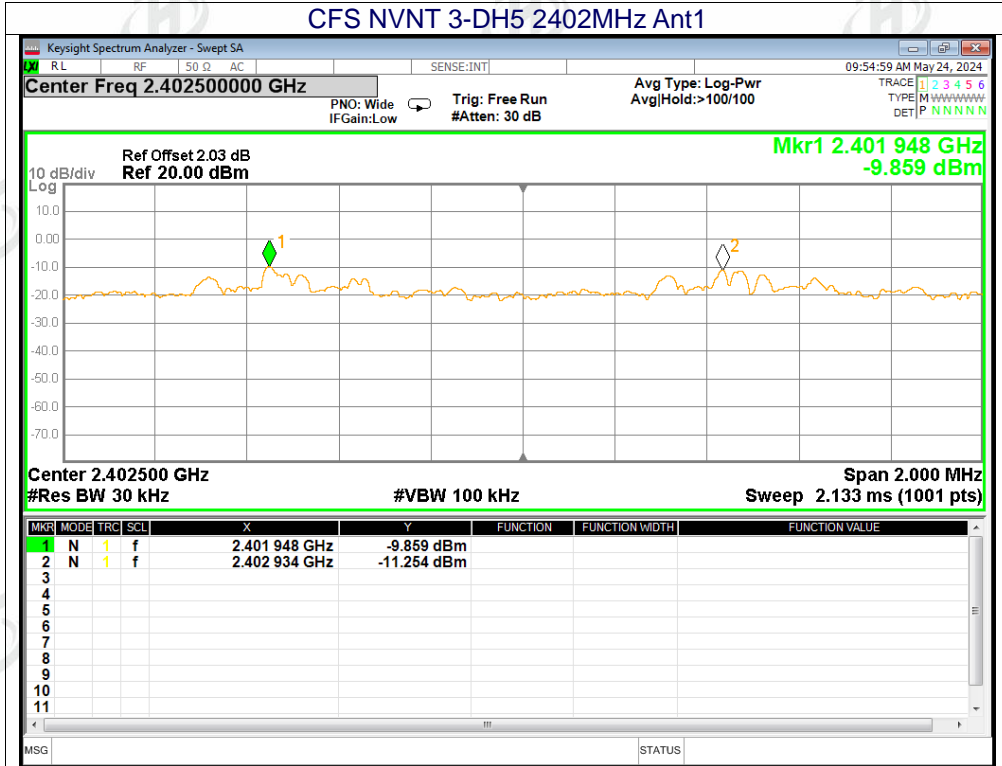

CFS NVNT 3-DH5 2441MHz Ant1

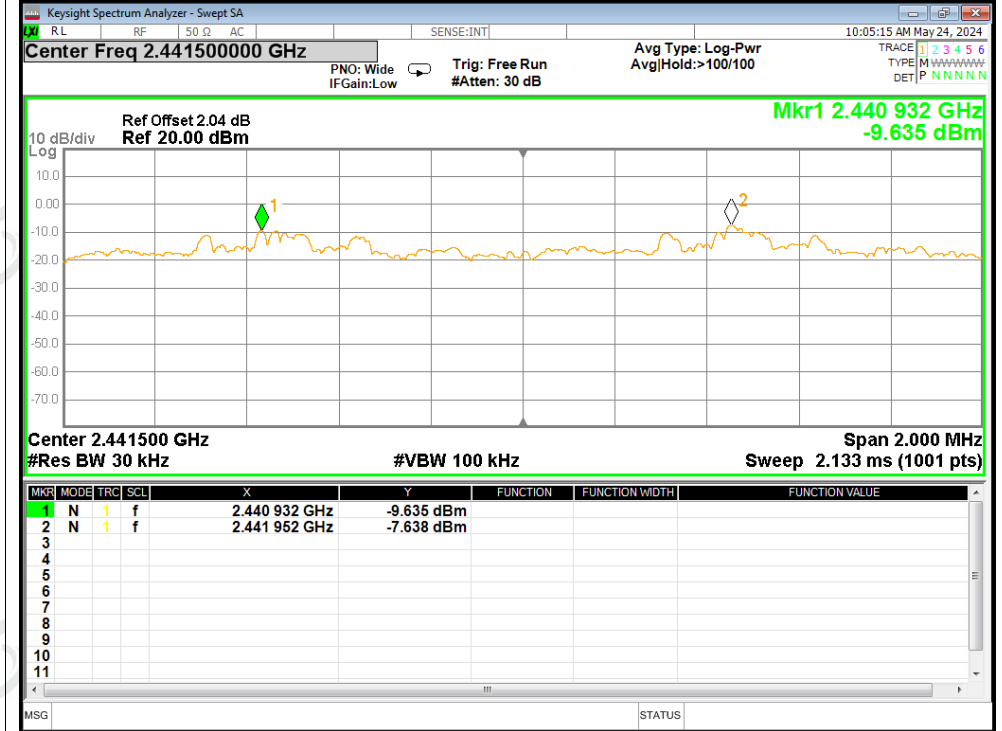

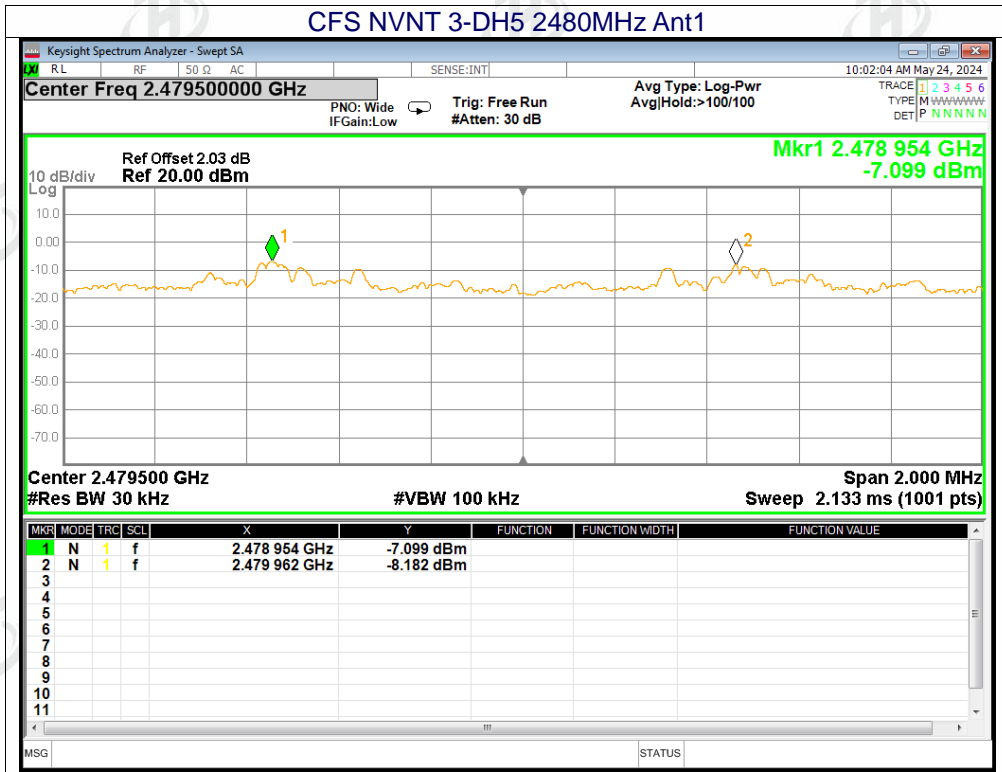



13.6 Number of Hopping Channel

| Mode | Hopping Number | Limit | Verdict |
|-------|----------------|-------|---------|
| 1-DH5 | 79 | 15 | Pass |
| 2-DH5 | 79 | 15 | Pass |
| 3-DH5 | 79 | 15 | Pass |

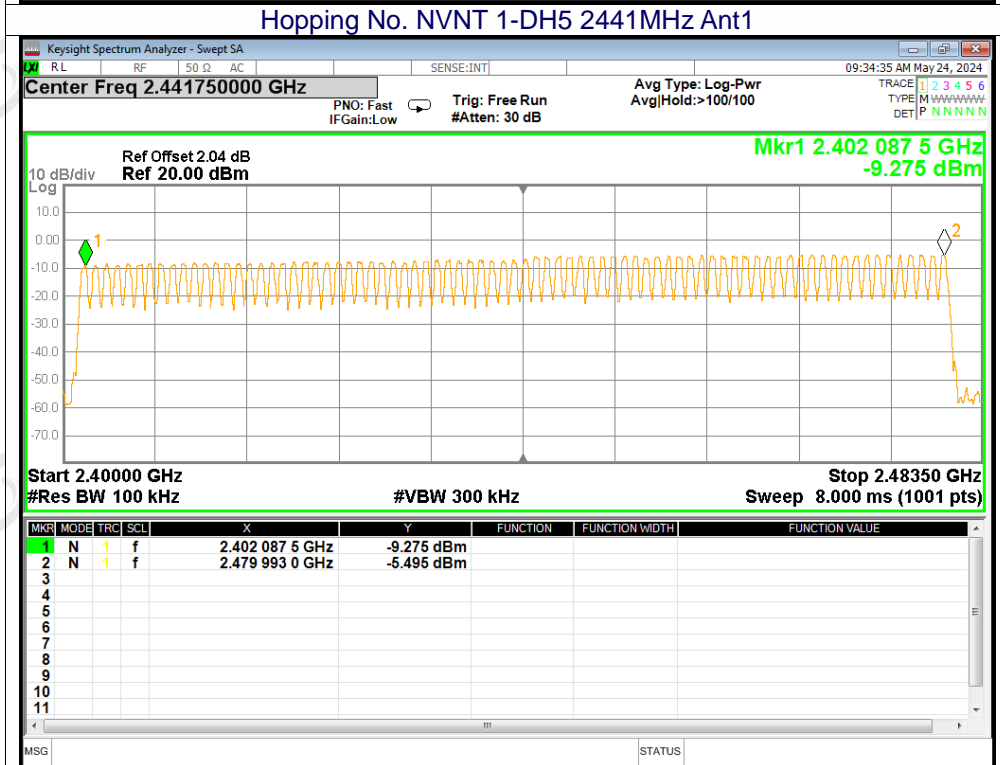
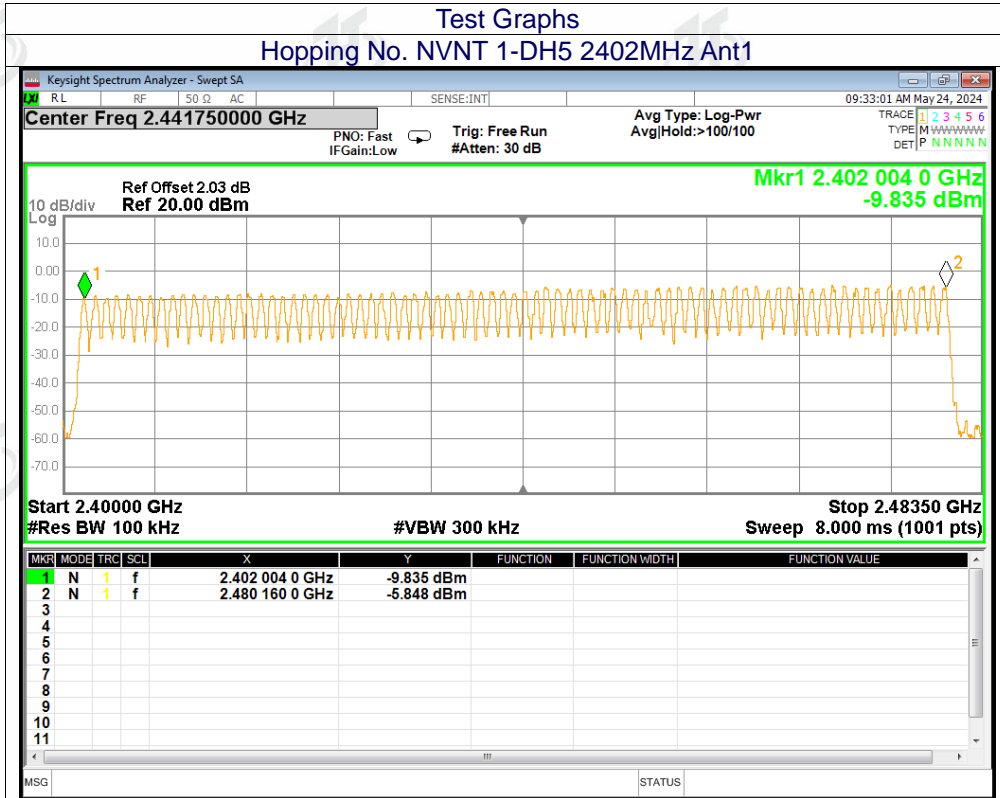

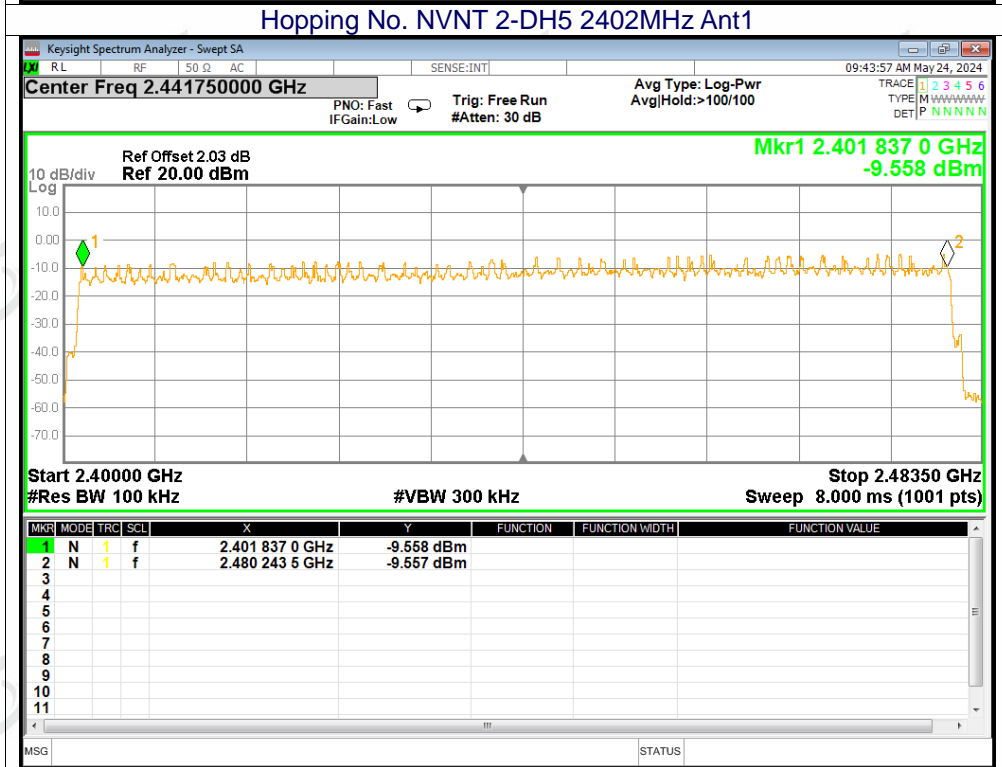
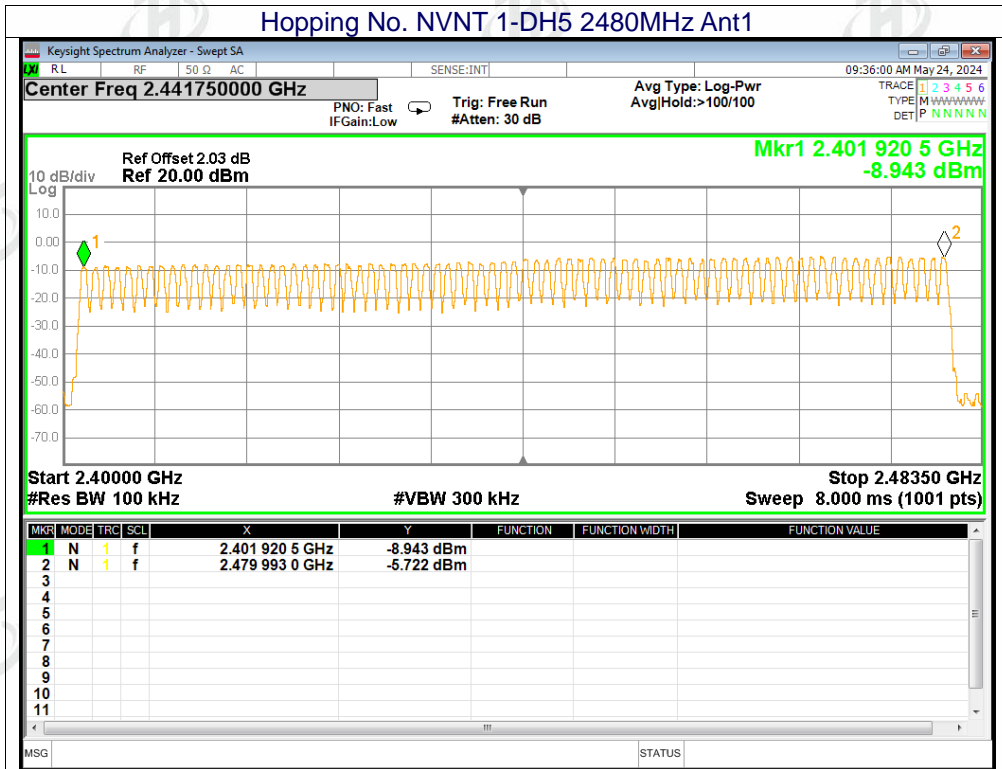



Hopping No. NVNT 2-DH5 2441MHz Ant1

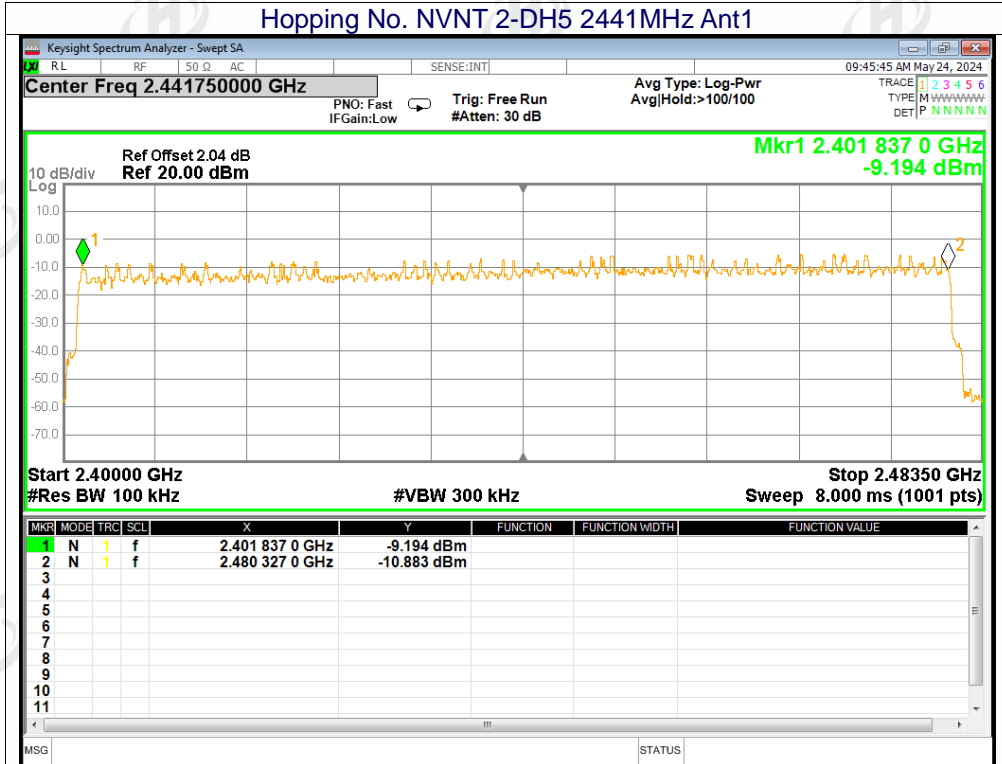

Hopping No. NVNT 2-DH5 2480MHz Ant1

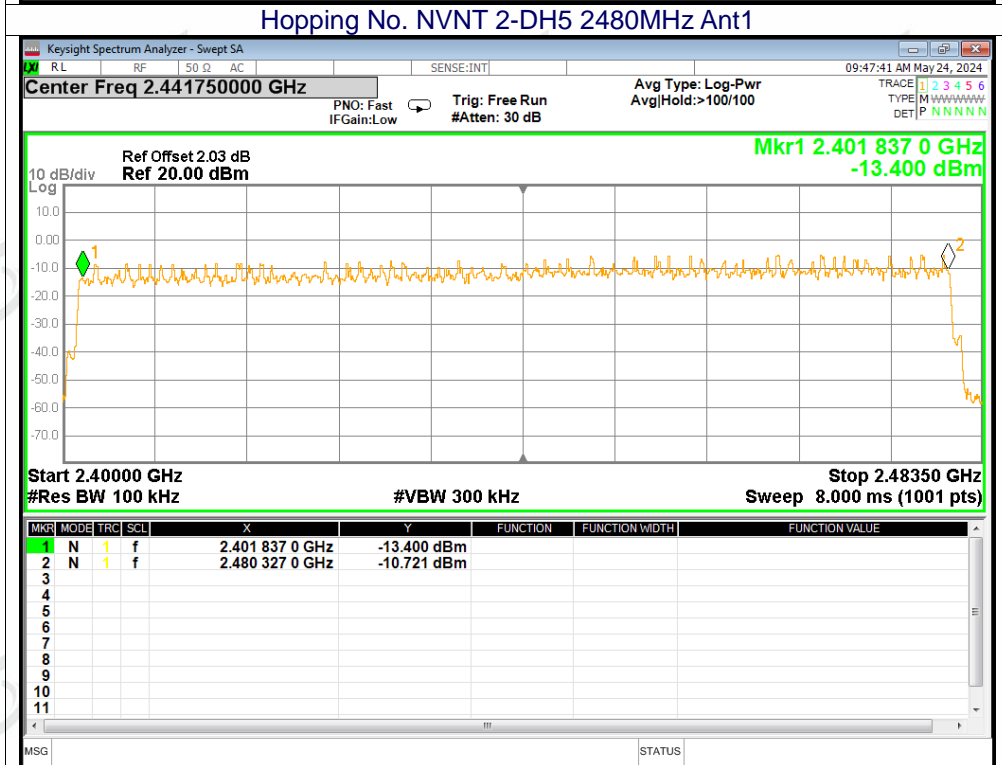

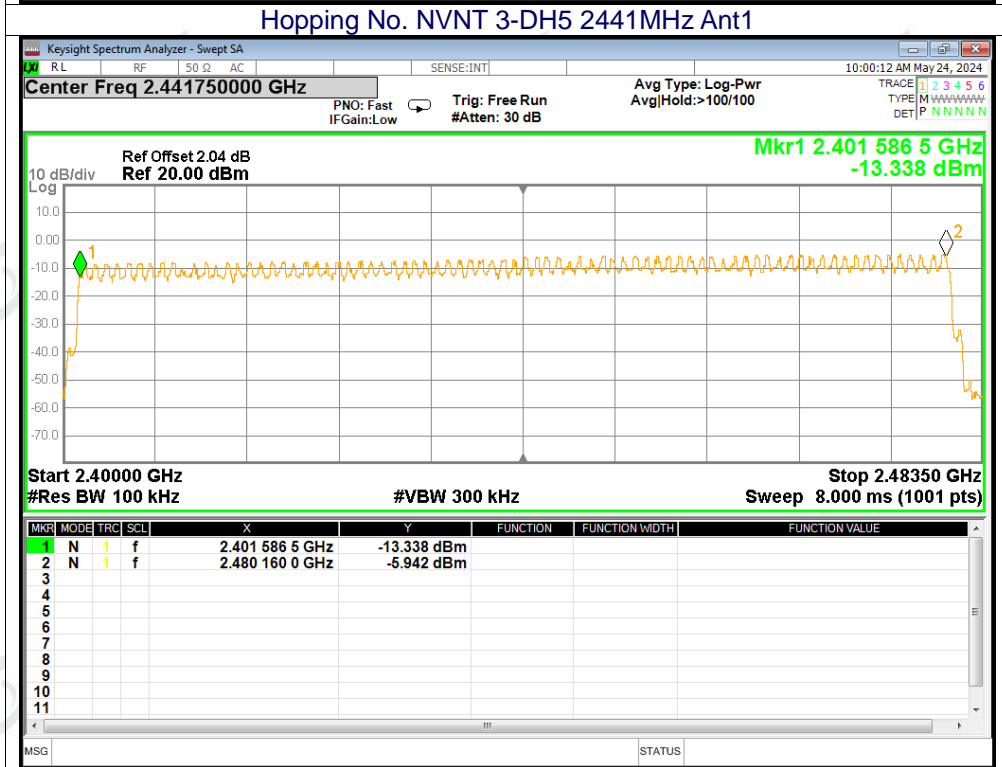
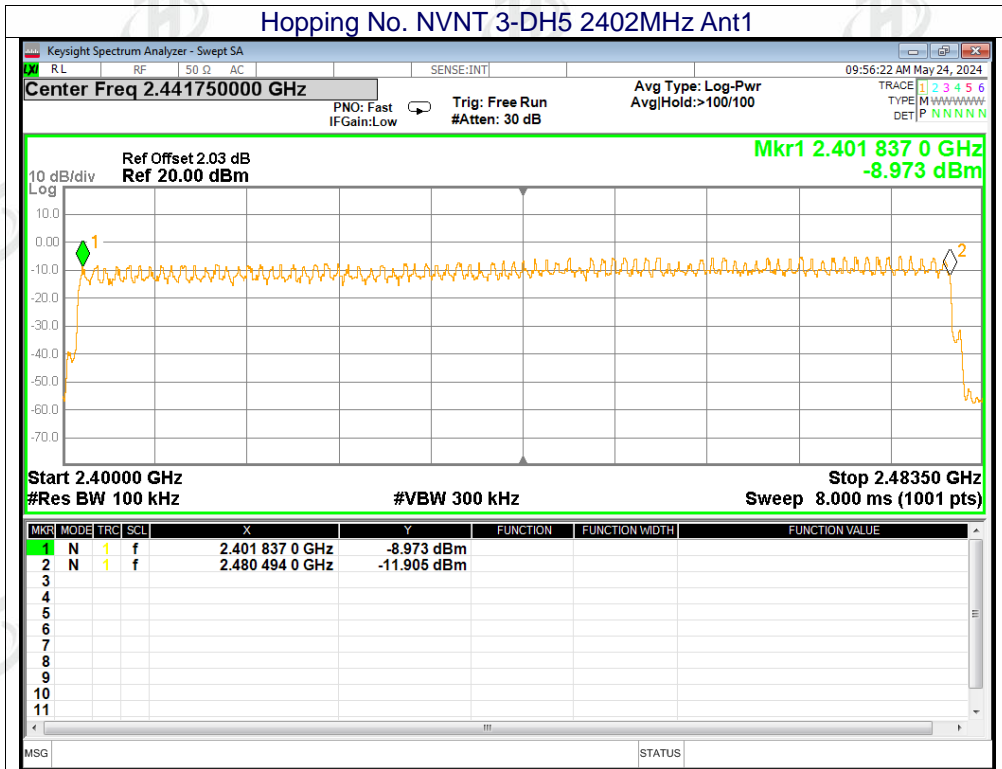

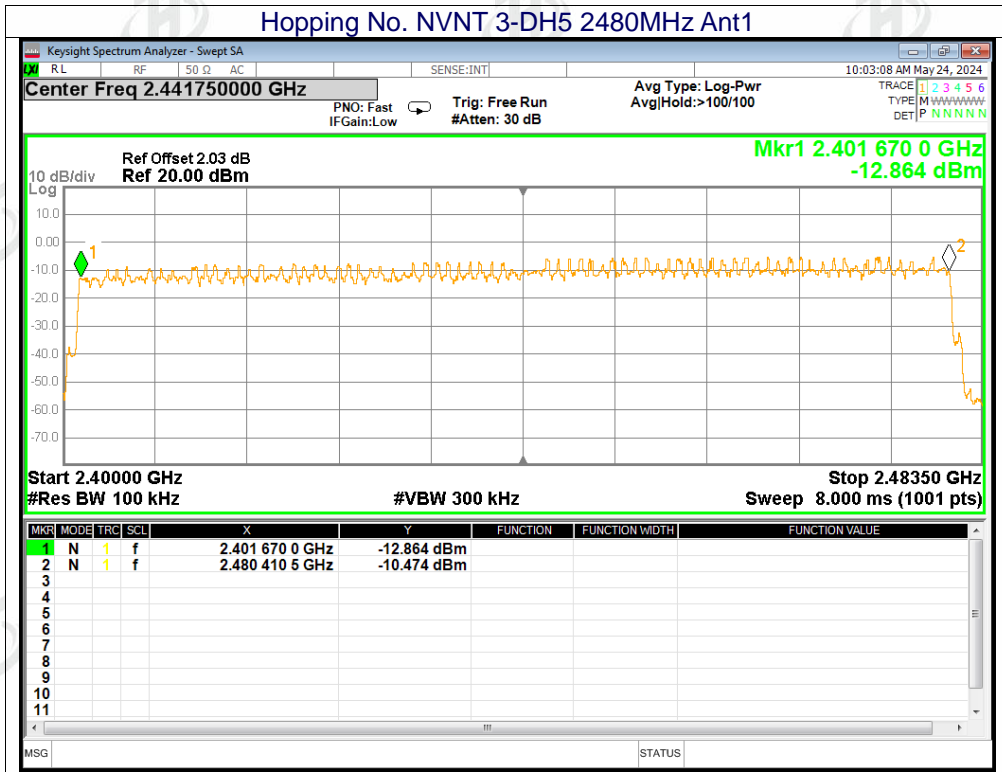



13.7 Band Edge

| Mode | Frequency (MHz) | Hopping Mode | Max Value (dBc) | Limit (dBc) | Verdict |
|-------|-----------------|--------------|-----------------|-------------|---------|
| 1-DH5 | 2402 | No-Hopping | -44.78 | -20 | Pass |
| 1-DH5 | 2480 | No-Hopping | -52.27 | -20 | Pass |
| 2-DH5 | 2402 | No-Hopping | -43.87 | -20 | Pass |
| 2-DH5 | 2480 | No-Hopping | -51 | -20 | Pass |
| 3-DH5 | 2402 | No-Hopping | -45.01 | -20 | Pass |
| 3-DH5 | 2480 | No-Hopping | -50.1 | -20 | Pass |

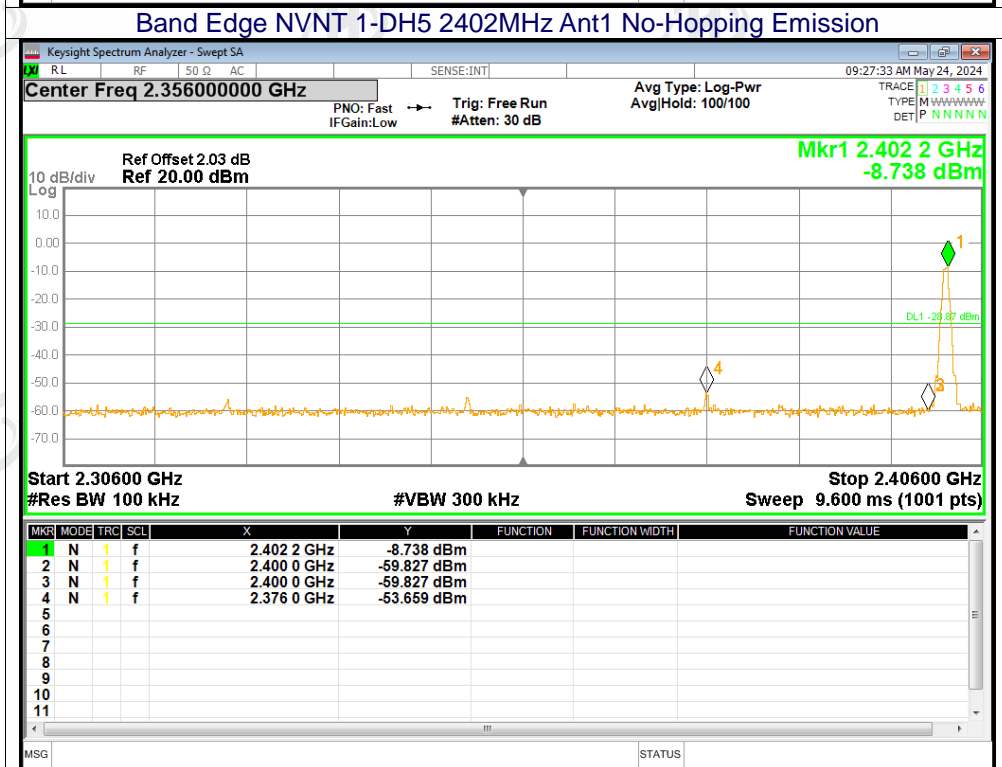
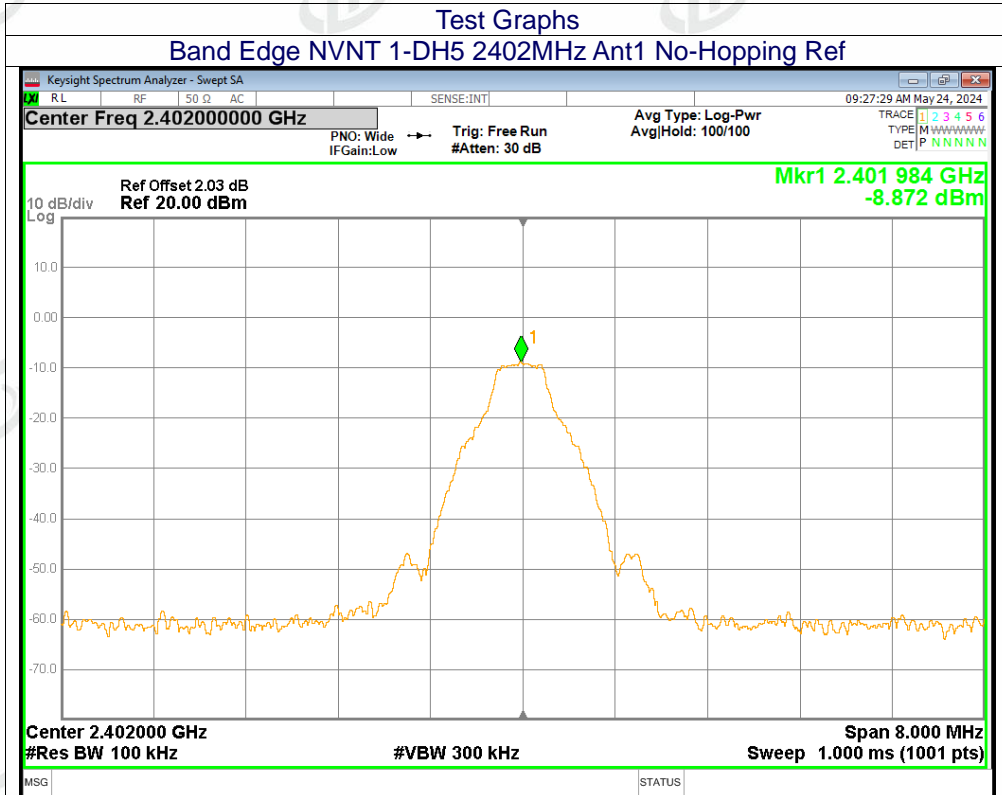

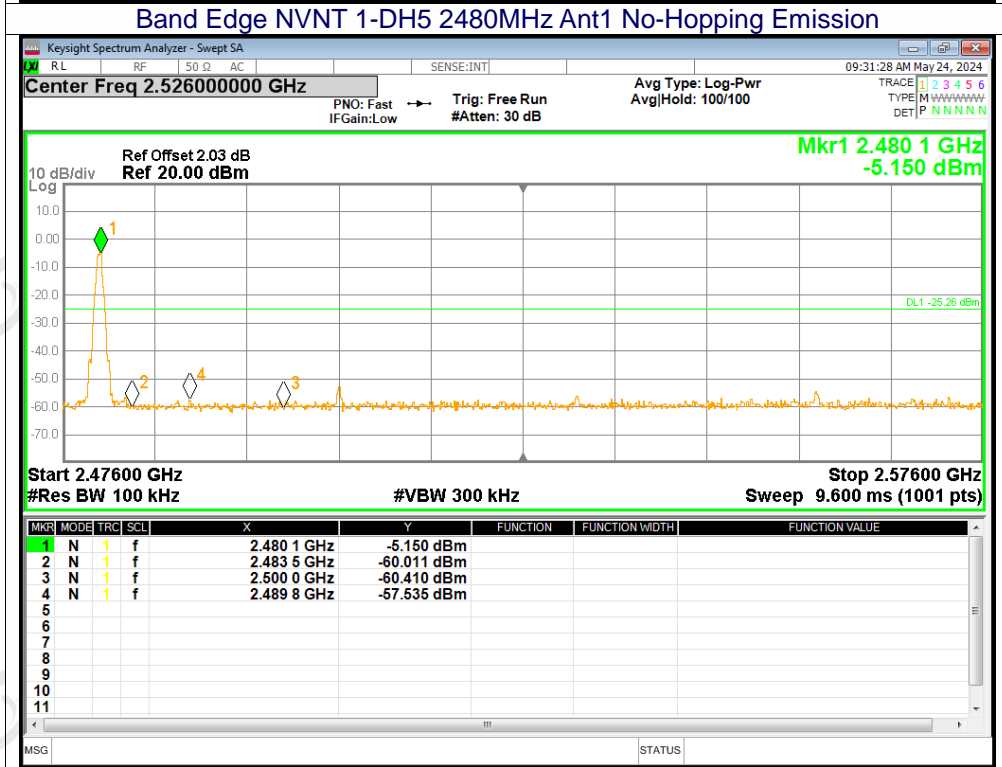
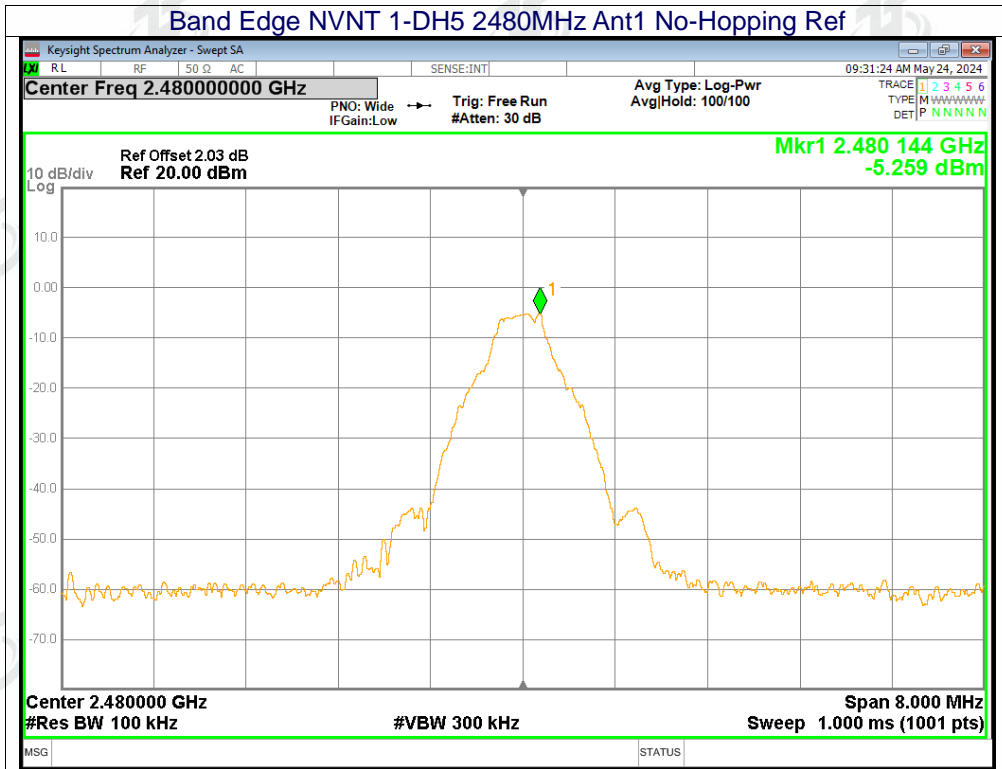

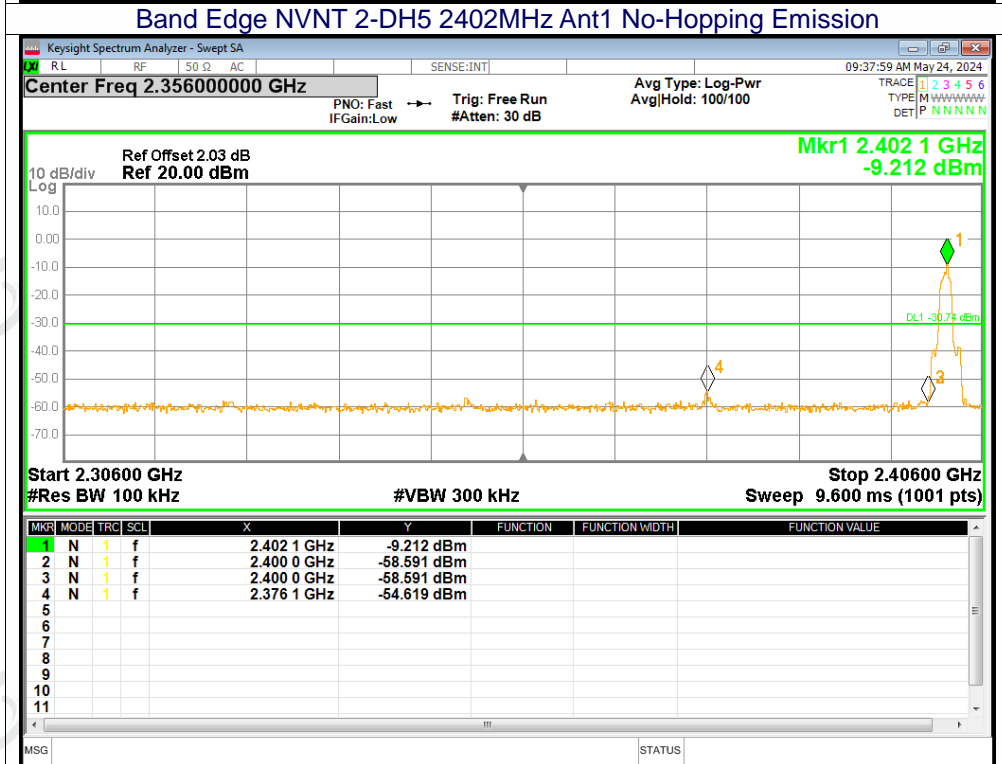
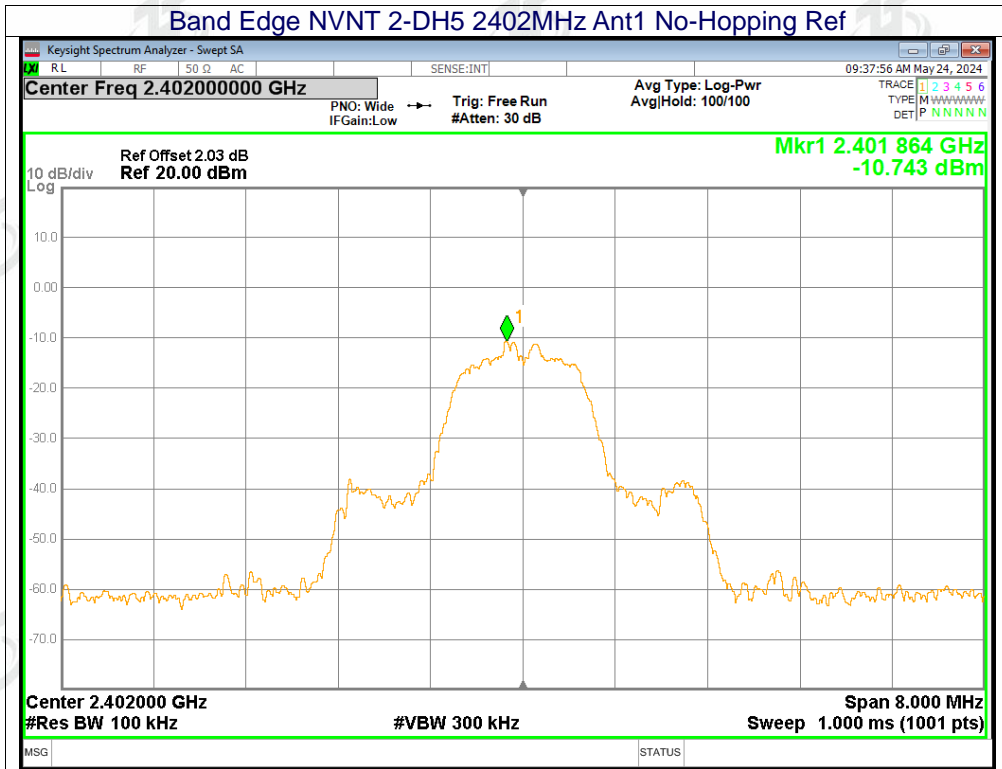

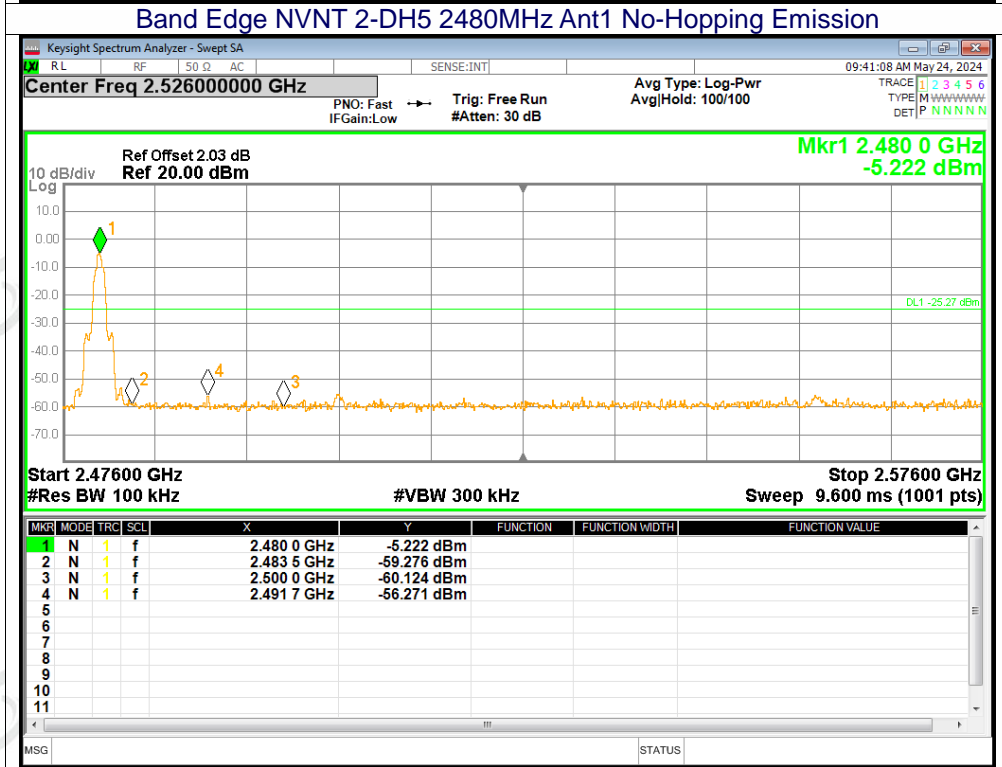
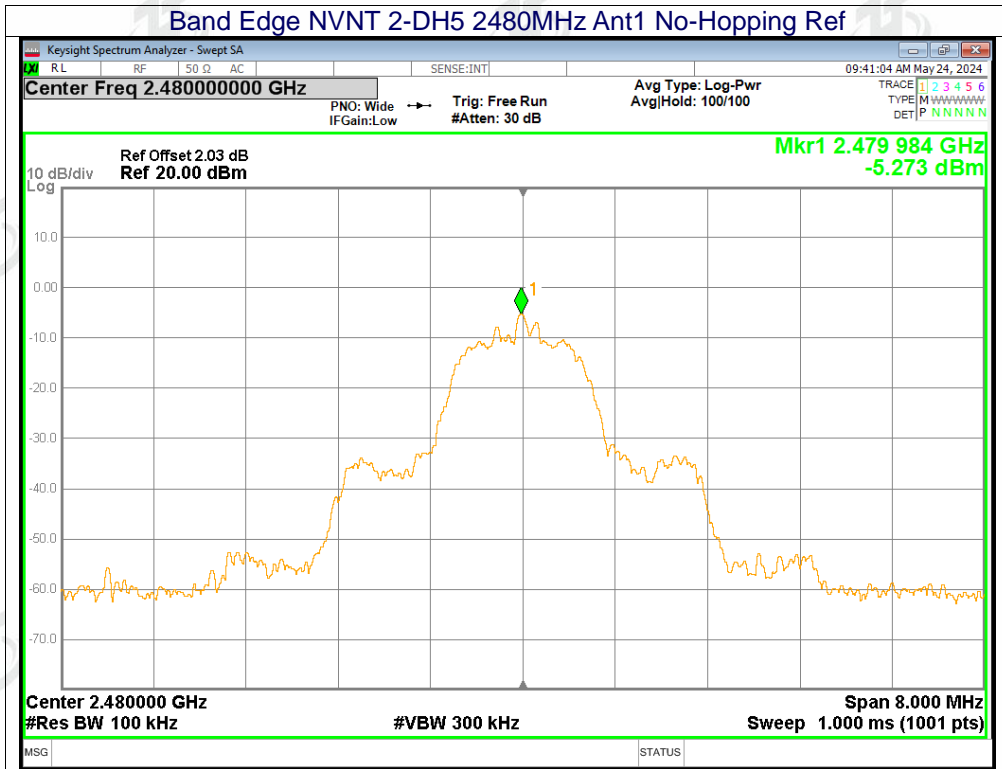

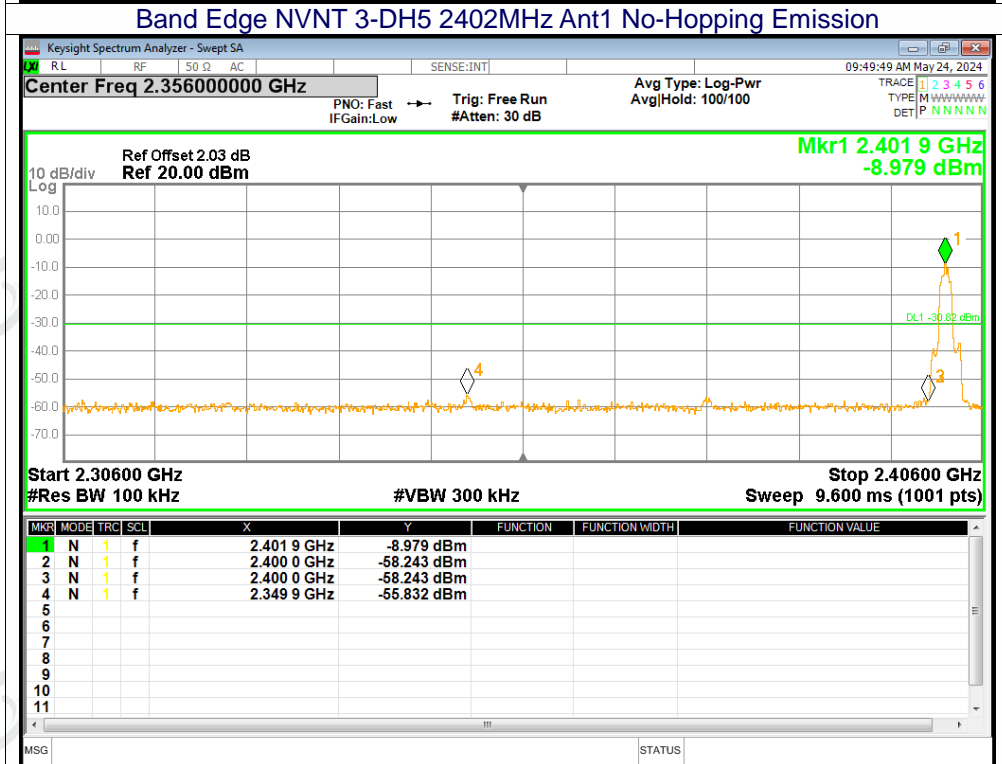
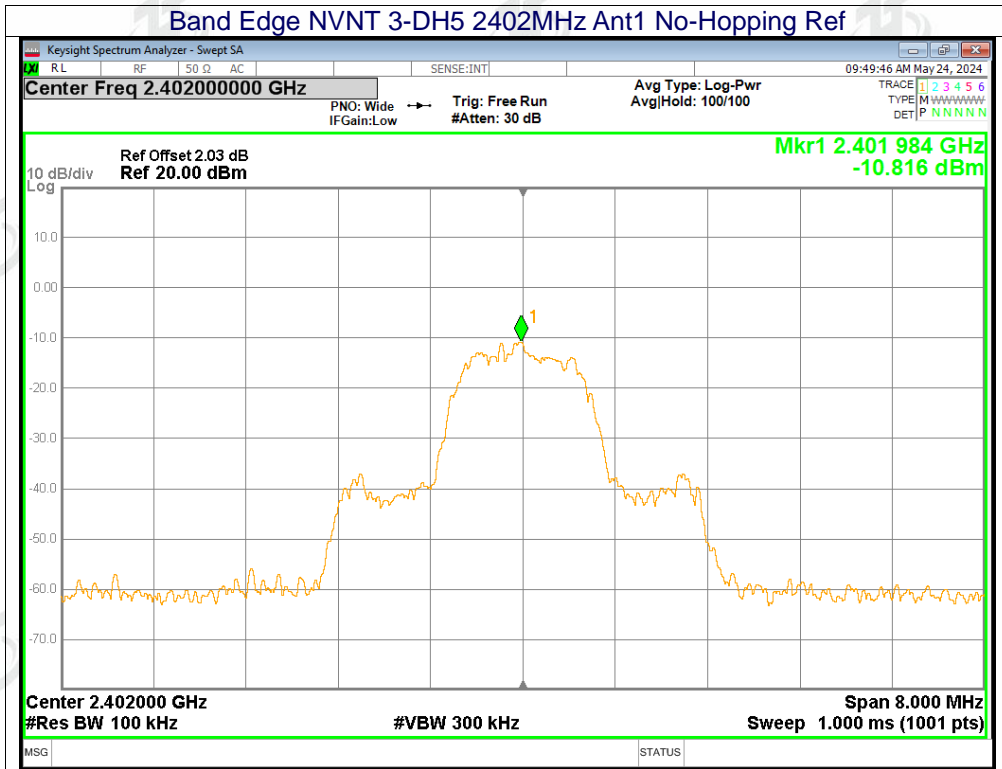

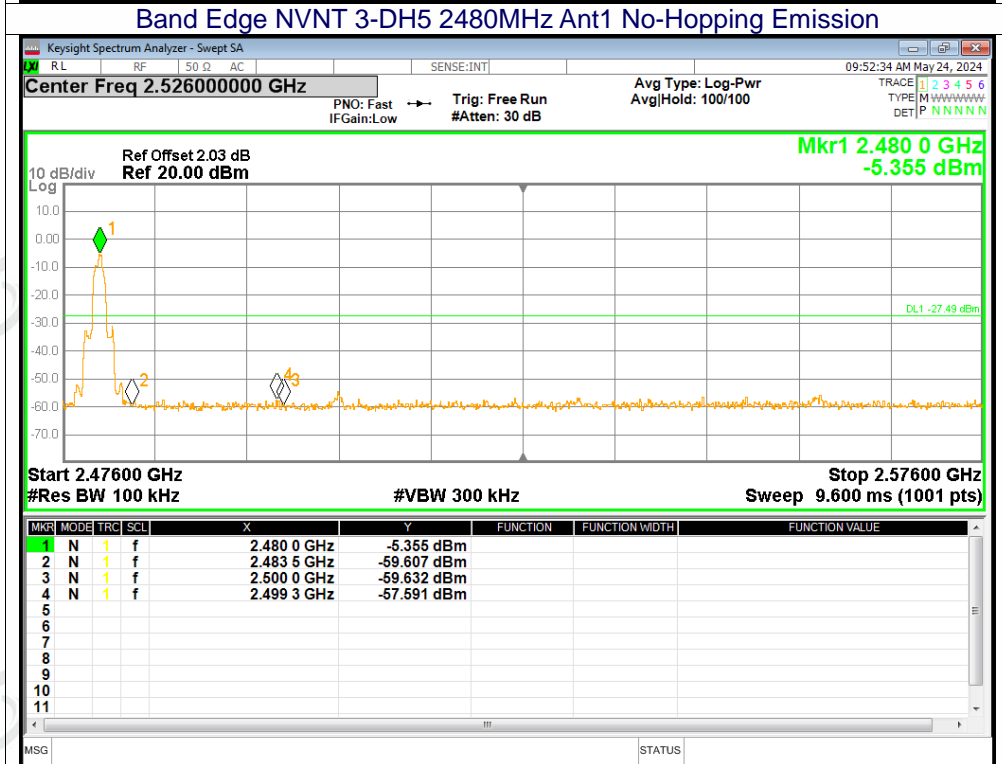
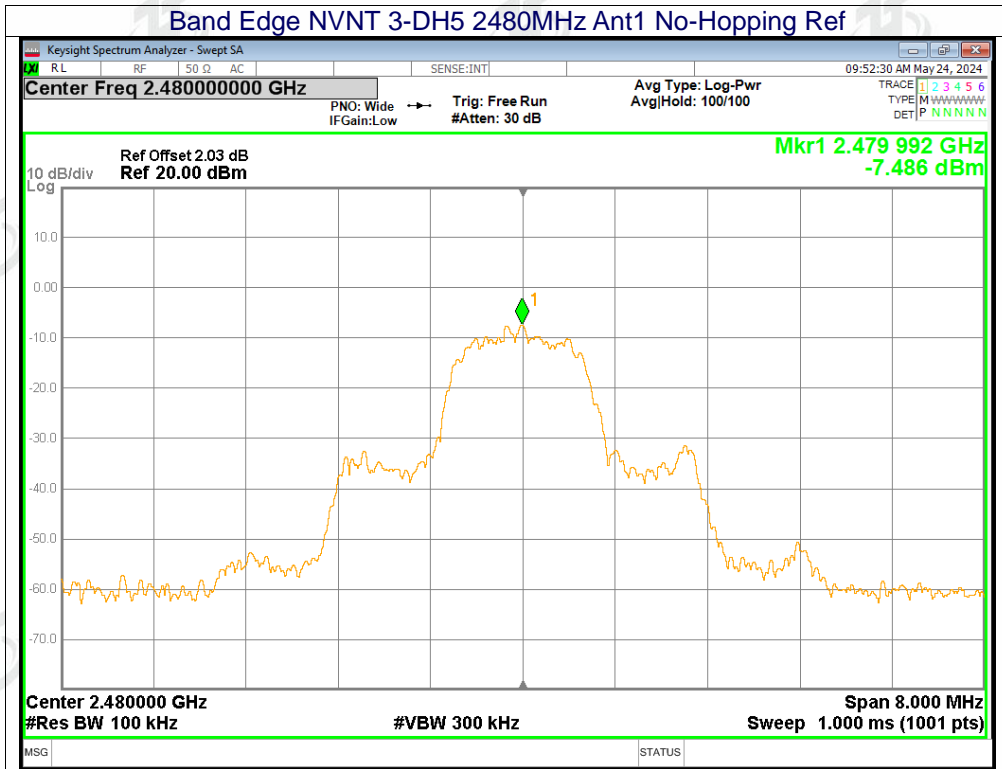



13.8 Band Edge(Hopping)

| Mode | Frequency (MHz) | Hopping Mode | Max Value (dBc) | Limit (dBc) | Verdict |
|-------|-----------------|--------------|-----------------|-------------|---------|
| 1-DH5 | 2402 | Hopping | -44.73 | -20 | Pass |
| 1-DH5 | 2480 | Hopping | -47.68 | -20 | Pass |
| 2-DH5 | 2402 | Hopping | -45.13 | -20 | Pass |
| 2-DH5 | 2480 | Hopping | -48.53 | -20 | Pass |
| 3-DH5 | 2402 | Hopping | -47.22 | -20 | Pass |
| 3-DH5 | 2480 | Hopping | -47.94 | -20 | Pass |

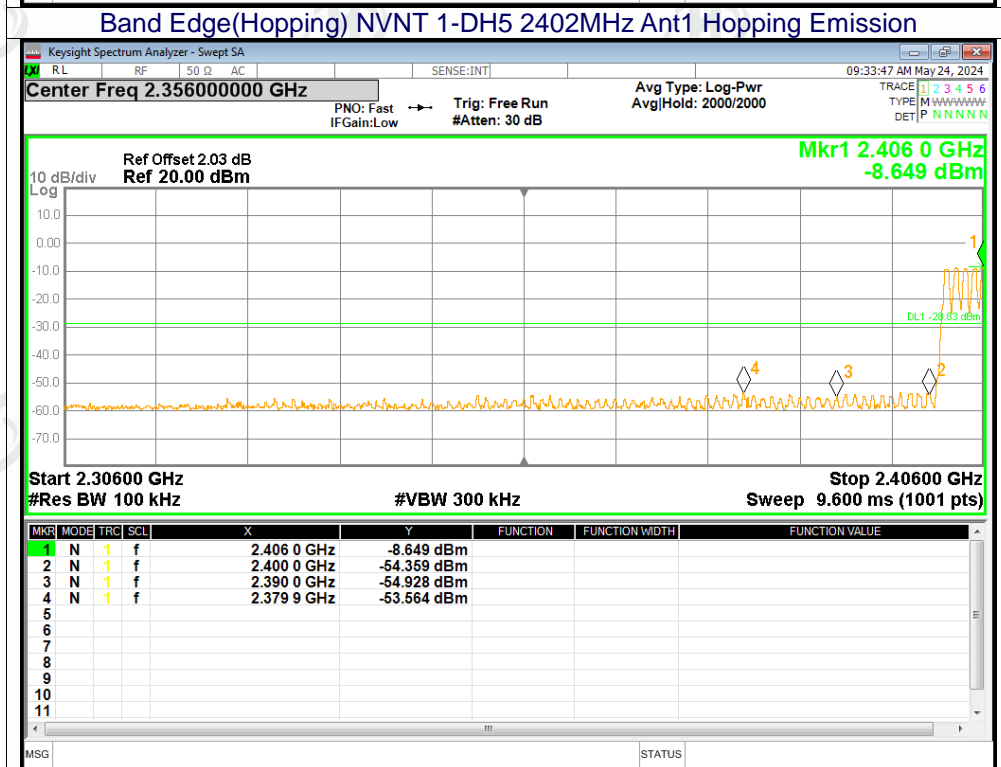
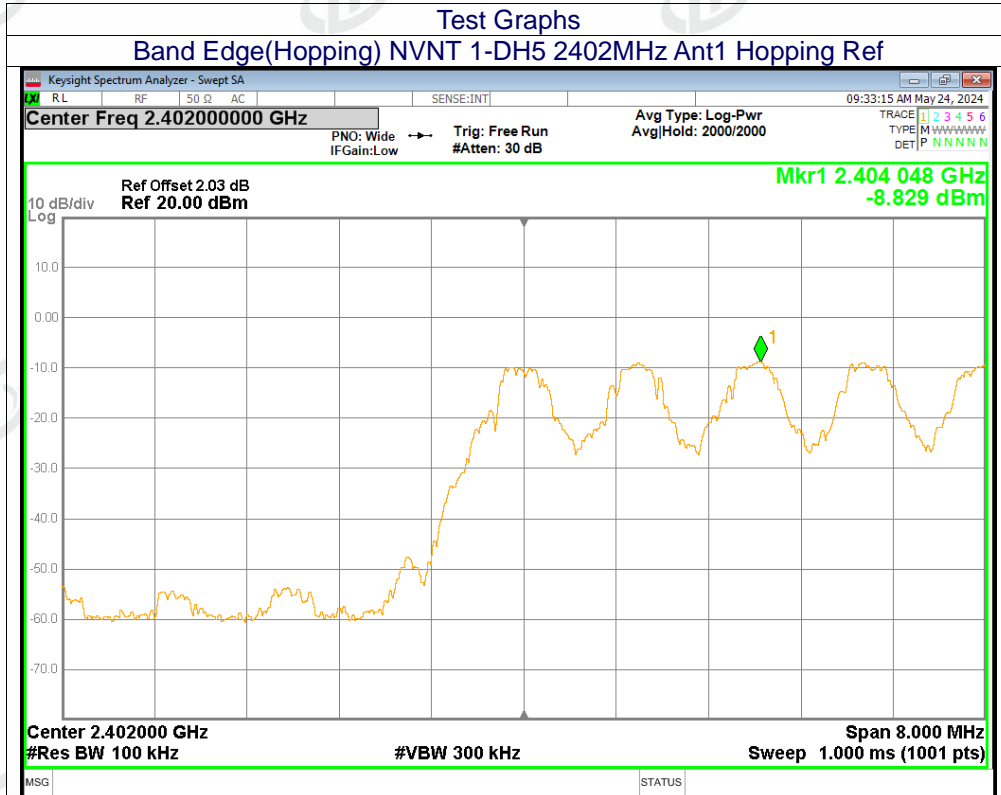



Band Edge(Hopping) NVNT 1-DH5 2480MHz Ant1 Hopping Ref

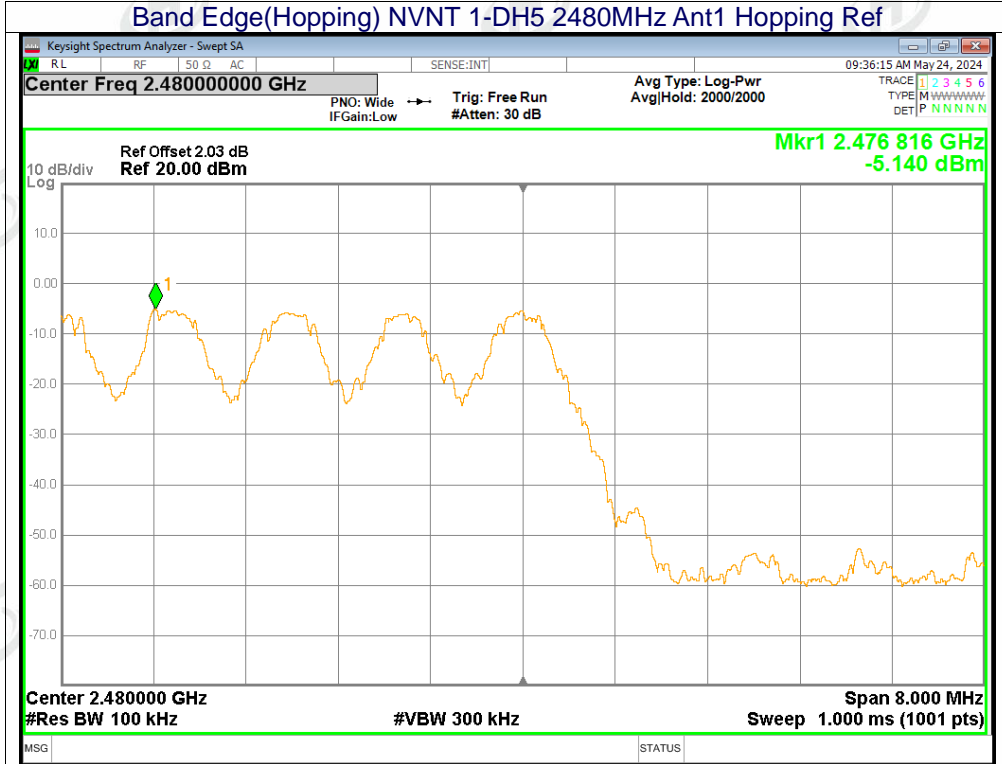

Band Edge(Hopping) NVNT 1-DH5 2480MHz Ant1 Hopping Emission

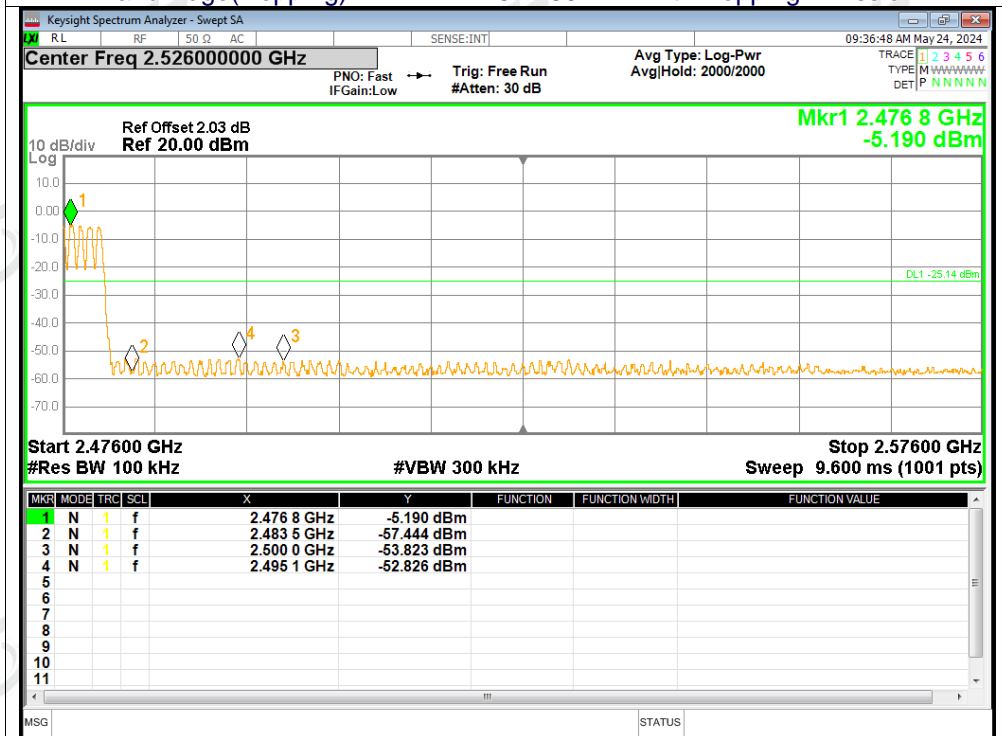

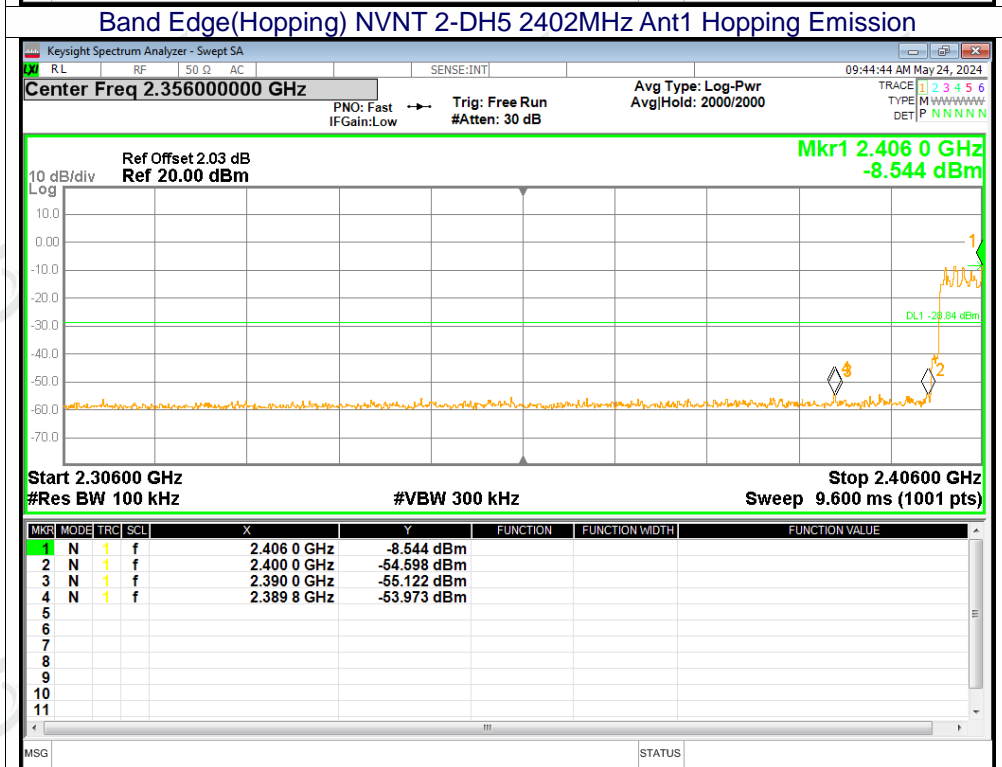
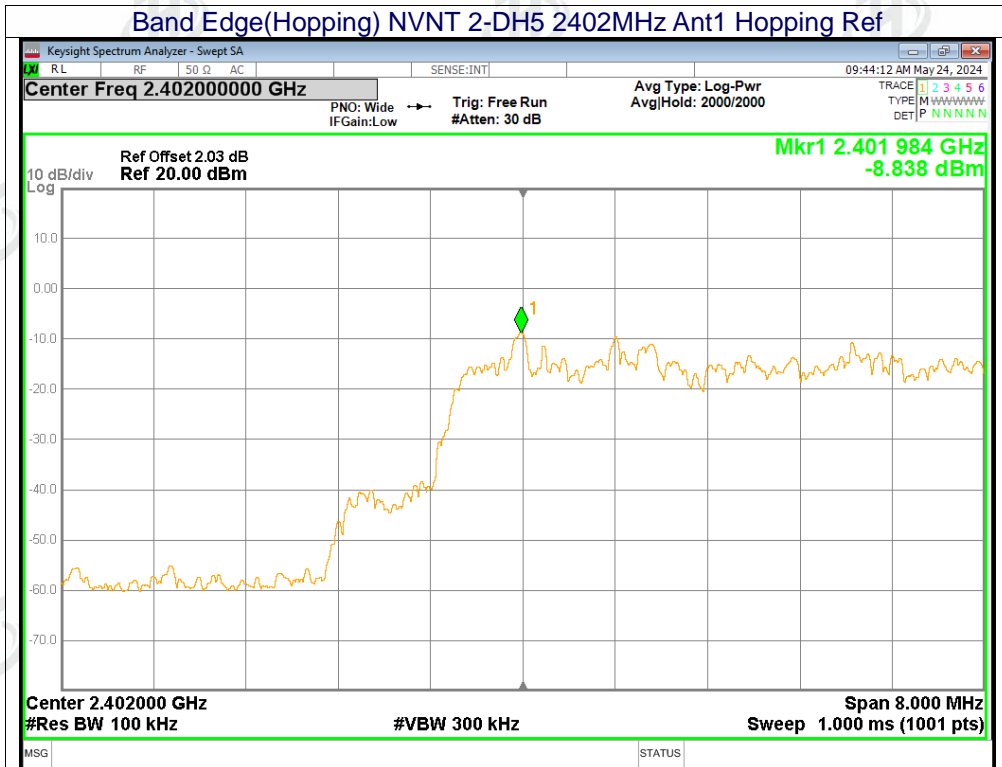

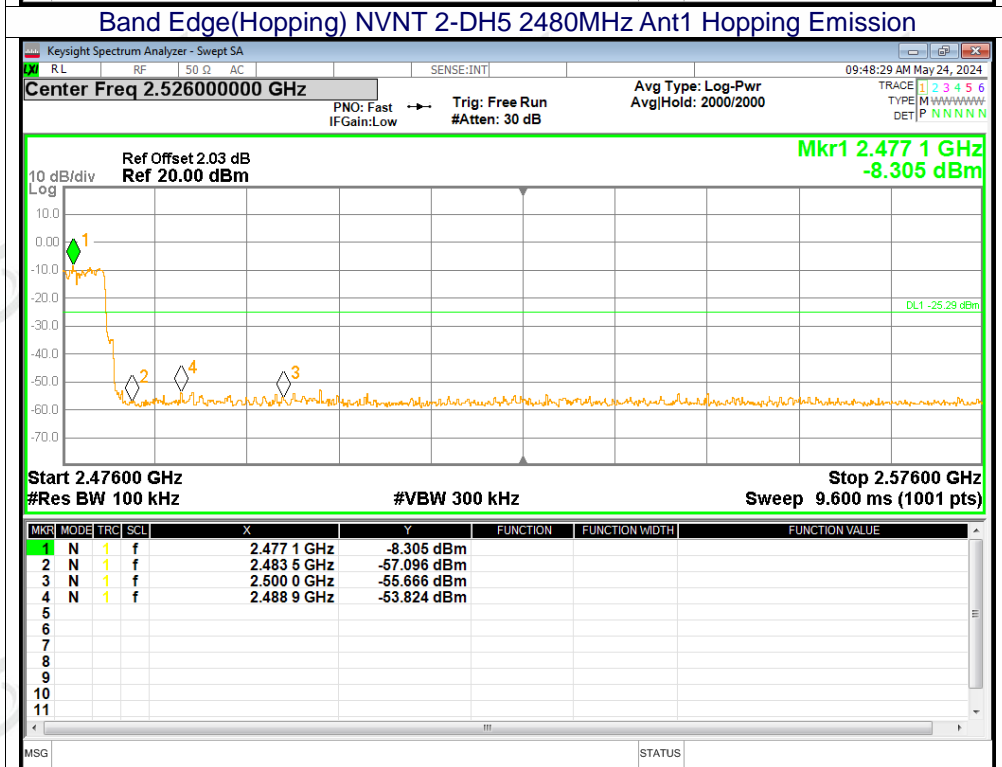
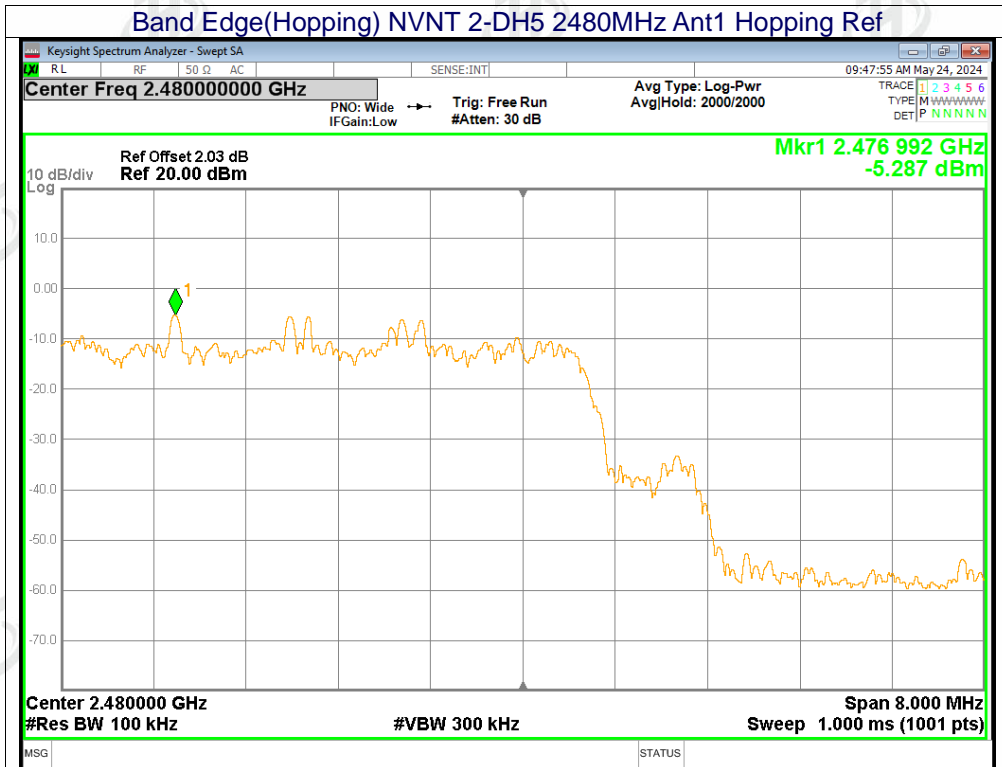

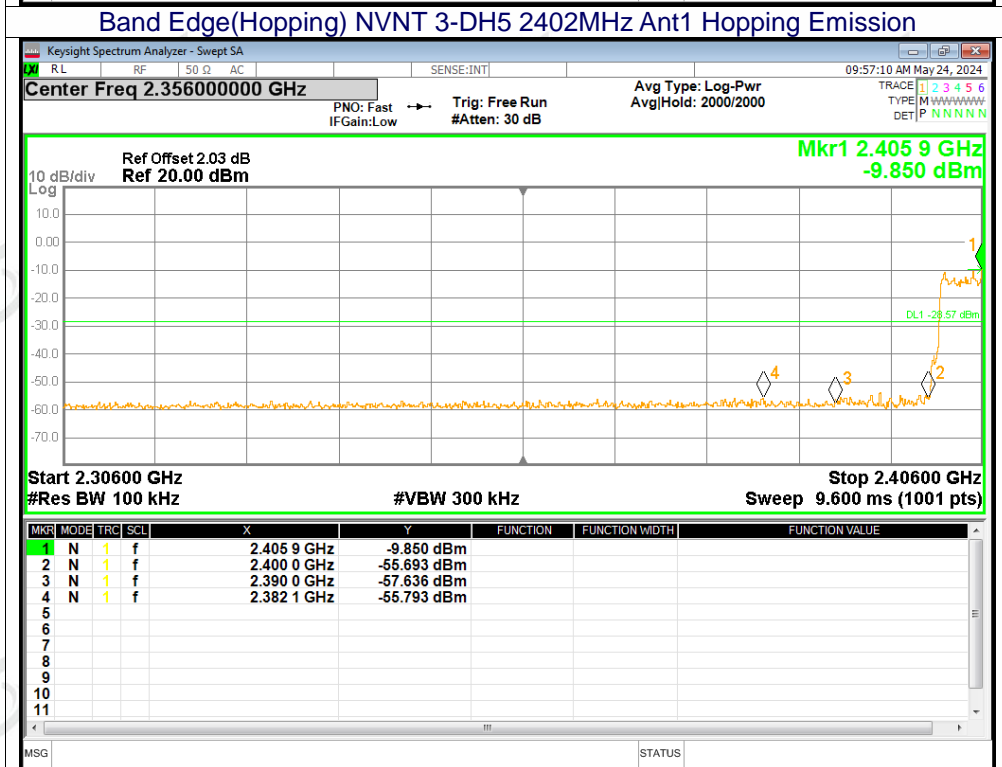
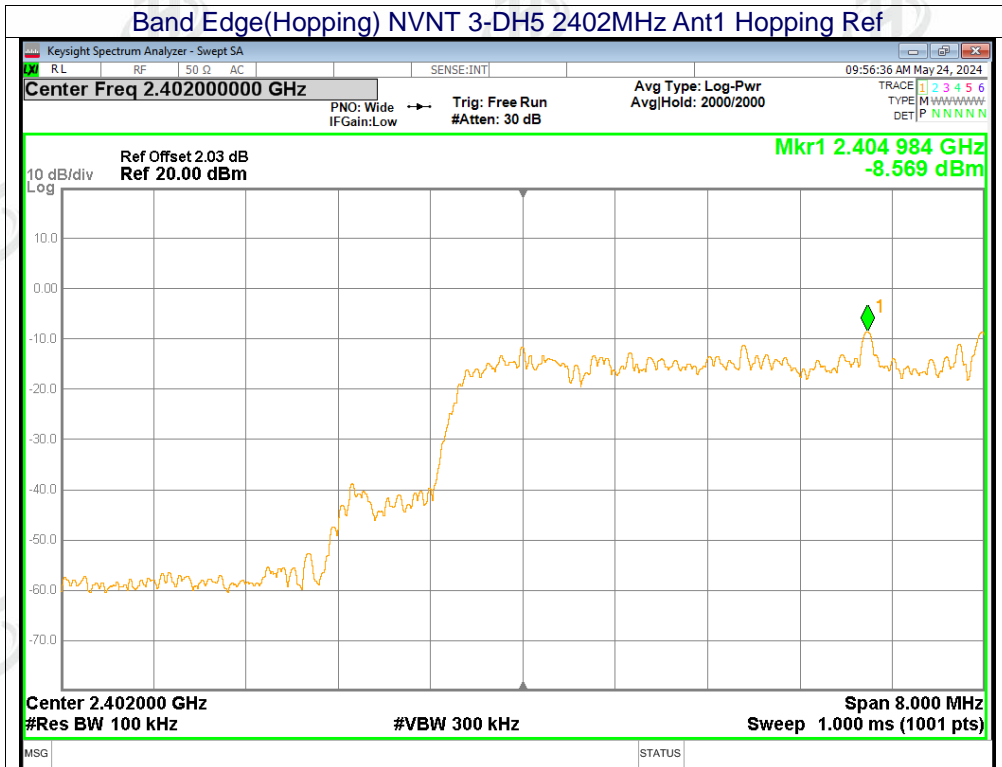

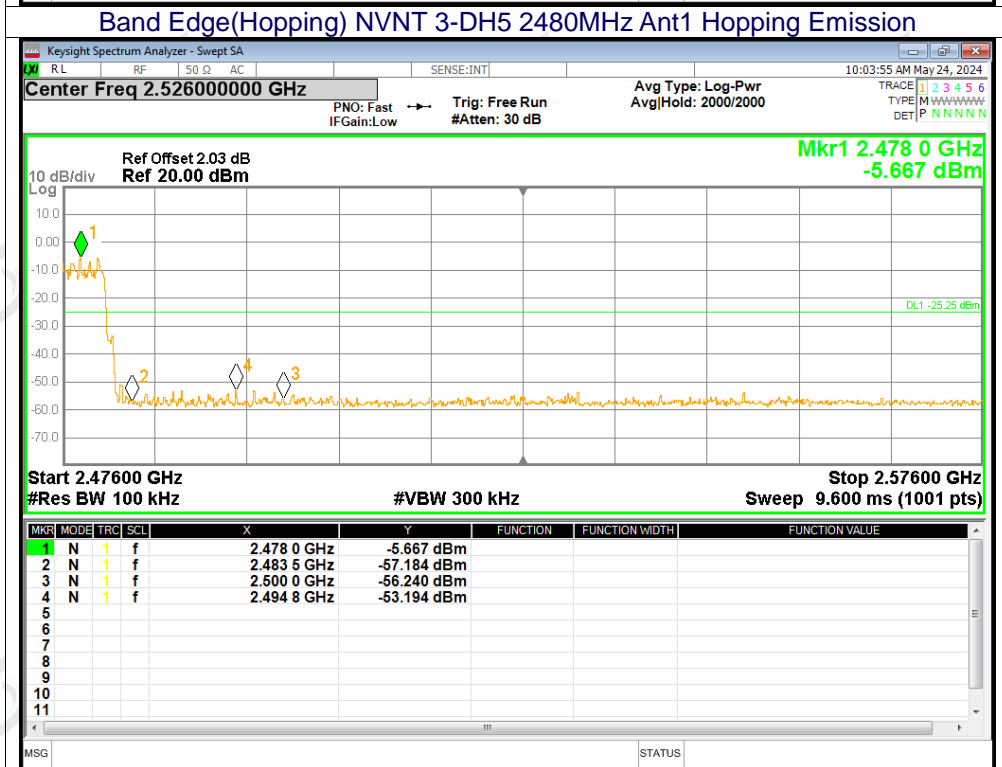
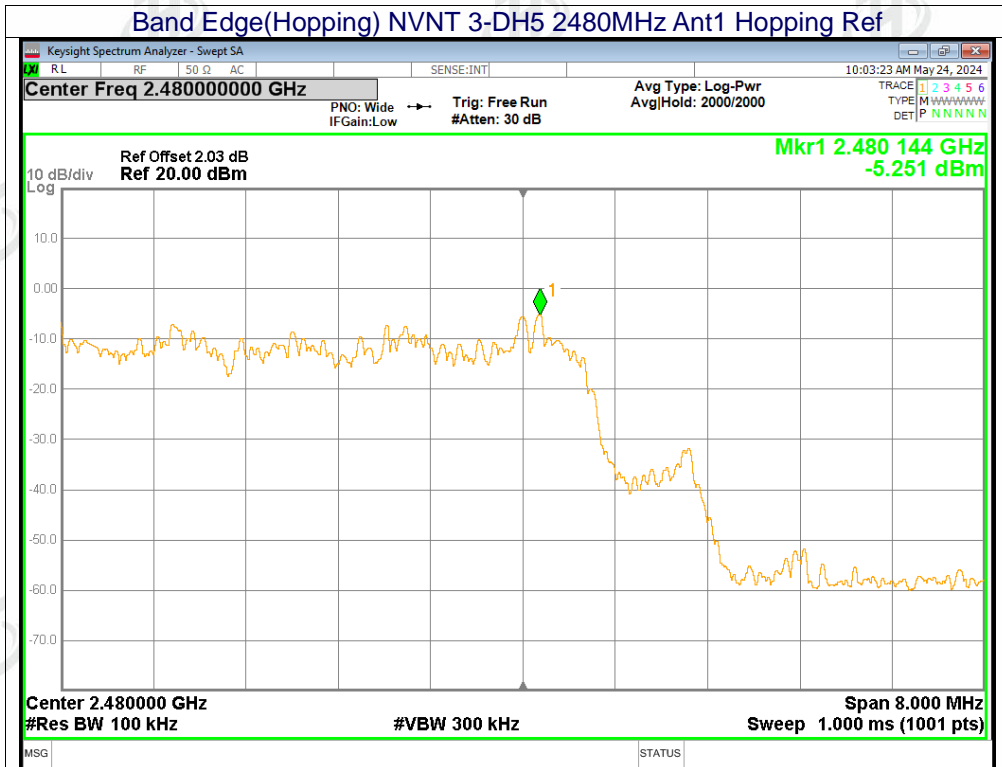



13.9 Conducted RF Spurious Emission

| Mode | Frequency (MHz) | Max Value (dBc) | Limit (dBc) | Verdict |
|-------|-----------------|-----------------|-------------|---------|
| 1-DH5 | 2402 | -31.44 | -20 | Pass |
| 1-DH5 | 2441 | -32.35 | -20 | Pass |
| 1-DH5 | 2480 | -33.99 | -20 | Pass |
| 2-DH5 | 2402 | -34.09 | -20 | Pass |
| 2-DH5 | 2441 | -37.95 | -20 | Pass |
| 2-DH5 | 2480 | -39.88 | -20 | Pass |
| 3-DH5 | 2402 | -37.13 | -20 | Pass |
| 3-DH5 | 2441 | -36.89 | -20 | Pass |
| 3-DH5 | 2480 | -36.45 | -20 | Pass |

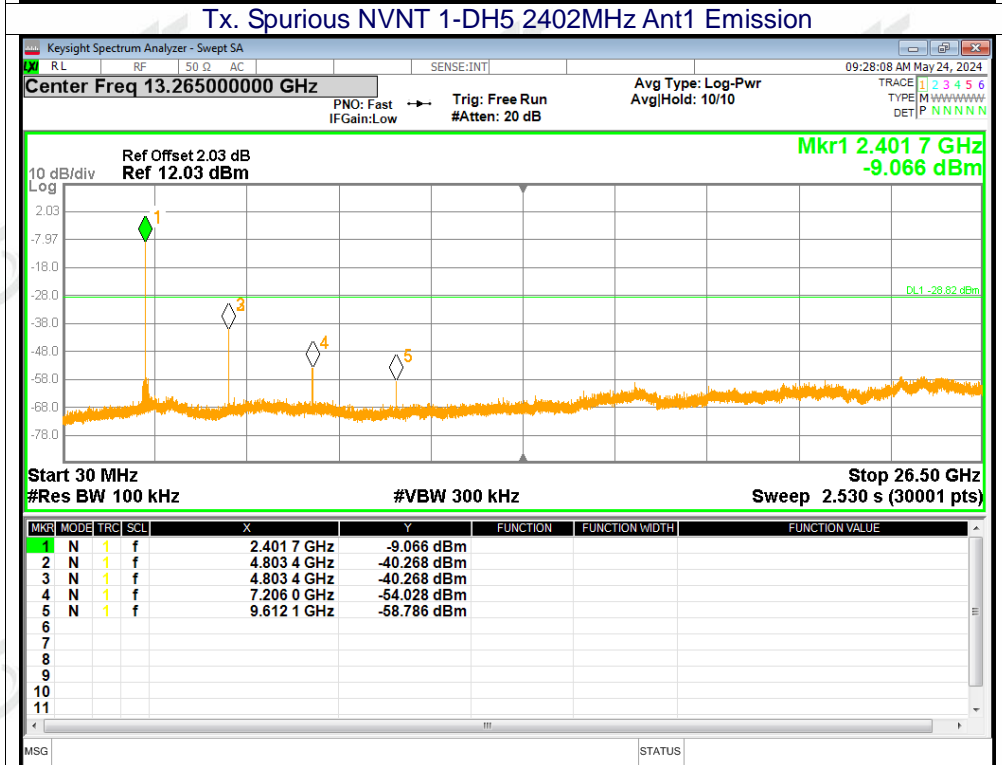
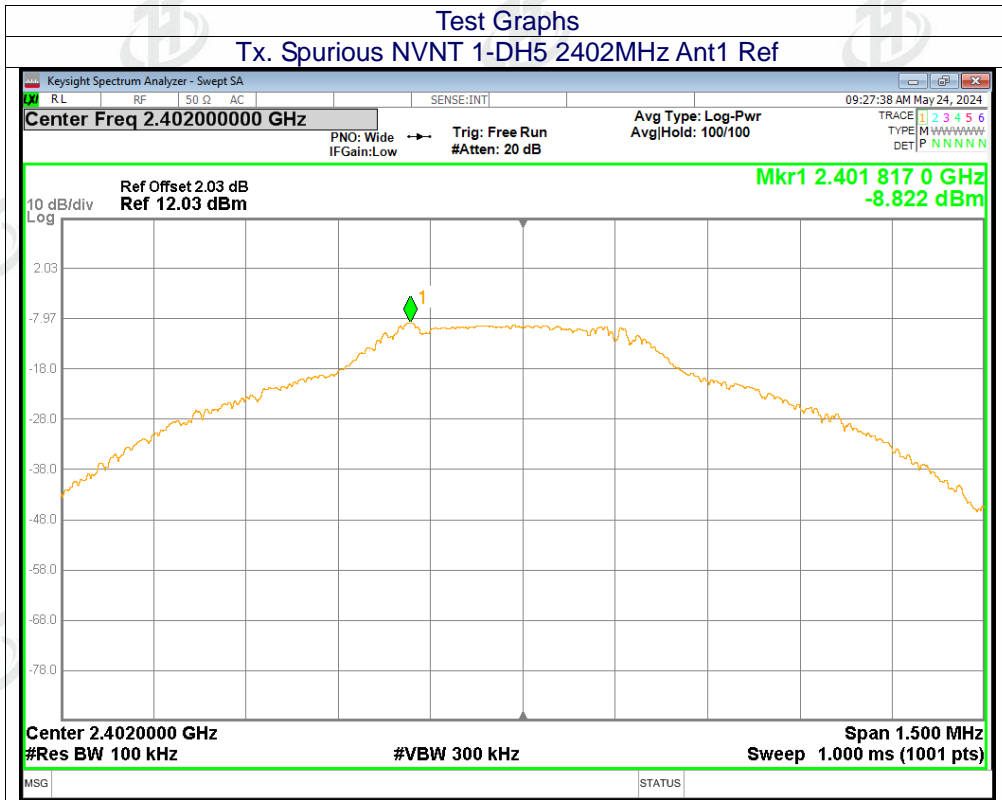

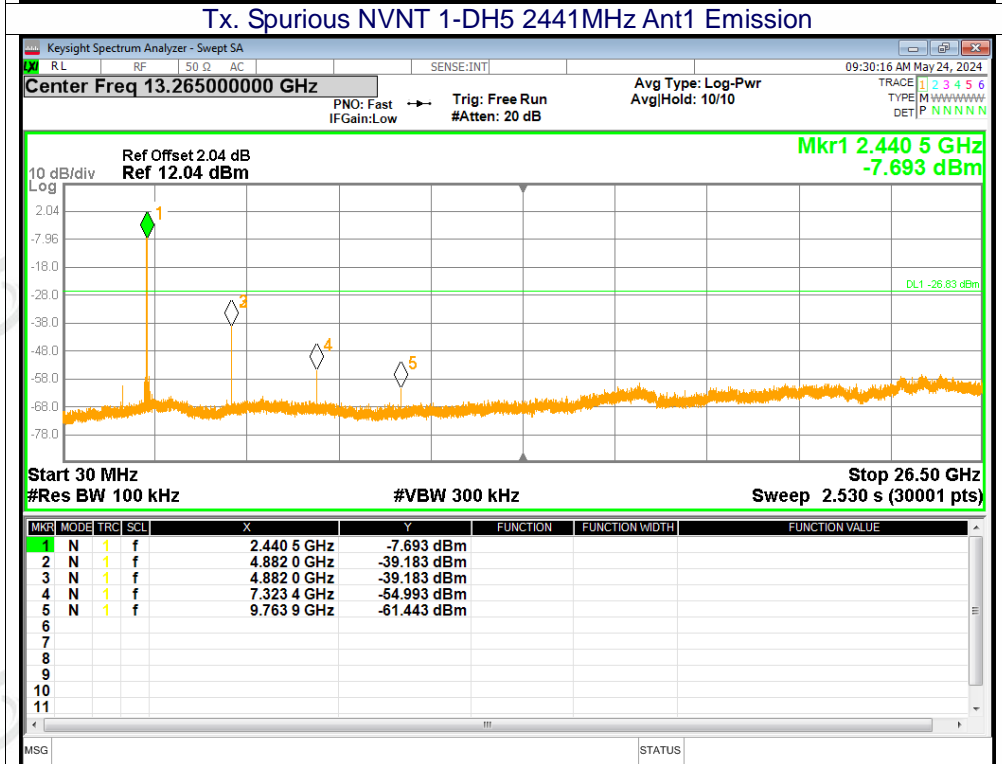
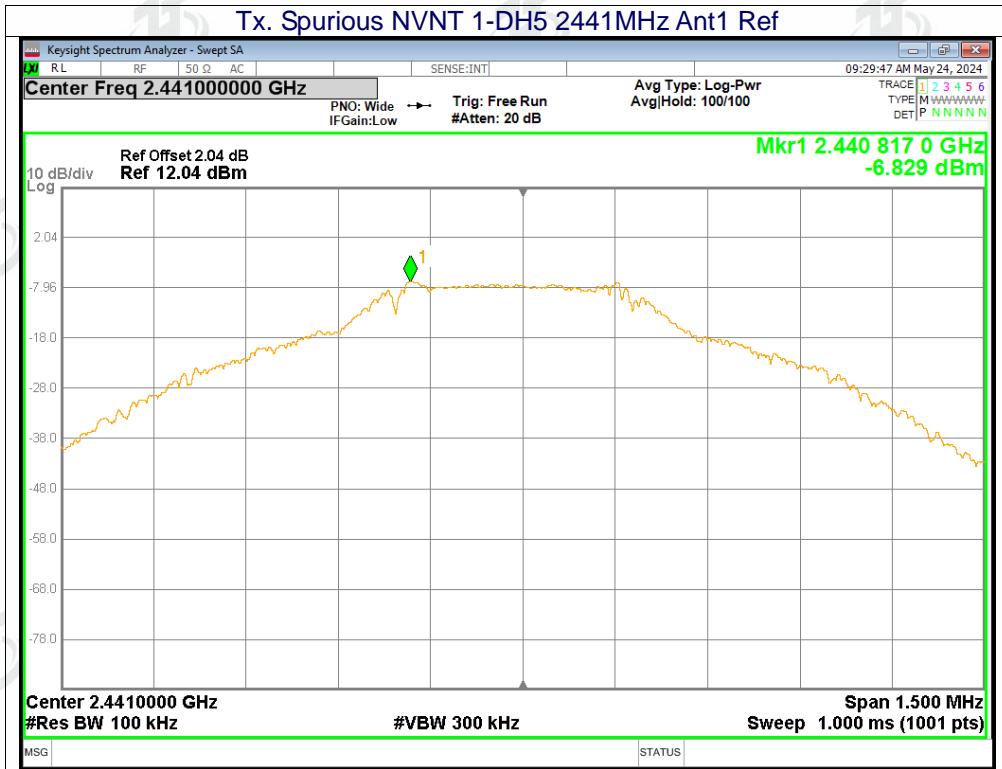

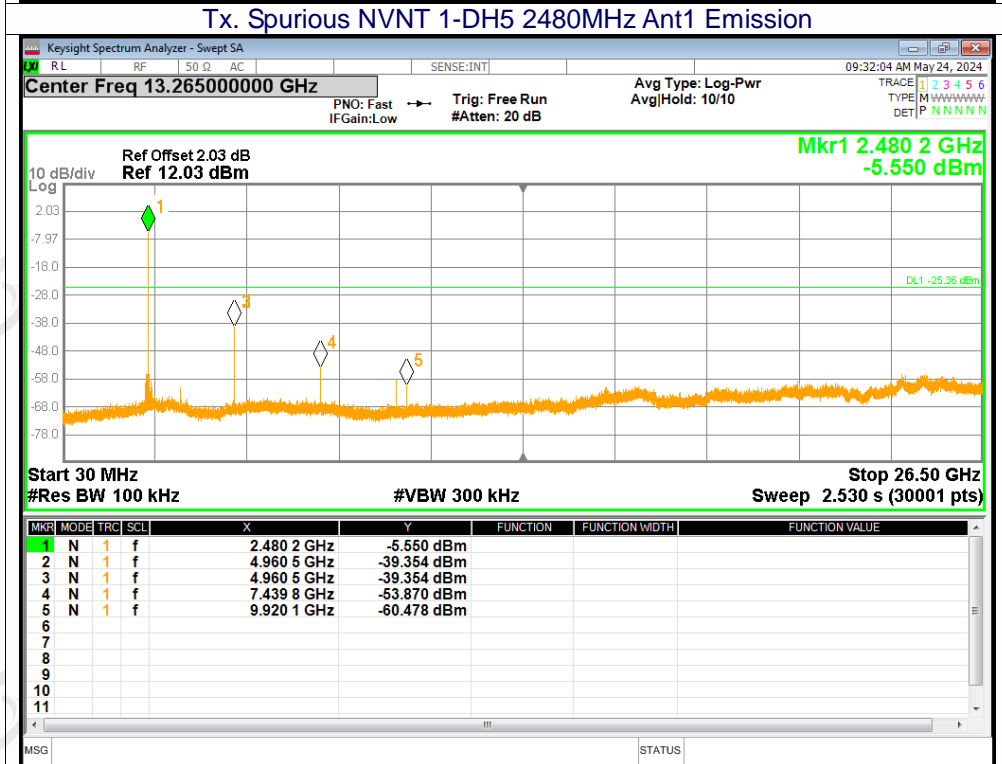
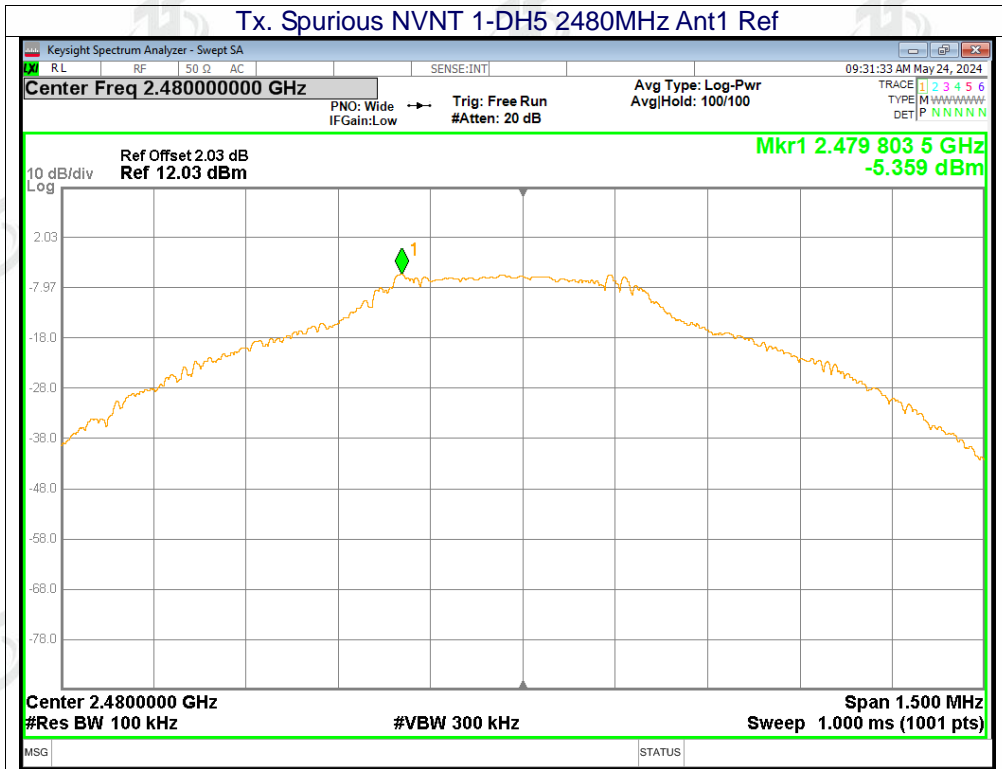

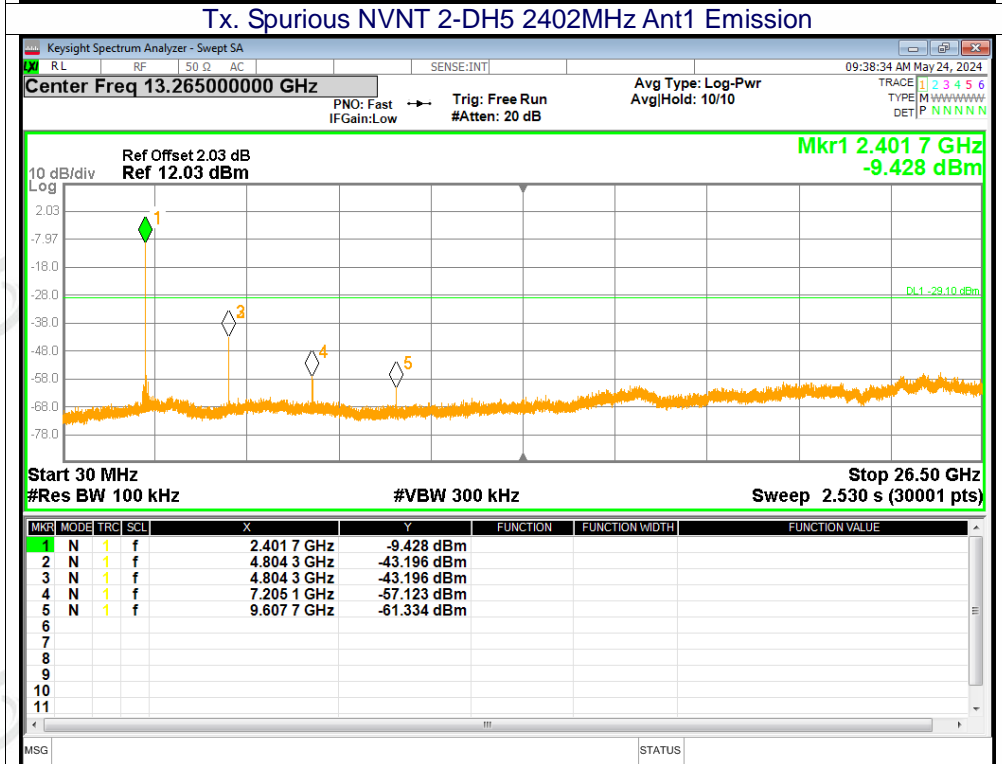
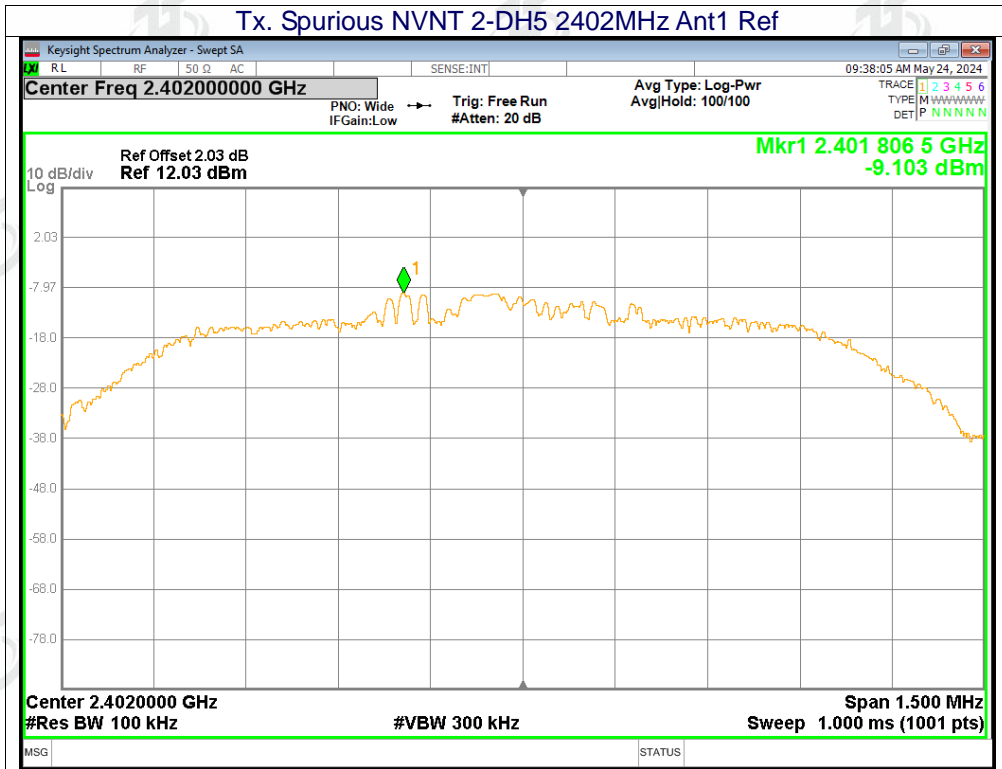

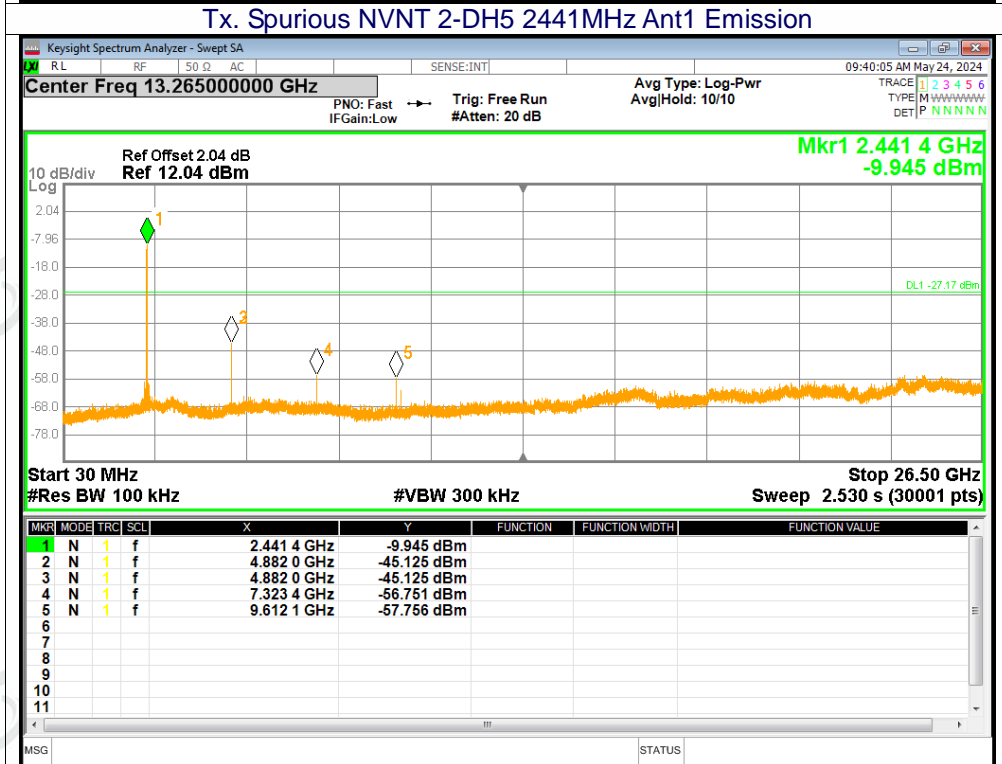
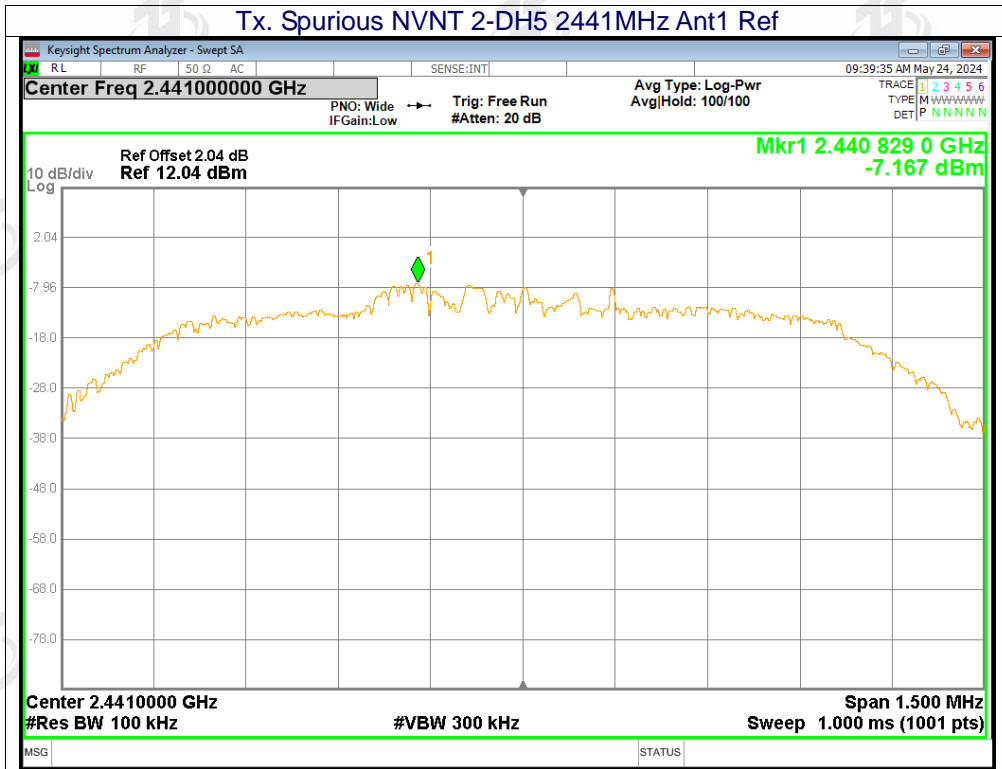

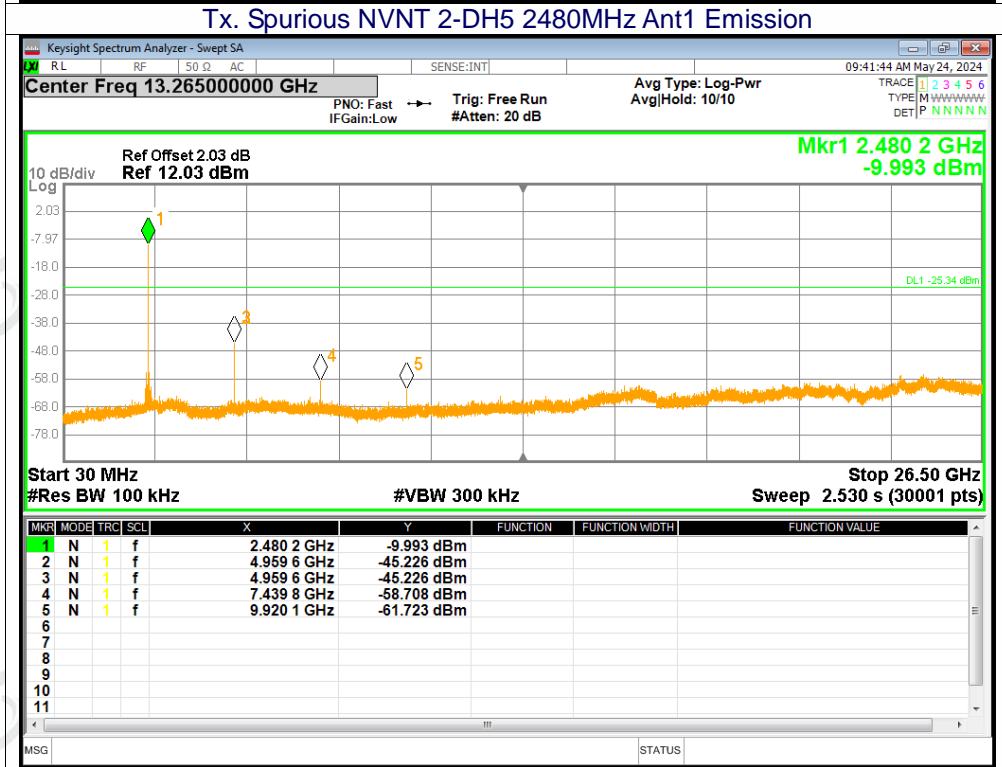
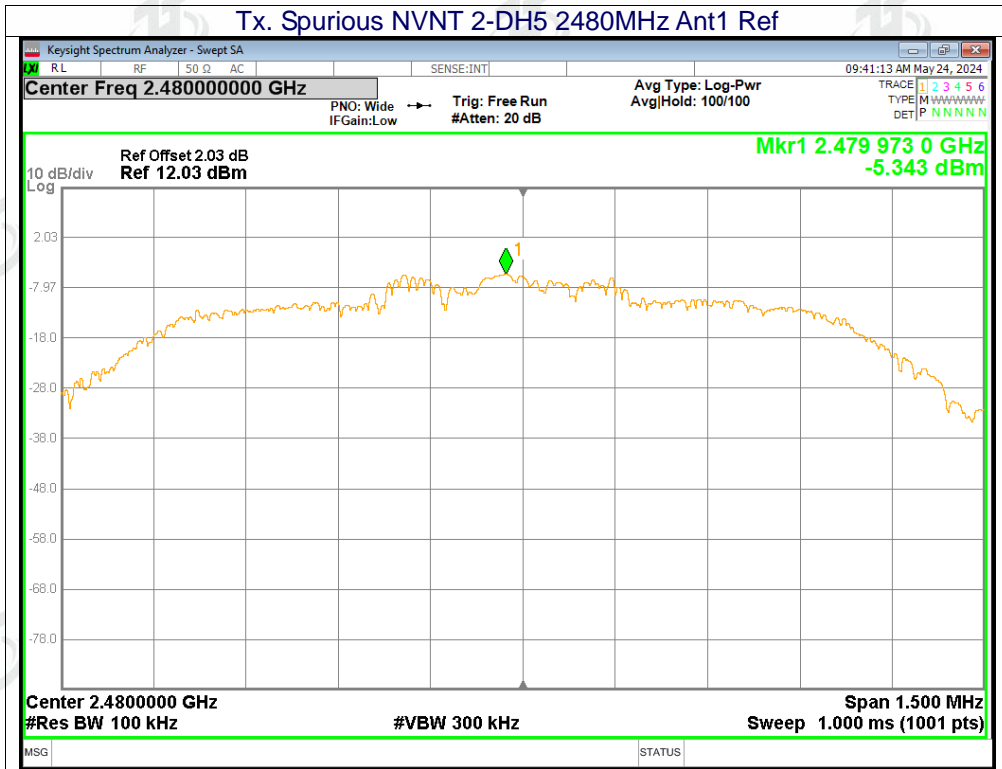

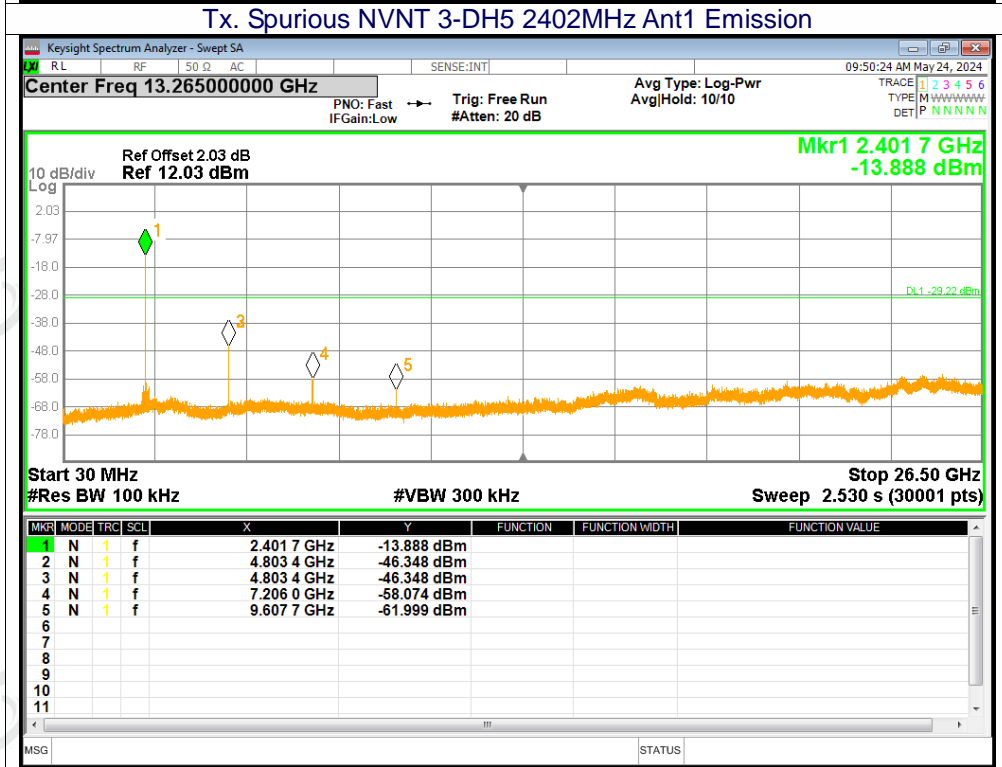
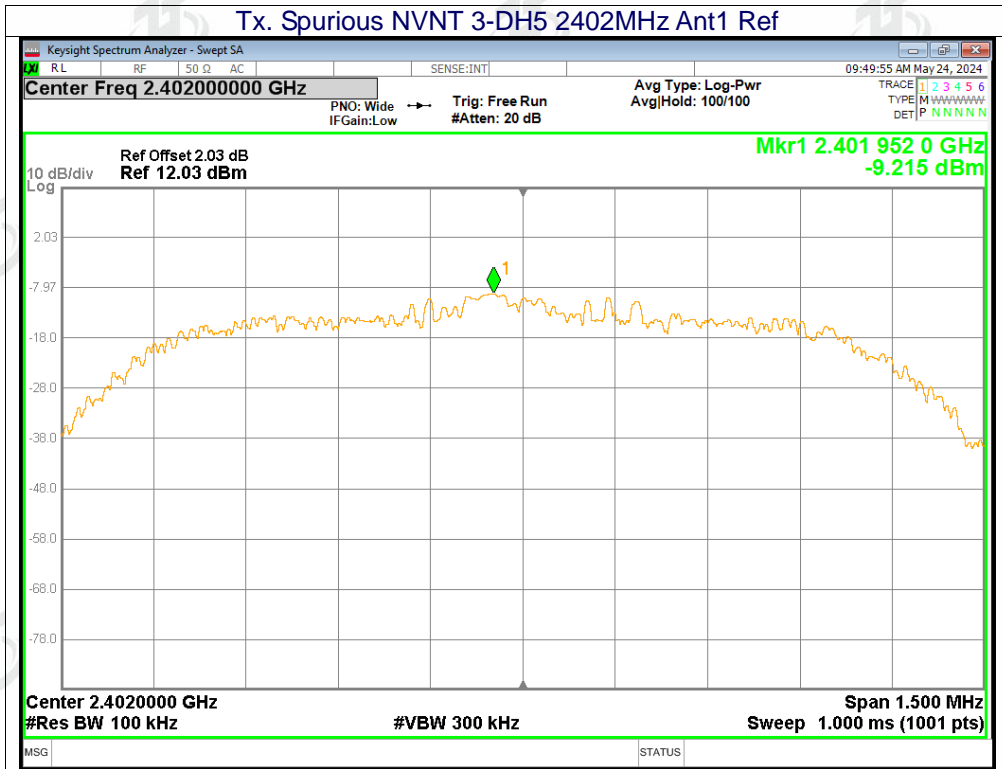

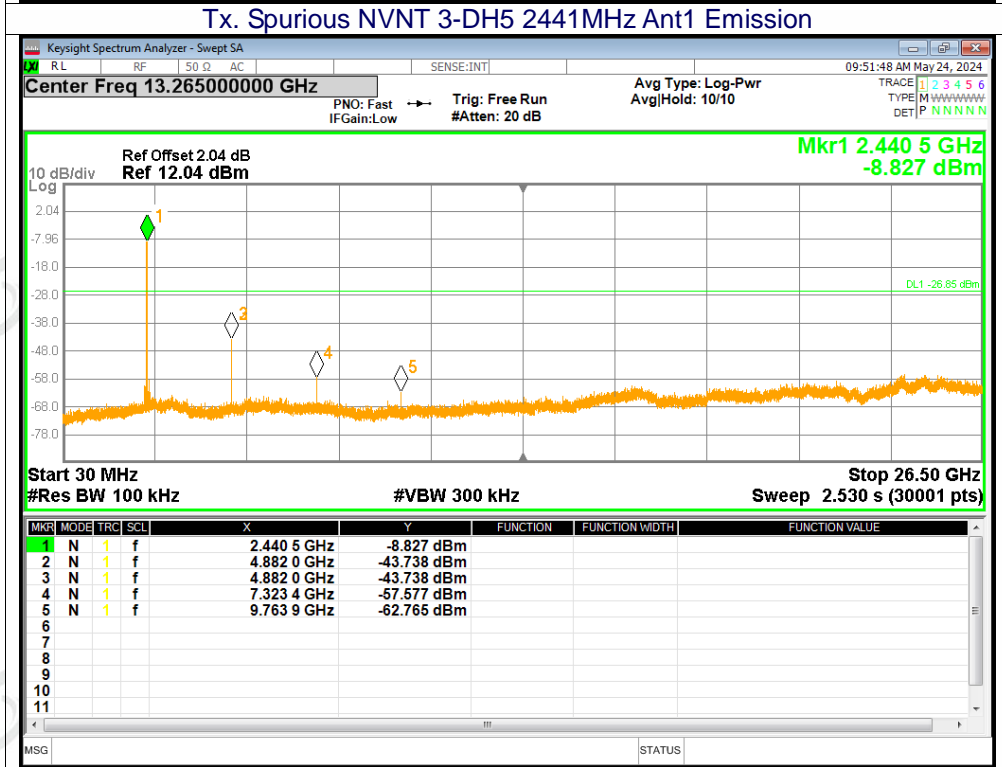
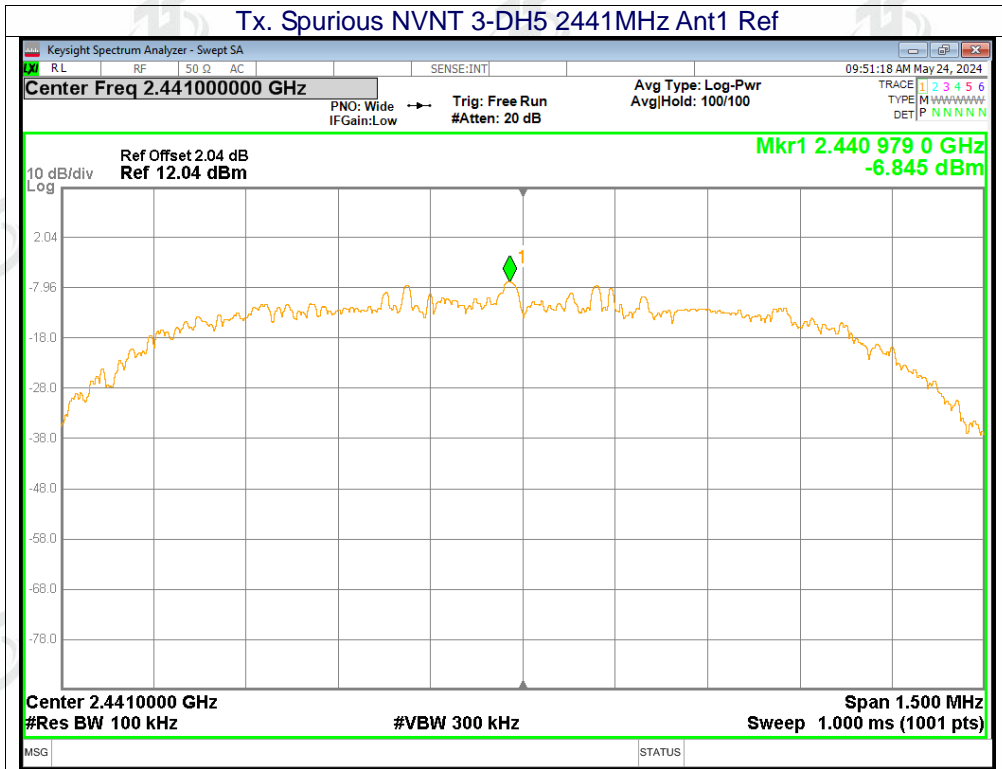

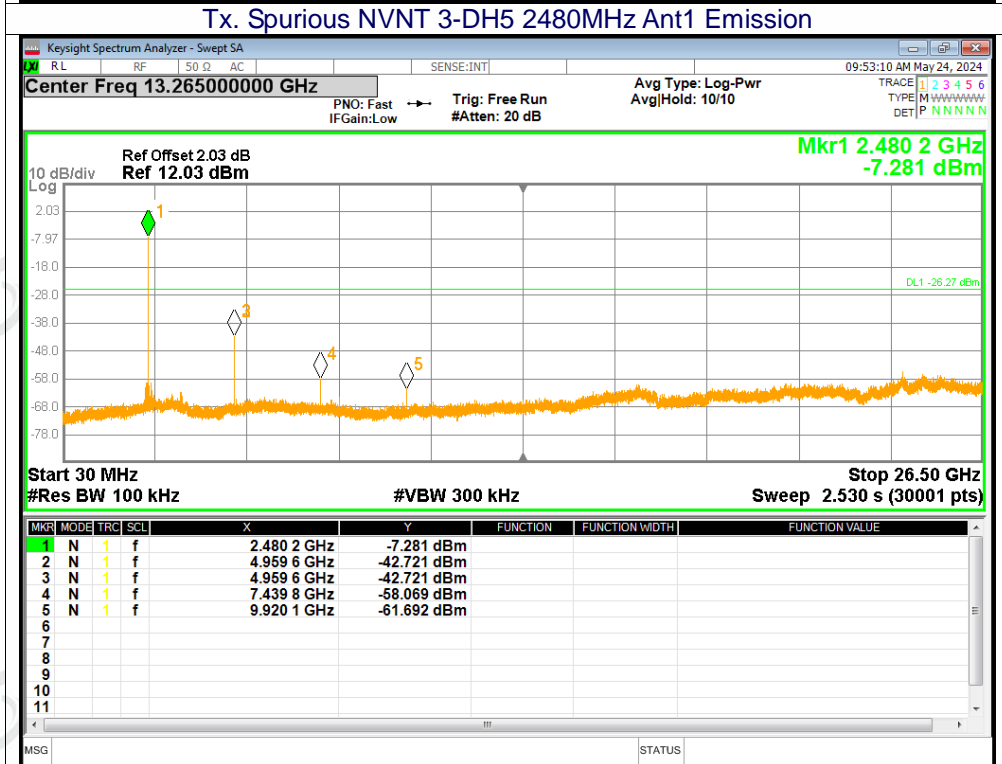
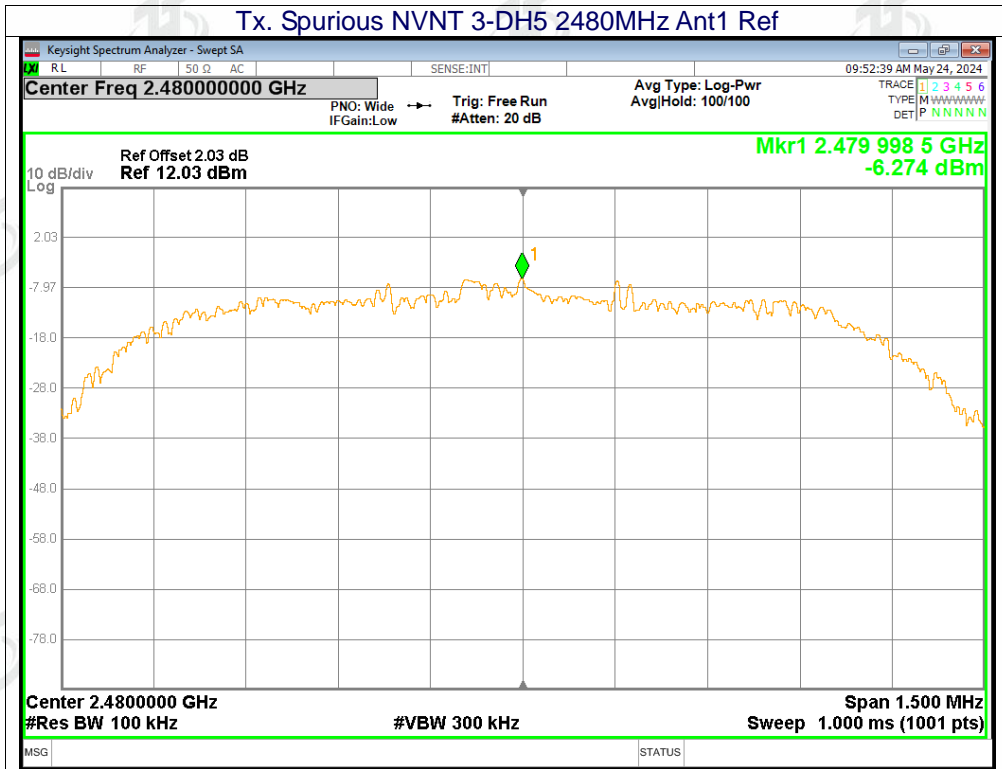



14. Test Setup Photo

Reference to the appendix I for details.

15. EUT Constructional Details

Reference to the appendix II for details.

***** END OF REPORT *****