

# ShenZhen Suncent Auto Parts Technology Company Limited

## TEST REPORT

**SCOPE OF WORK**

EMC TESTING—CS03, CS04

**REPORT NUMBER**

230926015GZU-003

**ISSUE DATE**

27-February-2024

**[REVISED DATE]**

[-----]

**PAGES**

28

**DOCUMENT CONTROL NUMBER**

FCC Part 15.225-f  
© 2017 INTERTEK



## TEST REPORT

Applicant Name & Address : ShenZhen Suncent Auto Parts Technology Company Limited  
5A1, Building C, Qingchuangcheng, Zhangkeng Community, Minzhi Street, Longhua District, Shenzhen City, Guangdong Province, China  
Manufacturing Site : Jiangsu Yihang Electric Science and Technology Co., Ltd.  
262 Deyu Road, Hongshan Subdistrict, Xinwu District Wuxi, China  
Intertek Report No: 230926015GZU-003  
FCC ID: 2BCL5-CS03

## Test standards

**47 CFR PART 15 Subpart C: 2021 section 15.225**

## Sample Description

Product : EV Charging Station  
Model No. : CS03,CS04  
Electrical Rating : CS03:240V AC 60Hz 40A,  
CS04: 240V AC 60Hz 48A  
Serial No. : Not Labeled  
Date Received : 26 September 2023  
Date Test : 02 January 2024-05 January 2024  
Conducted

Prepared and Checked By

*Richard Liu*

Richard Liu

Engineer

Approved By:

*Dean Liu*

Dean Liu

Sr. Project Engineer

This report is for the exclusive use of Intertek's Client and is provided pursuant to the agreement between Intertek and its Client. Intertek's responsibility and liability are limited to the terms and conditions of the agreement. Intertek assumes no liability to any party, other than to the Client in accordance with the agreement, for any loss, expense or damage occasioned by the use of this report. Only the Client is authorized to permit copying or distribution of this report and then only in its entirety. Any use of the Intertek name or one of its marks for the sale or advertisement of the tested material, product or service must first be approved in writing by Intertek. The observations and test results in this report are relevant only to the sample tested. This report by itself does not imply that the material, product, or service is or has ever been under an Intertek certification program.

**TEST REPORT**

**CONTENT**

**TEST REPORT ..... 1**

**CONTENT ..... 3**

**1.0 TEST RESULT SUMMARY ..... 4**

**2.0 GENERAL DESCRIPTION ..... 5**

    2.1 PRODUCT DESCRIPTION ..... 5

    2.2 RELATED SUBMITTAL(S) GRANTS ..... 5

    2.3 TEST METHODOLOGY ..... 5

    2.4 TEST FACILITY ..... 5

**3.0 SYSTEM TEST CONFIGURATION ..... 6**

    3.1 JUSTIFICATION ..... 6

    3.2 EUT EXERCISING SOFTWARE ..... 7

    3.3 SPECIAL ACCESSORIES ..... 7

    3.4 MEASUREMENT UNCERTAINTY ..... 7

    3.5 EQUIPMENT MODIFICATION ..... 8

    3.6 SUPPORT EQUIPMENT LIST AND DESCRIPTION ..... 8

**4.0 MEASUREMENT RESULTS ..... 9**

    4.1 ANTENNA REQUIREMENT ..... 9

    4.2 OCCUPIED BANDWIDTH ..... 10

    4.3 RADIATED EMISSION ..... 12

    4.4 FREQUENCY STABILITY ..... 22

    4.5 CONDUCTED EMISSION TEST ..... 25

**5.0 TEST EQUIPMENT LIST ..... 28**

## TEST REPORT

### 1.0 TEST RESULT SUMMARY

Test Item	Test Requirement	Test Method	Result
Antenna Requirement	FCC PART 15 C Section 15.203	FCC PART 15 C Section 15.203	PASS
Occupied Bandwidth	FCC PART 15 C section 15.215(c)	ANSI C63.10: Clause 6.9	PASS
Radiated Emission	FCC PART 15 C section 15.225 (a), (b), (c), (d)	ANSI C63.10: Clause 6.4 & 6.5	PASS
Frequency Stability	FCC PART 15 C section 15.225 (e)	ANSI C63.10: Clause 6.8	PASS
Conducted Emissions at Mains Terminals	FCC PART 15 C section 15.207	ANSI C63.10: Clause 6.2	PASS

**Remark:**

**N/A:** not applicable. Refer to the relative section for the details.

**EUT:** In this whole report EUT means Equipment Under Test.

**Tx:** In this whole report Tx (or tx) means Transmitter.

**Rx:** In this whole report Rx (or rx) means Receiver.

**RF:** In this whole report RF means Radio Frequency.

**ANSI C63.10:** the detail version is ANSI C63.10:2013 in the whole report

Both of models are same as each other except the model's name and output current.

The rated output current of model CS03 is 40A, and the rated output current of model CS04 is 48A

After pre-testing, the worst mode appeared in model CS04, and only the data of model CS04 was recorded.

## TEST REPORT

### 2.0 General Description

#### 2.1 Product Description

Operating Frequency	13.56 MHz
Type of Modulation:	ASK
Number of Channels	1 Channel
Channel Separation:	N/A
Antenna Type	Integral loop antenna
Power Supply:	240V/60Hz
Power cord:	N/A

#### 2.2 Related Submittal(s) Grants

This is an application for certification of:

DTS- Part 15 Digital Transmission Systems (WIFI transmitter portion)  
DXX(Part 15 Low Power Communication Device Transmitter).

Remaining portions are subject to the following procedures:

1. Receiver portion: exempt from technical requirement of this Part.

#### 2.3 Test Methodology

Both AC mains line-conducted and radiated emission measurements were performed according to the procedures in ANSI C63.10. Radiated emission measurement was performed in semi-anechoic chamber and conducted emission measurement was performed in shield room. For radiated emission measurement, preliminary scans and final tests were performed in the semi-anechoic chamber to determine the worst case modes. All radiated tests were performed at an antenna to EUT distance of 3 meters, unless stated otherwise.

#### 2.4 Test Facility

All tests were performed at:

Intertek Testing Services Shenzhen Ltd. Guangzhou Branch  
Room102/104, No 203, KeZhu Road, Science City, GETDD Guangzhou, China

Except Conducted Emissions was performed at:

Room101/301/401/102/202/302/402/502/602/702/802, No. 7-2, Caipin Road, Huangpu District, Guangzhou, Guangdong, China

## TEST REPORT

A2LA Certificate Number 0078.10

Intertek Testing Services Shenzhen Ltd. Guangzhou Branch is accredited by A2LA and Listed in FCC website. FCC accredited test labs may perform both Certification testing under Parts 15 and 18 and Declaration of Conformity testing.

### 3.0 System Test Configuration

#### 3.1 Justification

For emissions testing, the equipment under test (EUT) setup to transmit continuously to simplify the measurement methodology. Care was taken to ensure proper power supply voltages during testing. During testing, AC power line was manipulated to produce worst case emissions. It was powered by AC 120V/60Hz supply.

When below 30MHz, the measurement antenna was positioned with its plane perpendicular to the ground at the specified distance. When perpendicular to the ground plane, the lowest height of the magnetic antenna was 1 m above the ground and was positioned at 3m distance from the EUT. During testing the loop antenna was rotated about its vertical axis for maximum response at each azimuth and also investigated with the loop positioned in the horizontal plane. For each measurement antenna alignment, the EUT shall be rotated through 0° to 360° on a turntable.

When above 30MHz, the antenna height and polarization are varied during the search for maximum signal level. The antenna height is varied from 1 to 4 meters. Radiated emissions are taken at three meters unless the signal level is too low for measurement at that distance. If necessary, a pre-amplifier is used and/or the test is conducted at a closer distance.

All readings are extrapolated back to the equivalent three meter reading using inverse scaling with distance. The spurious emissions more than 20 dB below the permissible value are not reported.

For an intentional radiator, the spectrum shall be investigated from the lowest radio frequency signal generated in the device, without going below 9 kHz, up to at least the frequency shown in the following table:

Frequency range of radiated emission measurements

Lowest frequency generated in the device	Upper frequency range of measurement
9 kHz to below 10 GHz	10th harmonic of highest fundamental frequency or to 40 GHz, whichever is lower
At or above 10 GHz to below 30 GHz	5th harmonic of highest fundamental frequency or to 100 GHz, whichever is lower
At or above 30 GHz	5th harmonic of highest fundamental frequency or to 200 GHz, whichever is lower, unless otherwise specified

## TEST REPORT

Number of fundamental frequencies to be tested in EUT transmit band

Frequency range in which device operates	Number of frequencies	Location in frequency range of operation
1 MHz or less	1	Middle
1 MHz to 10 MHz	2	1 near top and 1 near bottom
More than 10 MHz	3	1 near top, 1 near middle and 1 near bottom

### 3.2 EUT Exercising Software

The NFC starts automatically.

### 3.3 Special Accessories

No special accessories used.

### 3.4 Measurement Uncertainty

No.	Item	Measurement Uncertainty
1	20 dB Bandwidth	2.3%
2	Carrier Frequencies Separated	2.3%
3	Radiated Emissions	4.24 dB (9KHz-30MHz)
		4.7 dB (25 MHz-1 GHz)
		4.8 dB (1 GHz-18 GHz)
		5.21dB (18GZH-26GHz)
4	Conducted Emissions at Mains Terminals	2.58dB
5	Temperature	0.5 °C
6	Humidity	0.4 %
7	Time	1.2%

The measurement uncertainty describes the overall uncertainty of the given measured value during the operation of the EUT.

Measurement uncertainty is calculated in accordance with ETSI TR 100 028-2001.

The measurement uncertainty is given with a confidence of 95%, k=2.

When determining of the test conclusion, the Measurement Uncertainty of test has been considered.

## TEST REPORT

Uncertainty and Compliance – Unless the standard specifically states that measured values are to be extended by the measurement uncertainty in determining compliance, all compliance determinations are based on the actual measured value

### 3.5 Equipment Modification

Any modifications installed previous to testing by ShenZhen Suncent Auto Parts Technology Company Limited will be incorporated in each production model sold / leased in the United States.

No modifications were installed by Intertek Testing Services Shenzhen Ltd. Guangzhou Branch.

### 3.6 Support Equipment List and Description

This product was tested with corresponding support equipment as below:

#### Support Equipment

Description	Manufacturer	Model No.	SN/Version	Supplied by
NoteBook	HP	Compaq 6710b	SN:CNU8240LF9	Intertek
Airbreak switch	CHNT	DZ158-125	SN:100025307896	Intertek

#### Cable

Description	Model No.	Connector type	Cable length/type	Supplied by
Antenna cable	RF-01	SMA	0.2 m(shielded)	Intertek

#### Load

Description	Model No.	Electrical Rating	Quantity	Supplied by
Load box	STK-20KW	20KW Max	1	Intertek
Load box	VILVA-ACDC-20KW-R	20KW Max	1	Intertek



## TEST REPORT

### 4.0 Measurement Results

#### 4.1 Antenna Requirement

Standard requirement:

15.203 requirement:

For intentional device. According to 15.203 an intentional radiator shall be designed to Ensure that no antenna other than that furnished by the responsible party shall be used with the device.

EUT Antenna

The antenna is an integral loop antenna and no consideration of replacement.

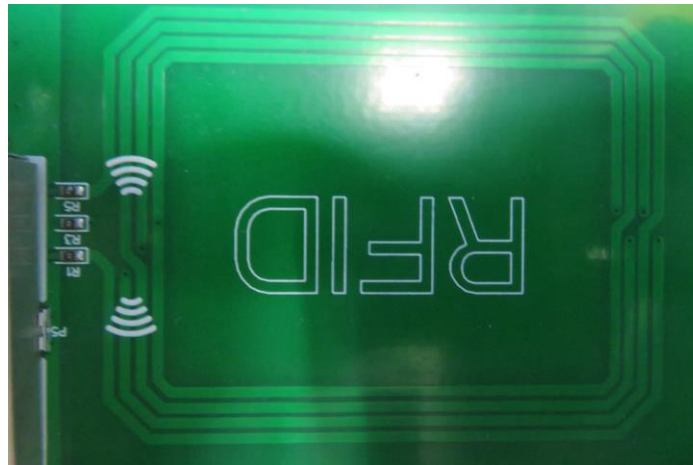

Antenna dimension design

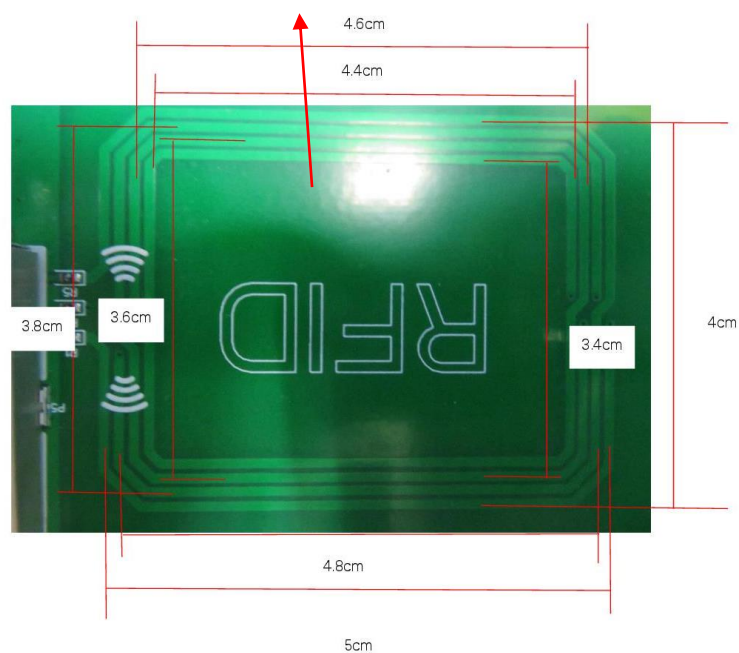

## TEST REPORT

### 4.2 Occupied Bandwidth

- Test Requirement: FCC PART 15 C section 15.215(c)  
(c) Intentional radiators operating under the alternative provisions to the general emission limits, as contained in §§ 15.217 through 15.257 and in subpart E of this part, must be designed to ensure that the 20 dB bandwidth of the emission, or whatever bandwidth may otherwise be specified in the specific rule section under which the equipment operates, is contained within the frequency band designated in the rule section under which the equipment is operated
- Test Method: ANSI C63.10: Clause 6.9
- Test Status: Pre-Scan has been conducted to determine the worst-case mode.
- Test Configuration:

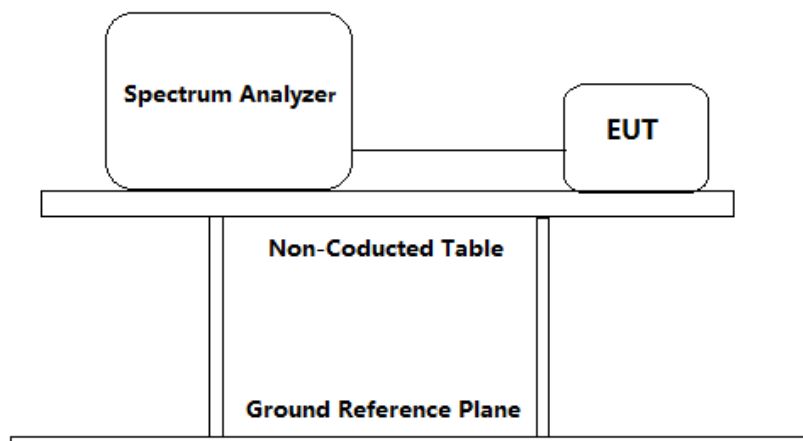

- Test Procedure:
- The transmitter was operated at its maximum carrier power measured under normal test conditions.
- The instrument center frequency was set to the nominal EUT channel center frequency. The frequency span for the spectrum analyzer was between 1.5 times and 5.0 times the OBW(20 dB Bandwidth).
  - The nominal IF filter bandwidth (3 dB RBW) was in the range of 1% to 5% of the OBW, and VBW was approximately three times the RBW.
  - Set the reference level of the instrument as required, keeping the signal from exceeding the maximum input mixer level for linear operation. In general, the peak of the spectral envelope was more than  $[10 \log (\text{OBW}/\text{RBW})]$  below the reference level.
  - Step a) through step c) might require iteration to adjust within the specified range.
  - The dynamic range of the instrument at the selected RBW was more than 10 dB below the target “-20 dB down” requirement; that is, if the requirement calls for measuring the -20 dB OBW, the instrument noise floor at the selected RBW was at least 30 dB below the reference value.

**TEST REPORT**

- f) Peak detection and max hold mode (until the trace stabilizes) was used.
- g) Used the 20dB bandwidth function of the instrument and reported the measured bandwidth.
- h) The occupied bandwidth was reported by providing plot(s) of the measuring instrument display; the plot axes and the scale units per division was clearly labeled. Tabular data was reported in addition to the plot(s).

**Used Test Equipment List**

Spectrum Analyzer. Refer to Clause 5 Test Equipment List for details.

20 dB bandwidth:

Frequency (MHz)	20 dB bandwidth (kHz)	lower frequency (MHz)	upper frequency (MHz)	Assigned Band (MHz)	Result
13.560	2.315	13.559	13.561	13.110-14.010	Pass

Result plot as follows:

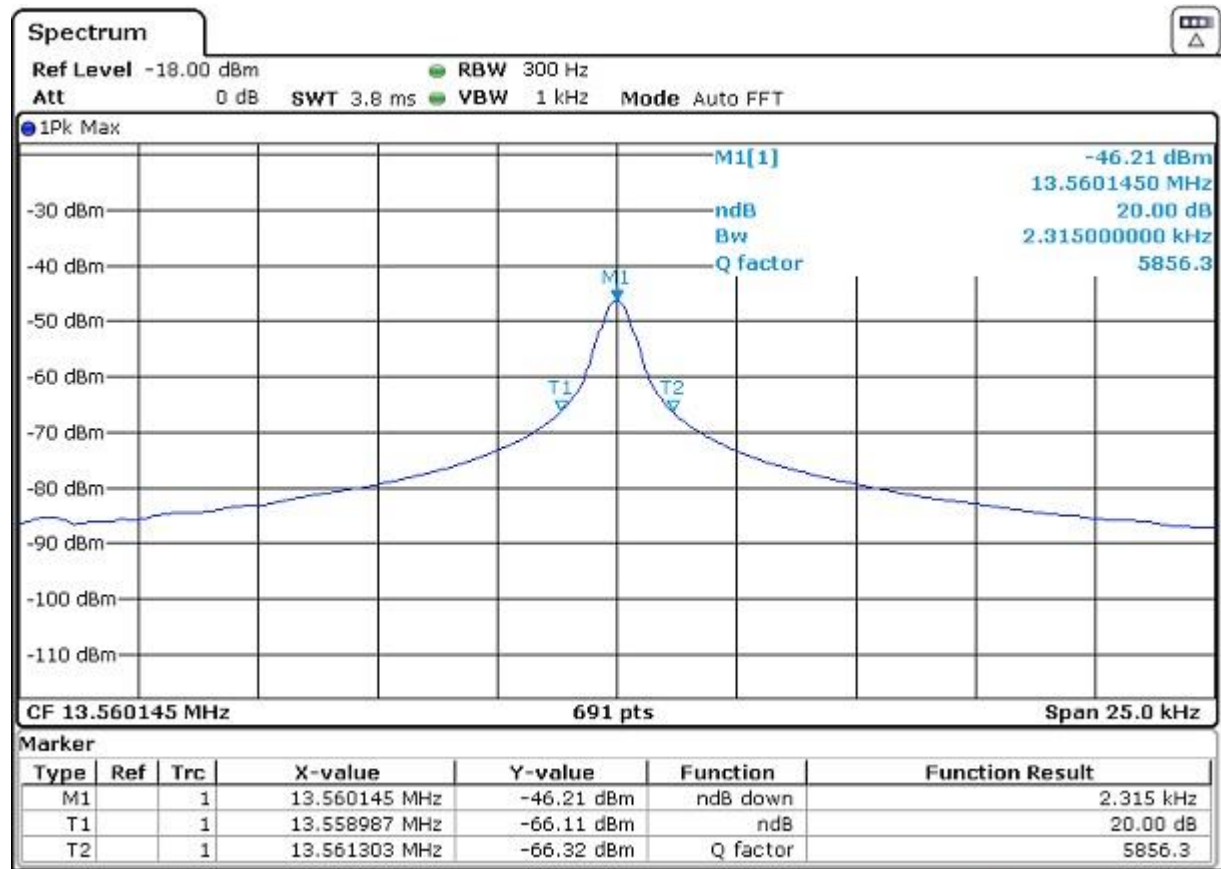

Test result: The unit does meet the FCC requirements.

**TEST REPORT**

**4.3 Radiated Emission**

Test Requirement:

FCC PART 15 C section 15.225 (a), (b), (c), (d)

The field strength of emissions from intentional radiators operated under this Section shall not exceed the following:

15.225(a): The field strength of any emissions within the band 13.553-13.567 MHz shall not exceed 15,848 microvolts/meter at 30 meters. i.e. 124.0dBμV/m @ 3 m.

15.225(b): Within the bands 13.410-13.553 MHz and 13.567-13.710 MHz, the field strength of any emissions shall not exceed 334 microvolts/meter at 30 meters. i.e. 90.5dBμV/m @ 3 m.

15.225(c): Within the bands 13.110-13.410 MHz and 13.710-14.010 MHz the field strength of any emissions shall not exceed 106 microvolts/meter at 30 meters. i.e. 80.5dBμV/m @ 3 m.

15.225(d) :The field strength of any emissions appearing outside of the 13.110-14.010 MHz band shall not exceed the general radiated emission limits in § 15.209.

Convert the units of microvolts/meter to dBμV/m:

$$20 * \log \text{Value}(\text{microvolts/meter}) = \text{Value}(\text{dB}\mu\text{V/m})$$

convert the field strength limits at 30m and 300m to 3m:

$$\text{Value}(\text{dB}\mu\text{V/m})@30\text{m} + 40 = \text{Value}(\text{dB}\mu\text{V/m})@3\text{m}$$

$$\text{Value}(\text{dB}\mu\text{V/m})@300\text{m} + 80 = \text{Value}(\text{dB}\mu\text{V/m})@3\text{m}$$

§ 15.209 Limit:

Frequency (MHz)	Field Strength (dBμV/m @ 3m)
1.705-30.0	69.5
30-88	40
88-216	43.5
216-960	46
Above 960	54

Test Method:

ANSI C63.10: Clause 6.4 and 6.5.

Test Status:

Pre-Scan has been conducted to determine the worst-case mode from all possible configuration.

Test site:

Measurement Distance: 3m (Semi-Anechoic Chamber)

Detector:

Quasi-Peak detector:

RBW=200 Hz for 9 kHz to 150 kHz

RBW=9 kHz for 150 kHz to 30 MHz

RBW=120 kHz for 30 MHz to 1GHz

Sweep = auto

Trace = max hold

Field Strength Calculation:

The field strength is calculated by adding the reading on the

**TEST REPORT**

Spectrum Analyzer to the factors associated with preamplifiers (if any), antennas, cables, pulse desensitization and average factors (when specified limit is in average and measurements are made with peak detectors). A sample calculation is included below:

$$FS = RA + AF + CF - AG + PD + AV$$

$$FS = RA + \text{Correct Factor} + AV$$

FS = Field Strength in dB $\mu$ V/m

Where:

RA = Receiver Amplitude (including preamplifier) in dB $\mu$ V

AF = Antenna Factor in dB

CF = Cable Attenuation Factor in dB

AG = Amplifier Gain in dB

PD = Pulse Desensitization in dB

AV = Average Factor in -dB

Correct Factor = AF + CF - AG + PD

In the radiated emission table which follows, the reading shown on the data table may reflect the preamplifier gain. An example of the calculations, where the reading does not reflect the preamplifier gain, follows:

$$FS = RA + AF + CF - AG + PD + AV$$

Assume a receiver reading of 62.0 dB $\mu$ V is obtained. The antenna factor of 7.4 dB and cable factor of 1.6 dB is added. The amplifier gain of 29 dB is subtracted. The pulse desensitization factor of the spectrum analyzer was 0 dB, and the resultant average factor was -10 dB. The net field strength for comparison to the appropriate emission limit is 32 dB $\mu$ V/m.

$$RA = 62.0 \text{ dB}\mu\text{V}$$

$$AF = 7.4 \text{ dB}$$

$$CF = 1.6 \text{ dB}$$

$$AG = 29.0 \text{ dB}$$

$$PD = 0 \text{ dB}$$

$$AV = -10 \text{ dB}$$

$$\text{Correct Factor} = 7.4 + 1.6 - 29.0 + 0 = -20 \text{ dB}$$

$$FS = 62 + (-20) + (-10) = 32 \text{ dB}\mu\text{V/m}$$

Section 15.205 Restricted bands of operation.

MHz	MHz	MHz	GHz
-----	-----	-----	-----

## TEST REPORT

0.090 - 0.110	16.42 - 16.423	399.9 - 410	4.5 - 5.15
0.495 - 0.505	16.69475 - 16.69525	608 - 614	5.35 - 5.46
2.1735 - 2.1905	16.80425 - 16.80475	960 - 1240	7.25 - 7.75
4.125 - 4.128	25.5 - 25.67	1300 - 1427	8.025 - 8.5
4.17725 - 4.17775	37.5 - 38.25	1435 - 1626.5	9.0 - 9.2
4.20725 - 4.20775	73 - 74.6	1645.5 - 1646.5	9.3 - 9.5
6.215 - 6.218	74.8 - 75.2	1660 - 1710	10.6 - 12.7
6.26775 - 6.26825	108 - 121.94	1718.8 - 1722.2	13.25 - 13.4
6.31175 - 6.31225	123 - 138	2200 - 2300	14.47 - 14.5
8.291 - 8.294	149.9 - 150.05	2310 - 2390	15.35 - 16.2
8.362 - 8.366	156.52475 -	2483.5 - 2500	17.7 - 21.4
8.37625 - 8.38675	156.52525	2655 - 2900	22.01 - 23.12
8.41425 - 8.41475	156.7 - 156.9	3260 - 3267	23.6 - 24.0
12.29 - 12.293	162.0125 - 167.17	3332 - 3339	31.2 - 31.8
12.51975 - 12.52025	167.72 - 173.2	3345.8 - 3358	36.43 - 36.5
12.57675 - 12.57725	240 - 285	3600 - 4400	
13.36 - 13.41	322 - 335.4		

The field strength of emissions appearing within these frequency bands shall not exceed the limits shown in 15.209.

### Test Configuration:

- 1) 9 kHz to 30 MHz emissions:

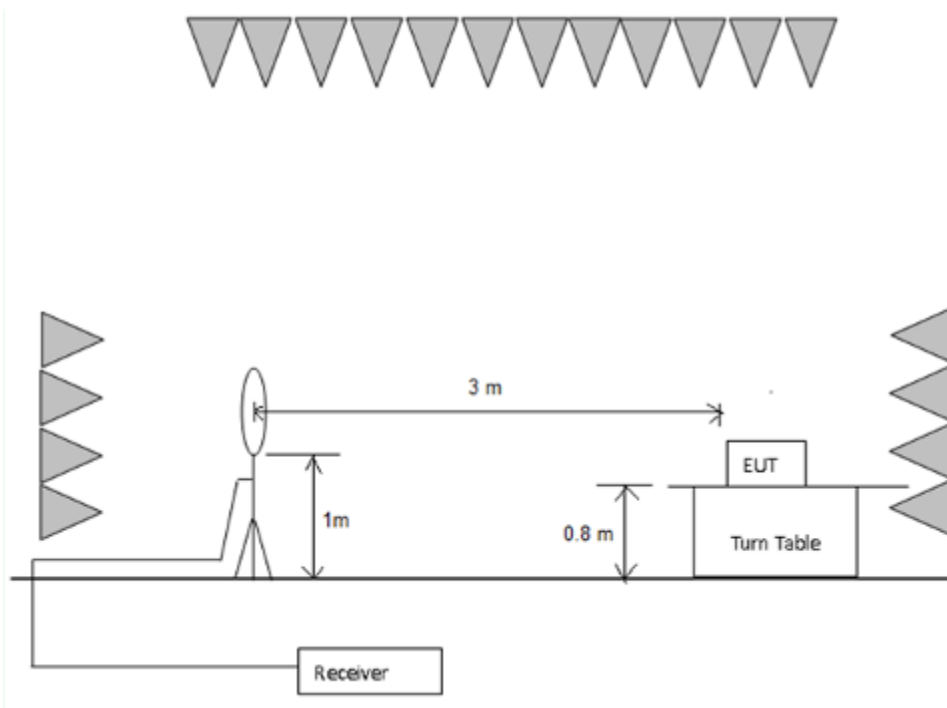

- 2) 30 MHz to 1 GHz emissions:

## TEST REPORT

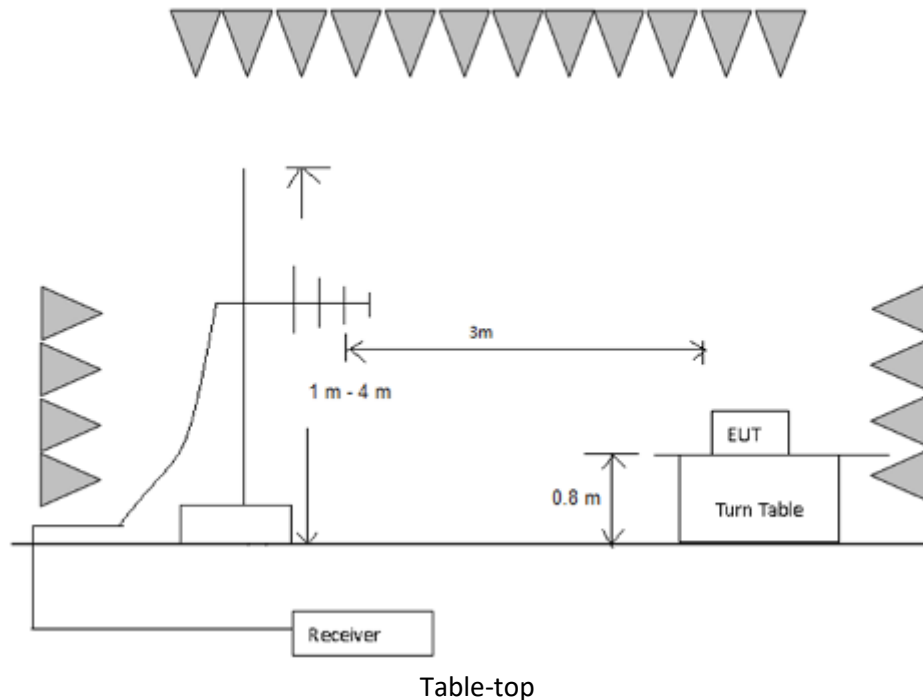

### Test Procedure:

#### 1) 9 kHz to 30 MHz emissions:

For testing performed with the loop antenna, the lowest height of the magnetic antenna shall be 1 m above the ground and shall be positioned at the specified distance from the EUT. During testing the loop was rotated about its vertical axis for maximum response at each azimuth and also investigated with the loop positioned in the horizontal plane.

#### 2) 30 MHz to 1 GHz emissions:

For testing performed with the TRILOG Super Broadband test Antenna. The measurement is performed with the EUT rotated 360°, the antenna height scanned between 1m and 4m, and the antenna rotated to repeat the measurement for both the horizontal and vertical antenna polarizations.

- 3) The receiver was scanned from 9 kHz to 200 MHz. When an emission was found, the table was rotated to produce the maximum signal strength. An initial pre-scan was performed for in peak detection mode using the receiver. The EUT was measured for both the Horizontal and Vertical polarities and performed a pre-test three orthogonal planes. For intentional radiators, measurements of the variation of the input power or the radiated signal level of the fundamental frequency component of the emission, as appropriate, shall be performed with the supply voltage varied between 85% and 115% of the nominal rated supply voltage. The worst case emissions were reported.

### Used Test Equipment List:

3m Semi-Anechoic Chamber, EMI Test Receiver (9 kHz~7 GHz), Signal and Spectrum Analyzer (10 Hz~40 GHz), Loop antenna (9 kHz-30 MHz). TRILOG Super Broadband test Antenna(30 MHz-3 GHz) (RX), Bouble-Ridged Waveguide Horn Antenna (800 MHz-18 GHz)(RX) and High Frequency Antenna & preamplifier(18 GHz~26.5 GHz) (RX). Refer to Clause 5 Test Equipment List for details.

## TEST REPORT

### Radiated Emissions (Below 30 MHz)

Operation Mode: Continuously transmitting

Horizontal

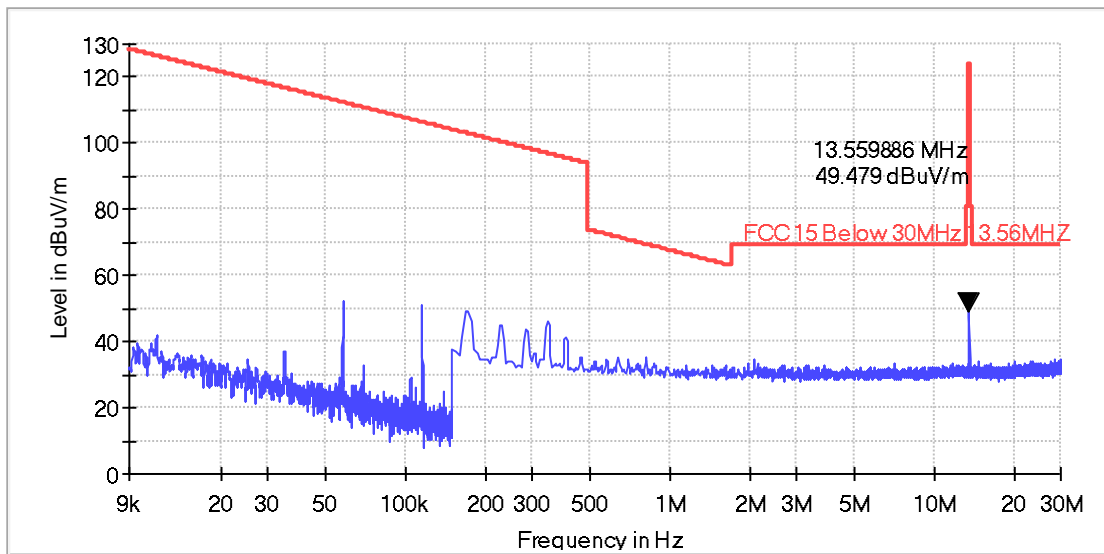

All emission levels are more than 6 dB below the limit.

Vertical

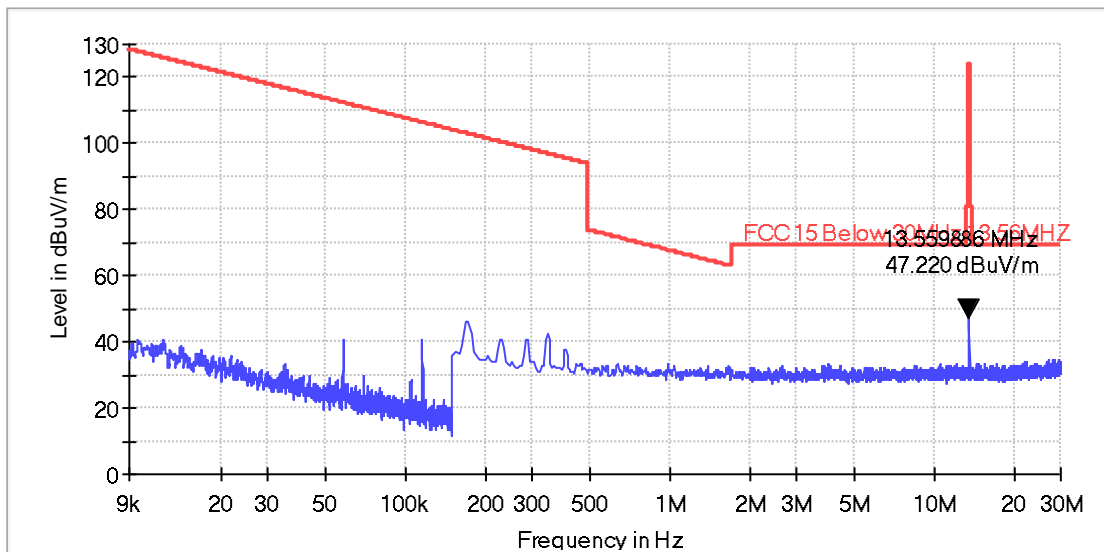

All emission levels are more than 6 dB below the limit.



**TEST REPORT**

Horizontal

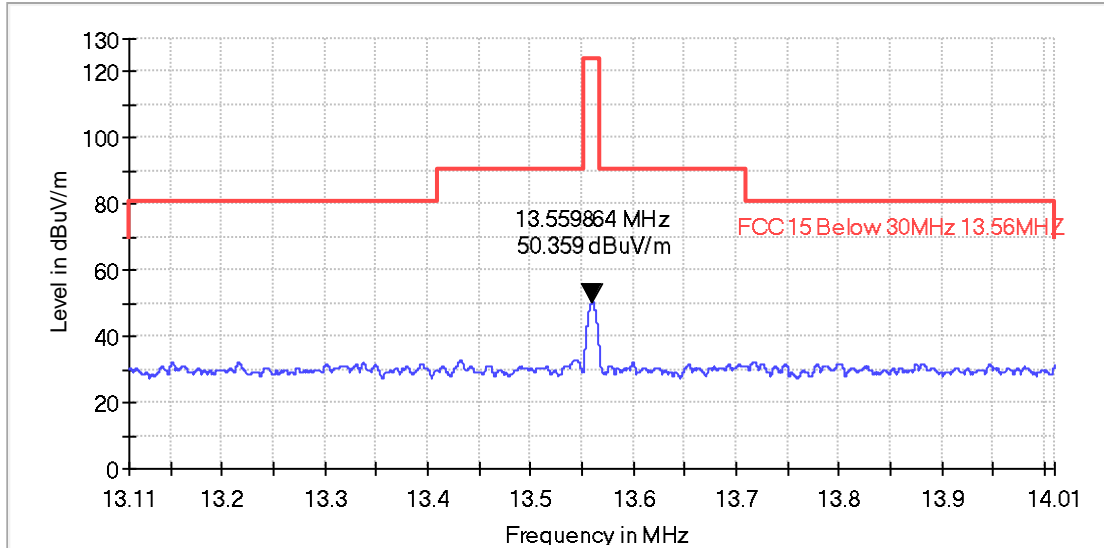

Frequency (MHz)	Receiver Reading Level (dBμV)	Correction factors (dB/m)	Emission Level (dBμV/m)	Limit (dBμV/m)	Margin (dBμV/m)
13.56	29.4	21.0	50.4	124.0	73.6

Vertical

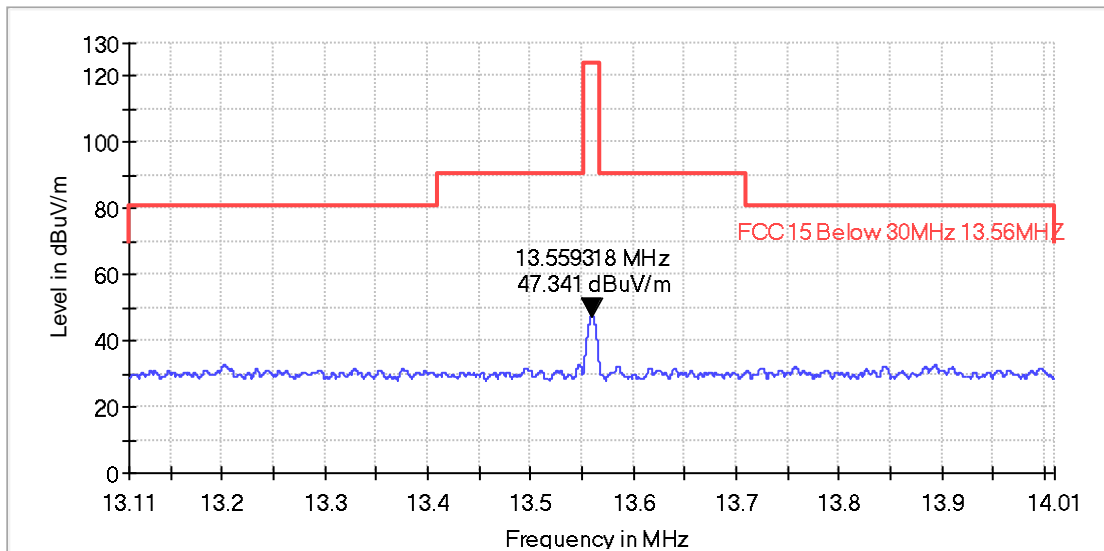

**TEST REPORT**

Frequency (MHz)	Receiver Reading Level (dBμV)	Correction factors (dB/m)	Emission Level (dBμV/m)	Limit (dBμV/m)	Margin (dBμV/m)
13.56	26.3	21.0	47.3	124.0	76.7

The emission limits shown above are based on measurements employing a CISPR quasi-peak detector except for the frequency bands 9-90 kHz, 110-490 kHz and above 1000 MHz. Radiated emission limits in these three bands are based on measurements employing an average detector.

Remark:

1. Corr. (dB) = Antenna Factor (dB) + Cable Loss (dB)
2. Level (dBμV/m) = Corr. (dB) + Read Level (dBμV)
3. Margin (dB) = Limit (dBμV/m) –Level (dBμV/m)
4. Only record the date closed to limit
5. The emission is worst case on Horizontal
6. When Peak emission level was below AV or QP limit, the AV and QP emission level was not recorded.

**Radiated Emissions (Above 30MHz)**

Operation Mode: Continuously transmitting

Horizontal

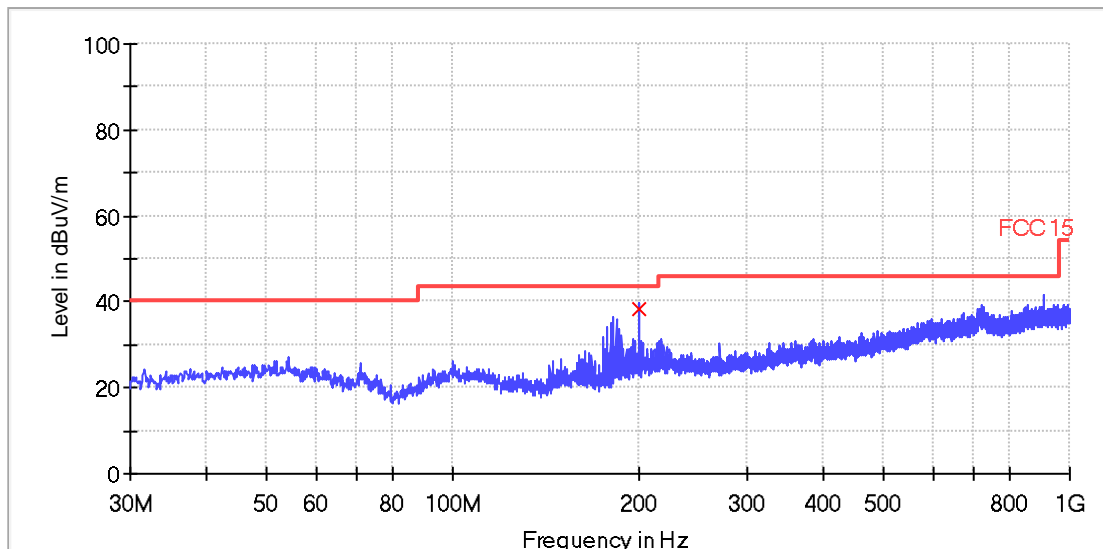

**QP**

## TEST REPORT

Frequency (MHz)	Quasi Peak (dBuV/m)	Bandwidth (kHz)	Pol	Corr. (dB)	Margin - QPK (dB)	Limit - QPK (dBuV/m)
199.960000	38.3	120.000	H	19.1	5.3	43.5

Remark:

1. Corr. (dB) = Antenna Factor (dB) + Cable Loss (dB)
2. Quasi Peak (dB $\mu$ V/m) = Corr. (dB) + Read Level (dB $\mu$ V)
3. Margin (dB) = Limit QPK (dB $\mu$ V/m) – Quasi Peak (dB $\mu$ V/m)

Vertical

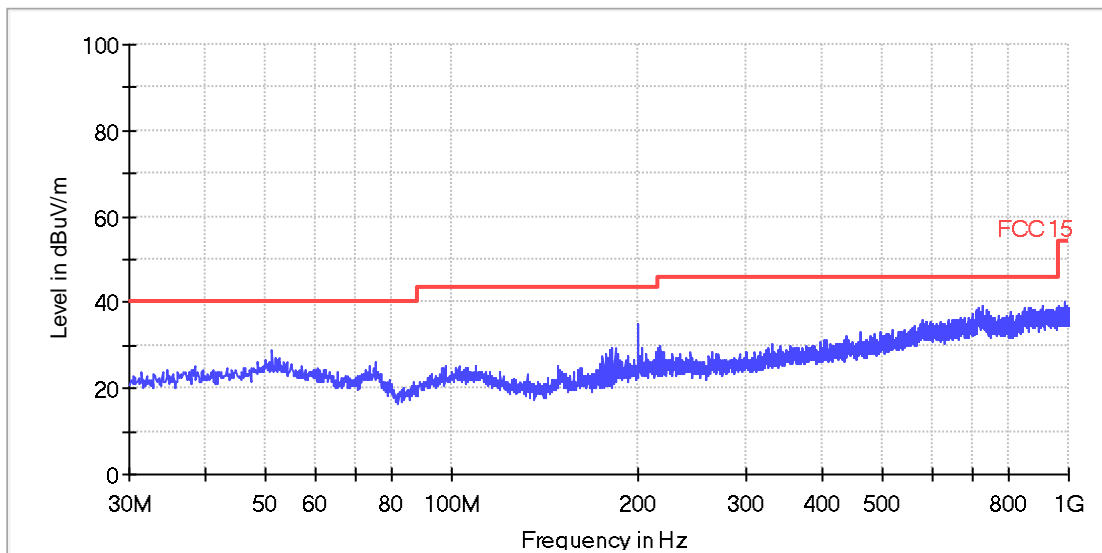

All emission levels are more than 6dB below the limit.

### TEST REPORT

Test in WIFI, Bluetooth, NFC continuous transmission status  
9 kHz~30 MHz Field Strength of Unwanted Emissions. Quasi-Peak Measurement The measurements with active loop antenna were greater than 20dB below the limit, so the test data were not recorded in the test report.  
30 MHz~1 GHz Spurious Emissions. Quasi-Peak Measurement  
Vertical:

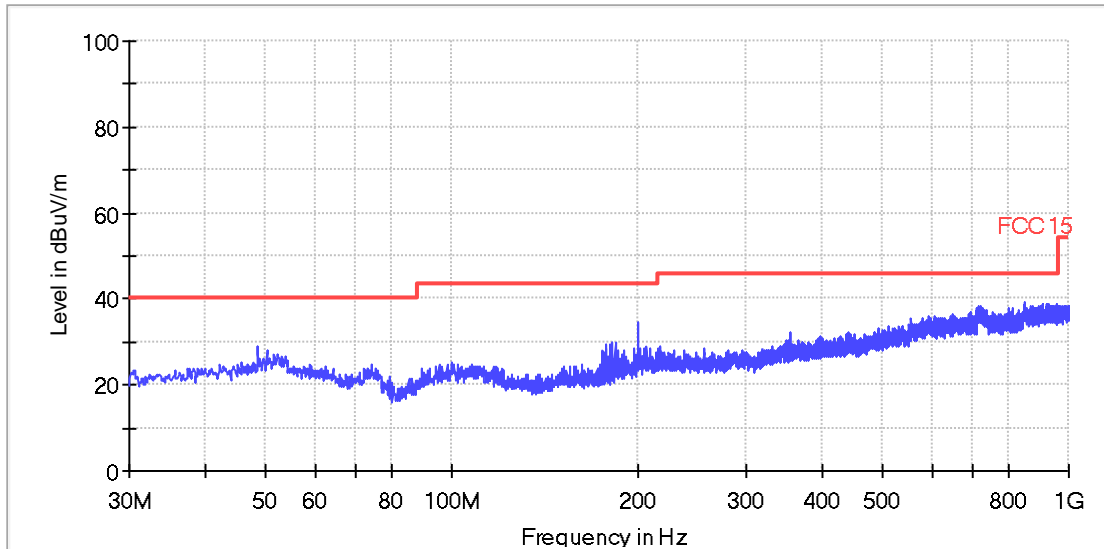

All emission levels are more than 6dB below the limit.

## TEST REPORT

Horizontal

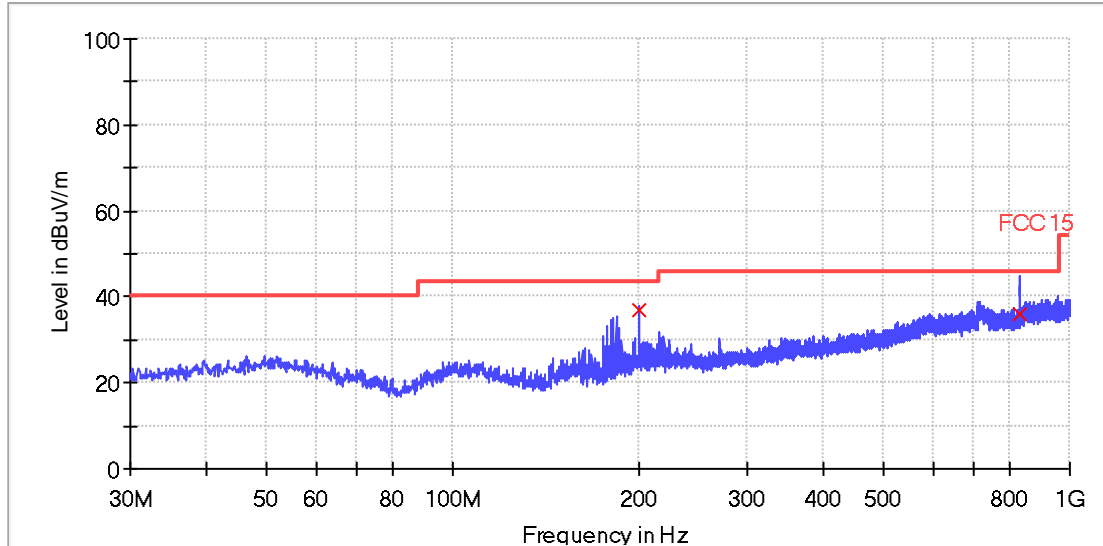

### QP

Frequency (MHz)	Quasi Peak (dBuV/m)	Bandwidth (kHz)	Pol	Corr. (dB)	Margin - QPK (dB)	Limit - QPK (dBuV/m)
199.960000	37.1	120.000	H	19.1	6.4	43.5
832.080000	36.1	120.000	H	30.3	9.9	46.0

Remark:

1. Corr. (dB) = Antenna Factor (dB) + Cable Loss (dB)
  2. Quasi Peak (dB $\mu$ V/m) = Corr. (dB) + Read Level (dB $\mu$ V)
  3. Margin (dB) = Limit QPK (dB $\mu$ V/m) – Quasi Peak (dB $\mu$ V/m)
- 1~25 GHz Radiated Emissions.

### PK Measurement:

Frequency (MHz)	PK Reading Level (dBuV)	Correction factors (dB)	PK Emission Level (dBuV/m)	PK Limit (dBuV/m)	Antenna polarization
2437.0	54.6	-8.0	46.6	74	V
4874.5	50.8	-1.0	49.8	74	V
2438.5	54.0	-8.0	46.0	74	H
4874.5	53.0	-1.0	52.0	74	H

### AV Measurement:

Frequency (MHz)	AV Reading Level (dBuV)	Correction factors (dB)	AV Emission Level (dBuV/m)	AV Limit (dBuV/m)	Antenna polarization
2437.0	-	-8.0	-	54	V
4874.5	-	-1.0	-	54	V
2438.5	-	-8.0	-	54	H
4874.5	-	-1.0	-	54	H

Remark: When Peak emission level was below AV limit, the AV emission level did not be record.

**TEST REPORT**

**4.4 Frequency Stability**

Test Requirement: FCC Part 15 C section 15.225 (e)  
(e) The frequency tolerance of the carrier signal shall be maintained within  $\pm 0.01\%$  of the operating frequency over a temperature variation of -20 degrees to + 50 degrees C at normal supply voltage, and for a variation in the primary supply voltage from 85% to 115% of the rated supply voltage at a temperature of 20 degrees C. For battery operated equipment, the equipment tests shall be performed using a new battery.

Test Method: ANSI C63.10: Clause 6.8

- Test Procedure:
- (1) Supply the EUT with a new battery. Turn the EUT OFF and place it inside the environmental temperature chamber.
  - (2) Set the temperature control on the chamber to +50 degrees C and allow the oscillator heater and the chamber temperature to stabilize.
  - (3) While maintaining a constant temperature inside the environmental chamber, turn the EUT ON and record the operating frequency at startup, and at 2 minutes, 5 minutes, and 10 minutes after the EUT is energized. Four measurements in total are made.
  - (4) Switch OFF the EUT. Lower the chamber temperature by not more than 10 °C, and allow the temperature inside the chamber to stabilize. Repeat step 3) through step 4) down to the lowest specified temperature.
  - (5) At a temperature of 20°C, record the frequency at 85% and 115% of the nominal supply voltage.

**Used Test Equipment List:**

Signal and Spectrum Analyzer, Programmable Temperature & Humidity Test Chamber, Regulated DC Power supply. Refer to Clause 5 Test Equipment List for details.

The frequency is 13.56MHz, under unnormal conditions, it's should be within  $\pm 0.01\%$ : 13.558644 - 13.561356MHz

Temperature: 50°C:

time	Measured Frequency (MHz)	Result
0 minutes	13.560032	Pass
2 minutes	13.560033	Pass
5 minutes	13.560033	Pass
10 minutes	13.560032	Pass

Temperature: 40°C:

**TEST REPORT**

time	Measured Frequency (MHz)	Result
0 minutes	13.560032	Pass
2 minutes	13.560031	Pass
5 minutes	13.560031	Pass
10 minutes	13.560032	Pass

Temperature: 30°C:

time	Measured Frequency (MHz)	Result
0 minutes	13.560031	Pass
2 minutes	13.560030	Pass
5 minutes	13.560031	Pass
10 minutes	13.560031	Pass

Temperature: 20°C:

time	Measured Frequency (MHz)	Result
0 minutes	13.560032	Pass
2 minutes	13.560031	Pass
5 minutes	13.560032	Pass
10 minutes	13.560030	Pass

Temperature: 10°C:

time	Measured Frequency (MHz)	Result
0 minutes	13.560032	Pass
2 minutes	13.560032	Pass
5 minutes	13.560031	Pass
10 minutes	13.560032	Pass

Temperature: 0°C:

time	Measured Frequency (MHz)	Result
0 minutes	13.560032	Pass
2 minutes	13.560030	Pass
5 minutes	13.560031	Pass
10 minutes	13.560032	Pass

Temperature: -10°C:

time	Measured Frequency (MHz)	Result
0 minutes	13.560031	Pass
2 minutes	13.560030	Pass
5 minutes	13.560031	Pass

**TEST REPORT**

10 minutes	13.560032	Pass
------------	-----------	------

Temperature: -20°C:

time	Measured Frequency (MHz)	Result
0 minutes	13.560030	Pass
2 minutes	13.560030	Pass
5 minutes	13.560031	Pass
10 minutes	13.560030	Pass

Temperature: 20°C:

Power Supply (V AC)	Measured Frequency (MHz)	Result
85%	13.560029	Pass
95%	13.560030	Pass
105%	13.560030	Pass
115%	13.560031	Pass



## TEST REPORT

### 4.5 Conducted Emission Test

Test Configuration:

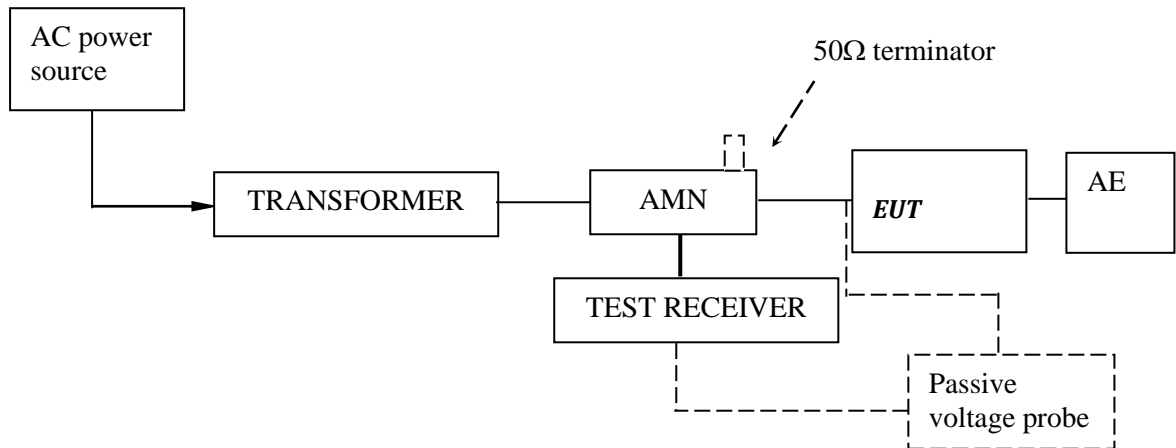

Test Setup and Procedure:

Test was performed according to ANSI C63.10 Clause 6.2. The EUT was set to achieve the maximum emission level. The mains terminal disturbance voltage was measured with the EUT in a shielded room. The EUT was connected to AC power source through an Artificial Mains Network which provides a 50Ω linear impedance Artificial hand is used if appropriate (for handheld apparatus). The load/control terminal disturbance voltage was measured with passive voltage probe if appropriate.

The table-top EUT was placed on a 0.8m high non-metallic table above earthed ground plane (Ground Reference Plane). And for floor standing EUT, was placed on a 12 mm high non-metallic supported on GRP. The EUT keeps a distance of at least 0.8m from any other of the metallic surface. The Artificial Mains Network is situated at a distance of 0.8m from the EUT.

During the test, mains lead of EUT excess 0.8m was folded back and forth parallel to the lead so as to form a horizontal bundle with a length between 0.3m and 0.4m

The bandwidth of test receiver was set at 9 kHz. The frequency range from 150 kHz to 30MHz was checked.

**TEST REPORT**

Test Data and Curve

At main terminal:

Tested Wire: Live

Operation Mode: transmitting mode

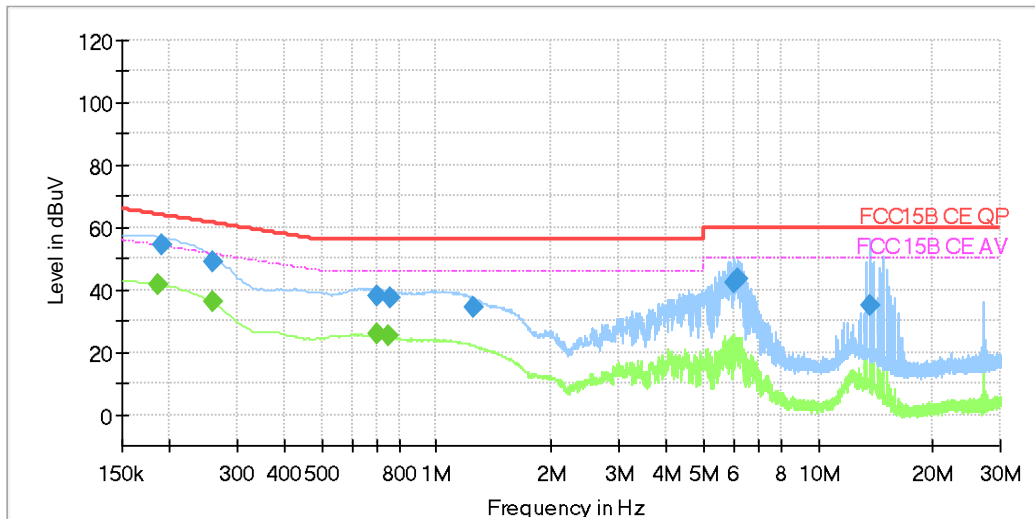

**Final Result**

Frequency (MHz)	QuasiPeak (dBuV)	Average (dBuV)	Limit (dBuV)	Margin (dB)	Meas. Time (ms)	Bandwidth (kHz)	Line	Corr. (dB)
0.186000	---	41.74	54.21	12.47	1000.0	9.000	L1	10.5
0.190000	54.63	---	64.04	9.41	1000.0	9.000	L1	10.5
0.258000	---	35.94	51.50	15.56	1000.0	9.000	L1	10.4
0.258000	48.65	---	61.50	12.85	1000.0	9.000	L1	10.4
0.698000	---	26.07	46.00	19.93	1000.0	9.000	L1	10.4
0.702000	37.71	---	56.00	18.29	1000.0	9.000	L1	10.4
0.746000	---	25.31	46.00	20.69	1000.0	9.000	L1	10.4
0.754000	37.10	---	56.00	18.90	1000.0	9.000	L1	10.4
1.250000	34.44	---	56.00	21.56	1000.0	9.000	L1	10.4
6.030000	42.11	---	60.00	17.89	1000.0	9.000	L1	10.5
6.126000	43.56	---	60.00	16.44	1000.0	9.000	L1	10.5
13.598000	34.77	---	60.00	25.23	1000.0	9.000	L1	10.6

Remark:

1. Corr. (dB) = LISN Factor (dB) + Cable Loss (dB)
2. Level (dBμV) = Corr. (dB) + Read Level (dBμV)
3. Delta Limit (dB) = Level (dBμV)-Limit (dBμV)

**TEST REPORT**

Tested Wire: Neutral

Operation Mode: transmitting mode

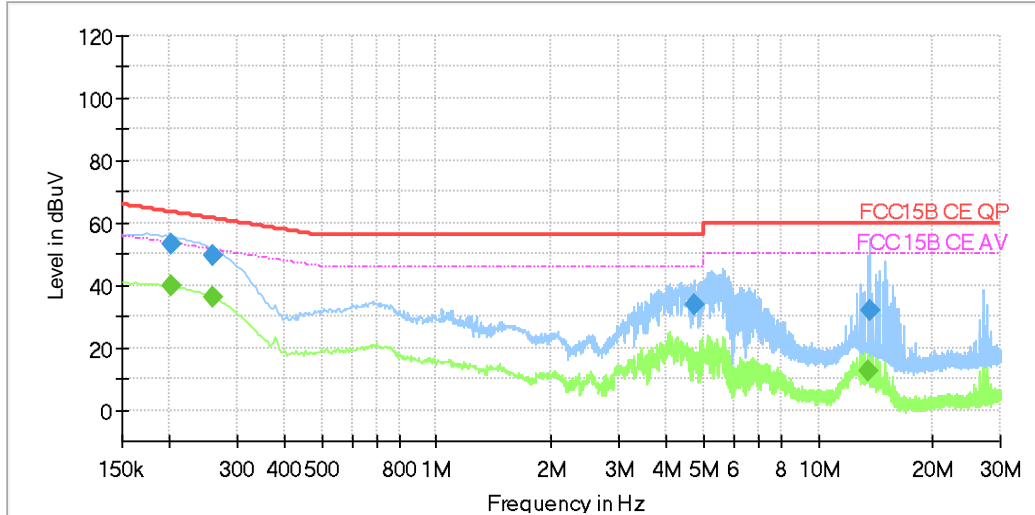

**Final\_Result**

Frequency (MHz)	QuasiPeak (dBuV)	Average (dBuV)	Limit (dBuV)	Margin (dB)	Meas. Time (ms)	Bandwidth (kHz)	Line	Corr. (dB)
0.202000	---	39.72	53.53	13.80	1000.0	9.000	N	10.5
0.202000	53.36	---	63.53	10.17	1000.0	9.000	N	10.5
0.258000	---	36.18	51.50	15.32	1000.0	9.000	N	10.4
0.258000	49.56	---	61.50	11.94	1000.0	9.000	N	10.4
4.718000	33.80	---	56.00	22.20	1000.0	9.000	N	10.5
13.470000	---	12.53	50.00	37.47	1000.0	9.000	N	10.6
13.690000	32.17	---	60.00	27.83	1000.0	9.000	N	10.6

Remark:

1. Corr. (dB) = LISN Factor (dB) + Cable Loss (dB)
2. Level (dBμV) = Corr. (dB) + Read Level (dBμV)
3. Delta Limit (dB) = Level (dBμV)-Limit (dBμV)Test Data and Curve

## TEST REPORT

### 5.0 Test Equipment List

Radiated Emission/Radio					
Equipment No.	Equipment	Model	Manufacturer	Cal. Due date (YYYY-MM-DD)	Calibration Interval
EM030-04	3m Semi-Anechoic Chamber	9×6×6 m <sup>3</sup>	ETS• LINDGREN	2024-04-10	1Y
EM031-02	EMI Test Receiver (9 kHz~7 GHz)	R&S ESR7	R&S	2024-11-15	1Y
EM031-03	Signal and Spectrum Analyzer (10 Hz~40 GHz)	R&S FSV40	R&S	2024-11-12	1Y
EM011-04	Loop antenna (9 kHz-30 MHz)	HFH2-Z2	R&S	2024-07-02	1Y
EM033-01	TRILOG Super Broadband test Antenna(30 MHz-3 GHz) (RX)	VULB 9163	SCHWARZBECK	2024-12-05	1Y
EM033-02	Bouble-Ridged Waveguide Horn Antenna (800 MHz-18 GHz)(RX)	R&S HF907	R&S	2024-07-02	1Y
EM033-03	High Frequency Antenna & preamplifier(18 GHz~26.5 GHz) (RX)	R&S SCU-26	R&S	2024-04-22	1Y
EM033-04	High Frequency Antenna & preamplifier (26 GHz-40 GHz)	R&S SCU-40	R&S	2024-04-22	1Y
EM031-02-01	Coaxial cable(9 kHz-1 GHz)	N/A	R&S	2024-04-10	1Y
EM033-02-02	Coaxial cable(1 GHz-18 GHz)	N/A	R&S	2024-04-10	1Y
EM033-04-02	Coaxial cable(18 GHz-40 GHz)	N/A	R&S	2024-04-22	1Y
EM031-01	Signal Generator (9 kHz~6 GHz)	SMB100A	R&S	2024-07-19	1Y
EM040-01	Band Reject/Notch Filter	WRHFV	Wainwright	N/A	1Y
EM040-02	Band Reject/Notch Filter	WRCGV	Wainwright	N/A	1Y
EM040-03	Band Reject/Notch Filter	WRCGV	Wainwright	N/A	1Y
EM022-03	2.45 GHz Filter	BRM50702	Micro-Tronics	2024-05-09	1Y
SA016-29	Climatic Test Chamber	MHU-80L	JIANQIAO	2025-01-03	1Y
EM046-05	Power meter	NPR6A	R&S	2024-04-19	1Y
EM046-06	Power meter	NPR6A	R&S	2024-04-19	1Y
EM045-01-01	EMC32 software (RE/RS)	V10.01.00	R&S	N/A	N/A
Conducted Disturbance-Mains Terminal (2)					
Equipment No.	Equipment	Model	Manufacturer	Cal. Due date (DD-MM-YYYY)	Calibration Interval
EM031-04	EMI receiver	ESR3	R&S	04/01/2025	1Y
EM032-02	LISN	NSLK8128	SCHWARZBECK	13/07/2024	1Y
SA047-111	Digital Temperature-Humidity Recorder	RS210	YIJIE	22/10/2024	1Y
EM004-03	EMC shield Room	8m×4m×3m	Zhongyu	03/01/2025	1Y
EM031-04-01	EMC32 software (CE)	V10.01.00	R&S	N/A	1Y

\*\*\*\*\*End of the test report\*\*\*\*\*