



TEST REPORT

FCC PART 15.247

Report Reference No.....: CTL2401242041-WF

Compiled by: Happy Guo
(position+printed name+signature) (File administrators)

Tested by: Snow Tang
(position+printed name+signature) (Test Engineer)

Approved by: Ivan Xie
(position+printed name+signature) (Manager)

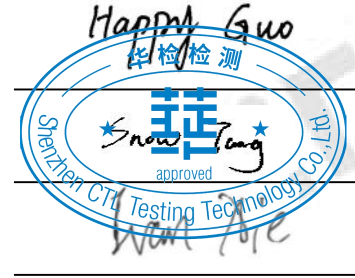

Product Name.....: Electronic Label

Model/Type reference.....: PW75R_V1

List Model(s).....: PW42R_V1, PW42R_V2, PW42_V2, PW75_V1, PW102R_V1,
PW102_V1, PW133R_V1, PW75R_D, PW75R_DM,
PW1085R_D, PW1085R_V1, PW133C_V1

Trade Mark.....: N/A

FCC ID.....: 2BCKG-PW75RV1

Applicant's name.....: Picksmart Technology Co., Limited

Address of applicant.....: Room406, Deguanting Business Center, Xin'an 3rd Road, Bao'an
28th District, Shenzhen City, China, 518109

Test Firm.....: Shenzhen CTL Testing Technology Co., Ltd.

Address of Test Firm.....: Floor 1-A, Baisha Technology Park, No.3011, Shahexi Road,
Nanshan District, Shenzhen, China 518055

Test specification.....:

Standard.....: FCC Part 15.247: Operation within the bands 902-928 MHz,
2400-2483.5 MHz and 5725-5850 MHz.

TRF Originator.....: Shenzhen CTL Testing Technology Co., Ltd.

Master TRF.....: Dated 2011-01

Date of receipt of test item.....: Jan. 25, 2024

Date of Test Date.....: Jan. 25, 2024-Mar. 04, 2024

Date of Issue.....: Mar. 08, 2024

Result.....: Pass

Shenzhen CTL Testing Technology Co., Ltd. All rights reserved.

This publication may be reproduced in whole or in part for non-commercial purposes as long as the Shenzhen CTL Testing Technology Co., Ltd. is acknowledged as copyright owner and source of the material. Shenzhen CTL Testing Technology Co., Ltd. takes no responsibility for and will not assume liability for damages resulting from the reader's interpretation of the reproduced material due to its placement and context.

TEST REPORT

Test Report No. :	CTL2401242041-WF	Mar. 08, 2024
		Date of issue

Equipment under Test : Electronic Label

Sample No : CTL2401242041

Model /Type : PW75R_V1

Listed Models : PW42R_V1, PW42R_V2, PW42_V2, PW75_V1,
PW102R_V1, PW102_V1, PW133R_V1, PW75R_D,
PW75R_DM, PW1085R_D, PW1085R_V1,
PW133C_V1

Applicant : **Picksmart Technology Co., Limited**

Address : Room406,Deguanging Business Center,Xin'an 3rd
Road,Bao'an 28th District,Shenzhen City,
China,518109

Manufacturer : **Picksmart Technology Co., Limited**

Address : Room406,Deguanging Business Center,Xin'an 3rd
Road,Bao'an 28th District,Shenzhen City,
China,518109

Test result	Pass *
--------------------	---------------

* In the configuration tested, the EUT complied with the standards specified page 5.

The test results presented in this report relate only to the object tested.

This report shall not be reproduced, except in full, without the written approval of the issuing testing laboratory.

Table of Contents

Page

1. SUMMARY	5
1.1. TEST STANDARDS	5
1.2. TEST DESCRIPTION	5
1.3. TEST FACILITY	6
1.4. STATEMENT OF THE MEASUREMENT UNCERTAINTY	6
2. GENERAL INFORMATION	8
2.1. ENVIRONMENTAL CONDITIONS	8
2.2. GENERAL DESCRIPTION OF EUT	8
2.3. DESCRIPTION OF TEST MODES AND TEST FREQUENCY	9
2.4. EQUIPMENTS USED DURING THE TEST	10
2.5. RELATED SUBMITTAL(S) / GRANT (S)	11
2.6. MODIFICATIONS	11
3. TEST CONDITIONS AND RESULTS	12
3.1. CONDUCTED EMISSIONS TEST	12
3.2. RADIATED EMISSIONS AND BAND EDGE	15
3.3. MAXIMUM CONDUCTED OUTPUT POWER	29
3.4. POWER SPECTRAL DENSITY	30
3.5. 6DB BANDWIDTH	31
3.6. OUT-OF-BAND EMISSIONS	32
3.7. ANTENNA REQUIREMENT	33
4. TEST SETUP PHOTOS OF THE EUT	34
5. PHOTOS OF THE EUT	35

1. SUMMARY

1.1. TEST STANDARDS

The tests were performed according to following standards:

[FCC Rules Part 15.247](#): Frequency Hopping, Direct Spread Spectrum and Hybrid Systems that are in operation within the bands of 902-928 MHz, 2400-2483.5 MHz, and 5725-5850 MHz

[ANSI C63.10: 2013](#): American National Standard for Testing Unlicensed Wireless Devices

[KDB 558074 D01 15.247 Meas Guidance v05r02](#) : Guidance for Performing Compliance Measurements on Digital Transmission Systems (DTS) Operating Under §15.247

1.2. Test Description

FCC PART 15.247		
FCC Part 15.207	AC Power Conducted Emission	PASS
FCC Part 15.247(a)(2)	6dB Bandwidth	PASS
FCC Part 15.247(d)	Spurious RF Conducted Emission	PASS
FCC Part 15.247(b)	Maximum Conducted Output Power	PASS
FCC Part 15.247(e)	Power Spectral Density	PASS
FCC Part 15.109/ 15.205/ 15.209	Radiated Emissions	PASS
FCC Part 15.247(d)	Band Edge	PASS
FCC Part 15.203/15.247 (b)	Antenna Requirement	PASS

1.3. Test Facility

1.3.1 Address of the test laboratory

Shenzhen CTL Testing Technology Co.,Ltd.
Floor 1-A, Baisha Technology Park, No.3011, Shahehexi Road, Nanshan District, Shenzhen, China
518055

There is one 3m semi-anechoic chamber and two line conducted labs for final test. The Test Sites meet the requirements in documents ANSI C63.10 and CISPR 32/EN 55032 requirements.

1.3.2 Laboratory accreditation

The test facility is recognized, certified, or accredited by the following organizations:

CNAS-Lab Code: L7497

Shenzhen CTL Testing Technology Co., Ltd. has been assessed and proved to be in compliance with CNAS-CL01 Accreditation Criteria for Testing and Calibration Laboratories (identical to ISO/IEC 17025: 2017 General Requirements) for the Competence of Testing and Calibration Laboratories.

A2LA-Lab Cert. No. 4343.01

Shenzhen CTL Testing Technology Co., Ltd, EMC Laboratory has been accredited by A2LA for technical competence in the field of electrical testing, and proved to be in compliance with ISO/IEC 17025: 2017 General Requirements for the Competence of Testing and Calibration Laboratories and any additional program requirements in the identified field of testing.

IC Registration No.: 9618B

CAB identifier: CN0041

The 3m alternate test site of Shenzhen CTL Testing Technology Co., Ltd. EMC Laboratory has been registered by Innovation, Science and Economic Development Canada to test to Canadian radio equipment requirements with Registration No.: 9618B on Jan. 22, 2019.

FCC-Registration No.: 399832

Designation No.: CN1216

Shenzhen CTL Testing Technology Co., Ltd. EMC Laboratory has been registered and fully described in a report filed with the (FCC) Federal Communications Commission. The acceptance letter from the FCC is maintained in our files. Registration 399832, December 08, 2017.

1.4. Statement of the measurement uncertainty

The data and results referenced in this document are true and accurate. The reader is cautioned that there may be errors within the calibration limits of the equipment and facilities. The measurement uncertainty was calculated for all measurements listed in this test report acc. to CISPR 16 - 4 "Specification for radio disturbance and immunity measuring apparatus and methods – Part 4: Uncertainty in EMC Measurements" and is documented in the Shenzhen CTL Testing Technology Co., Ltd. quality system acc. to DIN EN ISO/IEC 17025. Furthermore, component and process variability of devices similar to that tested may result in additional deviation. The manufacturer has the sole responsibility of continued compliance of the device.

Hereafter the best measurement capability for CTL laboratory is reported:

Test	Measurement Uncertainty	Notes
Transmitter power Radiated	± 2.20 dB	(1)
Radiated Emission 9KHz~30MHz	± 3.66 dB	(1)
Radiated Emission 30~1000MHz	± 4.10 dB	(1)
Radiated Emission Above 1GHz	± 4.32 dB	(1)
DTS Bandwidth	$\pm 1.9\%$	(1)
Maximum Conducted Output Power	± 1.18 dB	(1)
Maximum Power Spectral Density Level	± 0.98 dB	(1)
Band-edge	± 1.21 dB	(1)
Unwanted Emissions In Non-restricted Freq Bands	9kHz-7GHz: ± 1.09 dB 7GHz-26.5GHz: ± 3.27 dB	(1)

(1) This uncertainty represents an expanded uncertainty expressed at approximately the 95% confidence level using a coverage factor of $k=1.96$.

2. GENERAL INFORMATION

2.1. Environmental conditions

During the measurement the environmental conditions were within the listed ranges:

Normal Temperature:	25°C
Relative Humidity:	55 %
Air Pressure:	101 kPa

2.2. General Description of EUT

Product Name:	Electronic Label
Model/Type reference:	PW75R_V1
Power supply:	DC 3.7V from battery
2.4G WIFI	
Supported type:	802.11b/802.11g/802.11n(H20)
Modulation:	802.11b: DSSS 802.11g/802.11n(H20): OFDM
Operation frequency:	802.11b/802.11g/802.11n(H20): 2412MHz~2462MHz
Channel number:	802.11b/802.11g/802.11n(H20): 11
Channel separation:	5MHz
Antenna type:	FPC Antenna
Antenna gain:	3.32dBi

Note1: For more details, please refer to the user's manual of the EUT.

Note2: Antenna gain provided by the applicant.

2.3. Description of Test Modes and Test Frequency

The Applicant provides communication tools software to control the EUT for staying in continuous transmitting (Duty Cycle more than 98%) and receiving mode for testing.

There are 11 channels provided to the EUT and Channel 01/03/06/09/11 were selected for WIFI test.

Operation Frequency WIFI :

Channel	Frequency(MHz)	Channel	Frequency(MHz)
1	2412	8	2447
2	2417	9	2452
3	2422	10	2457
4	2427	11	2462
5	2432		
6	2437		
7	2442		

Note: The line display in grey were the channel selected for testing

Data Rate Used:

Preliminary tests were performed in different data rate to find the worst radiated emission. The data rate shown in the table below is the worst-case rate with respect to the specific test item. Investigation has been done on all the possible configurations for searching the worst cases. The following table is a list of the test modes shown in this test report.

Test Items	Mode	Data Rate	Channel
Maximum Conducted Output Power Power Spectral Density 6dB Bandwidth Spurious RF conducted emission Radiated Emission 9kHz~1GHz& Radiated Emission 1GHz~10th Harmonic	11b/DSSS	1 Mbps	1/6/11
	11g/OFDM	6 Mbps	1/6/11
	11n(20MHz)/OFDM	6.5Mbps	1/6/11
Band Edge	11b/DSSS	1 Mbps	1/11
	11g/OFDM	6 Mbps	1/11
	11n(20MHz)/OFDM	6.5Mbps	1/11

2.4. Equipments Used during the Test

Conducted Emission						
Item	Test Equipment	Manufacturer	Model No.	Serial No.	Last Cal.	Cal.Due
	EMI Test Receiver	ROHDE & SCHWARZ	ESCI	1166.5950.03	2023/05/04	2024/05/03
	LISN	ROHDE & SCHWARZ	ESH2-Z5	860014/010	2023/05/04	2024/05/03
	Limitator	ROHDE & SCHWARZ	ESH3-Z2	100408	2023/05/04	2024/05/03
Software:						
Name of Software:				Version:		
ES-K1				V1.71		

Radiated Emissions and Band Edge					
Test Equipment	Manufacturer	Model No.	Serial No.	Calibration Date	Calibration Due Date
Active Loop Antenna	Da Ze	ZN30900A	/	2021/05/13	2024/05/12
Double cone logarithmic antenna	Schwarzbeck	VULB 9168	824	2023/02/13	2026/02/12
Horn Antenna	Sunol Sciences Corp.	DRH-118	A062013	2021/12/23	2024/12/22
Horn Antenna	Ocean Microwave	OBH1004 00	26999002	2021/12/22	2024/12/21
Amplifier	MRT-AP01M 06	MRT	S-001	2023/05/04	2024/05/03
Amplifier	Agilent	8449B	3008A02306	2023/05/04	2024/05/03
Amplifier	Brief&Smart	LNA-4018	2104197	2023/05/05	2024/05/04
EMI Test Receiver	ROHDE & SCHWARZ	ESCI	1166.5950.03	2023/05/04	2024/05/03
Spectrum Analyzer	RS	FSP	1164.4391.38	2023/05/05	2024/05/04
Test software					
Name of Software			Version		
EZ_EMG(Below 1GHz)			V1.1.4.2		
EZ_EMG(Above 1GHz)			V1.1.4.2		

Maximum Conducted Output Power & Power Spectral Density & 6dB Bandwidth & Out-of-band Emissions					
Test Equipment	Manufacturer	Model No.	Serial No.	Calibration Date	Calibration Due Date
Spectrum Analyzer	Keysight	N9020A	MY53420874	2023/05/04	2024/05/03
Temperature/Humidity Meter	Ji Yu	MC501	/	2023/05/09	2024/05/08
Test Software					

Name of Software	Version
TST-PASS	V2.0

2.5. Related Submittal(s) / Grant (s)

This submittal(s) (test report) is intended to comply with Section 15.247 of the FCC Part 15, Subpart C Rules.

2.6. Modifications

No modifications were implemented to meet testing criteria.

3. TEST CONDITIONS AND RESULTS

3.1. Conducted Emissions Test

LIMIT

FCC CFR Title 47 Part 15 Subpart C Section 15.207

Frequency range (MHz)	Limit (dBuV)	
	Quasi-peak	Average
0.15-0.5	66 to 56*	56 to 46*
0.5-5	56	46
5-30	60	50

* Decreases with the logarithm of the frequency.

TEST CONFIGURATION

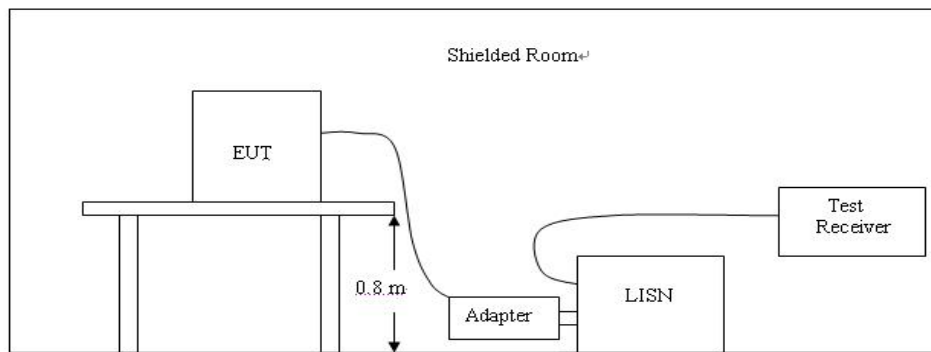

TEST PROCEDURE

1. The equipment was set up as per the test configuration to simulate typical actual usage per the user's manual. The EUT is a bObsweep Pet Hair Vision Plus Robot Vacuum Cleaner op system; a wooden table with a height of 0.8 meters is used and is placed on the ground plane as per ANSI C63.10:2013.
2. Support equipment, if needed, was placed as per ANSI C63.10:2013.
3. All I/O cables were positioned to simulate typical actual usage as per ANSI C63.10:2013.
4. The adapter received AC120V/60Hz power through a Line Impedance Stabilization Network (LISN) which supplied power source and was grounded to the ground plane.
5. All support equipments received AC power from a second LISN, if any.
6. The EUT test program was started. Emissions were measured on each current carrying line of the EUT using a spectrum Analyzer / Receiver connected to the LISN powering the EUT. The LISN has two monitoring points: Line 1 (Hot Side) and Line 2 (Neutral Side). Two scans were taken: one with Line 1 connected to Analyzer / Receiver and Line 2 connected to a 50 ohm load; the second scan had Line 1 connected to a 50 ohm load and Line 2 connected to the Analyzer / Receiver.
7. Analyzer / Receiver scanned from 150 KHz to 30MHz for emissions in each of the test modes.
8. During the above scans, the emissions were maximized by cable manipulation.

TEST RESULTS

Remark:802.11b/802.11g/802.11n(H20) mode all have been tested ,only worse case is reported.

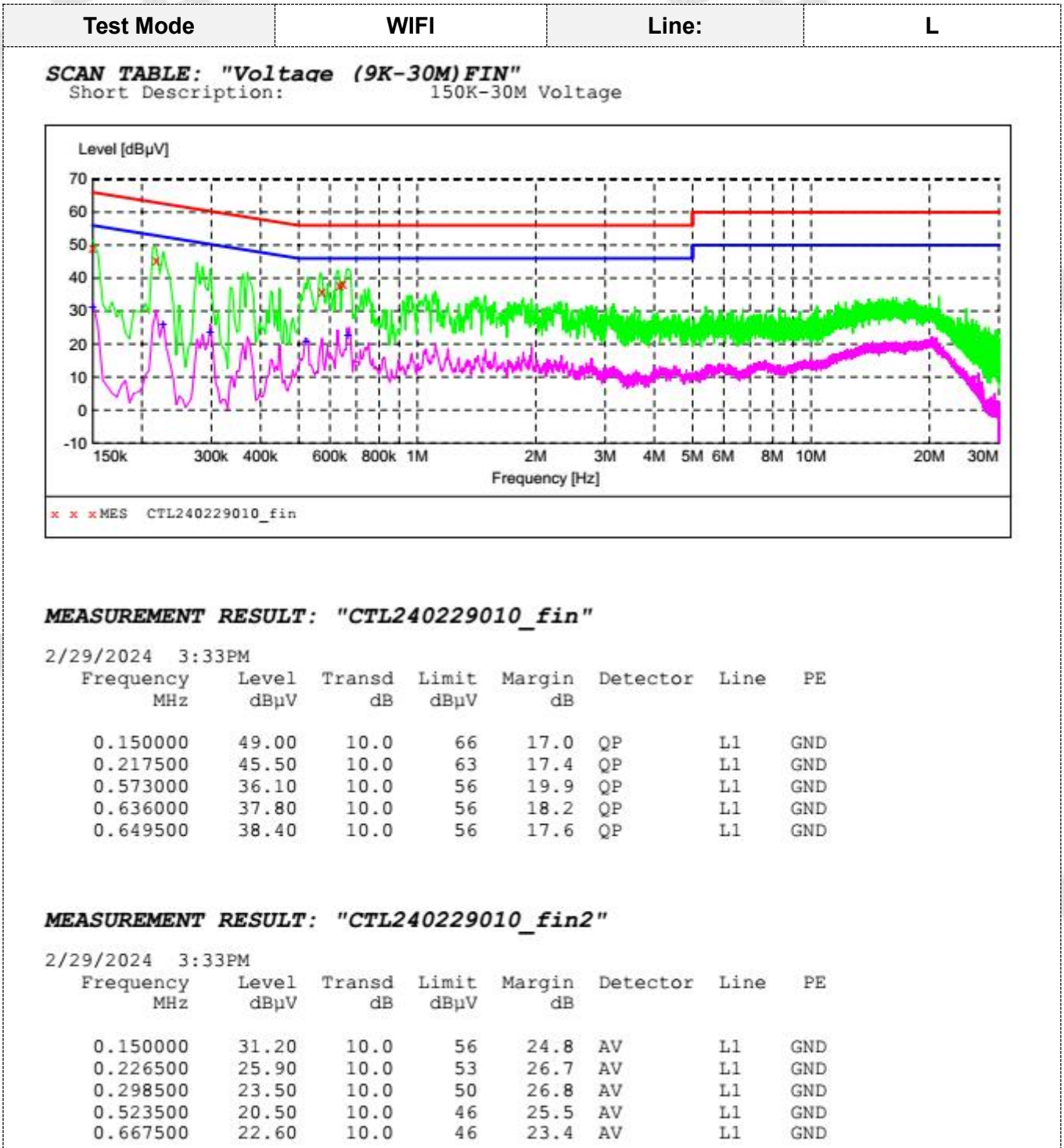

Test Mode	WIFI	Line:	N
-----------	------	-------	---

SCAN TABLE: "Voltage (9K-30M)FIN"
 Short Description: 150K-30M Voltage

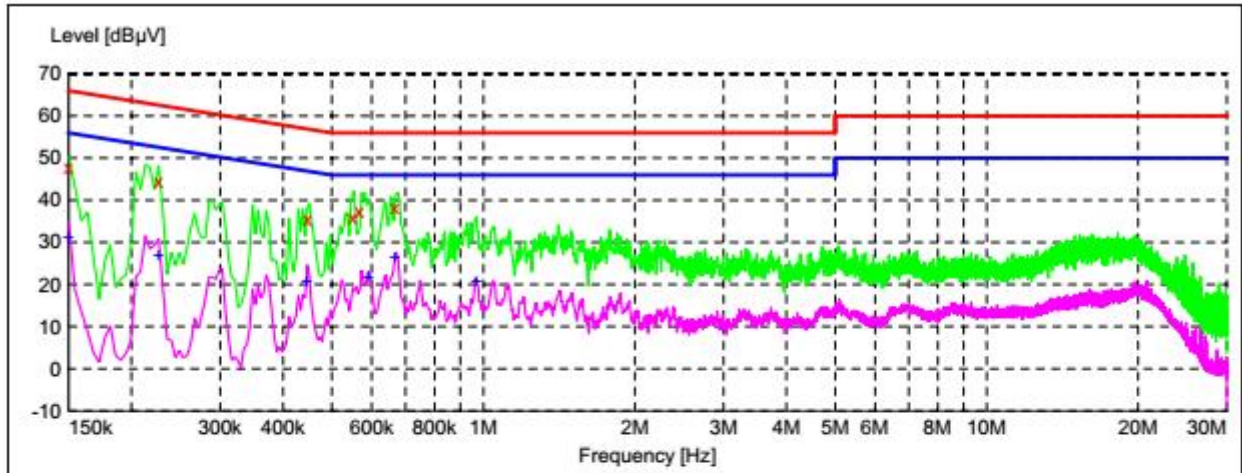

x x x MES CTL240229011_fin

MEASUREMENT RESULT: "CTL240229011_fin"

2/29/2024 3:36PM

Frequency MHz	Level dBµV	Transd dB	Limit dBµV	Margin dB	Detector	Line	PE
0.150000	47.70	10.0	66	18.3	QP	N	GND
0.226500	44.30	10.0	63	18.3	QP	N	GND
0.447000	35.60	10.0	57	21.3	QP	N	GND
0.550500	35.70	10.0	56	20.3	QP	N	GND
0.568500	37.10	10.0	56	18.9	QP	N	GND
0.667500	38.20	10.0	56	17.8	QP	N	GND

MEASUREMENT RESULT: "CTL240229011_fin2"

2/29/2024 3:36PM

Frequency MHz	Level dBµV	Transd dB	Limit dBµV	Margin dB	Detector	Line	PE
0.150000	31.30	10.0	56	24.7	AV	N	GND
0.226500	27.10	10.0	53	25.5	AV	N	GND
0.447000	20.60	10.0	47	26.3	AV	N	GND
0.591000	21.80	10.0	46	24.2	AV	N	GND
0.667500	26.40	10.0	46	19.6	AV	N	GND
0.969000	20.60	10.1	46	25.4	AV	N	GND

3.2. Radiated Emissions and Band Edge

Limit

For intentional device, according to § 15.209(a), the general requirement of field strength of radiated emission out of authorized band shall not exceed the following table at a 3 meters measurement distance.

In addition, radiated emissions which fall in the restricted bands, as defined in §15.205(a), must also comply with the radiated emission limits specified in §15.209(a)

Radiated emission limits

Frequency (MHz)	Distance (Meters)	Radiated (dBµV/m)	Radiated (µV/m)
0.009-0.49	3	$20\log(2400/F(\text{KHz})) + 40\log(300/3)$	$2400/F(\text{KHz})$
0.49-1.705	3	$20\log(24000/F(\text{KHz})) + 40\log(30/3)$	$24000/F(\text{KHz})$
1.705-30	3	$20\log(30) + 40\log(30/3)$	30
30-88	3	40.0	100
88-216	3	43.5	150
216-960	3	46.0	200
Above 960	3	54.0	500

TEST CONFIGURATION

(A) Radiated Emission Test Set-Up, Frequency Below 30MHz

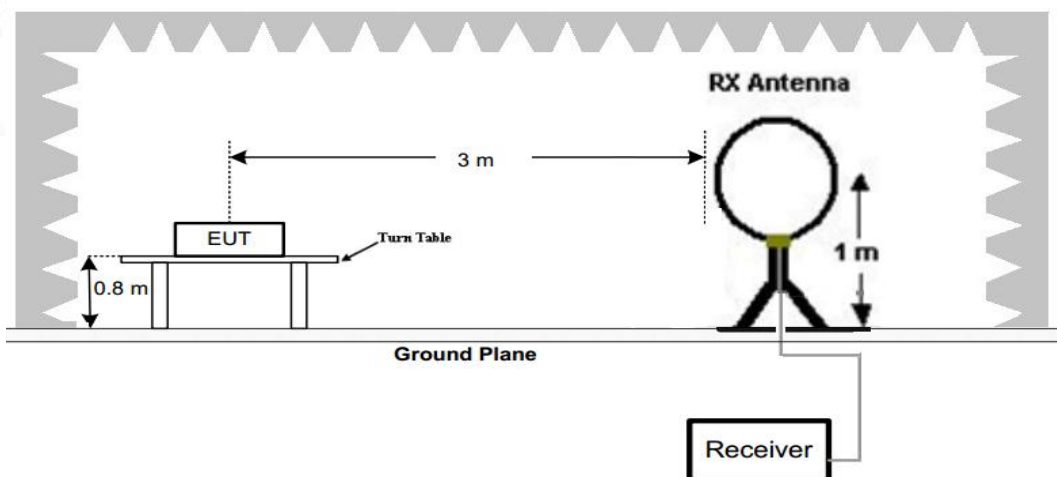

(B) Radiated Emission Test Set-Up, Frequency below 1000MHz

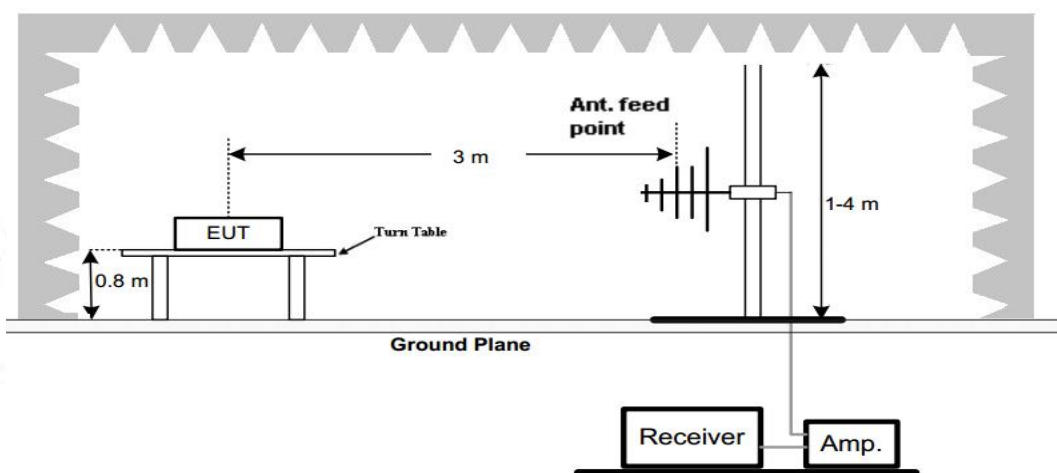

(C) Radiated Emission Test Set-Up, Frequency above 1000MHz

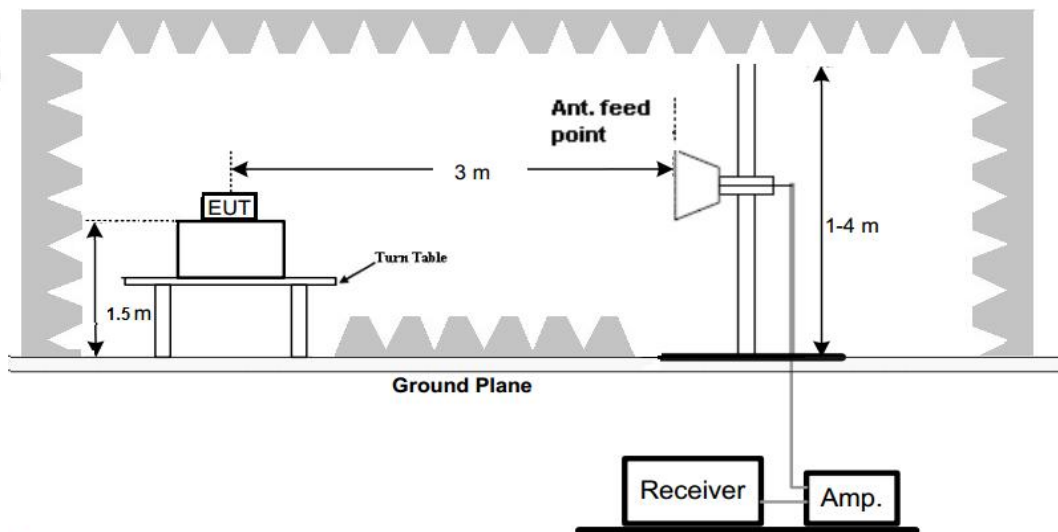

Test Procedure

1. Below 1GHz measurement the EUT is placed on a turntable which is 0.8m above ground plane, and above 1GHz measurement EUT was placed on a low permittivity and low loss tangent turn table which is 1.5m above ground plane.
2. Maximum procedure was performed by raising the receiving antenna from 1m to 4m and rotating the turn table from 0° to 360° to acquire the highest emissions from EUT
3. And also, each emission was to be maximized by changing the polarization of receiving antenna both horizontal and vertical.
4. Repeat above procedures until all frequency measurements have been completed.
5. The EUT was pretested with 3 orientations placed on the table for the radiated emission measurement –X, Y, and Z-plane. The X-plane results were found as the worst case and were shown in this report.

TEST RESULTS

Remark:

1. All three channels (lowest/middle/highest) of each mode were measured below 1GHz and recorded worst case at 802.11b low channel.
2. All three channels (lowest/middle/highest) of each mode were measured above 1GHz and recorded worst case at 802.11b mode.
3. Radiated emission test from 9 KHz to 10th harmonic of fundamental was verified, Found the emission level are attenuated 20dB below the limits from 9 kHz to 30MHz, so it does not recorded in report.

For 30MHz-1GHz

Test mode:	WIFI	Polarization:	Horizontal
------------	------	---------------	------------



Shenzhen CTL Testing Technology Co., Ltd
Tel: +86-755-89486194

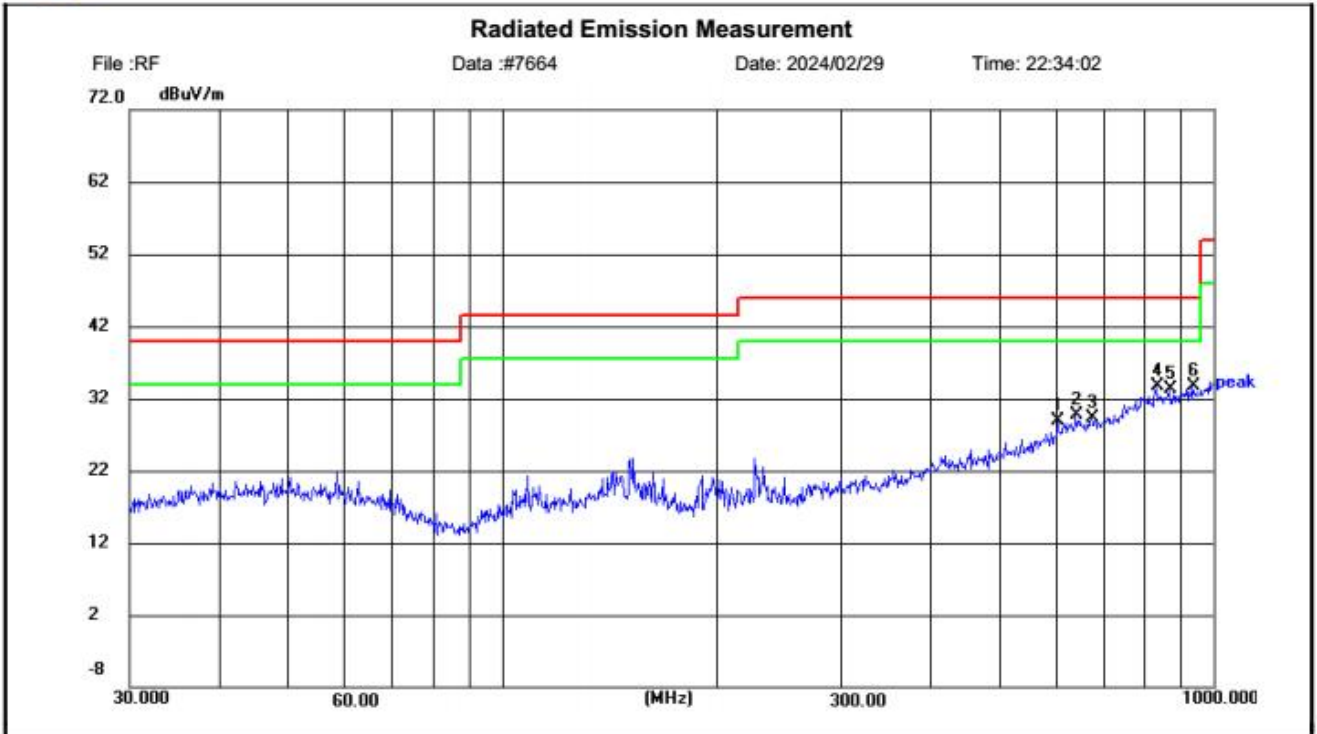

Site LAB Chamber 2 Polarization: **Horizontal** Temperature: 25(C)
 Limit: FCC Part15 RE-Class C_30-1000MHz Power: Humidity: 50 %
 EUT: / Distance: 3m
 M/N: PW75R_V1
 Mode: WIFI2.4G 2412MHz
 Note: Picksmart Technology Co., Limited

No.	Frequency (MHz)	Reading (dBuV)	Factor (dB/m)	Level (dBuV/m)	Limit (dBuV/m)	Margin (dB)	Detector	Height (cm)	Azimuth (deg.)	P/F	Remark
1	603.5391	7.02	21.86	28.88	46.00	17.12	peak	100	290	P	
2	640.6110	6.86	22.81	29.67	46.00	16.33	peak	100	281	P	
3	672.8444	6.66	22.61	29.27	46.00	16.73	peak	100	348	P	
4	830.4001	7.87	25.89	33.76	46.00	12.24	peak	100	156	P	
5	866.0879	6.92	26.29	33.21	46.00	12.79	peak	100	31	P	
6	935.5463	6.55	27.08	33.63	46.00	12.37	peak	100	204	P	

Test mode:	WIFI	Polarization:	Vertical
-------------------	-------------	----------------------	-----------------



Shenzhen CTL Testing Technology Co., Ltd
Tel: +86-755-89486194

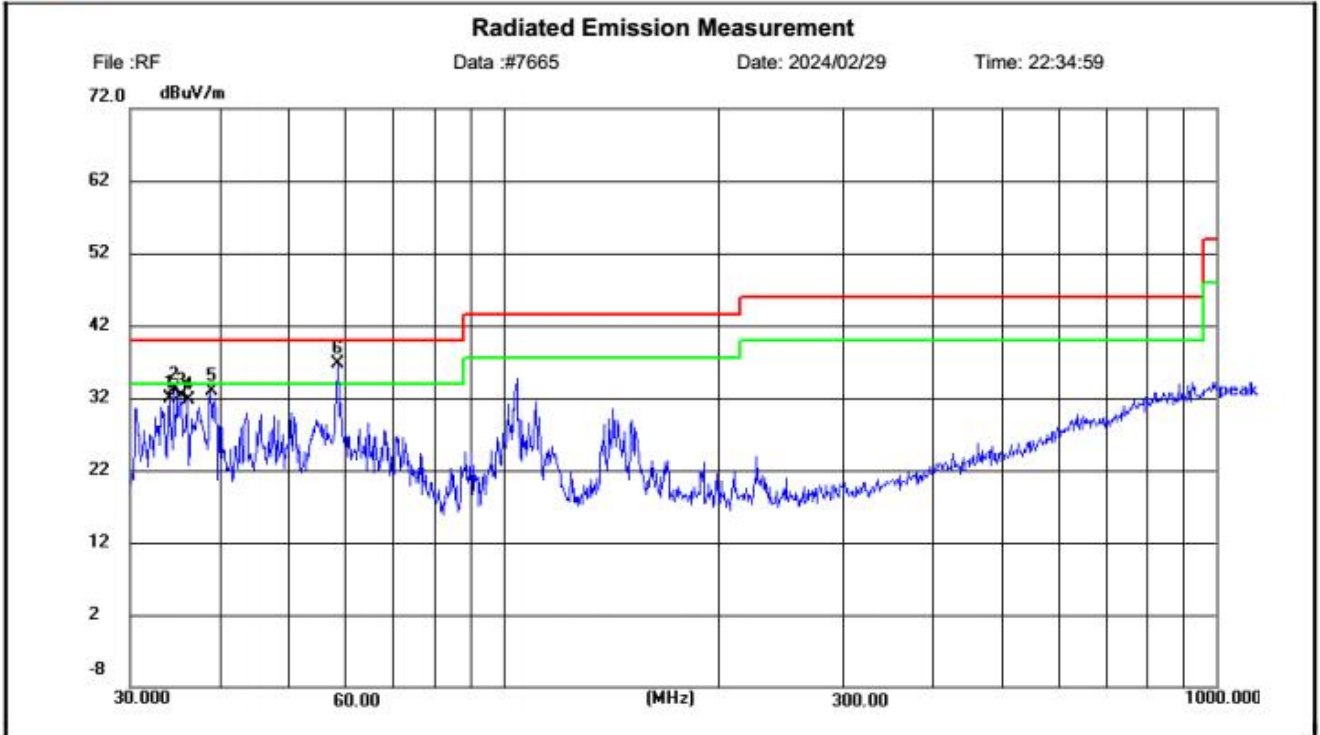

Site LAB Chamber 2	Polarization: Vertical	Temperature: 25(C)
Limit: FCC Part15 RE-Class C_30-1000MHz	Power:	Humidity: 50 %
EUT: /	Distance: 3m	
M/N: PW75R_V1		
Mode: WIFI2.4G 2412MHz		
Note: Picksmart Technology Co., Limited		

No.	Frequency (MHz)	Reading (dBuV)	Factor (dB/m)	Level (dBuV/m)	Limit (dBuV/m)	Margin (dB)	Detector	Height (cm)	Azimuth (deg.)	P/F	Remark
1	34.0365	18.67	13.29	31.96	40.00	8.04	peak	100	215	P	
2	34.6385	19.61	13.41	33.02	40.00	6.98	peak	100	351	P	
3	35.2512	18.65	13.57	32.22	40.00	7.78	peak	100	340	P	
4	36.1272	17.81	13.81	31.62	40.00	8.38	peak	100	0	P	
5	38.8878	18.81	14.09	32.90	40.00	7.10	peak	100	301	P	
6	58.6126	22.71	13.95	36.66	40.00	3.34	peak	100	311	P	

For 1GHz to 25GHz

802.11b Mode (above 1GHz)

Note: 802.11b/802.11g/802.11n (H20) all have been tested, only worse case 802.11b is reported



Shenzhen CTL Testing Technology Co., Ltd
Tel: +86-755-89486194

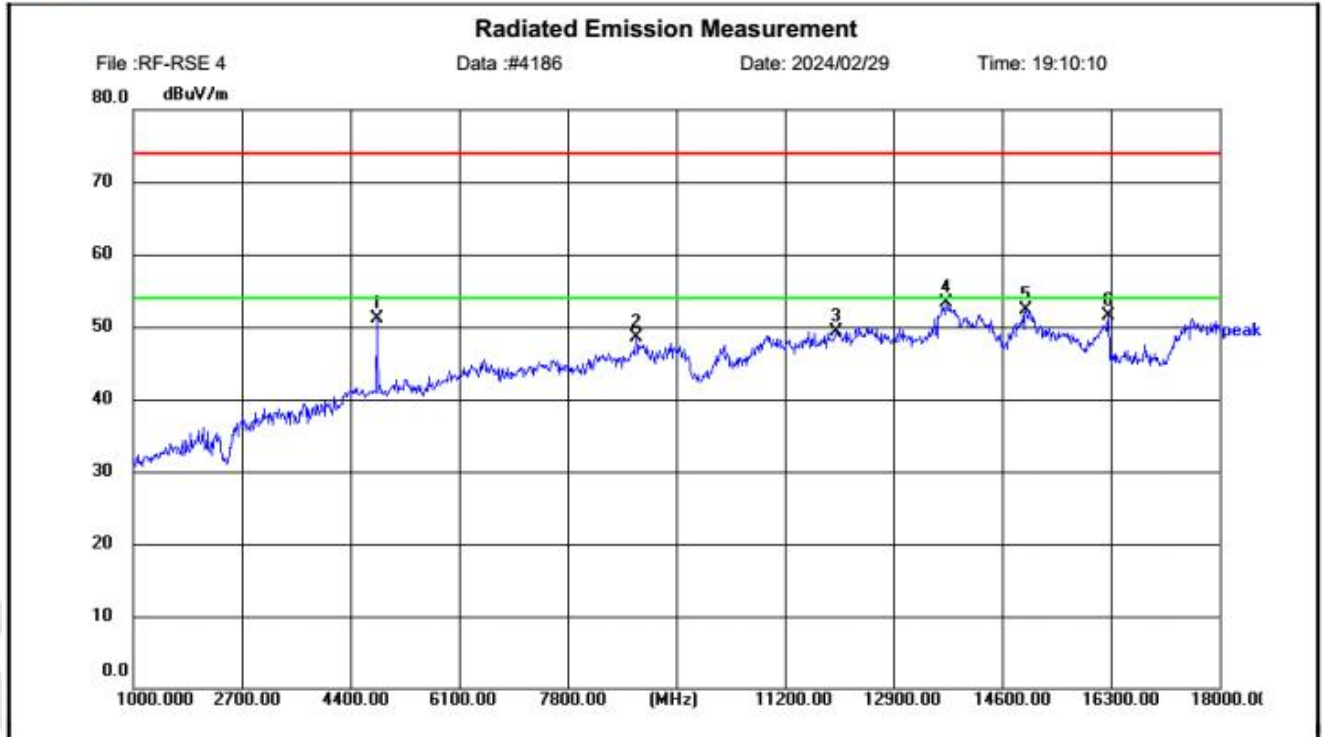

Site LAB Chamber 2 Polarization: **Horizontal** Temperature: 25(C)
 Limit: FCC Part15 RE-Class C_Above 1GHz_PK Power: Humidity: 50 %
 EUT: Distance: 3m
 M/N: PW75R_V1
 Mode: WIFI2.4G 2412MHz TX
 Note: Picksmart Technology Co., Limited

No.	Frequency (MHz)	Reading (dBuV)	Factor (dB/m)	Level (dBuV/m)	Limit (dBuV/m)	Margin (dB)	Detector	Height (cm)	Azimuth (deg.)	P/F	Remark
1	4822.875	59.09	-8.05	51.04	74.00	22.96	peak	150	108	P	
2	8875.250	49.09	-0.59	48.50	74.00	25.50	peak	150	2	P	
3	12013.875	47.18	2.21	49.39	74.00	24.61	peak	150	301	P	
4	13720.250	49.42	3.86	53.28	74.00	20.72	peak	150	146	P	
5	14976.125	48.97	3.29	52.26	74.00	21.74	peak	150	30	P	
6	16266.000	46.18	5.42	51.60	74.00	22.40	peak	150	214	P	



Shenzhen CTL Testing Technology Co., Ltd
Tel: +86-755-89486194

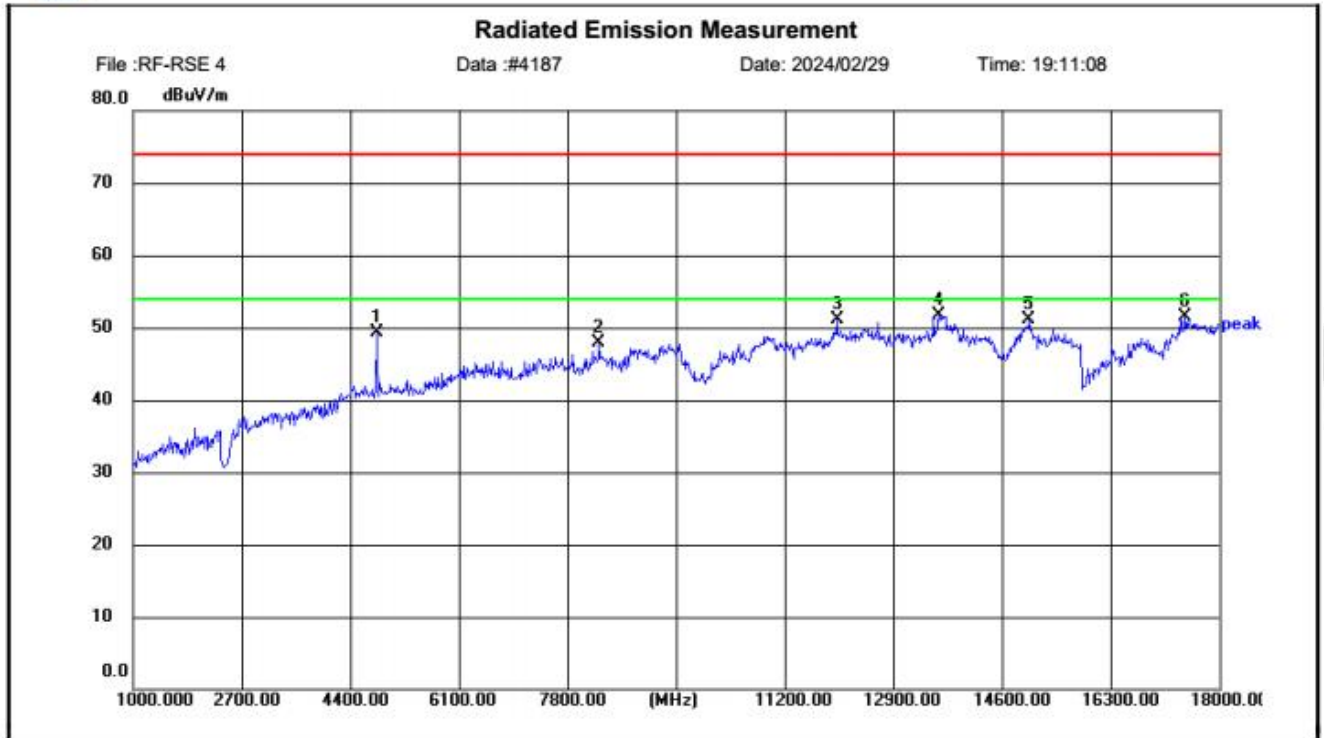

Site LAB Chamber 2

Polarization: **Vertical**

Temperature: 25(C)

Limit: FCC Part15 RE-Class C_Above 1GHz_PK

Power:

Humidity: 50 %

EUT:

Distance: 3m

M/N: PW75R_V1

Mode: WIFI2.4G 2412MHz TX

Note: Picksmart Technology Co., Limited

No.	Frequency (MHz)	Reading (dBuV)	Factor (dB/m)	Level (dBuV/m)	Limit (dBuV/m)	Margin (dB)	Detector	Height (cm)	Azimuth (deg.)	P/F	Remark
1	4822.875	57.44	-8.05	49.39	74.00	24.61	peak	150	20	P	
2	8301.500	50.01	-2.20	47.81	74.00	26.19	peak	150	204	P	
3	12022.375	48.91	2.20	51.11	74.00	22.89	peak	150	301	P	
4	13618.250	47.68	3.95	51.63	74.00	22.37	peak	150	98	P	
5	15033.500	47.82	3.37	51.19	74.00	22.81	peak	150	40	P	
6	17481.500	42.39	9.09	51.48	74.00	22.52	peak	150	243	P	



Shenzhen CTL Testing Technology Co., Ltd
Tel: +86-755-89486194

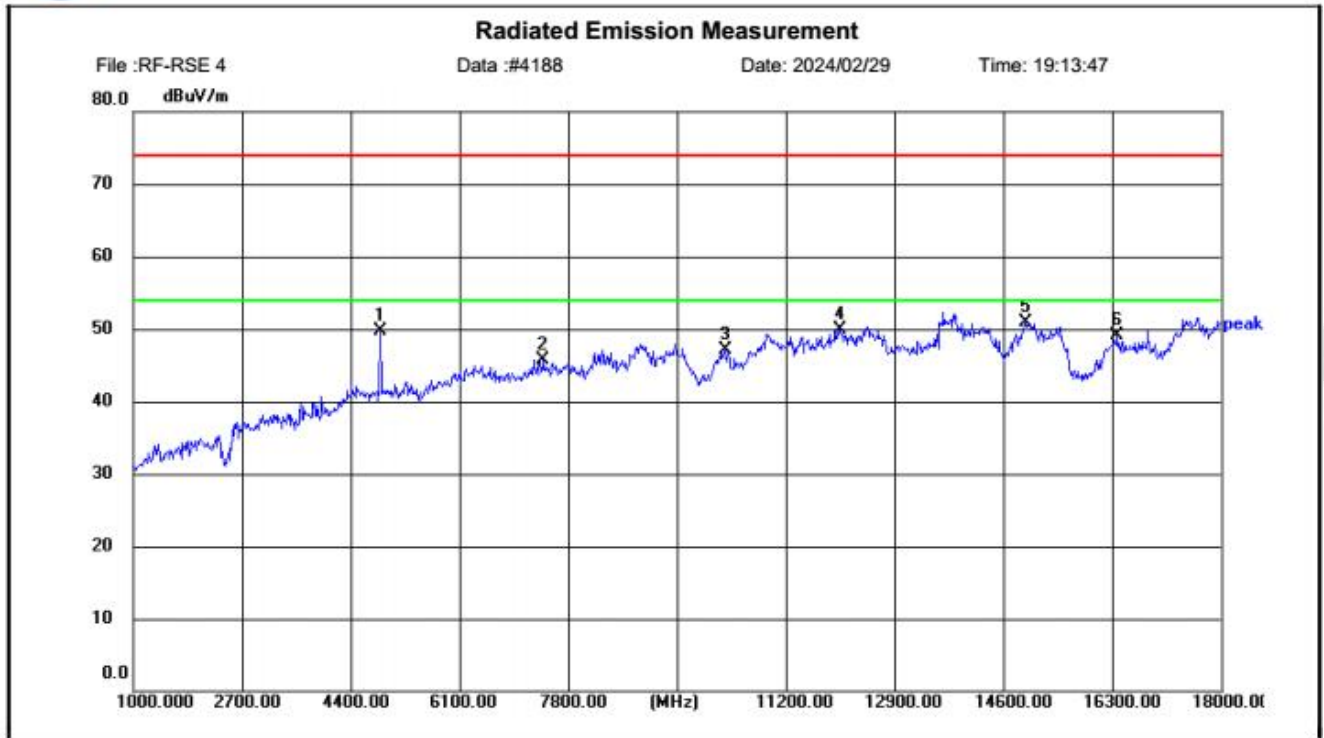

Site LAB Chamber 2	Polarization: Horizontal	Temperature: 25(C)
Limit: FCC Part15 RE-Class C_Above 1GHz_PK	Power:	Humidity: 50 %
EUT:	Distance: 3m	
M/N: PW75R_V1		
Mode: WIFI2.4G 2437MHz TX		
Note: Picksmart Technology Co., Limited		

No.	Frequency (MHz)	Reading (dBuV)	Factor (dB/m)	Level (dBuV/m)	Limit (dBuV/m)	Margin (dB)	Detector	Height (cm)	Azimuth (deg.)	P/F	Remark
1	4873.875	57.69	-7.97	49.72	74.00	24.28	peak	150	108	P	
2	7423.875	48.43	-2.80	45.63	74.00	28.37	peak	150	136	P	
3	10250.125	46.87	0.22	47.09	74.00	26.91	peak	150	184	P	
4	12054.250	47.70	2.19	49.89	74.00	24.11	peak	150	300	P	
5	14944.250	47.57	3.24	50.81	74.00	23.19	peak	150	30	P	
6	16399.875	43.24	5.80	49.04	74.00	24.96	peak	150	291	P	



Shenzhen CTL Testing Technology Co., Ltd
 Tel: +86-755-89486194

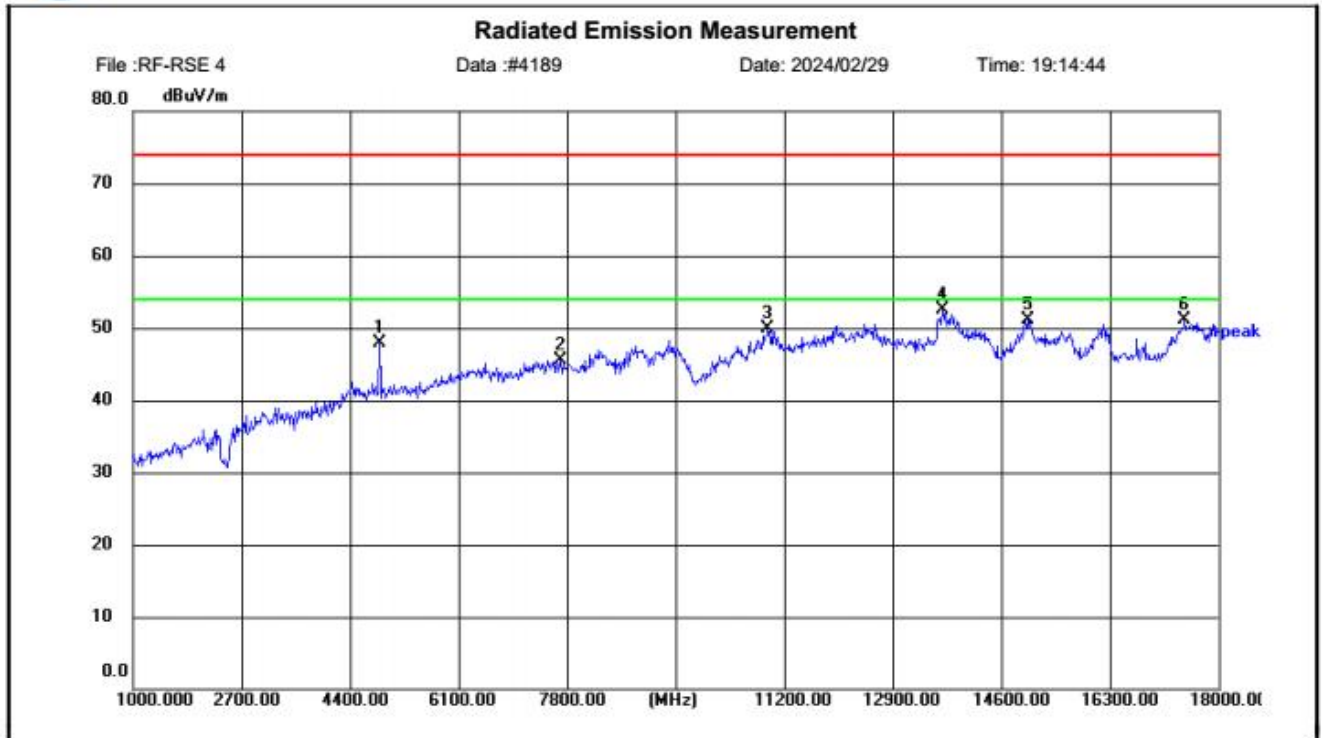

Site LAB Chamber 2

Polarization: **Vertical**

Temperature: 25(C)

Limit: FCC Part15 RE-Class C_Above 1GHz_PK

Power:

Humidity: 50 %

EUT:

Distance: 3m

M/N: PW75R_V1

Mode: WIFI2.4G 2437MHz TX

Note: Picksmart Technology Co., Limited

No.	Frequency (MHz)	Reading (dBuV)	Factor (dB/m)	Level (dBuV/m)	Limit (dBuV/m)	Margin (dB)	Detector	Height (cm)	Azimuth (deg.)	P/F	Remark
1	4873.875	55.95	-7.97	47.98	74.00	26.02	peak	150	19	P	
2	7712.875	48.45	-2.89	45.56	74.00	28.44	peak	150	233	P	
3	10953.500	49.11	0.72	49.83	74.00	24.17	peak	150	126	P	
4	13688.375	48.59	3.91	52.50	74.00	21.50	peak	150	233	P	
5	15014.375	47.80	3.36	51.16	74.00	22.84	peak	150	223	P	
6	17473.000	42.05	9.05	51.10	74.00	22.90	peak	150	58	P	



Shenzhen CTL Testing Technology Co., Ltd
Tel: +86-755-89486194

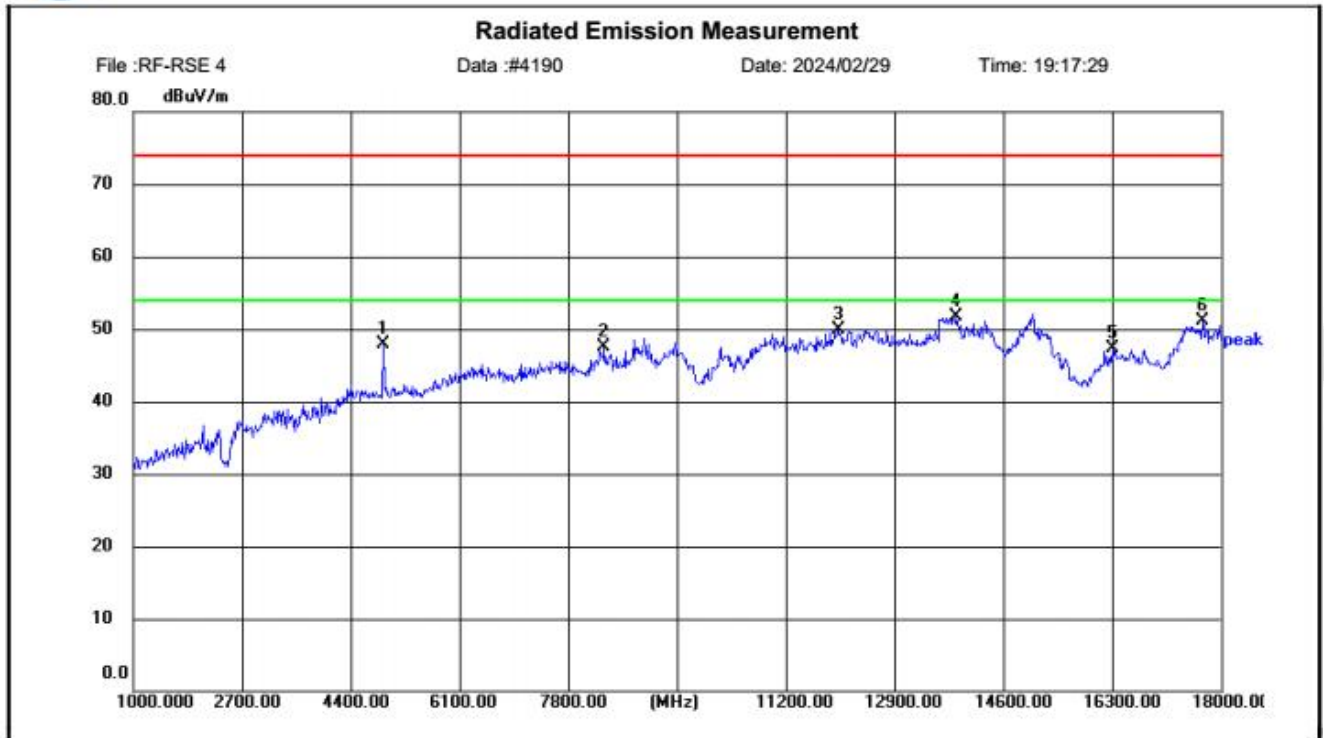

Site LAB Chamber 2 Polarization: **Horizontal** Temperature: 25(C)
 Limit: FCC Part15 RE-Class C_Above 1GHz_PK Power: Humidity: 50 %
 EUT: Distance: 3m
 M/N: PW75R_V1
 Mode: WIFI2.4G 2462MHz TX
 Note: Picksmart Technology Co., Limited

No.	Frequency (MHz)	Reading (dBuV)	Factor (dB/m)	Level (dBuV/m)	Limit (dBuV/m)	Margin (dB)	Detector	Height (cm)	Azimuth (deg.)	P/F	Remark
1	4922.750	55.76	-7.88	47.88	74.00	26.12	peak	150	98	P	
2	8361.000	49.61	-2.10	47.51	74.00	26.49	peak	150	281	P	
3	12028.750	47.71	2.20	49.91	74.00	24.09	peak	150	203	P	
4	13877.500	48.02	3.76	51.78	74.00	22.22	peak	150	175	P	
5	16310.625	41.79	5.55	47.34	74.00	26.66	peak	150	300	P	
6	17725.875	42.04	9.15	51.19	74.00	22.81	peak	150	49	P	



Shenzhen CTL Testing Technology Co., Ltd
Tel: +86-755-89486194

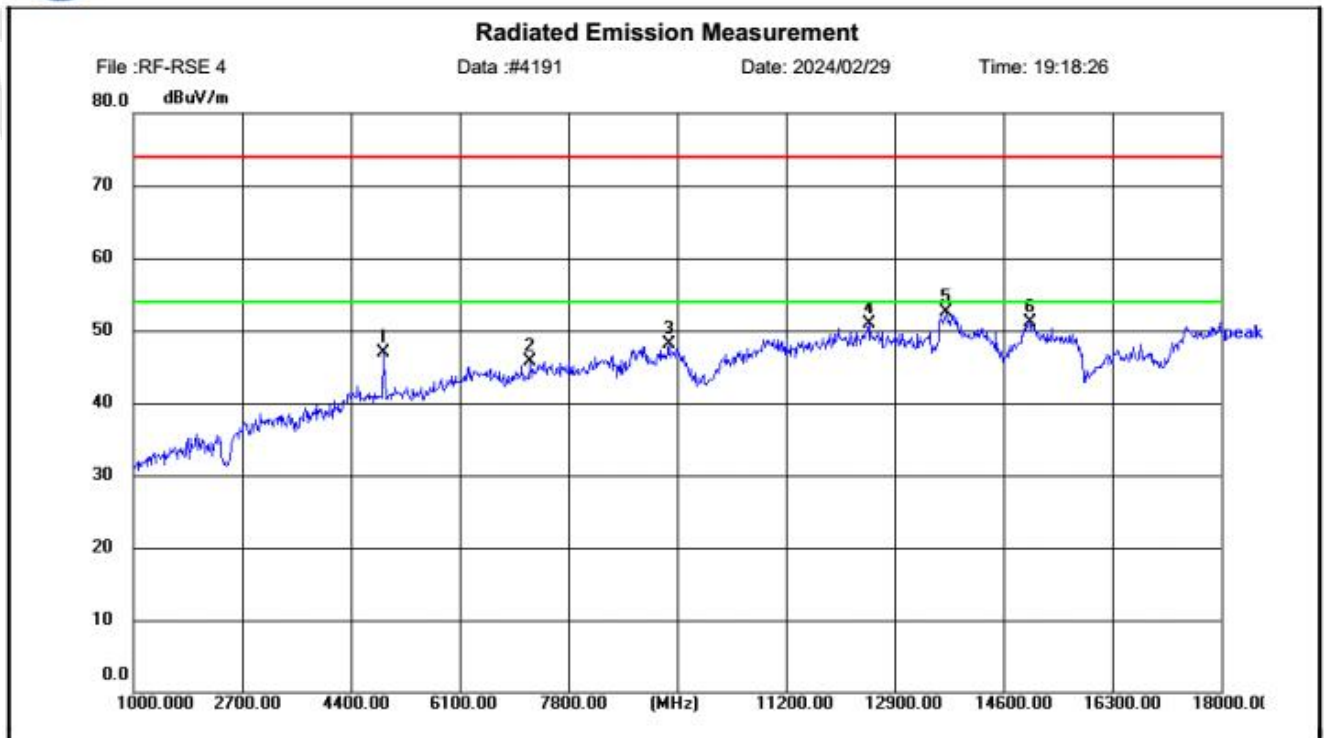

Site LAB Chamber 2 Polarization: **Vertical** Temperature: 25(C)
 Limit: FCC Part15 RE-Class C_Above 1GHz_PK Power: Humidity: 50 %
 EUT: Distance: 3m
 M/N: PW75R_V1
 Mode: WIFI2.4G 2462MHz TX
 Note: Picksmart Technology Co., Limited

No.	Frequency (MHz)	Reading (dBuV)	Factor (dB/m)	Level (dBuV/m)	Limit (dBuV/m)	Margin (dB)	Detector	Height (cm)	Azimuth (deg.)	P/F	Remark
1	4922.750	54.75	-7.88	46.87	74.00	27.13	peak	150	41	P	
2	7213.500	48.98	-3.26	45.72	74.00	28.28	peak	150	109	P	
3	9378.875	48.01	0.19	48.20	74.00	25.80	peak	150	128	P	
4	12492.000	48.62	2.27	50.89	74.00	23.11	peak	150	301	P	
5	13707.500	48.70	3.88	52.58	74.00	21.42	peak	150	331	P	
6	15022.875	47.78	3.36	51.14	74.00	22.86	peak	150	69	P	

REMARKS:

1. Emission level (dBuV/m) =Raw Value (dBuV)+Correction Factor (dB/m)
2. Correction Factor (dB/m) = Antenna Factor (dB/m)+Cable Factor (dB)-Pre-amplifier Factor
3. Margin value = Limit value- Emission level.
4. PK detector measurement value is lower than the average limit. Therefore, there is no need to test AV detector measurements.
5. RBW1MHz VBW3MHz Peak detector is for PK value; RBW 1MHz VBW10Hz Peak detector is for AV value.
6. Other emissions are attenuated 20dB below the limits from 9 kHz to 30MHz, so it does not recorded in report.
7. 18GHz-26GHz not recorded for no spurious point have a margin of less than 6 dB with respect to the limits.

Results of Band Edges Test (Radiated)

Note: 802.11b/802.11g/802.11n (H20) all have been tested, only worse case 802.11b is reported.



Shenzhen CTL Testing Technology Co., Ltd
Tel: +86-755-89486194

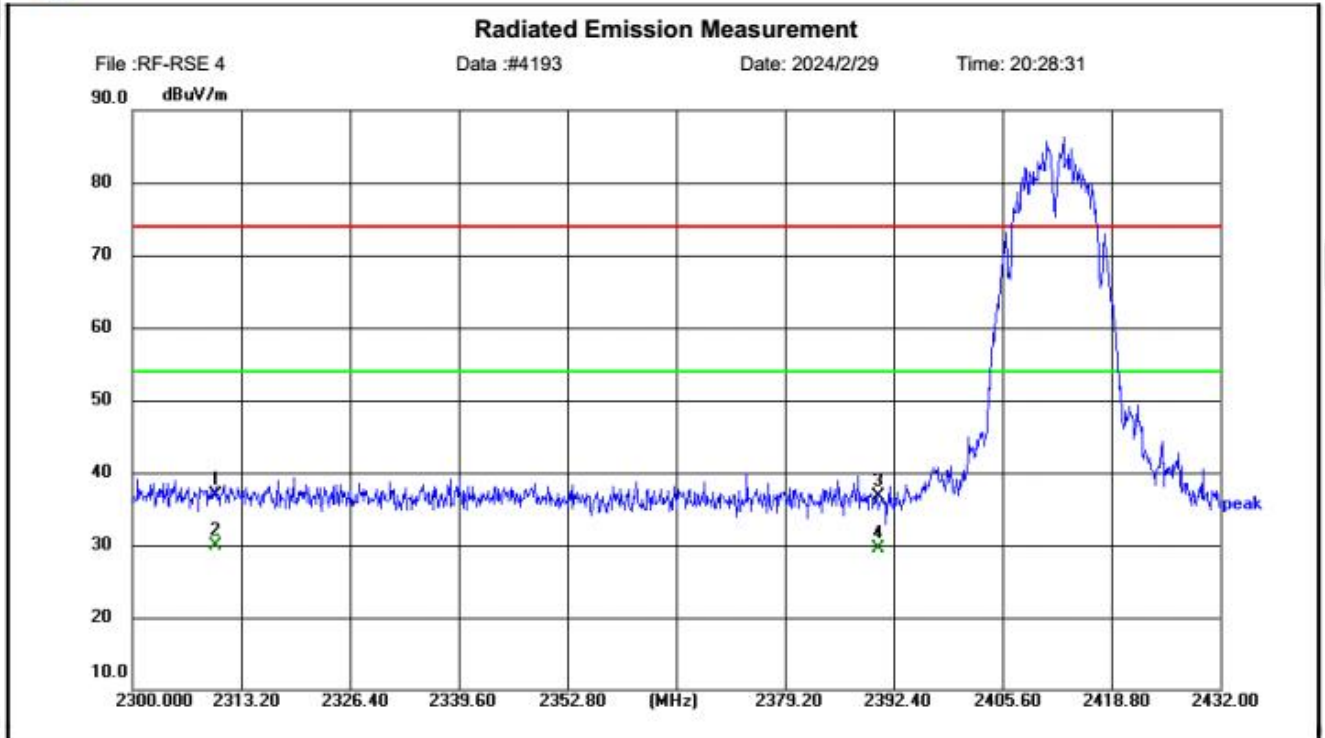

Site LAB Chamber 2 Polarization: **Horizontal** Temperature: 25(C)
Limit: FCC Part 15 C Power: Humidity: 50 %
EUT: Distance: 3m
M/N: PW75R_V1
Mode: WIFI 2.4G 2412MHz TX
Note: Picksmart Technology Co., Limited

No.	Frequency (MHz)	Reading (dBuV)	Factor (dB/m)	Level (dBuV/m)	Limit (dBuV/m)	Margin (dB)	Detector	Height (cm)	Azimuth (deg.)	P/F	Remark
1	2310.213	28.13	8.85	36.98	74.00	37.02	peak	150	360	P	
2	2310.213	21.08	8.85	29.93	54.00	24.07	AVG	150	0	P	
3	2390.470	27.85	8.88	36.73	74.00	37.27	peak	150	360	P	
4	2390.470	20.66	8.88	29.54	54.00	24.46	AVG	150	0	P	



Shenzhen CTL Testing Technology Co., Ltd
Tel: +86-755-89486194

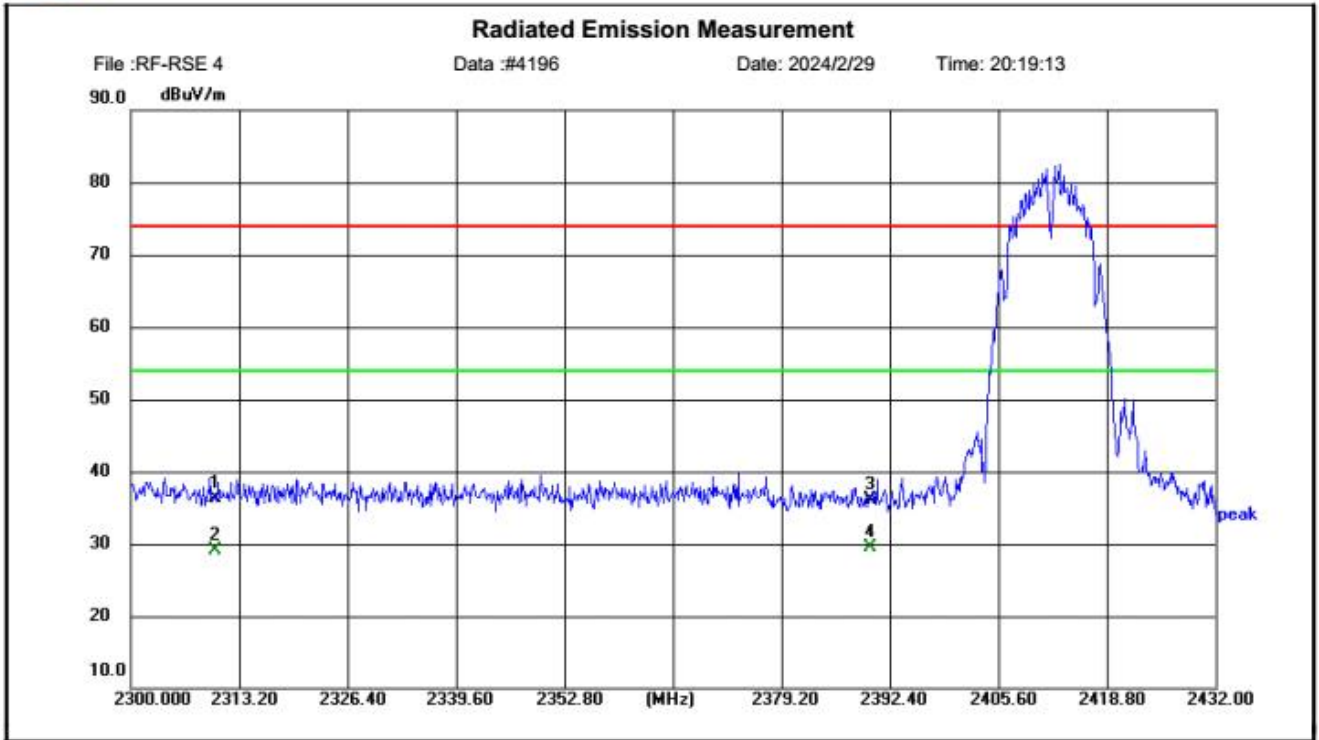

Site LAB Chamber 2
Limit: FCC Part 15 C
EUT:

Polarization: **Vertical**
Power:
Distance: 3m

Temperature: 25(C)
Humidity: 50 %

M/N: PW75R_V1
Mode: WIFI 2.4G 2412MHz TX
Note: Picksmart Technology Co., Limited

No.	Frequency (MHz)	Reading (dBuV)	Factor (dB/m)	Level (dBuV/m)	Limit (dBuV/m)	Margin (dB)	Detector	Height (cm)	Azimuth (deg.)	P/F	Remark
1	2310.263	27.49	8.85	36.34	74.00	37.66	peak	150	360	P	
2	2310.263	20.25	8.85	29.10	54.00	24.90	AVG	150	0	P	
3	2390.073	27.20	8.88	36.08	74.00	37.92	peak	150	360	P	
4	2390.073	20.59	8.88	29.47	54.00	24.53	AVG	150	0	P	



Shenzhen CTL Testing Technology Co., Ltd
Tel: +86-755-89486194

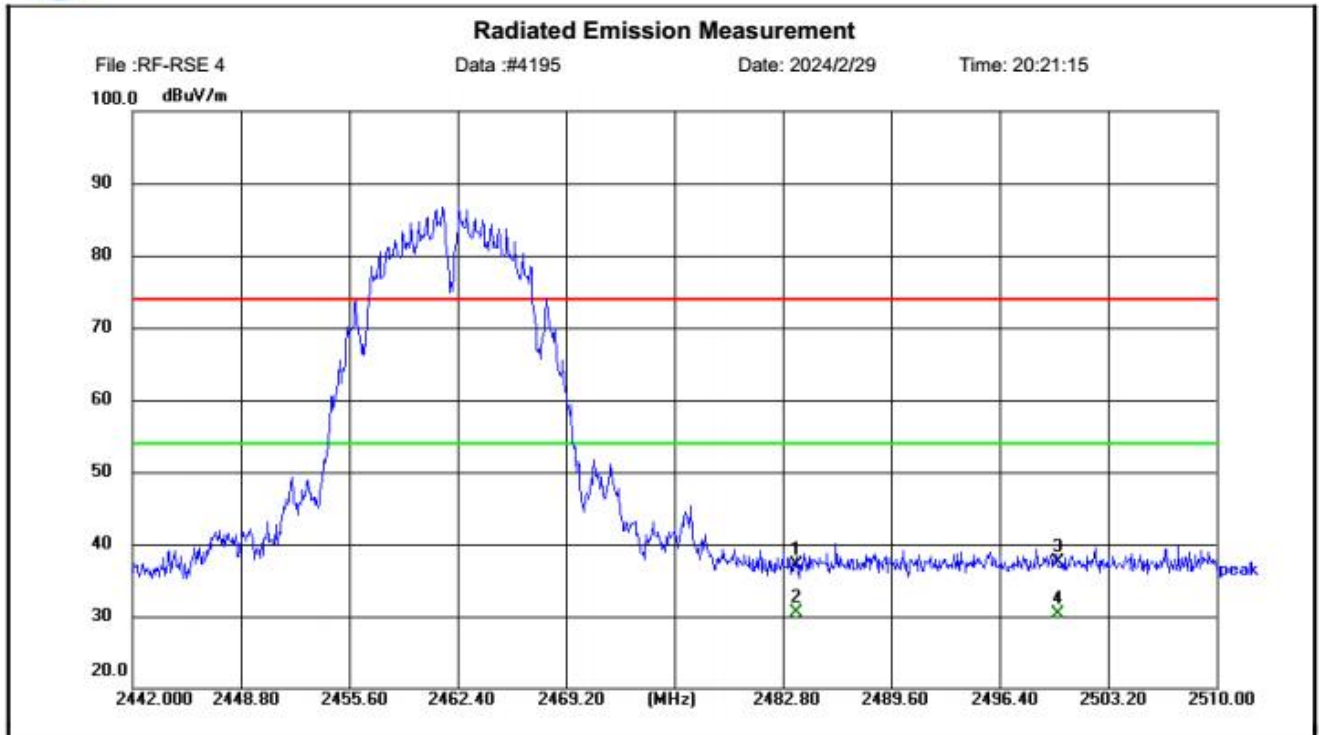

Site LAB Chamber 2	Polarization: Horizontal	Temperature: 25(C)
Limit: FCC Part 15 C	Power:	Humidity: 50 %
EUT:	Distance: 3m	
M/N: PW75R_V1		
Mode: WIFI 2.4G 2462MHz TX		
Note: Picksmart Technology Co., Limited		

No.	Frequency (MHz)	Reading (dBuV)	Factor (dB/m)	Level (dBuV/m)	Limit (dBuV/m)	Margin (dB)	Detector	Height (cm)	Azimuth (deg.)	P/F	Remark
1	2483.557	28.06	8.99	37.05	74.00	36.95	peak	150	360	P	
2	2483.557	21.49	8.99	30.48	54.00	23.52	AVG	150	0	P	
3	2500.004	28.39	9.05	37.44	74.00	36.56	peak	150	360	P	
4	2500.004	21.18	9.05	30.23	54.00	23.77	AVG	150	0	P	



Shenzhen CTL Testing Technology Co., Ltd
Tel: +86-755-89486194

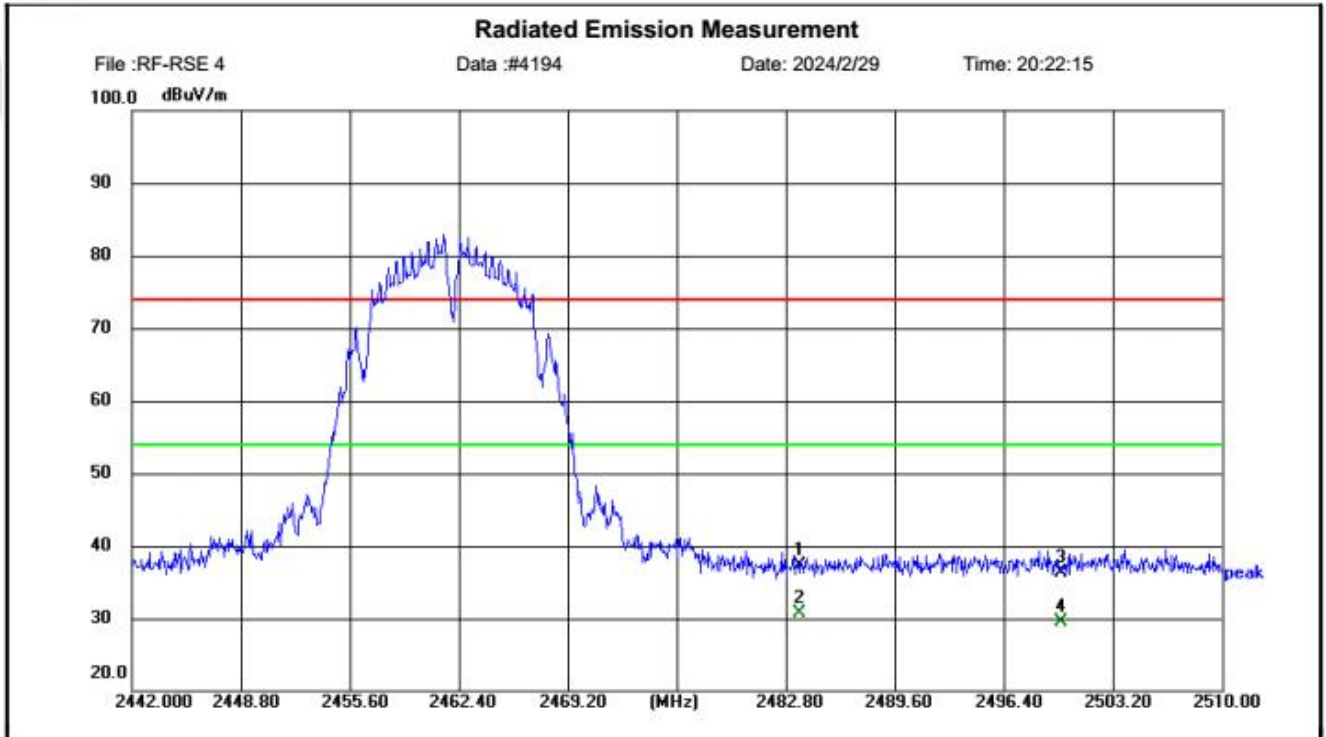

Site LAB Chamber 2	Polarization: Vertical	Temperature: 25(C)
Limit: FCC Part 15 C	Power:	Humidity: 50 %
EUT:	Distance: 3m	
M/N: PW75R_V1		
Mode: WIFI 2.4G 2462MHz TX		
Note: Picksmart Technology Co., Limited		

No.	Frequency (MHz)	Reading (dBUV)	Factor (dB/m)	Level (dBUV/m)	Limit (dBUV/m)	Margin (dB)	Detector	Height (cm)	Azimuth (deg.)	P/F	Remark
1	2483.582	28.28	8.99	37.27	74.00	36.73	peak	150	360	P	
2	2483.582	21.79	8.99	30.78	54.00	23.22	AVG	150	0	P	
3	2500.012	27.23	9.05	36.28	74.00	37.72	peak	150	360	P	
4	2500.012	20.49	9.05	29.54	54.00	24.46	AVG	150	0	P	

REMARKS:

1. Emission level (dBUV/m) =Raw Value (dBUV)+Correction Factor (dB/m)
2. Correction Factor (dB/m) = Antenna Factor (dB/m)+Cable Factor (dB)-Pre-amplifier Factor
3. Margin value = Limit value- Emission level.
4. PK detector measurement value is lower than the average limit. Therefore, there is no need to test AV detector measurements.
5. RBW1MHz VBW3MHz Peak detector is for PK value; RBW 1MHz VBW 10Hz Peak detector is for AV value.
6. For fundamental frequency, RBW 3MHz VBW 3MHz Peak detector is for PK Value; RMS detector is for AV value.
7. Other emissions are attenuated 20dB below the limits from 9kHz to 30MHz, so it does not recorded in report.

3.3. Maximum Conducted Output Power

Limit

The Maximum Peak Output Power Measurement is 30dBm.

Test Procedure

Remove the antenna from the EUT and then connect a low loss RF cable from the antenna port to the spectrum.

Test Configuration

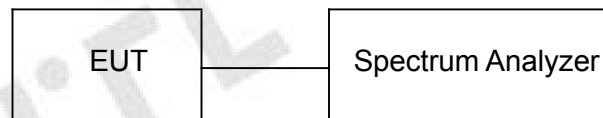

Test Results

Raw data reference to Section 2 of document No. CTL2401242041-WF_WIFI_2_4G_WLAN_Appendix.

3.4. Power Spectral Density

Limit

For digitally modulated systems, the power spectral density conducted from the intentional radiator to the antenna shall not be greater than 8 dBm in any 3 kHz band during any time interval of continuous transmission.

Test Procedure

1. Use this procedure when the maximum conducted output power in the fundamental emission is used to demonstrate compliance.
2. Set the RBW \geq 3 kHz.
3. Set the VBW \geq 3 \times RBW.
4. Set the span to 1.5 times the DTS channel bandwidth.
5. Detector = Average.
6. Trace mode = max hold.
7. Allow trace to fully stabilize.
8. Use the peak marker function to determine the maximum power level.
9. If measured value exceeds limit, reduce RBW (no less than 3 kHz) and repeat.
10. The resulting PSD level must be 8dBm.

Test Configuration

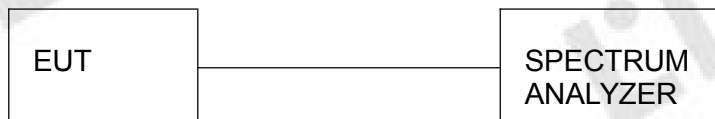

Test Results

Raw data reference to Section 3 of document No. CTL2401242041-WF_WIFI_2_4G_WLAN_Appendix.

3.5. 6dB Bandwidth

Limit

For digital modulation systems, the minimum 6 dB bandwidth shall be at least 500 kHz

Test Procedure

The transmitter output was connected to the spectrum analyzer through an attenuator. The bandwidth of the fundamental frequency was measured by spectrum analyzer with 100 KHz RBW and 300 KHz VBW. The 6dB bandwidth is defined as the total spectrum the power of which is higher than peak power minus 6dB.

Test Configuration



Test Results

Raw data reference to Section 1 of document No. CTL2401242041-WF_WIFI_2_4G_WLAN_Appendix.

3.6. Out-of-band Emissions

Limit

In any 100 kHz bandwidth outside the frequency band in which the spread spectrum or digitally modulated intentional radiator is operating, the radio frequency power that is produced by the intentional radiator shall be at least 20 dB below that in the 100 kHz bandwidth within the band that contains the highest level of the desired power, based on either an RF conducted or a radiated measurement, provided the transmitter demonstrates compliance with the peak conducted power limits. If the transmitter complies with the conducted power limits based on the use of RMS averaging over a time interval, as permitted under paragraph (b)(3) of this section, the attenuation required under this paragraph shall be 30 dB instead of 20 dB. Attenuation below the general limits specified in §15.209(a) is not required.

Test Procedure

Connect the transmitter output to spectrum analyzer using a low loss RF cable, and set the spectrum analyzer to RBW=100 kHz, VBW= 300 kHz, peak detector , and max hold. Measurements utilizing these setting are made of the in-band reference level, bandedge and out-of-band emissions.

Test Configuration



Test Results

Raw data reference to Section 4 of document No. CTL2401242041-WF_WIFI_2_4G_WLAN_Appendix.

3.7. Antenna Requirement

Standard Applicable

For intentional device, according to FCC 47 CFR Section 15.203:

An intentional radiator shall be designed to ensure that no antenna other than that furnished by the responsible party shall be used with the device. The use of a permanently attached antenna or of an antenna that uses a unique coupling to the intentional radiator, the manufacturer may design the unit so that a broken antenna can be replaced by the user, but the use of a standard antenna jack or electrical connector is prohibited

FCC CFR Title 47 Part 15 Subpart C Section 15.247(b) (4):

(4) The conducted output power limit specified in paragraph (b) of this section is based on the use of antennas with directional gains that do not exceed 6 dBi. Except as shown in paragraph (c) of this section, if transmitting antennas of directional gain greater than 6 dBi are used, the conducted output power from the intentional radiator shall be reduced below the stated values in paragraphs (b)(1), (b)(2), and (b)(3) of this section, as appropriate, by the amount in dB that the directional gain of the antenna exceeds 6 dBi.

Test Result:

The maximum gain of Antenna is 3.32dBi

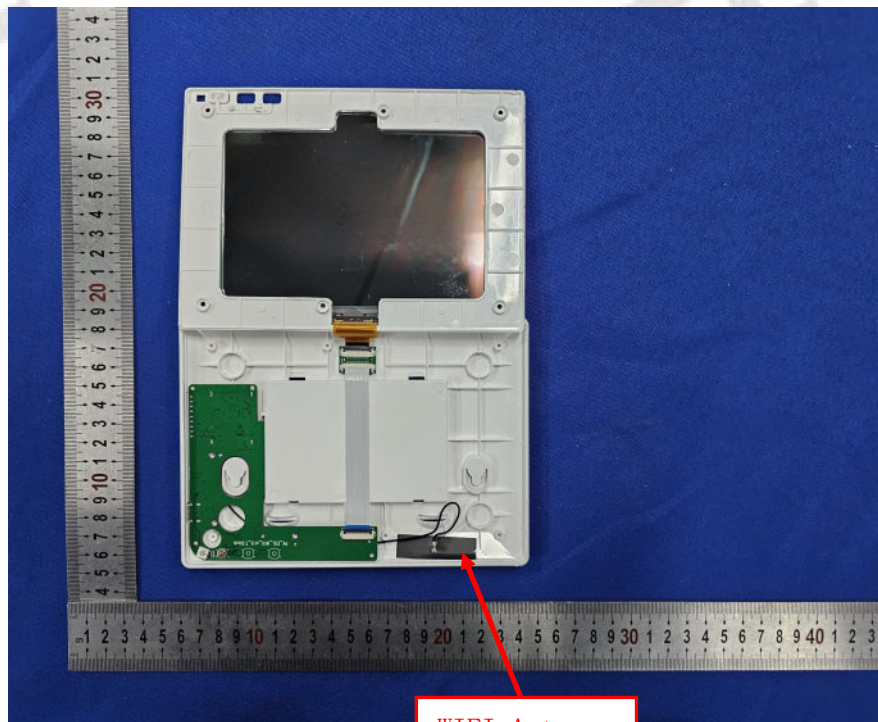

WIFI Antenna

4. Test Setup Photos of the EUT

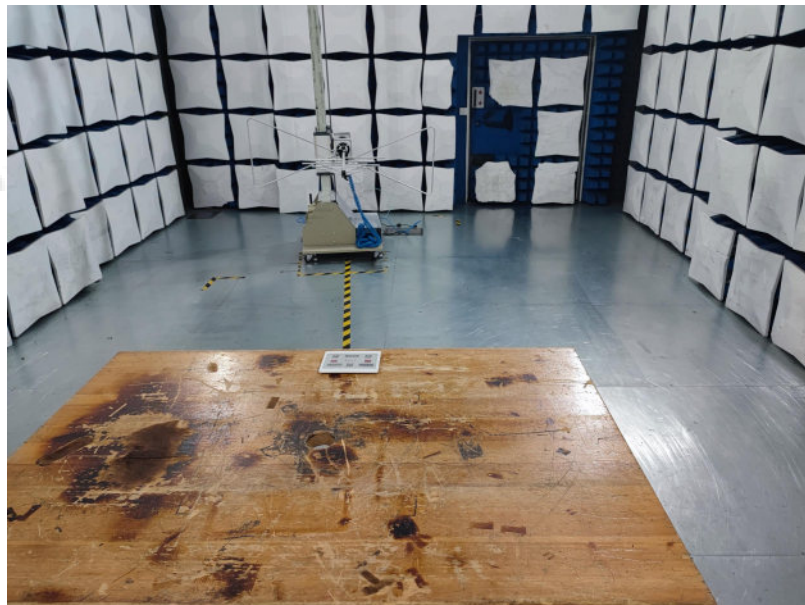
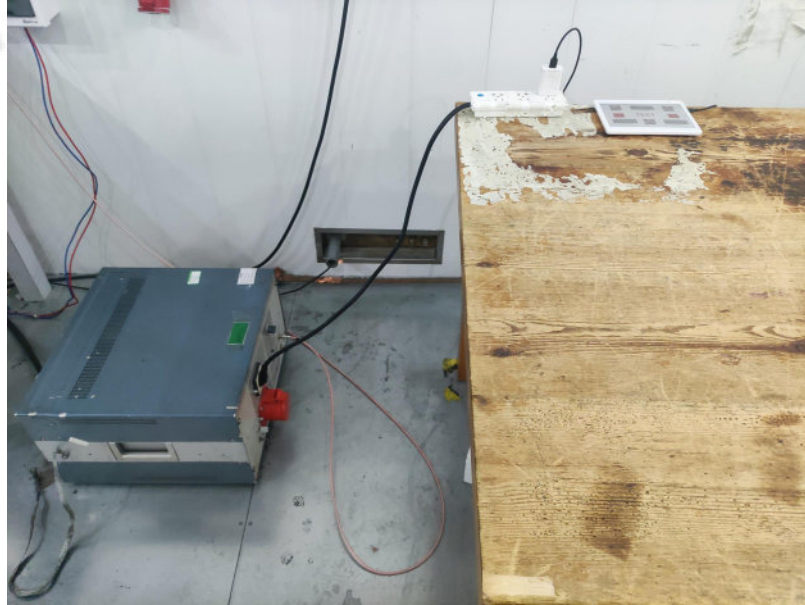

5. Photos of the EUT

External Photos of EUT



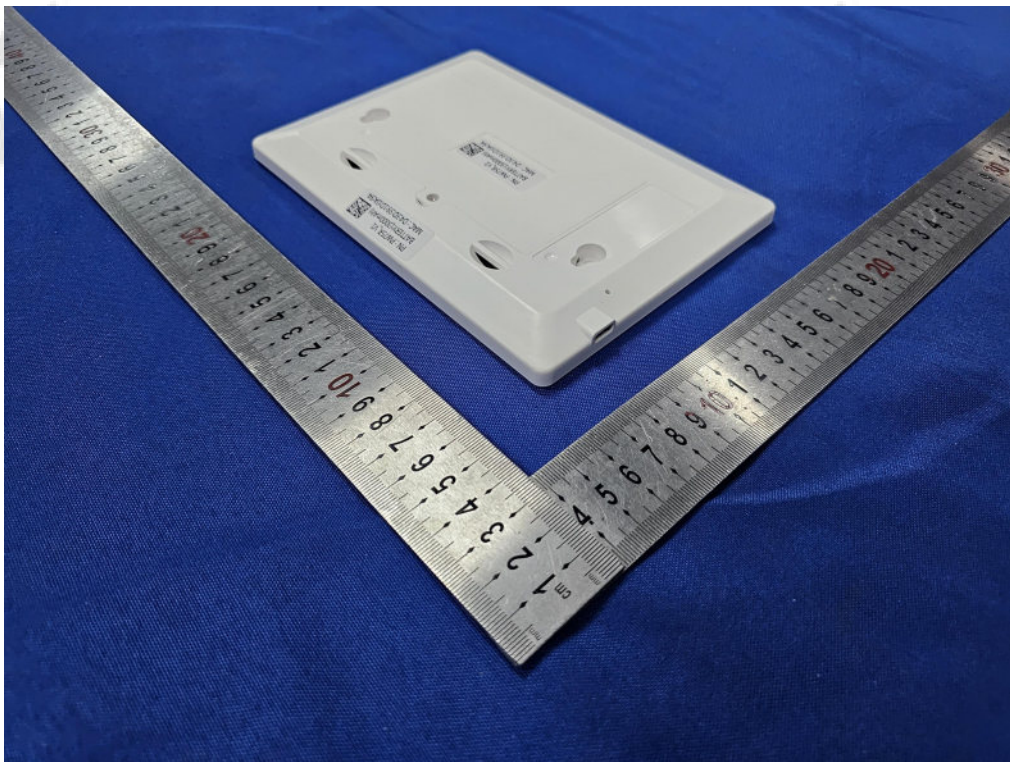
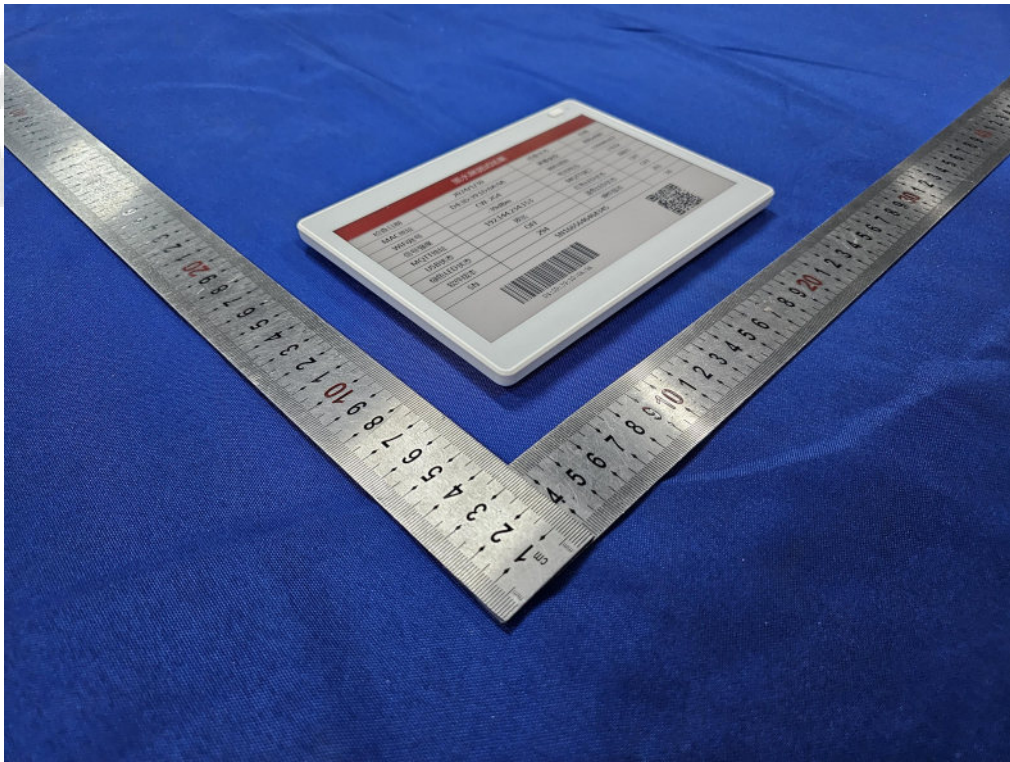



Internal Photos of EUT

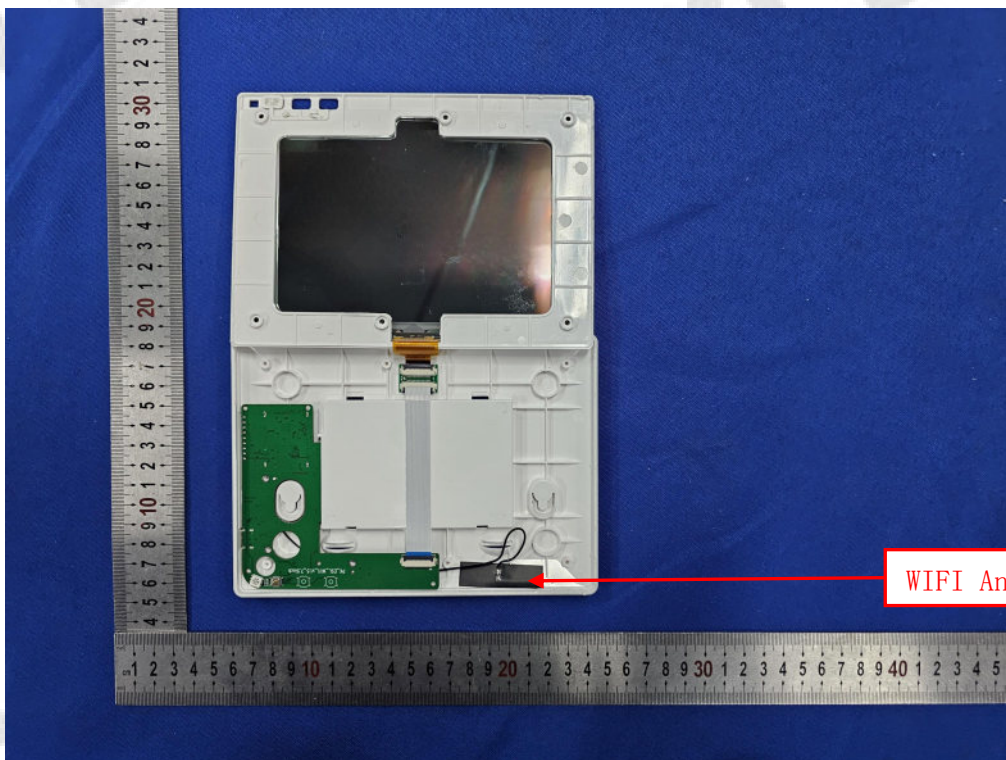
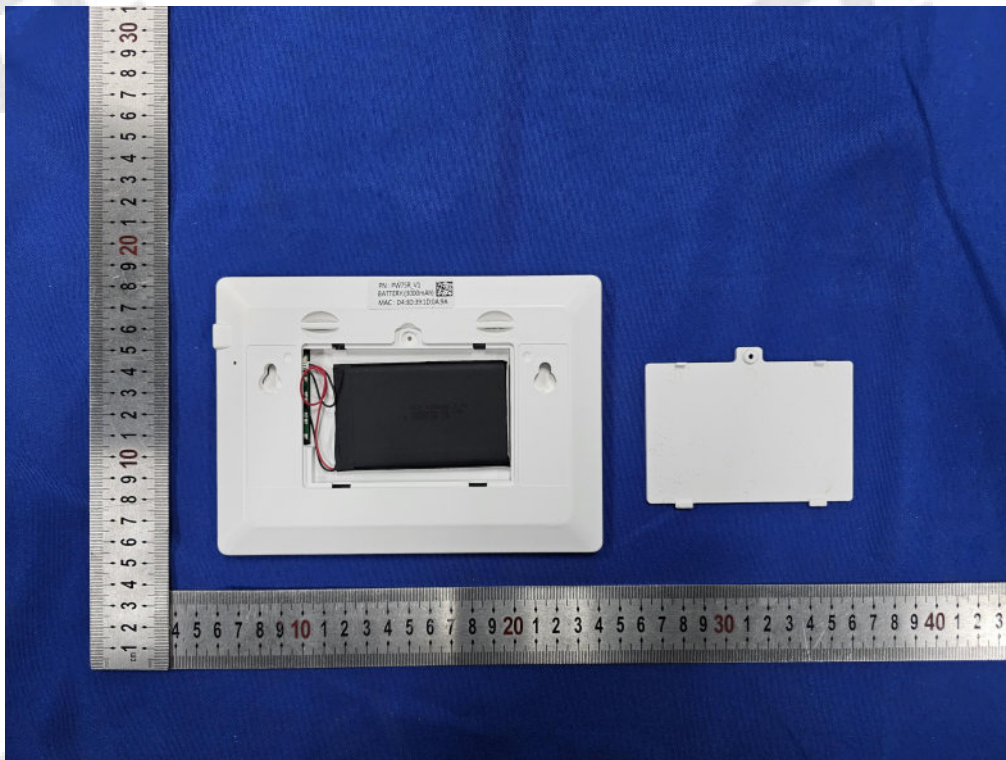

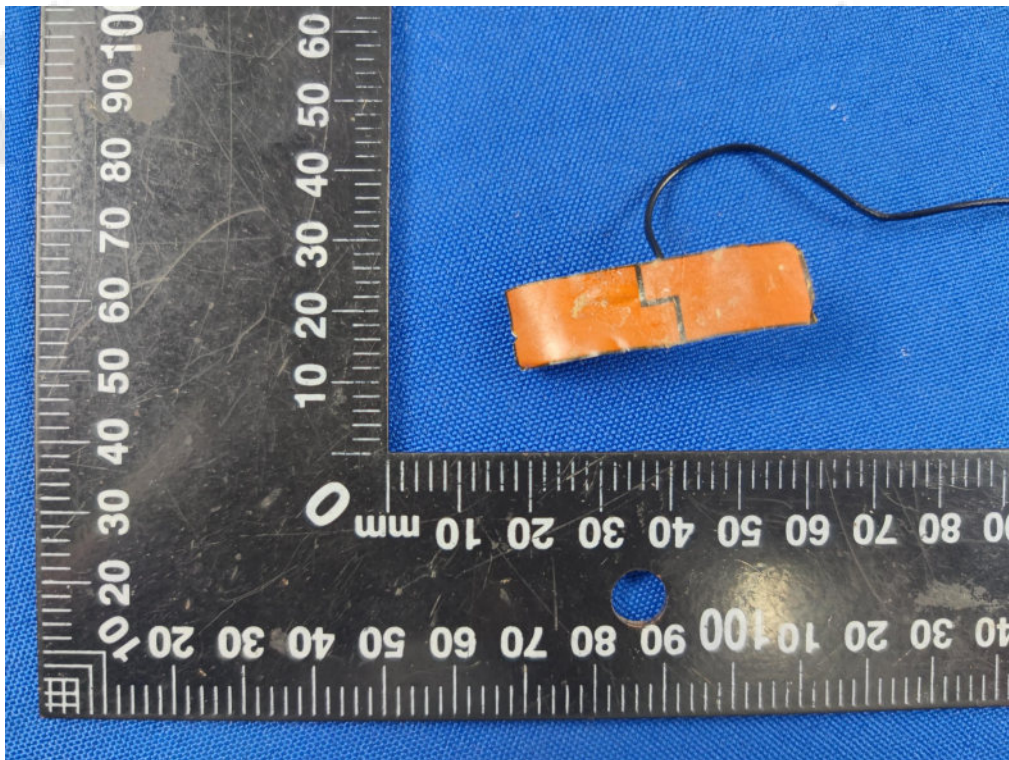
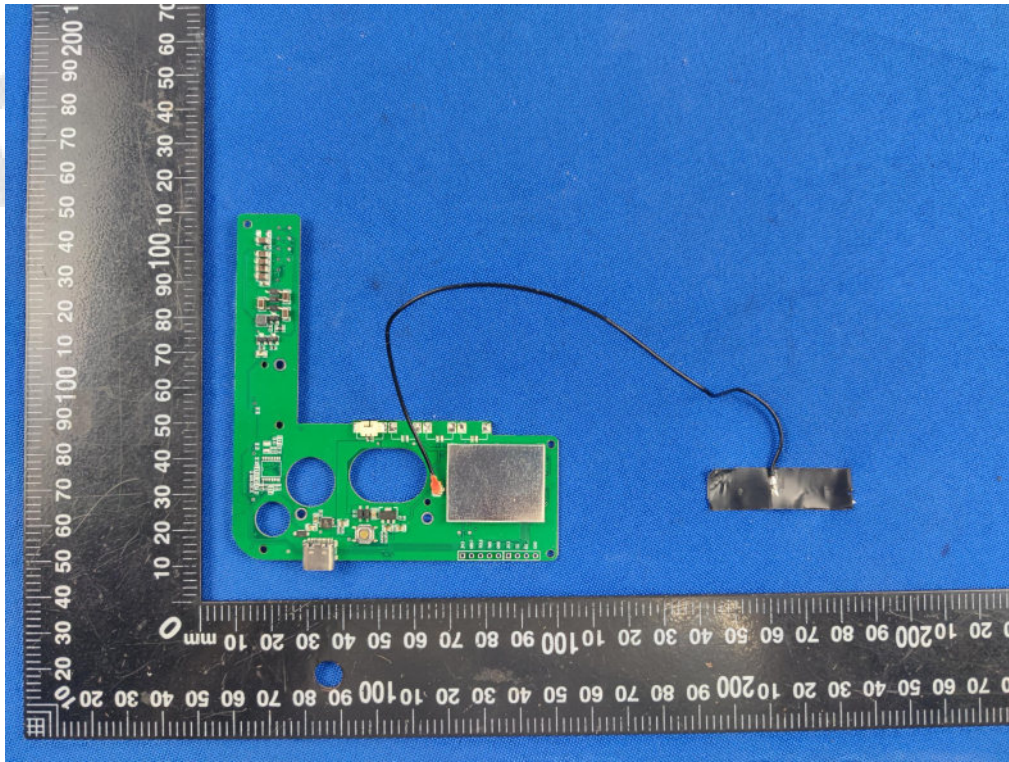

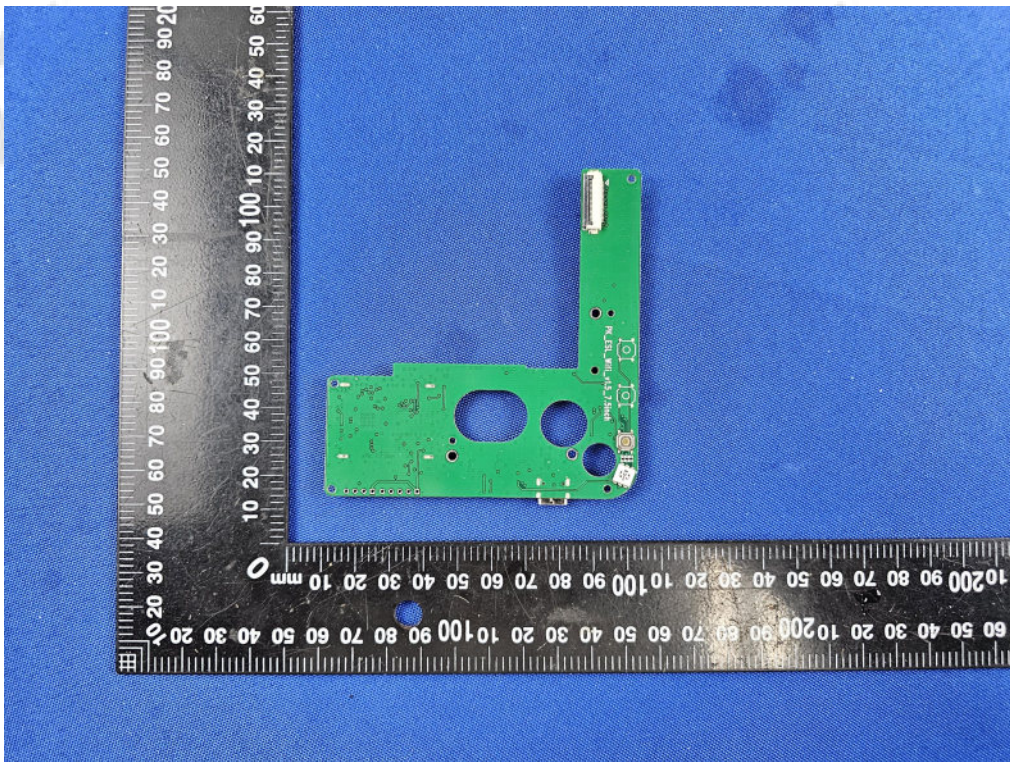
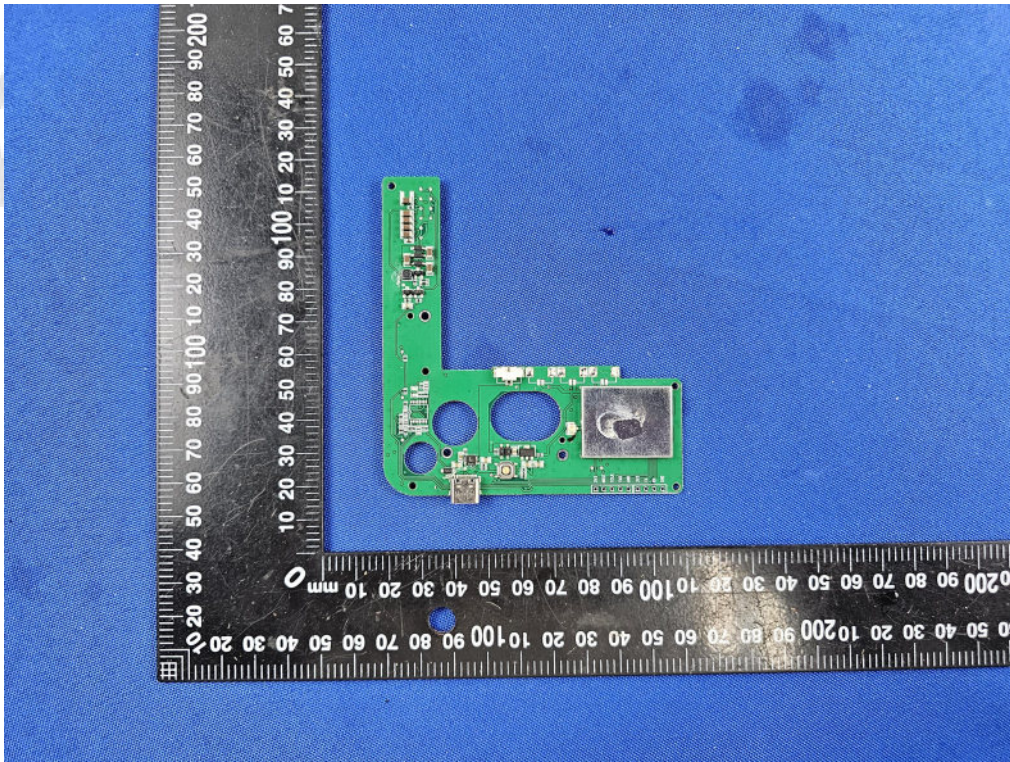

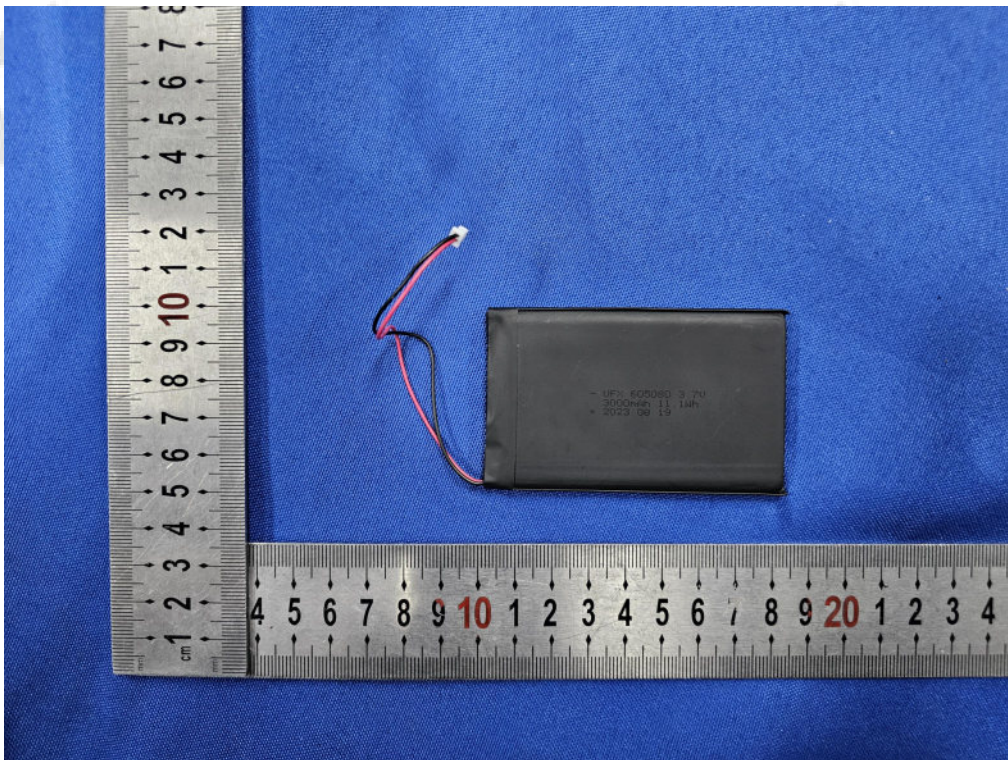

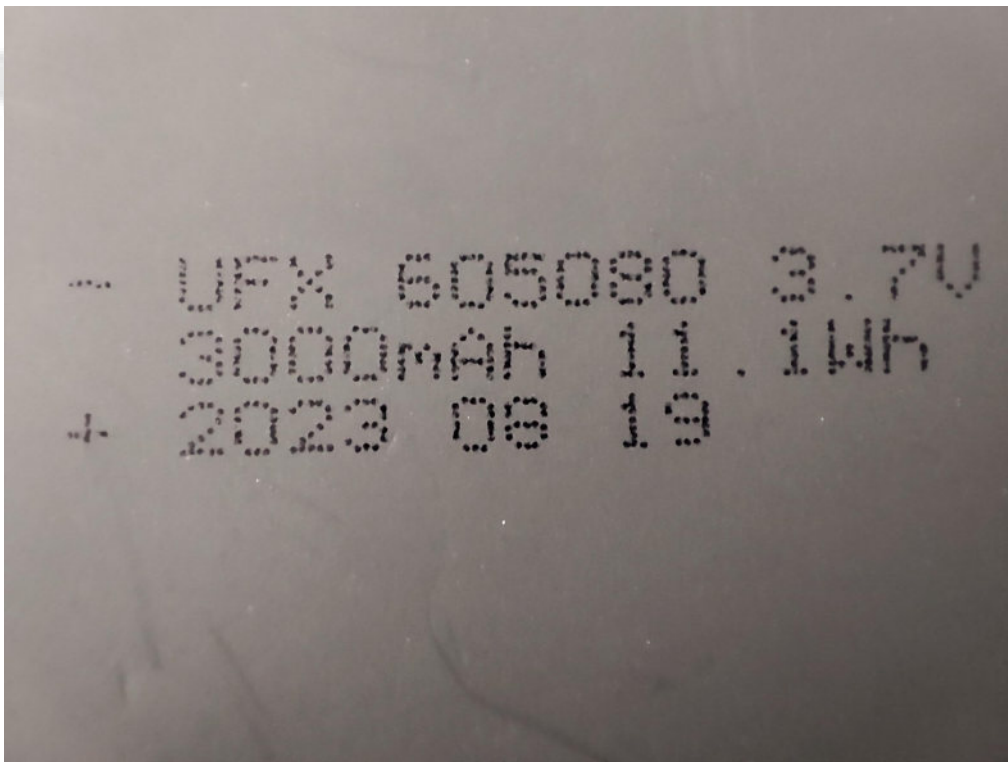

***** End of Report *****