

SAR MEASUREMENT REPORT

FCC ID: 2BCGWUB500PLUS
Applicant: TP-LINK CORPORATION PTE. LTD.
Product: Long Range Bluetooth USB Adapter
Model No.: UB500 Plus
Brand Name: tp-link
FCC Rule Part(s): FCC 47 CFR Part 2.1093
Result: Complies
Received Date: 2024-05-22
Test Date: 2024-06-07

Reviewed By:

Kevin Guo

Approved By:

Robin Wu



The test results relate only to the samples tested.

This equipment has been shown to be capable of compliance with the applicable technical standards as indicated in the measurement report and was tested in accordance with the measurement procedures specified in IEEE1528, KDB 447498 and KDB 865664. Test results reported herein relate only to the item(s) tested.

The test report shall not be reproduced except in full without the written approval of MRT Technology (Suzhou) Co., Ltd.

Revision History

Report No.	Version	Description	Issue Date	Note
2405RSU025-U1	V01	Initial Report	2024-06-18	Valid

CONTENTS

Description	Page
1. General Information	5
1.1. Applicant	5
1.2. Manufacturer	5
1.3. Testing Facility	5
1.4. Product Information	6
1.5. Radio Specification under Test	6
1.6. Antennas Details	6
2. Summary of Test Result	7
2.1. Test Standards	7
2.2. Environment Condition	7
2.3. RF Exposure Limits	7
2.4. Test Result Summary	8
3. Specific Absorption Rate (SAR)	9
3.1. Introduction	9
3.2. Definition	9
4. DASY6 Measurement System	10
4.1. Introduction	10
4.2. DASY6 Measurement System Diagram	10
4.3. System Components Details	11
5. The SAR Measurement Procedure	22
5.1. Measurement Process Diagram	22
5.2. Test Position Definition	23
5.3. Test Procedure	26
6. System Verificaiton	29
6.1. SAR Tissue Check	29
6.2. SAR System Check	32
7. Analysis and Results	34
7.1. Antenna Location	34
7.2. Conducted Power	34
7.3. SAR Test Results	35
8. Measuring Instrument	36
9. Measurement Uncertainty	37
Annex A - System Check Result	39
Annex B - Test Data Plots	40
Annex C - SAR Test Setup Photograph	41

Annex D - EUT Photograph 42
Annex E - Equipment Calibration Report..... 43

1.4. Product Information

Product Name	Long Range Bluetooth USB Adapter
Model No.	UB500 Plus
EUT Identification No.	20240522Sample#04
Brand Name	tp-link
Antenna Information	Refer to section 1.6
EUT Type	Portable Device
Exposure Category	General Population/Uncontrolled Exposure
<p>Note: The information of EUT was provided by the manufacturer, and the accuracy of the information shall be the responsibility of the manufacturer.</p>	

1.5. Radio Specification under Test

Bluetooth Specification	
Frequency Range	2402MHz~ 2480MHz
Channel Number	For Bluetooth-BR/EDR: 79 For BT-LE: 40
Channel Spacing	For Bluetooth-BR/EDR: 1MHz For BT-LE: 2MHz
Type of Modulation	For Bluetooth-BR/EDR: 1Mbps (GFSK), 2Mbps (Pi/4 DQPSK), 3Mbps (8DPSK) For BT-LE: 1Mbps&2Mbps&500kbps&125kbps (GFSK)

1.6. Antennas Details

Operating Condition	Bluetooth (1Tx, 1Rx)
Antenna Type	Dipole Antenna
Antenna Gain	1.00
Simultaneously Transmitting Scenarios	N/A

2. Summary of Test Result

2.1. Test Standards

No.	Identity	Document Title
1	47 CFR Part 2.1093	Radiofrequency radiation exposure evaluation: portable devices
2	IEEE 1528-2013	IEEE Recommended Practice for Determining the Peak Spatial-Average Specific Absorption Rate (SAR) in the Human Head from Wireless Communications Devices: Measurement Techniques
3	IEEE C95.1-2005	IEEE Standard for Safety Levels with Respect to Human Exposure to Radio Frequency Electromagnetic Fields, 3 kHz to 300 GHz
4	KDB 447498 D01 v06	General RF Exposure Guidance
5	KDB 447498 D02 v02r01	SAR Measurement Procedures for USB Dongle Transmitters
6	KDB 865664 D01 v01r04	SAR Measurement 100 MHz to 6 GHz
7	KDB 865664 D02 v01r02	RF Exposure Reporting

2.2. Environment Condition

Ambient Temperature	20.5°C~24.0°C
Temperature of Simulant	20.0°C~23.5°C
Relative Humidity	38%RH ~55%RH

2.3. RF Exposure Limits

Human Exposure	Basic restrictions for electric, magnetic and electromagnetic fields. (Unit in mW/g or W/kg)
Spatial Peak SAR ¹ (Head and Body)	1.60
Spatial Average SAR ² (Whole Body)	0.08
Spatial Peak SAR ³ (Arms and Legs)	4.00

Notes:

1. The Spatial Peak value of the SAR averaged over any 1 gram of tissue (defined as a tissue volume in the shape of a cube) and over the appropriate averaging time.
2. The Spatial Average value of the SAR averaged over the whole body.
3. The Spatial Peak value of the SAR averaged over any 1 gram of tissue (defined as a tissue volume in the shape of a cube) and over appropriate averaging time.

2.4. Test Result Summary

Worst SAR List

Highest Reported SAR	Body 1g SAR (W/kg)
Bluetooth 3DH5	0.35

3. Specific Absorption Rate (SAR)

3.1. Introduction

SAR is related to the rate at which energy is absorbed per unit mass in an object exposed to a radio field. The SAR distribution in a biological body is complicated and is usually carried out by experimental techniques or numerical modeling. The standard recommends limits for two tiers of groups, occupational /controlled and general population/uncontrolled, based on a person's awareness and ability to exercise control over his or her exposure. In general, occupational/controlled exposure limits are higher than the limits for general population/uncontrolled.

3.2. Definition

The SAR in the tissue-equivalent liquid can be determined by the rate of temperature increase or by E-field measurements, according to Formulas (1) or (2):

$$SAR = \frac{\sigma E^2}{\rho} \quad (1)$$

$$SAR = c_h \left. \frac{dT}{dt} \right|_{t=0} \quad (2)$$

where

SAR is the specific absorption rate in W/kg;

E is the rms value of the electric field strength in the tissue medium in V/m;

σ is the electrical conductivity of the tissue medium in S/m;

ρ is the mass density of the tissue medium in kg/m³;

c_h is the specific heat capacity of the tissue medium in J/(kg K);

$\left. \frac{dT}{dt} \right|_{t=0}$ is the initial time derivative of temperature in the tissue medium in K/s.

4. DASY6 Measurement System

4.1. Introduction

DASY6 is the latest generation of the Dosimetric Assessment System optimized for specific absorption rate (SAR) measurements, SAR compliance. DASY6 builds on the power of our industry - leading dosimetric and near-field evaluation system, DASY52. Running on a significantly more robust platform and a more powerful measurement server, DASY6 offers much faster scanning with no sacrifice of measurement precision. All hardware and software are fully compatible with DASY52. The new system seamlessly integrates two software solutions, the novel cDASY V6.6 - optimized for SAR compliance testing to significantly reduce SAR assessment costs - and the widely used DASY V5.2 for generalized near-field evaluations with maximized flexibility.

4.2. DASY6 Measurement System Diagram

The DASY6 system in cDASY6/DASY5 V5.2 SAR Configuration is shown below:

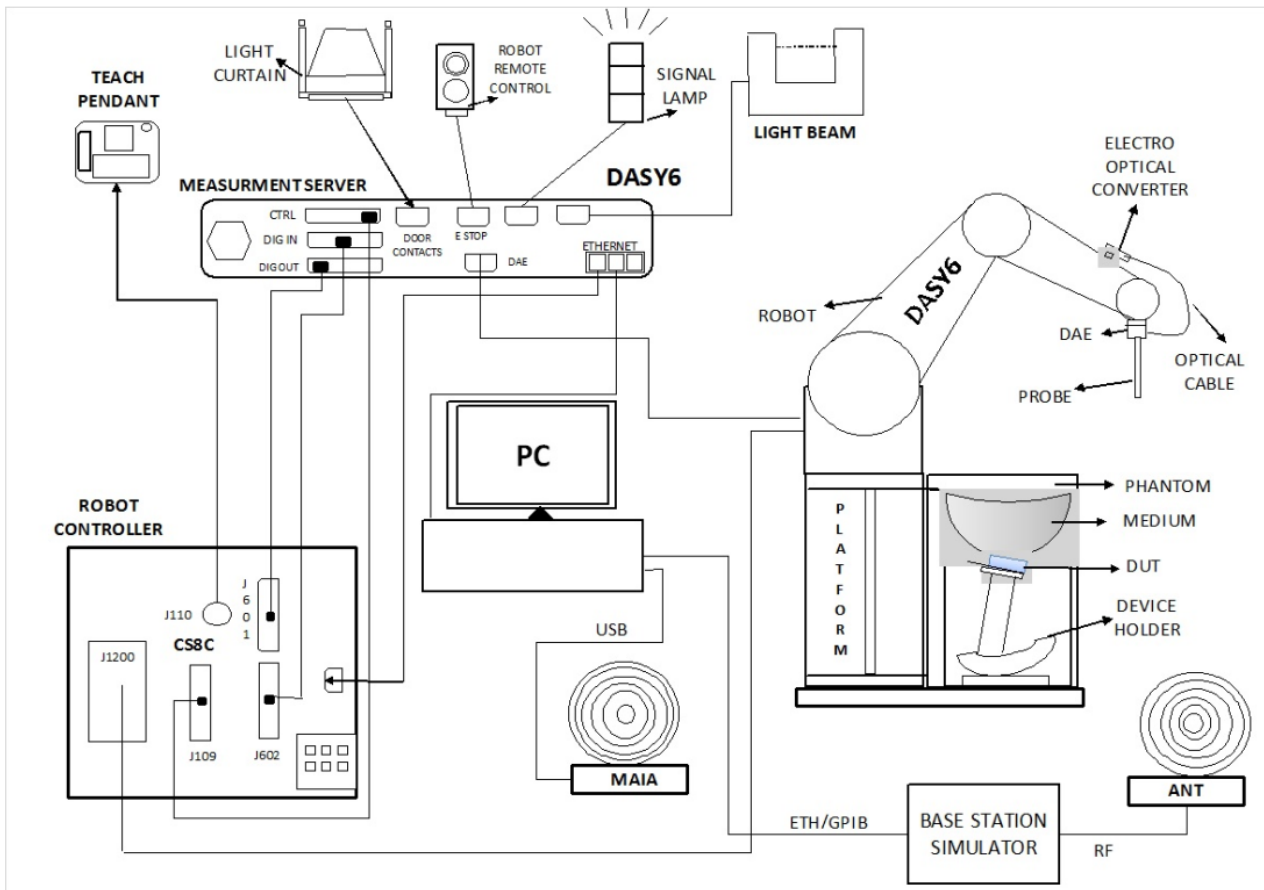

The System consist of the following components:

DASY6 Measurement Server, Data Acquisition Electronics (DAE), Probes, Light-Beam Unit, Phantoms, Media, Device Holder for SAM-Twin Phantom, Laptop Extension Kit to Mounting Device, Robot System Platform & Pedestal, Verification of the Parameters with the Dielectric Assessment Kit (DAK), Modulation and Interference Analyzer (MAIA), Omni-Directional Ultra-Wideband Antenna (ANT), cDASY6 software, DASY5 NEO software and SEMCAD data evaluation software.

4.3. System Components Details

DASY6 Platforms MP6E-TX60L

MP6E-TX60L platform is a compact cost-effective platform based on TX60L. It consists of:

- a stable non-metallic platform for the TX60L robot
- a frame for two standard-size phantoms (1.0×0.5 m)
- a frame for one half-size phantom (0.5×0.5 m)

It includes two easily moveable trolleys for the phone and tablet/computer positioner and two platforms for positioning dipoles and other antennas.

Material The beams consist of a composite of wood and epoxy (permittivity of 3.3 and loss tangent of <0.07)

Size The footprint of the platform is 1590 mm \times 1060 mm.

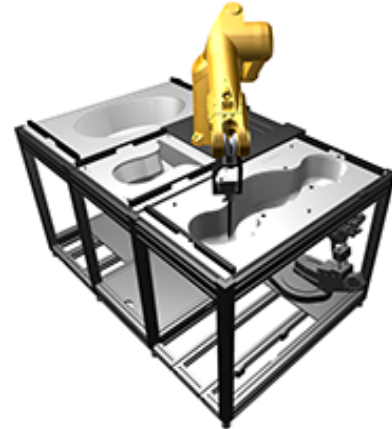

Robots -TX60L

The MRT DASY6 system uses the high-precision industrial robots TX60L from Staubli SA (France). The TX robot family - the successor of the well-known RX robot family - continues to offer the features important for DASY6 applications:

- High precision (repeatability 0.02mm)
- High reliability (industrial design)
- Low maintenance costs (virtually maintenance-free as all gears are direct drive, no belt drives)
- Jerk-free straight movements (brushless synchron motors, no stepper motors)
- Low extremely low frequency (ELF) interference (motor control fields are shielded by the closed metallic construction)

The robots are controlled by the Staubli CS8c robot controllers. All information regarding the use and maintenance of the robot arm and the robot controller is provided on CDs delivered with the robot. Paper manuals are available directly from Staubli upon request.



DASY6 Measurement Server

The DASY6 measurement server is based on a PC/104 CPU board with a 400MHz intel ULV Celeron, 128MB chip-disk and 128MB RAM. The necessary circuits for communication with the DAE4 electronics box, as well as the 16-bit AD converter system for optical detection and digital I/O interface are contained on the DASY6 I/O board, which is directly connected to the PC/104 bus of the CPU board. The measurement server performs all real-time data evaluations of field measurements and surface detection, controls robot movements, and handles safety operations.



Data Acquisition Electronics (DAE)

The data acquisition electronics (DAE4) consist of a highly sensitive electrometer-grade preamplifier with auto-zeroing, a channel and gain-switching multiplexer, a fast 16-bit AD-converter, and a command decoder with a control logic unit. Transmission to the measurement server is accomplished through an optical downlink for data and status information, as well as an optical uplink for commands and the clock.

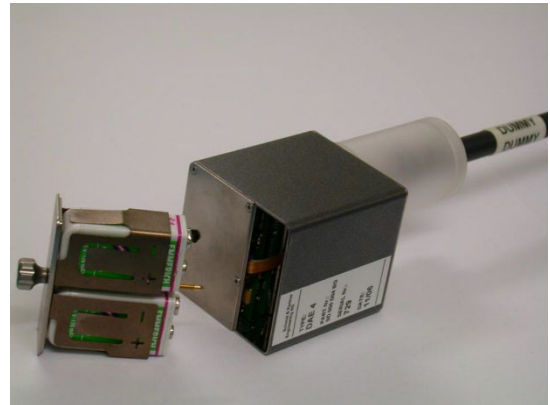

Probes

E-Field Probe(EX3DV4)

The SAR measurement is conducted with the dosimetric probe manufactured by SPEAG. The probe is specially designed and calibrated for use in liquid with high permittivity. The dosimetric probe has special calibration in liquid at different frequency. SPEAG conducts the probe calibration in compliance with international and national standards (e.g. IEEE 1528, EN 62209-1, IEC 62209, etc.) under ISO 17025.

Construction:

Symmetric design with triangular core Built-in shielding against static charges PEEK enclosure material (resistant to organic solvents, e.g., DGBE)

Frequency: 4 MHz ~ 10 GHz

Linearity: ± 0.2 dB (30 MHz ~ 10 GHz)

Directivity:

± 0.1 dB in TSL (rotation around probe axis)

± 0.3 dB in TSL (rotation normal to probe axis)

Dynamic Range: 10 μ W/g to 100 mW/g; Linearity: ± 0.2 dB (noise: typically < 1 μ W/g)

Dimensions:

Overall length: 337 mm (Tip: 20 mm)

Tip diameter: 2.5 mm (Body: 12 mm)

Typical distance from probe tip to dipole centers: 1 mm

Applications:

High precision dosimetric measurements in any exposure scenario (e.g., very strong gradient fields); the only probe that enables compliance testing for frequencies up to 6 GHz with precision of better than 30%.



MSTV1 (Mother Scan Teaching V1) Electronics & TP6V2 (Teaching Probe 6V2) Probe

MSTV1 (Mother Scan Teaching V1) electronics together with the TP6V2 (Teaching Probe 6V2) probe is used for mother scan of DASY6 system. This probe uses a 3D Renishaw LP2 sensor which ensures accurate detection of any shape and a measurement repeatability of 8 μ m.



Light-Beam Unit

The light beam switch allows automatic "tooling" of the probe. During the process, the actual position of the probe tip with respect to the robot arm, as well as the probe length and the horizontal probe offset, are measured. The software then corrects all movements within the measurement jobs, such that the robot coordinates are valid for the probe tip.



The repeatability of this process is better than 0.1 mm. If a position has been taught with an aligned probe, the same position will be reached with another aligned probe within 0.1 mm, even if the other probe has different dimensions. During probe rotations, the probe tip will keep its actual position.

Phantoms

SAM-Twin Phantom

The shell corresponds to the specifications of the Specific Anthropomorphic Mannequin (SAM) phantom defined in IEEE 1528 and IEC 62209-1. It enables the dosimetric evaluation of left and right hand phone usage as well as body-mounted usage at the flat phantom region. A cover prevents evaporation of the liquid. Reference markings on the phantom allow the complete setup of all predefined phantom positions and measurement grids by teaching three points with the robot.

SAM-Twin V5.0 and higher has the same shell geometry and is manufactured from the same material as SAM-Twin V4.0, but with the top structure reinforced.

Material Vinyl ester, fiberglass reinforced (VE-GF)
The phantom shell is compatible with SPEAG tissue simulating liquids (sugar and oil based).

Liquid Compatibility Use of other liquids may render the phantom warranty void (see note or consult SPEAG support).

Shell Thickness 2 ± 0.2 mm (6 ± 0.2 mm at ear point)

Dimensions Length: 1000 mm

(incl. Wooden Width: 500 mm

Support) Height: adjustable feet

Filling Volume approx. 25 liters

Support DASY6: standard-size platform slot
DASY52 stand-alone: SPEAG standard phantom table

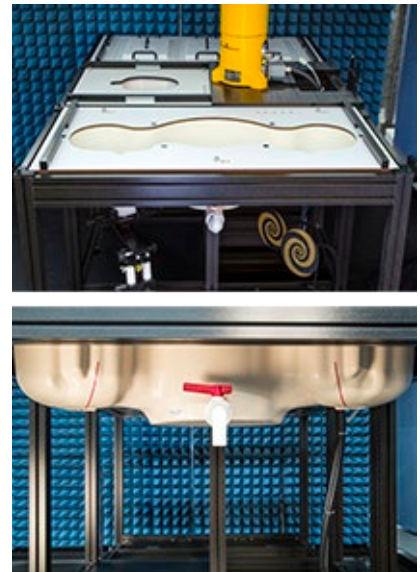

ELI phantom

The ELI phantom is used for compliance testing of handheld and body-mounted wireless devices in the frequency range of 30 MHz to 6 GHz. ELI is fully compatible with the IEC 62209-2 standard and all known tissue simulating liquids. ELI has been optimized regarding its performance and can be integrated into our standard phantom tables. A cover prevents evaporation of the liquid. Reference markings on the phantom allow installation of the complete setup, including all predefined phantom positions and measurement grids, by teaching three points. The phantom is compatible with all SPEAG dosimetric probes and dipoles.

ELI V5.0 and higher has the same shell geometry and is manufactured from the same material as ELI V4.0, but has reinforced top structure. ELI V6.0, released in August 2014, has the same shell geometry as ELI V4.0 but offers increased longterm stability.

Material	Vinyl ester, fiberglass reinforced (VE-GF) The phantom shell is compatible with SPEAG tissue simulating liquids (sugar and oil
Liquid Compatibility	based). Use of other liquids may render the phantom warranty void (see note or consult SPEAG support).
Shell Thickness	2.0 ± 0.2 mm (bottom plate)
Dimensions	Major axis: 600 mm Minor axis: 400 mm
Filling Volume	approx. 30 liters
Support	DASY6: standard-size platform slot DASY52 stand-alone: SPEAG standard phantom table

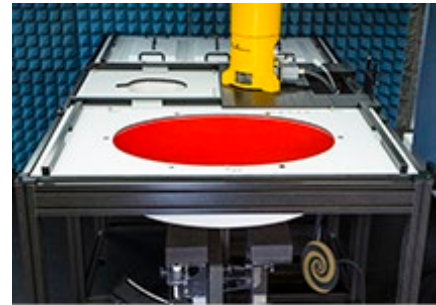

SAM Face Down Phantom

The SAM Face Down Phantom V10 allows assessment of the exposure of the face and in particular the eyes for handheld devices operated in front of the face. e.g., video phones, cameras, organizers, etc. It is manufactured from high precision injection molded polypropylene. The Mounting Device for Transmitters including extensions kit can be used to position the device.

Material	Epoxy based
Liquid Compatibility	The phantom shell is compatible with SPEAG tissue simulating liquids (sugar and oil based). Use of other liquids may render the phantom warranty void (see note or consult SPEAG support).
Shell Thickness	2 ± 0.2 mm (6 mm at ear point)
Head Shape	Standard compatible SAM head.

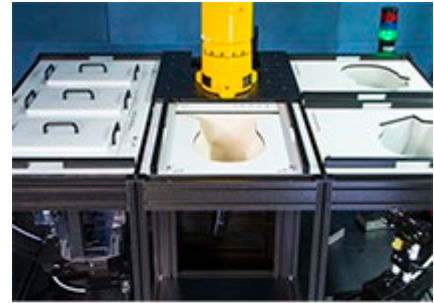

SAM Head Stand Phantom

The SAM Head Stand Phantom V10 allows assessment of the exposure of the top-head or around-the-head wireless accessories, e.g., head-belts, etc. It is manufactured from high precision injection molded polypropylene. The Mounting Device for Transmitters including extensions kit can be used to position the device.

Material	Epoxy based
Liquid Compatibility	The phantom shell is compatible with SPEAG tissue simulating liquids (sugar and oil based). Use of other liquids may render the phantom warranty void (see note or consult SPEAG support).
Shell Thickness	2 ± 0.2 mm (6 mm at ear point)
Head Shape	Standard compatible SAM head.

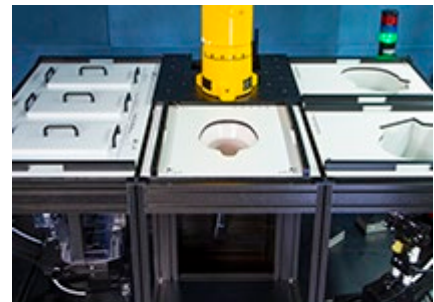

Wrist Phantom

The Wrist Phantom V10 is shape-compatible with the CTIA approved OTA GFPC-V1 and optimized for SAR evaluation of watches and other wireless hand accessories.

Material	Epoxy based The phantom shell is compatible with SPEAG tissue simulating liquids (sugar and oil based). Use of other liquids may render the phantom warranty void (see note or consult SPEAG support).
Liquid Compatibility	
Shell Thickness	Shell Thickness
Wrist Shape	Design compatible with CTIA forearm.



Device Holder for SAM-Twin Phantom

The SAR in the phantom is approximately inversely proportional to the square of the distance between the source and the liquid surface. For a source at 5mm distance, a positioning uncertainty of $\pm 0.5\text{mm}$ would produce uncertainty in the SAR of $\pm 20\%$. Accurate device positioning is therefore crucial for accurate and repeatable measurements. The positions at which the devices must be measured are defined by the standards.

MD4HHTV5 - Mounting Device for Hand-Held Transmitters

In combination with the Twin SAM V5.0/V5.0c or ELI phantoms, the Mounting Device for Hand-Held Transmitters enables rotation of the mounted transmitter device to specified spherical coordinates. At the heads, the rotation axis is at the ear opening. Transmitter devices can be easily and accurately positioned according to IEC 62209-1, IEEE 1528, FCC, or other specifications. The device holder can be locked for positioning at different phantom sections (left head, right head, flat).

Material: Polyoxymethylene (POM)



MDA4WTV5 - Mounting Device Adaptor for Ultra Wide Transmitters

An upgrade kit to Mounting Device to enable easy mounting of wider devices like big smart-phones, e-books, small tablets, etc. It holds devices with width up to 140 mm.

Material: Polyoxymethylene (POM)



MDA4SPV6 - Mounting Device Adaptor for Smart Phones

The solid low-density MDA4SPV6 adaptor assuring no impact on the DUT radiation performance and is conform with any DUT design and shape.

Material: ROHACELL



MD4LAPV5 - Mounting Device for Laptops and other Body-Worn Transmitters

In combination with the Twin SAM V5.0/V5.0c or ELI phantoms, the Mounting Device (Body-Worn) enables testing of transmitter devices according to IEC 62209-2 specifications. The device holder can be locked for positioning at a flat phantom section.

Material: Polyoxymethylene (POM), PET-G, Foam



MDA4LAP - Mounting Device Adaptor for Laptops

A simple but effective and easy-to-use extension for the Mounting Device; facilitates testing of larger devices (e.g., laptops, cameras, etc.) according to IEC 62209-2; lightweight and fits easily on the upper part of the Mounting Device in place of the phone positioner. The extension is fully compatible with the Twin SAM as well as ELI and other Flat Phantoms.

Material: Polyoxymethylene (POM), PET-G, Foam



Modulation and Interference Analyzer(MAIA)

MAIA is a hardware interface used to evaluate the modulation and audio interference characteristics of RF signals in the frequency range 698 - 6000 MHz. DASY6 evaluates the time-domain and frequency domain properties of the uplink signal transmitted by the DUT during SAR measurement with MAIA. MAIA uses USB powered active electronics to identify the modulation of the DUT. It can be operated over the air interface using the built-in ultra-broadband planar log spiral antenna (698 - 6000 MHz) or in conducted mode using the coaxial SMA 50 Ohm connector (300 - 6000 MHz).



To prevent damage in conducted mode due to high peak power, an external RF attenuator may be mounted. The LED on the MAIA hardware also indicates whether it is connected.

DAK-3.5 (200MHz – 20GHz)

This precision dielectric measurement system is designed to cover the 200MHz – 20GHz frequency range with a single open-ended coaxial dielectric probe. The system uses advanced algorithms and novel hardware to measure the dielectric properties of liquids, solids, and semi-solids over a broad range of parameters. The measurement method is fast and non-destructive to the material under test.



Evaluation of reference liquids over a broad frequency range for specific absorption rate (SAR) measurements, in accordance with IEC 62209, IEEE 1528, and several federal regulations.

Evaluating Software: DAK software version 2.0

MRT simulating liquid

Product	Test Frequency (MHz)	Main Ingredients
HSL450	400 – 500	Water, Sucrose, NaCl
MSL450	400 – 500	Water, Sucrose, NaCl

Speag Broad-Band simulating liquid

Product	Test Frequency (MHz)	Main Ingredients
HBBL600-10000V6	600 – 10000	Water, Oil
MBBL600-6000V6	600 – 6000	Water, Oil

5. The SAR Measurement Procedure

5.1. Measurement Process Diagram

General Procedure

For IEEE1528-2013 Head SAR

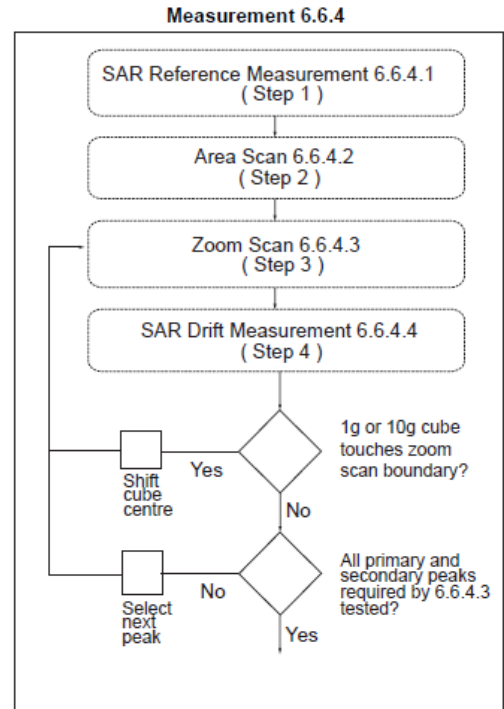
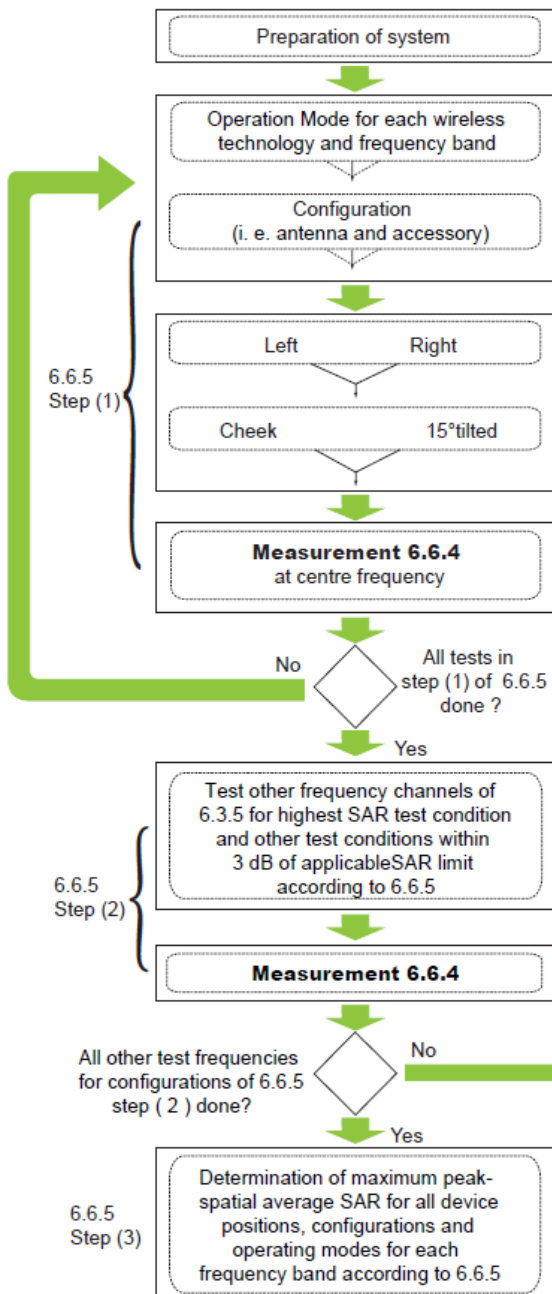

For Body SAR

SAR scan procedures described in section 2.7 of KDB 865664 D01 v01r04 should be applied to body SAR test.

5.2. Test Position Definition

■ Head SAR Test Position

Define two imaginary lines on the handset—the vertical centerline and the horizontal line. The vertical centerline passes through two points on the front side of the handset—the midpoint of the width w_t of the handset at the level of the acoustic output [point A in Fixed case and Clamshell case], and the midpoint of the width w_b at the bottom of the handset (point B). The horizontal line is perpendicular to the vertical centerline and passes through the center of the acoustic output [see Fixed case]. The horizontal line is also tangential to the face of the handset at point A. The two lines intersect at point A. Note that for many handsets, point A coincides with the center of the acoustic output; however, the acoustic output may be located elsewhere on the horizontal line. Also note that the vertical centerline is not necessarily parallel to the front face of the handset [see Clamshell case], especially for clamshell handsets, handsets with flip covers, and other irregularly-shaped handsets, the vertical centerline passes through point A but not the tip edge of the phone.

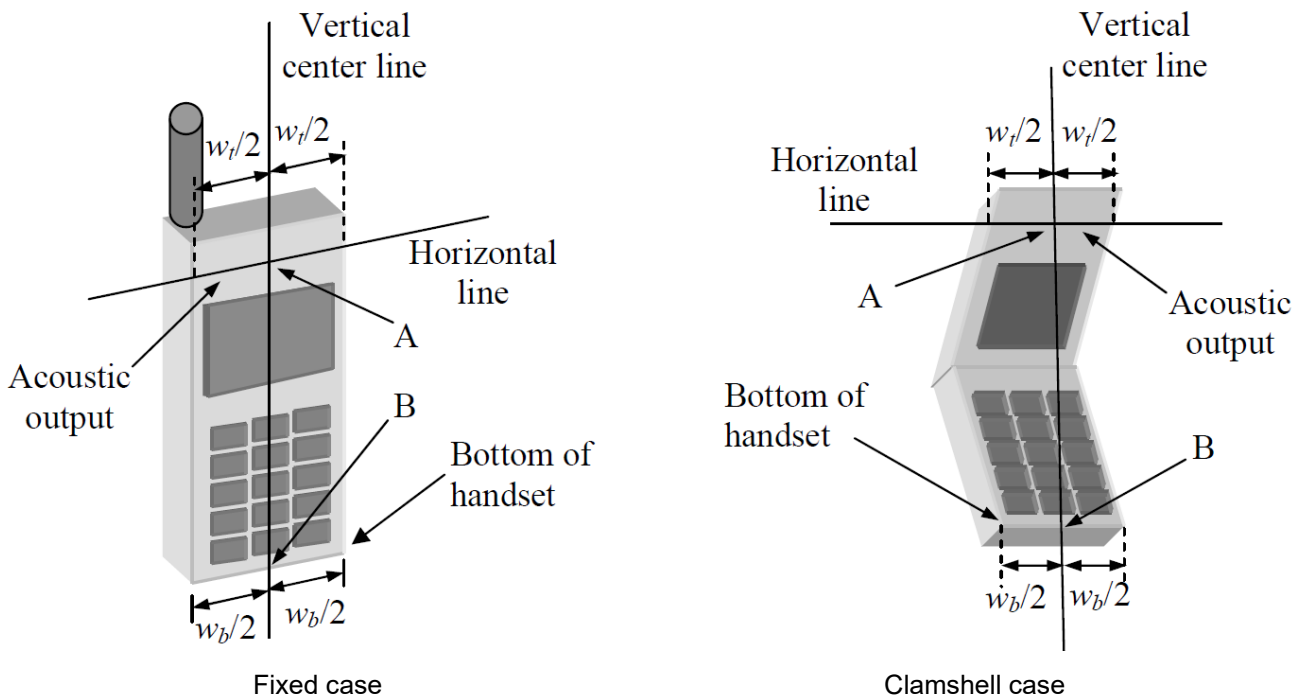

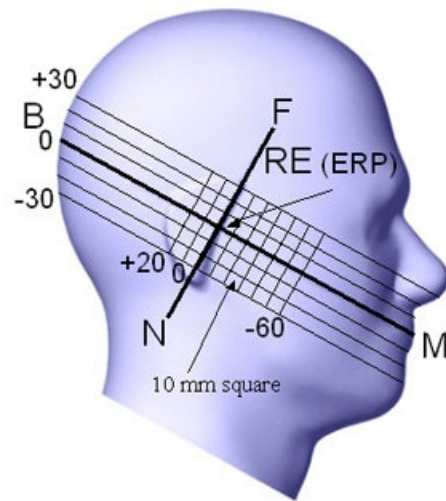
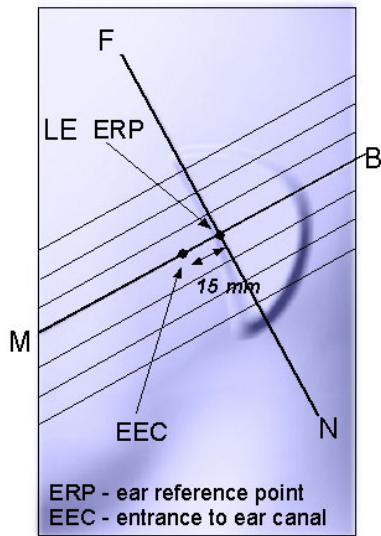
Key

- B Direction of B-M line back endpoint
- F Direction of N-F line front endpoint
- N Direction of N-F line neck endpoint
- M Mouth reference point
- LE Left ear reference point (ERP)

Key

- B Line B-M back endpoint
- M Line B-M front endpoint
- N Line N-F neck endpoint
- F Line N-F front endpoint
- RE Right ear reference point (ERP)

Cheek Position

The cheek position has the following characteristics, based on the geometrical lines described above:

- The N-F line (see above) is in the plane defined by the handset vertical centerline and horizontal line
- Handset touches the pinna
- The handset vertical centerline is aligned with the Reference Plane.

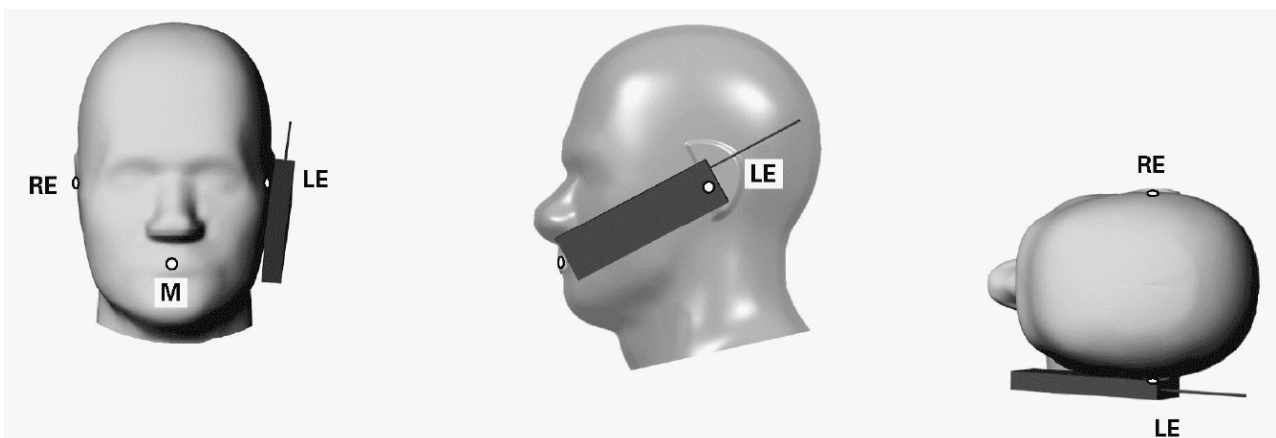

Key

- M Mouth reference point
- LE Left ear reference point
- RE Right ear reference point

Tilt Position

The tilt position is established as follows:

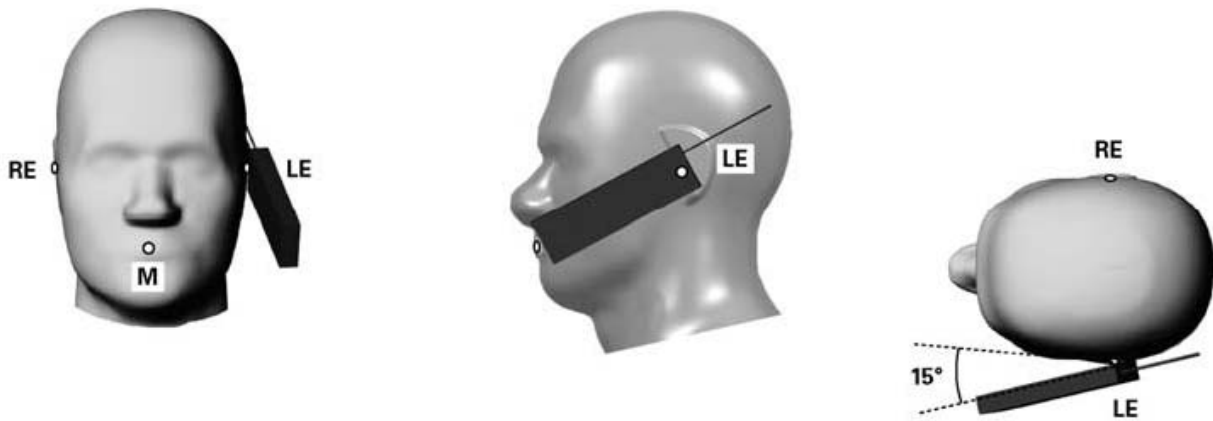
- Repeat the steps to place the device in the cheek position.
- While maintaining the orientation of the handset, move the handset away from the pinna along the line passing through RE and LE far enough to allow a rotation of the handset away from the cheek by 15° .
- Rotate the handset around the horizontal line by 15° .
- While maintaining the orientation of the handset, move the handset towards the phantom on the line passing through RE and LE until any part of the handset touches the ear. The tilt position is obtained when the contact point is on the pinna. If contact occurs at any location other than the pinna, e.g., the antenna at the back of the phantom head, the angle of the handset shall be reduced. In this case, the tilt position is obtained if any point on the handset is in contact with the pinna and a second point on the handset is in contact with the phantom, e.g., the antenna with the back of the head.



Key

- M Mouth reference point
- LE Left ear reference point
- RE Right ear reference point

■ Body SAR Test Position

For body-worn accessory, hotspot mode and other exposure conditions to human body should be conducted pursuant to the test position requirements of SAR KDBs for certain product.

5.3. Test Procedure

Step 1 Setup a Connection

First, engineer should record the conducted power before the test. Then establish a call in handset at the maximum power level with a base station simulator via air interface, or make the EUT establish transmission by itself in testing band. Place the EUT to certain test position.

Step 2 Power Reference Measurements

To measure the local E-field value at a fixed location which value will be taken as a reference value for calculating a possible power drift.

Step 3 Area Scan

The Area Scan is used as a fast scan in two dimensions to find the area of high field values, before doing a fine measurement around the hot spot. The sophisticated interpolation routines implemented in DASYS software can find the maximum locations even in relatively coarse grids. When an Area Scan has measured all reachable points, it computes the field maximal found in the scanned area, within a range of the global maximum. The range (in dB) is specified in the standards for compliance testing. For example, a 2 dB range is required in IEEE Standard 1528 and IEC 62209 standards, whereby 3 dB is a requirement when compliance is assessed in accordance with the ARIB standard (Japan). If only one Zoom Scan follows the Area Scan, then only the absolute maximum will be taken as reference. For cases where multiple maximums are detected, the number of Zoom Scans has to be increased accordingly.

Area Scan Parameters extracted from KDB 865664 D01v01r04

	≤ 3 GHz	> 3 GHz
Maximum distance from closest measurement point (geometric center of probe sensors) to phantom surface	5 mm ± 1 mm	$\frac{1}{2} \cdot \delta \cdot \ln(2)$ mm ± 0.5 mm
Maximum probe angle from probe axis to phantom surface normal at the measurement location	30° ± 1°	20° ± 1°
Maximum area scan spatial resolution: ΔX_{Area} , ΔY_{Area}	≤ 2 GHz: ≤ 15 mm 2 - 3 GHz: ≤ 12 mm	3 - 4 GHz: ≤ 12 mm 4 - 6 GHz: ≤ 10 mm
	When the x or y dimension of the test device, in the measurement plane orientation, is smaller than the above, the measurement resolution must be ≤ the corresponding x or y dimension of the test device with at least one measurement point on the test device.	
Note: δ is the penetration depth of a plane-wave at normal incidence to the tissue medium; see IEEE Std 1528-2013 for details.		

Step 4 Zoom Scan

Zoom Scans are used to assess the peak spatial SAR values within a cubic averaging volume containing 1 g and 10 g of simulated tissue. The Zoom Scan measures points (refer to table below) within a cube whose base faces are centered on the maxima found in a preceding area scan job within the same procedure. When the measurement is done, the Zoom Scan evaluates the averaged SAR for 1 g and 10 g and displays these values next to the job's label.

Zoom Scan Parameters extracted from KDB 865664 D01 v01r04

			≤ 3 GHz	> 3 GHz
Maximum zoom scan spatial resolution: $\Delta x_{\text{Zoom}}, \Delta y_{\text{Zoom}}$			≤ 2 GHz: ≤ 8 mm 2 - 3 GHz: ≤ 5 mm*	3 - 4 GHz: ≤ 5 mm* 4 - 6 GHz: ≤ 4 mm*
Maximum zoom scan spatial resolution, normal to phantom surface	uniform grid: $\Delta z_{\text{Zoom}}(n)$		≤ 5 mm	3 - 4 GHz: ≤ 4 mm 4 - 5 GHz: ≤ 3 mm 5 - 6 GHz: ≤ 2 mm
	graded grid	$\Delta z_{\text{Zoom}}(1)$: between 1 st two points closest to phantom surface	≤ 4 mm	3 - 4 GHz: ≤ 3 mm 4 - 5 GHz: ≤ 2.5 mm 5 - 6 GHz: ≤ 2 mm
		$\Delta z_{\text{Zoom}}(n>1)$: between subsequent points	≤ 1.5 · $\Delta z_{\text{Zoom}}(n-1)$ mm	
Minimum zoom scan volume	x, y, z		≥ 30 mm	3-4 GHz: ≥ 28 mm 4-5 GHz: ≥ 25 mm 5-6 GHz: ≥ 22 mm
Note: * When zoom scan is required and the reported SAR from the area scan based 1-g SAR estimation procedures of KDB Publication 447498 is ≤ 1.4 W/kg, ≤ 8 mm, ≤ 7 mm and ≤ 5 mm zoom scan resolution may be applied, respectively, for 2 GHz to 3 GHz, 3 GHz to 4 GHz and 4 GHz to 6 GHz.				

Step 5 Power Drift Measurements

Repetition of the E-field measurement at the fixed location mentioned in Step 1 to make sure the two results differ by less than ± 0.2 dB.

Step 6 Test Data

After the test, SAR test data should be exported by SEMCAD.

6. System Verificaiton

6.1. SAR Tissue Check

- Refer to KDB 865664 D01 v01r04, the depth of tissue-equivalent liquid in a phantom must be ≥ 15.0 cm with $\leq \pm 0.5$ cm variation for SAR measurements ≤ 3 GHz and ≥ 10.0 cm with $\leq \pm 0.5$ cm variation for measurements > 3 GHz.

15cm Depth Head Tissue for ELI Phantom

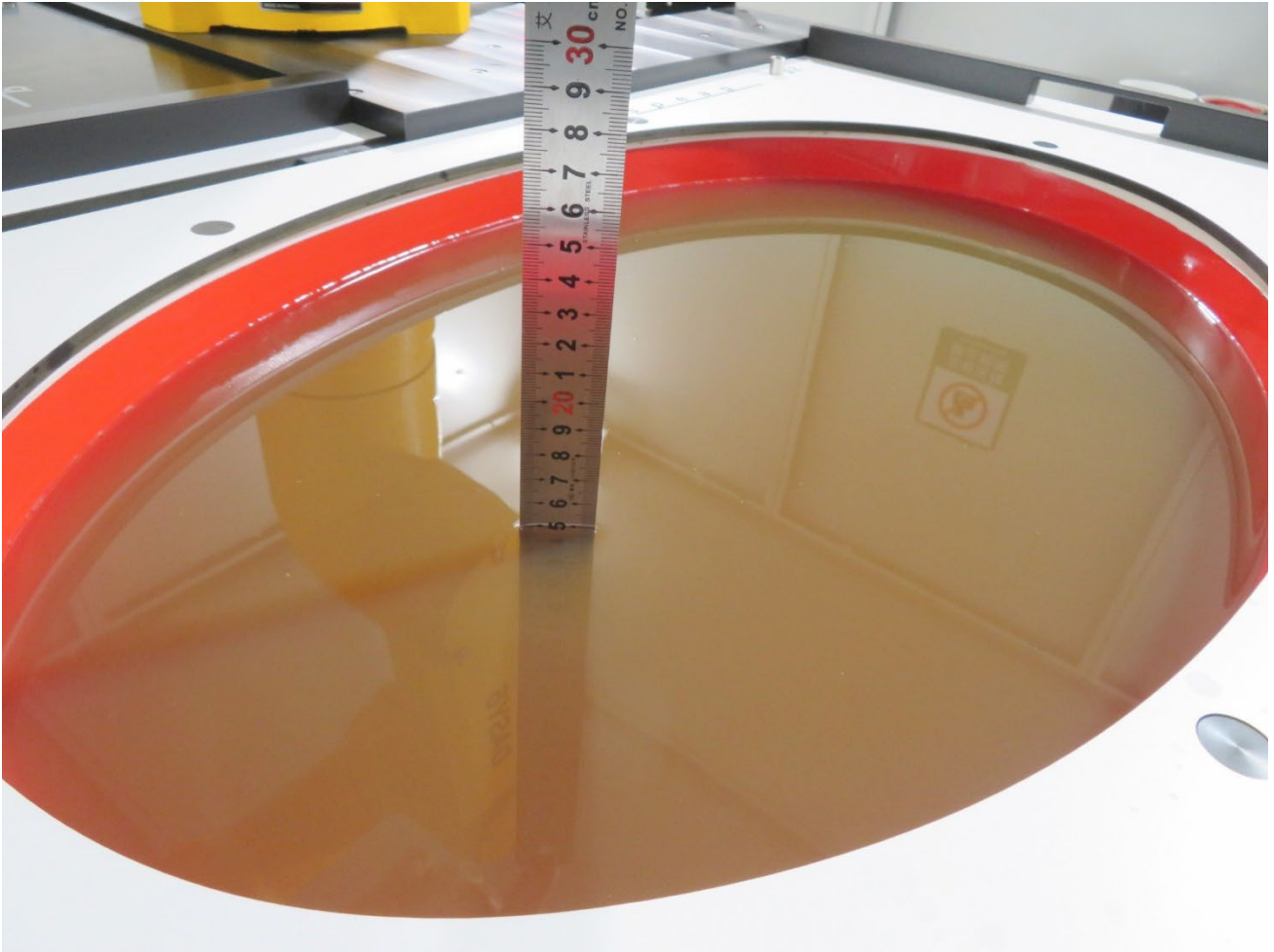

■ Dielectric properties of the head tissue-equivalent liquid

Frequency MHz	Relative Permittivity ϵ_r	Conductivity (σ) S/m
300	45.3	0.87
450	43.5	0.87
750	41.9	0.89
835	41.5	0.90
900	41.5	0.97
1 450	40.5	1.20
<i>1 500</i>	<i>40.4</i>	<i>1.23</i>
<i>1 640</i>	<i>40.2</i>	<i>1.31</i>
<i>1 750</i>	<i>40.1</i>	<i>1.37</i>
1 800	40.0	1.40
1 900	40.0	1.40
2 000	40.0	1.40
<i>2 100</i>	<i>39.8</i>	<i>1.49</i>
<i>2 300</i>	<i>39.5</i>	<i>1.67</i>
2 450	39.2	1.80
<i>2 600</i>	<i>39.0</i>	<i>1.96</i>
3 000	38.5	2.40
<i>3 500</i>	<i>37.9</i>	<i>2.91</i>
<i>4 000</i>	<i>37.4</i>	<i>3.43</i>
<i>4 500</i>	<i>36.8</i>	<i>3.94</i>
<i>5 000</i>	<i>36.2</i>	<i>4.45</i>
<i>5 200</i>	<i>36.0</i>	<i>4.66</i>
<i>5 400</i>	<i>35.8</i>	<i>4.86</i>
<i>5 600</i>	<i>35.5</i>	<i>5.07</i>
<i>5 800</i>	<i>35.3</i>	<i>5.27</i>
6 000	35.1	5.48

Note: For convenience, permittivity and conductivity values are linearly interpolated for frequencies that are not a part of the original data from Drossos et al. [2]. They are shown in italics in Table 2. The italicized values are linearly interpolated (below 5 800 MHz) or extrapolated (above 5 800 MHz) from the non-italicized values that are immediately above and below these values.

■ Tissue Calibration Result

The dielectric parameters of the liquids were verified prior to the SAR evaluation using DASY6 Dielectric Assessment Kit and keysight PNA-L Network Analyzer N5234B.

Freq. (MHz)	Perm.	Cond.	Target Perm.	Target Cond.	Deviation Perm. %	Deviation Cond. %	Tissue Temperature	Test Date
2450	40.39	1.78	39.20	1.80	3.04	-1.11	22.5°C	2024.06.07

Note: The $\pm 5\%$ deviation of tissue parameter is recommended.

6.2. SAR System Check

■ Purpose

The purpose of the system check is to verify that the system operates within its specifications at the device test frequencies. System check verifies the measurement repeatability of a SAR system before compliance testing and is not a validation of all system specifications. The latter is not required for testing a device but is mandatory before the system is deployed.

■ System Performance Check Setup Diagram

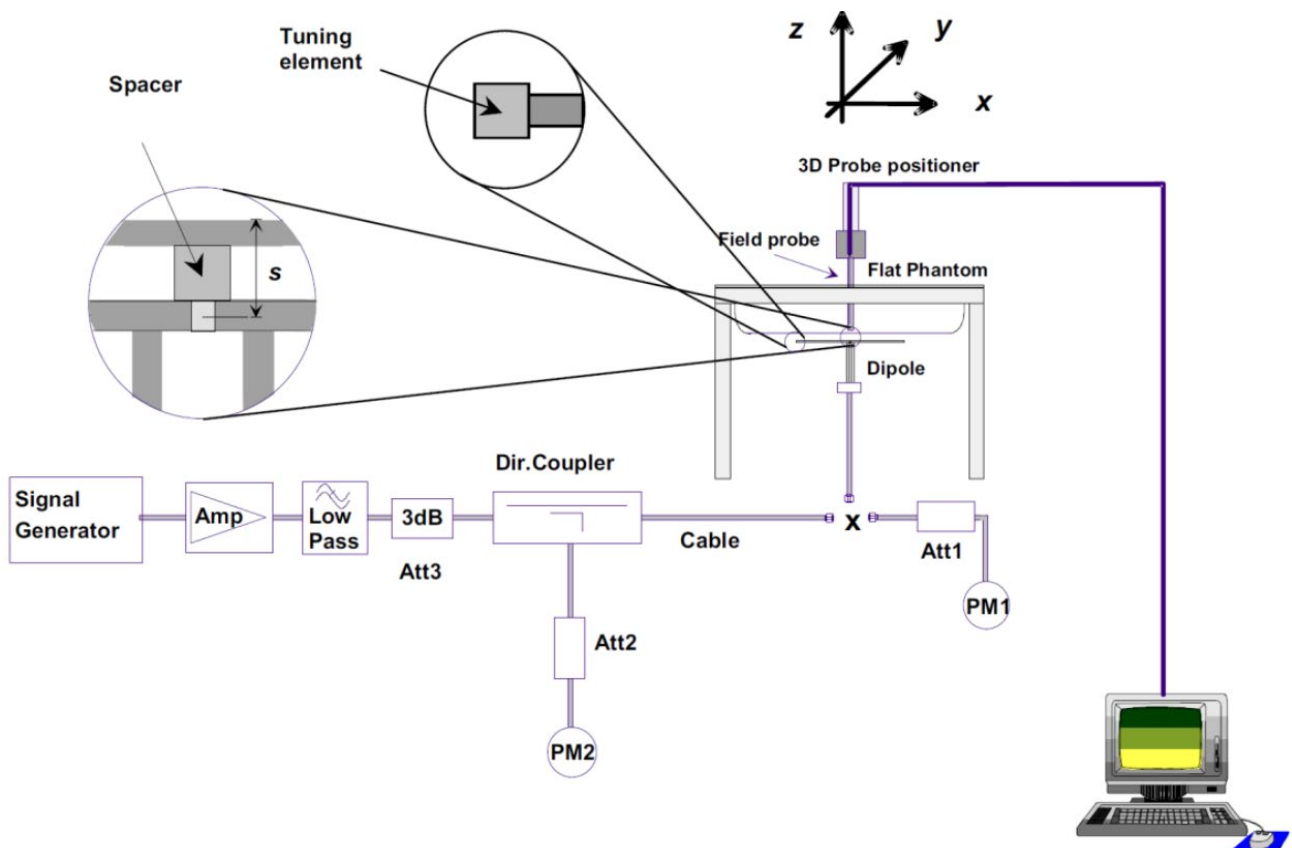

■ System Check Procedure

The system check procedure is a complete 1g and 10g peak spatial-average SAR measurement using a source having a previously determined system check target value. The measured 1g and 10g SAR are normalized to the target input power of the specific source and compared to their respective target values. A description of the different measurement tasks to be performed is given below, together with the information that can be deduced from their results:

- a. The Power Reference Measurement and Power Drift Measurement are located at the beginning and end of the batch process. They measure the field drift at one single point in the liquid over the complete procedure. The indicated drift is mainly the variation of the amplifier output power. If it is too high (above ± 0.1 dB), the

system check should be repeated; some amplifiers have very high drift during warm-up. A stable amplifier gives drift results in the DASY6 system below ± 0.02 dB.

b. The second step is optional. For probes with integrated optical surface detection sensor this step must be conducted, otherwise the step can be skipped. The Surface Check tests the optical surface detection system of the DASY6 system by repeatedly detecting the surface with the optical and mechanical surface detector and comparing the results. The output gives the detecting heights of both systems, the difference between the two systems and the standard deviation of the detection repeatability. Air bubbles or refraction in the liquid due to separation of the sugar-water mixture gives poor repeatability (above ± 0.1 mm). In that case it is better to abort the system check and stir the liquid.

c. The Area Scan measures the SAR above the dipole on a plane parallel to the surface. It is used to locate the approximate location of the peak SAR. The proposed scan uses large grid spacing for faster measurement; due to the symmetric field, the peak detection is reliable. If a finer graphic is desired, the grid spacing can be reduced. Grid spacing and orientation have no influence on the SAR result.

d. The Zoom Scan measures the field in a volume around the peak SAR value assessed in the previous Area Scan.

If the system check gives reasonable results, the SAR peak, 1 g and 10 g spatial average SAR values normalized to 1 W dipole input power give reference data for comparisons. The next sections analyze the expected uncertainties of these values, as well as additional checks for further information or troubleshooting.

■ Result of System Performance Check

Freq. (MHz)	1g SAR (W/kg)	10g SAR (W/kg)	Target 1g SAR (W/kg)	Target 10g SAR (W/kg)	Deviation 1g SAR (%)	Deviation 10g SAR (%)	Tissue Temp.	Test Date
2450	48.80	23.36	53.00	24.70	-7.92	-5.43	22.5°C	2024.06.07

Notes:

1. The $\pm 10\%$ deviation of system check result is required.
2. System check value listed above has been harmonized to 1W.

7. Analysis and Results

7.1. Antenna Location

Please refer to EUT Photograph.

7.2. Conducted Power

Mode	CH.	Freq. (MHz)	Average Power (dBm)	Max. Tune-up Power (dBm)	Duty Cycle %
DH5	0	2402	9.38	10.5	77.60
	39	2441	9.76	10.5	
	78	2480	9.94	10.5	
2DH5	0	2402	9.37	10.5	77.41
	39	2441	9.29	10.5	
	78	2480	9.46	10.5	
3DH5	0	2402	9.38	10.5	77.55
	39	2441	9.70	10.5	
	78	2480	10.07	10.5	
LE-1Mbps	0	2402	8.37	9.0	63.74
	19	2440	8.65	9.0	
	39	2480	8.85	9.0	
LE-2Mbps	0	2402	8.06	9.0	34.00
	19	2440	8.36	9.0	
	39	2480	8.49	9.0	
LE-Coded S=2	0	2402	8.38	9.0	57.68
	19	2440	8.71	9.0	
	39	2480	8.89	9.0	
LE-Coded S=8	0	2402	8.30	9.0	83.08
	19	2440	8.61	9.0	
	39	2480	8.87	9.0	

7.3. SAR Test Results

Test Site	WZ-SR3
Test Engineer	Bella Chen

Test Mode	CH.	Freq. (MHz)	Test Position	Dist. (mm)	Cond. Power (dBm)	Max. Tune-up Power (dBm)	Scaling Factor	Duty Cycle (%)	Duty Cycle Factor	Meas. SAR-1g (W/kg)	Reported SAR-1g (W/kg)	SAR Plot #
3DH5	0	2402	Vertical-Front_0°	5	9.38	10.5	1.29	77.55	1.29	0.21	0.35	1
	39	2441	Vertical-Front_0°	5	9.70	10.5	1.20	77.55	1.29	0.18	0.28	
	78	2480	Horizontal-UP_0°	5	10.07	10.5	1.10	77.55	1.29	0.17	0.24	
			Horizontal-UP_90°	5	10.07	10.5	1.10	77.55	1.29	0.01	0.01	
			Horizontal-Down_0°	5	10.07	10.5	1.10	77.55	1.29	0.17	0.24	
			Tip_90°	5	10.07	10.5	1.10	77.55	1.29	0.01	0.01	
			Vertical-Front_0°	5	10.07	10.5	1.10	77.55	1.29	0.23	0.33	
			Vertical-Back_0°	5	10.07	10.5	1.10	77.55	1.29	0.14	0.20	

8. Measuring Instrument

Instrument	Manufacturer	Type No.	Asset No.	Cali. Interval	Cali. Due Date
Stäubli Robot TX60L	Stäubli	TX60L	MRTSUE06412	N/A	N/A
Robot Controller	Stäubli	CS8C	MRTSUE06412	N/A	N/A
ELI Phantom Shell	Speag	V8	MRTSUE06420	N/A	N/A
DAK	Speag	DAK-3.5	MRTSUE06435	N/A	N/A
Dipole Validation Kits	Speag	D2450V2	MRTSUE06430	3 years	2027/05/06
Data Acquisition Electronic	Speag	DAE4(SN 1552)	MRTSUE06414	1 year	2025/05/13
E-Field Probe	Speag	EX3DV4(SN 7856)	MRTSUE07088	1 year	2024/12/05
Network Analyzer	Keysight	N5234B	MRTSUE06454	1 year	2025/05/08
Directional Coupler	Agilent	778D	MRTSUE06083	1 year	2025/03/05
Directional Coupler	Agilent	87301DOPT 292	MRTSUE06082	1 year	2025/03/05
Signal Generator	Keysight	N5183B	MRTSUE06197	1 year	2024/06/29
Power Sensor	Keysight	U2021XA	MRTSUE06446	1 year	2025/05/08
Thermohygrometer	Testo	622	MRTSUE06361	1 year	2025/05/22

Software	Version	Function
DASY NEO	52.10.4.1535	SAR Test Software

9. Measurement Uncertainty

DASY6 Uncertainty Budget, according to IEEE 1528 (0.3 - 3 GHz range)								
Error Description	Uncert. value	Prob. Dist.	Div.	(ci) 1g	(ci) 10g	Std. Unc. (1g)	Std. Unc. (10g)	(vi) v _{eff}
Measurement System								
Probe Calibration	±6.0 %	N	1	1	1	±6.0 %	±6.0 %	∞
Axial Isotropy	±4.7 %	R	$\sqrt{3}$	0.7	0.7	±1.9 %	±1.9 %	∞
Hemispherical Isotropy	±9.6 %	R	$\sqrt{3}$	0.7	0.7	±3.9 %	±3.9 %	∞
Boundary Effects	±1.0 %	R	$\sqrt{3}$	1	1	±0.6 %	±0.6 %	∞
Linearity	±4.7 %	R	$\sqrt{3}$	1	1	±2.7 %	±2.7 %	∞
System Detection Limits	±1.0 %	R	$\sqrt{3}$	1	1	±0.6 %	±0.6 %	∞
Modulation Response	±2.4 %	R	$\sqrt{3}$	1	1	±1.4 %	±1.4 %	∞
Readout Electronics	±0.3 %	N	1	1	1	±0.3 %	±0.3 %	∞
Response Time	±0.8 %	R	$\sqrt{3}$	1	1	±0.5 %	±0.5 %	∞
Integration Time	±2.6 %	R	$\sqrt{3}$	1	1	±1.5 %	±1.5 %	∞
RF Ambient Noise	±3.0 %	R	$\sqrt{3}$	1	1	±1.7 %	±1.7 %	∞
RF Ambient Reflections	±3.0 %	R	$\sqrt{3}$	1	1	±1.7 %	±1.7 %	∞
Probe Positioner	±0.02 %	R	$\sqrt{3}$	1	1	±0.0 %	±0.0 %	∞
Probe Positioning	±0.4 %	R	$\sqrt{3}$	1	1	±0.2 %	±0.2 %	∞
Max. SAR Eval.	±2.0 %	R	$\sqrt{3}$	1	1	±1.2 %	±1.2 %	∞
Test Sample Related								
Device Positioning	±2.9%	N	1	1	1	±2.9 %	±2.9 %	145
Device Holder	±3.6%	N	1	1	1	±3.6 %	±3.6 %	5
Power Drift	±5.0%	R	$\sqrt{3}$	1	1	±2.9 %	±2.9 %	∞
Power Scaling	±0%	R	$\sqrt{3}$	1	1	±0.0 %	±0.0 %	∞
Phantom and Setup								
Phantom Uncertainty	±6.1%	R	$\sqrt{3}$	1	1	±3.5 %	±3.5 %	∞
SAR correction	±1.9%	N	1	1	0.84	±1.9 %	±1.6 %	∞
Liquid Cond. (mea.) ^{DAK}	±2.5%	N	1	0.78	0.71	±2.0 %	±1.8 %	∞
Liquid Perm. (mea.) ^{DAK}	±2.5%	N	1	0.23	0.26	±0.6 %	±0.7 %	∞
Temp. unc. – Conductivity	±3.4%	R	$\sqrt{3}$	0.78	0.71	±1.5 %	±1.4 %	∞
Temp. unc. – Permittivity	±0.4%	R	$\sqrt{3}$	0.23	0.26	±0.1 %	±0.1 %	∞
Combined Std. Uncertainty						±11.3%	±11.2%	459
Expanded STD Uncertainty						±22.6%	±22.4%	

DASY6 Uncertainty Budget, according to IEEE 1528 (3 - 6 GHz range)								
Error Description	Uncert. value	Prob. Dist.	Div.	(ci) 1g	(ci) 10g	Std. Unc. (10g)	Std. Unc. (10g)	(vi) v _{eff}
Measurement System								
Probe Calibration	±6.55 %	N	1	1	1	±6.55 %	±6.55 %	∞
Axial Isotropy	±4.7 %	R	$\sqrt{3}$	0.7	0.7	±1.9 %	±1.9 %	∞
Hemispherical Isotropy	±9.6 %	R	$\sqrt{3}$	0.7	0.7	±3.9 %	±3.9 %	∞
Boundary Effects	±2.0 %	R	$\sqrt{3}$	1	1	±1.2 %	±1.2 %	∞
Linearity	±4.7 %	R	$\sqrt{3}$	1	1	±2.7 %	±2.7 %	∞
System Detection Limits	±1.0 %	R	$\sqrt{3}$	1	1	±0.6 %	±0.6 %	∞
Modulation Response	±2.4 %	R	$\sqrt{3}$	1	1	±1.4 %	±1.4 %	∞
Readout Electronics	±0.3 %	N	1	1	1	±0.3 %	±0.3 %	∞
Response Time	±0.8 %	R	$\sqrt{3}$	1	1	±0.5 %	±0.5 %	∞
Integration Time	±2.6 %	R	$\sqrt{3}$	1	1	±1.5 %	±1.5 %	∞
RF Ambient Noise	±3.0 %	R	$\sqrt{3}$	1	1	±1.7 %	±1.7 %	∞
RF Ambient Reflections	±3.0 %	R	$\sqrt{3}$	1	1	±1.7 %	±1.7 %	∞
Probe Positioner	±0.04 %	R	$\sqrt{3}$	1	1	±0.0 %	±0.0 %	∞
Probe Positioning	±0.8 %	R	$\sqrt{3}$	1	1	±0.5 %	±0.5 %	∞
Max. SAR Eval.	±4.0 %	R	$\sqrt{3}$	1	1	±2.3 %	±2.3 %	∞
Test Sample Related								
Device Positioning	±2.9%	N	1	1	1	±2.9 %	±2.9 %	145
Device Holder	±3.6%	N	1	1	1	±3.6 %	±3.6 %	5
Power Drift	±5.0%	R	$\sqrt{3}$	1	1	±2.9 %	±2.9 %	∞
Power Scaling	±0%	R	$\sqrt{3}$	1	1	±0.0 %	±0.0 %	∞
Phantom and Setup								
Phantom Uncertainty	±6.6%	R	$\sqrt{3}$	1	1	±3.8 %	±3.8 %	∞
SAR correction	±1.9%	N	1	1	0.84	±1.9 %	±1.6 %	∞
Liquid Cond. (mea.) ^{DAK}	±2.5%	N	1	0.78	0.71	±2.0 %	±1.8 %	∞
Liquid Perm. (mea.) ^{DAK}	±2.5%	N	1	0.23	0.26	±0.6 %	±0.7 %	∞
Temp. unc. – Conductivity	±3.4%	R	$\sqrt{3}$	0.78	0.71	±1.5 %	±1.4 %	∞
Temp. unc. – Permittivity	±0.4%	R	$\sqrt{3}$	0.23	0.26	±0.1 %	±0.1 %	∞
Combined Std. Uncertainty						±11.9%	±11.8%	569
Expanded STD Uncertainty						±23.8%	±23.6%	

Annex A - System Check Result

Test Date: 2024/06/07

SystemPerformanceCheck-SAM2-D2450HSL

DUT: Dipole 2450 MHz D2450V2; Type: D2450V2

Communication System: CW; Frequency: 2450 MHz; Duty Cycle: 1:1

Medium parameters used: $f = 2450$ MHz; $\sigma = 1.78$ S/m; $\epsilon_r = 40.39$; $\rho = 1000$ kg/m³

Phantom section: Flat Section

DASY5 Configuration:

- Probe: EX3DV4 - SN7856; ConvF(7.08, 7.12, 7.02) @ 2450 MHz; Calibrated: 2023/12/6
- Sensor-Surface: 1.4mm (Mechanical Surface Detection)
- Electronics: DAE4 Sn1552; Calibrated: 2024/5/14
- Phantom: SAM2; Type: QD OVA 004 AA; Serial: 2089
- Measurement SW: DASY52, Version 52.10 (4); SEMCAD X Version 14.6.14 (7501)

configuration/d=10mm, Pin=250mW, dist=1.4mm (EX-Probe)/Area Scan (7x9x1): Measurement grid:

$dx=12$ mm, $dy=12$ mm; Maximum value of SAR (measured) = 19.1 W/kg

configuration/d=10mm, Pin=250mW, dist=1.4mm (EX-Probe)/Zoom Scan (7x7x7)/Cube 0: Measurement

grid: $dx=5$ mm, $dy=5$ mm, $dz=5$ mm; Reference Value = 101.8 V/m; Power Drift = 0.02 dB

Peak SAR (extrapolated) = 24.0 W/kg

SAR(1 g) = 12.2 W/kg; SAR(10 g) = 5.84 W/kg

Smallest distance from peaks to all points 3 dB below = 9.1 mm

Ratio of SAR at M2 to SAR at M1 = 51.6%

Maximum value of SAR (measured) = 19.7 W/kg

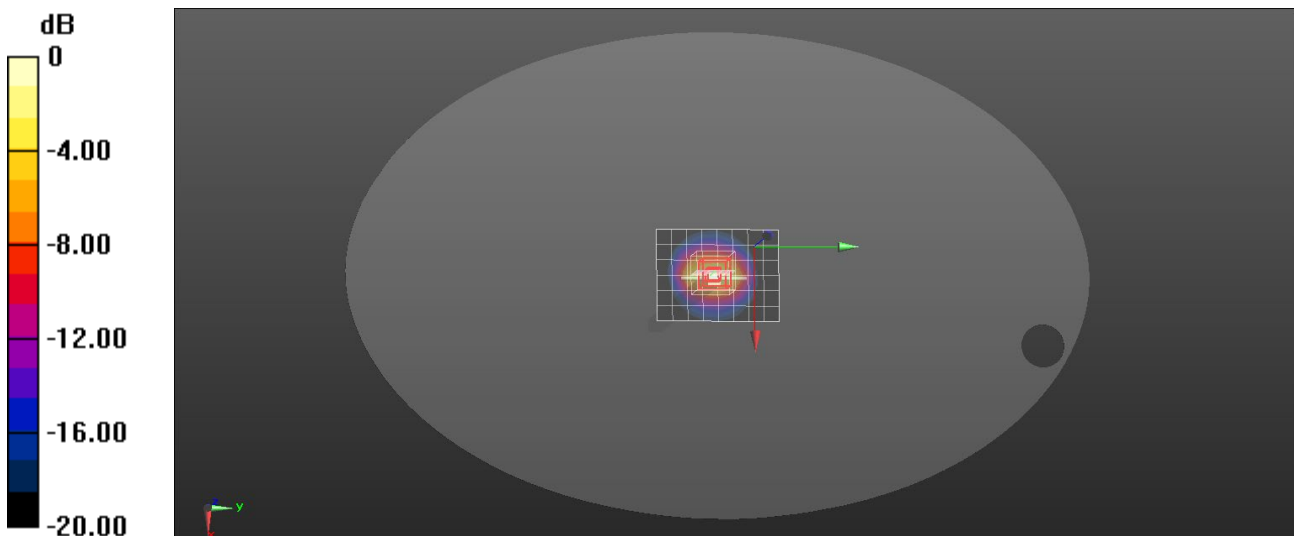

0 dB = 19.7 W/kg = 12.94 dBW/kg

Annex B - Test Data Plots

Plot 1#

Test Date: 2024/06/07

DUT: Long Range Bluetooth USB Adapter; Type: UB500 Plus

Procedure Name: Bluetooth 3DH5 2402MHz Vertical-Front_degree 0

Communication System: Bluetooth; Frequency: 2402 MHz; Duty Cycle: 1:1

Medium parameters used: $f = 2402$ MHz; $\sigma = 1.74$ S/m; $\epsilon_r = 40.44$; $\rho = 1000$ kg/m³; Tissue Temp (celsius)-22.5°C; Phantom section: Flat Section

DASY5 Configuration:

- Probe: EX3DV4 - SN7856; ConvF(7.08, 7.12, 7.02) @ 2402 MHz; Calibrated: 2023/12/6
- Sensor-Surface: 1.4mm (Mechanical Surface Detection)
- Electronics: DAE4 Sn1552; Calibrated: 2024/5/14
- Phantom: SAM2; Type: QD OVA 004 AA; Serial: 2089
- Measurement SW: DASY52, Version 52.10 (4); SEMCAD X Version 14.6.14 (7501)

Configuration/Bluetooth 3DH5 2402MHz Vertical-Front_degree 0/Area Scan (6x12x1): Measurement grid:

$dx=12$ mm, $dy=12$ mm; Maximum value of SAR (measured) = 0.236 W/kg

Configuration/Bluetooth 3DH5 2402MHz Vertical-Front_degree 0/Zoom Scan (7x7x7)/Cube 0:

Measurement grid: $dx=5$ mm, $dy=5$ mm, $dz=5$ mm; Reference Value = 4.798 V/m; Power Drift = 0.14 dB

Peak SAR (extrapolated) = 0.433 W/kg

SAR(1 g) = 0.210 W/kg; SAR(10 g) = 0.101 W/kg

Smallest distance from peaks to all points 3 dB below = 9.2 mm

Ratio of SAR at M2 to SAR at M1 = 49.3%

Maximum value of SAR (measured) = 0.343 W/kg

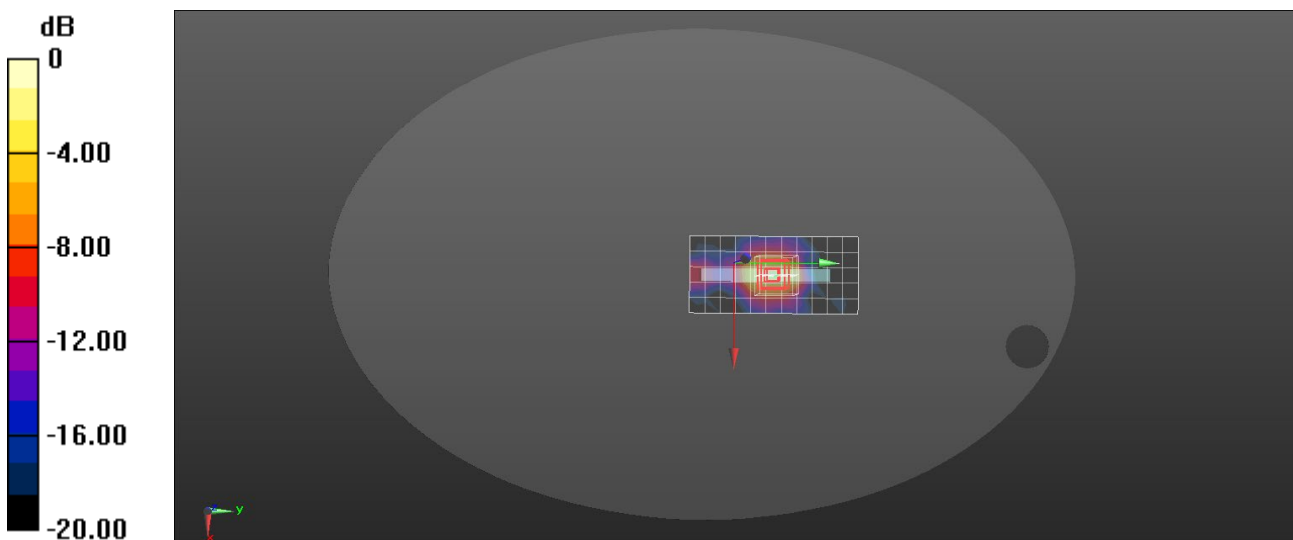

0 dB = 0.343 W/kg = -4.65 dBW/kg

Annex C - SAR Test Setup Photograph

Please refer to document "2405RSU025-UT".

Annex D - EUT Photograph

Please refer to EUT Photograph.

Annex E - Equipment Calibration Report

Please refer to document "Annex E - Equipment Calibration Report.pdf".

————— The End —————