



## RF MEASUREMENT REPORT

---

**FCC ID** : 2BCGWTBE550E  
**APPLICANT** : TP-LINK CORPORATION PTE. LTD.  
**Application Type** : Certification  
**Product** : BE9300 Wi-Fi 7 Bluetooth PCIe Adapter  
**Model No.** : Archer TBE550E  
**Brand Name** : tp-link  
**FCC Classification** : Digital Transmission System (DTS)  
**FCC Rule Part(s)** : Part 15.247  
**Test Procedure(s)** : ANSI C63.10-2013  
**Received Date** : November 9, 2023  
**Test Date** : November 22, 2023~ November 29, 2023

**Tested By** : Owen Tsai  
( Owen Tsai )

**Reviewed By** : Paddy Chen  
( Paddy Chen )

**Approved By** : Chenz Ker  
( Chenz Ker )



The test results only relate to the tested sample.

This equipment has been shown to be capable of compliance with the applicable technical standards as indicated in the measurement report and was tested in accordance with the measurement procedures specified in ANSI C63.10. Test results reported herein relate only to the item(s) tested.

The test report shall not be reproduced except in full without the written approval of MRT Technology (Taiwan) Co., Ltd.

---

## Revision History

Report No.	Version	Description	Issue Date	Note
2311TW0112-U3	1.0	Original Report	2024-01-19	Valid

---

## CONTENTS

Description	Page
<b>§2.1033 General Information .....</b>	<b>5</b>
<b>1. INTRODUCTION .....</b>	<b>6</b>
1.1. Scope.....	6
1.2. MRT Test Location.....	6
<b>2. PRODUCT INFORMATION .....</b>	<b>7</b>
2.1. Equipment Description .....	7
2.2. Product Specification Subjective to this Standard.....	7
2.3. Test Mode.....	7
2.4. Operation Frequency / Channel List.....	8
2.5. Test Configuration.....	9
2.6. Test System Details .....	9
2.7. Test Software.....	10
2.8. Duty Cycle.....	10
2.9. EMI Suppression Device(s)/Modifications .....	11
2.10. Labeling Requirements .....	11
<b>3. DESCRIPTION of TEST .....</b>	<b>12</b>
3.1. Evaluation Procedure.....	12
3.2. AC Line Conducted Emissions .....	12
3.3. Radiated Emissions .....	13
<b>4. ANTENNA REQUIREMENTS.....</b>	<b>14</b>
<b>5. TEST EQUIPMENT CALIBRATION DATE.....</b>	<b>15</b>
<b>6. MEASUREMENT UNCERTAINTY.....</b>	<b>16</b>
<b>7. TEST RESULT .....</b>	<b>17</b>
7.1. Summary.....	17
7.2. 6dB Bandwidth Measurement .....	18
7.2.1. Test Limit.....	18
7.2.2. Test Procedure used .....	18
7.2.3. Test Setting .....	18
7.2.4. Test Setup.....	18
7.2.5. Test Result .....	19
7.3. Output Power Measurement.....	24
7.3.1. Test Limit.....	24
7.3.2. Test Procedure Used.....	24
7.3.3. Test Setting .....	24
7.3.4. Test Setup.....	24
7.3.5. Test Result of Output Power.....	25
7.4. Power Spectral Density Measurement .....	26
7.4.1. Test Limit.....	26
7.4.2. Test Procedure Used.....	26
7.4.3. Test Setting .....	26

---

7.4.4.	Test Setup .....	27
7.4.5.	Test Result .....	28
7.5.	Out-of-Band Spurious Emissions Emissions Measurement .....	33
7.5.1.	Test Limit .....	33
7.5.2.	Test Procedure Used .....	33
7.5.3.	Test Settintg .....	33
7.5.4.	Test Setup .....	34
7.5.5.	Test Result .....	35
7.6.	Radiated Spurious Emission Measurement .....	40
7.6.1.	Test Limit .....	40
7.6.2.	Test Procedure Used .....	40
7.6.3.	Test Setting .....	40
7.6.4.	Test Setup .....	42
7.6.5.	Test Result .....	44
7.7.	Radiated Restricted Band Edge Measurement .....	70
7.7.1.	Test Limit .....	70
7.7.2.	Test Procedure Used .....	70
7.7.3.	Test Setting .....	70
7.7.4.	Test Setup .....	72
7.7.5.	Test Result .....	73
7.8.	AC Conducted Emissions Measurement .....	93
7.8.1.	Test Limit .....	93
7.8.2.	Test Setup .....	93
7.8.3.	Test Result .....	94
<b>8.</b>	<b>CONCLUSION .....</b>	<b>98</b>
	<b>Appendix A : Test Photograph .....</b>	<b>99</b>
	<b>Appendix B : External Photograph .....</b>	<b>99</b>
	<b>Appendix C : Internal Photograph .....</b>	<b>99</b>

## §2.1033 General Information

<b>Applicant</b>	TP-LINK CORPORATION PTE. LTD.
<b>Applicant Address</b>	7 Temasek Boulevard #29-03 Suntec Tower One, Singapore 038987
<b>Manufacturer</b>	TP-LINK CORPORATION PTE. LTD.
<b>Manufacturer Address</b>	7 Temasek Boulevard #29-03 Suntec Tower One, Singapore 038987
<b>Test Site</b>	MRT Technology (Taiwan) Co., Ltd
<b>Test Site Address</b>	No. 38, Fuxing Second Rd., Guishan Dist., Taoyuan City 333, Taiwan (R.O.C)
<b>MRT FCC Registration No.</b>	291082
<b>FCC Rule Part(s)</b>	Part 15.247

### Test Facility / Accreditations

1. MRT facility is a FCC registered (Reg. No. 291082) test facility with the site description report on file and is designated by the FCC as an Accredited Test Firm.
2. MRT facility is an IC registered (MRT Reg. No. 21723) test laboratory with the site description on file at Industry Canada.
3. MRT Lab is accredited to ISO 17025 by the Taiwan Accreditation Foundation (TAF Cert. No. 3261) in EMC, Telecommunications and Radio testing for FCC (Designation Number: TW3261), Industry Canada, EU and TELEC Rules.

# 1. INTRODUCTION

## 1.1. Scope

Measurement and determination of electromagnetic emissions (EMC) of radio frequency devices including intentional and/or unintentional radiators for compliance with the technical rules and regulations of the Federal Communications Commission and the Industry Canada Certification and Engineering Bureau.

## 1.2. MRT Test Location

The map below shows the location of the MRT LABORATORY, its proximity to the Taoyuan City. These measurement tests were conducted at the MRT Technology (Taiwan) Co., Ltd. Facility located at No.38, Fuxing 2nd Rd., Guishan Dist., Taoyuan City 33377, Taiwan (R.O.C).

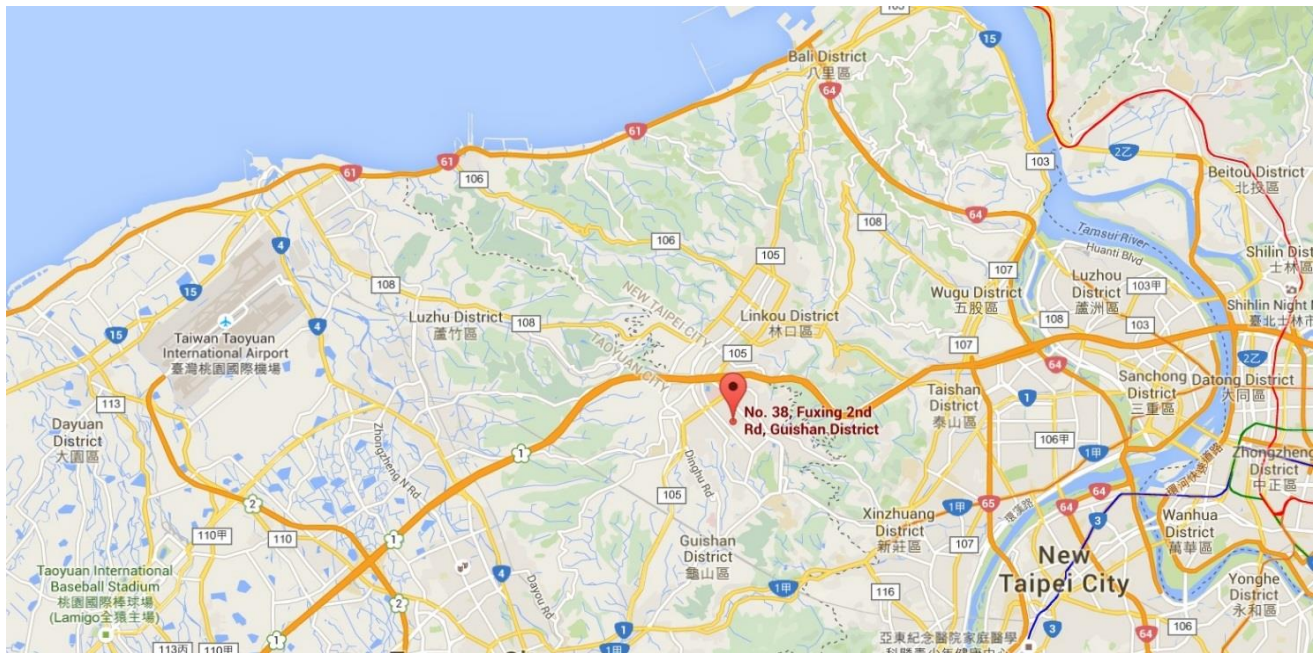

## 2. PRODUCT INFORMATION

### 2.1. Equipment Description

Product Name	BE9300 Wi-Fi 7 Bluetooth PCIe Adapter
Model No.	Archer TBE550E
Brand Name	tp-link
Bluetooth Specification	Bluetooth Mode: V4.2
Wi-Fi Specification	802.11a/b/g/n/ac/ax/be
EUT Identification No.:	#1-1 (Conducted) #1-2 (Radiated)

### 2.2. Product Specification Subjective to this Standard

Operating Frequency	2402~2480MHz
Type of modulation	GFSK
Data Rate	1Mbps / 2Mbps / S2 / S8
Antenna Type	Dipole
Antenna Gain	1.0dBi

### 2.3. Test Mode

Test Mode	Mode 1: Transmit - LE (1Mbps) Mode 2: Transmit - LE (2Mbps) Mode 3: Transmit - LE (Coded S=2) Mode 4: Transmit - LE (Coded S=8)
-----------	------------------------------------------------------------------------------------------------------------------------------------------

Note: Regarding to the operation frequency, the lowest, middle and highest frequency are selected to perform the test.

## 2.4. Operation Frequency / Channel List

Channel	Frequency	Channel	Frequency	Channel	Frequency
00	2402 MHz	01	2404 MHz	02	2406 MHz
03	2408 MHz	04	2410 MHz	05	2412 MHz
06	2414 MHz	07	2416 MHz	08	2418 MHz
09	2420 MHz	10	2422 MHz	11	2424 MHz
12	2426 MHz	13	2428 MHz	14	2430 MHz
15	2432 MHz	16	2434 MHz	17	2436 MHz
18	2438 MHz	19	2440 MHz	20	2442 MHz
21	2444 MHz	22	2446 MHz	23	2448 MHz
24	2450 MHz	25	2452 MHz	26	2454 MHz
27	2456 MHz	28	2458 MHz	29	2460 MHz
30	2462 MHz	31	2464 MHz	32	2466 MHz
33	2468 MHz	34	2470 MHz	35	2472 MHz
36	2474 MHz	37	2476 MHz	38	2478 MHz
39	2480 MHz	N/A	N/A	N/A	N/A



## 2.5. Test Configuration

This device was tested per the guidance of ANSI C63.10-2013. ANSI C63.10-2013 was used to reference the appropriate EUT setup for radiated spurious emissions testing and AC line conducted testing.

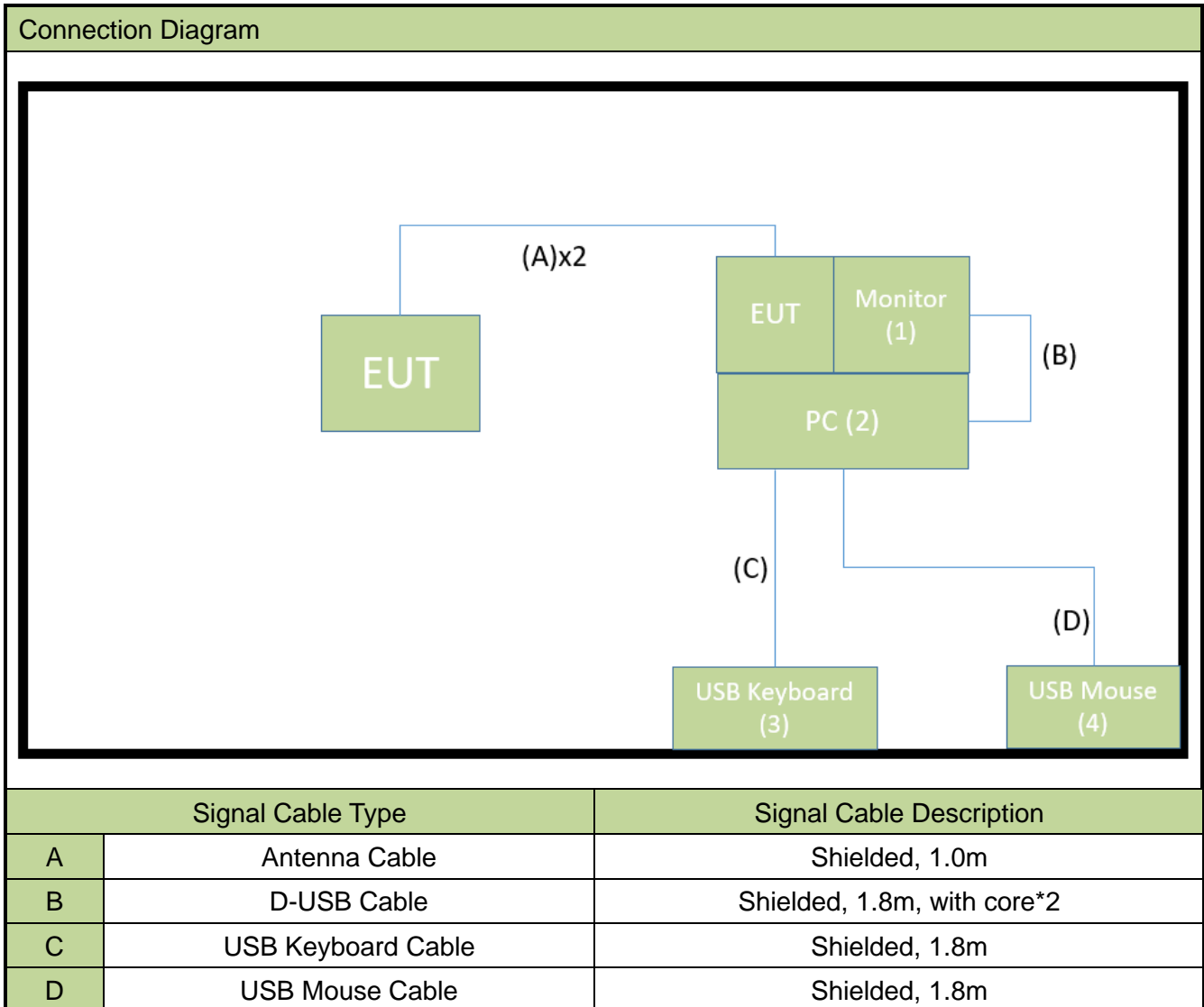

## 2.6. Test System Details

The types for all equipments, plus descriptions of all cables used in the tested system (including inserted cards) are:

	Product	Manufacturer	Model No.	Serial No.	Power Cord
1	Monitor	acer	K242HYL	N/A	Non-shielded, 1.8m
2	PC	TP-LINK	QNOBQCQ	N/A	Non-shielded, 1.8m
3	USB Keyboard	Lenovo	KU-0225	N/A	N/A
4	USB Mouse	Lenovo	M-U0025-O	N/A	N/A

## 2.7. Test Software

The test utility software used during testing was “WCN Combo Tool v3.4.0.47”.

## 2.8. Duty Cycle

Test Mode	Duty Cycle
BLE-1Mbps	85.43%
BLE-2Mbps	57.52%
BLE-Coded S=2	91.39%
BLE-Coded S=8	97.54%

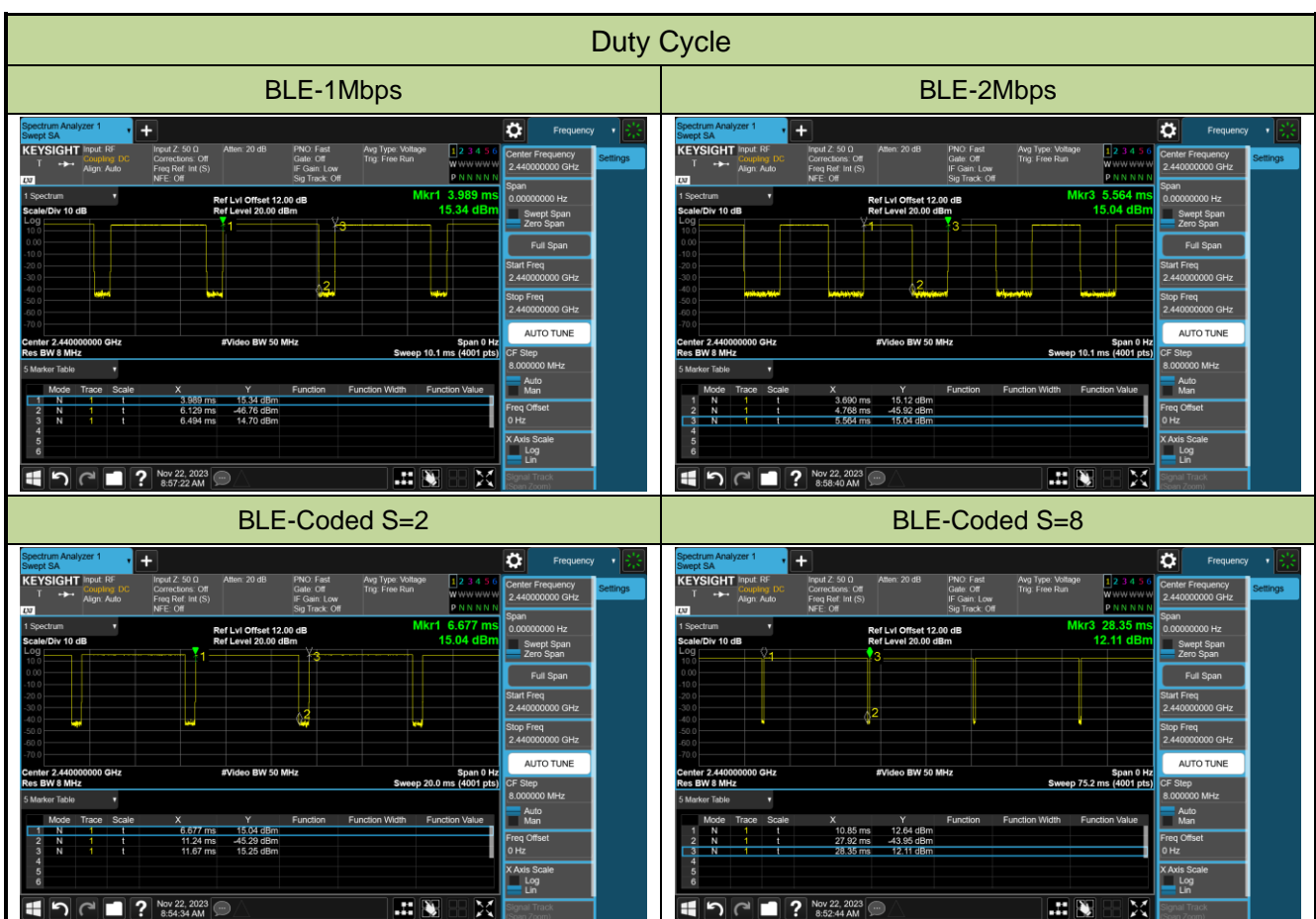

## **2.9. EMI Suppression Device(s)/Modifications**

No EMI suppression device(s) were added and/or no modifications were made during testing.

## **2.10. Labeling Requirements**

Per 2.1074 & 15.19; Docket 95-19

The label shall be permanently affixed at a conspicuous location on the device; instruction manual or pamphlet supplied to the user and be readily visible to the purchaser at the time of purchase.

However, when the device is so small wherein placement of the label with specified statement is not practical, only the FCC ID must be displayed on the device per Section 15.19(a)(5). Please see attachment for FCC ID label and label location.

### 3. DESCRIPTION of TEST

#### 3.1. Evaluation Procedure

The measurement procedures described in the American National Standard for Testing Unlicensed Wireless Devices (ANSI C63.10-2013), and the guidance provided in KDB 558074 D01v05r02 were used in the measurement of the **BE9300 Wi-Fi 7 Bluetooth PCIe Adapter**.

**Deviation from measurement procedure.....None**

#### 3.2. AC Line Conducted Emissions

The line-conducted facility is located inside an 9'x4'x3' shielded enclosure. A 1m x 2m wooden table 80cm high is placed 40cm away from the vertical wall and 80cm away from the sidewall of the shielded room. Two 10kHz-30MHz, 50Ω/50uH Line-Impedance Stabilization Networks (LISNs) are bonded to the shielded room floor. Power to the LISNs is filtered by external high-current high-insertion loss power line filters. These filters attenuate ambient signal noise from entering the measurement lines. These filters are also bonded to the shielded enclosure.

The EUT is powered from one LISN and the support equipment is powered from the second LISN. All interconnecting cables more than 1 meter were shortened to a 1 meter length by non-inductive bundling (serpentine fashion) and draped over the back edge of the test table. All cables were at least 40cm above the horizontal reference ground-plane. Power cables for support equipment were routed down to the second LISN while ensuring that that cables were not draped over the second LISN.

Sufficient time for the EUT, support equipment, and test equipment was allowed in order for them to warm up to their normal operating condition. The RF output of the LISN was connected to the receiver and exploratory measurements were made to determine the frequencies producing the maximum emission from the EUT. The receiver was scanned from 150kHz to 30MHz. The detector function was set to peak mode for exploratory measurements while the bandwidth of the analyzer was set to 9kHz. The EUT, support equipment, and interconnecting cables were arranged and manipulated to maximize each emission. Each emission was also maximized by varying: power lines, the mode of operation or data exchange speed, or support equipment which determined the worst-case emission. Once the worst case emissions have been identified, the one EUT cable configuration/arrangement and mode of operation that produced these emissions are used for final measurements on the same test site. The analyzer is set to CISPR quasi-peak and average detectors with a 9kHz resolution bandwidth for final measurements.

An extension cord was used to connect to a single LISN which powered by EUT. The extension cord was calibrated with LISN, the impedance and insertion loss are compliance with the requirements as stated in ANSI C63.10-2013.

Line conducted emissions test results are shown in Section 7.8.

### 3.3. Radiated Emissions

The radiated test facilities consisted of an indoor 3 meter semi-anechoic chamber used for final measurements and exploratory measurements, when necessary. The measurement area is contained within the semi-anechoic chamber which is shielded from any ambient interference. For measurements above 1GHz absorbers are arranged on the floor between the turn table and the antenna mast in such a way so as to maximize the reduction of reflections. For measurements below 1GHz, the absorbers are removed. A MF Model 210SS turntable is used for radiated measurement. It is a continuously rotatable, remote controlled, metallic turntable and 2 meters (6.56 ft.) in diameter. The turn table is flush with the raised floor of the chamber in order to maintain its function as a ground plane. An 80cm high PVC support structure is placed on top of the turntable.

For all measurements, the spectrum was scanned through all EUT azimuths and from 1 to 4 meter receive antenna height using a broadband antenna from 30MHz up to the upper frequency shown in 15.33(b)(1) depending on the highest frequency generated or used in the device or on which the device operates or tunes. For frequencies above 1GHz, linearly polarized double ridge horn antennas were used. For frequencies below 30MHz, a calibrated loop antenna was used. When exploratory measurements were necessary, they were performed at 1 meter test distance inside the semi-anechoic chamber using broadband antennas, broadband amplifiers, and spectrum analyzers to determine the frequencies and modes producing the maximum emissions. Sufficient time for the EUT, support equipment, and test equipment was allowed in order for them to warm up to their normal operating condition. The test set-up for frequencies below 1GHz was placed on top of the 0.8 meter high, 1 x 1.5 meter table; and test set-up for frequencies 1-40GHz was placed on top of the 1.5 meter high, 1 x 1.5 meter table. The EUT, support equipment, and interconnecting cables were arranged and manipulated to maximize each emission. Appropriate precaution was taken to ensure that all emissions from the EUT were maximized and investigated. The system configuration, clock speed, mode of operation or video resolution, if applicable, turntable azimuth, and receive antenna height was noted for each frequency found.

Final measurements were made in the semi-anechoic chamber using calibrated, linearly polarized broadband and horn antennas. The test setup was configured to the setup that produced the worst case emissions. The spectrum analyzer was set to investigate all frequencies required for testing to compare the highest radiated disturbances with respect to the specified limits. The turntable containing the EUT was rotated through 360 degrees and the height of the receive antenna was varied 1 to 4 meters and stopped at the azimuth and height producing the maximum emission. Each emission was maximized by changing the orientation of the EUT through three orthogonal planes and changing the polarity of the receive antenna, which produced the worst-case emissions. According to 3dB Beam-Width of horn antenna, the horn antenna should be always directed to the EUT when rising height.

Radiated emissions test results are shown in Section 7.6 & 7.7 .

## 4. ANTENNA REQUIREMENTS

### Excerpt from §15.203 of the FCC Rules/Regulations:

“An intentional radiator antenna shall be designed to ensure that no antenna other than that furnished by the responsible party can be used with the device. The use of a permanently attached antenna or of an antenna that uses a unique coupling to the intentional radiator shall be considered sufficient to comply with the provisions of this section.”

- The antenna of the BE9300 Wi-Fi 7 Bluetooth PCIe Adapter is **an external antenna with a RP-SMA connector.**

### **Conclusion:**

The EUT unit complies with the requirement of §15.203.

## 5. TEST EQUIPMENT CALIBRATION DATE

### Conducted Emissions – SR2

Instrument	Manufacturer	Type No.	Asset No.	Cali. Interval	Cali. Due Date
Two-Line V-Network	R&S	ENV216	MRTTWA00020	1 year	2024/4/17
Cable	Rosnol	N1C50-RG400-B 1C50-500CM	MRTTWE00013	1 year	2024/6/15
EMI Test Receiver	R&S	ESR3	MRTTWA00009	1 year	2024/3/8

### Radiated Emissions – AC2

Instrument	Manufacturer	Type No.	Asset No.	Cali. Interval	Cali. Due Date
Active Loop Antenna	SCHWARZBECK	FMZB 1519B	MRTTWA00002	1 year	2024/5/22
Broadband TRILOG Antenna	SCHWARZBECK	VULB 9162	MRTTWA00001	1 year	2024/10/31
Broadband Hornantenna	RFSPIN	DRH18-E	MRTTWA00087	1 year	2024/5/17
Broadband Preamplicifier	EMC Instruments corporation	EMC118A45SE	MRTTWA00088	1 year	2024/5/17
Breitband Hornantenna	SCHWARZBECK	BBHA 9170	MRTTWA00004	1 year	2024/3/20
Broadband Amplifier	SCHWARZBECK	BBV 9721	MRTTWA00006	1 year	2024/3/27
EMI Test Receiver	R&S	ESR3	MRTTWA00009	1 year	2024/3/8
Signal Analyzer	R&S	FSVA3044	MRTTWA00092	1 year	2024/6/29
Antenna Cable	HUBERSUHNER	SF106	MRTTWE00034	1 year	2024/6/26
Cable	HUBERSUHNER	EMC105-NM-NM -3000	MRTTWE00035	1 year	2024/6/26
Temperature/Humidity Meter	TFA	35.1078.10.IT	MRTTWA00032	1 year	2024/6/4

### Conducted Test Equipment – SR5

Instrument	Manufacturer	Type No.	Asset No.	Cali. Interval	Cali. Due Date
EXA Signal Analyzer	KEYSIGHT	N9010A	MRTTWA00012	1 year	2024/10/17
EXA Signal Analyzer	KEYSIGHT	N9010B	MRTTWA00074	1 year	2024/7/19
USB Wideband Power Sensor	KEYSIGHT	U2021XA	MRTTWA00015	1 year	2024/3/16

### Test Software

Software	Version	Function
e3	9.160520a	EMI Test Software
EMI	V3	EMI Test Software

## 6. MEASUREMENT UNCERTAINTY

Where relevant, the following test uncertainty levels have been estimated for tests performed on the EUT as specified in CISPR 16-4-2. This uncertainty represents an expanded uncertainty expressed at approximately the 95% confidence level using a coverage factor of  $k = 2$ .

<b>Conducted Emission- Power Line</b>
Measuring Uncertainty for a Level of Confidence of 95% ( $U=2Uc(y)$ ): 0.15MHz~30MHz: $\pm 2.53\text{dB}$
<b>Radiated Spurious Emission</b>
Measuring Uncertainty for a Level of Confidence of 95% ( $U=2Uc(y)$ ): 9kHz~30MHz: $\pm 3.92\text{dB}$ 30MHz~1GHz: $\pm 4.25\text{dB}$ 1GHz~18GHz: $\pm 4.40\text{dB}$ 18GHz~40GHz: $\pm 4.45\text{dB}$
<b>Frequency Error</b>
Measuring Uncertainty for a Level of Confidence of 95% ( $U=2Uc(y)$ ): $\pm 78.4\text{Hz}$
<b>Conducted Power</b>
Measuring Uncertainty for a Level of Confidence of 95% ( $U=2Uc(y)$ ): $\pm 0.84\text{dB}$
<b>Conducted Spurious Emission</b>
Measuring Uncertainty for a Level of Confidence of 95% ( $U=2Uc(y)$ ): $\pm 2.65\text{ dB}$
<b>Occupied Bandwidth</b>
Measuring Uncertainty for a Level of Confidence of 95% ( $U=2Uc(y)$ ): $\pm 3.3\%$
<b>Temp. / Humidity</b>
Measuring Uncertainty for a Level of Confidence of 95% ( $U=2Uc(y)$ ): $\pm 0.82^\circ\text{C}/ \pm 3\%$
<b>DC Voltage</b>
Measuring Uncertainty for a Level of Confidence of 95% ( $U=2Uc(y)$ ): $\pm 0.3\%$



## 7. TEST RESULT

### 7.1. Summary

FCC Part Section(s)	Test Description	Test Limit	Test Condition	Test Result	Reference
15.247(a)(2)	6dB Bandwidth	$\geq 500\text{kHz}$	Conducted	Pass	Section 7.2
15.247(b)(3)	Output Power	$\leq 30.00\text{dBm}$		Pass	Section 7.3
15.247(e)	Power Spectral Density	$\leq 8.00\text{dBm}/3\text{kHz}$		Pass	Section 7.4
15.247(d)	Out-of-Band Emissions	Conducted $\geq 20\text{dBc}$		Pass	Section 7.5
15.205 15.209	Spurious Emission	< FCC 15.209 limits	Radiated	Pass	Section 7.6
15.205 15.209	Band Edge Measurement	$\leq 74\text{dBuV/m(Peak)}$ $\leq 54\text{dBuV/m(Average)}$		Pass	Section 7.7
15.207	AC Conducted Emissions 150kHz - 30MHz	< FCC 15.207 limits	Line Conducted	Pass	Section 7.8

#### Notes:

- 1) Determining compliance is based on the test results met the regulation limits or requirements declared by clients, and the test results don't take into account the value of measurement uncertainty.
- 2) For radiated emission test, every axis (X, Y, Z) was also verified when applicable. The test results shown in the following sections represent the worst case emissions.
- 3) The analyzer plots shown in this section were all taken with a correction table loaded into the analyzer. The correction table was used to account for the losses of the cables and attenuators used as part of the system to connect the EUT to the analyzer at all frequencies of interest.

## 7.2. 6dB Bandwidth Measurement

### 7.2.1. Test Limit

The minimum 6dB bandwidth shall be at least 500 kHz.

### 7.2.2. Test Procedure used

ANSI C63.10 - 2013 - Section 11.8

### 7.2.3. Test Setting

1. The Spectrum's automatic bandwidth measurement capability was used to perform the 6dB bandwidth measurement. The "X" dB bandwidth parameter was set to  $X = 6$ . The bandwidth measurement was not influenced by any intermediate power nulls in the fundamental emission.
2. Set RBW = 100 kHz
3.  $VBW \geq 3 \times RBW$
4. Detector = Peak
5. Trace mode = max hold
6. Sweep = auto couple
7. Allow the trace was allowed to stabilize

### 7.2.4. Test Setup

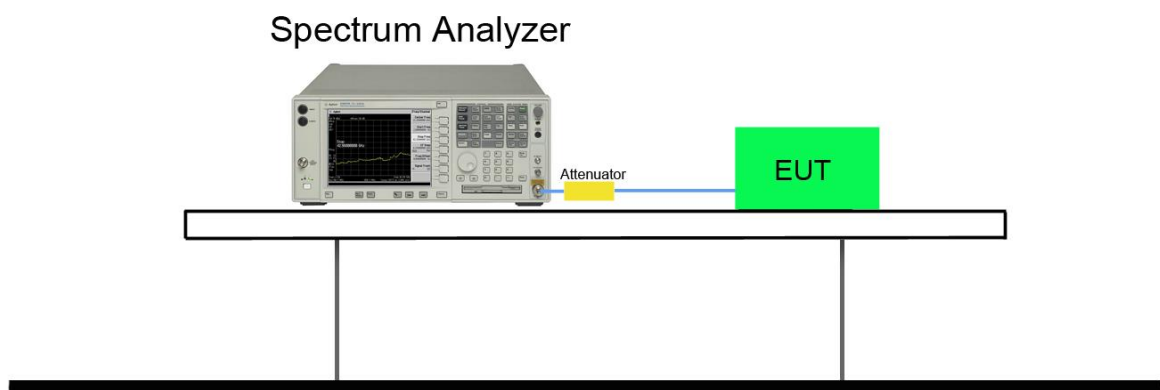

### 7.2.5. Test Result

Test Mode	Channel No.	Frequency (MHz)	6dB Bandwidth (MHz)	99% Bandwidth (MHz)	Limit (MHz)	Result
LE 1Mbps	00	2402	0.6708	1.0442	$\geq 0.5$	Pass
	19	2440	0.6701	1.0471	$\geq 0.5$	Pass
	39	2480	0.6641	1.0412	$\geq 0.5$	Pass
LE 2Mbps	00	2402	1.1840	2.0425	$\geq 0.5$	Pass
	19	2440	1.2330	2.0517	$\geq 0.5$	Pass
	39	2480	1.1800	2.0408	$\geq 0.5$	Pass
LE Coded S=2	00	2402	0.6713	1.0457	$\geq 0.5$	Pass
	19	2440	0.6693	1.0483	$\geq 0.5$	Pass
	39	2480	0.6676	1.0503	$\geq 0.5$	Pass
LE Coded S=8	00	2402	0.6855	1.0510	$\geq 0.5$	Pass
	19	2440	0.6851	1.0513	$\geq 0.5$	Pass
	39	2480	0.6900	1.0523	$\geq 0.5$	Pass

LE 1Mbps

LE CH00 (2402MHz)



LE CH19 (2440MHz)

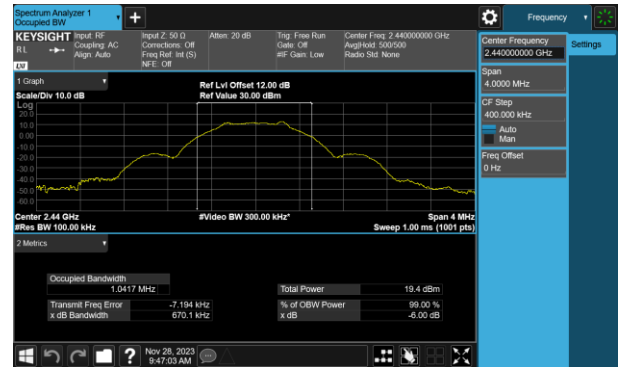

LE CH39 (2480MHz)

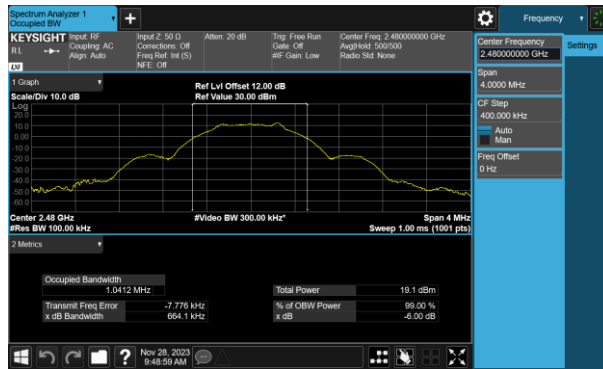

### LE 2Mbps

#### LE CH00 (2402MHz)

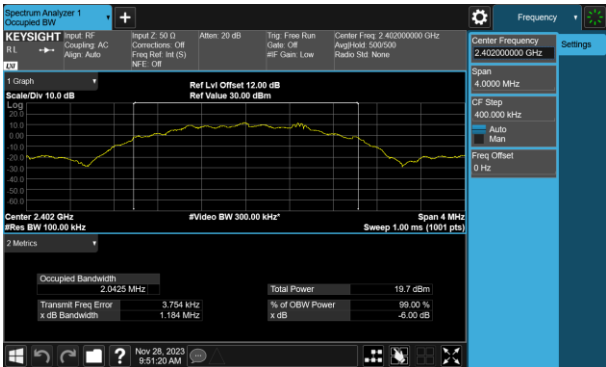

#### LE CH19 (2440MHz)

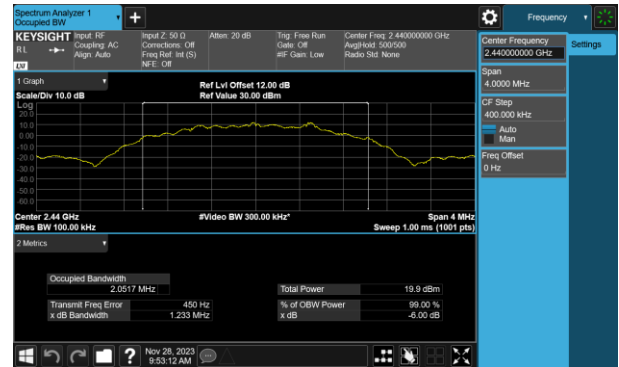

#### LE CH39 (2480MHz)

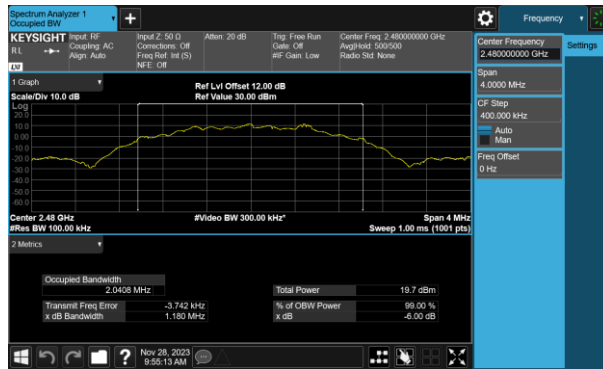

LE Coded S=2

LE CH00 (2402MHz)



LE CH19 (2440MHz)



LE CH39 (2480MHz)



LE Coded S=8

LE CH00 (2402MHz)



LE CH19 (2440MHz)



LE CH39 (2480MHz)

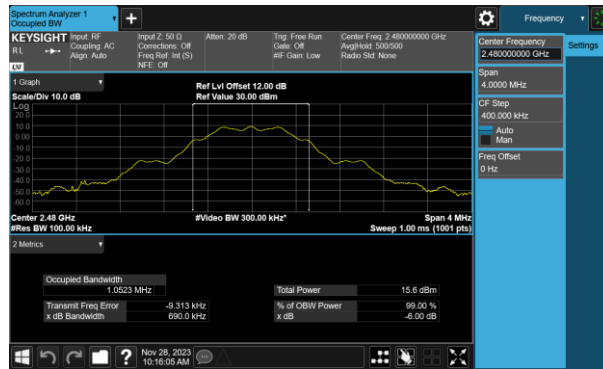

## 7.3. Output Power Measurement

### 7.3.1. Test Limit

The maximum out power shall be less 1 Watt (30dBm).

### 7.3.2. Test Procedure Used

ANSI C63.10 - 2013 - Section 11.9.1.3

ANSI C63.10 - 2013 - Section 11.9.2.3.2

### 7.3.3. Test Setting

#### Peak Power Measurement

The maximum peak conducted output power may be measured using a broadband peak RF power meter. The power meter shall have a video bandwidth that is greater than or equal to the DTS bandwidth and shall utilize a fast-responding diode detector.

#### Average Power Measurement

Average power measurements were performed only when the EUT was transmitting at its maximum power control level using a broadband power meter with a pulse sensor. The power meter implemented triggering and gating capabilities which were set up such that power measurements were recorded only during the ON time of the transmitter. The trace was averaged over 100 traces to obtain the final measured average power.

### 7.3.4. Test Setup

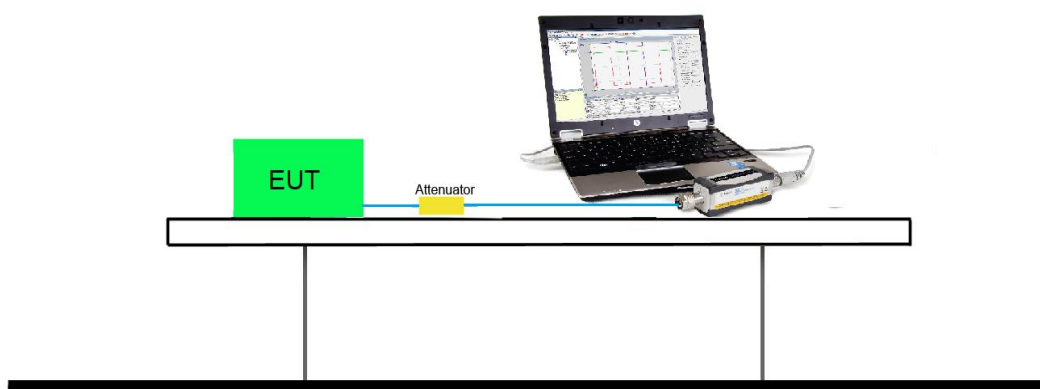



### 7.3.5. Test Result of Output Power

Test Mode	Channel No.	Frequency (MHz)	Average Power (dBm)	Peak Power (dBm)	Power Limit (dBm)
LE 1Mbps	00	2402	13.35	13.94	≤ 30
	19	2440	13.53	13.98	≤ 30
	39	2480	13.13	13.61	≤ 30
LE 2Mbps	00	2402	13.15	13.71	≤ 30
	19	2440	13.30	13.77	≤ 30
	39	2480	13.00	13.31	≤ 30
LE Coded S=2	00	2402	13.28	13.54	≤ 30
	19	2440	13.39	13.89	≤ 30
	39	2480	13.04	13.43	≤ 30
LE Coded S=8	00	2402	13.25	13.75	≤ 30
	19	2440	13.45	13.81	≤ 30
	39	2480	13.05	13.40	≤ 30

Note1: Output power = Reading value on power meter + cable loss.

Note2: Antenna Gain: 1.00dBi.

## **7.4. Power Spectral Density Measurement**

### **7.4.1. Test Limit**

The maximum permissible power spectral density is 8dBm in any 3 kHz band.

### **7.4.2. Test Procedure Used**

ANSI C63.10 - 2013 Section 11.10.5

### **7.4.3. Test Setting**

1. Measure the duty cycle (x) of the transmitter output signal.
2. Set instrument center frequency to DTS channel center frequency.
3. Set span to at least 1.5 times the OBW.
4. RBW = 10 kHz.
5. VBW = 30 kHz.
6. Detector = RMS.
7. Ensure that the number of measurement points in the sweep  $\geq 2 \times \text{span}/\text{RBW}$ .
8. Sweep time = auto couple.
9. Don't use sweep triggering. Allow sweep to "free run".
10. Employ trace averaging (RMS) mode over a minimum of 100 traces.
11. Use the peak marker function to determine the maximum amplitude level.
12. Add  $10 \log (1/x)$ , where x is the duty cycle measured in step (a), to the measured PSD to compute the average PSD during the actual transmission time.

#### 7.4.4. Test Setup

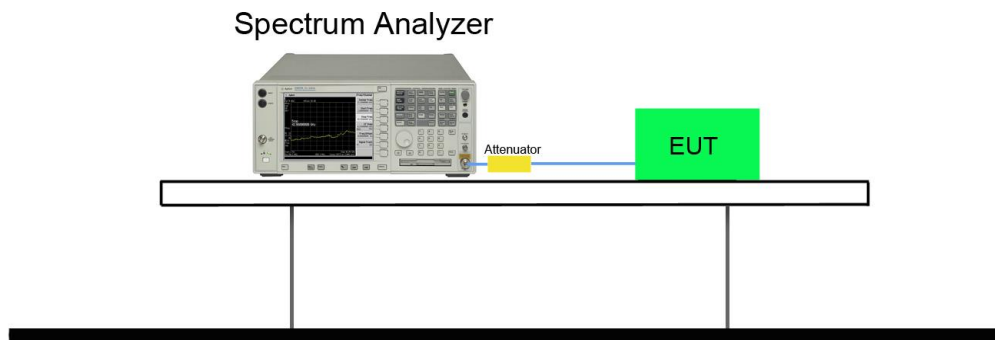

### 7.4.5. Test Result

Test Mode	Channel No.	Frequency (MHz)	PSD (dBm/10kHz)	Duty Cycle (%)	Total Average PSD (dBm/10kHz)	Limit (dBm/3KHz)	Result
LE 1Mbps	00	2402	-4.363	85.43%	-3.679	≤ 8	Pass
	19	2440	-4.171	85.43%	-3.487	≤ 8	Pass
	39	2480	-4.495	85.43%	-3.811	≤ 8	Pass
LE 2Mbps	00	2402	-7.872	57.52%	-5.470	≤ 8	Pass
	19	2440	-7.632	57.52%	-5.230	≤ 8	Pass
	39	2480	-8.875	57.52%	-6.473	≤ 8	Pass
LE Coded S=2	00	2402	-3.554	91.39%	-3.163	≤ 8	Pass
	19	2440	-3.281	91.39%	-2.890	≤ 8	Pass
	39	2480	-2.352	91.39%	-1.961	≤ 8	Pass
LE Coded S=8	00	2402	6.298	97.54%	6.406	≤ 8	Pass
	19	2440	6.599	97.54%	6.707	≤ 8	Pass
	39	2480	6.118	97.54%	6.226	≤ 8	Pass

Note: Total Average PSD= Average PSD + 10\*log (1/Duty Cycle (%))

LE 1Mbps

LE CH00 (2402MHz)

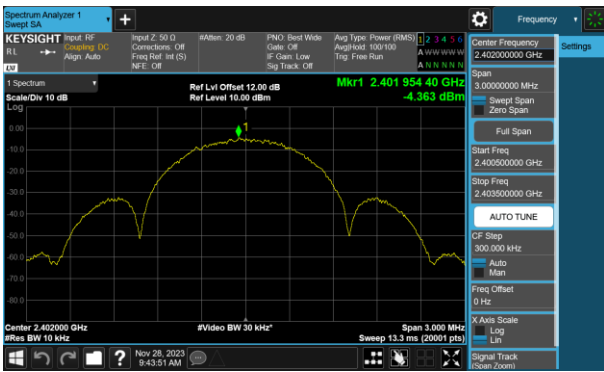

LE CH19 (2440MHz)

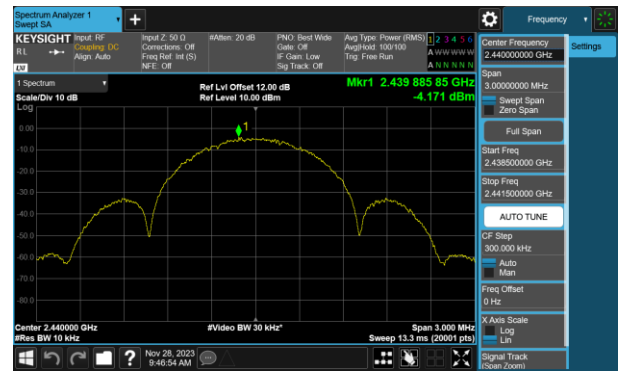

LE CH39 (2480MHz)

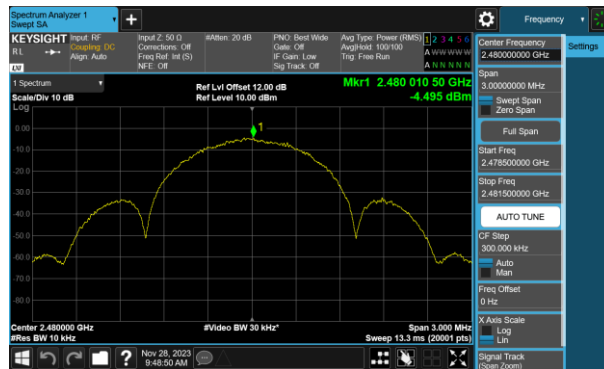

### LE 2Mbps

#### LE CH00 (2402MHz)

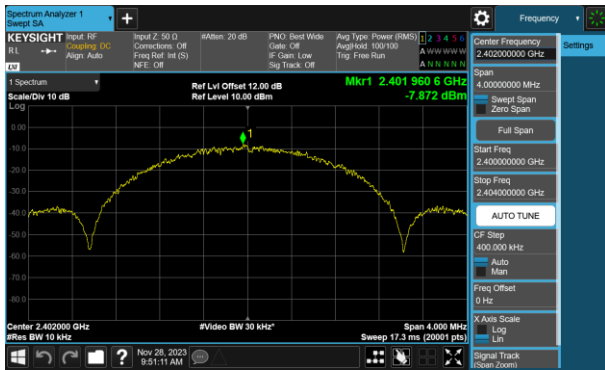

#### LE CH19 (2440MHz)

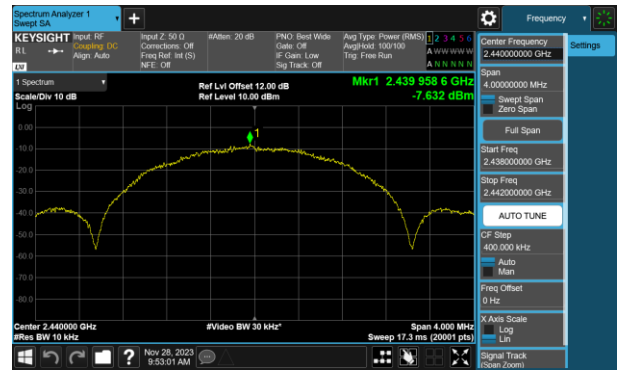

#### LE CH39 (2480MHz)

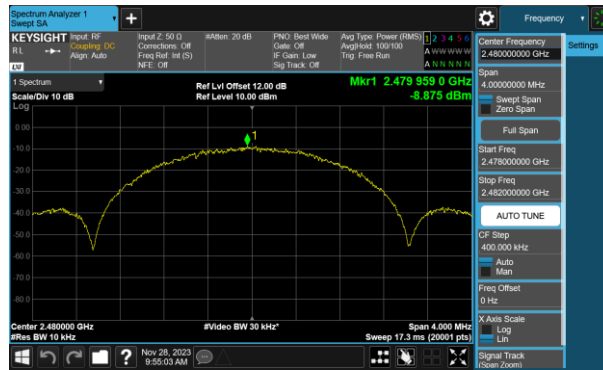

LE Coded S=2

LE CH00 (2402MHz)

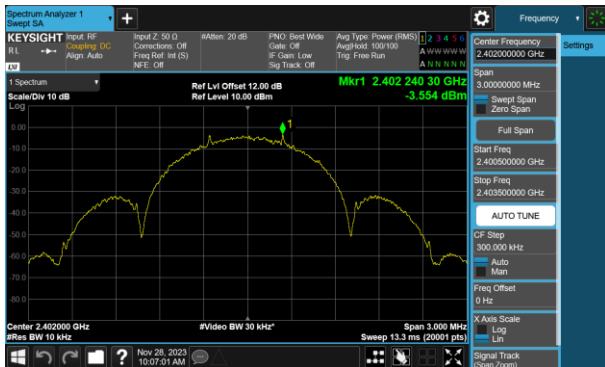

LE CH19 (2440MHz)

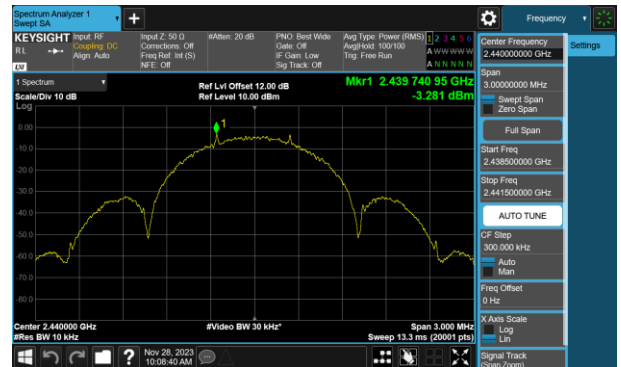

LE CH39 (2480MHz)

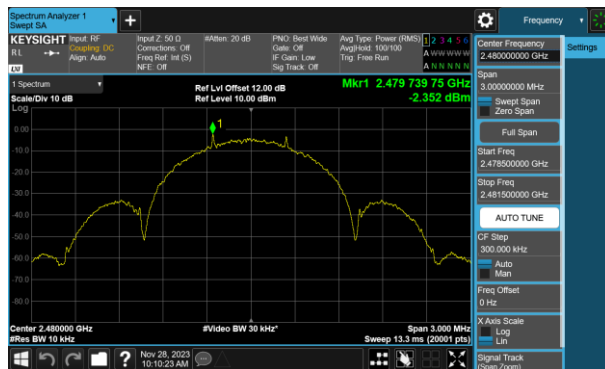

LE Coded S=8

LE CH00 (2402MHz)

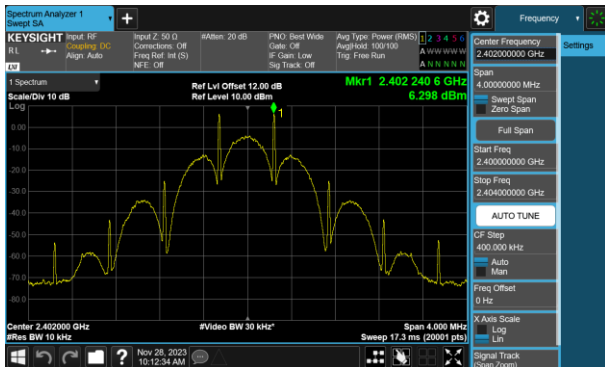

LE CH19 (2440MHz)

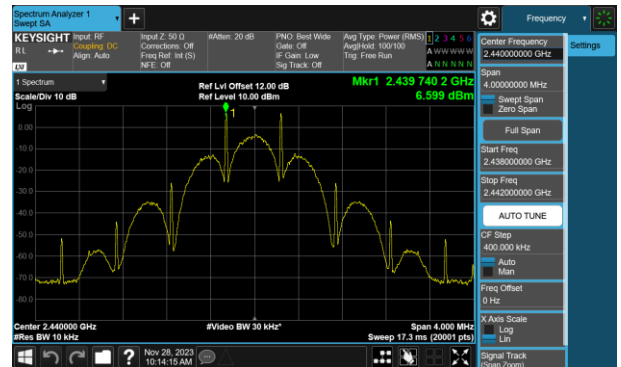

LE CH39 (2480MHz)

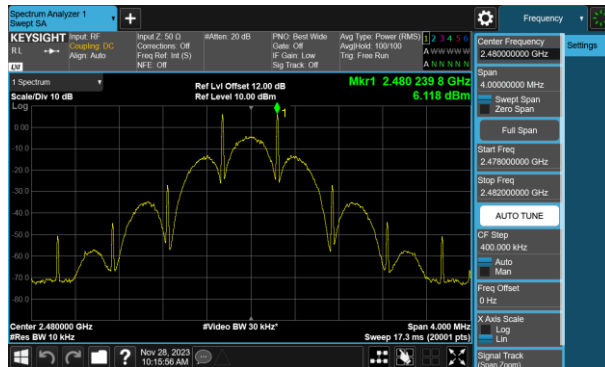



## 7.5. Out-of-Band Spurious Emissions Emissions Measurement

### 7.5.1. Test Limit

In any 100 kHz bandwidth outside the frequency band in which the spread spectrum or digitally modulated intentional radiator is operating, the radio frequency power that is produced by the intentional radiator shall be at least 20 dB below that in the 100 kHz bandwidth within the band that contains the highest level of the desired power, based on RF conducted measurement, provided the transmitter demonstrates compliance with the peak conducted power limits.

### 7.5.2. Test Procedure Used

ANSI C63.10 - 2013 Section 11.11

### 7.5.3. Test Setting

#### Reference level measurement

1. Set instrument center frequency to DTS channel center frequency
2. Set the span to  $\geq 1.5$  times the DTS bandwidth
3. Set the RBW = 100 kHz
4. Set the VBW  $\geq 3 \times$  RBW
5. Detector = peak
6. Sweep time = auto couple
7. Trace mode = max hold
8. Allow trace to fully stabilize

#### Emission level measurement

1. Set the center frequency and span to encompass frequency range to be measured
2. RBW = 100kHz
3. VBW = 300kHz
4. Detector = Peak
5. Trace mode = max hold

- 6. Sweep time = auto couple
- 7. The trace was allowed to stabilize

#### 7.5.4. Test Setup

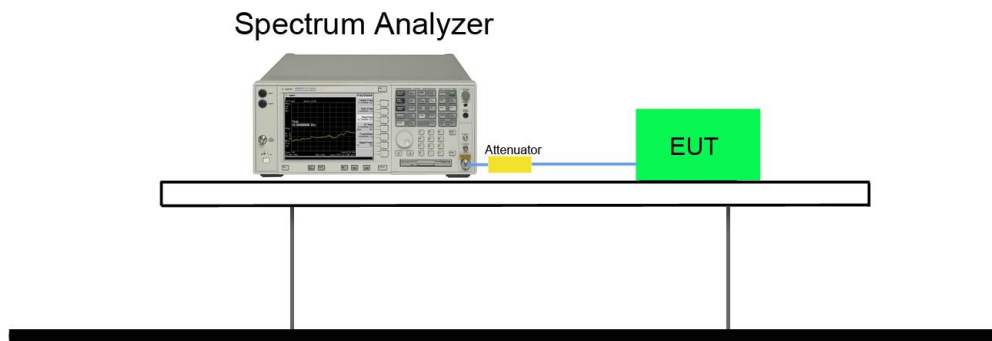

### 7.5.5. Test Result

Test Mode	Channel No.	Frequency (MHz)	Limit	Result
LE 1Mbps	00	2402	30dBc	Pass
	19	2440	30dBc	Pass
	39	2480	30dBc	Pass
LE 2Mbps	00	2402	30dBc	Pass
	19	2440	30dBc	Pass
	39	2480	30dBc	Pass
LE Coded S=2	00	2402	30dBc	Pass
	19	2440	30dBc	Pass
	39	2480	30dBc	Pass
LE Coded S=8	00	2402	30dBc	Pass
	19	2440	30dBc	Pass
	39	2480	30dBc	Pass

### LE 1Mbps

#### CH00 (2402MHz) LE(1Mbps)

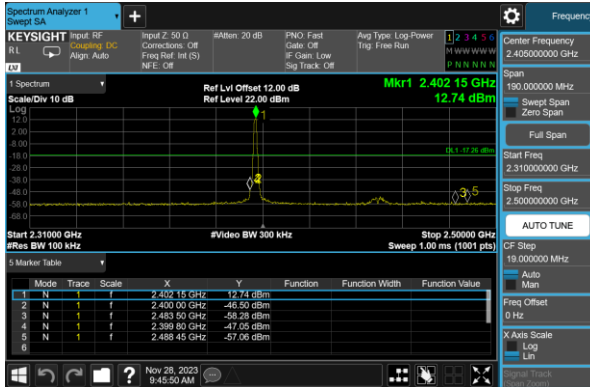

#### CH00 (2402MHz) LE(1Mbps)

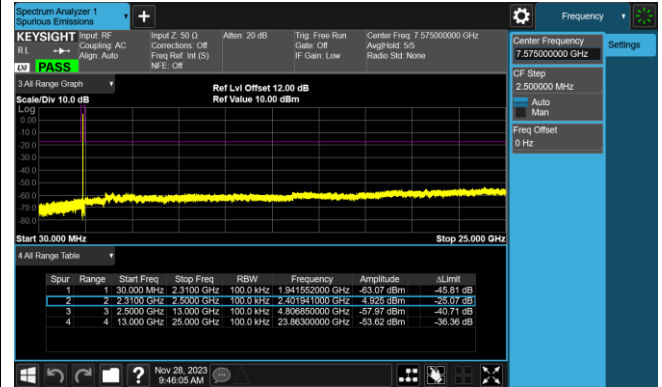

#### CH19 (2440MHz) LE(1Mbps)

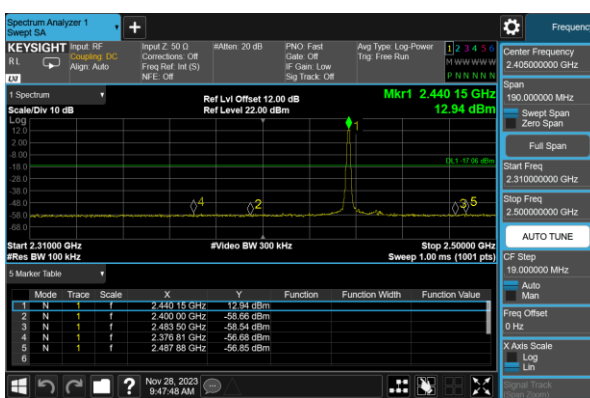

#### CH19 (2440MHz) LE(1Mbps)

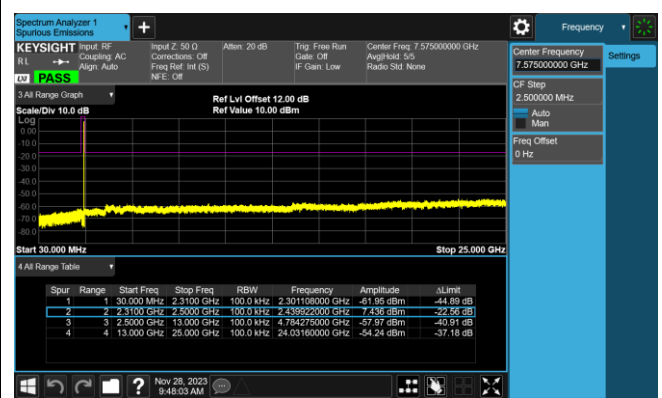

#### CH39 (2480MHz) LE(1Mbps)

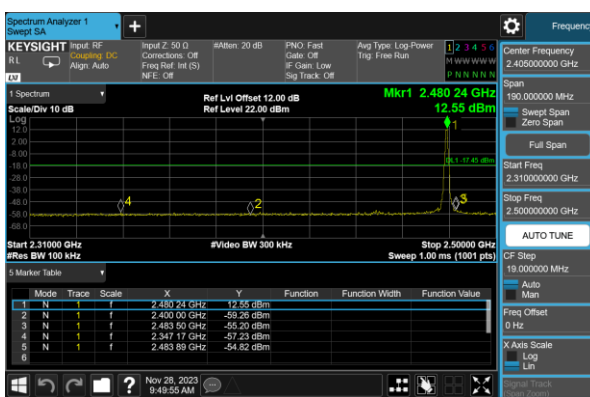

#### CH39 (2480MHz) LE(1Mbps)

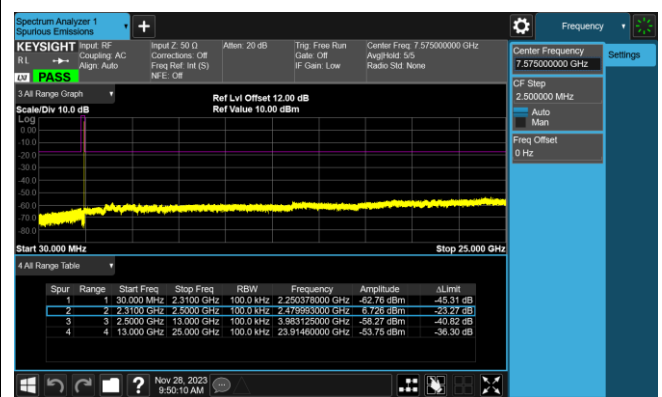

### LE 2Mbps

#### CH00 (2402MHz) LE(1Mbps)

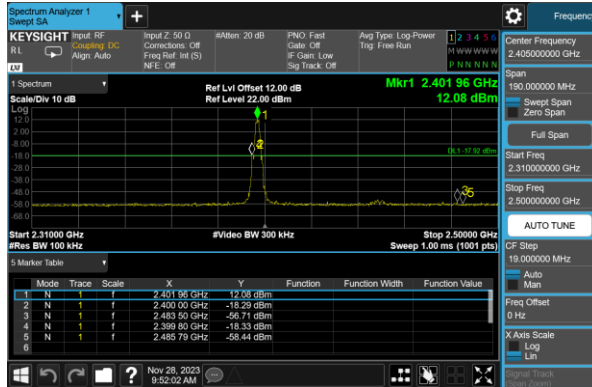

#### CH00 (2402MHz) LE(1Mbps)

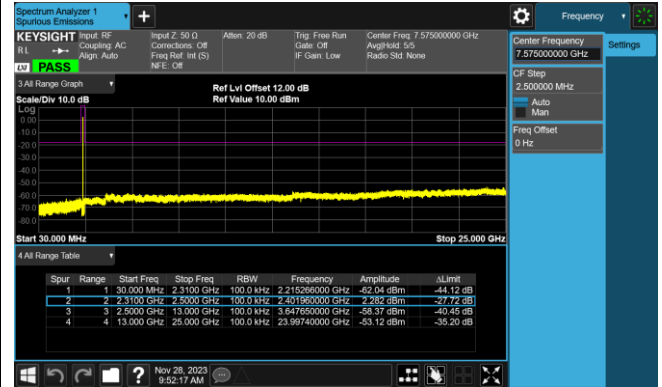

#### CH19 (2440MHz) LE(1Mbps)

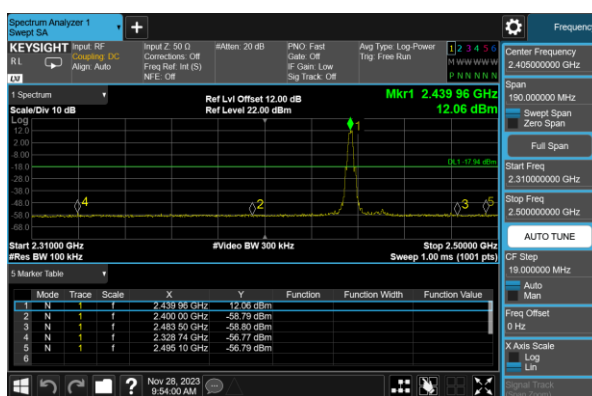

#### CH19 (2440MHz) LE(1Mbps)

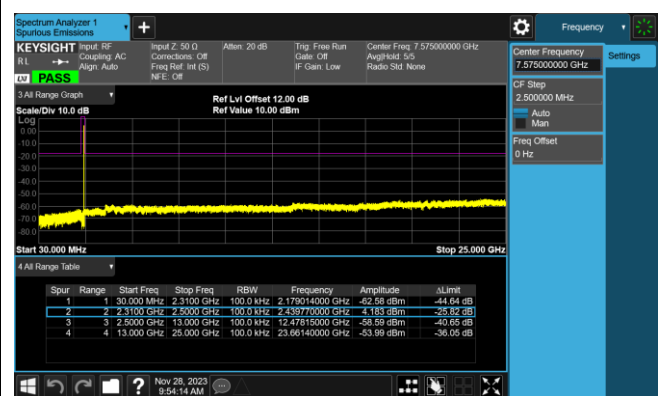

#### CH39 (2480MHz) LE(1Mbps)

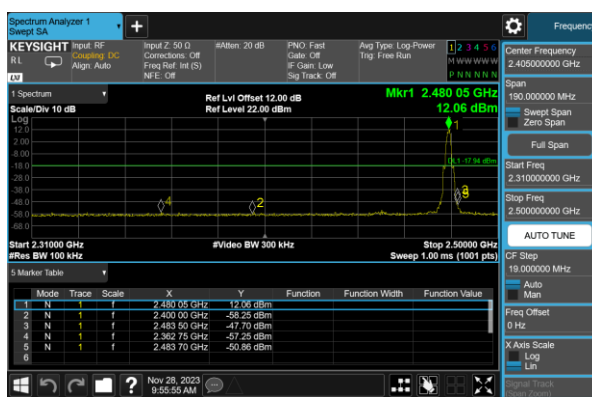

#### CH39 (2480MHz) LE(1Mbps)

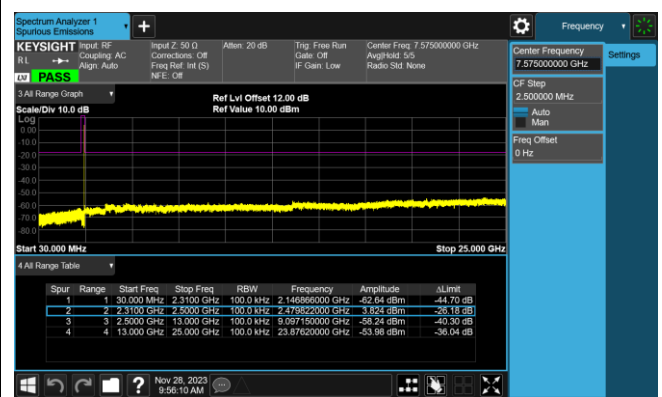

## LE Coded S=2

## CH00 (2402MHz) LE(1Mbps)

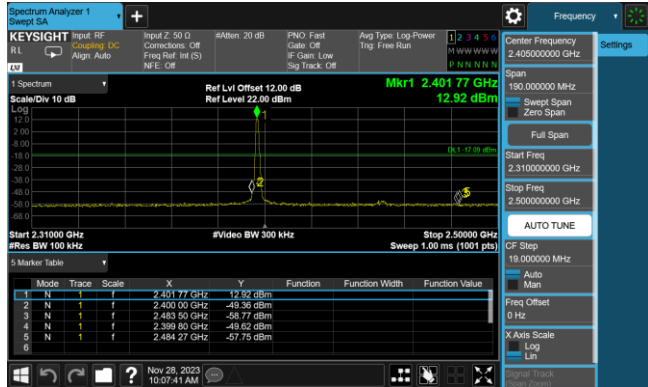

## CH00 (2402MHz) LE(1Mbps)

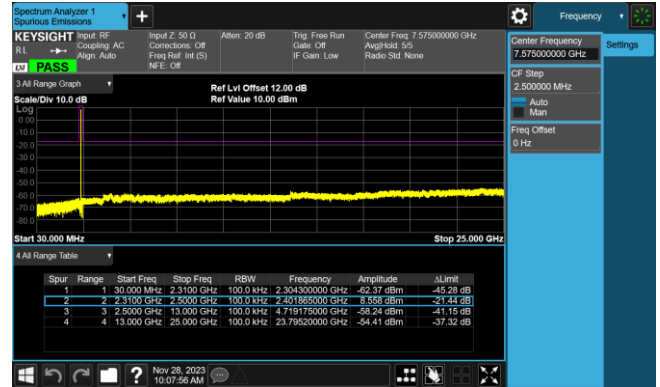

## CH19 (2440MHz) LE(1Mbps)



## CH19 (2440MHz) LE(1Mbps)

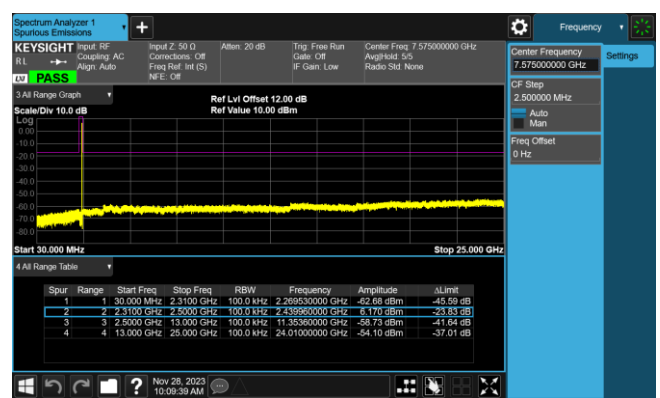

## CH39 (2480MHz) LE(1Mbps)

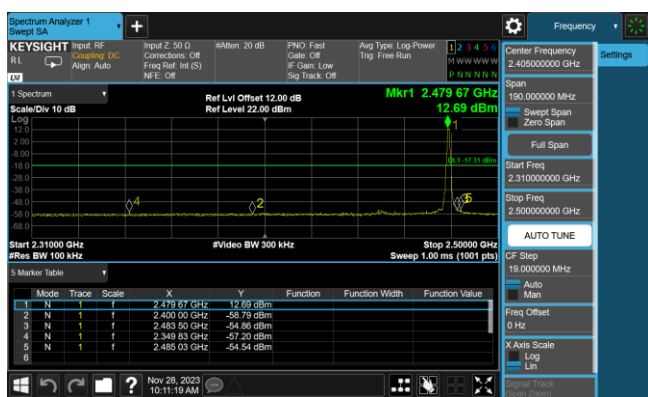

## CH39 (2480MHz) LE(1Mbps)

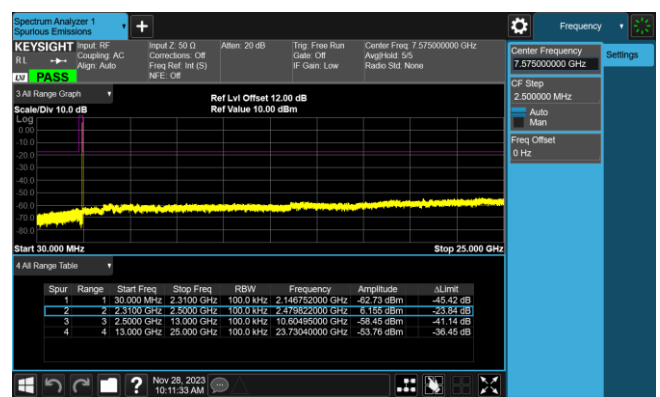

LE Coded S=8

CH00 (2402MHz) LE(1Mbps)

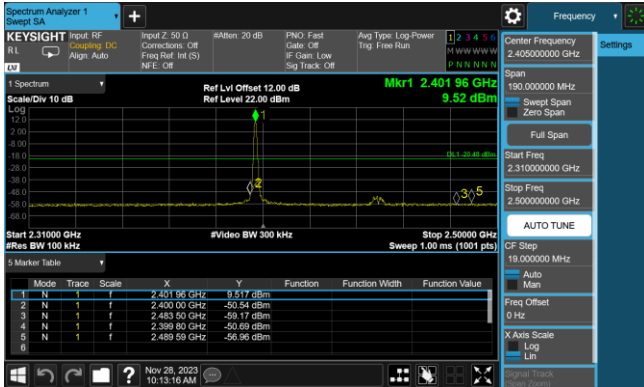

CH00 (2402MHz) LE(1Mbps)

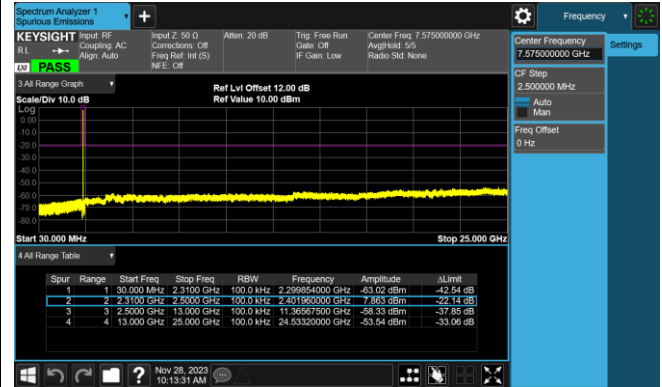

CH19 (2440MHz) LE(1Mbps)

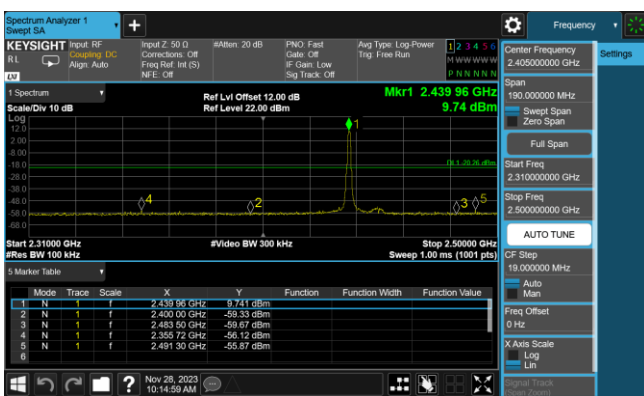

CH19 (2440MHz) LE(1Mbps)

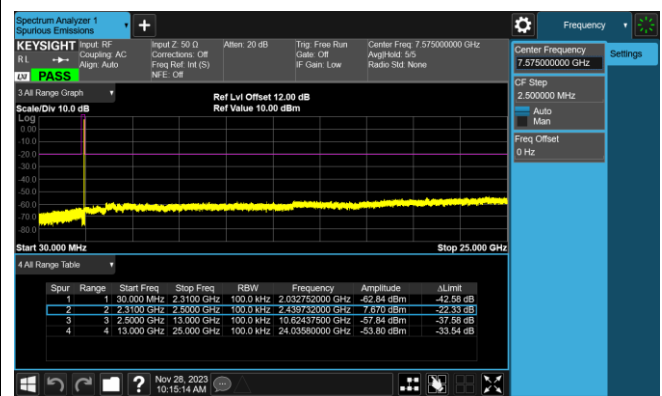

CH39 (2480MHz) LE(1Mbps)

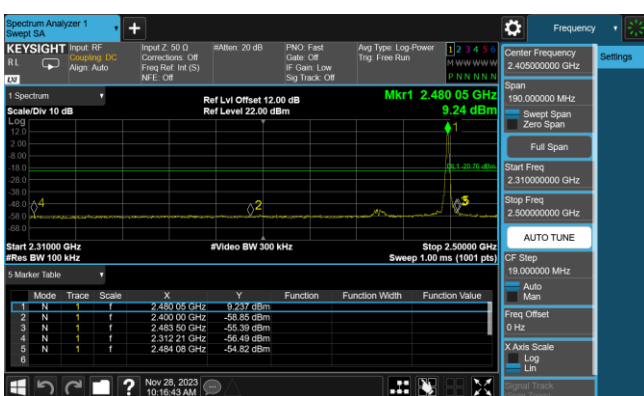

CH39 (2480MHz) LE(1Mbps)

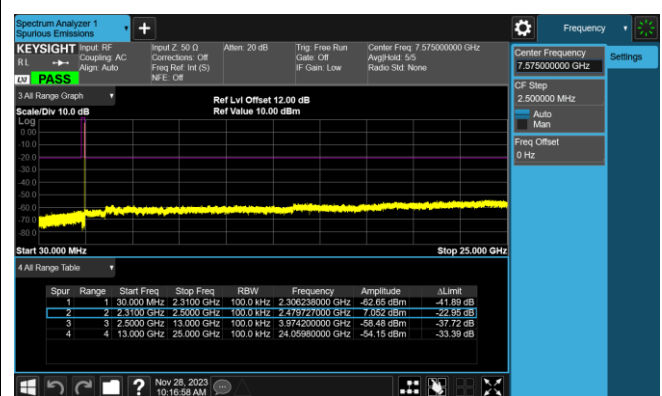

## 7.6. Radiated Spurious Emission Measurement

### 7.6.1. Test Limit

All out of band emissions appearing in a restricted band as specified in Section 15.205 of the Title 47 CFR must not exceed the limits shown in Table per Section 15.209.

FCC Part 15 Subpart C Paragraph 15.209		
Frequency [MHz]	Field Strength [V/m]	Measured Distance [Meters]
0.009 - 0.490	2400/F (kHz)	300
0.490 - 1.705	24000/F (kHz)	30
1.705 - 30	30	30
30 - 88	100	3
88 - 216	150	3
216 - 960	200	3
Above 960	500	3

### 7.6.2. Test Procedure Used

ANSI C63.10 - 2013 Section 6.3 (General Requirements)

ANSI C63.10 - 2013 Section 6.4 (Standard test method below 30MHz)

ANSI C63.10 - 2013 Section 6.5 (Standard test method above 30MHz to 1GHz)

ANSI C63.10 - 2013 Section 6.6 (Standard test method above 1GHz)

### 7.6.3. Test Setting

#### Peak Field Strength Measurements

1. Analyzer center frequency was set to the frequency of the radiated spurious emission of interest
2. RBW = as specified in Table 1
3. VBW = 3MHz
4. Detector = peak



5. Sweep time = auto couple
6. Trace mode = max hold
7. Trace was allowed to stabilize

**Table 1 - RBW as a function of frequency**

Frequency	RBW
9 ~ 150 kHz	200 ~ 300 Hz
0.15 ~ 30 MHz	9 ~ 10 kHz
30 ~ 1000 MHz	100 ~ 120 kHz
> 1000 MHz	1 MHz

#### **Average Field Strength Measurements**

1. Analyzer center frequency was set to the frequency of the radiated spurious emission of interest
2. RBW = 1MHz
3. VBW  $\geq$  1/T
4. De As an alternative, the instrument may be set to linear detector mode. Ensure that video filtering is applied in linear voltage domain (rather than in a log or dB domain). Some instruments require linear display mode in order to accomplish this. Others have a setting for Average-VBW Type, which can be set to "Voltage" regardless of the display mode
5. Detector = Peak
6. Sweep time = auto
7. Trace mode = max hold
8. Allow max hold to run for at least 50 times (1/duty cycle) traces

#### 7.6.4. Test Setup

##### 9kHz ~ 30MHz Test Setup:

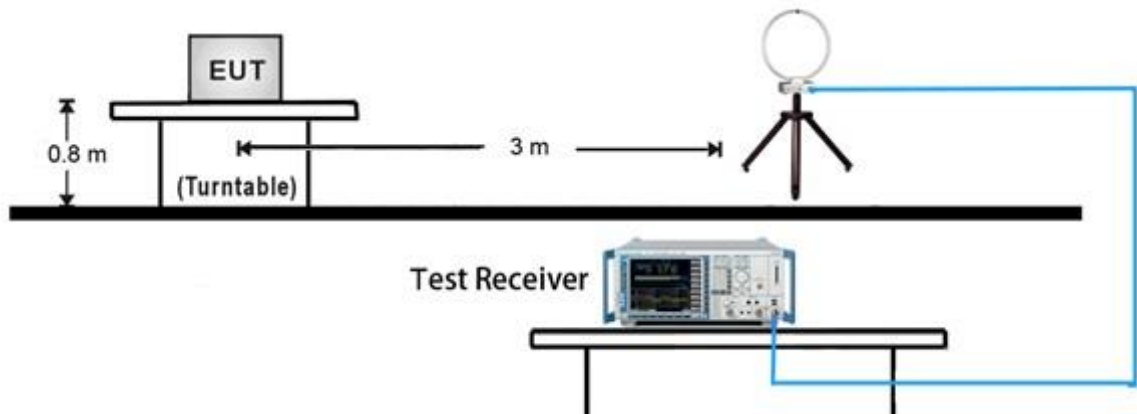

##### 30MHz ~ 1GHz Test Setup:

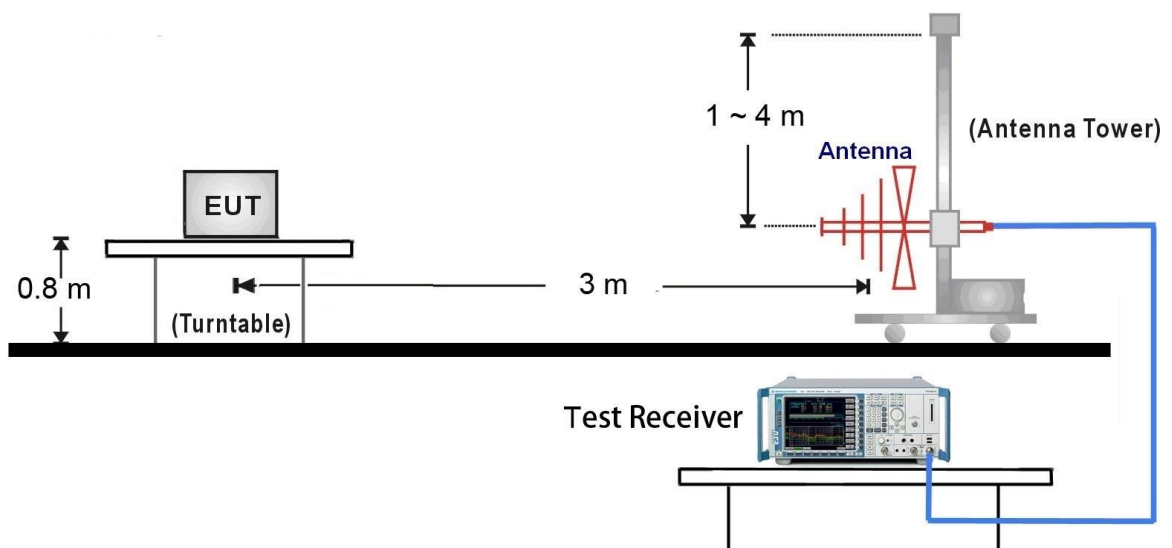

1GHz ~ 25GHz Test Setup:

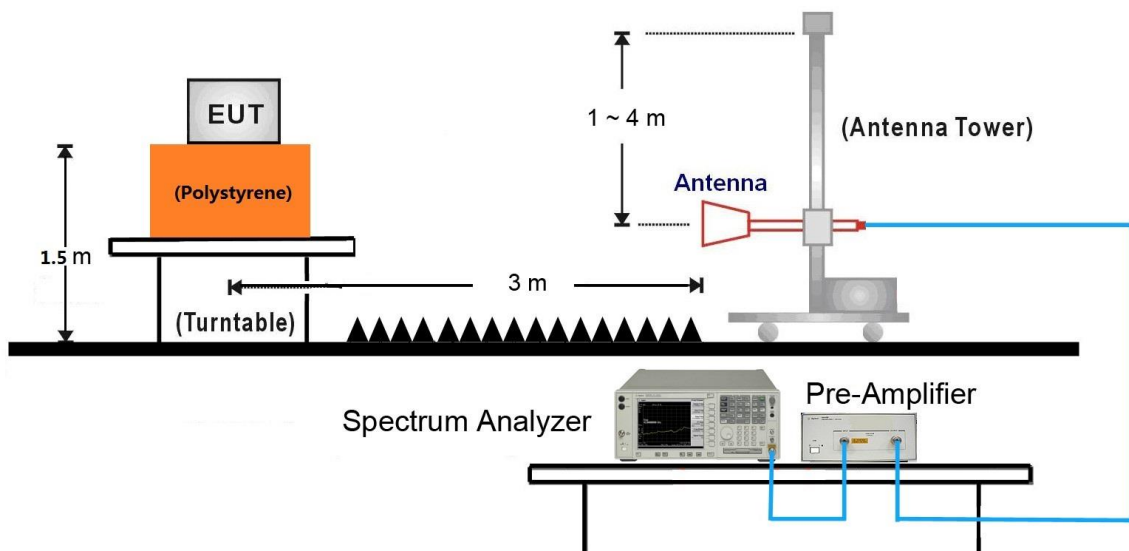

### 7.6.5. Test Result

EUT	BE9300 Wi-Fi 7 Bluetooth PCIe Adapter	Date of Test	2023-11-22
Factor	VULB 9162	Temp. / Humidity	23°C /63%
Polarity	Horizontal	Site / Test Engineer	AC2 / Stanley
Test Mode	BLE_1Mbps_TX_CH 19	Test Voltage	AC 120V/60Hz

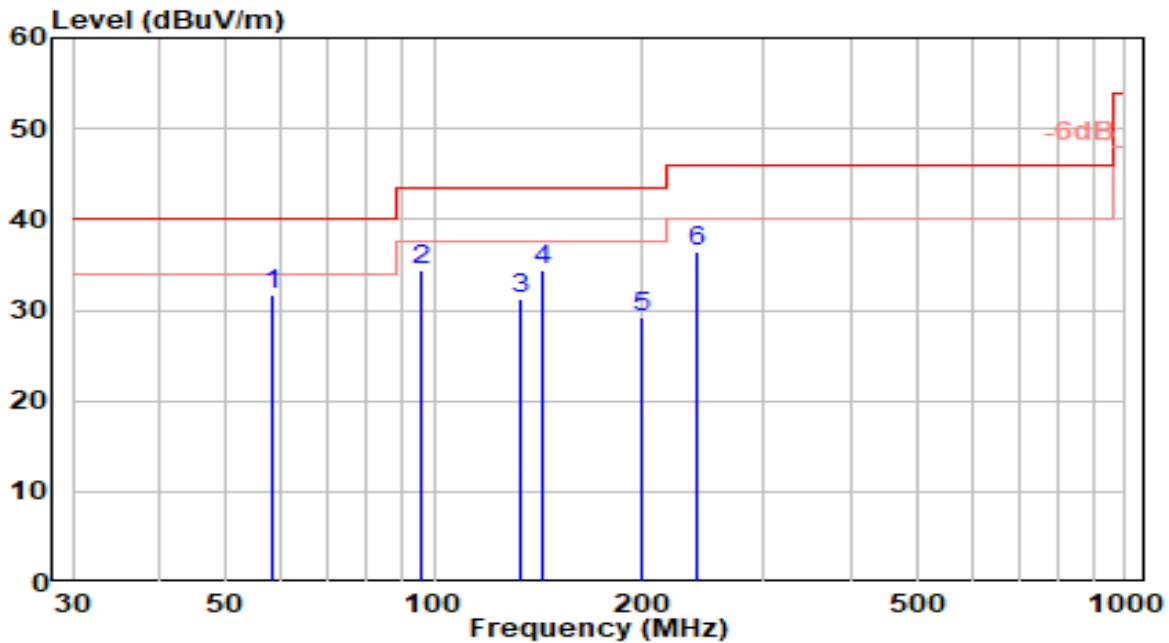

No	Frequency (MHz)	Reading (dBuV)	C.F (dB/m)	Measurement (dBuV/m)	Margin (dB)	Limit (dBuV/m)	Height (cm)	Angle (deg)	Remark (QP/PK/AV)
1	* 58.130	12.32	19.40	31.72	-8.28	40.00	200	261	QP
2	95.960	16.60	17.72	34.32	-9.18	43.50	200	308	QP
3	132.820	16.08	15.23	31.31	-12.19	43.50	200	227	QP
4	143.490	19.63	14.74	34.37	-9.13	43.50	200	224	QP
5	199.750	11.25	17.98	29.23	-14.27	43.50	200	79	QP
6	239.520	17.09	19.43	36.52	-9.48	46.00	200	199	QP

Note:

- "\*" means this data is the worst emission level.
- C.F (Correction Factor) = Antenna Factor (dB/m) + Cable Loss (dB).
- Measurement (dBuV/m) = Reading(dBuV) + C.F (Correction Factor).
- The emission levels of other frequencies are very lower than the limit and not show in test report.
- The amplitude of radiated emissions (frequency range from 9kHz to 30MHz) is that proximity to ambient noise, which also are attenuated more than 20dB below the permissible value. Therefore, the data is not presented in the report.

EUT	BE9300 Wi-Fi 7 Bluetooth PCIe Adapter	Date of Test	2023-11-22
Factor	VULB 9162	Temp. / Humidity	23°C /63%
Polarity	Vertical	Site / Test Engineer	AC2 / Stanley
Test Mode	BLE_1Mbps_TX_CH 19	Test Voltage	AC 120V/60Hz

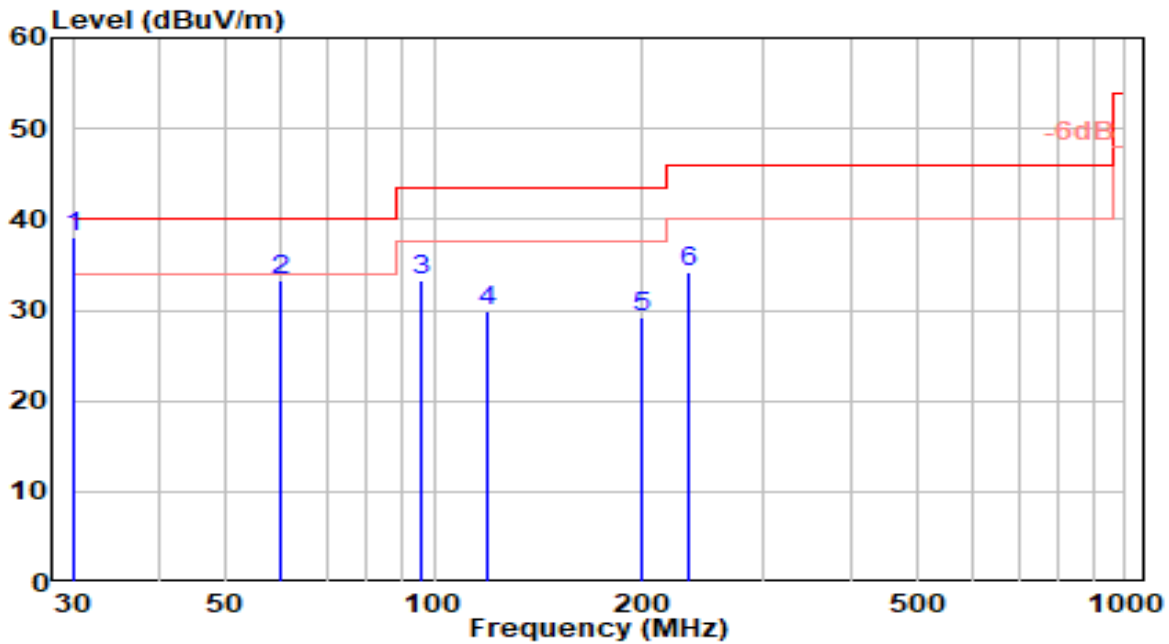

No	Frequency (MHz)	Reading (dBuV)	C.F (dB/m)	Measurement (dBuV/m)	Margin (dB)	Limit (dBuV/m)	Height (cm)	Angle (deg)	Remark (QP/PK/AV)
1	* 30.000	21.60	16.48	38.08	-1.92	40.00	100	0	QP
2	60.070	14.23	19.08	33.30	-6.70	40.00	100	202	QP
3	95.960	15.55	17.72	33.27	-10.23	43.50	100	0	QP
4	119.240	13.23	16.73	29.96	-13.54	43.50	100	294	QP
5	199.750	11.31	17.98	29.28	-14.22	43.50	100	310	QP
6	232.730	15.21	19.08	34.28	-11.72	46.00	100	182	QP

Note:

- "\*" means this data is the worst emission level.
- C.F (Correction Factor) = Antenna Factor (dB/m) + Cable Loss (dB).
- Measurement (dBuV/m) = Reading(dBuV) + C.F (Correction Factor).
- The emission levels of other frequencies are very lower than the limit and not show in test report.
- The amplitude of radiated emissions (frequency range from 9kHz to 30MHz) is that proximity to ambient noise, which also are attenuated more than 20dB below the permissible value. Therefore, the data is not presented in the report.

EUT	BE9300 Wi-Fi 7 Bluetooth PCIe Adapter	Date of Test	2023-11-24
Factor	DRH18-E	Temp. / Humidity	23°C /63%
Polarity	Horizontal	Site / Test Engineer	AC2 / Stanley
Test Mode	BLE_1Mbps_TX_CH 0	Test Voltage	AC 120V/60Hz

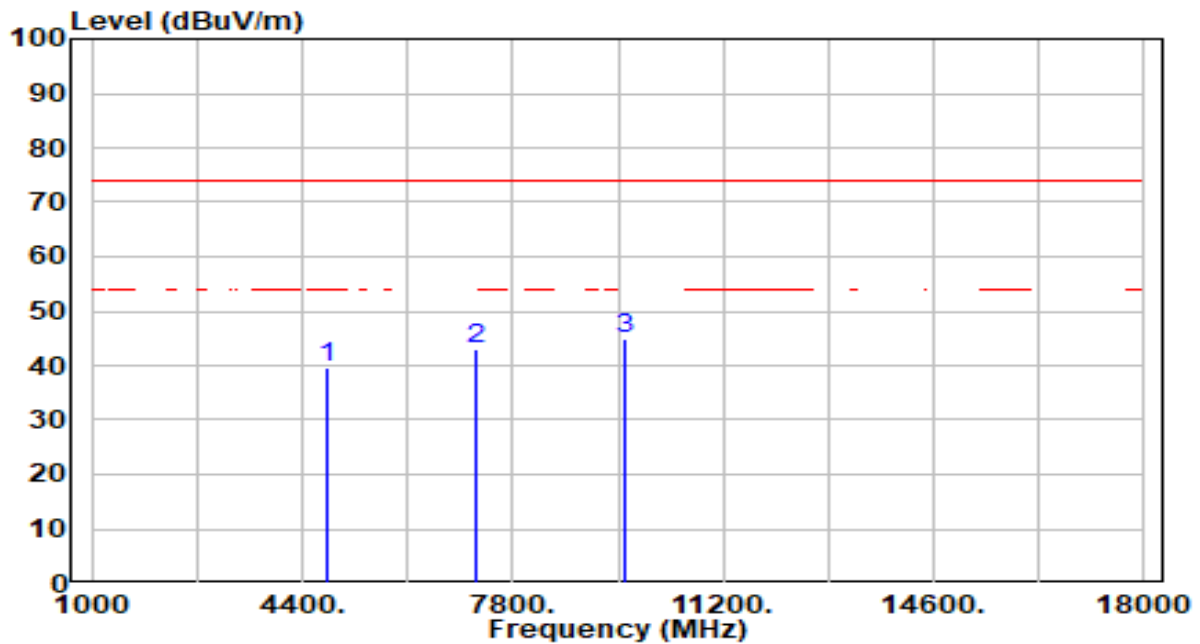

No	Frequency (MHz)	Reading (dBuV)	C.F (dB/m)	Measurement (dBuV/m)	Margin (dB)	Limit (dBuV/m)	Height (cm)	Angle (deg)	Remark (QP/PK/AV)
1	4804.000	40.87	-1.15	39.72	-34.28	74.00	100	60	Peak
2	7206.000	39.15	3.90	43.05	-30.95	74.00	100	335	Peak
3	* 9608.000	41.58	3.20	44.78	-29.22	74.00	100	223	Peak

Note:

- "\*", means this data is the worst emission level.
- C.F (Correction Factor) = Antenna Factor (dB/m) + Cable Loss (dB) – Preamplifier(dB).
- Measurement (dBuV/m) = Reading(dBuV) + C.F (Correction Factor).
- The emission levels of other frequencies are very lower than the limit and not show in test report.

EUT	BE9300 Wi-Fi 7 Bluetooth PCIe Adapter	Date of Test	2023-11-24
Factor	DRH18-E	Temp. / Humidity	23°C /63%
Polarity	Vertical	Site / Test Engineer	AC2 / Stanley
Test Mode	BLE_1Mbps_TX_CH 0	Test Voltage	AC 120V/60Hz

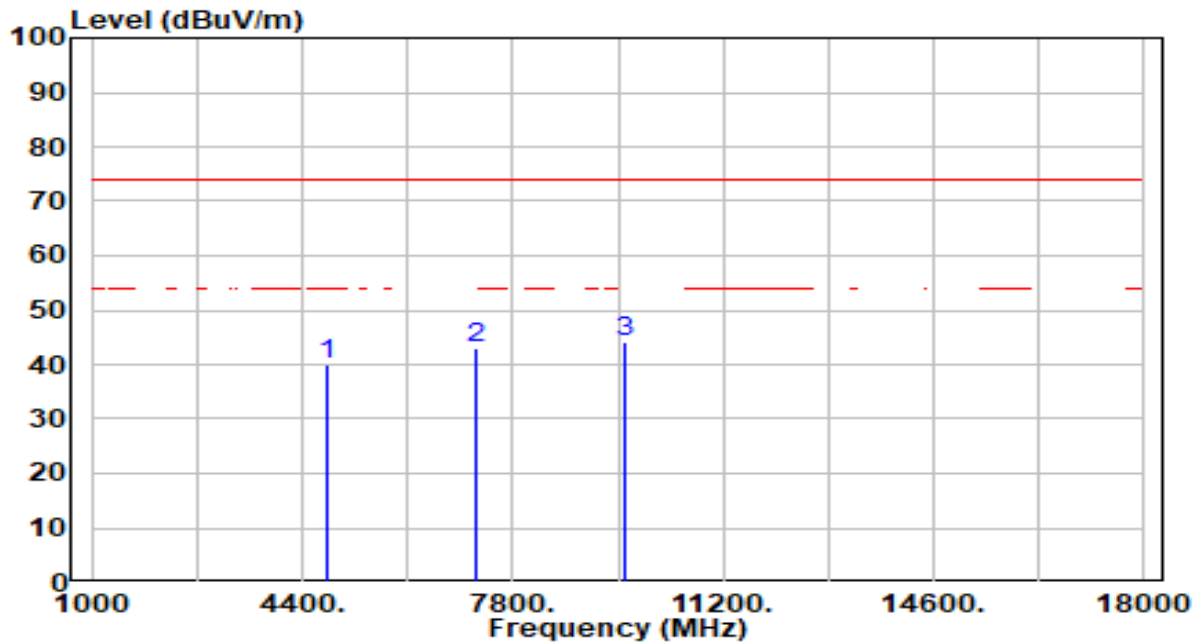

No	Frequency (MHz)	Reading (dBuV)	C.F (dB/m)	Measurement (dBuV/m)	Margin (dB)	Limit (dBuV/m)	Height (cm)	Angle (deg)	Remark (QP/PK/AV)
1	4804.000	41.18	-1.15	40.03	-33.97	74.00	100	323	Peak
2	7206.000	39.08	3.90	42.97	-31.03	74.00	100	213	Peak
3	* 9608.000	41.06	3.20	44.26	-29.74	74.00	100	334	Peak

Note:

1. " \*" , means this data is the worst emission level.
2. C.F (Correction Factor) = Antenna Factor (dB/m) + Cable Loss (dB) – Preamplifier(dB).
3. Measurement (dBuV/m) = Reading(dBuV) + C.F (Correction Factor).
4. The emission levels of other frequencies are very lower than the limit and not show in test report.

EUT	BE9300 Wi-Fi 7 Bluetooth PCIe Adapter	Date of Test	2023-11-24
Factor	DRH18-E	Temp. / Humidity	23°C /63%
Polarity	Horizontal	Site / Test Engineer	AC2 / Stanley
Test Mode	BLE_1Mbps_TX_CH 19	Test Voltage	AC 120V/60Hz

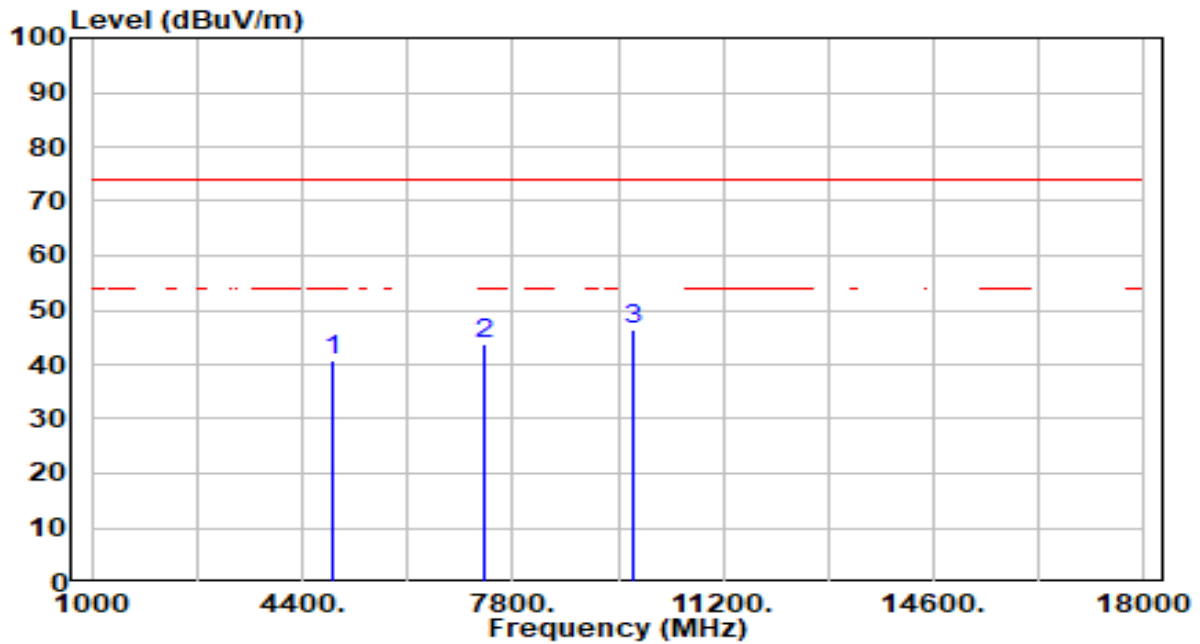

No	Frequency (MHz)	Reading (dBuV)	C.F (dB/m)	Measurement (dBuV/m)	Margin (dB)	Limit (dBuV/m)	Height (cm)	Angle (deg)	Remark (QP/PK/AV)
1	4880.000	41.54	-0.95	40.59	-33.41	74.00	300	176	Peak
2	7320.000	39.68	3.92	43.60	-30.40	74.00	200	99	Peak
3	* 9760.000	43.21	3.25	46.46	-27.54	74.00	200	71	Peak

Note:

1. " \*" , means this data is the worst emission level.
2. C.F (Correction Factor) = Antenna Factor (dB/m) + Cable Loss (dB) – Preamplifier(dB).
3. Measurement (dBuV/m) = Reading(dBuV) + C.F (Correction Factor).
4. The emission levels of other frequencies are very lower than the limit and not show in test report.



EUT	BE9300 Wi-Fi 7 Bluetooth PCIe Adapter	Date of Test	2023-11-24
Factor	DRH18-E	Temp. / Humidity	23°C /63%
Polarity	Vertical	Site / Test Engineer	AC2 / Stanley
Test Mode	BLE_1Mbps_TX_CH 19	Test Voltage	AC 120V/60Hz

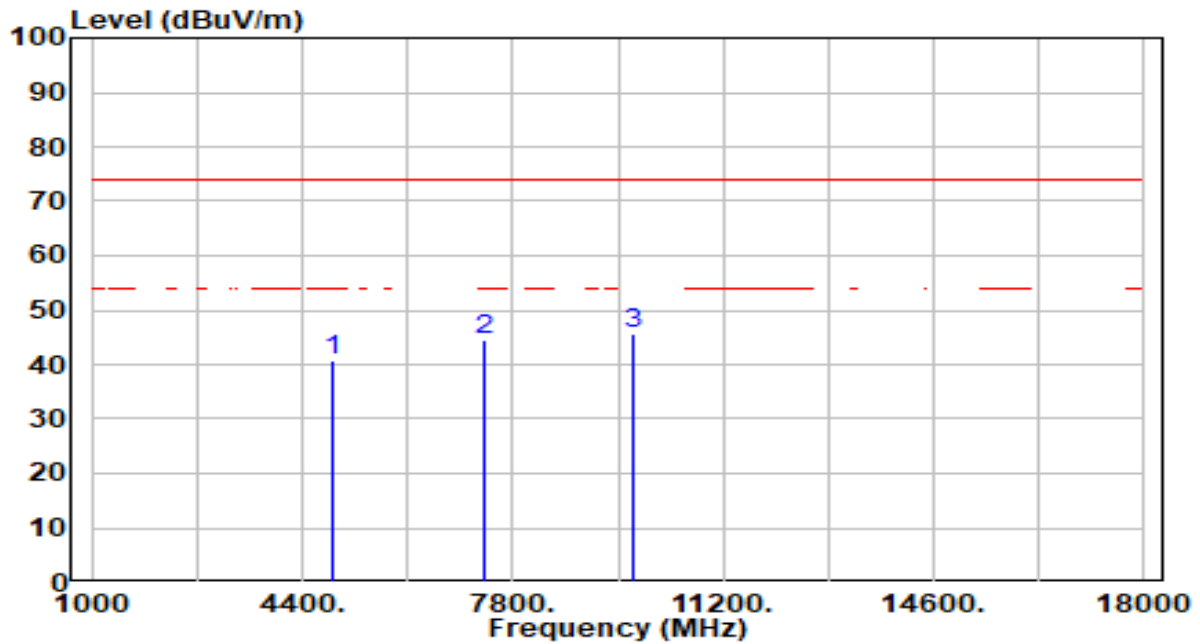

No	Frequency (MHz)	Reading (dBuV)	C.F (dB/m)	Measurement (dBuV/m)	Margin (dB)	Limit (dBuV/m)	Height (cm)	Angle (deg)	Remark (QP/PK/AV)
1	4880.000	41.86	-0.95	40.91	-33.09	74.00	200	209	Peak
2	7320.000	40.77	3.92	44.69	-29.31	74.00	207	0	Peak
3	* 9760.000	42.28	3.25	45.52	-28.48	74.00	300	230	Peak

Note:

1. " \*" , means this data is the worst emission level.
2. C.F (Correction Factor) = Antenna Factor (dB/m) + Cable Loss (dB) – Preamplifier(dB).
3. Measurement (dBuV/m) = Reading(dBuV) + C.F (Correction Factor).
4. The emission levels of other frequencies are very lower than the limit and not show in test report.

EUT	BE9300 Wi-Fi 7 Bluetooth PCIe Adapter	Date of Test	2023-11-24
Factor	DRH18-E	Temp. / Humidity	23°C /63%
Polarity	Horizontal	Site / Test Engineer	AC2 / Stanley
Test Mode	BLE_1Mbps_TX_CH 39	Test Voltage	AC 120V/60Hz

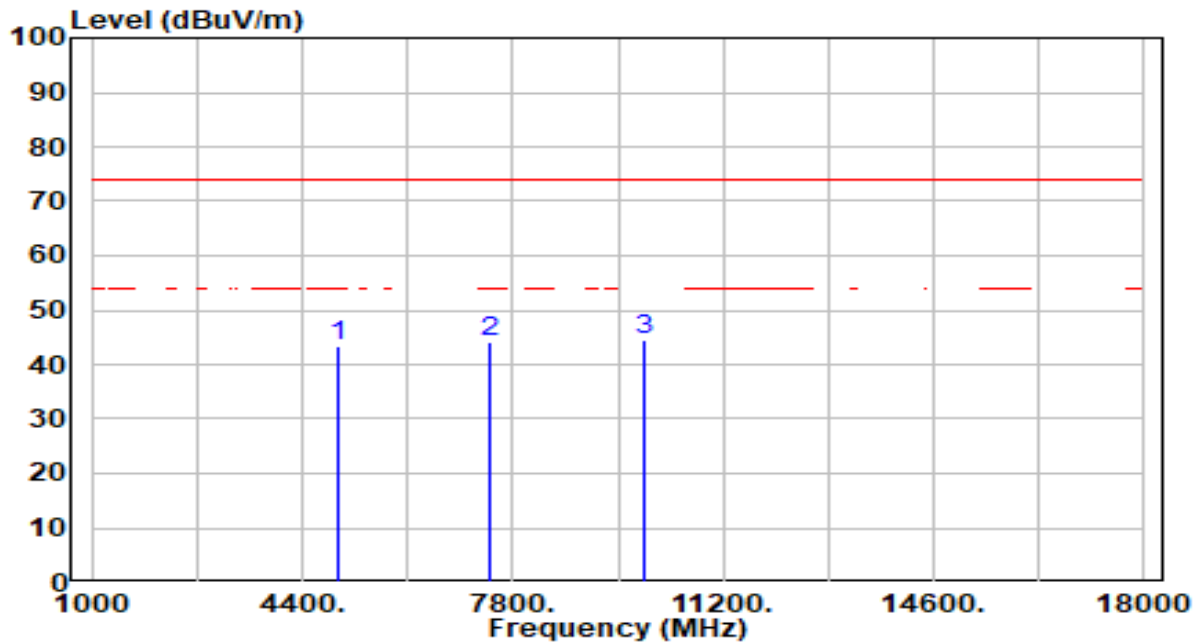

No	Frequency (MHz)	Reading (dBuV)	C.F (dB/m)	Measurement (dBuV/m)	Margin (dB)	Limit (dBuV/m)	Height (cm)	Angle (deg)	Remark (QP/PK/AV)
1	4960.000	44.30	-0.74	43.56	-30.44	74.00	100	175	Peak
2	7440.000	40.12	3.91	44.03	-29.97	74.00	100	206	Peak
3	* 9920.000	41.34	3.29	44.63	-29.37	74.00	100	352	Peak

Note:

1. " \*", means this data is the worst emission level.
2. C.F (Correction Factor) = Antenna Factor (dB/m) + Cable Loss (dB) – Preamplifier(dB).
3. Measurement (dBuV/m) = Reading(dBuV) + C.F (Correction Factor).
4. The emission levels of other frequencies are very lower than the limit and not show in test report.

EUT	BE9300 Wi-Fi 7 Bluetooth PCIe Adapter	Date of Test	2023-11-24
Factor	DRH18-E	Temp. / Humidity	23°C /63%
Polarity	Vertical	Site / Test Engineer	AC2 / Stanley
Test Mode	BLE_1Mbps_TX_CH 39	Test Voltage	AC 120V/60Hz

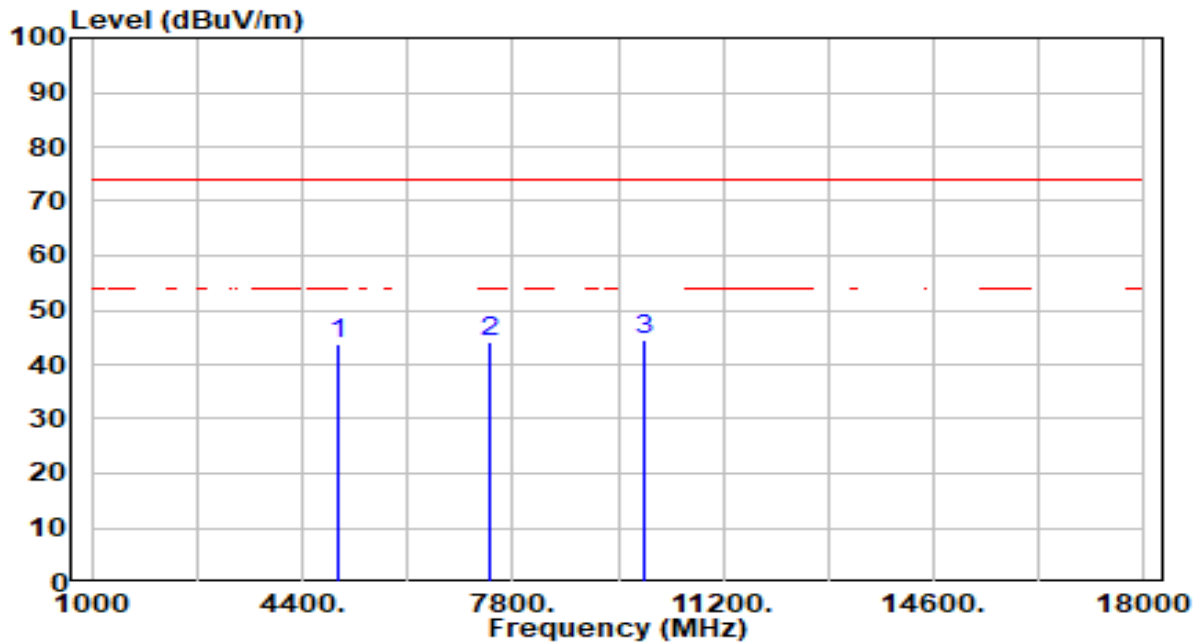

No	Frequency (MHz)	Reading (dBuV)	C.F (dB/m)	Measurement (dBuV/m)	Margin (dB)	Limit (dBuV/m)	Height (cm)	Angle (deg)	Remark (QP/PK/AV)
1	4960.000	44.33	-0.74	43.59	-30.41	74.00	100	153	Peak
2	7440.000	40.28	3.91	44.19	-29.81	74.00	100	156	Peak
3	* 9920.000	41.23	3.29	44.52	-29.48	74.00	100	298	Peak

Note:

1. " \*" , means this data is the worst emission level.
2. C.F (Correction Factor) = Antenna Factor (dB/m) + Cable Loss (dB) – Preamplifier(dB).
3. Measurement (dBuV/m) = Reading(dBuV) + C.F (Correction Factor).
4. The emission levels of other frequencies are very lower than the limit and not show in test report.

EUT	BE9300 Wi-Fi 7 Bluetooth PCIe Adapter	Date of Test	2023-11-24
Factor	DRH18-E	Temp. / Humidity	23°C /63%
Polarity	Horizontal	Site / Test Engineer	AC2 / Stanley
Test Mode	BLE_2Mbps_TX_CH 0	Test Voltage	AC 120V/60Hz

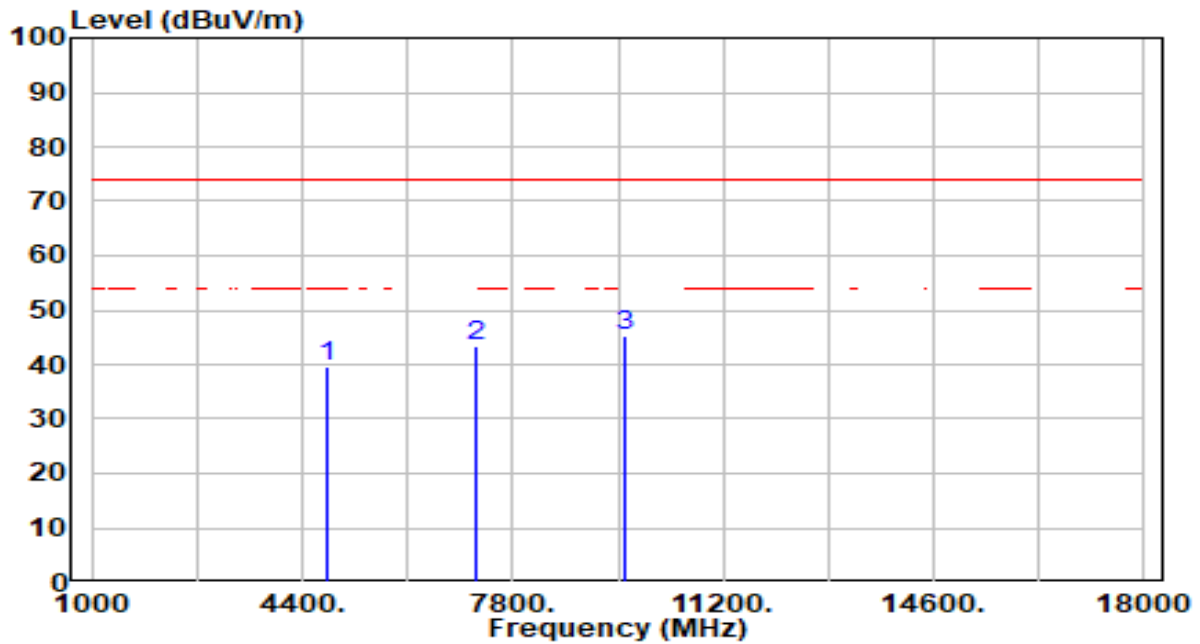

No	Frequency (MHz)	Reading (dBuV)	C.F (dB/m)	Measurement (dBuV/m)	Margin (dB)	Limit (dBuV/m)	Height (cm)	Angle (deg)	Remark (QP/PK/AV)
1	4804.000	40.86	-1.15	39.71	-34.29	74.00	100	250	Peak
2	7206.000	39.41	3.90	43.30	-30.70	74.00	100	34	Peak
3	* 9608.000	42.18	3.20	45.38	-28.62	74.00	100	148	Peak

Note:

1. " \*", means this data is the worst emission level.
2. C.F (Correction Factor) = Antenna Factor (dB/m) + Cable Loss (dB) – Preamplifier(dB).
3. Measurement (dBuV/m) = Reading(dBuV) + C.F (Correction Factor).
4. The emission levels of other frequencies are very lower than the limit and not show in test report.

EUT	BE9300 Wi-Fi 7 Bluetooth PCIe Adapter	Date of Test	2023-11-24
Factor	DRH18-E	Temp. / Humidity	23°C /63%
Polarity	Vertical	Site / Test Engineer	AC2 / Stanley
Test Mode	BLE_2Mbps_TX_CH 0	Test Voltage	AC 120V/60Hz

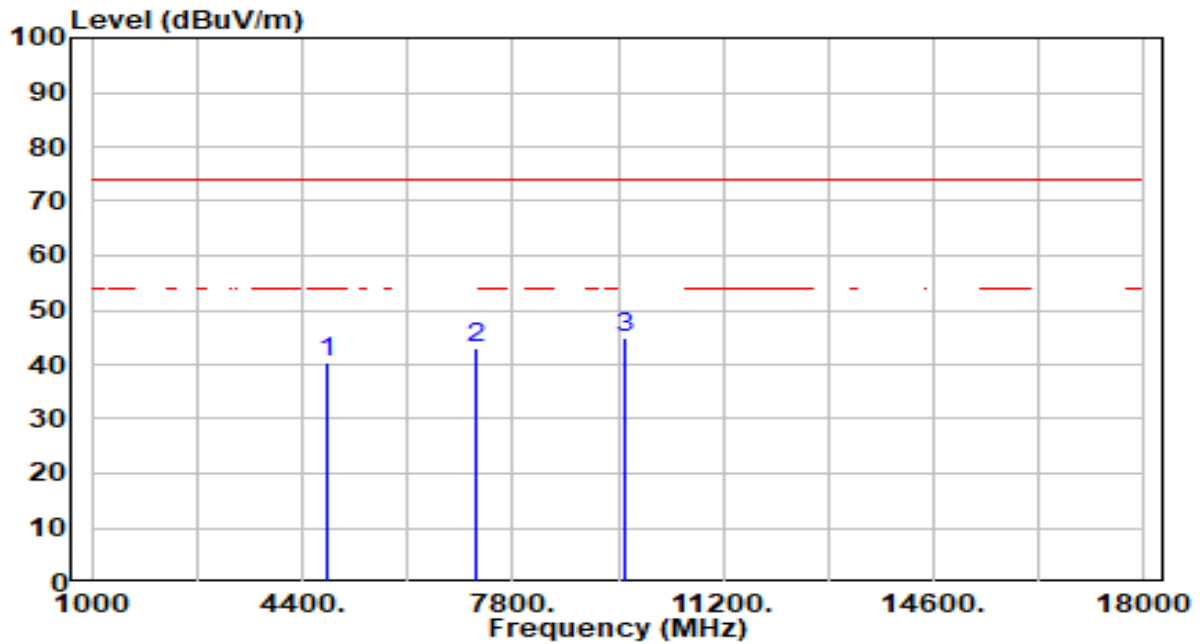

No	Frequency (MHz)	Reading (dBuV)	C.F (dB/m)	Measurement (dBuV/m)	Margin (dB)	Limit (dBuV/m)	Height (cm)	Angle (deg)	Remark (QP/PK/AV)
1	4804.000	41.42	-1.15	40.27	-33.73	74.00	100	323	Peak
2	7206.000	39.25	3.90	43.15	-30.85	74.00	100	343	Peak
3	* 9608.000	41.60	3.20	44.80	-29.20	74.00	100	128	Peak

Note:

1. " \*", means this data is the worst emission level.
2. C.F (Correction Factor) = Antenna Factor (dB/m) + Cable Loss (dB) – Preamplifier(dB).
3. Measurement (dBuV/m) = Reading(dBuV) + C.F (Correction Factor).
4. The emission levels of other frequencies are very lower than the limit and not show in test report.

EUT	BE9300 Wi-Fi 7 Bluetooth PCIe Adapter	Date of Test	2023-11-24
Factor	DRH18-E	Temp. / Humidity	23°C /63%
Polarity	Horizontal	Site / Test Engineer	AC2 / Stanley
Test Mode	BLE_2Mbps_TX_CH 19	Test Voltage	AC 120V/60Hz

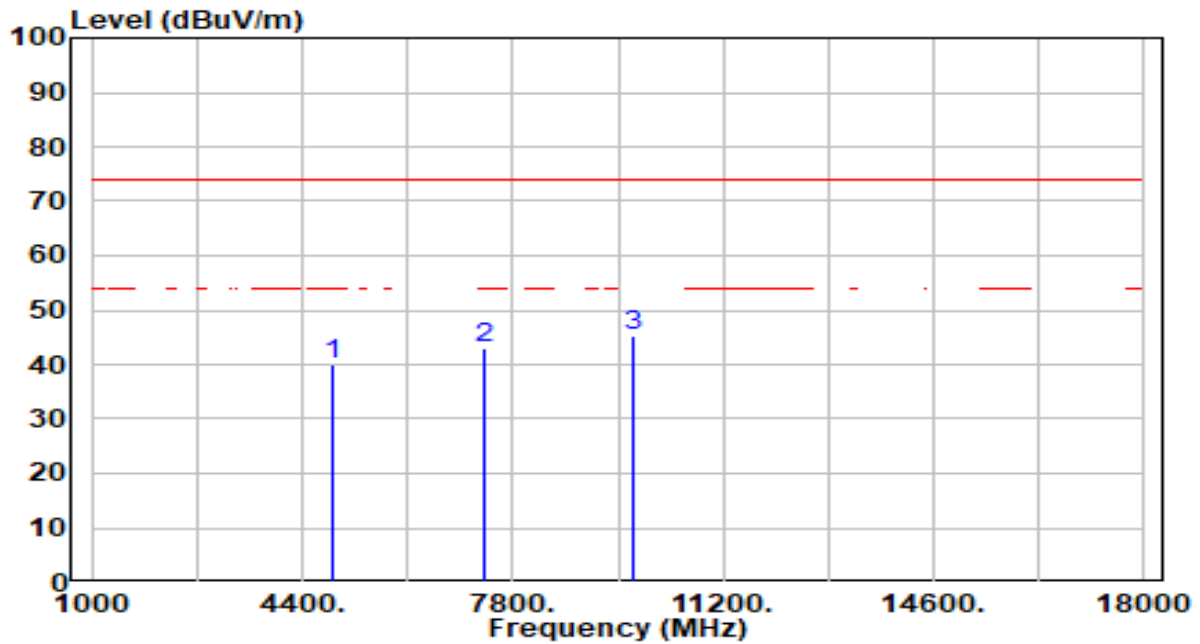

No	Frequency (MHz)	Reading (dBuV)	C.F (dB/m)	Measurement (dBuV/m)	Margin (dB)	Limit (dBuV/m)	Height (cm)	Angle (deg)	Remark (QP/PK/AV)
1	4880.000	40.82	-0.95	39.87	-34.13	74.00	100	193	Peak
2	7320.000	39.13	3.92	43.05	-30.95	74.00	100	327	Peak
3	* 9760.000	42.11	3.25	45.35	-28.65	74.00	100	46	Peak

Note:

1. " \*", means this data is the worst emission level.
2. C.F (Correction Factor) = Antenna Factor (dB/m) + Cable Loss (dB) – Preamplifier(dB).
3. Measurement (dBuV/m) = Reading(dBuV) + C.F (Correction Factor).
4. The emission levels of other frequencies are very lower than the limit and not show in test report.

EUT	BE9300 Wi-Fi 7 Bluetooth PCIe Adapter	Date of Test	2023-11-24
Factor	DRH18-E	Temp. / Humidity	23°C /63%
Polarity	Vertical	Site / Test Engineer	AC2 / Stanley
Test Mode	BLE_2Mbps_TX_CH 19	Test Voltage	AC 120V/60Hz

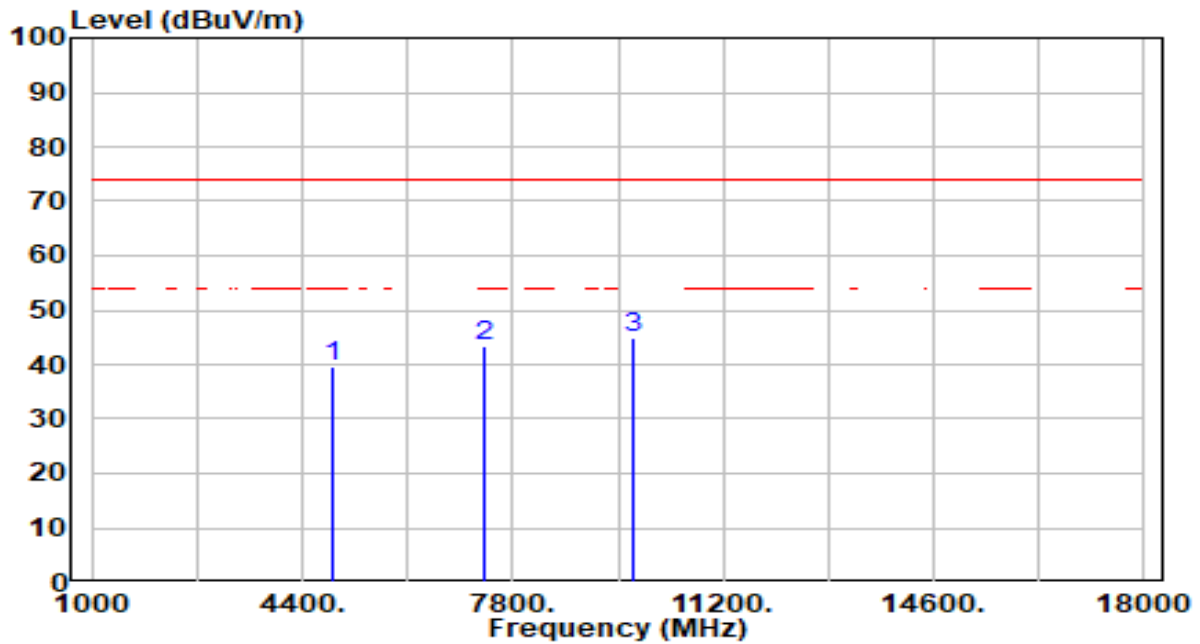

No	Frequency (MHz)	Reading (dBuV)	C.F (dB/m)	Measurement (dBuV/m)	Margin (dB)	Limit (dBuV/m)	Height (cm)	Angle (deg)	Remark (QP/PK/AV)
1	4880.000	40.55	-0.95	39.60	-34.40	74.00	100	0	Peak
2	7320.000	39.43	3.92	43.35	-30.65	74.00	100	332	Peak
3	* 9760.000	41.57	3.25	44.81	-29.19	74.00	100	131	Peak

Note:

1. " \*" , means this data is the worst emission level.
2. C.F (Correction Factor) = Antenna Factor (dB/m) + Cable Loss (dB) – Preamplifier(dB).
3. Measurement (dBuV/m) = Reading(dBuV) + C.F (Correction Factor).
4. The emission levels of other frequencies are very lower than the limit and not show in test report.

EUT	BE9300 Wi-Fi 7 Bluetooth PCIe Adapter	Date of Test	2023-11-24
Factor	DRH18-E	Temp. / Humidity	23°C /63%
Polarity	Horizontal	Site / Test Engineer	AC2 / Stanley
Test Mode	BLE_2Mbps_TX_CH 39	Test Voltage	AC 120V/60Hz

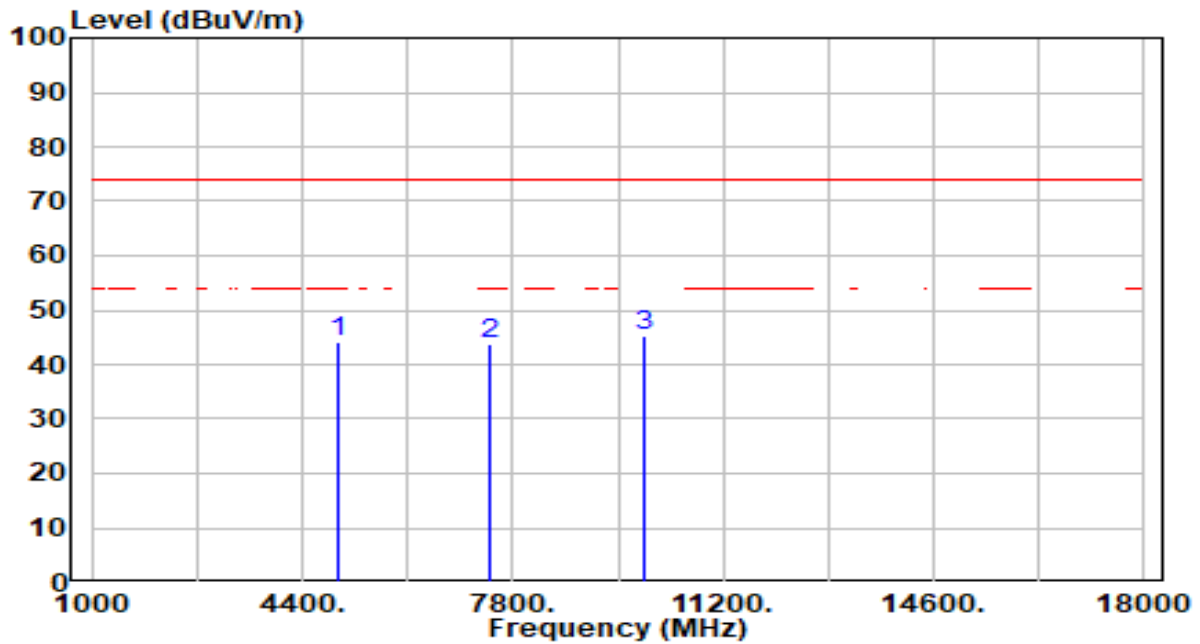

No	Frequency (MHz)	Reading (dBuV)	C.F (dB/m)	Measurement (dBuV/m)	Margin (dB)	Limit (dBuV/m)	Height (cm)	Angle (deg)	Remark (QP/PK/AV)
1	4960.000	44.78	-0.74	44.03	-29.97	74.00	100	232	Peak
2	7440.000	40.04	3.91	43.95	-30.05	74.00	100	356	Peak
3	* 9920.000	41.82	3.29	45.10	-28.90	74.00	100	325	Peak

Note:

1. " \*" , means this data is the worst emission level.
2. C.F (Correction Factor) = Antenna Factor (dB/m) + Cable Loss (dB) – Preamplifier(dB).
3. Measurement (dBuV/m) = Reading(dBuV) + C.F (Correction Factor).
4. The emission levels of other frequencies are very lower than the limit and not show in test report.



EUT	BE9300 Wi-Fi 7 Bluetooth PCIe Adapter	Date of Test	2023-11-24
Factor	DRH18-E	Temp. / Humidity	23°C /63%
Polarity	Vertical	Site / Test Engineer	AC2 / Stanley
Test Mode	BLE_2Mbps_TX_CH 39	Test Voltage	AC 120V/60Hz

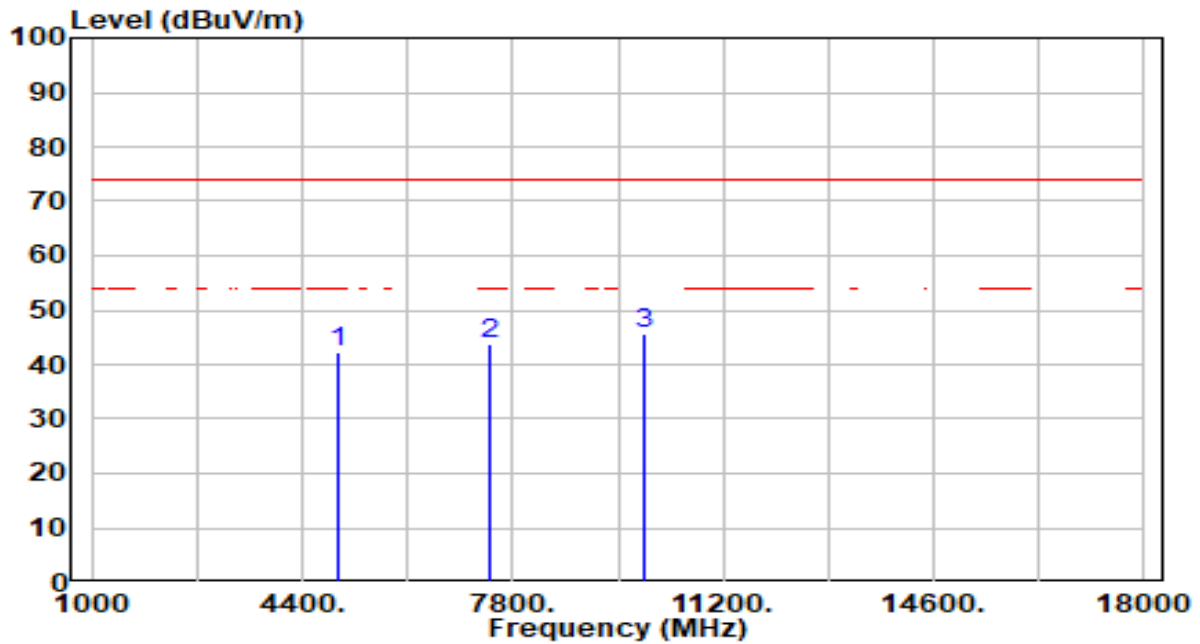

No	Frequency (MHz)	Reading (dBuV)	C.F (dB/m)	Measurement (dBuV/m)	Margin (dB)	Limit (dBuV/m)	Height (cm)	Angle (deg)	Remark (QP/PK/AV)
1	4960.000	42.86	-0.74	42.12	-31.88	74.00	100	145	Peak
2	7440.000	39.76	3.91	43.67	-30.33	74.00	100	277	Peak
3	* 9920.000	42.20	3.29	45.49	-28.51	74.00	100	12	Peak

Note:

1. " \*", means this data is the worst emission level.
2. C.F (Correction Factor) = Antenna Factor (dB/m) + Cable Loss (dB) – Preamplifier(dB).
3. Measurement (dBuV/m) = Reading(dBuV) + C.F (Correction Factor).
4. The emission levels of other frequencies are very lower than the limit and not show in test report.

EUT	BE9300 Wi-Fi 7 Bluetooth PCIe Adapter	Date of Test	2023-11-24
Factor	DRH18-E	Temp. / Humidity	23°C /63%
Polarity	Horizontal	Site / Test Engineer	AC2 / Stanley
Test Mode	BLE_Coded S=2_TX_CH 0	Test Voltage	AC 120V/60Hz

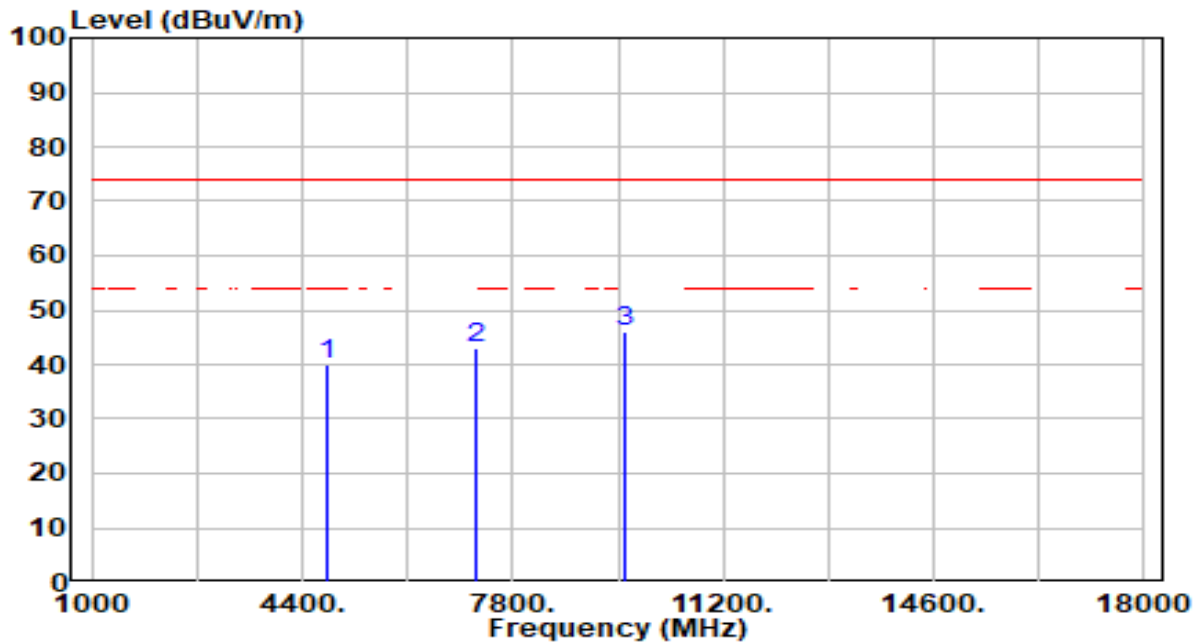

No	Frequency (MHz)	Reading (dBuV)	C.F (dB/m)	Measurement (dBuV/m)	Margin (dB)	Limit (dBuV/m)	Height (cm)	Angle (deg)	Remark (QP/PK/AV)
1	4804.000	41.19	-1.15	40.04	-33.96	74.00	100	26	Peak
2	7206.000	39.15	3.90	43.04	-30.96	74.00	100	210	Peak
3	* 9608.000	42.68	3.20	45.88	-28.12	74.00	100	215	Peak

Note:

1. " \*", means this data is the worst emission level.
2. C.F (Correction Factor) = Antenna Factor (dB/m) + Cable Loss (dB) – Preamplifier(dB).
3. Measurement (dBuV/m) = Reading(dBuV) + C.F (Correction Factor).
4. The emission levels of other frequencies are very lower than the limit and not show in test report.

EUT	BE9300 Wi-Fi 7 Bluetooth PCIe Adapter	Date of Test	2023-11-24
Factor	DRH18-E	Temp. / Humidity	23°C /63%
Polarity	Vertical	Site / Test Engineer	AC2 / Stanley
Test Mode	BLE_Coded S=2_TX_CH 0	Test Voltage	AC 120V/60Hz

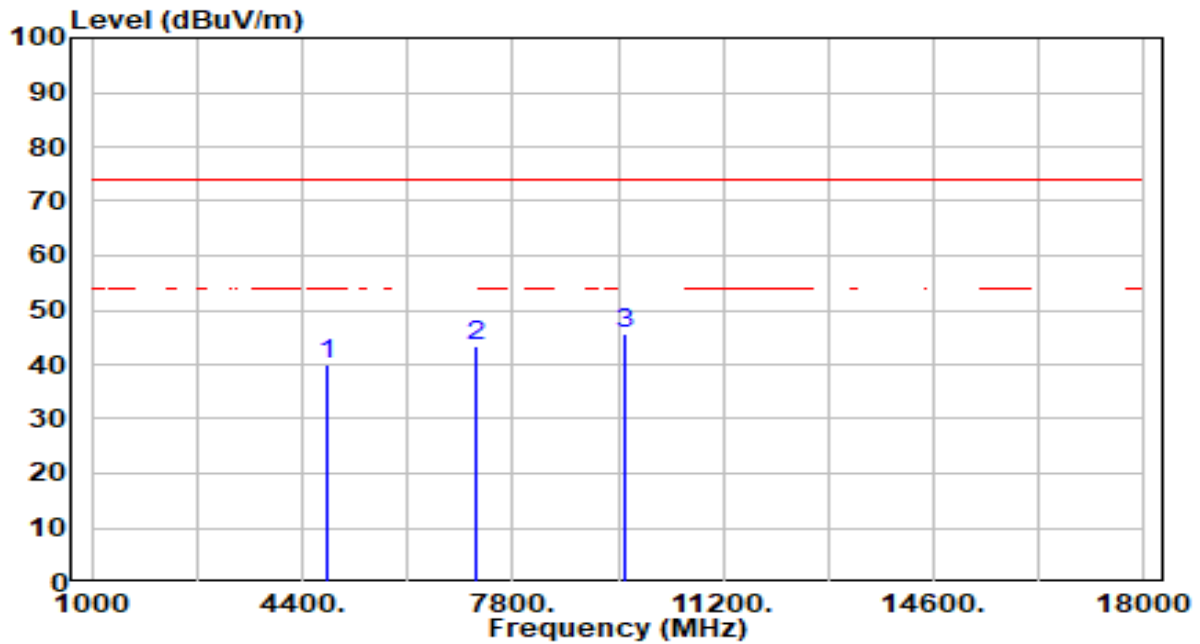

No	Frequency (MHz)	Reading (dBuV)	C.F (dB/m)	Measurement (dBuV/m)	Margin (dB)	Limit (dBuV/m)	Height (cm)	Angle (deg)	Remark (QP/PK/AV)
1	4804.000	41.17	-1.15	40.02	-33.98	74.00	100	103	Peak
2	7206.000	39.51	3.90	43.40	-30.60	74.00	100	4	Peak
3	* 9608.000	42.60	3.20	45.80	-28.20	74.00	100	74	Peak

Note:

1. " \*", means this data is the worst emission level.
2. C.F (Correction Factor) = Antenna Factor (dB/m) + Cable Loss (dB) – Preamplifier(dB).
3. Measurement (dBuV/m) = Reading(dBuV) + C.F (Correction Factor).
4. The emission levels of other frequencies are very lower than the limit and not show in test report.

EUT	BE9300 Wi-Fi 7 Bluetooth PCIe Adapter	Date of Test	2023-11-24
Factor	DRH18-E	Temp. / Humidity	23°C /63%
Polarity	Horizontal	Site / Test Engineer	AC2 / Stanley
Test Mode	BLE_Coded S=2_TX_CH 19	Test Voltage	AC 120V/60Hz

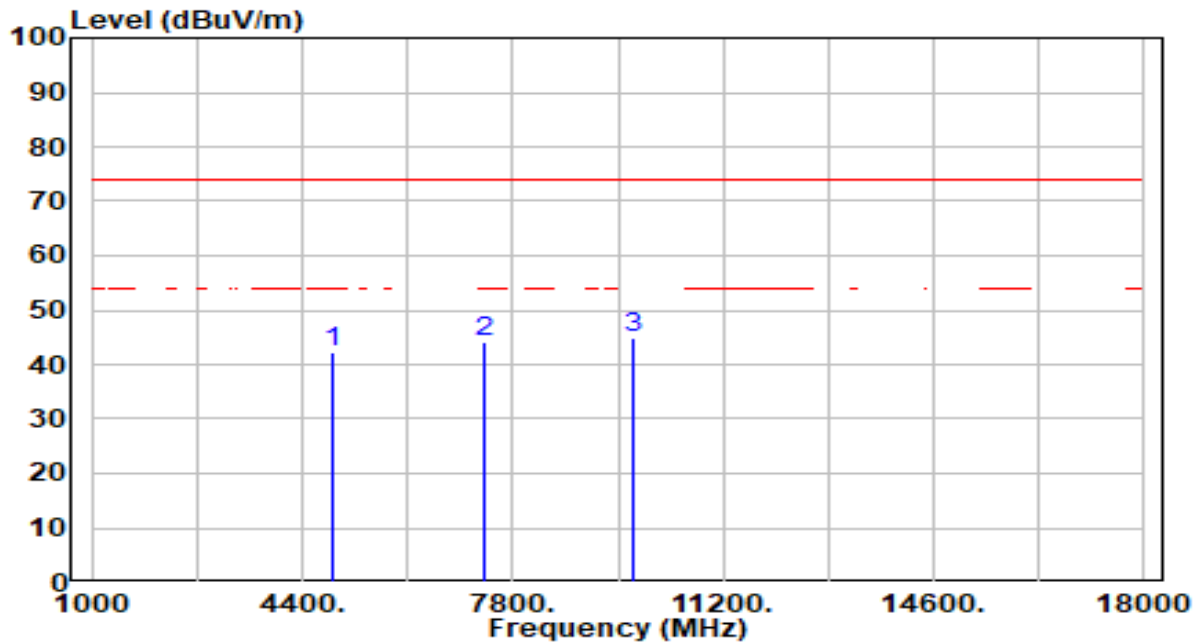

No	Frequency (MHz)	Reading (dBuV)	C.F (dB/m)	Measurement (dBuV/m)	Margin (dB)	Limit (dBuV/m)	Height (cm)	Angle (deg)	Remark (QP/PK/AV)
1	4880.000	43.06	-0.95	42.11	-31.89	74.00	100	170	Peak
2	7320.000	40.42	3.92	44.34	-29.66	74.00	100	251	Peak
3	* 9760.000	41.53	3.25	44.77	-29.23	74.00	100	84	Peak

Note:

1. " \*" , means this data is the worst emission level.
2. C.F (Correction Factor) = Antenna Factor (dB/m) + Cable Loss (dB) – Preamplifier(dB).
3. Measurement (dBuV/m) = Reading(dBuV) + C.F (Correction Factor).
4. The emission levels of other frequencies are very lower than the limit and not show in test report.

EUT	BE9300 Wi-Fi 7 Bluetooth PCIe Adapter	Date of Test	2023-11-24
Factor	DRH18-E	Temp. / Humidity	23°C /63%
Polarity	Vertical	Site / Test Engineer	AC2 / Stanley
Test Mode	BLE_Coded S=2_TX_CH 19	Test Voltage	AC 120V/60Hz

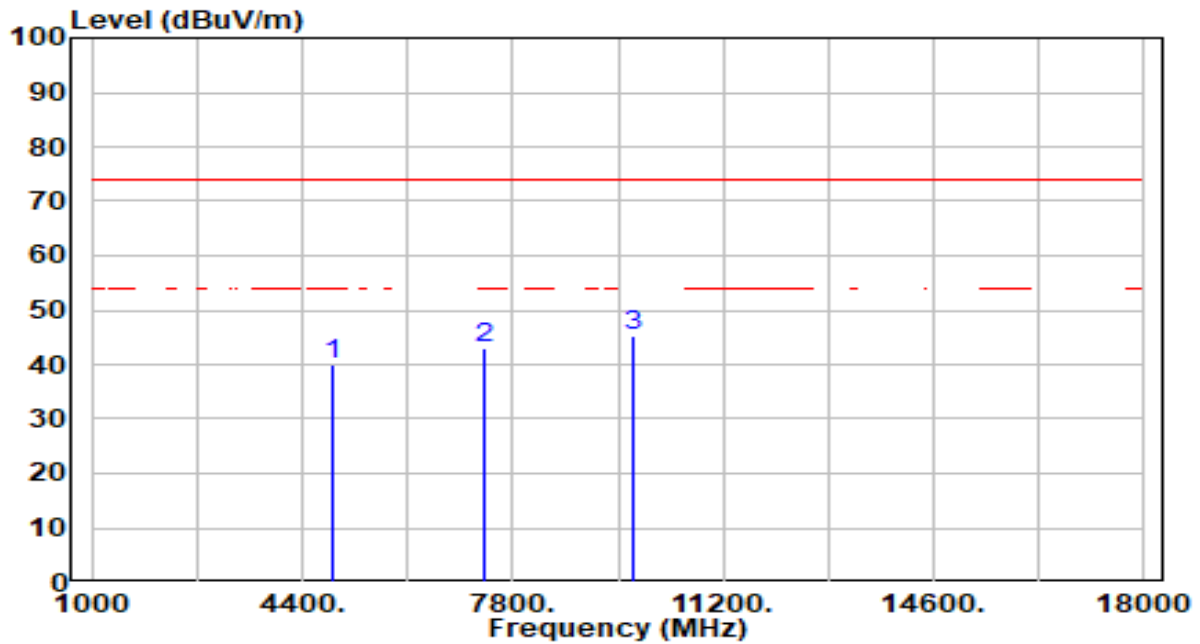

No	Frequency (MHz)	Reading (dBuV)	C.F (dB/m)	Measurement (dBuV/m)	Margin (dB)	Limit (dBuV/m)	Height (cm)	Angle (deg)	Remark (QP/PK/AV)
1	4880.000	40.91	-0.95	39.95	-34.05	74.00	100	199	Peak
2	7320.000	39.22	3.92	43.14	-30.86	74.00	100	216	Peak
3	* 9760.000	42.08	3.25	45.32	-28.68	74.00	100	259	Peak

Note:

1. " \*", means this data is the worst emission level.
2. C.F (Correction Factor) = Antenna Factor (dB/m) + Cable Loss (dB) – Preamplifier(dB).
3. Measurement (dBuV/m) = Reading(dBuV) + C.F (Correction Factor).
4. The emission levels of other frequencies are very lower than the limit and not show in test report.

EUT	BE9300 Wi-Fi 7 Bluetooth PCIe Adapter	Date of Test	2023-11-24
Factor	DRH18-E	Temp. / Humidity	23°C /63%
Polarity	Horizontal	Site / Test Engineer	AC2 / Stanley
Test Mode	BLE_Coded S=2_TX_CH 39	Test Voltage	AC 120V/60Hz

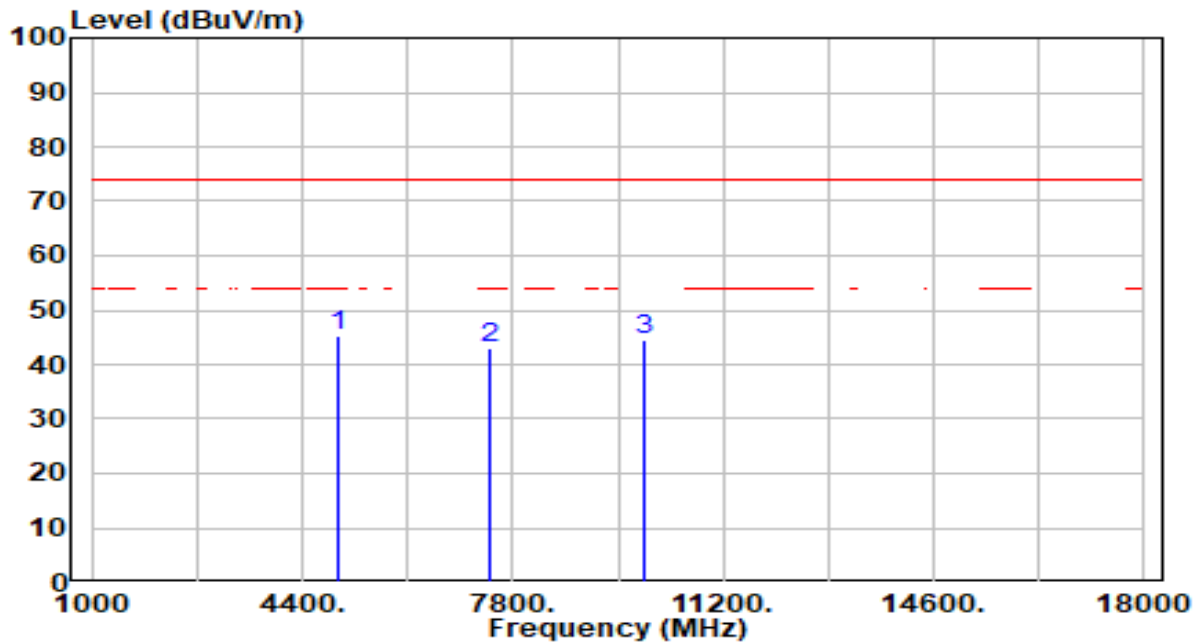

No	Frequency (MHz)	Reading (dBuV)	C.F (dB/m)	Measurement (dBuV/m)	Margin (dB)	Limit (dBuV/m)	Height (cm)	Angle (deg)	Remark (QP/PK/AV)
1	* 4960.000	45.93	-0.74	45.19	-28.81	74.00	100	169	Peak
2	7440.000	38.93	3.91	42.84	-31.16	74.00	100	214	Peak
3	9920.000	41.40	3.29	44.69	-29.31	74.00	100	169	Peak

Note:

1. " \*" , means this data is the worst emission level.
2. C.F (Correction Factor) = Antenna Factor (dB/m) + Cable Loss (dB) – Preamplifier(dB).
3. Measurement (dBuV/m) = Reading(dBuV) + C.F (Correction Factor).
4. The emission levels of other frequencies are very lower than the limit and not show in test report.

EUT	BE9300 Wi-Fi 7 Bluetooth PCIe Adapter	Date of Test	2023-11-24
Factor	DRH18-E	Temp. / Humidity	23°C /63%
Polarity	Vertical	Site / Test Engineer	AC2 / Stanley
Test Mode	BLE_Coded S=2_TX_CH 39	Test Voltage	AC 120V/60Hz

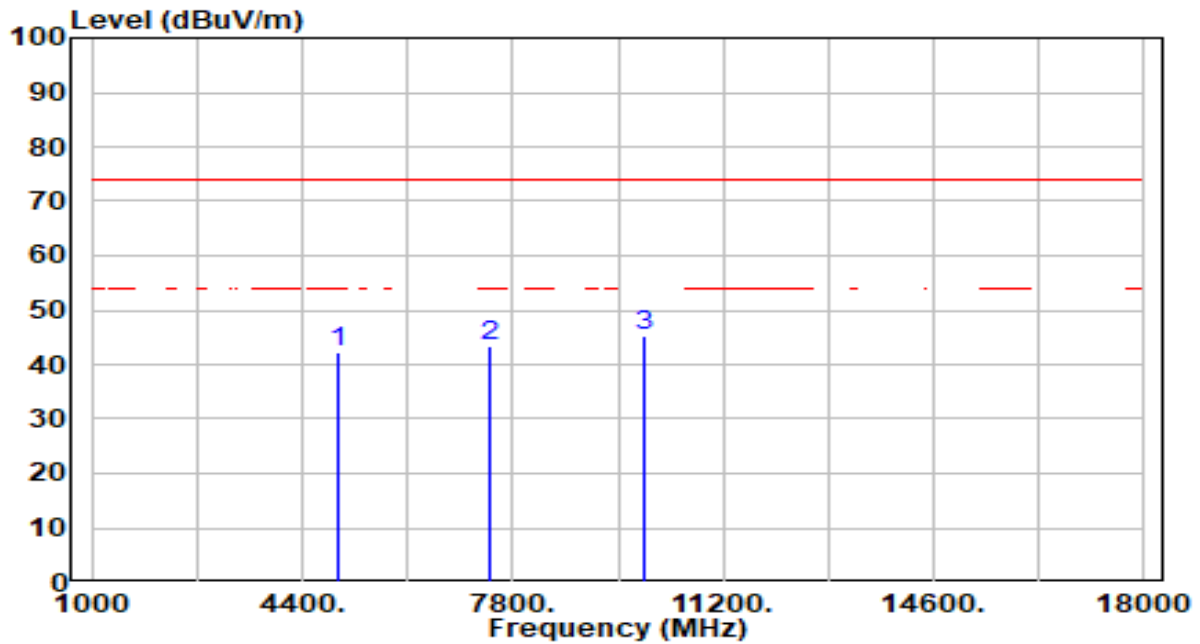

No	Frequency (MHz)	Reading (dBuV)	C.F (dB/m)	Measurement (dBuV/m)	Margin (dB)	Limit (dBuV/m)	Height (cm)	Angle (deg)	Remark (QP/PK/AV)
1	4960.000	43.12	-0.74	42.37	-31.63	74.00	100	145	Peak
2	7440.000	39.61	3.91	43.52	-30.48	74.00	100	360	Peak
3	* 9920.000	41.86	3.29	45.15	-28.85	74.00	100	133	Peak

Note:

1. " \*" , means this data is the worst emission level.
2. C.F (Correction Factor) = Antenna Factor (dB/m) + Cable Loss (dB) – Preamplifier(dB).
3. Measurement (dBuV/m) = Reading(dBuV) + C.F (Correction Factor).
4. The emission levels of other frequencies are very lower than the limit and not show in test report.

EUT	BE9300 Wi-Fi 7 Bluetooth PCIe Adapter	Date of Test	2023-11-24
Factor	DRH18-E	Temp. / Humidity	23°C /63%
Polarity	Horizontal	Site / Test Engineer	AC2 / Stanley
Test Mode	BLE_Coded S=8_TX_CH 0	Test Voltage	AC 120V/60Hz

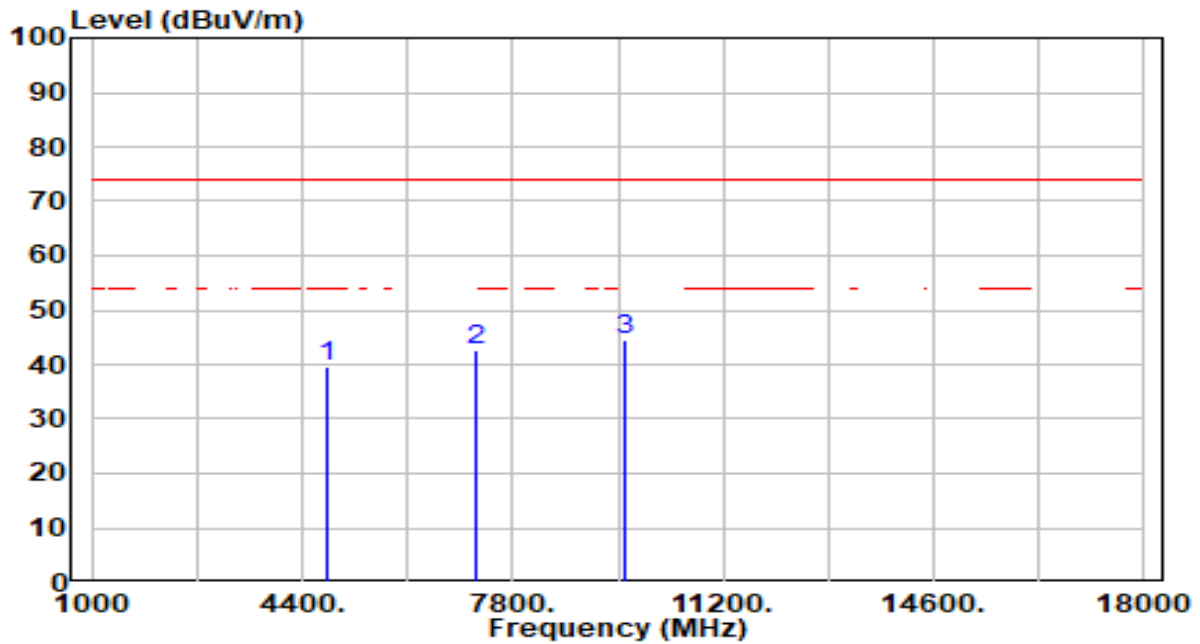

No	Frequency (MHz)	Reading (dBuV)	C.F (dB/m)	Measurement (dBuV/m)	Margin (dB)	Limit (dBuV/m)	Height (cm)	Angle (deg)	Remark (QP/PK/AV)
1	4804.000	40.77	-1.15	39.62	-34.38	74.00	100	212	Peak
2	7206.000	38.70	3.90	42.59	-31.41	74.00	100	31	Peak
3	* 9608.000	41.36	3.20	44.56	-29.44	74.00	100	350	Peak

Note:

1. " \*", means this data is the worst emission level.
2. C.F (Correction Factor) = Antenna Factor (dB/m) + Cable Loss (dB) – Preamplifier(dB).
3. Measurement (dBuV/m) = Reading(dBuV) + C.F (Correction Factor).
4. The emission levels of other frequencies are very lower than the limit and not show in test report.



EUT	BE9300 Wi-Fi 7 Bluetooth PCIe Adapter	Date of Test	2023-11-24
Factor	DRH18-E	Temp. / Humidity	23°C /63%
Polarity	Vertical	Site / Test Engineer	AC2 / Stanley
Test Mode	BLE_Coded S=8_TX_CH 0	Test Voltage	AC 120V/60Hz

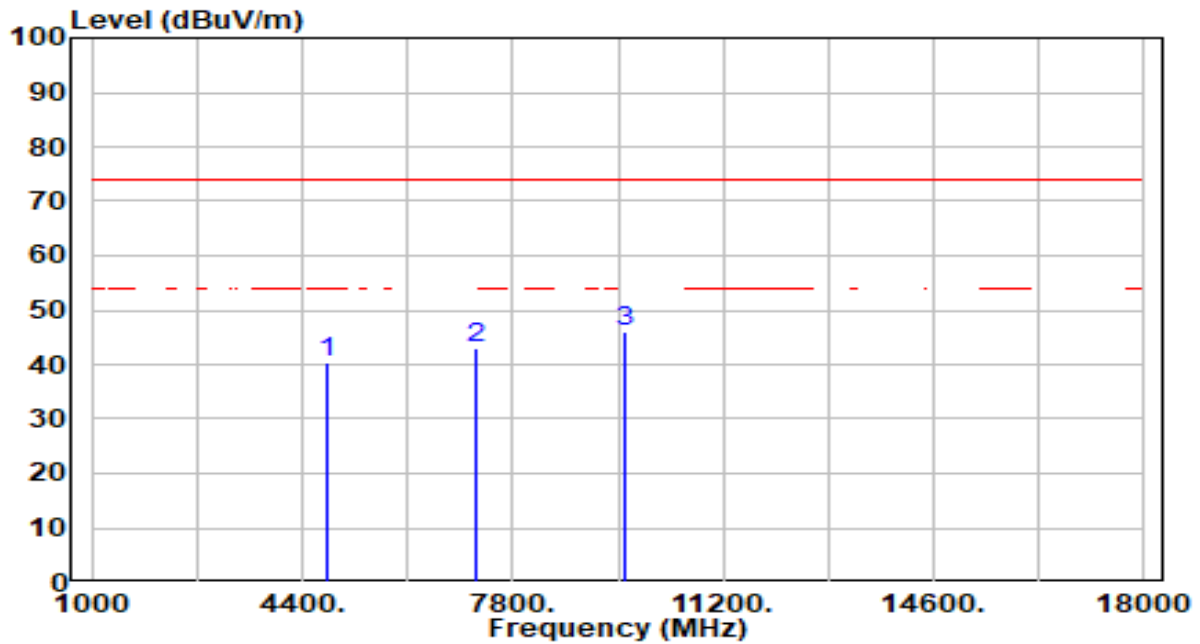

No	Frequency (MHz)	Reading (dBuV)	C.F (dB/m)	Measurement (dBuV/m)	Margin (dB)	Limit (dBuV/m)	Height (cm)	Angle (deg)	Remark (QP/PK/AV)
1	4804.000	41.51	-1.15	40.36	-33.64	74.00	100	328	Peak
2	7206.000	39.00	3.90	42.89	-31.11	74.00	100	325	Peak
3	* 9608.000	42.89	3.20	46.09	-27.91	74.00	100	294	Peak

Note:

1. " \*" , means this data is the worst emission level.
2. C.F (Correction Factor) = Antenna Factor (dB/m) + Cable Loss (dB) – Preamplifier(dB).
3. Measurement (dBuV/m) = Reading(dBuV) + C.F (Correction Factor).
4. The emission levels of other frequencies are very lower than the limit and not show in test report.

EUT	BE9300 Wi-Fi 7 Bluetooth PCIe Adapter	Date of Test	2023-11-24
Factor	DRH18-E	Temp. / Humidity	23°C /63%
Polarity	Horizontal	Site / Test Engineer	AC2 / Stanley
Test Mode	BLE_Coded S=8_TX_CH 19	Test Voltage	AC 120V/60Hz

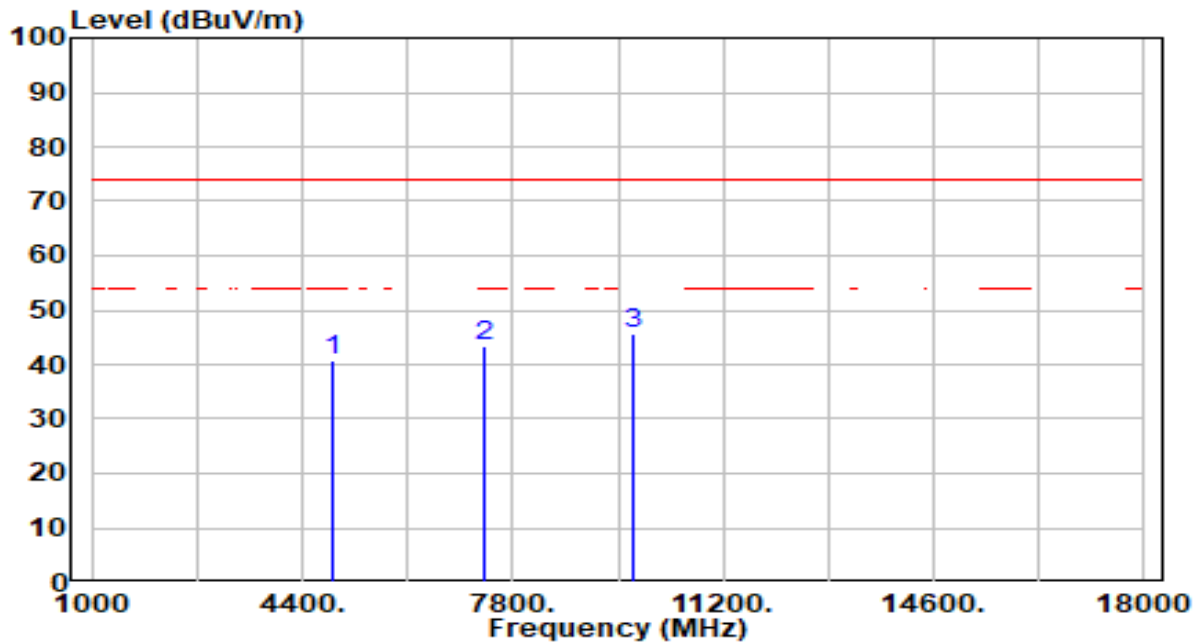

No	Frequency (MHz)	Reading (dBuV)	C.F (dB/m)	Measurement (dBuV/m)	Margin (dB)	Limit (dBuV/m)	Height (cm)	Angle (deg)	Remark (QP/PK/AV)
1	4880.000	41.81	-0.95	40.85	-33.15	74.00	100	207	Peak
2	7320.000	39.37	3.92	43.29	-30.71	74.00	100	315	Peak
3	* 9760.000	42.36	3.25	45.61	-28.39	74.00	100	17	Peak

Note:

1. " \*", means this data is the worst emission level.
2. C.F (Correction Factor) = Antenna Factor (dB/m) + Cable Loss (dB) – Preamplifier(dB).
3. Measurement (dBuV/m) = Reading(dBuV) + C.F (Correction Factor).
4. The emission levels of other frequencies are very lower than the limit and not show in test report.

EUT	BE9300 Wi-Fi 7 Bluetooth PCIe Adapter	Date of Test	2023-11-24
Factor	DRH18-E	Temp. / Humidity	23°C /63%
Polarity	Vertical	Site / Test Engineer	AC2 / Stanley
Test Mode	BLE_Coded S=8_TX_CH 19	Test Voltage	AC 120V/60Hz

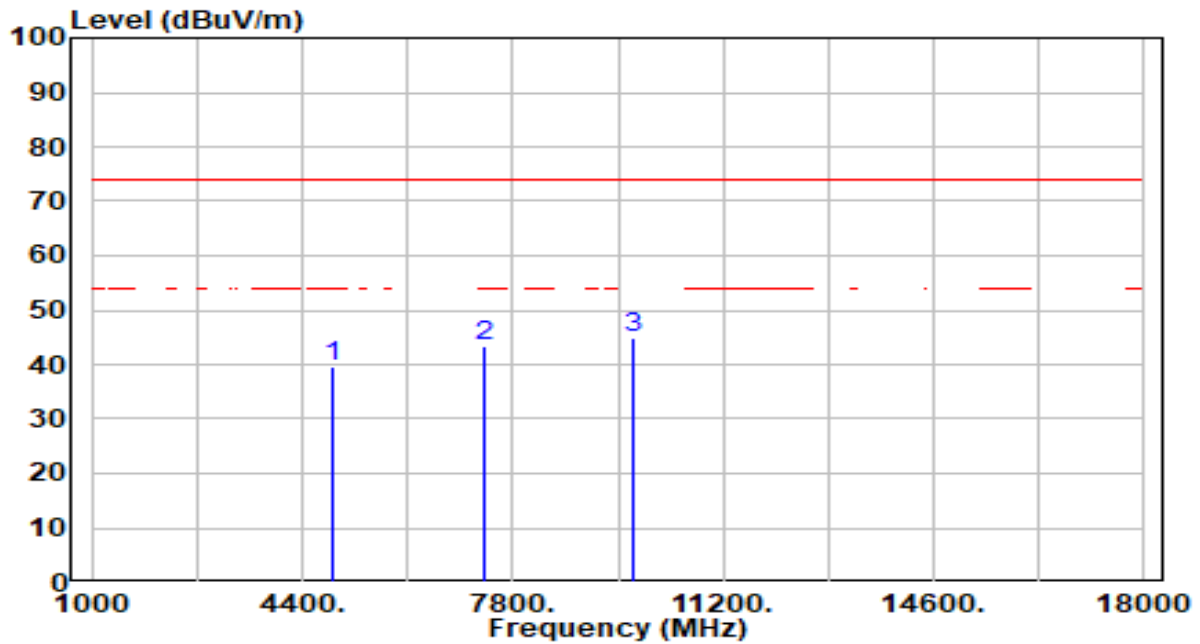

No	Frequency (MHz)	Reading (dBuV)	C.F (dB/m)	Measurement (dBuV/m)	Margin (dB)	Limit (dBuV/m)	Height (cm)	Angle (deg)	Remark (QP/PK/AV)
1	4880.000	40.45	-0.95	39.50	-34.50	74.00	100	346	Peak
2	7320.000	39.48	3.92	43.40	-30.60	74.00	100	256	Peak
3	* 9760.000	41.82	3.25	45.07	-28.93	74.00	100	211	Peak

Note:

1. " \*" , means this data is the worst emission level.
2. C.F (Correction Factor) = Antenna Factor (dB/m) + Cable Loss (dB) – Preamplifier(dB).
3. Measurement (dBuV/m) = Reading(dBuV) + C.F (Correction Factor).
4. The emission levels of other frequencies are very lower than the limit and not show in test report.

EUT	BE9300 Wi-Fi 7 Bluetooth PCIe Adapter	Date of Test	2023-11-24
Factor	DRH18-E	Temp. / Humidity	23°C /63%
Polarity	Horizontal	Site / Test Engineer	AC2 / Stanley
Test Mode	BLE_Coded S=8_TX_CH 39	Test Voltage	AC 120V/60Hz

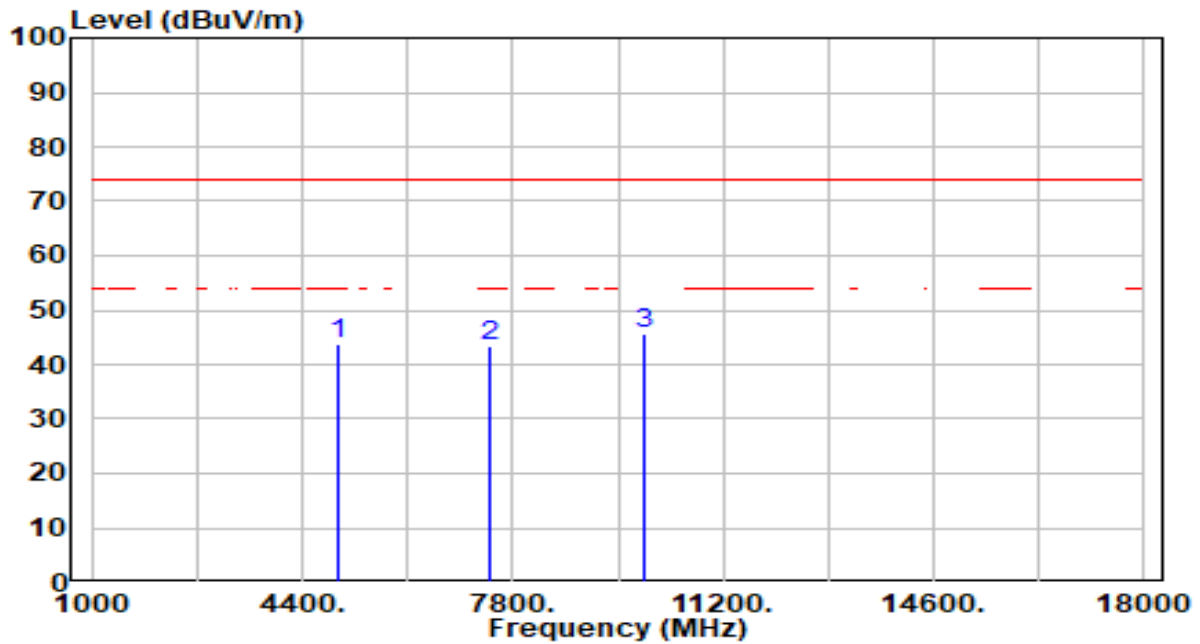

No	Frequency (MHz)	Reading (dBuV)	C.F (dB/m)	Measurement (dBuV/m)	Margin (dB)	Limit (dBuV/m)	Height (cm)	Angle (deg)	Remark (QP/PK/AV)
1	4960.000	44.63	-0.74	43.89	-30.11	74.00	100	232	Peak
2	7440.000	39.33	3.91	43.24	-30.76	74.00	100	283	Peak
3	* 9920.000	42.38	3.29	45.67	-28.33	74.00	100	0	Peak

Note:

1. " \*", means this data is the worst emission level.
2. C.F (Correction Factor) = Antenna Factor (dB/m) + Cable Loss (dB) – Preamplifier(dB).
3. Measurement (dBuV/m) = Reading(dBuV) + C.F (Correction Factor).
4. The emission levels of other frequencies are very lower than the limit and not show in test report.

EUT	BE9300 Wi-Fi 7 Bluetooth PCIe Adapter	Date of Test	2023-11-24
Factor	DRH18-E	Temp. / Humidity	23°C /63%
Polarity	Vertical	Site / Test Engineer	AC2 / Stanley
Test Mode	BLE_Coded S=8_TX_CH 39	Test Voltage	AC 120V/60Hz

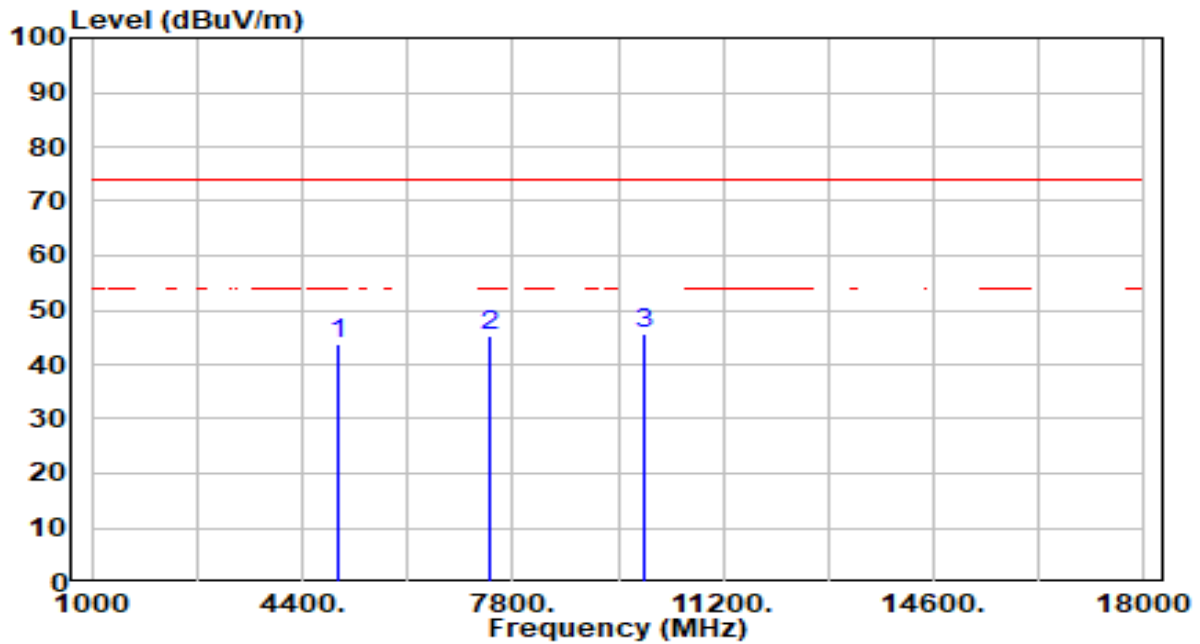

No	Frequency (MHz)	Reading (dBuV)	C.F (dB/m)	Measurement (dBuV/m)	Margin (dB)	Limit (dBuV/m)	Height (cm)	Angle (deg)	Remark (QP/PK/AV)
1	4960.000	44.49	-0.74	43.75	-30.25	74.00	100	218	Peak
2	7440.000	41.26	3.91	45.17	-28.83	74.00	100	10	Peak
3	* 9920.000	42.44	3.29	45.73	-28.27	74.00	100	70	Peak

Note:

1. " \*", means this data is the worst emission level.
2. C.F (Correction Factor) = Antenna Factor (dB/m) + Cable Loss (dB) – Preamplifier(dB).
3. Measurement (dBuV/m) = Reading(dBuV) + C.F (Correction Factor).
4. The emission levels of other frequencies are very lower than the limit and not show in test report.

## 7.7. Radiated Restricted Band Edge Measurement

### 7.7.1. Test Limit

All out of band emissions appearing in a restricted band as specified in Section 15.205 of the Title 47 CFR must not exceed the limits shown in Table per Section 15.209.

FCC Part 15 Subpart C Paragraph 15.209		
Frequency [MHz]	Field Strength [V/m]	Measured Distance [Meters]
0.009 - 0.490	2400/F (kHz)	300
0.490 - 1.705	24000/F (kHz)	30
1.705 – 30	30	30
30 – 88	100	3
88 – 216	150	3
216 – 960	200	3
Above 960	500	3

### 7.7.2. Test Procedure Used

ANSI C63.10 - 2013 Section 6.3 (General Requirements)

ANSI C63.10 - 2013 Section 6.6 (Standard test method above 1GHz)

### 7.7.3. Test Setting

#### Peak Field Strength Measurements

1. Analyzer center frequency was set to the frequency of the radiated spurious emission of interest
2. RBW = as specified in Table 1
3. VBW = 3 \* RBW
4. Detector = peak
5. Sweep time = auto couple
6. Trace mode = max hold

7. Trace was allowed to stabilize

**Table 1 - RBW as a function of frequency**

Frequency	RBW
9 ~ 150 kHz	200 ~ 300 Hz
0.15 ~ 30 MHz	9 ~ 10 kHz
30 ~ 1000 MHz	100 ~ 120 kHz
> 1000 MHz	1 MHz

**Average Field Strength Measurements**

1. Analyzer center frequency was set to the frequency of the radiated spurious emission of interest
2. RBW = 1MHz
3. VBW  $\geq 1/T$
4. De As an alternative, the instrument may be set to linear detector mode. Ensure that video filtering is applied in linear voltage domain (rather than in a log or dB domain). Some instruments require linear display mode in order to accomplish this. Others have a setting for Average-VBW Type, which can be set to "Voltage" regardless of the display mode
5. Detector = Peak
6. Sweep time = auto
7. Trace mode = max hold
8. Allow max hold to run for at least 50 times (1/duty cycle) traces

### 7.7.4. Test Setup

#### 1GHz ~ 25GHz Test Setup:

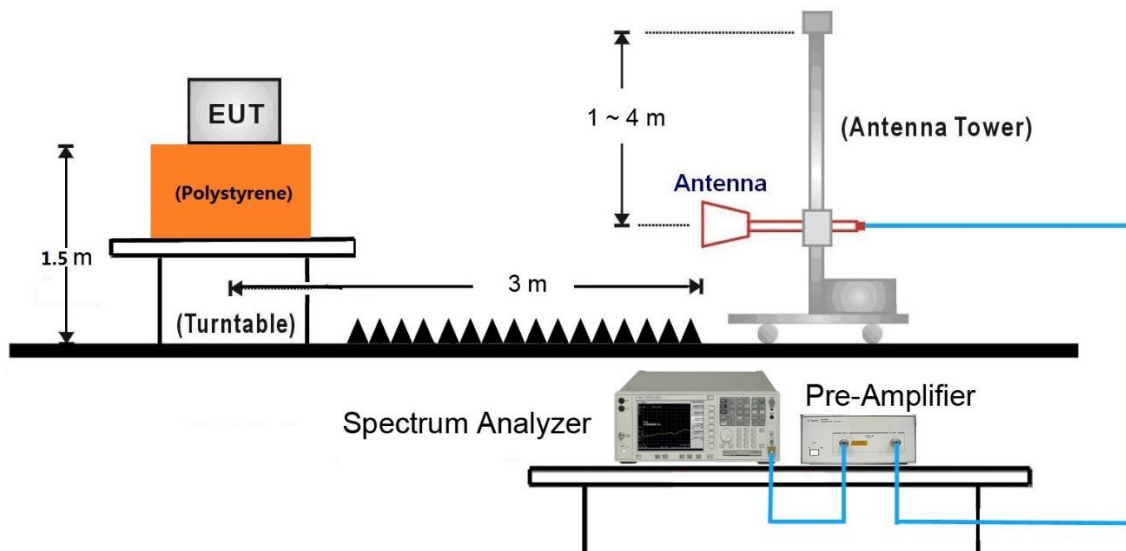



### 7.7.5. Test Result

EUT	BE9300 Wi-Fi 7 Bluetooth PCIe Adapter	Date of Test	2023-11-24
Factor	DRH18-E	Temp. / Humidity	23°C /63%
Polarity	Horizontal	Site / Test Engineer	AC2 / Stanley
Test Mode	BLE_1Mbps_TX_CH 0	Test Voltage	AC 120V/60Hz

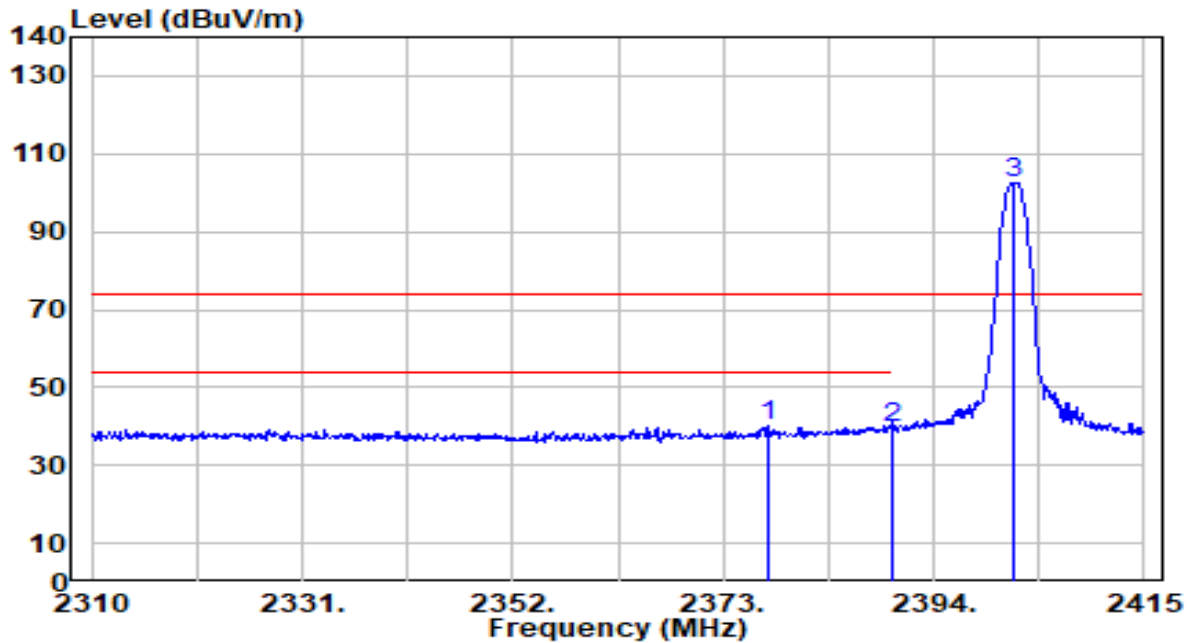

No	Frequency (MHz)	Reading (dBuV)	C.F (dB/m)	Measurement (dBuV/m)	Margin (dB)	Limit (dBuV/m)	Height (cm)	Angle (deg)	Remark (QP/PK/AV)
1	* 2377.620	45.75	-5.44	40.32	-33.68	74.00	300	122	Peak
2	2390.000	44.94	-5.41	39.53	-34.47	74.00	300	122	Peak
3	2401.875	107.95	-5.39	102.55	N/A	N/A	300	122	Peak

Note:

1. " \*", means this data is the worst emission level.
2. C.F (Correction Factor) = Antenna Factor (dB/m) + Cable Loss (dB) – Preamplifier(dB).
3. Measurement (dBuV/m) = Reading(dBuV) + C.F (Correction Factor).
4. The emission levels of other frequencies are very lower than the limit and not show in test report.

EUT	BE9300 Wi-Fi 7 Bluetooth PCIe Adapter	Date of Test	2023-11-24
Factor	DRH18-E	Temp. / Humidity	23°C /63%
Polarity	Vertical	Site / Test Engineer	AC2 / Stanley
Test Mode	BLE_1Mbps_TX_CH 0	Test Voltage	AC 120V/60Hz

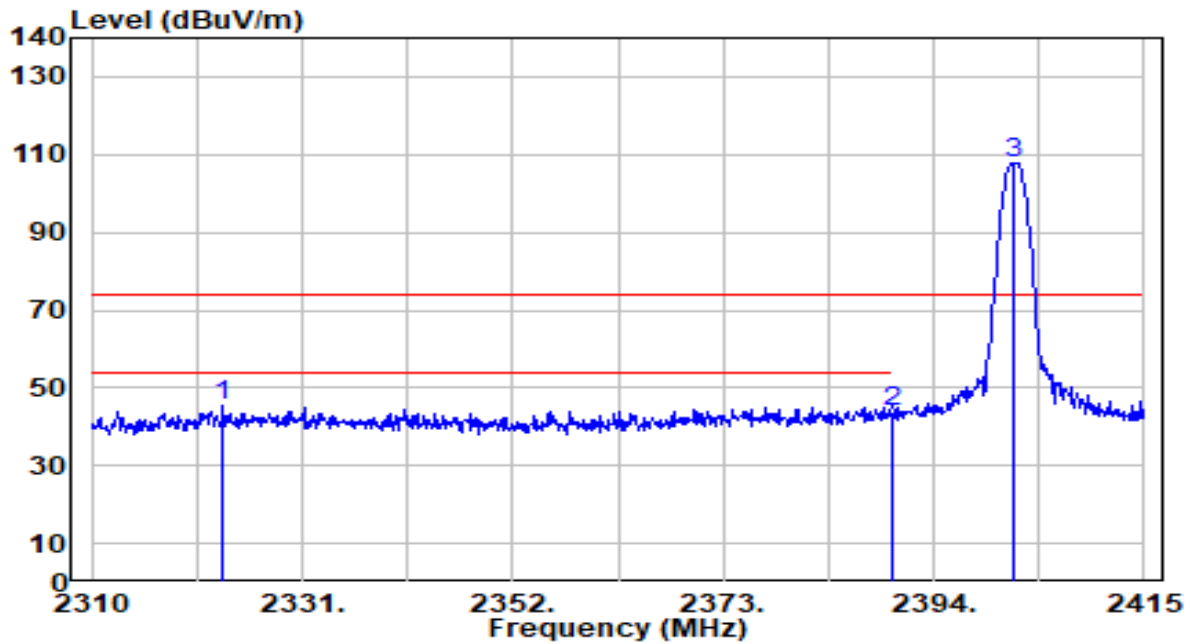

No	Frequency (MHz)	Reading (dBuV)	C.F (dB/m)	Measurement (dBuV/m)	Margin (dB)	Limit (dBuV/m)	Height (cm)	Angle (deg)	Remark (QP/PK/AV)
1	* 2323.125	50.79	-5.54	45.25	-28.75	74.00	100	160	Peak
2	2390.000	49.22	-5.41	43.81	-30.19	74.00	100	160	Peak
3	2401.980	113.10	-5.39	107.71	N/A	N/A	100	160	Peak

Note:

1. " \*", means this data is the worst emission level.
2. C.F (Correction Factor) = Antenna Factor (dB/m) + Cable Loss (dB) – Preamplifier(dB).
3. Measurement (dBuV/m) = Reading(dBuV) + C.F (Correction Factor).
4. The emission levels of other frequencies are very lower than the limit and not show in test report.

EUT	BE9300 Wi-Fi 7 Bluetooth PCIe Adapter	Date of Test	2023-11-24
Factor	DRH18-E	Temp. / Humidity	23°C /63%
Polarity	Horizontal	Site / Test Engineer	AC2 / Stanley
Test Mode	BLE_1Mbps_TX_CH 39	Test Voltage	AC 120V/60Hz

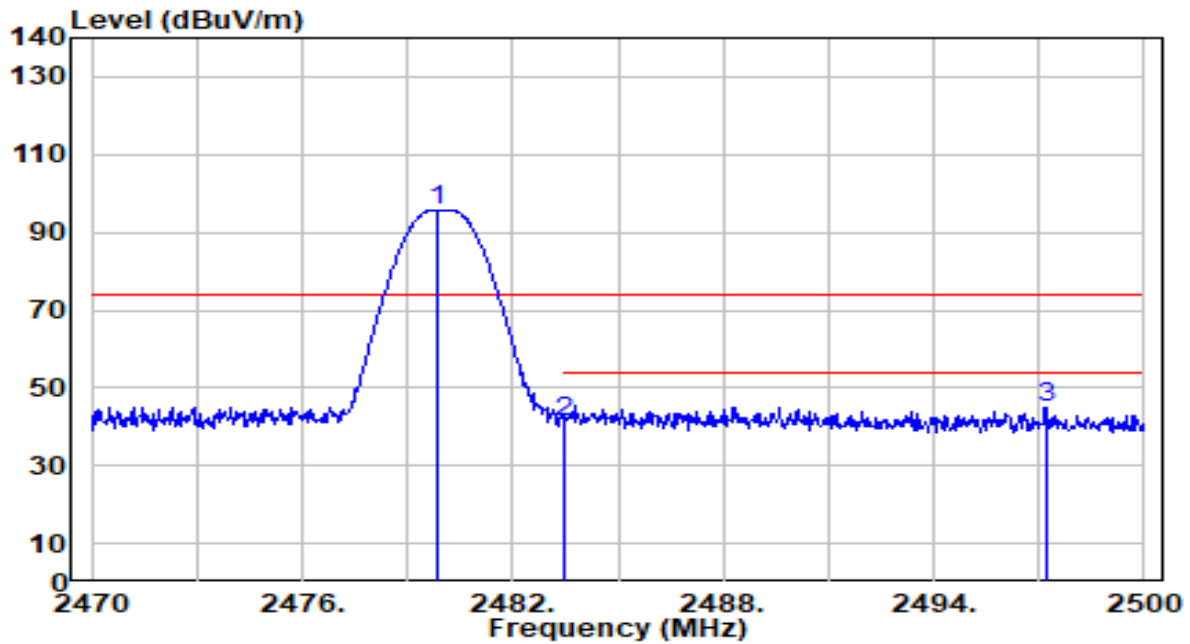

No	Frequency (MHz)	Reading (dBuV)	C.F (dB/m)	Measurement (dBuV/m)	Margin (dB)	Limit (dBuV/m)	Height (cm)	Angle (deg)	Remark (QP/PK/AV)
1	2479.840	101.25	-5.37	95.88	N/A	N/A	104	192	Peak
2	2483.500	46.57	-5.37	41.21	-32.79	74.00	104	192	Peak
3	* 2497.210	50.40	-5.36	45.04	-28.96	74.00	104	192	Peak

Note:

1. " \*" , means this data is the worst emission level.
2. C.F (Correction Factor) = Antenna Factor (dB/m) + Cable Loss (dB) – Preamplifier(dB).
3. Measurement (dBuV/m) = Reading(dBuV) + C.F (Correction Factor).
4. The emission levels of other frequencies are very lower than the limit and not show in test report.

EUT	BE9300 Wi-Fi 7 Bluetooth PCIe Adapter	Date of Test	2023-11-24
Factor	DRH18-E	Temp. / Humidity	23°C /63%
Polarity	Vertical	Site / Test Engineer	AC2 / Stanley
Test Mode	BLE_1Mbps_TX_CH 39	Test Voltage	AC 120V/60Hz

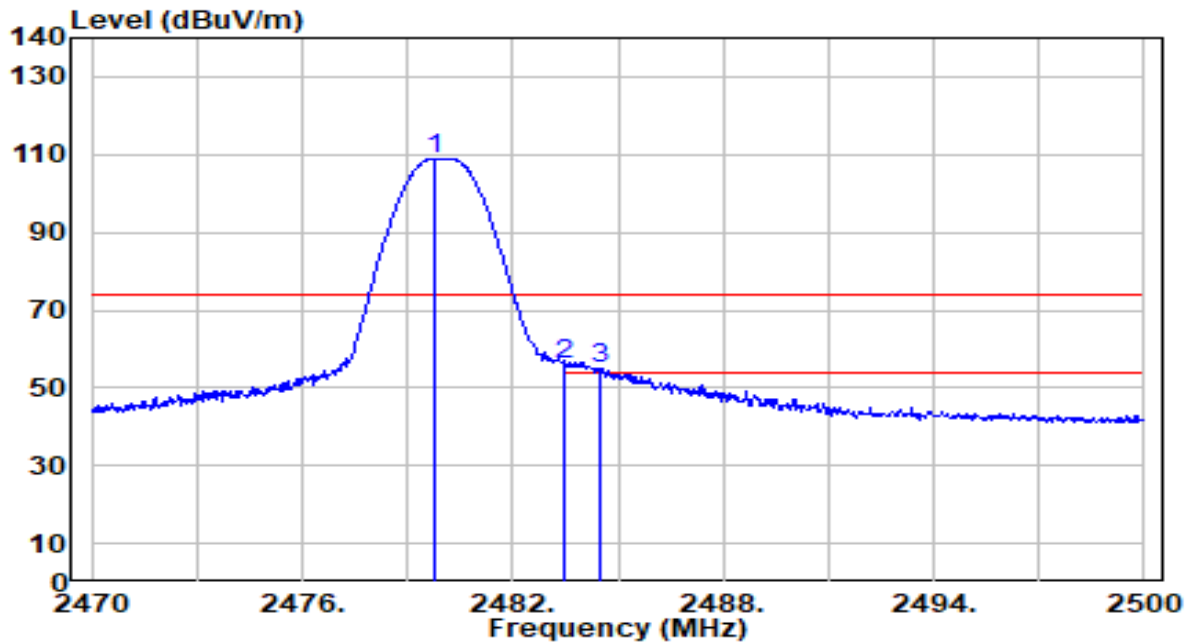

No	Frequency (MHz)	Reading (dBuV)	C.F (dB/m)	Measurement (dBuV/m)	Margin (dB)	Limit (dBuV/m)	Height (cm)	Angle (deg)	Remark (QP/PK/AV)
1	2479.810	114.42	-5.37	109.05	N/A	N/A	208	157	Peak
2	* 2483.500	61.48	-5.37	56.11	-17.89	74.00	208	157	Peak
3	2484.520	60.12	-5.37	54.75	-19.25	74.00	208	157	Peak

Note:

1. " \*", means this data is the worst emission level.
2. C.F (Correction Factor) = Antenna Factor (dB/m) + Cable Loss (dB) – Preamplifier(dB).
3. Measurement (dBuV/m) = Reading(dBuV) + C.F (Correction Factor).
4. The emission levels of other frequencies are very lower than the limit and not show in test report.

EUT	BE9300 Wi-Fi 7 Bluetooth PCIe Adapter	Date of Test	2023-11-24
Factor	DRH18-E	Temp. / Humidity	23°C /63%
Polarity	Vertical	Site / Test Engineer	AC2 / Stanley
Test Mode	BLE_1Mbps_TX_CH 39	Test Voltage	AC 120V/60Hz

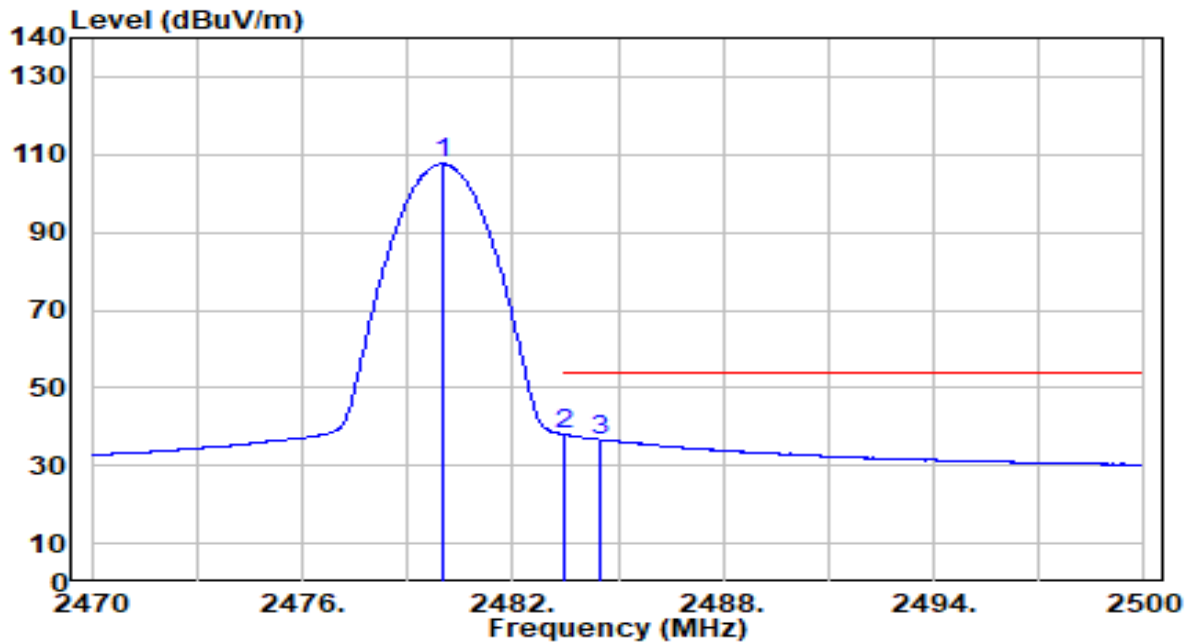

No	Frequency (MHz)	Reading (dBuV)	C.F (dB/m)	Measurement (dBuV/m)	Margin (dB)	Limit (dBuV/m)	Height (cm)	Angle (deg)	Remark (QP/PK/AV)
1	2479.990	112.95	-5.37	107.59	N/A	N/A	208	157	Average
2	* 2483.500	43.34	-5.37	37.97	-16.03	54.00	208	157	Average
3	2484.520	42.01	-5.37	36.65	-17.35	54.00	208	157	Average

Note:

1. " \*", means this data is the worst emission level.
2. C.F (Correction Factor) = Antenna Factor (dB/m) + Cable Loss (dB) – Preamplifier(dB).
3. Measurement (dBuV/m) = Reading(dBuV) + C.F (Correction Factor).
4. The emission levels of other frequencies are very lower than the limit and not show in test report.

EUT	BE9300 Wi-Fi 7 Bluetooth PCIe Adapter	Date of Test	2023-11-24
Factor	DRH18-E	Temp. / Humidity	23°C /63%
Polarity	Horizontal	Site / Test Engineer	AC2 / Stanley
Test Mode	BLE_2Mbps_TX_CH 0	Test Voltage	AC 120V/60Hz

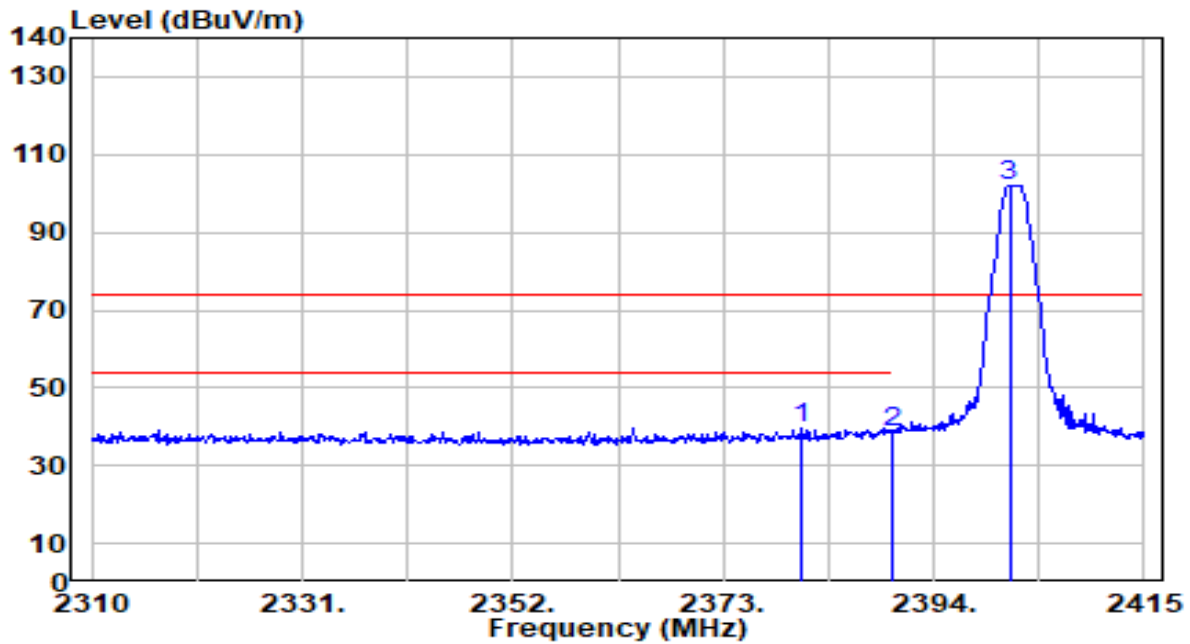

No	Frequency (MHz)	Reading (dBuV)	C.F (dB/m)	Measurement (dBuV/m)	Margin (dB)	Limit (dBuV/m)	Height (cm)	Angle (deg)	Remark (QP/PK/AV)
1	* 2380.770	45.29	-5.43	39.86	-34.14	74.00	300	122	Peak
2	2390.000	44.14	-5.41	38.73	-35.27	74.00	300	122	Peak
3	2401.560	107.55	-5.39	102.16	N/A	N/A	300	122	Peak

Note:

1. " \*", means this data is the worst emission level.
2. C.F (Correction Factor) = Antenna Factor (dB/m) + Cable Loss (dB) – Preamplifier(dB).
3. Measurement (dBuV/m) = Reading(dBuV) + C.F (Correction Factor).
4. The emission levels of other frequencies are very lower than the limit and not show in test report.

EUT	BE9300 Wi-Fi 7 Bluetooth PCIe Adapter	Date of Test	2023-11-24
Factor	DRH18-E	Temp. / Humidity	23°C /63%
Polarity	Vertical	Site / Test Engineer	AC2 / Stanley
Test Mode	BLE_2Mbps_TX_CH 0	Test Voltage	AC 120V/60Hz

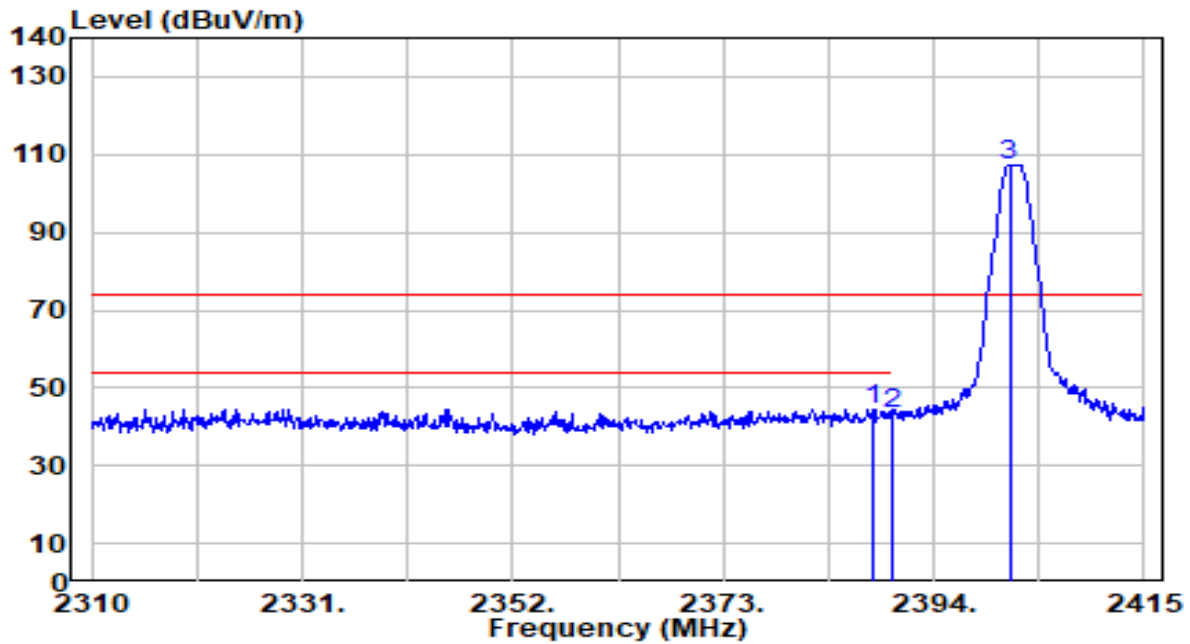

No	Frequency (MHz)	Reading (dBuV)	C.F (dB/m)	Measurement (dBuV/m)	Margin (dB)	Limit (dBuV/m)	Height (cm)	Angle (deg)	Remark (QP/PK/AV)
1	* 2388.015	50.00	-5.42	44.59	-29.41	74.00	100	160	Peak
2	2390.000	48.51	-5.41	43.10	-30.90	74.00	100	160	Peak
3	2401.560	112.78	-5.39	107.39	N/A	N/A	100	160	Peak

Note:

1. " \*", means this data is the worst emission level.
2. C.F (Correction Factor) = Antenna Factor (dB/m) + Cable Loss (dB) – Pre-amplifier(dB).
3. Measurement (dBuV/m) = Reading(dBuV) + C.F (Correction Factor).
4. The emission levels of other frequencies are very lower than the limit and not show in test report.

EUT	BE9300 Wi-Fi 7 Bluetooth PCIe Adapter	Date of Test	2023-11-24
Factor	DRH18-E	Temp. / Humidity	23°C /63%
Polarity	Horizontal	Site / Test Engineer	AC2 / Stanley
Test Mode	BLE_2Mbps_TX_CH 39	Test Voltage	AC 120V/60Hz

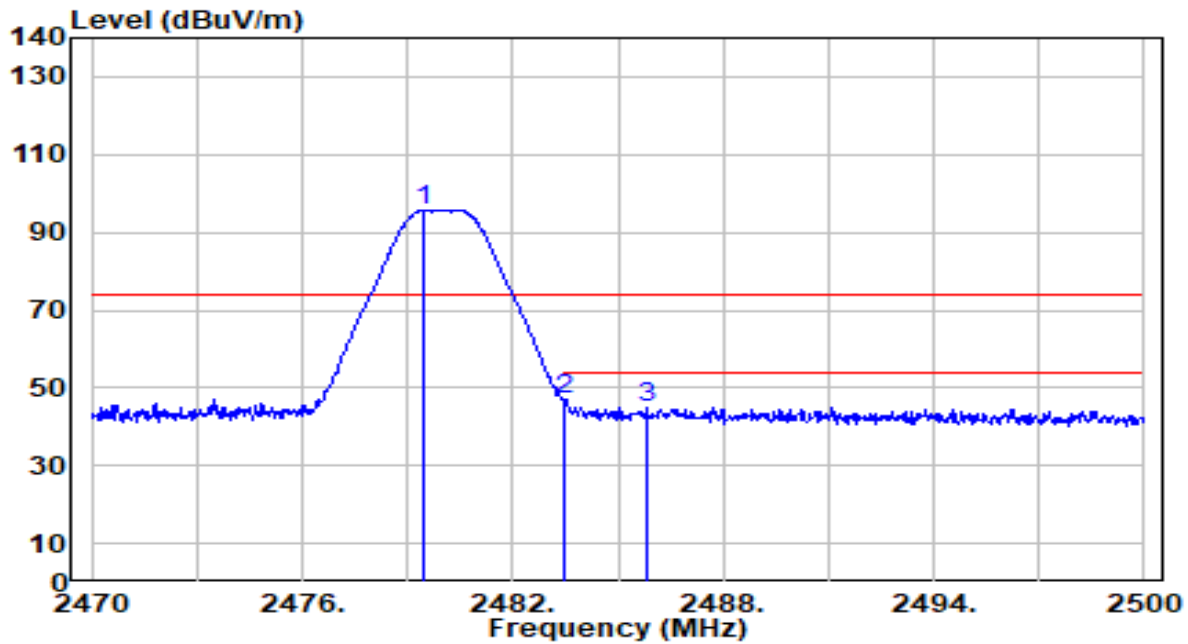

No	Frequency (MHz)	Reading (dBuV)	C.F (dB/m)	Measurement (dBuV/m)	Margin (dB)	Limit (dBuV/m)	Height (cm)	Angle (deg)	Remark (QP/PK/AV)
1	2479.480	100.99	-5.37	95.62	N/A	N/A	104	192	Peak
2	* 2483.500	52.61	-5.37	47.25	-26.75	74.00	104	192	Peak
3	2485.810	50.26	-5.36	44.89	-29.11	74.00	104	192	Peak

Note:

1. " \*", means this data is the worst emission level.
2. C.F (Correction Factor) = Antenna Factor (dB/m) + Cable Loss (dB) – Preamplifier(dB).
3. Measurement (dBuV/m) = Reading(dBuV) + C.F (Correction Factor).
4. The emission levels of other frequencies are very lower than the limit and not show in test report.



EUT	BE9300 Wi-Fi 7 Bluetooth PCIe Adapter	Date of Test	2023-11-24
Factor	DRH18-E	Temp. / Humidity	23°C /63%
Polarity	Vertical	Site / Test Engineer	AC2 / Stanley
Test Mode	BLE_2Mbps_TX_CH 39	Test Voltage	AC 120V/60Hz

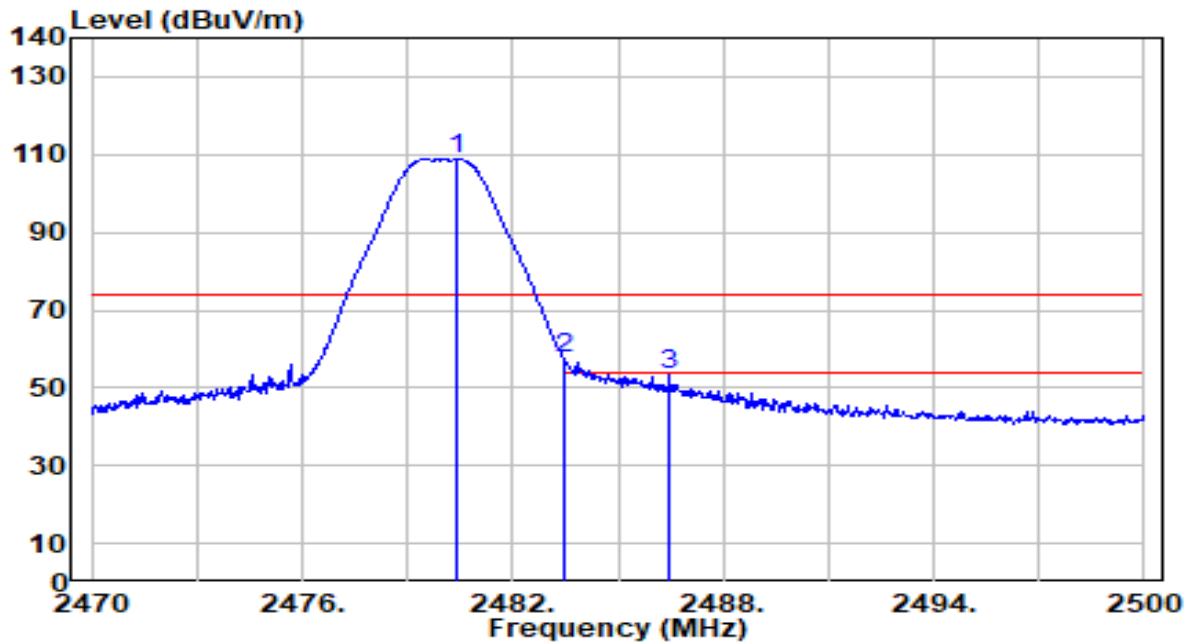

No	Frequency (MHz)	Reading (dBuV)	C.F (dB/m)	Measurement (dBuV/m)	Margin (dB)	Limit (dBuV/m)	Height (cm)	Angle (deg)	Remark (QP/PK/AV)
1	2480.440	114.15	-5.37	108.78	N/A	N/A	208	157	Peak
2	* 2483.500	62.75	-5.37	57.39	-16.61	74.00	208	157	Peak
3	2486.470	58.90	-5.36	53.53	-20.47	74.00	208	157	Peak

Note:

1. " \*", means this data is the worst emission level.
2. C.F (Correction Factor) = Antenna Factor (dB/m) + Cable Loss (dB) – Preamplifier(dB).
3. Measurement (dBuV/m) = Reading(dBuV) + C.F (Correction Factor).
4. The emission levels of other frequencies are very lower than the limit and not show in test report.

EUT	BE9300 Wi-Fi 7 Bluetooth PCIe Adapter	Date of Test	2023-11-24
Factor	DRH18-E	Temp. / Humidity	23°C /63%
Polarity	Vertical	Site / Test Engineer	AC2 / Stanley
Test Mode	BLE_2Mbps_TX_CH 39	Test Voltage	AC 120V/60Hz

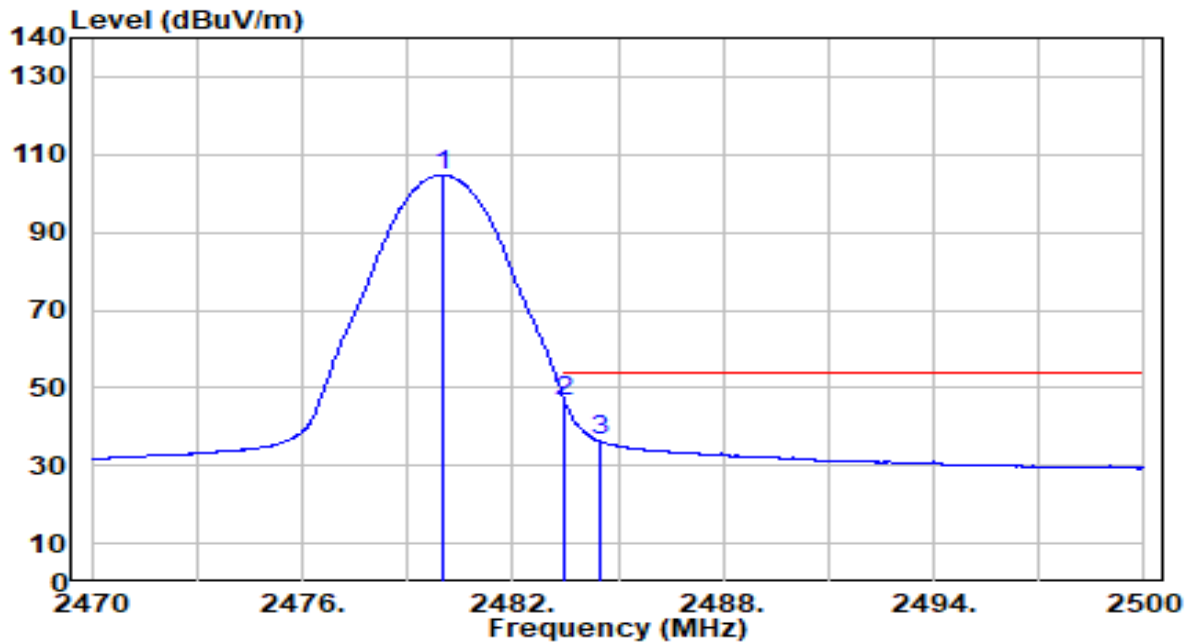

No	Frequency (MHz)	Reading (dBuV)	C.F (dB/m)	Measurement (dBuV/m)	Margin (dB)	Limit (dBuV/m)	Height (cm)	Angle (deg)	Remark (QP/PK/AV)
1	2479.990	110.09	-5.37	104.73	N/A	N/A	208	157	Average
2	* 2483.500	51.71	-5.37	46.34	-7.66	54.00	208	157	Average
3	2484.520	41.59	-5.37	36.22	-17.78	54.00	208	157	Average

Note:

1. " \*" , means this data is the worst emission level.
2. C.F (Correction Factor) = Antenna Factor (dB/m) + Cable Loss (dB) – Preamplifier(dB).
3. Measurement (dBuV/m) = Reading(dBuV) + C.F (Correction Factor).
4. The emission levels of other frequencies are very lower than the limit and not show in test report.

EUT	BE9300 Wi-Fi 7 Bluetooth PCIe Adapter	Date of Test	2023-11-24
Factor	DRH18-E	Temp. / Humidity	23°C /63%
Polarity	Horizontal	Site / Test Engineer	AC2 / Stanley
Test Mode	BLE_Coded S=2_TX_CH 0	Test Voltage	AC 120V/60Hz

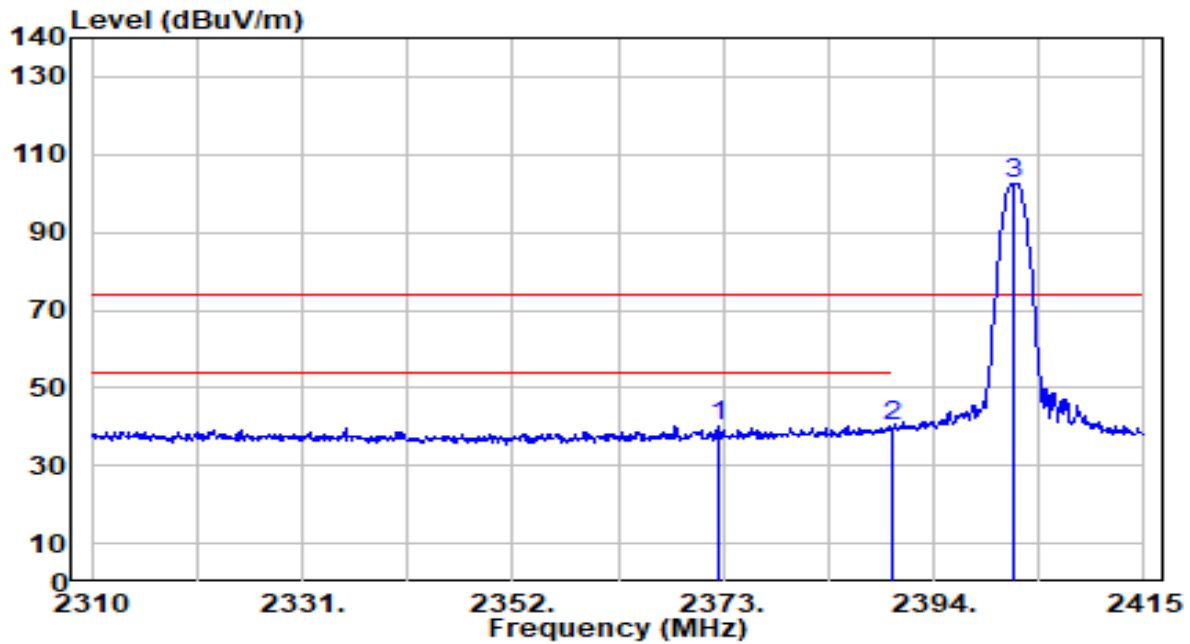

No	Frequency (MHz)	Reading (dBuV)	C.F (dB/m)	Measurement (dBuV/m)	Margin (dB)	Limit (dBuV/m)	Height (cm)	Angle (deg)	Remark (QP/PK/AV)
1	* 2372.475	45.82	-5.44	40.38	-33.62	74.00	300	122	Peak
2	2390.000	45.36	-5.41	39.95	-34.05	74.00	300	122	Peak
3	2401.980	107.89	-5.39	102.49	N/A	N/A	300	122	Peak

Note:

1. " \*", means this data is the worst emission level.
2. C.F (Correction Factor) = Antenna Factor (dB/m) + Cable Loss (dB) – Preamplifier(dB).
3. Measurement (dBuV/m) = Reading(dBuV) + C.F (Correction Factor).
4. The emission levels of other frequencies are very lower than the limit and not show in test report.

EUT	BE9300 Wi-Fi 7 Bluetooth PCIe Adapter	Date of Test	2023-11-24
Factor	DRH18-E	Temp. / Humidity	23°C /63%
Polarity	Vertical	Site / Test Engineer	AC2 / Stanley
Test Mode	BLE_Coded S=2_TX_CH 0	Test Voltage	AC 120V/60Hz

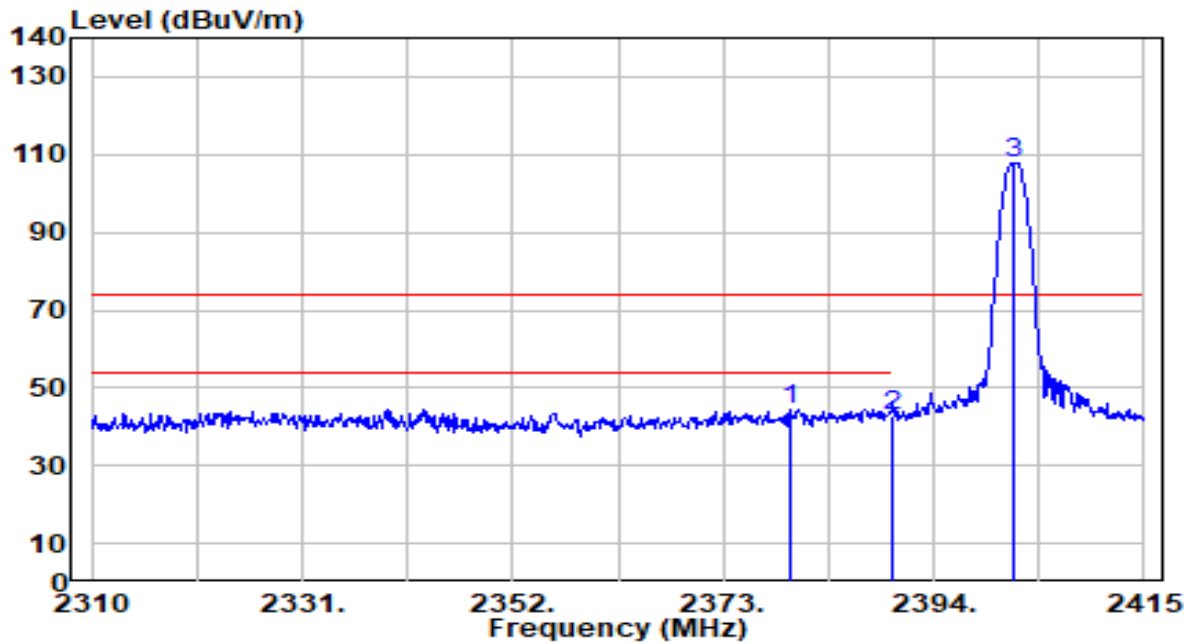

No	Frequency (MHz)	Reading (dBuV)	C.F (dB/m)	Measurement (dBuV/m)	Margin (dB)	Limit (dBuV/m)	Height (cm)	Angle (deg)	Remark (QP/PK/AV)
1	* 2379.720	50.00	-5.43	44.57	-29.43	74.00	100	160	Peak
2	2390.000	48.05	-5.41	42.64	-31.36	74.00	100	160	Peak
3	2401.875	113.14	-5.39	107.75	N/A	N/A	100	160	Peak

Note:

1. " \*", means this data is the worst emission level.
2. C.F (Correction Factor) = Antenna Factor (dB/m) + Cable Loss (dB) – Preamplifier(dB).
3. Measurement (dBuV/m) = Reading(dBuV) + C.F (Correction Factor).
4. The emission levels of other frequencies are very lower than the limit and not show in test report.

EUT	BE9300 Wi-Fi 7 Bluetooth PCIe Adapter	Date of Test	2023-11-24
Factor	DRH18-E	Temp. / Humidity	23°C /63%
Polarity	Horizontal	Site / Test Engineer	AC2 / Stanley
Test Mode	BLE_Coded S=2_TX_CH 39	Test Voltage	AC 120V/60Hz

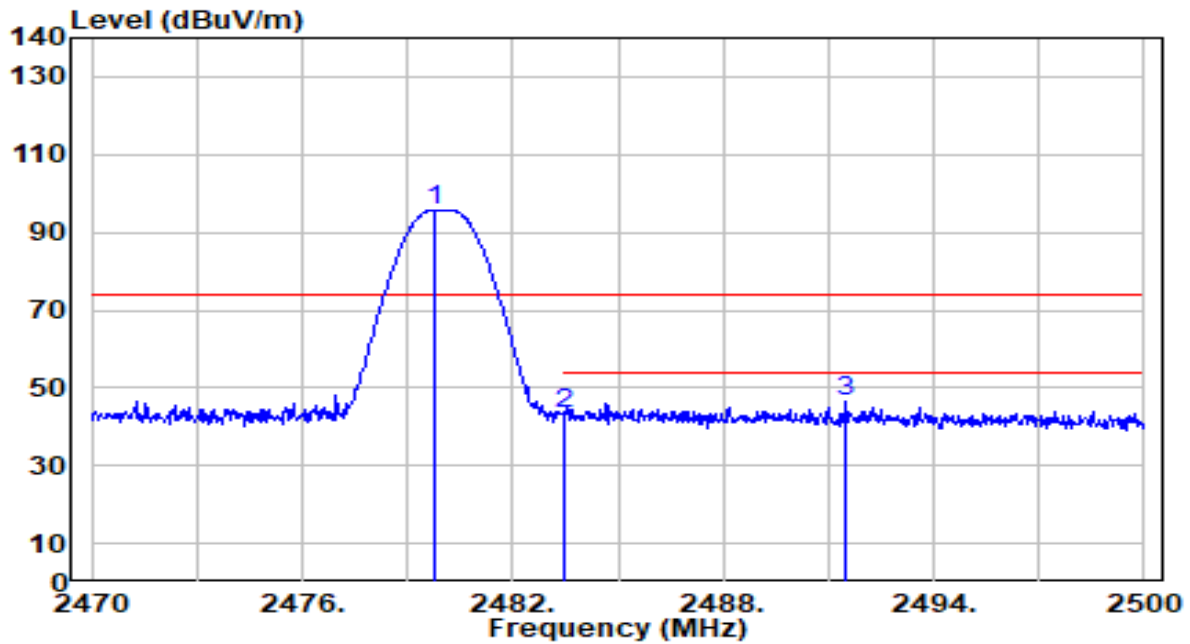

No	Frequency (MHz)	Reading (dBuV)	C.F (dB/m)	Measurement (dBuV/m)	Margin (dB)	Limit (dBuV/m)	Height (cm)	Angle (deg)	Remark (QP/PK/AV)
1	2479.810	101.22	-5.37	95.85	N/A	N/A	104	192	Peak
2	2483.500	48.63	-5.37	43.27	-30.73	74.00	104	192	Peak
3	* 2491.480	51.66	-5.36	46.30	-27.70	74.00	104	192	Peak

Note:

1. " \*", means this data is the worst emission level.
2. C.F (Correction Factor) = Antenna Factor (dB/m) + Cable Loss (dB) – Preamplifier(dB).
3. Measurement (dBuV/m) = Reading(dBuV) + C.F (Correction Factor).
4. The emission levels of other frequencies are very lower than the limit and not show in test report.

EUT	BE9300 Wi-Fi 7 Bluetooth PCIe Adapter	Date of Test	2023-11-24
Factor	DRH18-E	Temp. / Humidity	23°C /63%
Polarity	Vertical	Site / Test Engineer	AC2 / Stanley
Test Mode	BLE_Coded S=2_TX_CH 39	Test Voltage	AC 120V/60Hz

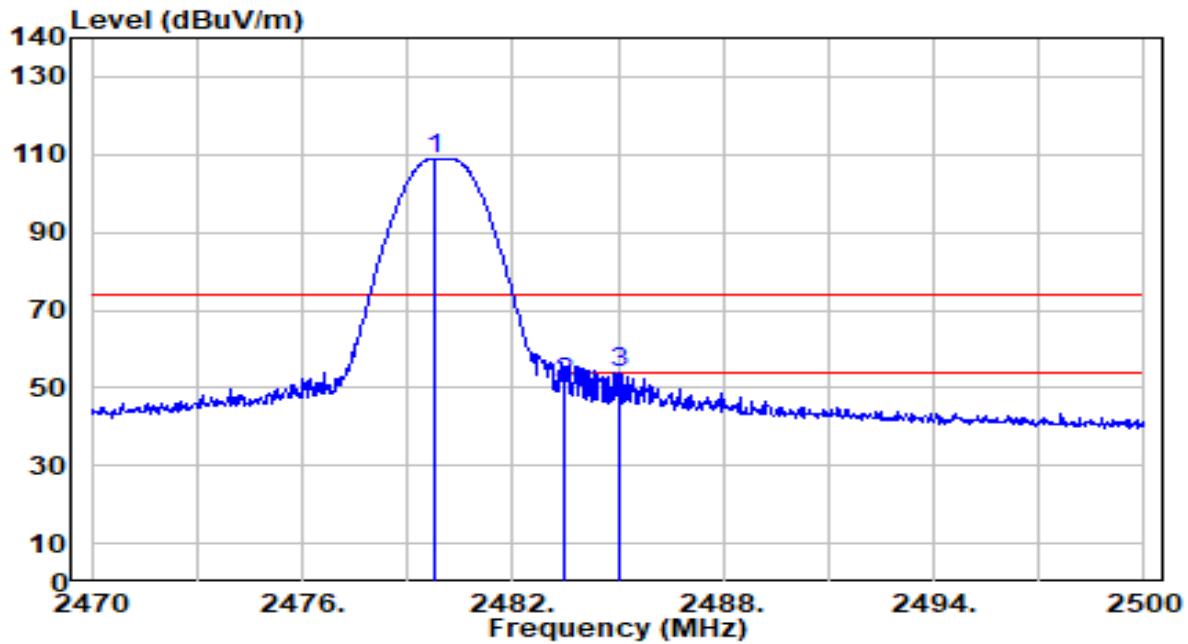

No	Frequency (MHz)	Reading (dBuV)	C.F (dB/m)	Measurement (dBuV/m)	Margin (dB)	Limit (dBuV/m)	Height (cm)	Angle (deg)	Remark (QP/PK/AV)
1	2479.810	114.38	-5.37	109.01	N/A	N/A	208	157	Peak
2	2483.500	56.73	-5.37	51.37	-22.63	74.00	208	157	Peak
3	* 2485.060	59.48	-5.37	54.12	-19.88	74.00	208	157	Peak

Note:

1. " \*" , means this data is the worst emission level.
2. C.F (Correction Factor) = Antenna Factor (dB/m) + Cable Loss (dB) – Preamplifier(dB).
3. Measurement (dBuV/m) = Reading(dBuV) + C.F (Correction Factor).
4. The emission levels of other frequencies are very lower than the limit and not show in test report.

EUT	BE9300 Wi-Fi 7 Bluetooth PCIe Adapter	Date of Test	2023-11-24
Factor	DRH18-E	Temp. / Humidity	23°C /63%
Polarity	Vertical	Site / Test Engineer	AC2 / Stanley
Test Mode	BLE_Coded S=2_TX_CH 39	Test Voltage	AC 120V/60Hz

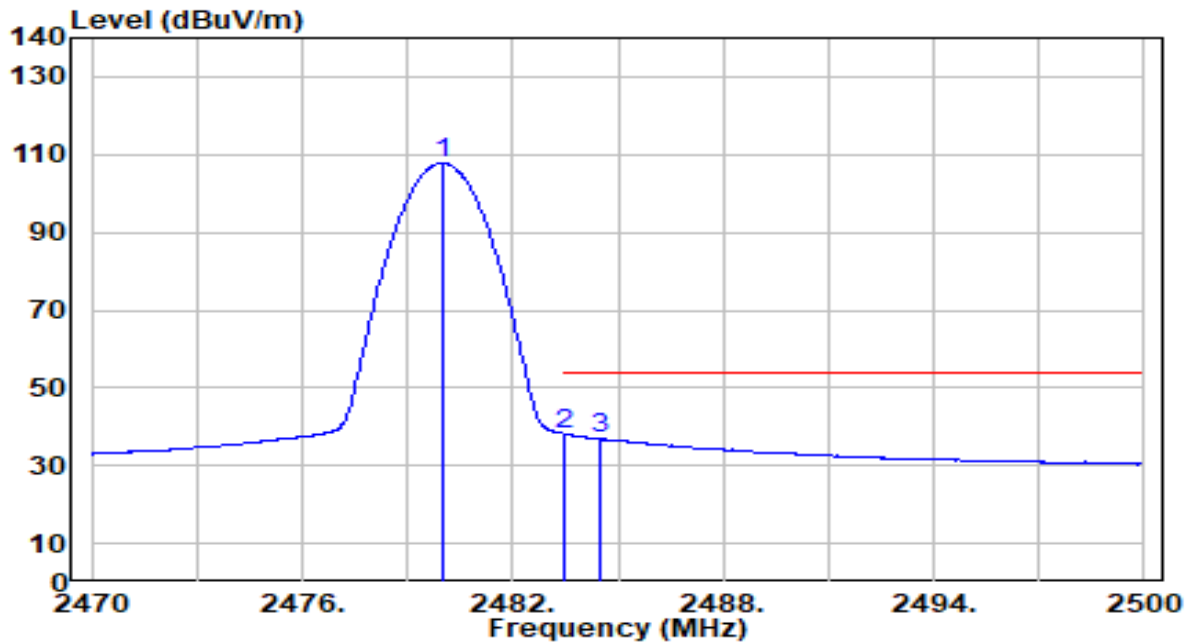

No	Frequency (MHz)	Reading (dBuV)	C.F (dB/m)	Measurement (dBuV/m)	Margin (dB)	Limit (dBuV/m)	Height (cm)	Angle (deg)	Remark (QP/PK/AV)
1	2480.020	113.20	-5.37	107.83	N/A	N/A	208	157	Average
2	* 2483.500	43.52	-5.37	38.15	-15.85	54.00	208	157	Average
3	2484.520	42.16	-5.37	36.80	-17.20	54.00	208	157	Average

Note:

1. " \*", means this data is the worst emission level.
2. C.F (Correction Factor) = Antenna Factor (dB/m) + Cable Loss (dB) – Preamplifier(dB).
3. Measurement (dBuV/m) = Reading(dBuV) + C.F (Correction Factor).
4. The emission levels of other frequencies are very lower than the limit and not show in test report.

EUT	BE9300 Wi-Fi 7 Bluetooth PCIe Adapter	Date of Test	2023-11-24
Factor	DRH18-E	Temp. / Humidity	23°C /63%
Polarity	Horizontal	Site / Test Engineer	AC2 / Stanley
Test Mode	BLE_Coded S=8_TX_CH 0	Test Voltage	AC 120V/60Hz

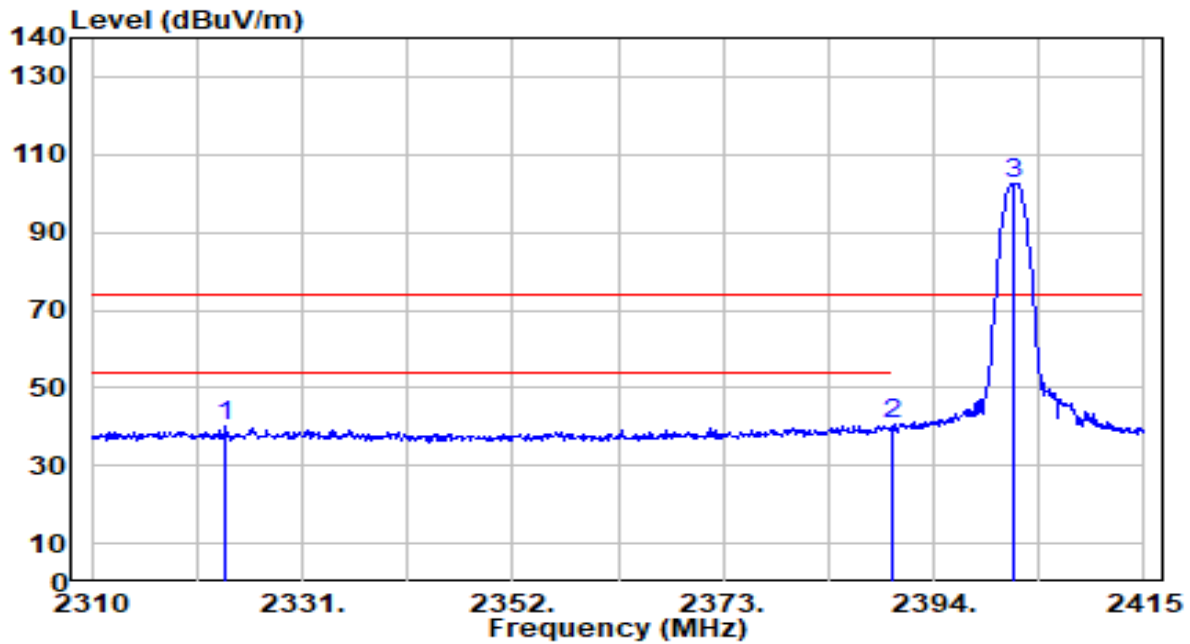

No	Frequency (MHz)	Reading (dBuV)	C.F (dB/m)	Measurement (dBuV/m)	Margin (dB)	Limit (dBuV/m)	Height (cm)	Angle (deg)	Remark (QP/PK/AV)
1	2323.440	45.94	-5.53	40.40	-33.60	74.00	300	122	Peak
2	* 2390.000	45.87	-5.41	40.46	-33.54	74.00	300	122	Peak
3	2401.875	107.93	-5.39	102.54	N/A	N/A	300	122	Peak

Note:

1. " \*" , means this data is the worst emission level.
2. C.F (Correction Factor) = Antenna Factor (dB/m) + Cable Loss (dB) – Preamplifier(dB).
3. Measurement (dBuV/m) = Reading(dBuV) + C.F (Correction Factor).
4. The emission levels of other frequencies are very lower than the limit and not show in test report.



EUT	BE9300 Wi-Fi 7 Bluetooth PCIe Adapter	Date of Test	2023-11-24
Factor	DRH18-E	Temp. / Humidity	23°C /63%
Polarity	Vertical	Site / Test Engineer	AC2 / Stanley
Test Mode	BLE_Coded S=8_TX_CH 0	Test Voltage	AC 120V/60Hz

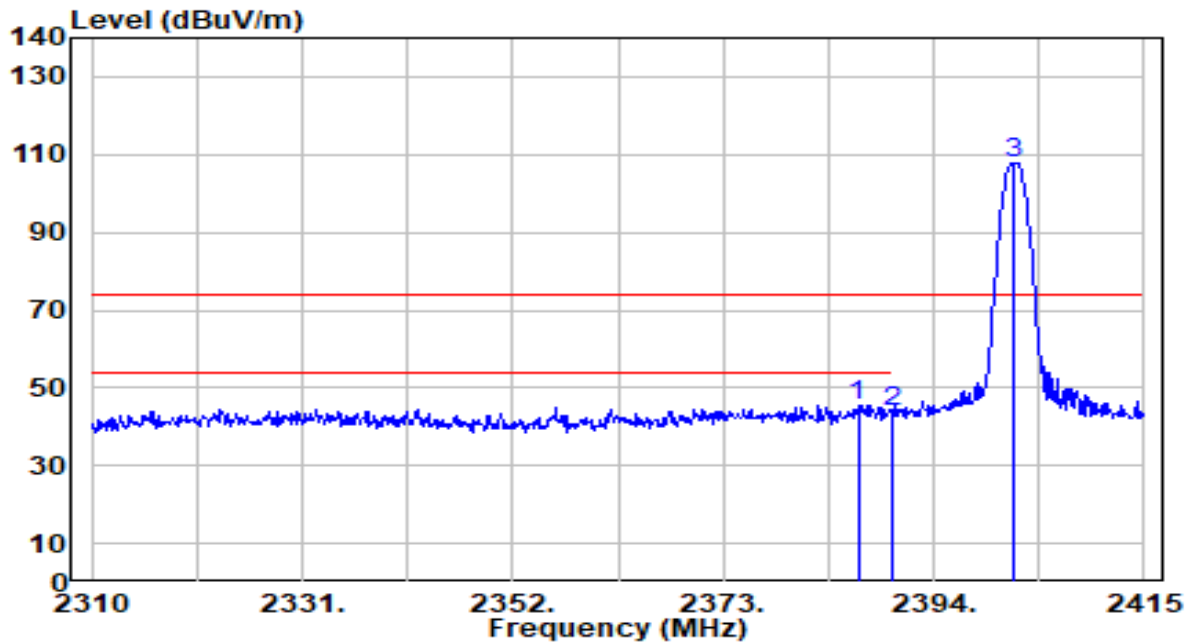

No	Frequency (MHz)	Reading (dBuV)	C.F (dB/m)	Measurement (dBuV/m)	Margin (dB)	Limit (dBuV/m)	Height (cm)	Angle (deg)	Remark (QP/PK/AV)
1	* 2386.440	51.09	-5.42	45.67	-28.33	74.00	100	160	Peak
2	2390.000	49.37	-5.41	43.95	-30.05	74.00	100	160	Peak
3	2401.875	113.08	-5.39	107.69	N/A	N/A	100	160	Peak

Note:

1. " \*", means this data is the worst emission level.
2. C.F (Correction Factor) = Antenna Factor (dB/m) + Cable Loss (dB) – Preamplifier(dB).
3. Measurement (dBuV/m) = Reading(dBuV) + C.F (Correction Factor).
4. The emission levels of other frequencies are very lower than the limit and not show in test report.

EUT	BE9300 Wi-Fi 7 Bluetooth PCIe Adapter	Date of Test	2023-11-24
Factor	DRH18-E	Temp. / Humidity	23°C /63%
Polarity	Horizontal	Site / Test Engineer	AC2 / Stanley
Test Mode	BLE_Coded S=8_TX_CH 39	Test Voltage	AC 120V/60Hz

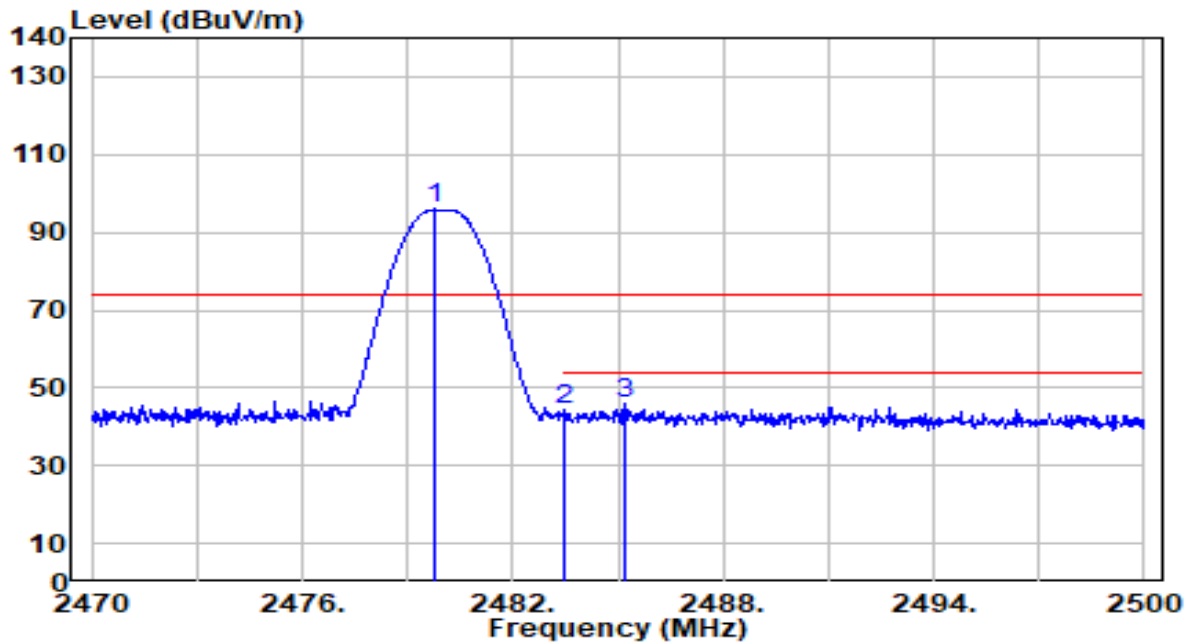

No	Frequency (MHz)	Reading (dBuV)	C.F (dB/m)	Measurement (dBuV/m)	Margin (dB)	Limit (dBuV/m)	Height (cm)	Angle (deg)	Remark (QP/PK/AV)
1	2479.810	101.26	-5.37	95.89	N/A	N/A	104	192	Peak
2	2483.500	49.49	-5.37	44.12	-29.88	74.00	104	192	Peak
3	* 2485.180	51.07	-5.37	45.70	-28.30	74.00	104	192	Peak

Note:

1. " \*", means this data is the worst emission level.
2. C.F (Correction Factor) = Antenna Factor (dB/m) + Cable Loss (dB) – Preamplifier(dB).
3. Measurement (dBuV/m) = Reading(dBuV) + C.F (Correction Factor).
4. The emission levels of other frequencies are very lower than the limit and not show in test report.

EUT	BE9300 Wi-Fi 7 Bluetooth PCIe Adapter	Date of Test	2023-11-24
Factor	DRH18-E	Temp. / Humidity	23°C /63%
Polarity	Vertical	Site / Test Engineer	AC2 / Stanley
Test Mode	BLE_Coded S=8_TX_CH 39	Test Voltage	AC 120V/60Hz

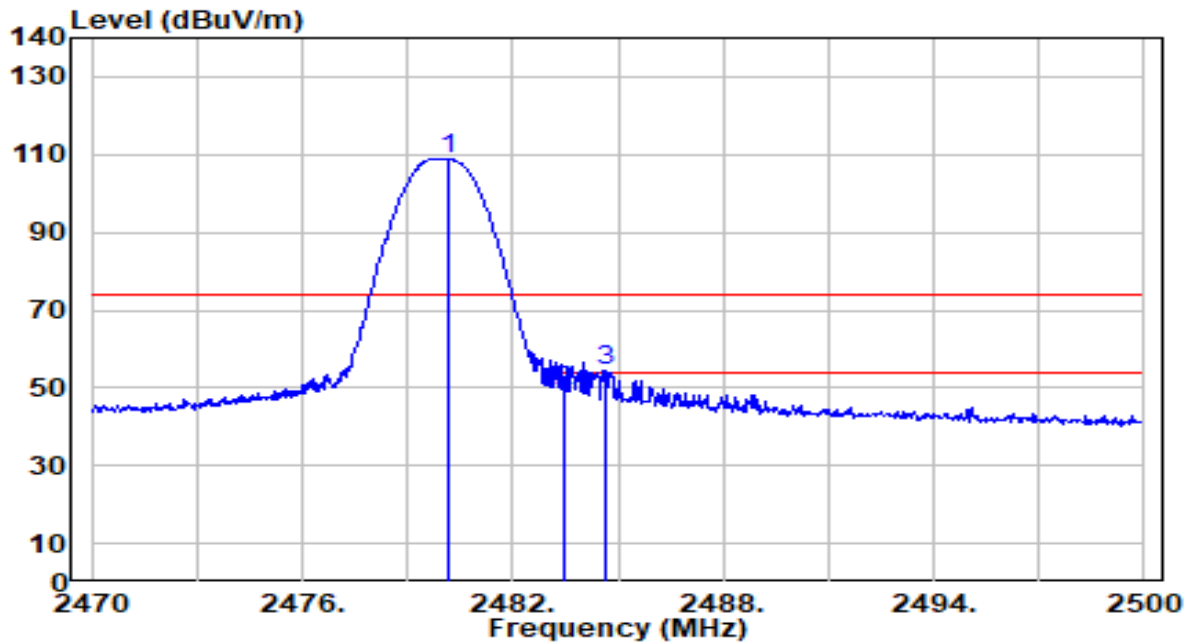

No	Frequency (MHz)	Reading (dBuV)	C.F (dB/m)	Measurement (dBuV/m)	Margin (dB)	Limit (dBuV/m)	Height (cm)	Angle (deg)	Remark (QP/PK/AV)
1	2480.170	114.20	-5.37	108.83	N/A	N/A	208	157	Peak
2	2483.500	54.64	-5.37	49.28	-24.72	74.00	208	157	Peak
3	* 2484.670	59.85	-5.37	54.49	-19.51	74.00	208	157	Peak

Note:

1. " \*", means this data is the worst emission level.
2. C.F (Correction Factor) = Antenna Factor (dB/m) + Cable Loss (dB) – Preamplifier(dB).
3. Measurement (dBuV/m) = Reading(dBuV) + C.F (Correction Factor).
4. The emission levels of other frequencies are very lower than the limit and not show in test report.

EUT	BE9300 Wi-Fi 7 Bluetooth PCIe Adapter	Date of Test	2023-11-24
Factor	DRH18-E	Temp. / Humidity	23°C /63%
Polarity	Vertical	Site / Test Engineer	AC2 / Stanley
Test Mode	BLE_Coded S=8_TX_CH 39	Test Voltage	AC 120V/60Hz

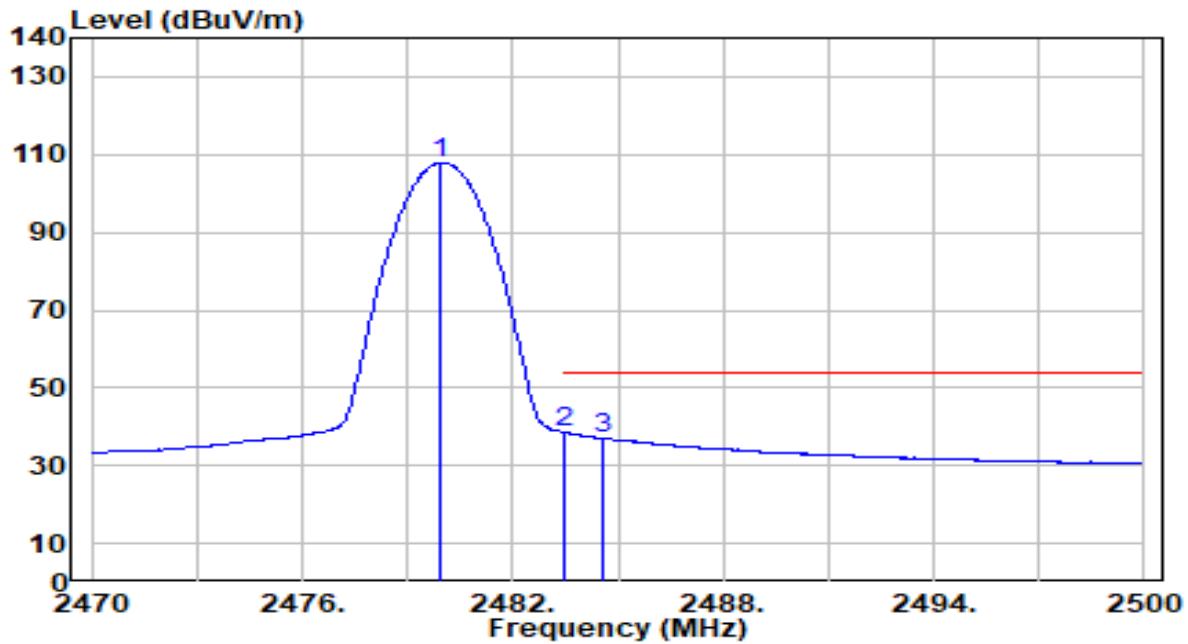

No	Frequency (MHz)	Reading (dBuV)	C.F (dB/m)	Measurement (dBuV/m)	Margin (dB)	Limit (dBuV/m)	Height (cm)	Angle (deg)	Remark (QP/PK/AV)
1	2479.930	113.40	-5.37	108.03	N/A	N/A	208	157	Average
2	* 2483.500	43.96	-5.37	38.59	-15.41	54.00	208	157	Average
3	2484.550	42.38	-5.37	37.02	-16.98	54.00	208	157	Average

Note:

1. " \*", means this data is the worst emission level.
2. C.F (Correction Factor) = Antenna Factor (dB/m) + Cable Loss (dB) – Preamplifier(dB).
3. Measurement (dBuV/m) = Reading(dBuV) + C.F (Correction Factor).
4. The emission levels of other frequencies are very lower than the limit and not show in test report.

## 7.8. AC Conducted Emissions Measurement

### 7.8.1. Test Limit

FCC Part 15 Subpart C Paragraph 15.207 / RSS-Gen Limits		
Frequency (MHz)	QP (dB $\mu$ V)	Average (dB $\mu$ V)
0.15 - 0.50	66 - 56	56 - 46
0.50 - 5.0	56	46
5.0 - 30	60	50

Note 1: The lower limit shall apply at the transition frequencies.

Note 2: The limit decreases linearly with the logarithm of the frequency in the range 0.15MHz to 0.5MHz.

### 7.8.2. Test Setup

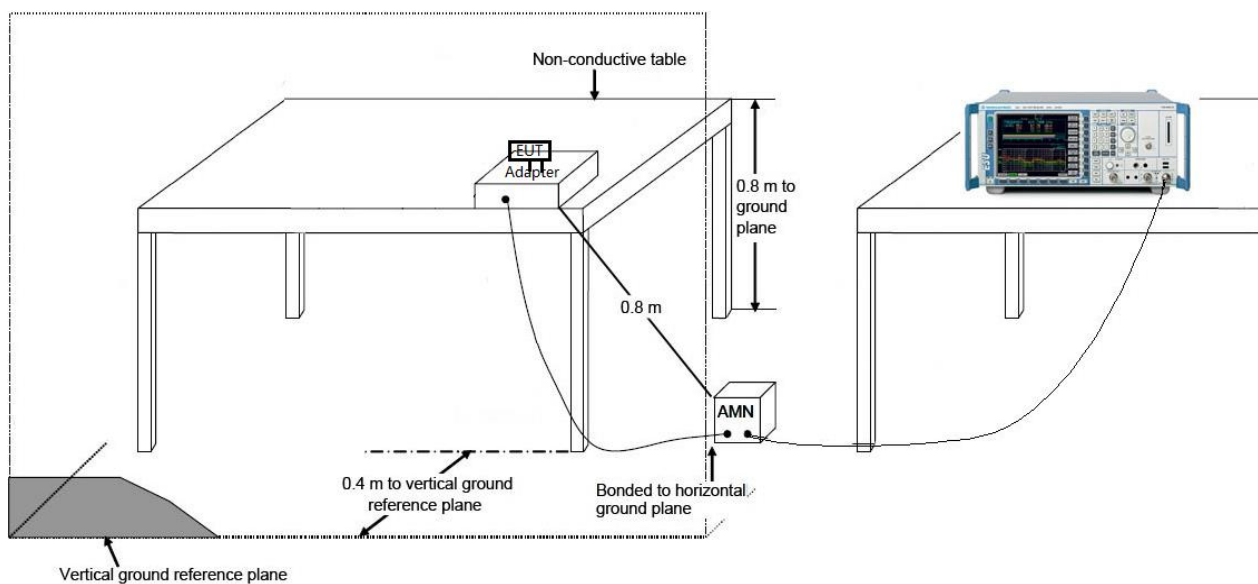

### 7.8.3. Test Result

EUT	BE9300 Wi-Fi 7 Bluetooth PCIe Adapter	Date of Test	2023-11-29
Factor	CE_ENV216-L1 (Filter ON)	Temp. / Humidity	23.2°C /45%
Polarity	Line1	Site / Test Engineer	SR2 / Bob
Test Mode	BLE_TX_1Mbps_CH 19	Test Voltage	AC 120V/60Hz

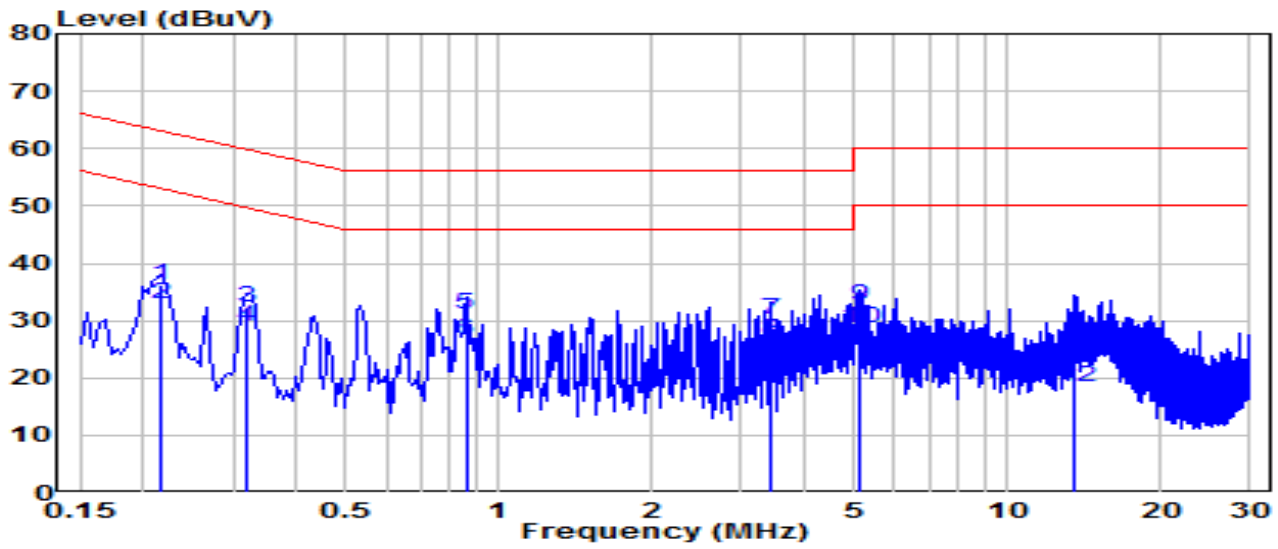

No	Frequency (MHz)	Reading (dBUV)	C.F (dB)	Measurement (dBUV)	Margin (dB)	Limit (dBUV)	Remark (QP/PK/AV)
1	0.217	26.60	9.62	36.22	-26.69	62.91	QP
2	0.217	23.24	9.62	32.86	-20.05	52.91	Average
3	0.321	22.76	9.63	32.39	-27.29	59.68	QP
4	0.321	19.49	9.63	29.12	-20.56	49.68	Average
5	* 0.861	21.40	9.66	31.07	-24.93	56.00	QP
6	* 0.861	16.89	9.66	26.55	-19.45	46.00	Average
7	3.435	20.57	9.72	30.29	-25.71	56.00	QP
8	3.435	16.70	9.72	26.42	-19.58	46.00	Average
9	5.153	22.96	9.75	32.71	-27.29	60.00	QP
10	5.153	18.92	9.75	28.67	-21.33	50.00	Average
11	13.482	14.95	9.88	24.83	-35.17	60.00	QP
12	13.482	8.46	9.88	18.34	-31.66	50.00	Average

Note:

1. " \*", means this data is the worst emission level.
2. C.F (Correction Factor) = LISN Factor (dB)+ Cable Loss (dB).
3. Measurement (dBUV) = Reading(dBUV) + C.F (Correction Factor).

EUT	BE9300 Wi-Fi 7 Bluetooth PCIe Adapter	Date of Test	2023-11-29
Factor	CE_ENV216-N (Filter ON)	Temp. / Humidity	23.2°C /45%
Polarity	Neutral	Site / Test Engineer	SR2 / Bob
Test Mode	BLE_TX_1Mbps_CH 19	Test Voltage	AC 120V/60Hz

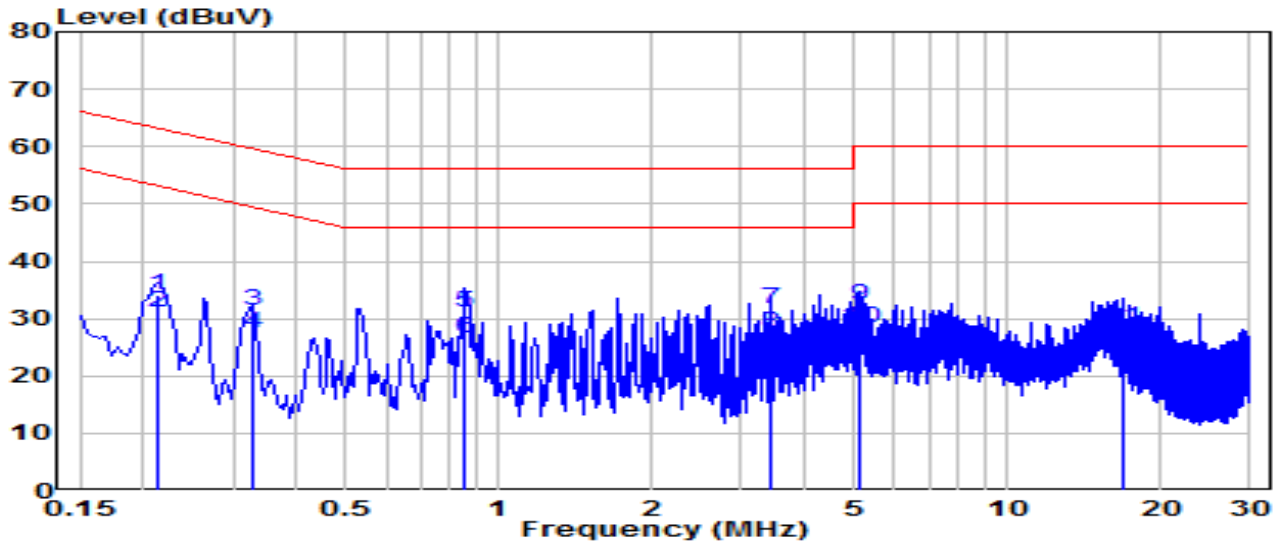

No	Frequency (MHz)	Reading (dBuV)	C.F (dB)	Measurement (dBuV)	Margin (dB)	Limit (dBuV)	Remark (QP/PK/AV)
1	0.213	24.58	9.62	34.20	-28.89	63.09	QP
2	0.213	21.34	9.62	30.97	-22.12	53.09	Average
3	0.330	21.62	9.63	31.25	-28.21	59.45	QP
4	0.330	17.90	9.63	27.53	-21.92	49.45	Average
5	0.856	21.31	9.66	30.97	-25.03	56.00	QP
6	0.856	16.80	9.66	26.46	-19.54	46.00	Average
7	* 3.439	21.86	9.72	31.57	-24.43	56.00	QP
8	* 3.439	17.74	9.72	27.46	-18.54	46.00	Average
9	5.153	22.68	9.75	32.43	-27.57	60.00	QP
10	5.153	18.54	9.75	28.29	-21.71	50.00	Average
11	16.794	18.44	9.96	28.40	-31.60	60.00	QP
12	16.794	15.19	9.96	25.15	-24.85	50.00	Average

Note:

1. " \*", means this data is the worst emission level.
2. C.F (Correction Factor) = LISN Factor (dB)+ Cable Loss (dB).
3. Measurement (dBuV) = Reading(dBuV) + C.F (Correction Factor).

EUT	BE9300 Wi-Fi 7 Bluetooth PCIe Adapter	Date of Test	2023-11-29
Factor	CE_ENV216-L1 (Filter ON)	Temp. / Humidity	23.2°C /45%
Polarity	Line1	Site / Test Engineer	SR2 / Bob
Test Mode	BLE_TX_1Mbps_CH 19	Test Voltage	AC 240V/60Hz

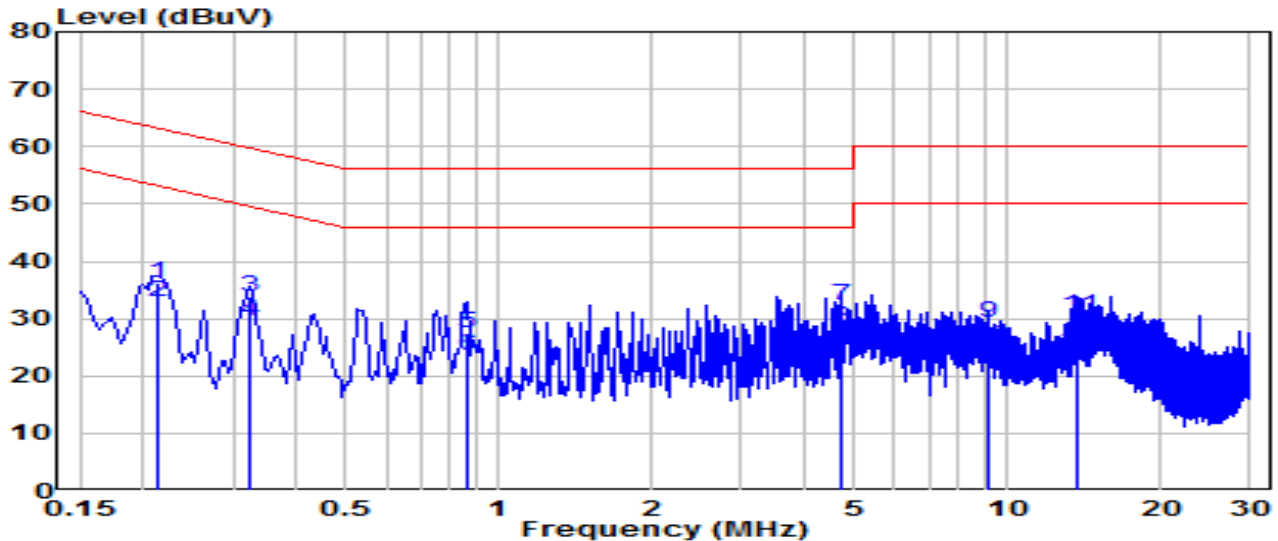

No	Frequency (MHz)	Reading (dBuV)	C.F (dB)	Measurement (dBuV)	Margin (dB)	Limit (dBuV)	Remark (QP/PK/AV)
1	0.213	26.46	9.62	36.08	-27.00	63.09	QP
2	0.213	23.18	9.62	32.80	-20.28	53.09	Average
3	0.325	24.11	9.63	33.74	-25.82	59.57	QP
4	0.325	20.03	9.63	29.66	-19.91	49.57	Average
5	0.870	17.94	9.66	27.60	-28.40	56.00	QP
6	0.870	13.80	9.66	23.46	-22.54	46.00	Average
7	* 4.726	22.52	9.74	32.26	-23.74	56.00	QP
8	* 4.726	18.68	9.74	28.42	-17.58	46.00	Average
9	9.122	19.41	9.84	29.25	-30.75	60.00	QP
10	9.122	15.21	9.84	25.05	-24.95	50.00	Average
11	13.784	20.54	9.88	30.42	-29.58	60.00	QP
12	13.784	14.24	9.88	24.12	-25.88	50.00	Average

Note:

1. " \*", means this data is the worst emission level.
2. C.F (Correction Factor) = LISN Factor (dB)+ Cable Loss (dB).
3. Measurement (dBuV) = Reading(dBuV) + C.F (Correction Factor).



EUT	BE9300 Wi-Fi 7 Bluetooth PCIe Adapter	Date of Test	2023-11-29
Factor	CE_ENV216-N (Filter ON)	Temp. / Humidity	23.2°C /45%
Polarity	Neutral	Site / Test Engineer	SR2 / Bob
Test Mode	BLE_TX_1Mbps_CH 19	Test Voltage	AC 240V/60Hz

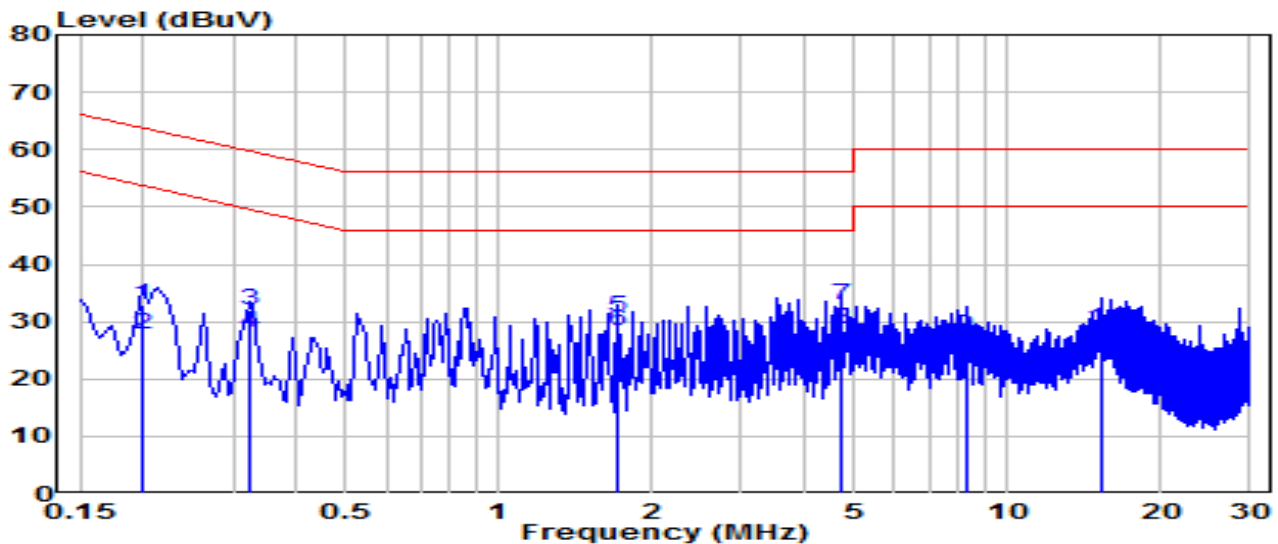

No	Frequency (MHz)	Reading (dBuV)	C.F (dB)	Measurement (dBuV)	Margin (dB)	Limit (dBuV)	Remark (QP/PK/AV)
1	0.199	23.27	9.62	32.89	-30.74	63.63	QP
2	0.199	18.26	9.62	27.89	-25.74	53.63	Average
3	0.325	22.34	9.63	31.97	-27.59	59.57	QP
4	0.325	18.58	9.63	28.21	-21.35	49.57	Average
5	1.707	21.13	9.68	30.81	-25.19	56.00	QP
6	1.707	18.61	9.68	28.30	-17.70	46.00	Average
7	* 4.726	23.11	9.74	32.86	-23.14	56.00	QP
8	* 4.726	19.04	9.74	28.79	-17.21	46.00	Average
9	8.272	17.76	9.83	27.59	-32.41	60.00	QP
10	8.272	12.72	9.83	22.54	-27.46	50.00	Average
11	15.421	18.64	9.94	28.58	-31.42	60.00	QP
12	15.421	13.82	9.94	23.76	-26.24	50.00	Average

Note:

1. " \*", means this data is the worst emission level.
2. C.F (Correction Factor) = LISN Factor (dB)+ Cable Loss (dB).
3. Measurement (dBuV) = Reading(dBuV) + C.F (Correction Factor).

## 8. CONCLUSION

The data collected relate only the item(s) tested and show that the device is in compliance with Part 15C of the FCC Rules.

## **Appendix A : Test Photograph**

Refer to “2311TW0112-UT” file.

## **Appendix B : External Photograph**

Refer to “2311TW0112-UE” file.

## **Appendix C : Internal Photograph**

Refer to “2311TW0112-UI” file.

————— The End —————