

RF MEASUREMENT REPORT

FCC ID: 2BCGWRE815XEV2
Applicant: TP-LINK CORPORATION PTE. LTD
Product: AXE5400 Tri-Band Wi-Fi 6E Range Extender
Model No.: RE815XE
Trademark: tp-link
FCC Classification: 15E 6GHz Low Power Indoor Access Point (6ID)
15E 6GHz Subordinate Indoor Device (6PP)
FCC Rule Part(s): Part 15 Subpart E (Section 15.407)
Result: Complies
Received Date: 2023-07-19
Test Date: 2023-07-31 ~ 2024-01-23

Reviewed By:

Kevin Guo

Approved By:

Robin Wu



The test results relate only to the samples tested.

This equipment has been shown to be capable of compliance with the applicable technical standards as indicated in the measurement report and was tested in accordance with the measurement procedures specified in KDB789033. Test results reported herein relate only to the item(s) tested.

The test report shall not be reproduced except in full without the written approval of MRT Technology (Suzhou) Co., Ltd.

Revision History

Report No.	Version	Description	Issue Date	Note
2307RSU051-U5	V01	Initial Report	2024-02-01	Valid

CONTENTS

Description	Page
1. General Information	6
1.1. Applicant	6
1.2. Manufacturer	6
1.3. Testing Facility	6
1.4. Product Information	7
1.5. Radio Specification under Test	7
1.6. Working Frequencies	8
1.7. Antenna Details	10
2. Test Configuration	11
2.1. Test Mode	11
2.2. Test System Connection Diagram	12
2.3. Test Software	12
2.4. Applied Standards	13
2.5. Test Environment Condition	13
3. Antenna Requirements	14
4. Measuring Instrument	15
5. Decision Rules and Measurement Uncertainty	16
5.1. Decision Rules	16
5.2. Measurement Uncertainty	16
6. Test Result	17
6.1. Summary	17
6.2. 26dB Bandwidth Measurement	18
6.2.1. Test Limit	18
6.2.2. Test Procedure	18
6.2.3. Test Setting	18
6.2.4. Test Setup	19
6.2.5. Test Result	19
6.3. Output Power Measurement	20
6.3.1. Test Limit	20
6.3.2. Test Procedure	20
6.3.3. Test Setting	20
6.3.4. Test Setup	20
6.3.5. Test Result	20
6.4. Power Spectral Density Measurement	21
6.4.1. Test Limit	21

6.4.2.	Test Procedure	21
6.4.3.	Test Setting	21
6.4.4.	Test Setup.....	22
6.4.5.	Test Result.....	22
6.5.	In-Band Emission Measurement	23
6.5.1.	Test Limit	23
6.5.2.	Test Procedure	23
6.5.3.	Test Setting.....	23
6.5.4.	Test Setup.....	24
6.5.5.	Test Result.....	24
6.6.	Frequency Stability Measurement.....	25
6.6.1.	Test Limit	25
6.6.2.	Test Procedure	25
6.6.3.	Test Setup.....	25
6.6.4.	Test Result.....	26
6.7.	Contention Based Protocol Measurement	27
6.7.1.	Test Limit	27
6.7.2.	Test Procedure	27
6.7.3.	Test Setting.....	27
6.7.4.	Test Setup.....	28
6.7.5.	Test Result.....	28
6.8.	Radiated Spurious Emission Measurement	29
6.8.1.	Test Limit	29
6.8.2.	Test Procedure	29
6.8.3.	Test Setting.....	30
6.8.4.	Test Setup.....	32
6.8.5.	Test Result.....	33
6.9.	Radiated Restricted Band Edge Measurement.....	34
6.9.1.	Test Limit	34
6.9.2.	Test Procedure	36
6.9.3.	Test Setting.....	36
6.9.4.	Test Setup.....	37
6.9.5.	Test Result.....	37
6.10.	AC Conducted Emissions Measurement.....	38
6.10.1.	Test Limit	38
6.10.2.	Test Setup.....	38
6.10.3.	Test Result.....	38
Appendix A – Test Result.....		39

A.1	Duty Cycle Test Result	39
A.2	26dB Bandwidth Test Result	41
A.3	Output Power Test Result	65
A.4	Power Spectral Density Test Result	71
A.5	In-Band Emission Measurement	115
A.6	Contention Based Protocol Test Result	183
A.7	Radiated Spurious Emission Test Result	199
A.8	Radiated Restricted Band Edge Test Result	245
A.9	AC Conducted Emissions Test Result	277
Appendix B – Test Setup Photograph		279
Appendix C – EUT Photograph		280

1. General Information

1.1. Applicant

TP-LINK CORPORATION PTE. LTD.

7 Temasek Boulevard #29-03 Suntec Tower One, Singapore 038987

1.2. Manufacturer

TP-LINK CORPORATION PTE. LTD.

7 Temasek Boulevard #29-03 Suntec Tower One, Singapore 038987

1.3. Testing Facility

<input checked="" type="checkbox"/>	Test Site – MRT Suzhou Laboratory
	Laboratory Location (Suzhou - Wuzhong) D8 Building, No.2 Tian'edang Rd., Wuzhong Economic Development Zone, Suzhou, China
	Laboratory Location (Suzhou - SIP) 4b Building, Liando U Valley, No.200 Xingpu Rd., Shengpu Town, Suzhou Industrial Park, China
	Laboratory Accreditations
	A2LA: 3628.01 CNAS: L10551 FCC: CN1166 ISED: CN0001 VCCI: <input type="checkbox"/> R-20025 <input type="checkbox"/> G-20034 <input type="checkbox"/> C-20020 <input type="checkbox"/> T-20020 <input type="checkbox"/> R-20141 <input type="checkbox"/> G-20134 <input type="checkbox"/> C-20103 <input type="checkbox"/> T-20104
<input checked="" type="checkbox"/>	Test Site – MRT Shenzhen Laboratory
	Laboratory Location (Shenzhen) 1G, Building A, Junxiangda Building, Zhongshanyuan Road West, Nanshan District, Shenzhen, China
	Laboratory Accreditations
	A2LA: 3628.02 CNAS: L10551 FCC: CN1284 ISED: CN0105
<input type="checkbox"/>	Test Site – MRT Taiwan Laboratory
	Laboratory Location (Taiwan) No. 38, Fuxing 2nd Rd., Guishan Dist., Taoyuan City 333, Taiwan (R.O.C.)
	Laboratory Accreditations
	TAF: 3261 FCC: 291082, TW3261 ISED: TW3261

1.4. Product Information

Product Name	AXE5400 Tri-Band Wi-Fi 6E Range Extender	
Model No.	RE815XE	
EUT Identification No.	20230719Sample#02 (For Radiated) 20230719Sample#01 (For Conducted)	
Wi-Fi Specification	802.11a/b/g/n/ac/ax	
Antenna Information	Refer to section 1.7	
Working Voltage	AC 100-240V~50/60Hz	
Operating Environment	<input checked="" type="checkbox"/> Indoor Use	<input type="checkbox"/> Outdoor Use
Note: The information of EUT was provided by the manufacturer, and the accuracy of the information shall be the responsibility of the manufacturer.		

1.5. Radio Specification under Test

Frequency Range	For 802.11ax-HE20: 5955 ~ 7095MHz For 802.11ax-HE40: 6125 ~ 7085MHz For 802.11ax-HE80: 6145 ~ 7025MHz For 802.11ax-HE160: 6185 ~ 6985MHz	
Type of Modulation	802.11ax: OFDMA	
Data Rate	802.11ax: up to 2402Mbps	
Channel Puncturing Function	<input type="checkbox"/> Supported	<input checked="" type="checkbox"/> Unsupported
Support RU	<input checked="" type="checkbox"/> Full RU	<input type="checkbox"/> Partial RU

1.6. Working Frequencies

802.11ax-HE20

Channel	Frequency	Channel	Frequency	Channel	Frequency
1	5955 MHz	5	5975 MHz	9	5995 MHz
13	6015 MHz	17	6035 MHz	21	6055 MHz
25	6075 MHz	29	6095 MHz	33	6115 MHz
37	6135 MHz	41	6155 MHz	45	6175 MHz
49	6195 MHz	53	6215 MHz	57	6235 MHz
61	6255 MHz	65	6275 MHz	69	6295 MHz
73	6315 MHz	77	6335 MHz	81	6355 MHz
85	6375 MHz	89	6395 MHz	93	6415 MHz
97	6435 MHz	101	6455 MHz	105	6475 MHz
109	5495 MHz	113	6515 MHz	117	6535 MHz
121	6555 MHz	125	6575 MHz	129	6595 MHz
133	6615 MHz	137	6635 MHz	141	6655 MHz
145	6675 MHz	149	6695 MHz	153	6715 MHz
157	6735 MHz	161	6755 MHz	165	6775 MHz
169	6795 MHz	173	6815 MHz	177	6835 MHz
181	6855 MHz	185	6875 MHz	189	6895 MHz
193	6915 MHz	197	6935 MHz	201	6955 MHz
205	6975 MHz	209	6995 MHz	213	7015 MHz
217	7035 MHz	221	7055 MHz	225	7075 MHz
229	7095 MHz	--	--	--	--

802.11ax-HE40

Channel	Frequency	Channel	Frequency	Channel	Frequency
3	5965 MHz	11	6005 MHz	19	6045 MHz
27	6085 MHz	35	6125 MHz	43	6165 MHz
51	6205 MHz	59	6245 MHz	67	6285 MHz
75	6325 MHz	83	6365 MHz	91	6405 MHz
99	6445 MHz	107	6485 MHz	115	6525 MHz
123	6565 MHz	131	6605 MHz	139	6645 MHz
147	6685 MHz	155	6725 MHz	163	6765 MHz
171	6805 MHz	179	6845 MHz	187	6885 MHz
195	6925 MHz	203	6965 MHz	211	7005 MHz
219	7045 MHz	227	7085 MHz		--

802.11ax-HE80

Channel	Frequency	Channel	Frequency	Channel	Frequency
7	5985 MHz	23	6065 MHz	39	6145 MHz
55	6225 MHz	71	6305 MHz	87	6385 MHz
103	6465 MHz	119	6545 MHz	135	6625 MHz
151	6705 MHz	167	6785 MHz	183	6865 MHz
199	6945 MHz	215	7025 MHz		--

802.11ax-HE160

Channel	Frequency	Channel	Frequency	Channel	Frequency
15	6025 MHz	47	6185 MHz	79	6345 MHz
111	6505 MHz	143	6665 MHz	175	6825 MHz
207	6985 MHz		--		--

1.7. Antenna Details

Antenna Type	Frequency Band (MHz)	Tx Paths	Number of spatial streams	Antenna Gain (dBi)		Beamforming Directional Gain (dBi)	CDD Directional Gain (dBi)	
				Ant 1	Ant 2		For Power	For PSD
				Dipole	2400 ~ 2483.5	2	1	3.00
5150 ~ 5850	2	1	3.00		3.00	6.01	3.00	6.01
5925 ~ 7125	2	1	2.00		2.00	5.01	2.00	5.01
		2	2.00		2.00	--	2.00	2.00

Remark:

- The EUT supports Cyclic Delay Diversity (CDD) mode, and CDD signals are correlated.
 If all antennas have the same gain, G_{ANT} , Directional gain = $G_{ANT} + \text{Array Gain}$, where Array Gain is as follows.
 - For power spectral density (PSD) measurements on all devices,
 Array Gain = $10 \log(N_{ANT}/N_{SS})$ dB;
 - For power measurements on IEEE 802.11 devices,
 Array Gain = 0 dB for $N_{ANT} \leq 4$;
- The EUT also supports Beam Forming mode, and the Beam Forming support 802.11n/ac/ax, not include 802.11a/b/g.
 BF Directional gain = $G_{ANT} + 10 \log(N_{ANT})$.
- The information as above is from the antenna report.

Test Mode	Tx Paths	CDD Mode	Beamforming Mode
802.11b/g (DTS)	2	√	X
802.11n/ax (DTS)	2	√	√
802.11a (NII)	2	√	X
802.11n/ac/ax (NII)	2	√	√
802.11ax (6ID & 6PP)	2	√	√

Remark: "√" means "Support", "X" means "Not support".

2. Test Configuration

2.1. Test Mode

CDD Mode
Mode 1: Transmit by 802.11ax-HE20_N _{SS} =1 (MCS0)
Mode 2: Transmit by 802.11ax-HE40_N _{SS} =1 (MCS0)
Mode 3: Transmit by 802.11ax-HE80_N _{SS} =1 (MCS0)
Mode 4: Transmit by 802.11ax-HE160_N _{SS} =1 (MCS0)
Mode 5: Transmit by 802.11ax-HE20_N _{SS} =2 (MCS0)
Mode 6: Transmit by 802.11ax-HE40_N _{SS} =2 (MCS0)
Mode 7: Transmit by 802.11ax-HE80_N _{SS} =2 (MCS0)
Mode 8: Transmit by 802.11ax-HE160_N _{SS} =2 (MCS0)
Beamforming Mode
Mode 9: Transmit by 802.11ax-HE20_N _{SS} =1 (MCS0)
Mode 10: Transmit by 802.11ax-HE40_N _{SS} =1 (MCS0)
Mode 11: Transmit by 802.11ax-HE80_N _{SS} =1 (MCS0)
Mode 12: Transmit by 802.11ax-HE160_N _{SS} =1 (MCS0)
Note:
<ol style="list-style-type: none"> 1. For Radiated emission, the modulation and the data rate picked for testing are determined by the Max. RF conducted power. 2. For CDD mode, this device supports 2 N_{SS}, N_{SS}=1 and N_{SS}=2 was assessed in this report. 3. Due to CDD mode was the worst mode, so all test items were evaluated in this report. The beamforming mode only evaluated the RF output power. 4. As Designated by manufacturer, the lowest data rate was the worst condition, so all the tests were done with lowest data rate.

2.2. Test System Connection Diagram

The device was tested per the guidance ANSI C63.10: 2013 was used to reference the appropriate EUT setup for radiated emissions testing and AC line conducted testing.

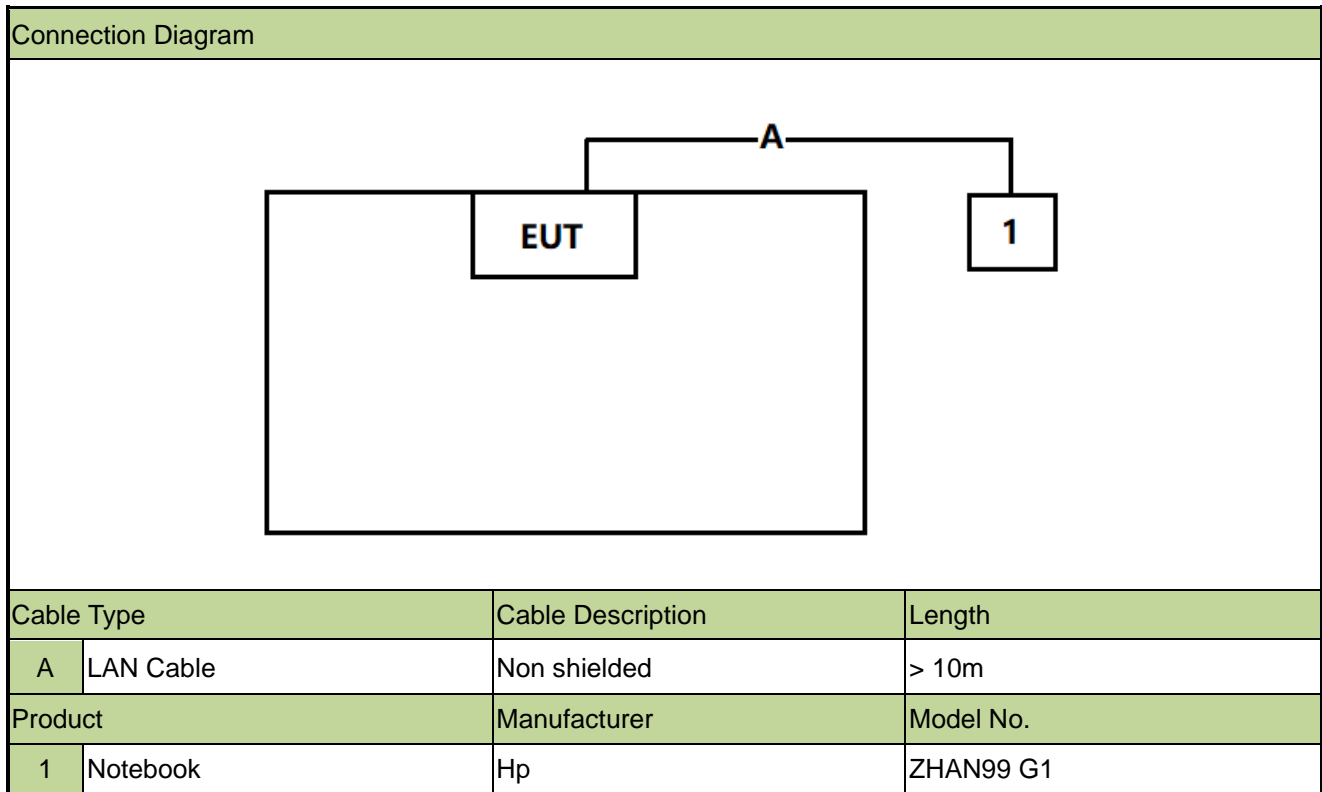

2.3. Test Software

The test utility software used during testing was “QDART”, and the version was 1.0.67.

Final power setting please refer to operational description.

2.4. Applied Standards

According to the specifications of the manufacturer, the EUT must comply with the requirements of the following standards:

- ANSI C63.10-2013
- FCC KDB 789033 D02v02r01
- FCC KDB 987594 D02v02r01
- FCC KDB 987594 D04v02
- FCC KDB 662911 D01v02r01
- FCC KDB 414788 D01v01r01
- FCC KDB 412172 D01v01r01

2.5. Test Environment Condition

Ambient Temperature	15 ~ 35°C
Relative Humidity	20 ~ 75%RH

3. Antenna Requirements

Excerpt from §15.407(a)(9) of the FCC Rules/Regulations:

Access points operating under the provisions of paragraphs (a)(5) and (a)(6) of this section must employ a permanently attached integrated antenna.

- The antenna of the device is built in and locked inside the enclosure.

Conclusion:

The device complies with the requirement of §15.407(a)(9).

4. Measuring Instrument

Instrument	Manufacturer	Model No.	Asset No.	Cali. Interval	Cali. Due Date	Test Site
USB Power Sensor	Keysight	U2021XA	MRTSUE06581	1 year	2024-06-30	NS-TR2
Thermohygrometer	DELI	NO.8813	MRTSUE06783	1 year	2024-12-05	NS-TR2
Horn Antenna	Schwarzbeck	BBHA 9170	MRTSUE06292	1 year	2024-10-21	NS-AC1
Anechoic Chamber	BOOMWAVE	NS-AC1	MRTSUE06496	1 year	2024-07-12	NS-AC1
Horn Antenna	Schwarzbeck	BBHA 9120D	MRTSUE06572	1 year	2024-03-31	NS-AC1
TRILOG Antenna	Schwarzbeck	VULB 9162	MRTSUE06573	1 year	2024-06-09	NS-AC1
Preamplifier	Schwarzbeck	BBV 9718	MRTSUE06574	1 year	2024-07-07	NS-AC1
EMI Test Receiver	R&S	ESR3	MRTSUE06575	1 year	2024-06-18	NS-AC1
Preamplifier	EMCI	EMC184045SE	MRTSUE06641	1 year	2024-01-12	NS-AC1
Thermohygrometer	testo	608-H1	MRTSUE11020	1 year	2024-05-03	NS-AC1
Signal Analyzer	Agilent	N9010A	MRTSUE06195	1 year	2024-12-10	NS-AC1/NS-TR2
Signal Analyzer	Keysight	N9020A	MRTSUE10065	1 year	2024-12-10	NS-AC1/NS-TR2
EMI Test Receiver	R&S	ESR7	MRTSUE06001	1 year	2024-12-17	WZ-AC1
Loop Antenna	Schwarzbeck	FMZB 1519	MRTSUE06025	1 year	2024-09-17	WZ-AC1
Thermohygrometer	testo	608-H1	MRTSUE11039	1 year	2024-10-25	WZ-AC1
Attenuator	MVE	MVE2213	MRTSUE11063	1 year	2024-06-08	NS
Attenuator	MVE	MVE2213	MRTSUE11064	1 year	2024-06-08	NS
Attenuator	MVE	MVE2213	MRTSUE11065	1 year	2024-06-08	NS
Attenuator	MVE	MVE2213	MRTSUE11066	1 year	2024-06-08	NS
Attenuator	MVE	MVE2213	MRTSUE11067	1 year	2024-06-08	NS
Shielding Room	BOOMWAVE	NS-SR2	MRTSUE06551	5 years	2024-06-03	NS-SR2
EMI Test Receiver	R&S	ESL3	MRTSUE06576	1 year	2024-06-18	NS-SR2
Two-Line V-Network	R&S	ENV216	MRTSUE06577	1 year	2024-04-25	NS-SR2
Two-Line V-Network	R&S	ENV216	MRTSUE06578	1 year	2024-04-25	NS-SR2
Thermohygrometer	testo	608-H1	MRTSUE11106	1 year	2024-05-03	NS-SR2
Frequency extender for EXG or MXG	Keysight	N5182BX07	MRTSUE06984	1 year	2024-02-29	WZ-SR4
Signal Generator	Keysight	N5182B	MRTSUE06451	1 year	2024-06-29	WZ-SR4
Signal Analyzer	Keysight	N9010B	MRTSUE06457	1 year	2024-05-23	WZ-SR4

Software	Version	Function
EMI Software	V3.0.0	EMI Test Software
Agilent Power Panel	V 3.9	Power
Controller_T-E-TAC-2	1.02	RE Antenna & Turntable
Controller_MF 7802	2.03C	RE Antenna & Turntable

5. Decision Rules and Measurement Uncertainty

5.1. Decision Rules

The Decision Rule is based on Simple Acceptance in accordance with ISO Guide 98-4: 2012 Clause 8.2. (Measurement uncertainty is not taken into account when stating conformity with a specified requirement.)

5.2. Measurement Uncertainty

Where relevant, the following test uncertainty levels have been estimated for tests performed on the EUT as specified in CISPR 16-4-2. This uncertainty represents an expanded uncertainty expressed at approximately the 95% confidence level using a coverage factor of $k = 2$.

AC Conducted Emission Measurement
The maximum measurement uncertainty is evaluated as: 9kHz~150kHz: 3.58dB 150kHz~30MHz: 3.20dB
Radiated Emission Measurement
The maximum measurement uncertainty is evaluated as: Coaxial: 9kHz~30MHz: 2.61dB Coplanar: 9kHz~30MHz: 2.62dB Horizontal: 30MHz~200MHz: 3.79dB 200MHz~1GHz: 3.91dB 1GHz~40GHz: 4.99dB Vertical: 30MHz~200MHz: 4.06dB 200MHz~1GHz: 5.21dB 1GHz~40GHz: 4.90dB
Spurious Emissions, Conducted
Measuring Uncertainty for a Level of Confidence of 95% ($U=2Uc(y)$): 2.2dB
Output Power
Measuring Uncertainty for a Level of Confidence of 95% ($U=2Uc(y)$): 1.4dB
Power Spectrum Density
Measuring Uncertainty for a Level of Confidence of 95% ($U=2Uc(y)$): 2.2dB
Occupied Bandwidth
Measuring Uncertainty for a Level of Confidence of 95% ($U=2Uc(y)$): 2.7%

6. Test Result

6.1. Summary

FCC Section(s)	Test Description	Test Condition	Verdict
15.407(a)(10)	Channel Bandwidth	Conducted	Pass
15.407(a)(5)	Maximum Equivalent Isotropically Radiated Power (EIRP)		Pass
15.407(a)(5)	Maximum Power Spectral Density (EIRP)		Pass
15.407(b)(7)	In-Band Emission		Pass
15.407(g)	Frequency Stability		Pass
15.407(d)(6)	Contention-Based Protocol		Pass
15.407(b)(6)	Unwanted Emissions	Radiated	Pass
15.407(b)(9), (10)	General Field Strength (Restricted Bands and Radiated Emission)		Pass
15.207	AC Conducted Emissions 150kHz - 30MHz	Line Conducted	Pass

Notes:

- The analyzer plots shown in this section were all taken with a correction table loaded into the analyzer. The correction table was used to account for the losses of the cables and attenuators used as part of the system to connect the EUT to the analyzer at all frequencies of interest.
- For radiated emission tests, every axis (X, Y, Z) was also verified. The test results shown in the following sections represent the worst-case emissions.

6.2. 26dB Bandwidth Measurement

6.2.1. Test Limit

The maximum transmitter channel bandwidth for U–NII devices in the 5.925–7.125 GHz band is 320 megahertz.

6.2.2. Test Procedure

KDB 789033 D02v02r01- Section II)C)1) (26dB Bandwidth)

KDB 789033 D02v02r01- Section II)D) (99% Bandwidth)

6.2.3. Test Setting

26dB Bandwidth

1. The analyzers' automatic bandwidth measurement capability was used to perform the 26dB bandwidth
2. RBW = approximately 1% of the emission bandwidth.
3. VBW > RBW
4. Detector = Peak.
5. Trace mode = max hold.
6. Measure the maximum width of the emission that is 26 dB down from the maximum of the emission.
Compare this with the RBW setting of the analyzer. Readjust RBW and repeat measurement as needed until the RBW/EBW ratio is approximately 1%.

99% Bandwidth

1. Set center frequency to the nominal EUT channel center frequency.
2. RBW = 1% to 5% of the OBW
3. VBW $\geq 3 \times$ RBW
4. Span = 1.5 times to 5 times the OBW
5. Detector = peak
6. Trace mode = max hold
7. Allow the trace to stabilize
8. Use the 99% power bandwidth function of the instrument.

6.2.4. Test Setup

Spectrum Analyzer

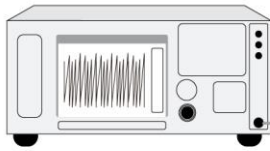

DC Block
&
Attenuator



6.2.5. Test Result

Refer to Appendix A.2.

6.3. Output Power Measurement

6.3.1. Test Limit

For an indoor access point operating in the 5.925-7.125 GHz band, the maximum EIRP over the frequency band of operation must not exceed 30 dBm.

For a subordinate device operating under the control of an indoor access point in the 5.925-7.125 GHz band, the maximum EIRP over the frequency band of operation must not exceed 30 dBm.

6.3.2. Test Procedure

KDB 789033D02v02r01- Section II)E)3)b) Method PM-G

6.3.3. Test Setting

Average Power Measurement

Average power measurements were performed only when the EUT was transmitting at its maximum power control level using a broadband power meter with a pulse sensor. The power meter implemented triggering and gating capabilities which were set up such that power measurements were recorded only during the ON time of the transmitter.

6.3.4. Test Setup

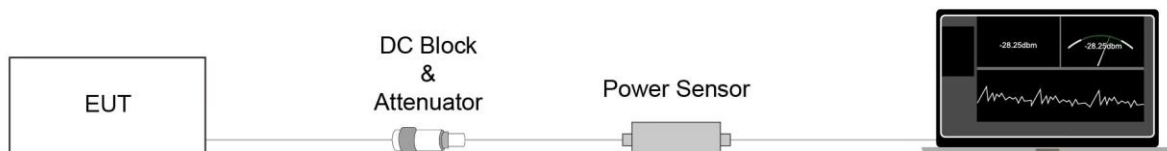

6.3.5. Test Result

Refer to Appendix A.3

6.4. Power Spectral Density Measurement

6.4.1. Test Limit

For an indoor access point operating in the 5.925-7.125 GHz band, the maximum power spectral density must not exceed 5 dBm EIRP in any 1-megahertz band.

For a subordinate device operating under the control of an indoor access point in the 5.925-7.125 GHz band, the maximum power spectral density must not exceed 5 dBm EIRP in any 1-megahertz band.

6.4.2. Test Procedure

KDB 789033 D02v02r01-Section II)F)

6.4.3. Test Setting

1. Analyzer was set to the center frequency of the UNII channel under investigation
2. Span was set to encompass the entire 26dB EBW of the signal.
3. RBW = 1MHz
4. VBW = 3MHz
5. Number of sweep points $\geq 2 \times (\text{span} / \text{RBW})$
6. Detector = power averaging (Average)
7. Sweep time = auto
8. Trigger = free run
9. Trace average at least 100 traces in power averaging (rms) mode; however, the number of traces to be averaged shall be increased above 100 as needed to ensure that the average accurately represents the true average over the on and off periods of the transmitter.
10. Use the peak search function on the instrument to find the peak of the spectrum and record its value.
11. Add $10 \cdot \log(1/x)$, where x is the duty cycle, to the measured power in order to compute the average power during the actual transmission times (because the measurement represents an average over both the on and off times of the transmission). For example, add $10 \cdot \log(1/0.25) = 6$ dB if the duty cycle is 25 percent.

6.4.4. Test Setup

Spectrum Analyzer

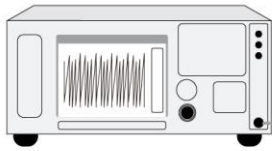

DC Block
&
Attenuator



6.4.5. Test Result

Refer to Appendix A.4

6.5. In-Band Emission Measurement

6.5.1. Test Limit

Suppressed by 20 dB at 1 MHz outside of the channel edge.

(The channel edge is defined as the 26-dB point on either side of the carrier center frequency.)

Suppressed by 28 dB at one channel bandwidth from the channel center.

Suppressed by 40 dB at one- and one-half times the channel bandwidth from the channel center.

6.5.2. Test Procedure

KDB 987594 D02v02r01- Section II)J)

6.5.3. Test Setting

Emissions Mask Reference Level Measurement

1. Set the span to encompass the entire 26 dB EBW of the signal.
2. Set RBW = same RBW used for 26 dB EBW measurement.
3. Set VBW $\geq 3 \times$ RBW.
4. Number of points in sweep $\geq [2 \times \text{span} / \text{RBW}]$.
5. Sweep time = auto.
6. Detector = RMS.
7. Trace average at least 100 traces in power averaging (rms) mode.
8. Use the peak search function on the instrument to find the peak of the spectrum.

In-Band Emission

1. Using the measuring equipment limit line function, develop the emissions mask based on rule.
2. Adjust the span to encompass the entire mask as necessary.
3. Clear trace.
4. Trace average at least 100 traces in power averaging (rms) mode.
5. Adjust the reference level as necessary so that the crest of the channel touches the top of the emission mask.

6.5.4. Test Setup

Spectrum Analyzer

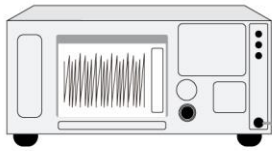

DC Block
&
Attenuator



6.5.5. Test Result

Refer to Appendix A.5

6.6. Frequency Stability Measurement

6.6.1. Test Limit

Manufactures of U-NII devices are responsible for ensuring frequency stability such that an emission is maintained within the band of operation under all conditions of normal operation as specified in the user's manual.

6.6.2. Test Procedure

Frequency Stability Under Temperature Variations:

The equipment under test was connected to an external AC or DC power supply and input rated voltage. RF output was connected to a frequency counter or spectrum analyzer via feed through attenuators. The EUT was placed inside the temperature chamber. Set the spectrum analyzer RBW low enough to obtain the desired frequency resolution and measure EUT 20°C operating frequency as reference frequency. Turn EUT off and set the chamber temperature to highest. After the temperature stabilized for approximately 30 minutes recorded the frequency. Repeat step measure with 10°C decreased per stage until the lowest temperature reached.

Frequency Stability Under Voltage Variations:

Set chamber temperature to 20°C. Use a variable AC power supply / DC power source to power the EUT and set the voltage to rated voltage. Set the spectrum analyzer RBW low enough to obtain the desired frequency resolution and recorded the frequency.

Reduce the input voltage to specify extreme voltage variation ($\pm 15\%$) and endpoint, record the maximum frequency change.

6.6.3. Test Setup

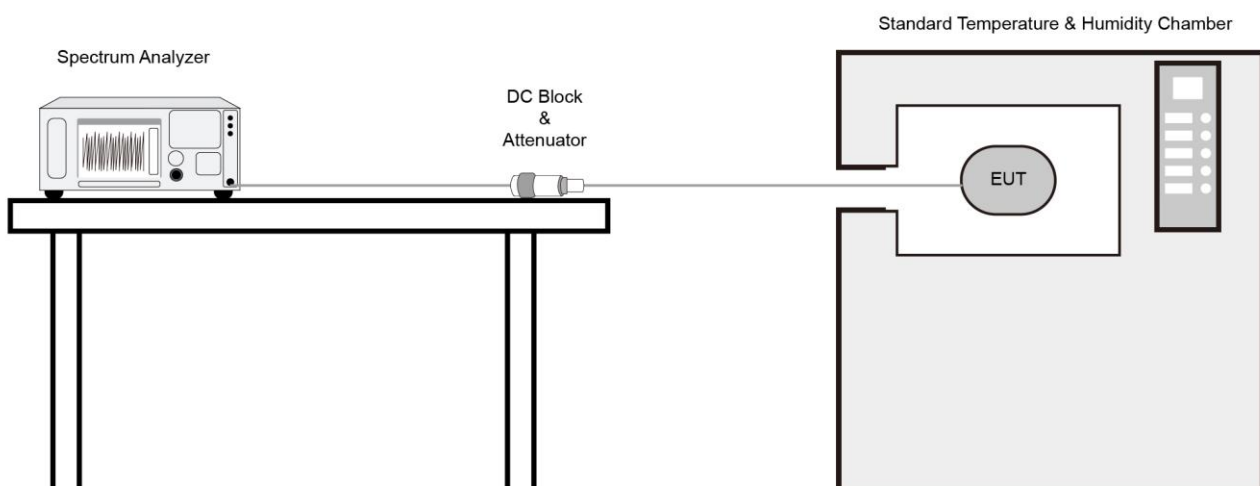

6.6.4. Test Result

Grantee ensure that the product meets e-CFR Title 47 section 15.407(g) and KDB 789033 D02v02r01 frequency stability such that the emissions are maintained within the band of operation under all conditions of normal operation as specified in the user's manual.

6.7. Contention Based Protocol Measurement

6.7.1. Test Limit

Unlicensed indoor low power device must detect co-channel radio frequency power that is at least -62dBm (The threshold is referenced to a 0dBi antenna gain.) or low.

Indoor low power device must detect an AWGN signal with 90% (or better) level of certainty.

6.7.2. Test Procedure

KDB 987594 D02v02r01- Section II(I)

6.7.3. Test Setting

1. Configure the EUT to transmit with a constant duty cycle.
2. Set the operating parameters of the EUT including power level, operating frequency, modulation and bandwidth.
3. Set the signal analyzer center frequency to the nominal EUT channel center frequency. The span range of the signal analyzer shall be between two times and five times the OBW of the EUT.
Connect the output port of the EUT to the signal analyzer 2. Ensure that the attenuator 2 provides enough attenuation to not overload the signal analyzer 2 receiver.
4. Monitoring the signal analyzer 2, verify the EUT is operating and transmitting with the parameters set at step two.
5. Using an AWGN signal source, generate a 10 MHz-wide AWGN signal. Use Table 1 of KDB 987594 to determine the center frequency of the 10 MHz AWGN signal relative to the EUT's channel bandwidth and center frequency.
6. Set the AWGN signal power to an extremely low level. Connect the AWGN signal source, via a 3-dB splitter, to the signal analyzer 1 and the EUT as shown in below figure.
7. Transmit the AWGN signal (RF ON) and verify its characteristics on the signal analyzer 1.
8. Monitor the signal analyzer 2 to verify if the AWGN signal has been detected and the EUT has ceased transmission. If the EUT continues to transmit, then incrementally increase the AWGN signal power level until the EUT stops transmitting.
9. Determine and record the AWGN signal power level (at the EUT's antenna port) at which the EUT ceased transmission. Repeat the procedure at least 10 times to verify the EUT can detect an AWGN signal with 90% (or better) level of certainty.
10. Refer to Table 1 to determine number of times the detection threshold testing needs to be repeated. If

testing is required more than once, then go back to step 5, choose a different center frequency for the AWGN signal and repeat the process.

6.7.4. Test Setup

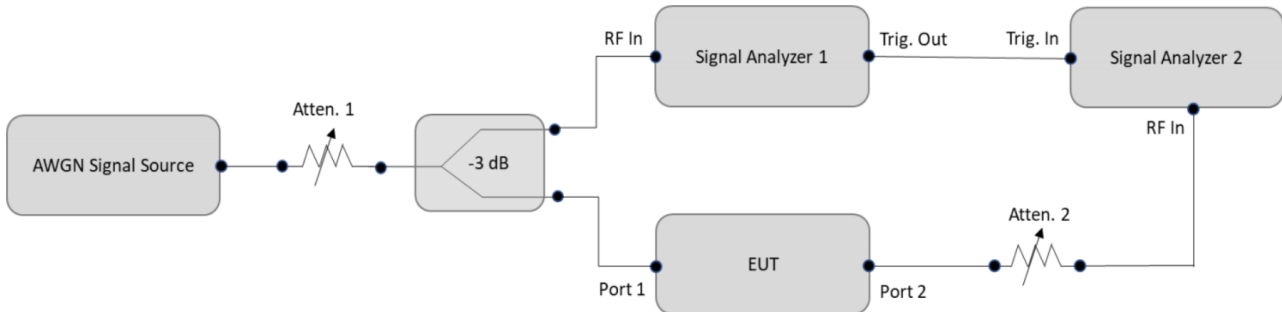

6.7.5. Test Result

Refer to Appendix A.6.

6.8. Radiated Spurious Emission Measurement

6.8.1. Test Limit

For 15.407(b)(5) requirement

For transmitters operating within the 5.925-7.125 GHz band: Any emissions outside of the 5.925-7.125 GHz band must not exceed an EIRP. of -27 dBm/MHz.

Refer to 987594 D02 U-NII 6GHz EMC Measurement v01 clause G

Use guidance in KDB 789033 for measurements below 1000 MHz and above 1000 MHz. Unwanted emissions outside of restricted bands are measured with a RMS detector. In addition, 15.35(b) applies where the peak emissions must be limited to no more than 20 dB above the average limit.

All out of band emissions appearing in a restricted band as specified in Section 15.205 of the Title 47CFR must not exceed the limits shown in Table per Section 15.209.

FCC Part 15 Subpart C Paragraph 15.209		
Frequency [MHz]	Field Strength [uV/m]	Measured Distance [Meters]
0.009 - 0.490	2400/F (kHz)	300
0.490 - 1.705	24000/F (kHz)	30
1.705 - 30	30	30
30 - 88	100	3
88 - 216	150	3
216 - 960	200	3
Above 960	500	3

6.8.2. Test Procedure

KDB 789033 D02v02r01-Section II)G)

6.8.3. Test Setting

Table 1 - RBW as a function of frequency

Frequency	RBW
9 ~ 150 kHz	200 ~ 300 Hz
0.15 ~ 30 MHz	9 ~ 10 kHz
30 ~ 1000 MHz	100 ~ 120 kHz
> 1000MHz	1MHz

Quasi-Peak Measurements below 1GHz

1. Analyzer center frequency was set to the frequency of the radiated spurious emission of interest
2. Span was set greater than 1MHz
3. RBW = as specified in Table 1
4. Detector = CISPR quasi-peak
5. Sweep time = auto couple
6. Trace was allowed to stabilize

Peak Measurements above 1GHz

1. Analyzer center frequency was set to the frequency of the radiated spurious emission of interest
2. RBW = 1MHz
3. VBW = 3MHz
4. Detector = peak
5. Sweep time = auto couple
6. Trace mode = max hold
7. Trace was allowed to stabilize

Average Measurements above 1GHz (Method VB)

1. Analyzer center frequency was set to the frequency of the radiated spurious emission of interest
2. RBW = 1MHz
3. VBW; If the EUT is configured to transmit with duty cycle $\geq 98\%$, set VBW = 10 Hz.
If the EUT duty cycle is $< 98\%$, set VBW $\geq 1/T$. T is the minimum transmission duration.
4. Detector = Peak
5. Sweep time = auto
6. Trace mode = max hold
7. Trace was allowed to stabilize

6.8.4. Test Setup

Below 30MHz Test Setup:

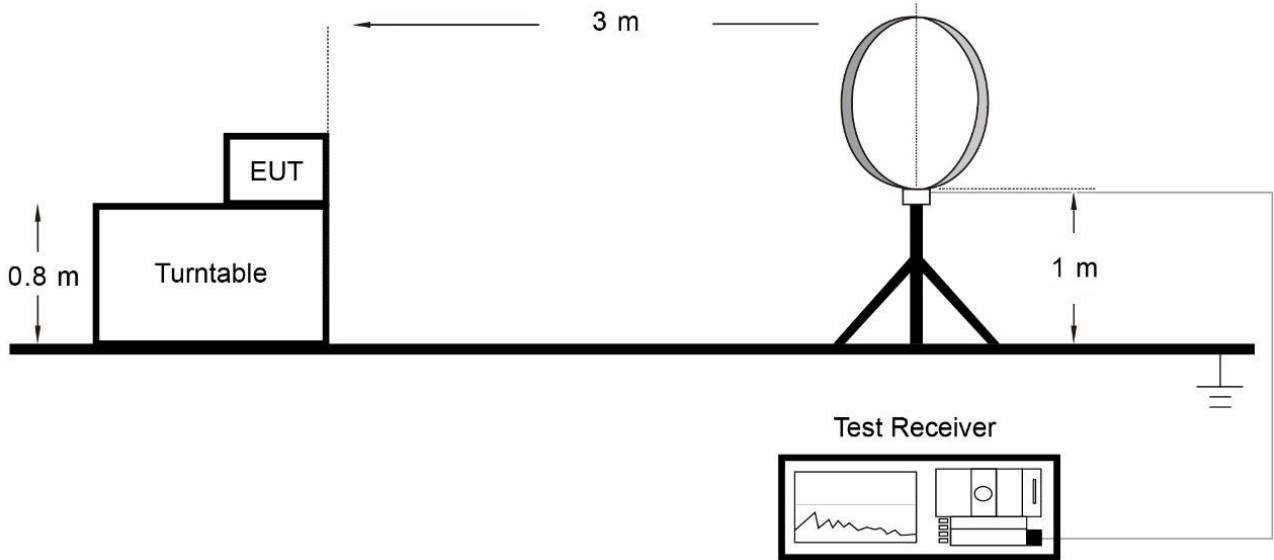

Below 1GHz Test Setup:

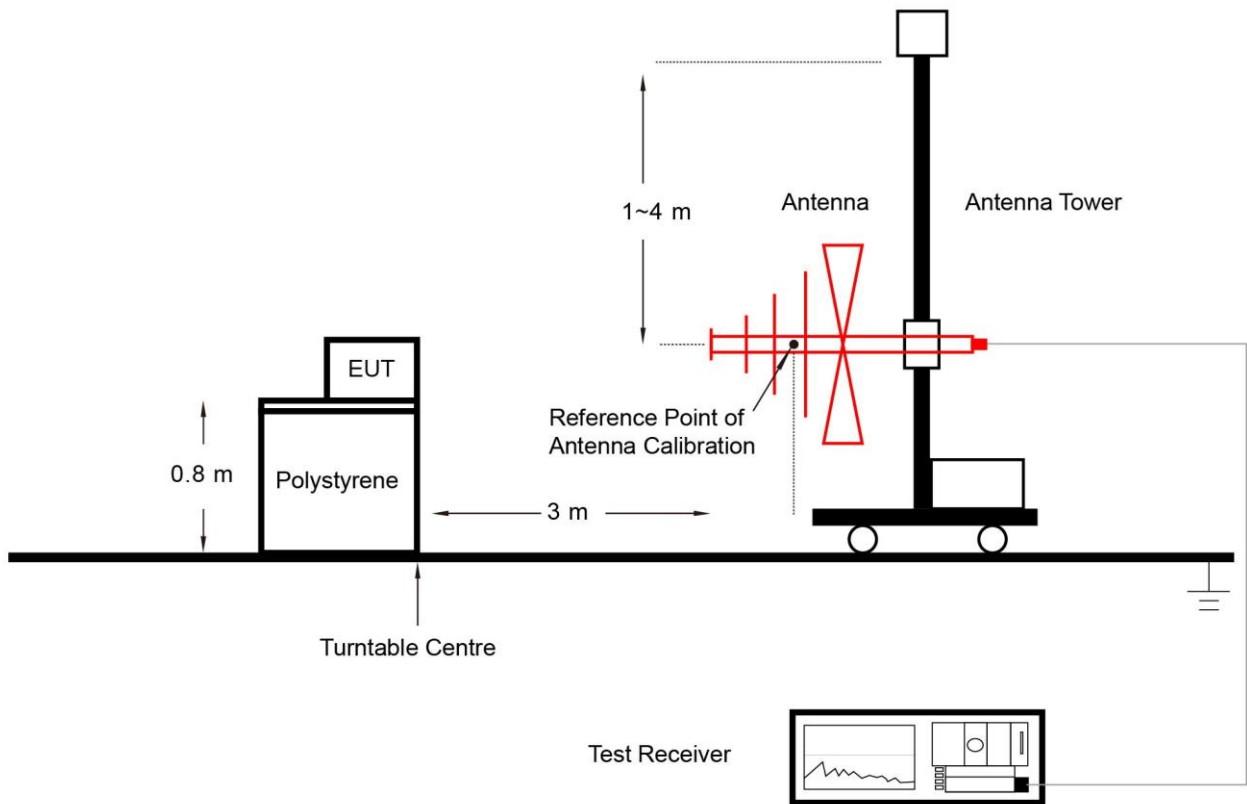

Above 1GHz Test Setup:

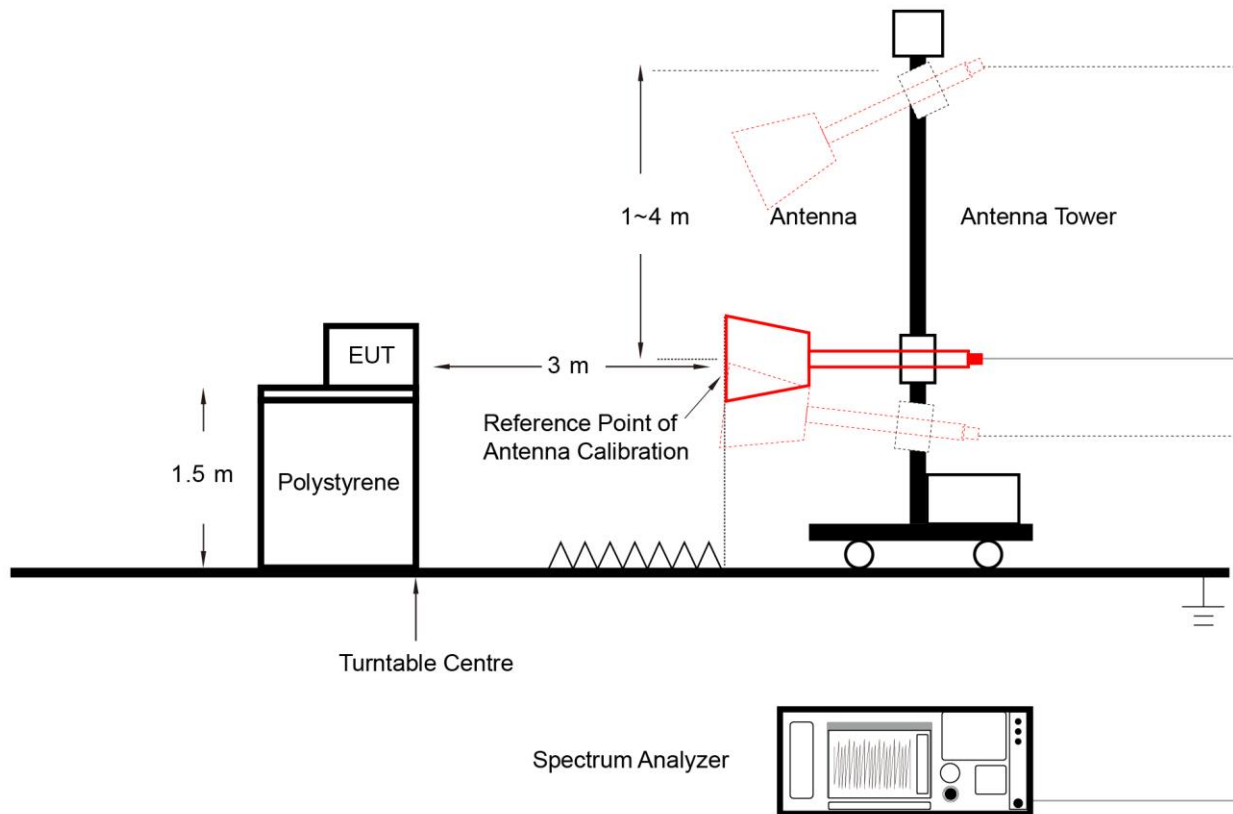

6.8.5. Test Result

Refer to Appendix A.7.

6.9. Radiated Restricted Band Edge Measurement

6.9.1. Test Limit

For 15.205 requirement:

Radiated emissions which fall in the restricted bands, as defined in Section 15.205(a) of FCC part 15, must also comply with the radiated emission limits specified in Section 15.209(a).

Frequency (MHz)	Frequency (MHz)	Frequency (MHz)	Frequency (GHz)
0.090 - 0.110	16.42 - 16.423	399.9 - 410	4.5 - 5.15
¹ 0.495 - 0.505	16.69475 - 16.69525	608 - 614	5.35 - 5.46
2.1735 - 2.1905	16.80425 - 16.80475	960 - 1240	7.25 - 7.75
4.125 - 4.128	25.5 - 25.67	1300 - 1427	8.025 - 8.5
4.17725 - 4.17775	37.5 - 38.25	1435 - 1626.5	9.0 - 9.2
4.20725 - 4.20775	73 - 74.6	1645.5 - 1646.5	9.3 - 9.5
6.215 - 6.218	74.8 - 75.2	1660 - 1710	10.6 - 12.7
6.26775 - 6.26825	108 - 121.94	1718.8 - 1722.2	13.25 - 13.4
6.31175 - 6.31225	123 - 138	2200 - 2300	14.47 - 14.5
8.291 - 8.294	149.9 - 150.05	2310 - 2390	15.35 - 16.2
8.362 - 8.366	156.52475 - 156.52525	2483.5 - 2500	17.7 - 21.4
8.37625 - 8.38675	156.7 - 156.9	2690 - 2900	22.01 - 23.12
8.41425 - 8.41475	162.0125 - 167.17	3260 - 3267	23.6 - 24.0
12.29 - 12.293	167.72 - 173.2	3332 - 3339	31.2 - 31.8
12.51975 - 12.52025	240 - 285	3345.8 - 3358	36.43 - 36.5
12.57675 - 12.57725	322 - 335.4	3600 - 4400	(²)
13.36 - 13.41	--	--	--

For 15.407(b)(5) requirement:

For transmitters operating within the 5.925-7.125 GHz band: Any emissions outside of the 5.925-7.125 GHz band must not exceed an EIRP. of -27 dBm/MHz.

Refer to 987594 D02 U-NII 6GHz EMC Measurement v01 clause G - Unwanted Emission Measurement

Use guidance in KDB 789033 for measurements below 1000 MHz and above 1000 MHz. Unwanted emissions outside of restricted bands are measured with a RMS detector. In addition, 15.35(b) applies where the peak emissions must be limited to no more than 20 dB above the average limit.

All out of band emissions appearing in a restricted band as specified in Section 15.205 of the Title 47CFR must not exceed the limits shown in Table per Section 15.209.

FCC Part 15 Subpart C Paragraph 15.209		
Frequency [MHz]	Field Strength [uV/m]	Measured Distance [Meters]
0.009 - 0.490	2400/F (kHz)	300
0.490 - 1.705	24000/F (kHz)	30
1.705 - 30	30	30
30 - 88	100	3
88 - 216	150	3
216 - 960	200	3
Above 960	500	3

6.9.2. Test Procedure

KDB 789033 D02v02r01-Section II)G)

6.9.3. Test Setting

Peak Measurements above 1GHz

1. Analyzer center frequency was set to the frequency of the radiated spurious emission of interest
2. RBW = 1MHz
3. VBW = 3MHz
4. Detector = Peak
5. Sweep time = Auto couple
6. Trace mode = Max hold
7. Trace was allowed to stabilize

Average Measurements above 1GHz (Method VB)

1. Analyzer center frequency was set to the frequency of the radiated spurious emission of interest
2. RBW = 1MHz
3. VBW; if the EUT is configured to transmit with duty cycle $\geq 98\%$, set VBW = 10Hz
If the EUT duty cycle is $< 98\%$, set VBW $\geq 1/T$. T is the minimum transmission duration.
4. Detector = Peak
5. Sweep time = Auto
6. Trace mode = Max hold
7. Trace was allowed to stabilize

6.9.4. Test Setup

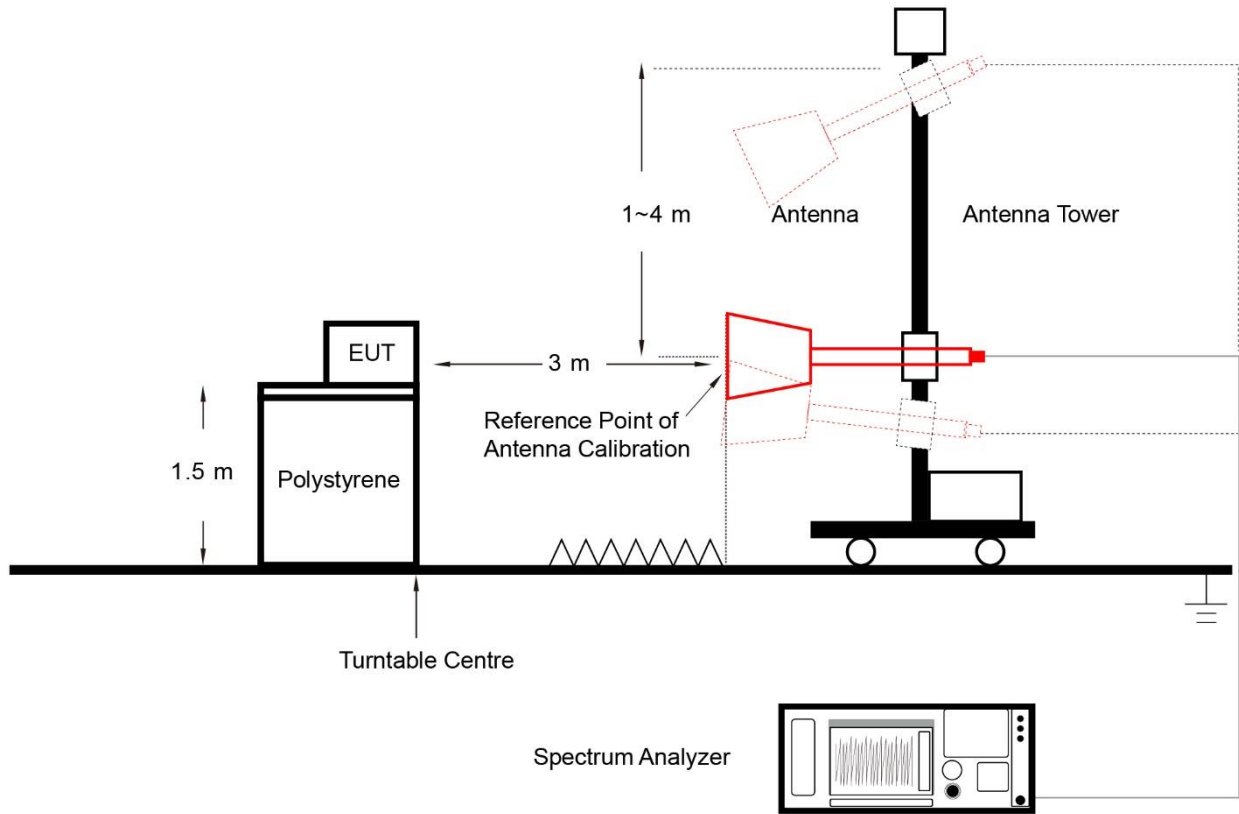

6.9.5. Test Result

Refer to Appendix A.8.

6.10. AC Conducted Emissions Measurement

6.10.1. Test Limit

FCC Part 15.207 Limits		
Frequency (MHz)	QP (dBuV)	AV (dBuV)
0.15 - 0.50	66 - 56	56 - 46
0.50 - 5.0	56	46
5.0 - 30	60	50

Note 1: The lower limit shall apply at the transition frequencies.

Note 2: The limit decreases linearly with the logarithm of the frequency in the range 0.15MHz to 0.5MHz.

6.10.2. Test Setup

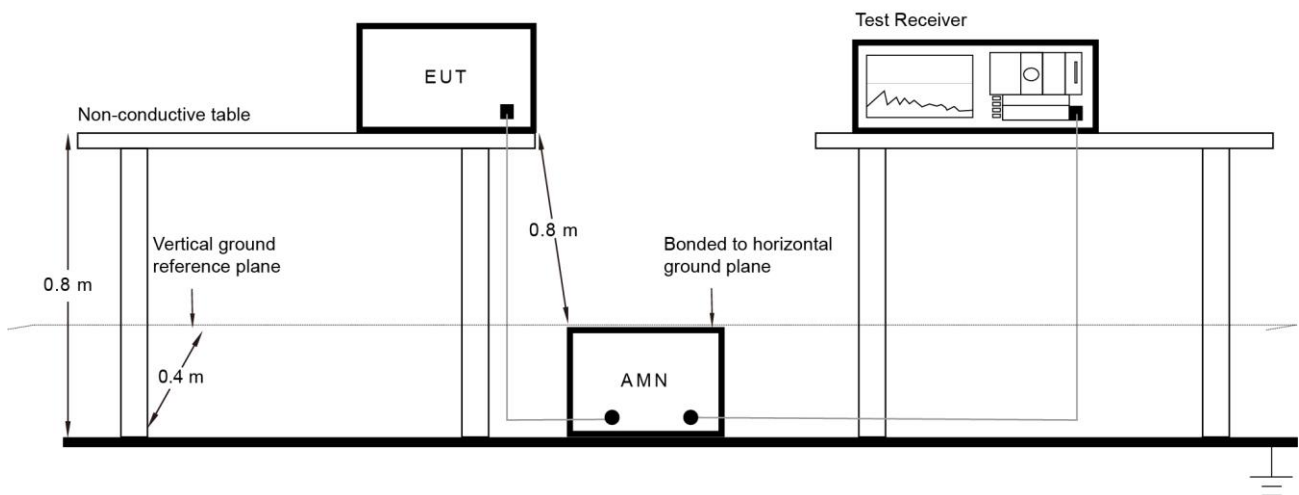

6.10.3. Test Result

Refer to Appendix A.9.

Appendix A – Test Result

A.1 Duty Cycle Test Result

Test Site	NS-TR2	Test Engineer	Summer Tang
Test Date	2023-07-31	Test Mode	N _{ss} = 1

Test Mode	Duty Cycle
802.11ax-HE20	84.16%
802.11ax-HE40	90.37%
802.11ax-HE80	91.28%
802.11ax-HE160	90.37%

Duty Cycle (T = Transmission Duration)

802.11ax-HE20 (T = 5.420ms)

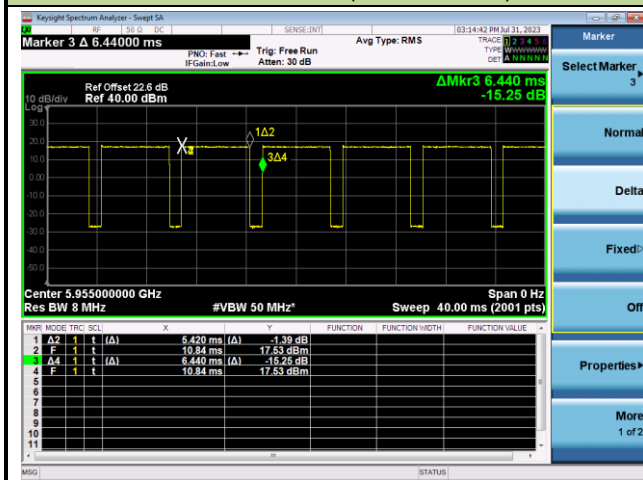

802.11ax-HE40 (T = 5.440ms)

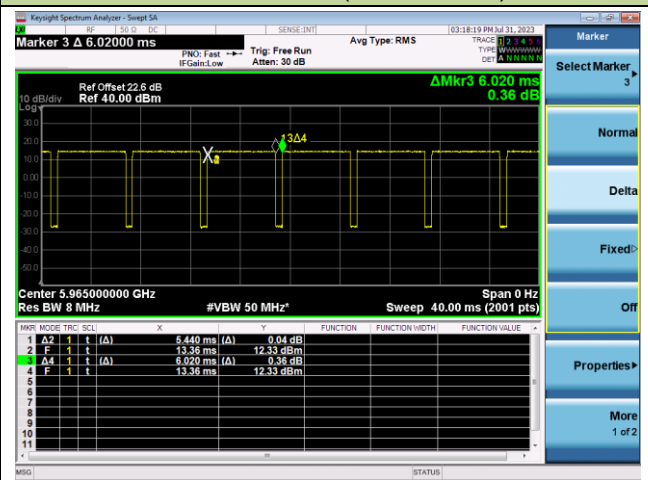

802.11ax-HE80 (T = 5.440ms)

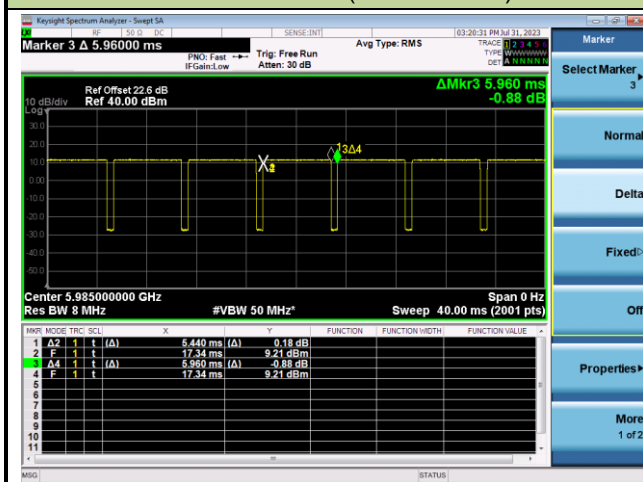

802.11ax-HE160 (T = 5.440ms)

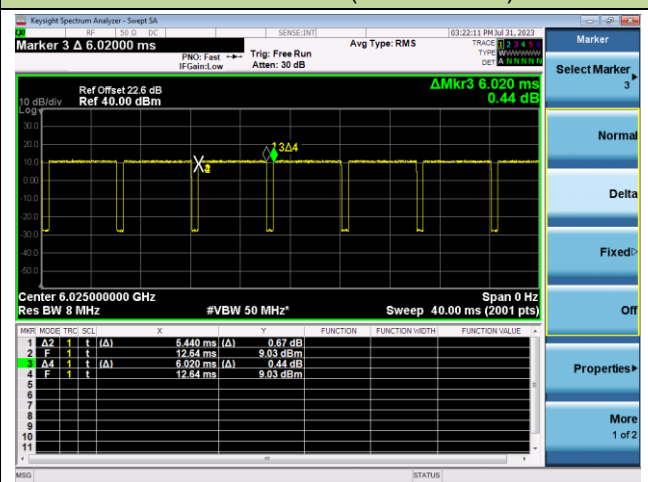

Test Site	NS-TR2	Test Engineer	Summer Tang
Test Date	2023-08-16~2023-08-17	Test Mode	Nss = 2

Test Mode	Duty Cycle
802.11ax-HE20	84.11%
802.11ax-HE40	90.94%
802.11ax-HE80	90.37%
802.11ax-HE160	90.64%

Duty Cycle (T = Transmission Duration)

802.11ax-HE20 (T = 5.400ms)

802.11ax-HE40 (T = 5.420ms)

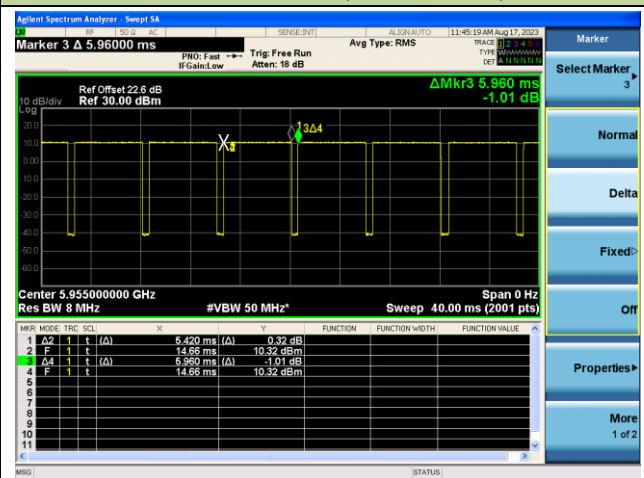
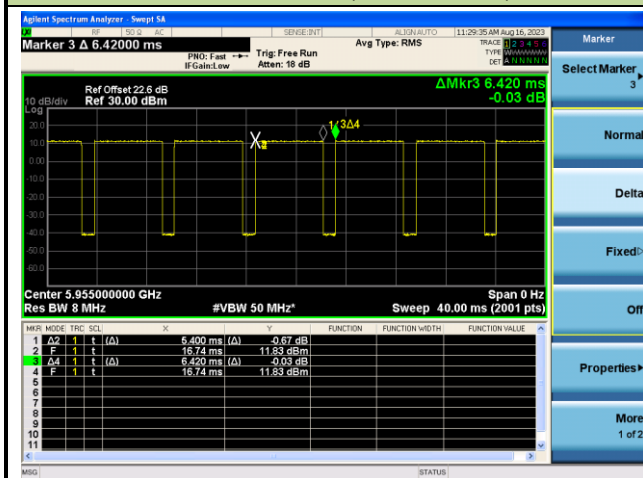

802.11ax-HE80 (T = 5.440ms)

802.11ax-HE160 (T = 5.420ms)

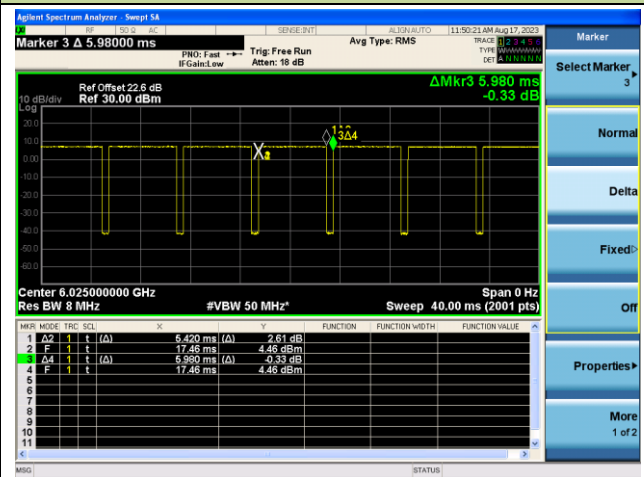
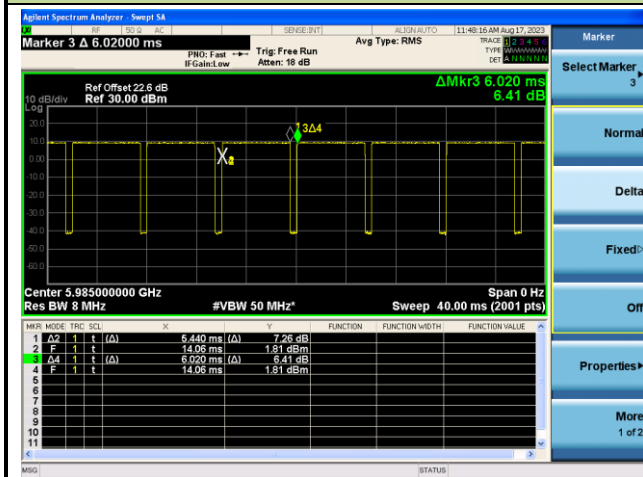

A.2 26dB Bandwidth Test Result

Test Site	NS-TR2	Test Engineer	Summer Tang
Test Date	2023-08-08	Test Mode	N _{SS} = 1

Test Mode	Data Rate/ MCS	Channel No.	Frequency (MHz)	26dB Bandwidth (MHz)	99% Bandwidth (MHz)	Limit (MHz)
802.11ax-HE20	MCS0	1	5955	22.14	19.104	≤ 320
802.11ax-HE20	MCS0	45	6175	22.12	19.058	≤ 320
802.11ax-HE20	MCS0	93	6415	22.35	19.078	≤ 320
802.11ax-HE20	MCS0	97	6435	22.21	19.080	≤ 320
802.11ax-HE20	MCS0	105	6475	21.95	19.074	≤ 320
802.11ax-HE20	MCS0	113	6515	21.98	19.111	≤ 320
802.11ax-HE20	MCS0	117	6535	22.17	19.097	≤ 320
802.11ax-HE20	MCS0	149	6695	21.79	19.085	≤ 320
802.11ax-HE20	MCS0	181	6855	21.80	19.104	≤ 320
802.11ax-HE20	MCS0	185	6875	21.91	19.037	≤ 320
802.11ax-HE20	MCS0	189	6895	21.78	19.066	≤ 320
802.11ax-HE20	MCS0	213	7015	22.44	19.096	≤ 320
802.11ax-HE20	MCS0	229	7095	22.04	19.080	≤ 320
802.11ax-HE40	MCS0	3	5965	43.90	38.093	≤ 320
802.11ax-HE40	MCS0	43	6165	43.34	38.043	≤ 320
802.11ax-HE40	MCS0	91	6405	43.43	38.036	≤ 320
802.11ax-HE40	MCS0	99	6445	42.84	38.103	≤ 320
802.11ax-HE40	MCS0	107	6485	43.46	38.057	≤ 320
802.11ax-HE40	MCS0	115	6525	43.17	38.063	≤ 320
802.11ax-HE40	MCS0	123	6565	44.17	38.080	≤ 320
802.11ax-HE40	MCS0	147	6685	43.31	38.032	≤ 320
802.11ax-HE40	MCS0	179	6845	43.17	38.047	≤ 320
802.11ax-HE40	MCS0	187	6885	42.75	38.001	≤ 320
802.11ax-HE40	MCS0	195	6925	43.01	38.010	≤ 320
802.11ax-HE40	MCS0	211	7005	43.51	38.006	≤ 320
802.11ax-HE40	MCS0	227	7085	43.46	38.038	≤ 320

Test Mode	Data Rate/ MCS	Channel No.	Frequency (MHz)	26dB Bandwidth (MHz)	99% Bandwidth (MHz)	Limit (MHz)
802.11ax-HE80	MCS0	7	5985	84.49	77.637	≤ 320
802.11ax-HE80	MCS0	39	6145	86.02	77.675	≤ 320
802.11ax-HE80	MCS0	87	6385	87.13	77.793	≤ 320
802.11ax-HE80	MCS0	103	6465	86.60	77.749	≤ 320
802.11ax-HE80	MCS0	119	6545	86.88	77.739	≤ 320
802.11ax-HE80	MCS0	135	6625	86.28	77.809	≤ 320
802.11ax-HE80	MCS0	151	6705	87.64	77.892	≤ 320
802.11ax-HE80	MCS0	167	6785	85.55	77.641	≤ 320
802.11ax-HE80	MCS0	183	6865	85.75	77.617	≤ 320
802.11ax-HE80	MCS0	199	6945	86.25	77.609	≤ 320
802.11ax-HE80	MCS0	215	7025	85.83	77.576	≤ 320
802.11ax-HE160	MCS0	15	6025	166.0	156.45	≤ 320
802.11ax-HE160	MCS0	47	6185	168.5	157.03	≤ 320
802.11ax-HE160	MCS0	79	6345	167.2	156.57	≤ 320
802.11ax-HE160	MCS0	111	6505	168.3	156.82	≤ 320
802.11ax-HE160	MCS0	143	6665	168.0	156.62	≤ 320
802.11ax-HE160	MCS0	175	6825	167.9	156.69	≤ 320
802.11ax-HE160	MCS0	207	6985	166.7	156.22	≤ 320

Note:

For channels with a nominal bandwidth less than 320 MHz compliance is demonstrated by way of the 26 dB EBW.

For channels with a nominal bandwidth of 320 MHz compliance is demonstrated by way of the 99% BW.

802.11ax-HE20 26dB Bandwidth - Nss = 1

Channel 1 (5955MHz)

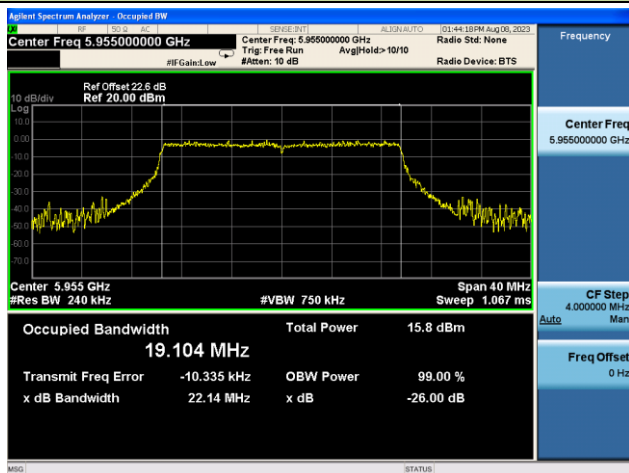

Channel 45 (6175MHz)

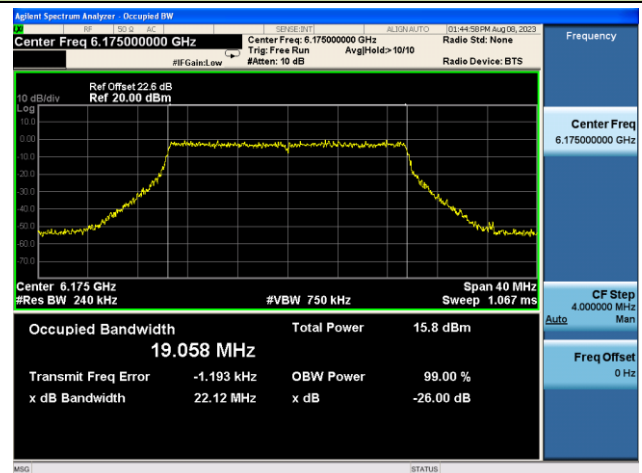

Channel 93 (6415MHz)

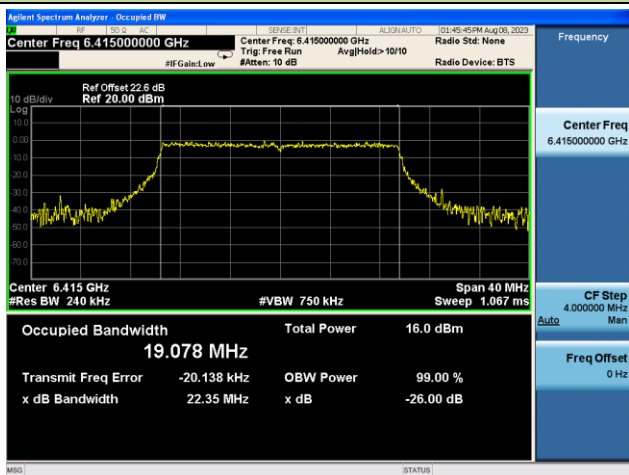

Channel 97 (6435MHz)

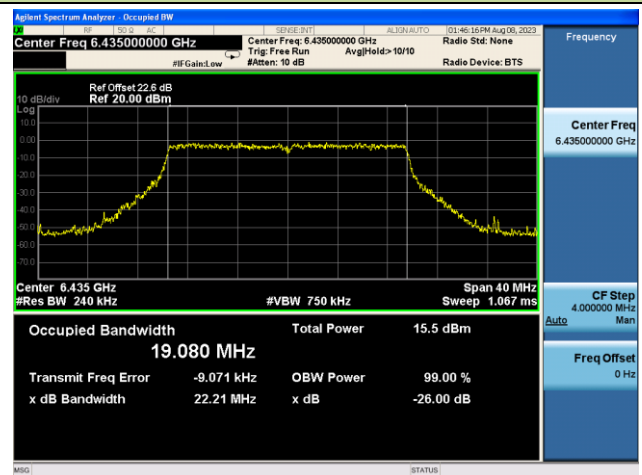

Channel 105 (6475MHz)

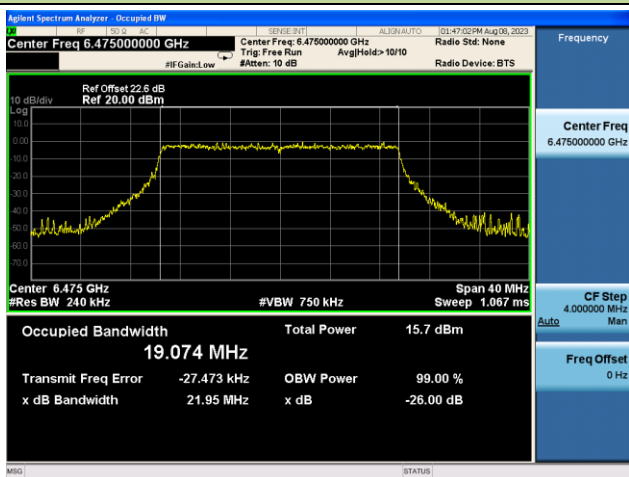

Channel 113 (6515MHz)

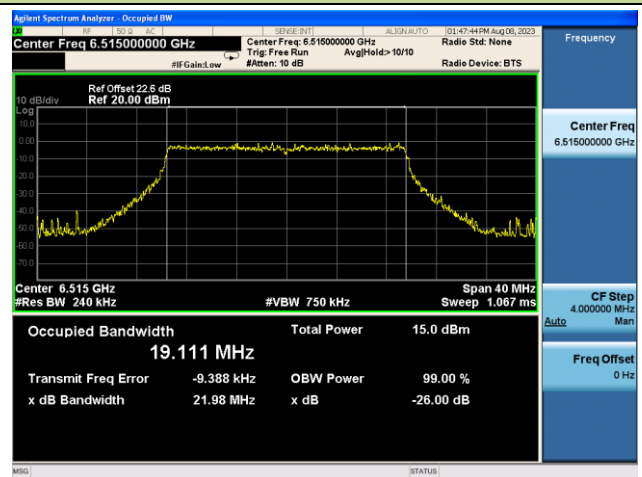

802.11ax-HE20 26dB Bandwidth - Nss = 1

Channel 117 (6535MHz)

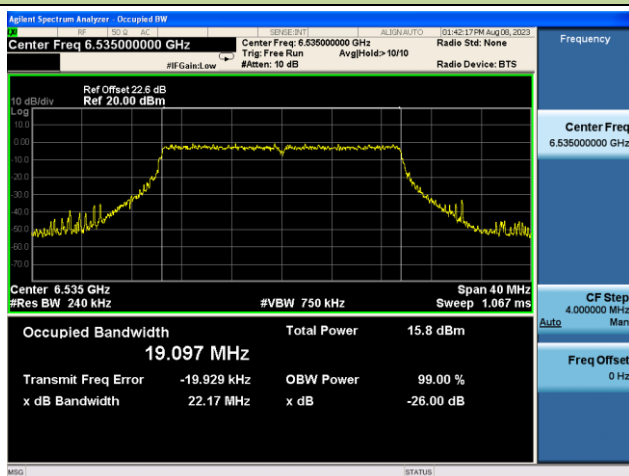

Channel 149 (6695MHz)

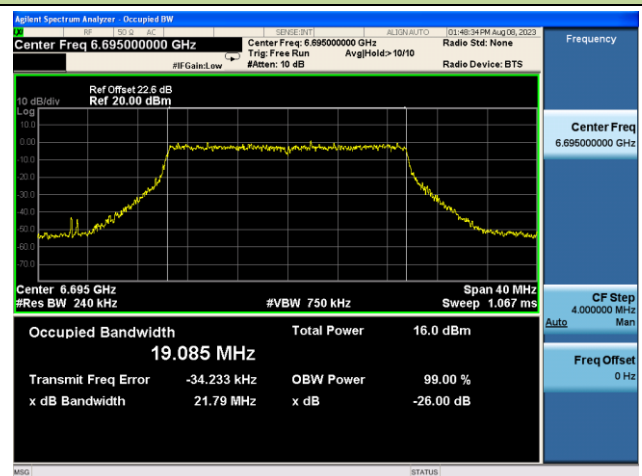

Channel 181 (6855MHz)

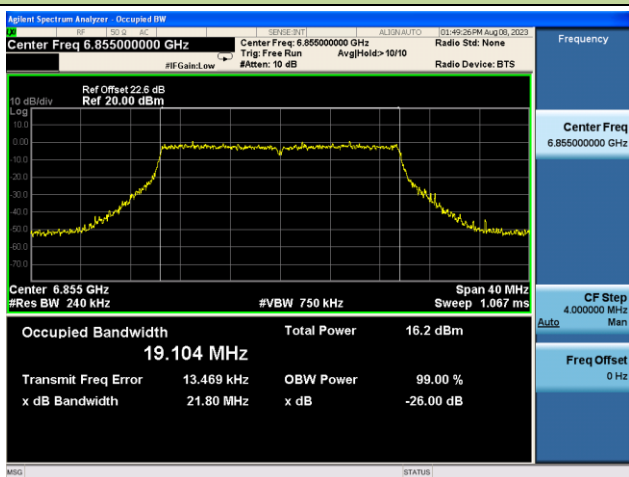

Channel 185 (6875MHz)

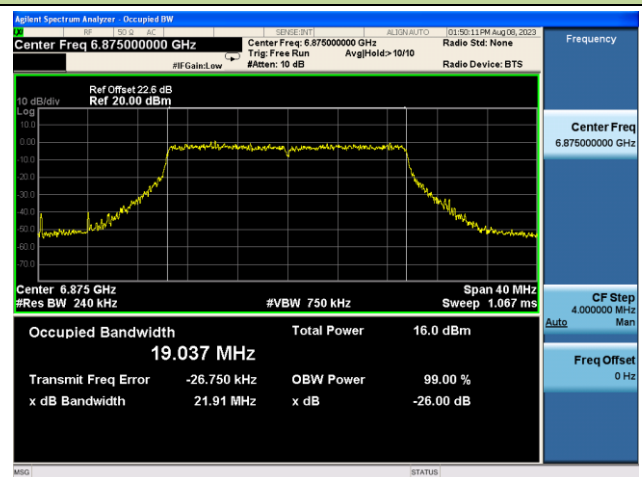

Channel 189 (6895MHz)

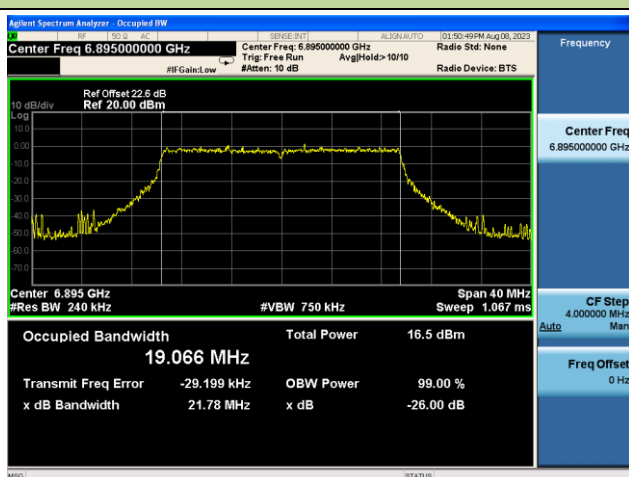

Channel 213 (7015MHz)

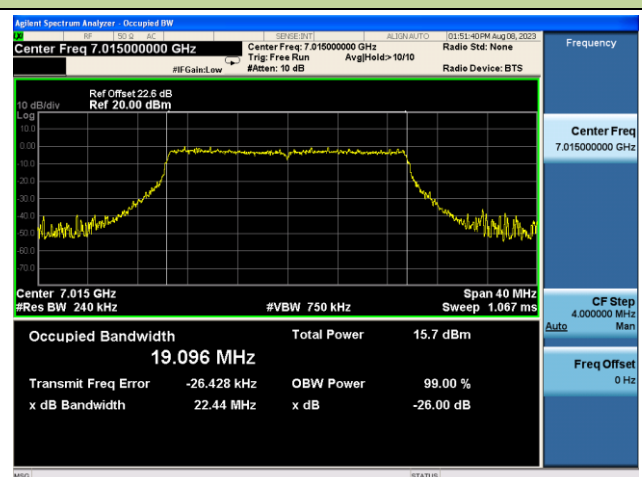

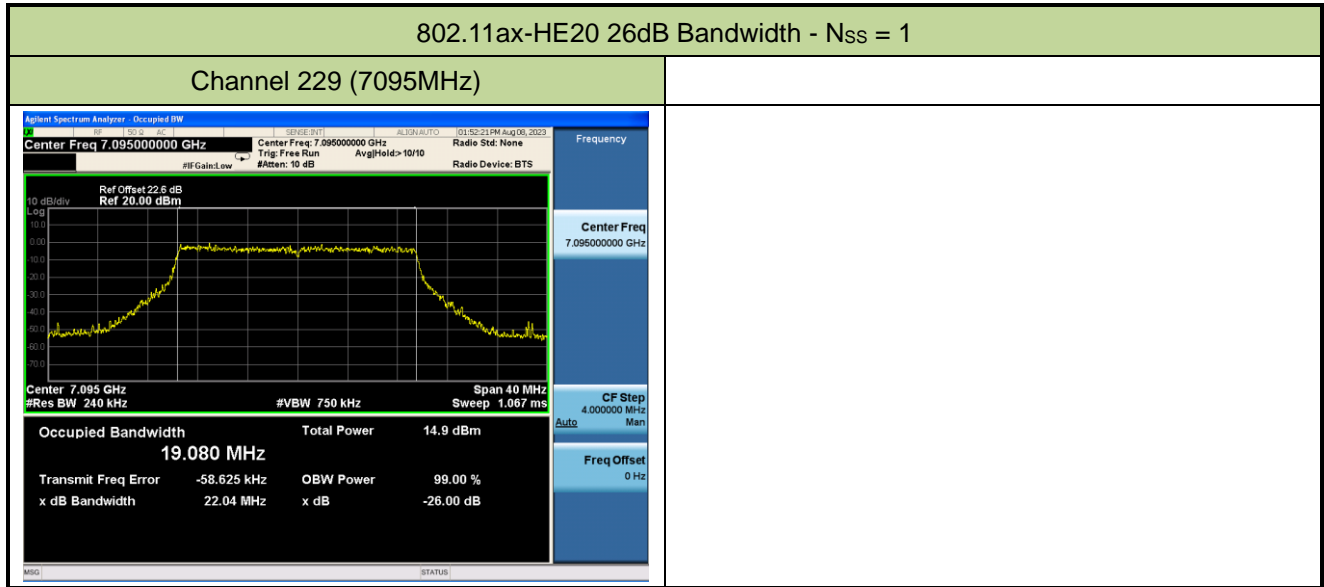

802.11ax-HE40 26dB Bandwidth - Nss = 1

Channel 3 (5965MHz)

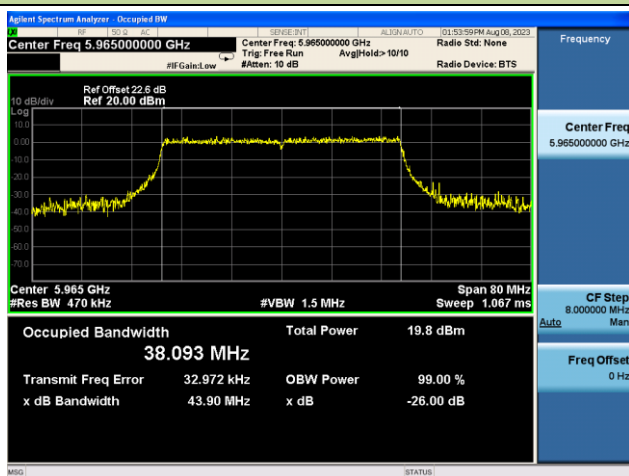

Channel 43 (6165MHz)

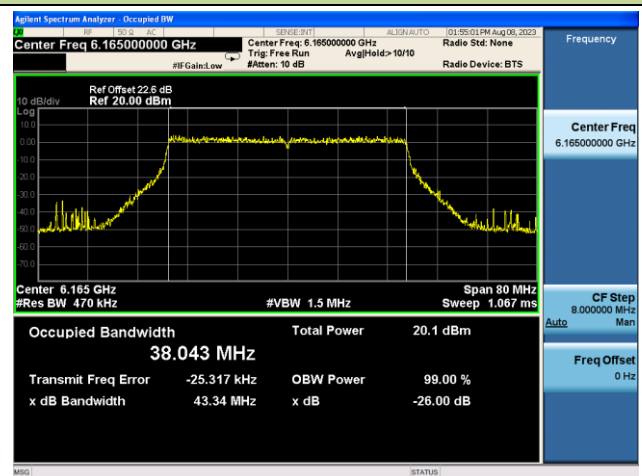

Channel 91 (6405MHz)

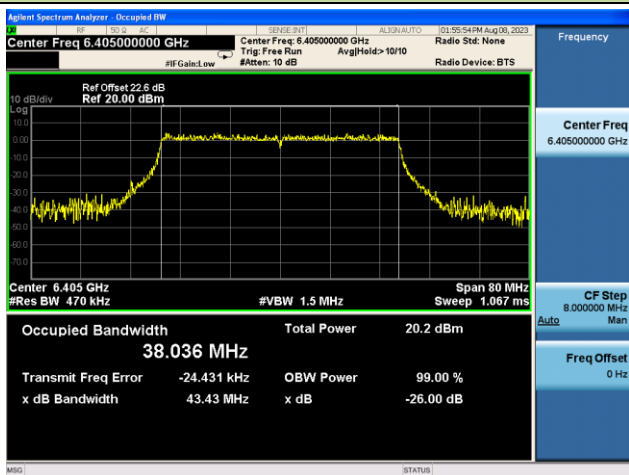

Channel 99 (6445MHz)

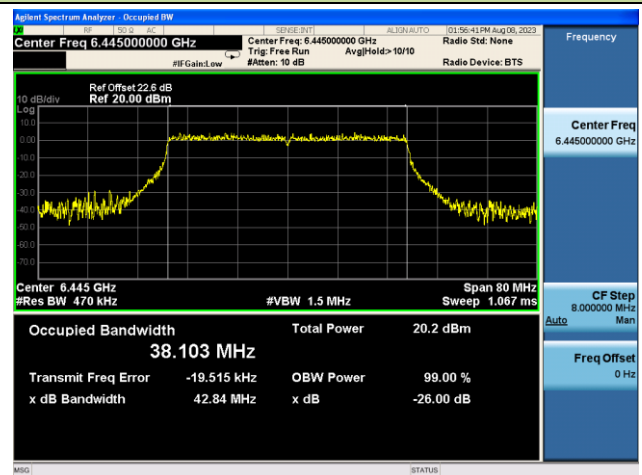

Channel 107 (6485MHz)

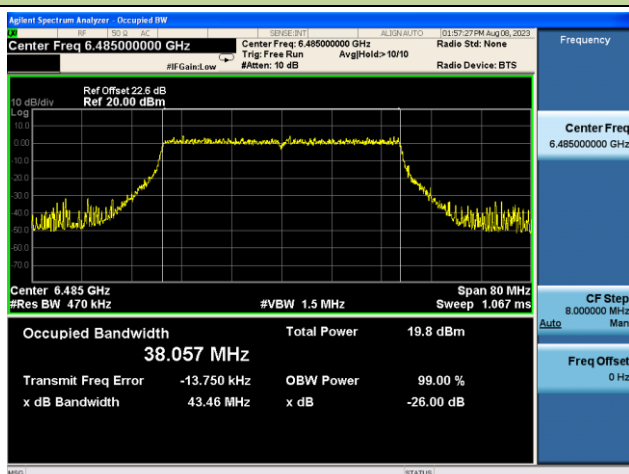

Channel 115 (6525MHz)

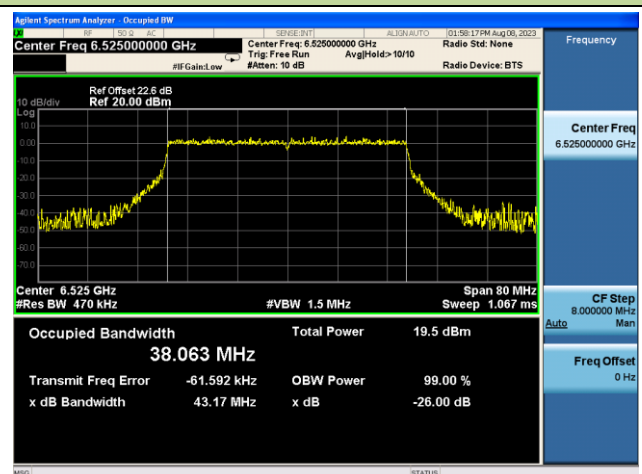

802.11ax-HE40 26dB Bandwidth - Nss = 1

Channel 123 (6565MHz)

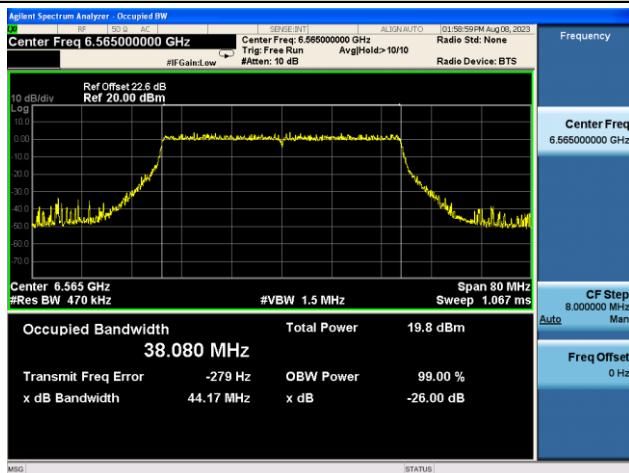

Channel 147 (6685MHz)

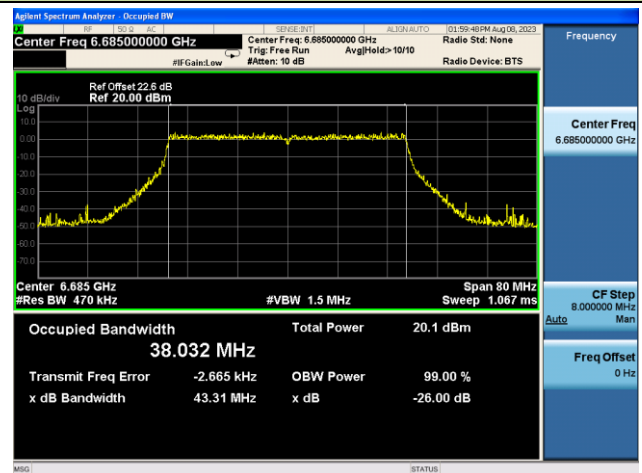

Channel 179 (6845MHz)

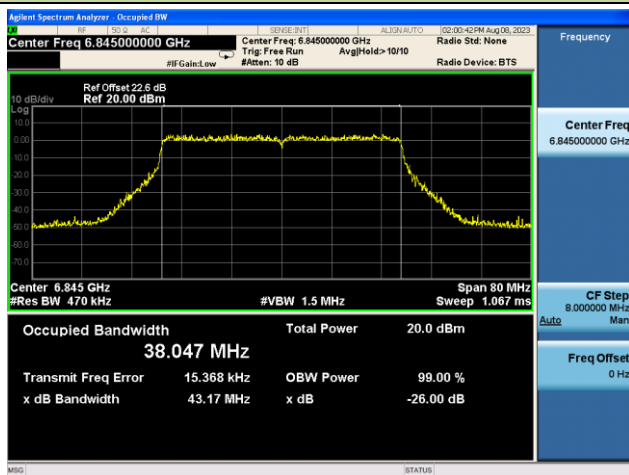

Channel 187 (6885MHz)

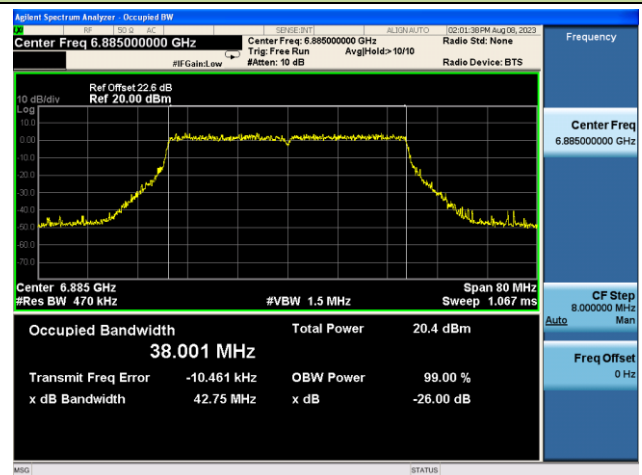

Channel 195 (6925MHz)

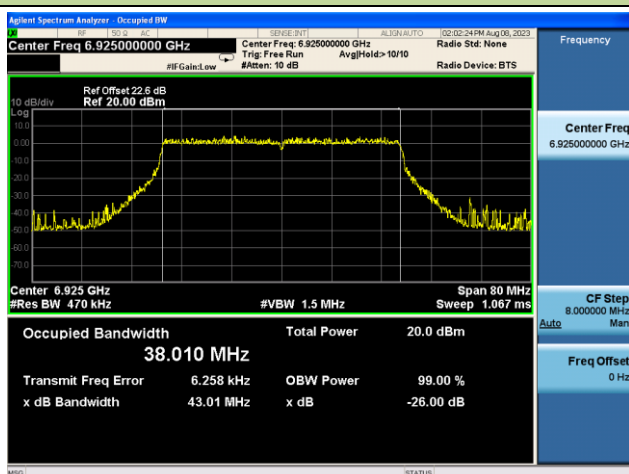

Channel 211 (7005MHz)

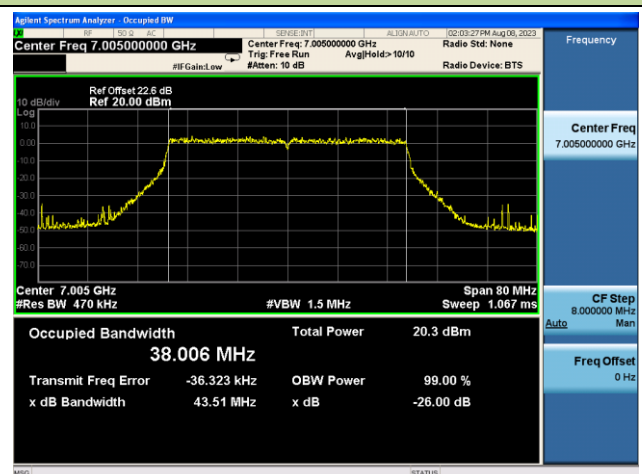

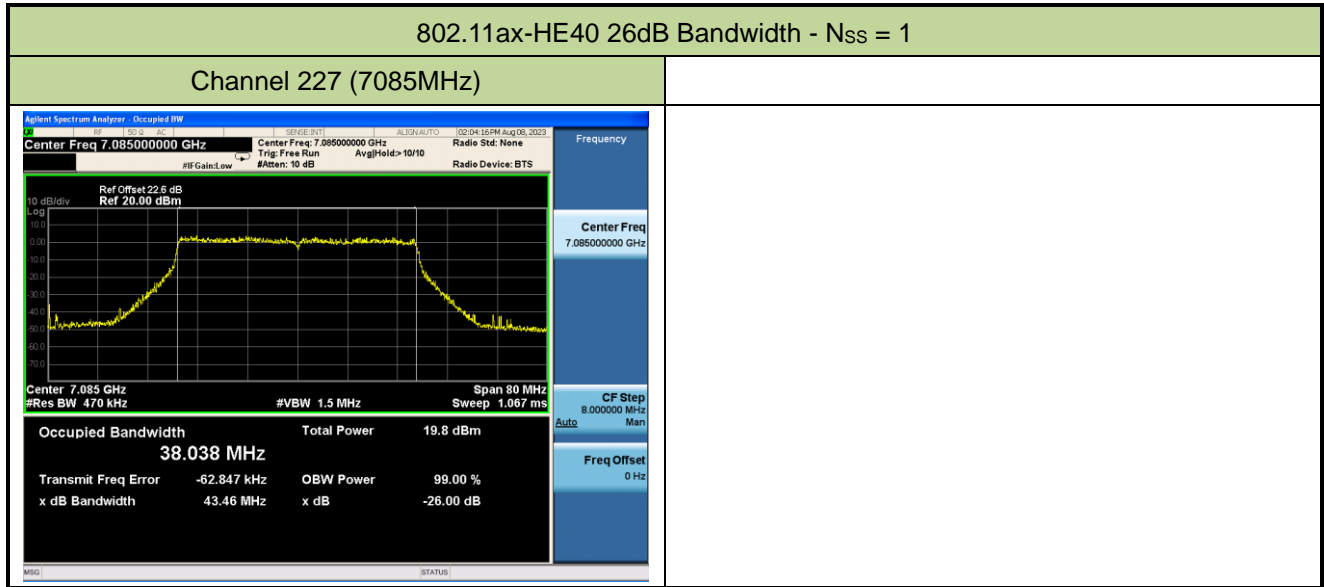

802.11ax-HE80 26dB Bandwidth - Nss = 1

Channel 7 (5985MHz)

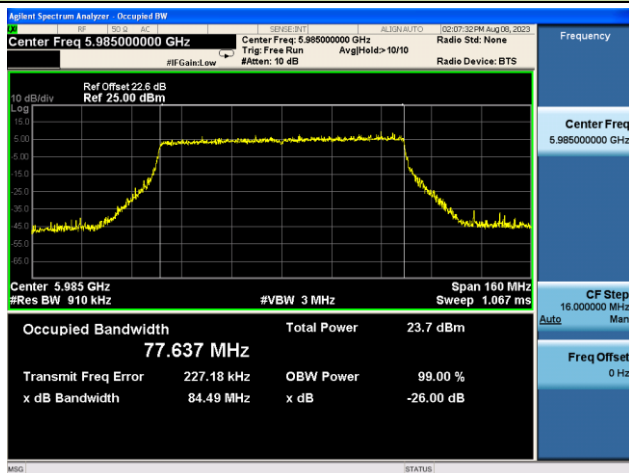

Channel 39 (6145MHz)

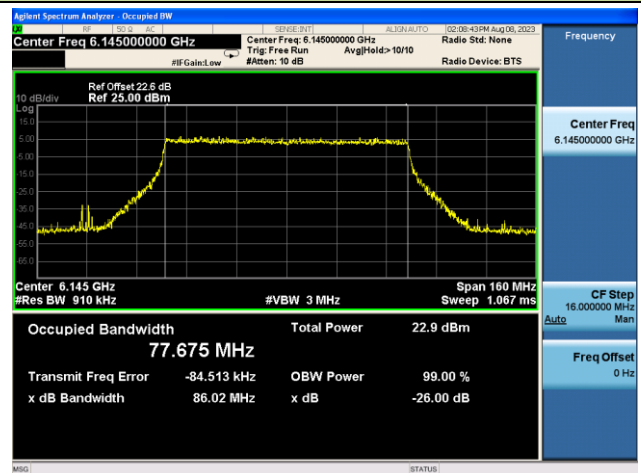

Channel 87 (6385MHz)

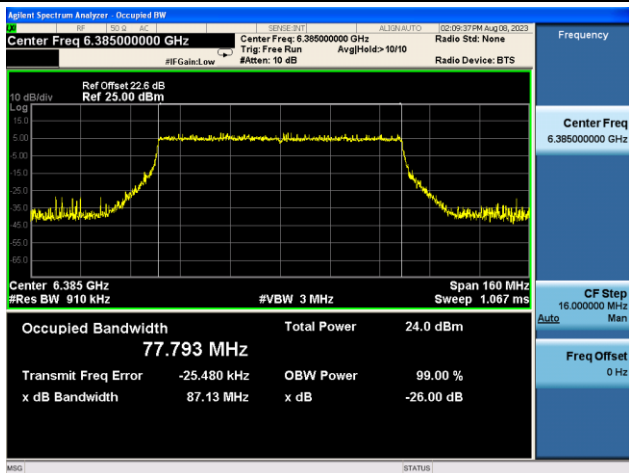

Channel 103 (6465MHz)

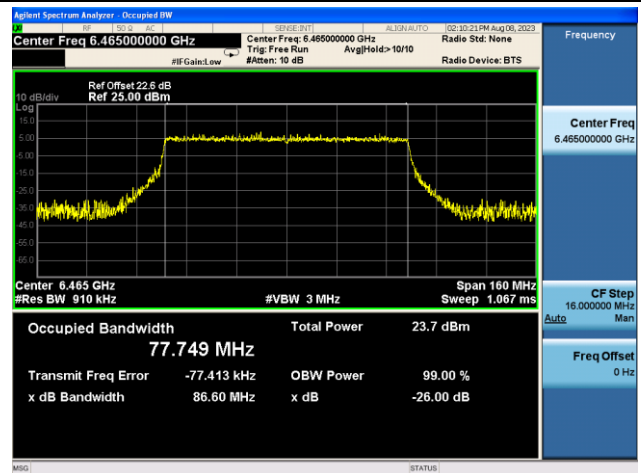

Channel 119 (6545MHz)

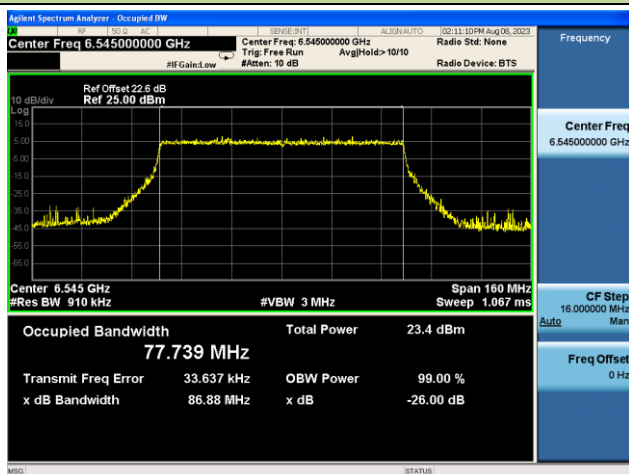

Channel 135 (6625MHz)

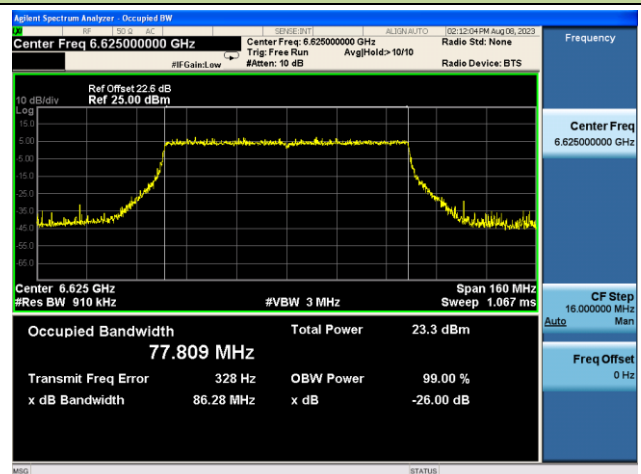

802.11ax-HE80 26dB Bandwidth - Nss = 1

Channel 151 (6705MHz)

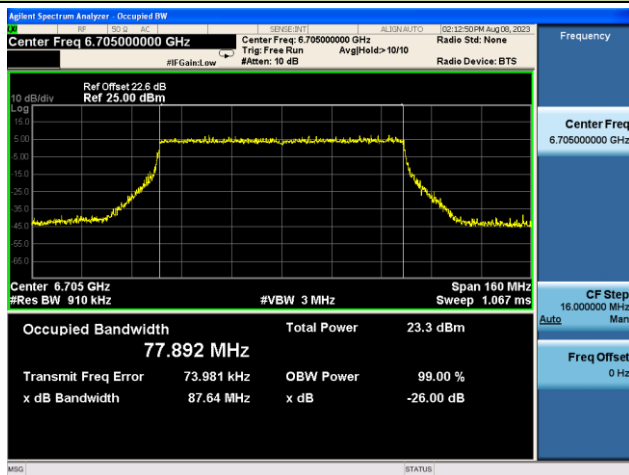

Channel 167 (6785MHz)

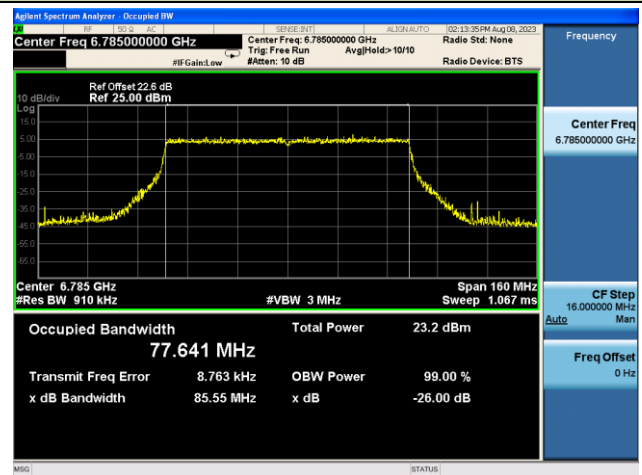

Channel 177 (6865MHz)

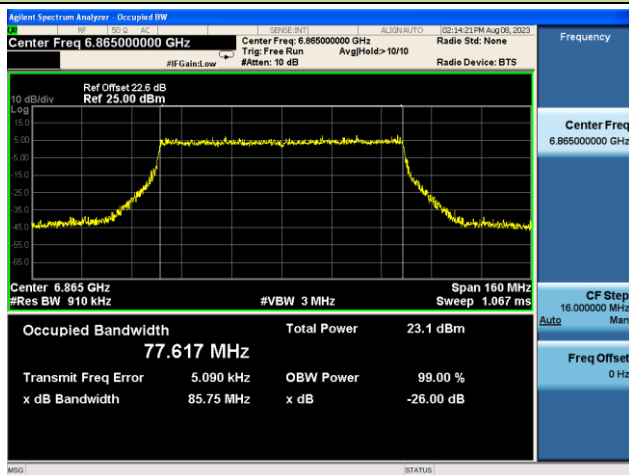

Channel 199 (6945MHz)

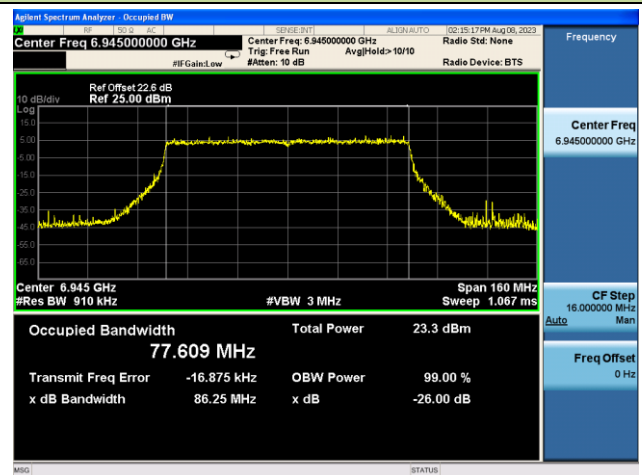

Channel 215 (7025MHz)

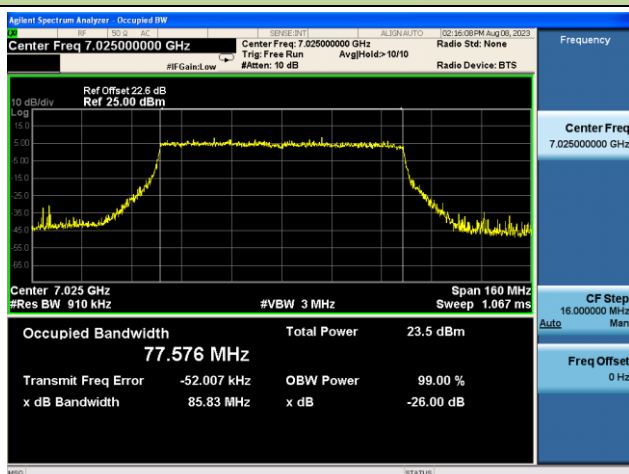

802.11ax-HE160 26dB Bandwidth - N_{ss} = 1

Channel 15 (6025MHz)

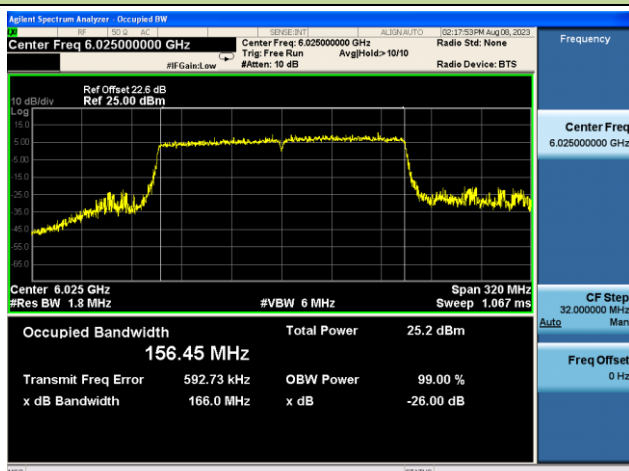

Channel 47 (6185MHz)

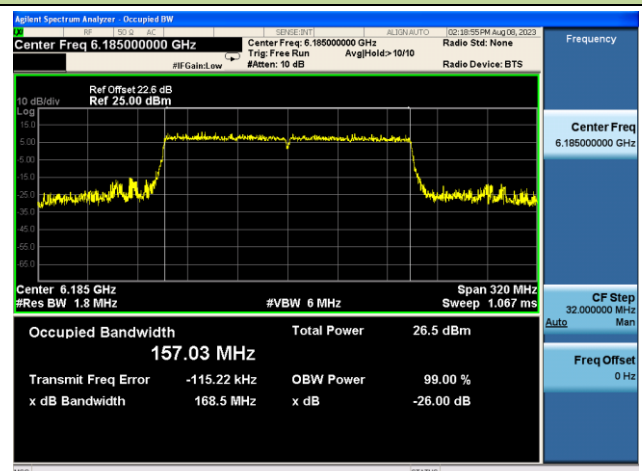

Channel 79 (6345MHz)

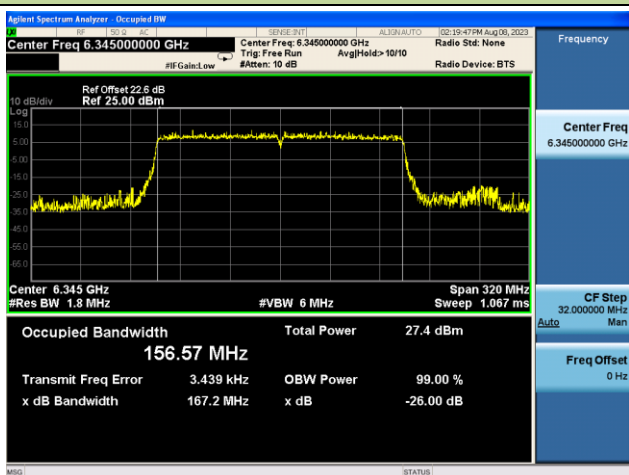

Channel 111 (6505MHz)

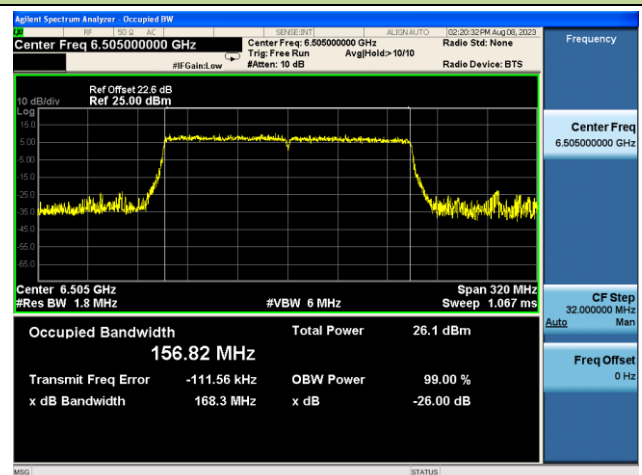

Channel 143 (6665MHz)

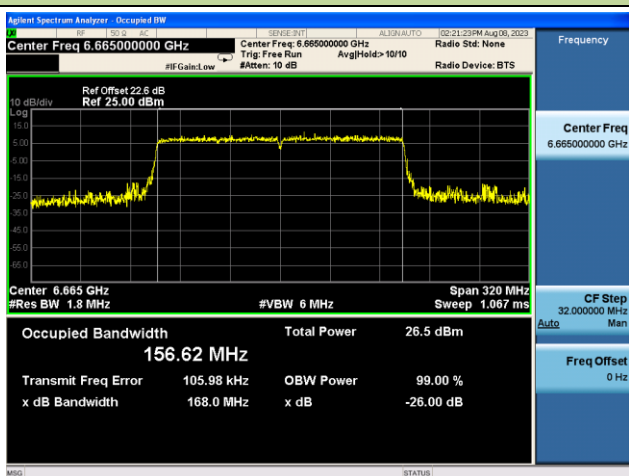

Channel 175 (6825MHz)

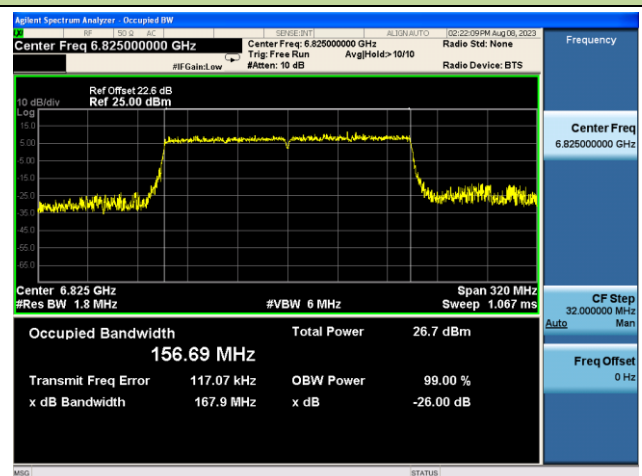

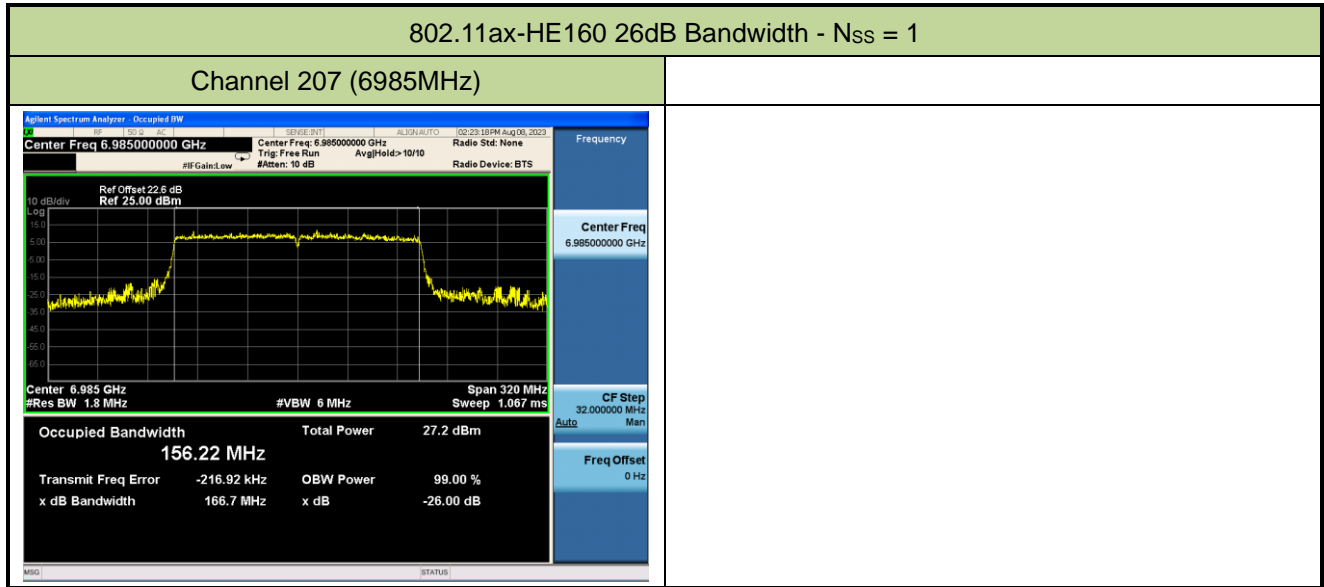

Test Site	NS-TR2	Test Engineer	Summer Tang
Test Date	2023-08-21	Test Mode	N _{ss} = 2

Test Mode	Data Rate/ MCS	Channel No.	Frequency (MHz)	26dB Bandwidth (MHz)	99% Bandwidth (MHz)	Limit (MHz)
802.11ax-HE20	MCS0	1	5955	21.86	19.091	≤ 320
802.11ax-HE20	MCS0	45	6175	21.90	19.136	≤ 320
802.11ax-HE20	MCS0	93	6415	21.94	19.049	≤ 320
802.11ax-HE20	MCS0	97	6435	21.96	19.124	≤ 320
802.11ax-HE20	MCS0	105	6475	21.64	19.107	≤ 320
802.11ax-HE20	MCS0	113	6515	22.11	19.088	≤ 320
802.11ax-HE20	MCS0	117	6535	22.05	19.068	≤ 320
802.11ax-HE20	MCS0	149	6695	22.29	19.073	≤ 320
802.11ax-HE20	MCS0	181	6855	22.25	19.060	≤ 320
802.11ax-HE20	MCS0	185	6875	21.35	19.043	≤ 320
802.11ax-HE20	MCS0	189	6895	21.65	19.045	≤ 320
802.11ax-HE20	MCS0	213	7015	22.19	19.107	≤ 320
802.11ax-HE20	MCS0	229	7095	21.78	19.110	≤ 320
802.11ax-HE40	MCS0	3	5965	43.37	38.003	≤ 320
802.11ax-HE40	MCS0	43	6165	43.47	37.973	≤ 320
802.11ax-HE40	MCS0	91	6405	43.56	38.011	≤ 320
802.11ax-HE40	MCS0	99	6445	42.68	38.068	≤ 320
802.11ax-HE40	MCS0	107	6485	43.37	38.033	≤ 320
802.11ax-HE40	MCS0	115	6525	42.77	38.061	≤ 320
802.11ax-HE40	MCS0	123	6565	42.49	37.972	≤ 320
802.11ax-HE40	MCS0	147	6685	42.38	37.958	≤ 320
802.11ax-HE40	MCS0	179	6845	43.20	37.964	≤ 320
802.11ax-HE40	MCS0	187	6885	43.24	38.074	≤ 320
802.11ax-HE40	MCS0	195	6925	42.67	38.052	≤ 320
802.11ax-HE40	MCS0	211	7005	43.07	37.993	≤ 320
802.11ax-HE40	MCS0	227	7085	42.86	38.050	≤ 320

Test Mode	Data Rate/ MCS	Channel No.	Frequency (MHz)	26dB Bandwidth (MHz)	99% Bandwidth (MHz)	Limit (MHz)
802.11ax-HE80	MCS0	7	5985	87.20	77.723	≤ 320
802.11ax-HE80	MCS0	39	6145	84.99	77.670	≤ 320
802.11ax-HE80	MCS0	87	6385	86.27	77.746	≤ 320
802.11ax-HE80	MCS0	103	6465	85.37	77.543	≤ 320
802.11ax-HE80	MCS0	119	6545	87.70	77.663	≤ 320
802.11ax-HE80	MCS0	135	6625	85.17	77.843	≤ 320
802.11ax-HE80	MCS0	151	6705	86.15	77.590	≤ 320
802.11ax-HE80	MCS0	167	6785	86.61	77.705	≤ 320
802.11ax-HE80	MCS0	183	6865	86.46	77.540	≤ 320
802.11ax-HE80	MCS0	199	6945	85.80	77.675	≤ 320
802.11ax-HE80	MCS0	215	7025	86.54	77.733	≤ 320
802.11ax-HE160	MCS0	15	6025	231.8	156.82	≤ 320
802.11ax-HE160	MCS0	47	6185	220.9	157.35	≤ 320
802.11ax-HE160	MCS0	79	6345	225.4	157.11	≤ 320
802.11ax-HE160	MCS0	111	6505	221.3	157.04	≤ 320
802.11ax-HE160	MCS0	143	6665	233.3	157.51	≤ 320
802.11ax-HE160	MCS0	175	6825	238.6	157.03	≤ 320
802.11ax-HE160	MCS0	207	6985	227.2	157.10	≤ 320

Note:

For channels with a nominal bandwidth less than 320 MHz compliance is demonstrated by way of the 26 dB EBW.

For channels with a nominal bandwidth of 320 MHz compliance is demonstrated by way of the 99% BW.