

RF MEASUREMENT REPORT

FCC ID: 2BCGWRE815XEV2
Applicant: TP-LINK CORPORATION PTE. LTD
Product: AXE5400 Tri-Band Wi-Fi 6E Range Extender
Model No.: RE815XE
Brand Name: tp-link
FCC Classification: Unlicensed National Information Infrastructure (NII)
FCC Rule Part(s): Part 15 Subpart E (Section 15.407)
Result: Complies
Received Date: 2023-07-19
Test Date: 2023-07-26 ~ 2023-08-17

Reviewed By:

Kevin Guo

Approved By:

Robin Wu



The test results relate only to the samples tested.

This equipment has been shown to be capable of compliance with the applicable technical standards as indicated in the measurement report and was tested in accordance with the measurement procedures specified in KDB789033. Test results reported herein relate only to the item(s) tested.

The test report shall not be reproduced except in full without the written approval of MRT Technology (Suzhou) Co., Ltd.

Revision History

Report No.	Version	Description	Issue Date	Note
2307RSU051-U3	V01	Initial Report	2024-02-01	Valid

CONTENTS

Description	Page
1. General Information	6
1.1. Applicant	6
1.2. Manufacturer.....	6
1.3. Testing Facility	6
1.4. Product Information	7
1.5. Radio Specification under Test.....	7
1.6. Working Frequencies.....	8
1.7. Antenna Details	9
2. Test Configuration	10
2.1. Test Mode	10
2.2. Test System Connection Diagram	11
2.3. Test Software	11
2.4. Applied Standards	11
2.5. Test Environment Condition.....	12
3. Antenna Requirements	13
4. Measuring Instrument	14
5. Decision Rules and Measurement Uncertainty	15
5.1. Decision Rules.....	15
5.2. Measurement Uncertainty	15
6. Test Result.....	16
6.1. Summary	16
6.2. 26dB & 99% Bandwidth Measurement.....	17
6.2.1. Test Limit.....	17
6.2.2. Test Procedure	17
6.2.3. Test Setting	17
6.2.4. Test Setup.....	18
6.2.5. Test Result	18
6.3. 6dB Bandwidth Measurement	19
6.3.1. Test Limit.....	19
6.3.2. Test Procedure	19
6.3.3. Test Setting	19
6.3.4. Test Setup.....	19
6.3.5. Test Result	19
6.4. Output Power Measurement.....	20
6.4.1. Test Limit.....	20

6.4.2.	Test Procedure	20
6.4.3.	Test Setting	20
6.4.4.	Test Setup	20
6.4.5.	Test Result	20
6.5.	Transmit Power Control Measurement	21
6.5.1.	Test Limit	21
6.5.2.	Test Procedure	21
6.5.3.	Test Setting	21
6.5.4.	Test Setup	21
6.5.5.	Test Result	21
6.6.	Power Spectral Density Measurement	22
6.6.1.	Test Limit	22
6.6.2.	Test Procedure	22
6.6.3.	Test Setting	22
6.6.4.	Test Setup	23
6.6.5.	Test Result	23
6.7.	Frequency Stability Measurement	24
6.7.1.	Test Limit	24
6.7.2.	Test Procedure	24
6.7.3.	Test Setup	24
6.7.4.	Test Result	25
6.8.	Radiated Spurious Emission Measurement	26
6.8.1.	Test Limit	26
6.8.2.	Test Procedure	26
6.8.3.	Test Setting	26
6.8.4.	Test Setup	28
6.8.5.	Test Result	29
6.9.	Radiated Restricted Band Edge Measurement	30
6.9.1.	Test Limit	30
6.9.2.	Test Procedure	32
6.9.3.	Test Setting	32
6.9.4.	Test Setup	33
6.9.5.	Test Result	33
6.10.	AC Conducted Emissions Measurement	34
6.10.1.	Test Limit	34
6.10.2.	Test Setup	34
6.10.3.	Test Result	34
Appendix A – Test Result		35
A.1	Duty Cycle Test Result	35

A.2	26dB Bandwidth Test Result	38
A.3	6dB Bandwidth Test Result	58
A.4	Output Power Test Result	64
A.5	Power Spectral Density Test Result	70
A.6	Radiated Spurious Emission Test Result	108
A.7	Radiated Restricted Band Edge Test Result	185
A.8	AC Conducted Emissions Test Result	323
Appendix B – Test Setup Photograph		325
Appendix C – EUT Photograph		326

1. General Information

1.1. Applicant

TP-LINK CORPORATION PTE. LTD.

7 Temasek Boulevard #29-03 Suntec Tower One, Singapore 038987

1.2. Manufacturer

TP-LINK CORPORATION PTE. LTD.

7 Temasek Boulevard #29-03 Suntec Tower One, Singapore 038987

1.3. Testing Facility

<input checked="" type="checkbox"/>	<p>Test Site – MRT Suzhou Laboratory</p> <hr/> <p>Laboratory Location (Suzhou - Wuzhong) D8 Building, No.2 Tian’edang Rd., Wuzhong Economic Development Zone, Suzhou, China</p> <p>Laboratory Location (Suzhou - SIP) 4b Building, Liando U Valley, No.200 Xingpu Rd., Shengpu Town, Suzhou Industrial Park, China</p> <hr/> <p>Laboratory Accreditations</p> <p>A2LA: 3628.01 CNAS: L10551 FCC: CN1166 ISED: CN0001</p> <p>VCCI: <input type="checkbox"/>R-20025 <input type="checkbox"/>G-20034 <input type="checkbox"/>C-20020 <input type="checkbox"/>T-20020 <input type="checkbox"/>R-20141 <input type="checkbox"/>G-20134 <input type="checkbox"/>C-20103 <input type="checkbox"/>T-20104</p>
<input checked="" type="checkbox"/>	<p>Test Site – MRT Shenzhen Laboratory</p> <hr/> <p>Laboratory Location (Shenzhen) 1G, Building A, Junxiangda Building, Zhongshanyuan Road West, Nanshan District, Shenzhen, China</p> <hr/> <p>Laboratory Accreditations</p> <p>A2LA: 3628.02 CNAS: L10551 FCC: CN1284 ISED: CN0105</p>
<input type="checkbox"/>	<p>Test Site – MRT Taiwan Laboratory</p> <hr/> <p>Laboratory Location (Taiwan) No. 38, Fuxing 2nd Rd., Guishan Dist., Taoyuan City 333, Taiwan (R.O.C.)</p> <hr/> <p>Laboratory Accreditations</p> <p>TAF: 3261 FCC: 291082, TW3261 ISED: TW3261</p>

1.4. Product Information

Product Name	AXE5400 Tri-Band Wi-Fi 6E Range Extender
Model No.	RE815XE
EUT Identification No.	20230719Sample#02 (For Radiated) 20230719Sample#01 (For Conducted)
Wi-Fi Specification	802.11a/b/g/n/ac/ax
Antenna Information	Refer to section 1.7
Working Voltage	AC 100-240V~50/60Hz
Operating Environment	Indoor Use
Remark: The information of EUT was provided by the manufacturer, and the accuracy of the information shall be the responsibility of the manufacturer.	

1.5. Radio Specification under Test

Frequency Range	For 802.11a/n-HT20/ac-VHT20/ax-HE20: 5180~5240MHz, 5260~5320MHz, 5500~5720MHz, 5745~5825MHz For 802.11n-HT40/ac-VHT40/ax-HE40: 5190~5230MHz, 5270~5310MHz, 5510~5710MHz, 5755~5795MHz For 802.11ac-VHT80/ax-HE80: 5210MHz, 5290MHz, 5530MHz, 5610 MHz, 5690MHz, 5775MHz For 802.11ac-VHT160/ax-HE160: 5250MHz, 5570MHz	
Type of Modulation	802.11a/n/ac: OFDM 802.11ax: OFDMA	
Data Rate	802.11a: 6/9/12/18/24/36/48/54Mbps 802.11n: up to 300Mbps 802.11ac: up to 1733.4Mbps 802.11ax: up to 2402Mbps	
Channel Puncturing Function	<input type="checkbox"/> Supported	<input checked="" type="checkbox"/> Unsupported
Support RU	<input checked="" type="checkbox"/> Full RU	<input type="checkbox"/> Partial RU

1.6. Working Frequencies

802.11a/n-HT20/ac-VHT20/ax-HE20

Channel	Frequency	Channel	Frequency	Channel	Frequency
36	5180 MHz	40	5200 MHz	44	5220 MHz
48	5240 MHz	52	5260 MHz	56	5280 MHz
60	5300 MHz	64	5320 MHz	100	5500 MHz
104	5520 MHz	108	5540 MHz	112	5560 MHz
116	5580 MHz	120	5600 MHz	124	5620 MHz
128	5640 MHz	132	5660 MHz	136	5680 MHz
140	5700 MHz	144	5720 MHz	149	5745 MHz
153	5765 MHz	157	5785 MHz	161	5805 MHz
165	5825 MHz	--	--	--	--

802.11n-HT40/ac-VHT40/ax-HE40

Channel	Frequency	Channel	Frequency	Channel	Frequency
38	5190 MHz	46	5230 MHz	54	5270 MHz
62	5310 MHz	102	5510 MHz	110	5550MHz
118	5590 MHz	126	5630 MHz	134	5670 MHz
142	5710 MHz	151	5755 MHz	159	5795 MHz

802.11ac-VHT80/ax-HE80

Channel	Frequency	Channel	Frequency	Channel	Frequency
42	5210 MHz	58	5290 MHz	106	5530 MHz
122	5610 MHz	138	5690 MHz	155	5775 MHz

802.11ac-VHT160/ax-HE160

Channel	Frequency	Channel	Frequency	Channel	Frequency
50	5250 MHz	114	5570 MHz	--	--

1.7. Antenna Details

Antenna Type	Frequency Band (MHz)	Tx Paths	Number of spatial streams	Antenna Gain (dBi)		Beamforming Directional Gain (dBi)	CDD Directional Gain (dBi)	
				Ant 1	Ant 2		For Power	For PSD
Dipole	2400 ~ 2483.5	2	1	3.00	3.00	6.01	3.00	6.01
	5150 ~ 5850	2	1	3.00	3.00	6.01	3.00	6.01
	5925 ~ 7125	2	1	2.00	2.00	5.01	2.00	5.01
			2	2.00	2.00	--	2.00	2.00

Remark:

- The EUT supports Cyclic Delay Diversity (CDD) mode, and CDD signals are correlated.
 If all antennas have the same gain, G_{ANT} , Directional gain = $G_{ANT} + \text{Array Gain}$, where Array Gain is as follows.
 - For power spectral density (PSD) measurements on all devices,
 Array Gain = $10 \log (N_{ANT} / N_{SS})$ dB;
 - For power measurements on IEEE 802.11 devices,
 Array Gain = 0 dB for $N_{ANT} \leq 4$;
- The EUT also supports Beam Forming mode, and the Beam Forming support 802.11n/ac/ax, not include 802.11a/b/g.
 BF Directional gain = $G_{ANT} + 10 \log (N_{ANT})$.
- The information as above is from the antenna report.

Test Mode	Tx Paths	CDD Mode	Beamforming Mode
802.11b/g (DTS)	2	√	X
802.11n/ax (DTS)	2	√	√
802.11a (NII)	2	√	X
802.11n/ac/ax (NII)	2	√	√
802.11ax (6ID & 6PP)	2	√	√

Remark: "√" means "Support", "X" means "Not support".

2. Test Configuration

2.1. Test Mode

CDD Mode
Mode 1: Transmit by 802.11a_Nss=1 (6Mbps)
Mode 2: Transmit by 802.11ac-VHT20_Nss=1 (MCS0)
Mode 3: Transmit by 802.11ac-VHT40_Nss=1 (MCS0)
Mode 4: Transmit by 802.11ac-VHT80_Nss=1 (MCS0)
Mode 5: Transmit by 802.11ac-VHT160_Nss=1 (MCS0)
Mode 6: Transmit by 802.11ax-HE20_Nss=1 (MCS0)
Mode 7: Transmit by 802.11ax-HE40_Nss=1 (MCS0)
Mode 8: Transmit by 802.11ax-HE80_Nss=1 (MCS0)
Mode 9: Transmit by 802.11ax-HE160_Nss=1 (MCS0)
Beamforming Mode
Mode 10: Transmit by 802.11ac-VHT20_Nss=1 (MCS0)
Mode 11: Transmit by 802.11ac-VHT40_Nss=1 (MCS0)
Mode 12: Transmit by 802.11ac-VHT80_Nss=1 (MCS0)
Mode 13: Transmit by 802.11ac-VHT160_Nss=1 (MCS0)
Mode 14: Transmit by 802.11ax-HE20_Nss=1 (MCS0)
Mode 15: Transmit by 802.11ax-HE40_Nss=1 (MCS0)
Mode 16: Transmit by 802.11ax-HE80_Nss=1 (MCS0)
Mode 17: Transmit by 802.11ax-HE160_Nss=1 (MCS0)
Note:
<ol style="list-style-type: none"> For Radiated emission, the modulation and the data rate picked for testing are determined by the Max. RF conducted power. For CDD mode, this device supports 2 N_{ss} and power level is the same of spatial multiplexing. The worst case is N_{ss}=1. Due to CDD mode was the worst mode, so all test items were evaluated in this report. The beamforming mode only evaluated the RF output power. Due to the same modulation between 802.11n and 802.11ac, so 802.11n-HT20 and HT40 are covered by 802.11ac-VHT20 and VHT40 in this report, meanwhile, power level for 802.11n-HT20 and HT40 will not be greater than 802.11ac-VHT20 and VHT40. As Designated by manufacturer, the lowest data rate was the worst condition, so all the tests were done with lowest data rate.

2.2. Test System Connection Diagram

The device was tested per the guidance ANSI C63.10: 2013 was used to reference the appropriate EUT setup for radiated emissions testing and AC line conducted testing.

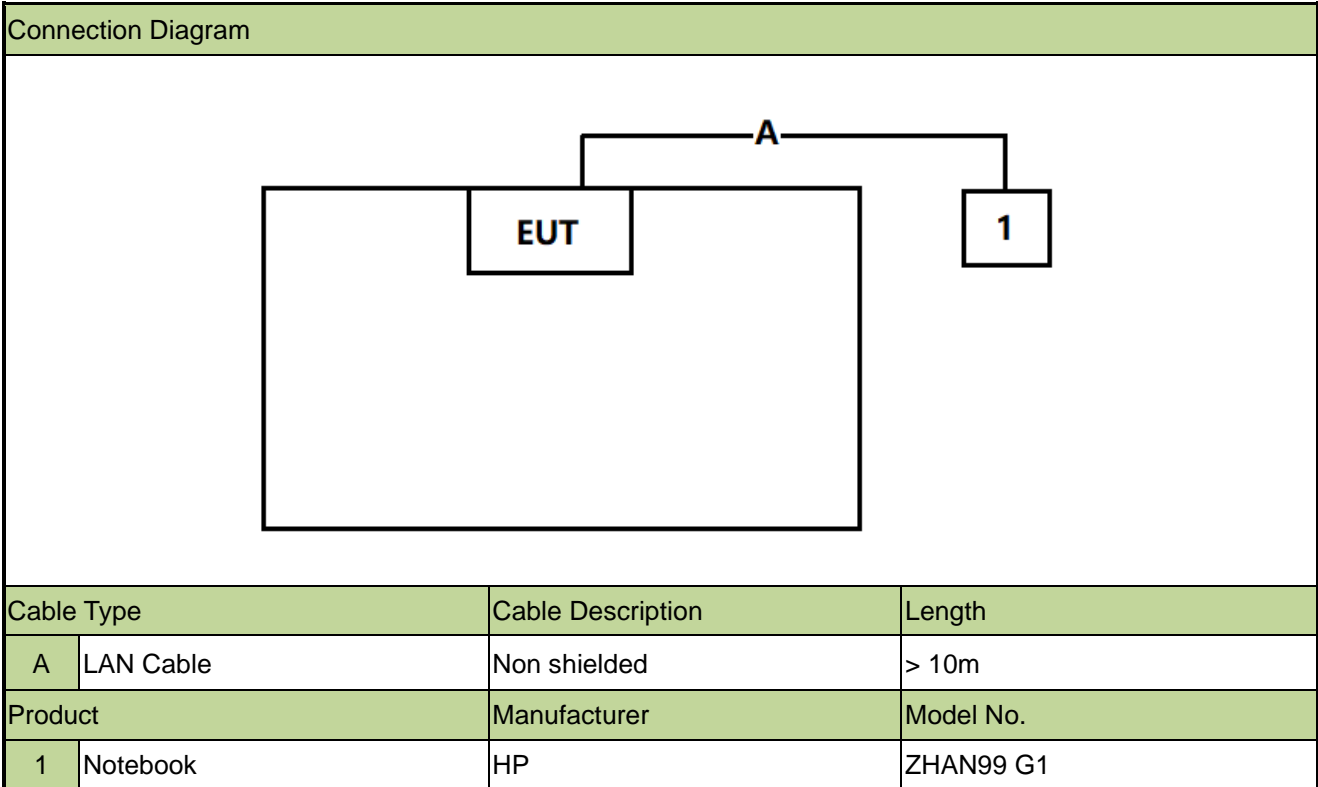

2.3. Test Software

The test utility software used during testing was “QDART”, and the version was 1.0.67.

Note: Final power setting please refer to operational description.

2.4. Applied Standards

According to the specifications of the manufacturer, the EUT must comply with the requirements of the following standards:

- FCC Part 15.407
- KDB 789033 D02v02r01
- KDB 662911 D01v02r01
- ANSI C63.10-2013

2.5. Test Environment Condition

Ambient Temperature	15 ~ 35°C
Relative Humidity	20 ~ 75%RH

3. Antenna Requirements

Excerpt from §15.203 of the FCC Rules/Regulations:

“An intentional radiator antenna shall be designed to ensure that no antenna other than that furnished by the responsible party can be used with the device. The use of a permanently attached antenna or of an antenna that uses a unique coupling to the intentional radiator shall be considered sufficient to comply with the provisions of this section.”

- The antenna of the device is **permanently attached**.
- There are no provisions for connection to an external antenna.

Conclusion:

The unit complies with the requirement of §15.203.

4. Measuring Instrument

Instrument	Manufacturer	Model No.	Asset No.	Cali. Interval	Cali. Due Date	Test Site
USB Power Sensor	Keysight	U2021XA	MRTSUE06581	1 year	2024-06-30	NS-TR2
Thermohygrometer	DELI	NO.8813	MRTSUE06783	1 year	2024-12-05	NS-TR2
Horn Antenna	Schwarzbeck	BBHA 9170	MRTSUE06292	1 year	2024-10-21	NS-AC1
Anechoic Chamber	BOOMWAVE	NS-AC1	MRTSUE06496	1 year	2024-07-12	NS-AC1
Horn Antenna	Schwarzbeck	BBHA 9120D	MRTSUE06572	1 year	2024-03-31	NS-AC1
TRILOG Antenna	Schwarzbeck	VULB 9162	MRTSUE06573	1 year	2024-06-09	NS-AC1
Preamplifier	Schwarzbeck	BBV 9718	MRTSUE06574	1 year	2024-07-07	NS-AC1
EMI Test Receiver	R&S	ESR3	MRTSUE06575	1 year	2024-06-18	NS-AC1
Preamplifier	EMCI	EMC184045SE	MRTSUE06641	1 year	2024-01-12	NS-AC1
Thermohygrometer	testo	608-H1	MRTSUE11020	1 year	2024-05-03	NS-AC1
Signal Analyzer	Agilent	N9010A	MRTSUE06195	1 year	2024-12-10	NS-AC1/NS-TR2
Signal Analyzer	Keysight	N9020A	MRTSUE10065	1 year	2024-12-10	NS-AC1/NS-TR2
EMI Test Receiver	R&S	ESR7	MRTSUE06001	1 year	2024-12-17	WZ-AC1
Loop Antenna	Schwarzbeck	FMZB 1519	MRTSUE06025	1 year	2024-09-17	WZ-AC1
Thermohygrometer	testo	608-H1	MRTSUE11039	1 year	2024-10-25	WZ-AC1
Attenuator	MVE	MVE2213	MRTSUE11063	1 year	2024-06-08	NS
Attenuator	MVE	MVE2213	MRTSUE11064	1 year	2024-06-08	NS
Attenuator	MVE	MVE2213	MRTSUE11065	1 year	2024-06-08	NS
Attenuator	MVE	MVE2213	MRTSUE11066	1 year	2024-06-08	NS
Attenuator	MVE	MVE2213	MRTSUE11067	1 year	2024-06-08	NS
Shielding Room	BOOMWAVE	NS-SR2	MRTSUE06551	5 years	2024-06-03	NS-SR2
EMI Test Receiver	R&S	ESL3	MRTSUE06576	1 year	2024-06-18	NS-SR2
Two-Line V-Network	R&S	ENV216	MRTSUE06577	1 year	2024-04-25	NS-SR2
Two-Line V-Network	R&S	ENV216	MRTSUE06578	1 year	2024-04-25	NS-SR2
Thermohygrometer	testo	608-H1	MRTSUE11106	1 year	2024-05-03	NS-SR2

Software	Version	Function
EMI Software	V3.0.0	EMI Test Software
Agilent Power Panel	V 3.9	Power
Controller_T-E-TAC-2	1.02	RE Antenna & Turntable
Controller_MF 7802	2.03C	RE Antenna & Turntable

5. Decision Rules and Measurement Uncertainty

5.1. Decision Rules

The Decision Rule is based on Simple Acceptance in accordance with ISO Guide 98-4: 2012 Clause 8.2. (Measurement uncertainty is not taken into account when stating conformity with a specified requirement.)

5.2. Measurement Uncertainty

Where relevant, the following test uncertainty levels have been estimated for tests performed on the EUT as specified in CISPR 16-4-2. This uncertainty represents an expanded uncertainty expressed at approximately the 95% confidence level using a coverage factor of $k = 2$.

AC Conducted Emission Measurement
The maximum measurement uncertainty is evaluated as: 9kHz~150kHz: 3.58dB 150kHz~30MHz: 3.20dB
Radiated Emission Measurement
The maximum measurement uncertainty is evaluated as: Coaxial: 9kHz~30MHz: 2.61dB Coplanar: 9kHz~30MHz: 2.62dB Horizontal: 30MHz~200MHz: 3.79dB 200MHz~1GHz: 3.91dB 1GHz~40GHz: 4.99dB Vertical: 30MHz~200MHz: 4.06dB 200MHz~1GHz: 5.21dB 1GHz~40GHz: 4.90dB
Spurious Emissions, Conducted
Measuring Uncertainty for a Level of Confidence of 95% ($U=2Uc(y)$): 2.2dB
Output Power
Measuring Uncertainty for a Level of Confidence of 95% ($U=2Uc(y)$): 1.4dB
Power Spectrum Density
Measuring Uncertainty for a Level of Confidence of 95% ($U=2Uc(y)$): 2.2dB
Occupied Bandwidth
Measuring Uncertainty for a Level of Confidence of 95% ($U=2Uc(y)$): 2.7%

6. Test Result

6.1. Summary

FCC Section(s)	Test Description	Test Condition	Verdict
15.407(a)	26dB Bandwidth	Conducted	Pass
15.407(e)	6dB Bandwidth		Pass
15.407(a)(1)(ii), (2), (3)(i)	Maximum Conducted Output Power		Pass
15.407(h)(1)	Transmit Power Control		Pass
15.407(g)	Frequency Stability		Pass
15.407(a)(1)(ii), (2), (3)(i), (12)	Peak Power Spectral Density		Pass
15.407(b)(1), (2), (3), (4)(i)	Undesirable Emissions	Radiated	Pass
15.205, 15.209 15.407(b)(8), (9), (10)	General Field Strength Limits (Restricted Bands and Radiated Emission Limits)		Pass
15.207	AC Conducted Emissions 150kHz - 30MHz	Line Conducted	Pass

Remark:

- The analyzer plots shown in this section were all taken with a correction table loaded into the analyzer. The correction table was used to account for the losses of the cables and attenuators used as part of the system to connect the EUT to the analyzer at all frequencies of interest.
- For radiated emission tests, every axis (X, Y, Z) was also verified. The test results shown in the following sections represent the worst-case emissions.

6.2. 26dB & 99% Bandwidth Measurement

6.2.1. Test Limit

N/A

6.2.2. Test Procedure

KDB 789033 D02v02r01- Section II)C)1) (26dB Bandwidth)

KDB 789033 D02v02r01- Section II)D) (99% Bandwidth)

6.2.3. Test Setting

26dB Bandwidth

1. The analyzers' automatic bandwidth measurement capability was used to perform the 26dB bandwidth
2. RBW = approximately 1% of the emission bandwidth.
3. VBW > RBW
4. Detector = Peak.
5. Trace mode = max hold.
6. Measure the maximum width of the emission that is 26 dB down from the maximum of the emission.
Compare this with the RBW setting of the analyzer. Readjust RBW and repeat measurement as needed until the RBW/EBW ratio is approximately 1%.

99% Bandwidth

1. Set center frequency to the nominal EUT channel center frequency.
2. RBW = 1% to 5% of the OBW
3. VBW $\geq 3 \times$ RBW
4. Span = 1.5 times to 5 times the OBW
5. Detector = peak
6. Trace mode = max hold
7. Allow the trace to stabilize
8. Use the 99% power bandwidth function of the instrument.

6.2.4. Test Setup

Spectrum Analyzer

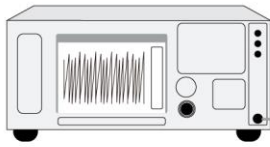

DC Block
&
Attenuator



6.2.5. Test Result

Refer to Appendix A.2.

6.3. 6dB Bandwidth Measurement

6.3.1. Test Limit

The minimum 6dB bandwidth shall be at least 500 kHz.

6.3.2. Test Procedure

KDB 789033 D02v02r01- Section II)C)2)

6.3.3. Test Setting

1. Set center frequency to the nominal EUT channel center frequency.
2. RBW = 100 kHz.
3. VBW $\geq 3 \times$ RBW.
4. Detector = Peak.
5. Trace mode = max hold.
6. Sweep = auto couple.
7. Allow the trace to stabilize.
8. Measure the maximum width of the emission that is constrained by the frequencies associated with the two outermost amplitude points (upper and lower frequencies) that are attenuated by 6 dB relative to the maximum level measured in the fundamental emission.

6.3.4. Test Setup

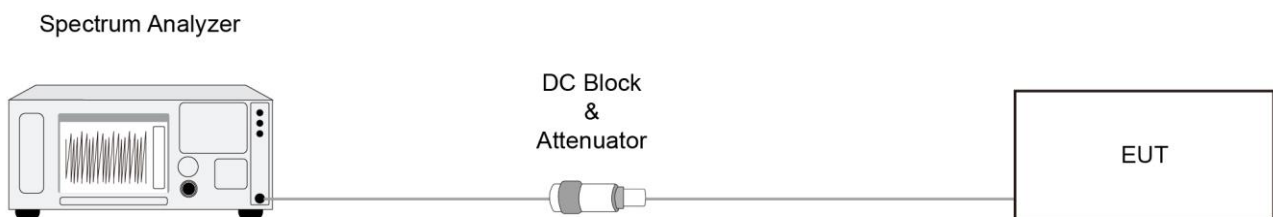

6.3.5. Test Result

Refer to Appendix A.3.

6.4. Output Power Measurement

6.4.1. Test Limit

For the band 5.15-5.25 GHz, the maximum conducted output power over the frequency band of operation shall not exceed 1 W provided the maximum antenna gain does not exceed 6 dBi.

For the 5.25-5.35 GHz and 5.47-5.725 GHz bands, the maximum conducted output power over the frequency bands of operation shall not exceed the lesser of 250 mW or $11 \text{ dBm} + 10 \log B$, where B is the 26 dB emission bandwidth in megahertz.

For the band 5.725-5.85 GHz, the maximum conducted output power over the frequency band of operation shall not exceed 1 W (30dBm).

If transmitting antennas of directional gain greater than 6dBi are used, the maximum conducted output power shall be reduced by the amount in dB that the directional gain of the antenna exceeds 6dBi.

6.4.2. Test Procedure

KDB 789033D02v02r01- Section II)E)3)b) Method PM-G

6.4.3. Test Setting

Average Power Measurement

Average power measurements were performed only when the EUT was transmitting at its maximum power control level using a broadband power meter with a pulse sensor. The power meter implemented triggering and gating capabilities which were set up such that power measurements were recorded only during the ON time of the transmitter.

6.4.4. Test Setup

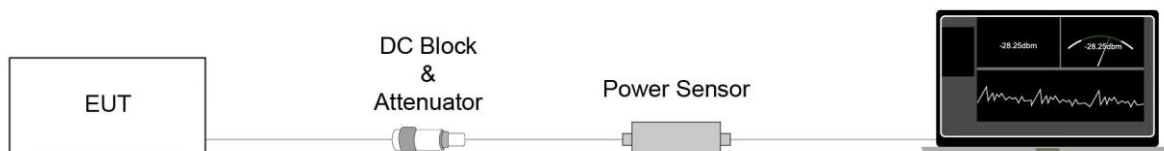

6.4.5. Test Result

Refer to Appendix A.4.

6.5. Transmit Power Control Measurement

6.5.1. Test Limit

The U-NII device is required to have the capability to operate at least 6 dB below the mean EIRP value of 30 dBm.

6.5.2. Test Procedure

KDB 789033 D02v02r01- Section II)E)3)b) Method PM-G

6.5.3. Test Setting

Average power measurements were performed only when the EUT was transmitting at its maximum power control level using a broadband power meter with a pulse sensor. The power meter implemented triggering and gating capabilities which were set up such that power measurements were recorded only during the ON time of the transmitter. The trace was averaged over 100 traces to obtain the final measured average power.

6.5.4. Test Setup

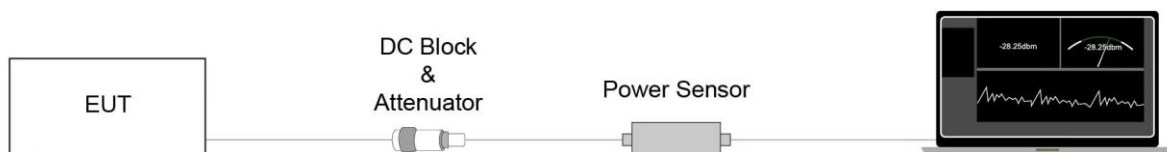

6.5.5. Test Result

Device supports TPC mechanism, details refer to the operational description.

6.6. Power Spectral Density Measurement

6.6.1. Test Limit

For the band 5.15-5.25 GHz, the maximum power spectral density shall not exceed 17 dBm in any 1 megahertz band.

For the 5.25-5.35 GHz and 5.47-5.725 GHz bands, the maximum power spectral density shall not exceed 11 dBm in any 1 megahertz band.

For the band 5.725-5.85 GHz, the maximum power spectral density shall not exceed 30 dBm in any 500-kHz band.

If transmitting antennas of directional gain greater than 6dBi are used, the peak power spectral density shall be reduced by the amount in dB that the directional gain of the antenna exceeds 6dBi.

6.6.2. Test Procedure

KDB 789033 D02v02r01-Section II)F)

6.6.3. Test Setting

1. Analyzer was set to the center frequency of the UNII channel under investigation
2. Span was set to encompass the entire 26dB EBW of the signal.
3. RBW = 1MHz (510kHz, if measurement bandwidth of Maximum PSD is specified in 500 kHz)
4. VBW = 3 × RBW
5. Number of sweep points $\geq 2 \times (\text{span} / \text{RBW})$
6. Detector = power averaging (Average)
7. Sweep time = auto
8. Trigger = free run
9. Trace average at least 100 traces in power averaging (rms) mode; however, the number of traces to be averaged shall be increased above 100 as needed to ensure that the average accurately represents the true average over the on and off periods of the transmitter.
10. Use the peak search function on the instrument to find the peak of the spectrum and record its value.
11. Add $10 \cdot \log(1/x)$, where x is the duty cycle, to the measured power in order to compute the average power during the actual transmission times (because the measurement represents an average over both the on and off times of the transmission). For example, add $10 \cdot \log(1/0.25) = 6$ dB if the duty cycle is 25 percent.

6.6.4. Test Setup

Spectrum Analyzer

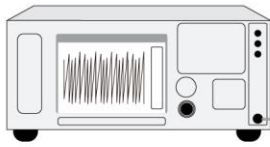

DC Block
&
Attenuator



6.6.5. Test Result

Refer to Appendix A.5.

6.7. Frequency Stability Measurement

6.7.1. Test Limit

Manufactures of U-NII devices are responsible for ensuring frequency stability such that an emission is maintained within the band of operation under all conditions of normal operation as specified in the user's manual.

6.7.2. Test Procedure

Frequency Stability Under Temperature Variations:

The equipment under test was connected to an external AC or DC power supply and input rated voltage. RF output was connected to a frequency counter or spectrum analyzer via feed through attenuators. The EUT was placed inside the temperature chamber. Set the spectrum analyzer RBW low enough to obtain the desired frequency resolution and measure EUT 20°C operating frequency as reference frequency. Turn EUT off and set the chamber temperature to highest. After the temperature stabilized for approximately 30 minutes recorded the frequency. Repeat step measure with 10°C decreased per stage until the lowest temperature reached.

Frequency Stability Under Voltage Variations:

Set chamber temperature to 20°C. Use a variable AC power supply / DC power source to power the EUT and set the voltage to rated voltage. Set the spectrum analyzer RBW low enough to obtain the desired frequency resolution and recorded the frequency.

Reduce the input voltage to specify extreme voltage variation ($\pm 15\%$) and endpoint, record the maximum frequency change.

6.7.3. Test Setup

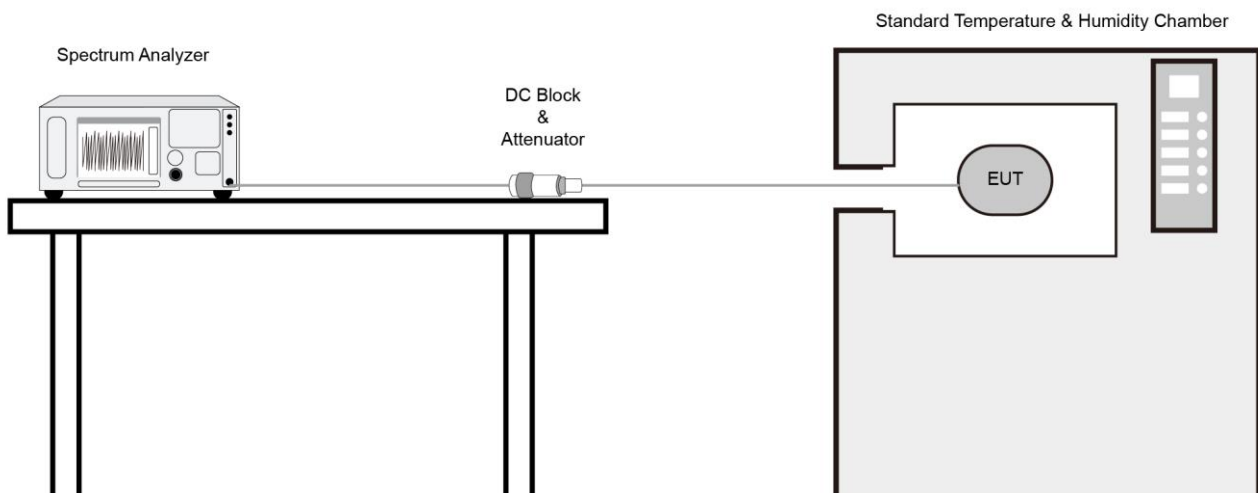

6.7.4. Test Result

Grantee ensure that the product meets e-CFR Title 47 section 15.407(g) and KDB 789033 D02v02r01 frequency stability such that the emissions are maintained within the band of operation under all conditions of normal operation as specified in the user's manual.

6.8. Radiated Spurious Emission Measurement

6.8.1. Test Limit

All out of band emissions appearing in a restricted band as specified in Section 15.205 of the Title 47 CFR must not exceed the limits shown in Table per Section 15.209.

FCC Part 15 Subpart C Paragraph 15.209		
Frequency [MHz]	Field Strength [uV/m]	Measured Distance [Meters]
0.009 - 0.490	2400/F (kHz)	300
0.490 - 1.705	24000/F (kHz)	30
1.705 - 30	30	30
30 - 88	100	3
88 - 216	150	3
216 - 960	200	3
Above 960	500	3

6.8.2. Test Procedure

KDB 789033 D02v02r01- Section II)G)

6.8.3. Test Setting

Table 1 - RBW as a function of frequency

Frequency	RBW
9 ~ 150 kHz	200 ~ 300 Hz
0.15 ~ 30 MHz	9 ~ 10 kHz
30 ~ 1000 MHz	100 ~ 120 kHz
> 1000MHz	1MHz

Quasi-Peak Measurements below 1GHz

1. Analyzer center frequency was set to the frequency of the radiated spurious emission of interest
2. Span was set greater than 1MHz
3. RBW = as specified in Table 1
4. Detector = CISPR quasi-peak
5. Sweep time = auto couple
6. Trace was allowed to stabilize

Peak Measurements above 1GHz

1. Analyzer center frequency was set to the frequency of the radiated spurious emission of interest
2. RBW = 1MHz
3. VBW = 3MHz
4. Detector = peak
5. Sweep time = auto couple
6. Trace mode = max hold
7. Trace was allowed to stabilize

Average Measurements above 1GHz (Method VB)

1. Analyzer center frequency was set to the frequency of the radiated spurious emission of interest
2. RBW = 1MHz
3. VBW; If the EUT is configured to transmit with duty cycle $\geq 98\%$, set VBW = 10 Hz.
If the EUT duty cycle is $< 98\%$, set VBW $\geq 1/T$. T is the minimum transmission duration.
4. Detector = Peak
5. Sweep time = auto
6. Trace mode = max hold
7. Trace was allowed to stabilize

6.8.4. Test Setup

Below 30MHz Test Setup:

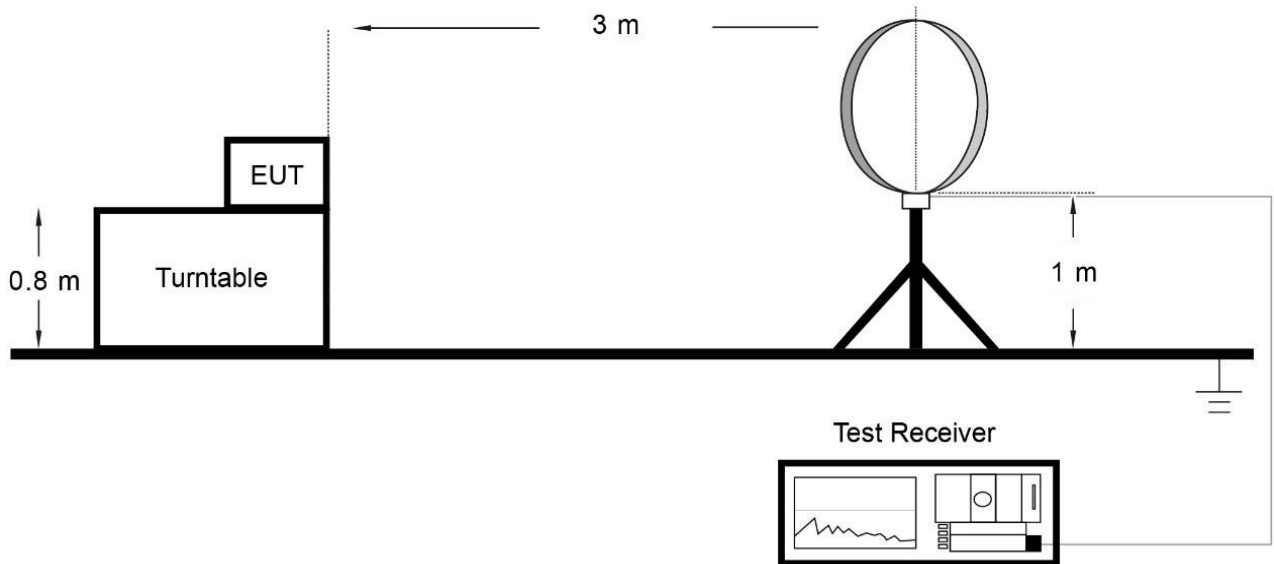

Below 1GHz Test Setup:

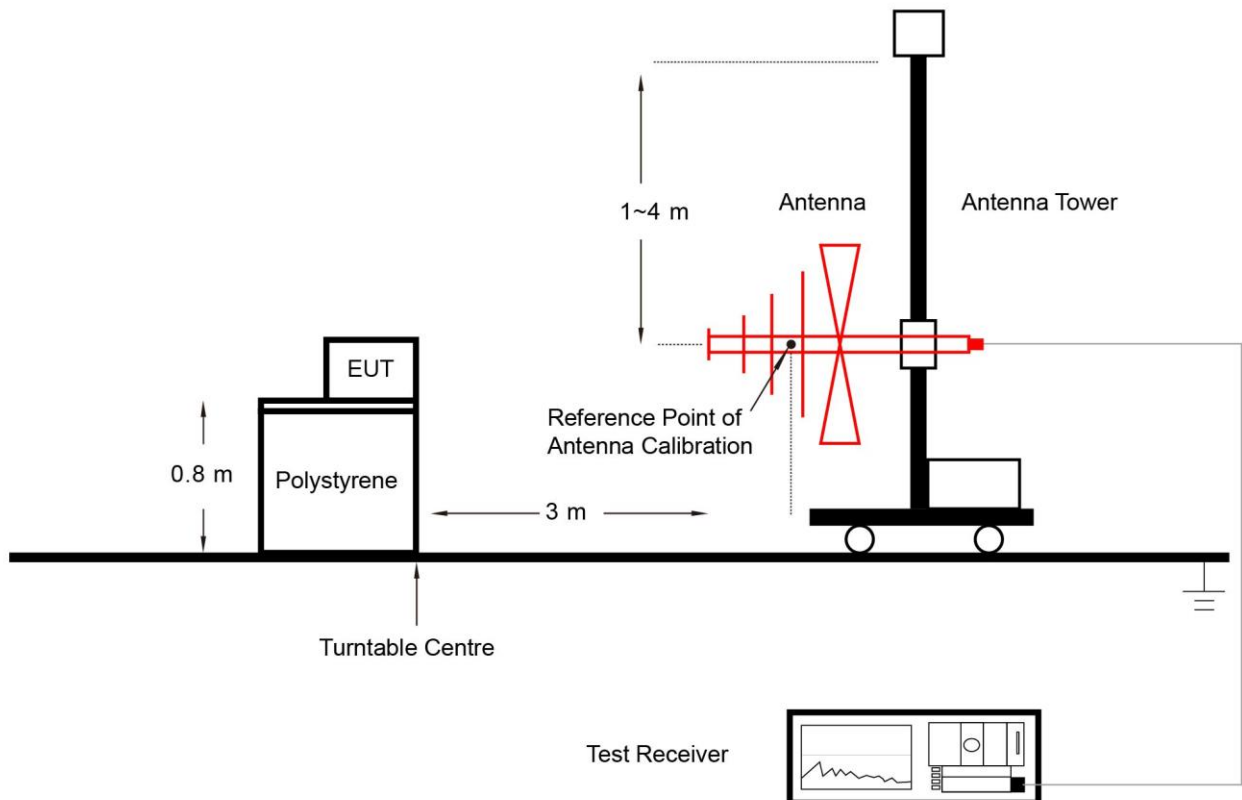

Above 1GHz Test Setup:

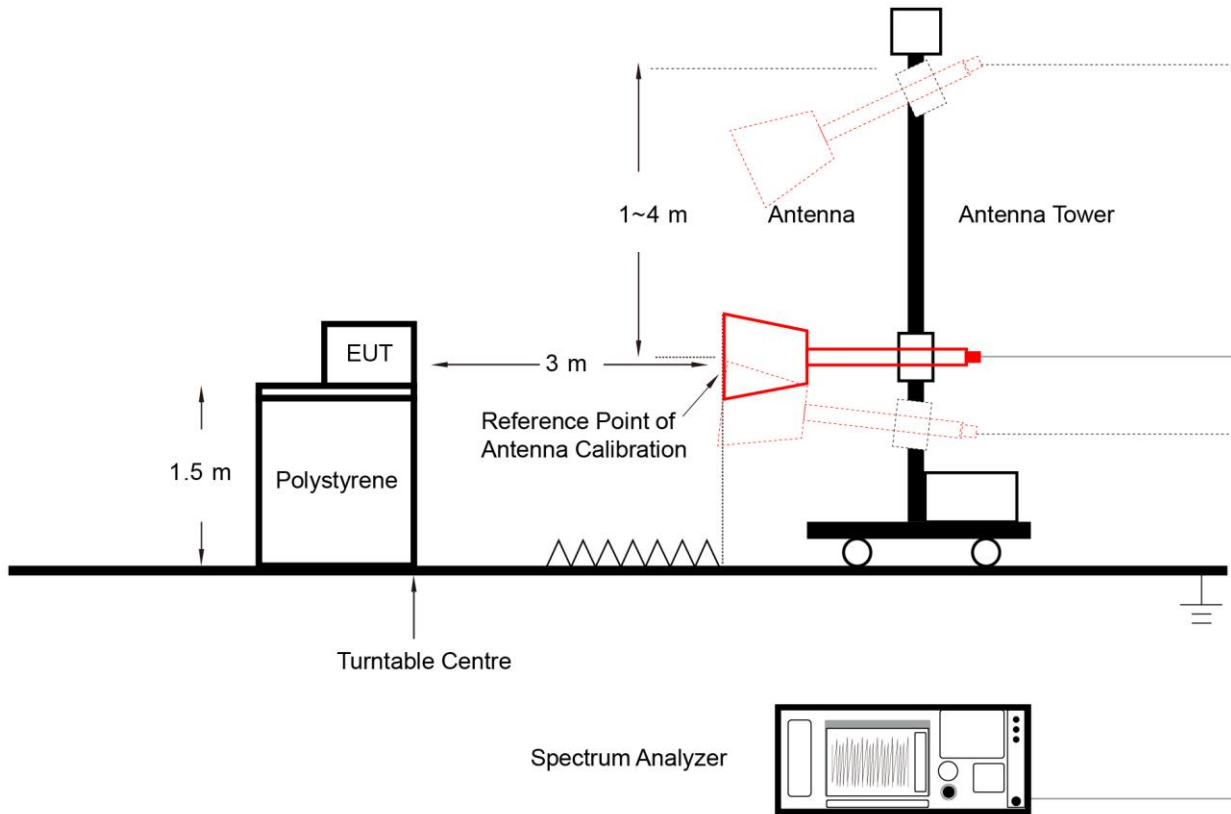

6.8.5. Test Result

Refer to Appendix A.6.

6.9. Radiated Restricted Band Edge Measurement

6.9.1. Test Limit

For 15.205 requirement:

Radiated emissions which fall in the restricted bands, as defined in Section 15.205(a) of FCC part 15, must also comply with the radiated emission limits specified in Section 15.209(a).

Frequency (MHz)	Frequency (MHz)	Frequency (MHz)	Frequency (GHz)
0.090 - 0.110	16.42 - 16.423	399.9 - 410	4.5 - 5.15
¹ 0.495 - 0.505	16.69475 - 16.69525	608 - 614	5.35 - 5.46
2.1735 - 2.1905	16.80425 - 16.80475	960 - 1240	7.25 - 7.75
4.125 - 4.128	25.5 - 25.67	1300 - 1427	8.025 - 8.5
4.17725 - 4.17775	37.5 - 38.25	1435 - 1626.5	9.0 - 9.2
4.20725 - 4.20775	73 - 74.6	1645.5 - 1646.5	9.3 - 9.5
6.215 - 6.218	74.8 - 75.2	1660 - 1710	10.6 - 12.7
6.26775 - 6.26825	108 - 121.94	1718.8 - 1722.2	13.25 - 13.4
6.31175 - 6.31225	123 - 138	2200 - 2300	14.47 - 14.5
8.291 - 8.294	149.9 - 150.05	2310 - 2390	15.35 - 16.2
8.362 - 8.366	156.52475 - 156.52525	2483.5 - 2500	17.7 - 21.4
8.37625 - 8.38675	156.7 - 156.9	2690 - 2900	22.01 - 23.12
8.41425 - 8.41475	162.0125 - 167.17	3260 - 3267	23.6 - 24.0
12.29 - 12.293	167.72 - 173.2	3332 - 3339	31.2 - 31.8
12.51975 - 12.52025	240 - 285	3345.8 - 3358	36.43 - 36.5
12.57675 - 12.57725	322 - 335.4	3600 - 4400	(²)
13.36 - 13.41	--	--	--

For 15.407(b) requirement:

For transmitters operating in the 5.15-5.25 GHz band: All emissions outside of the 5.15-5.35 GHz band shall not exceed an e.i.r.p. of -27 dBm/MHz.

For transmitters operating in the 5.25-5.35 GHz band: All emissions outside of the 5.15-5.35 GHz band shall not exceed an e.i.r.p. of -27 dBm/MHz.

For transmitters operating in the 5.47-5.725 GHz band: All emissions outside of the 5.47-5.725 GHz band shall not exceed an e.i.r.p. of -27 dBm/MHz.

For transmitters operating in the 5.725-5.85 GHz band: All emissions shall be limited to a level of -27 dBm/MHz at 75 MHz or more above or below the band edge increasing linearly to 10 dBm/MHz at 25 MHz above or below the band edge, and from 25 MHz above or below the band edge increasing linearly to a level of 15.6 dBm/MHz at 5 MHz above or below the band edge, and from 5 MHz above or below the band edge increasing linearly to a level of 27 dBm/MHz at the band edge.

Refer to KDB 789033 D02v02r01 G)2)c), as specified in § 15.407(b), emissions above 1000 MHz that are outside of the restricted bands are subject to a maximum emission limit of -27 dBm/MHz (or -17 dBm/MHz as specified in § 15.407(b)(4)). However, an out-of-band emission that complies with both the peak and average limits of § 15.209 is not required to satisfy the -27 dBm/MHz or -17 dBm/MHz maximum emission limit.

All out of band emissions appearing in a restricted band as specified in Section 15.205 of the Title 47CFR must not exceed the limits shown in Table per Section 15.209.

FCC Part 15 Subpart C Paragraph 15.209		
Frequency [MHz]	Field Strength [uV/m]	Measured Distance [Meters]
0.009 - 0.490	2400/F (kHz)	300
0.490 - 1.705	24000/F (kHz)	30
1.705 - 30	30	30
30 - 88	100	3
88 - 216	150	3
216 - 960	200	3
Above 960	500	3

6.9.2. Test Procedure

KDB 789033 D02v02r01- Section II)G)

6.9.3. Test Setting

Peak Measurements above 1GHz

1. Analyzer center frequency was set to the frequency of the radiated spurious emission of interest
2. RBW = 1MHz
3. VBW = 3MHz
4. Detector = Peak
5. Sweep time = Auto couple
6. Trace mode = Max hold
7. Trace was allowed to stabilize

Average Measurements above 1GHz (Method VB)

1. Analyzer center frequency was set to the frequency of the radiated spurious emission of interest
2. RBW = 1MHz
3. VBW; if the EUT is configured to transmit with duty cycle $\geq 98\%$, set VBW = 10Hz
4. If the EUT duty cycle is $< 98\%$, set VBW $\geq 1/T$. T is the minimum transmission duration
5. Detector = Peak
6. Sweep time = Auto
7. Trace mode = Max hold
8. Trace was allowed to stabilize

6.9.4. Test Setup

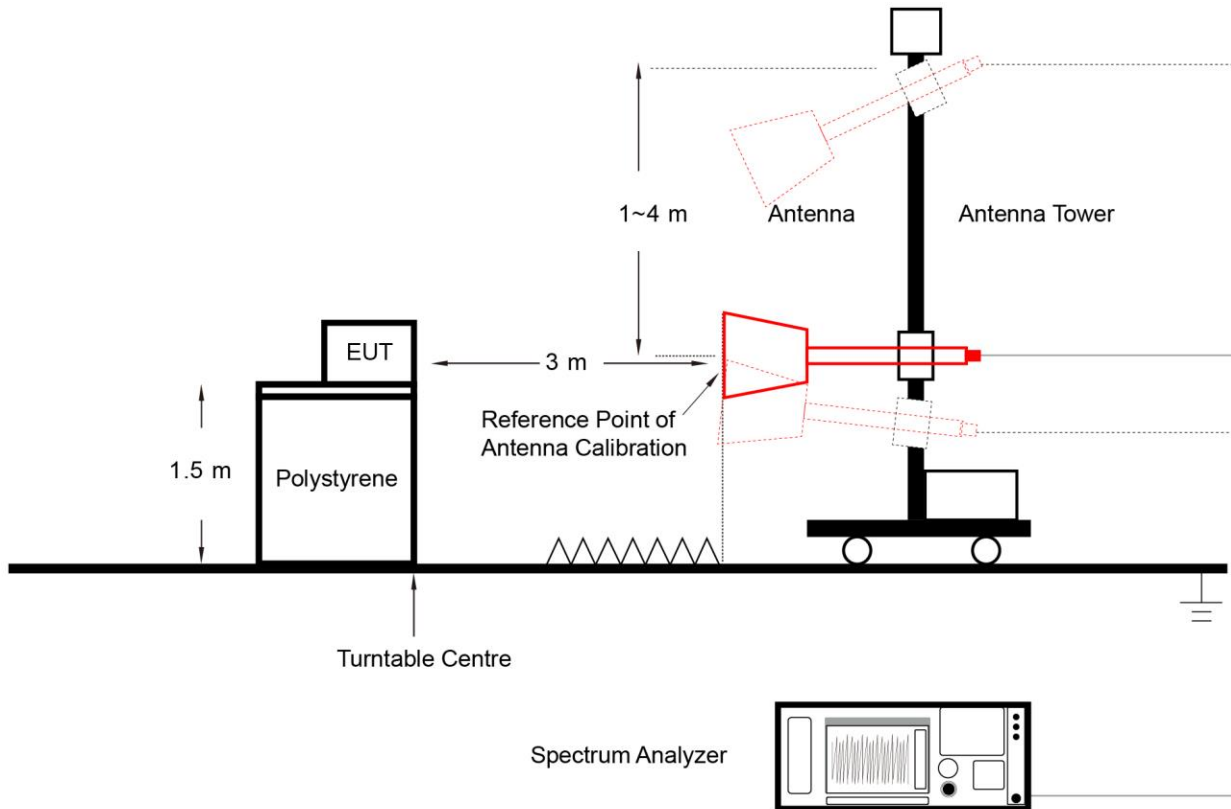

6.9.5. Test Result

Refer to Appendix A.7.

6.10. AC Conducted Emissions Measurement

6.10.1. Test Limit

FCC Part 15.207 Limits		
Frequency (MHz)	QP (dBuV)	AV (dBuV)
0.15 - 0.50	66 - 56	56 - 46
0.50 - 5.0	56	46
5.0 - 30	60	50

Note 1: The lower limit shall apply at the transition frequencies.

Note 2: The limit decreases linearly with the logarithm of the frequency in the range 0.15MHz to 0.5MHz.

6.10.2. Test Setup

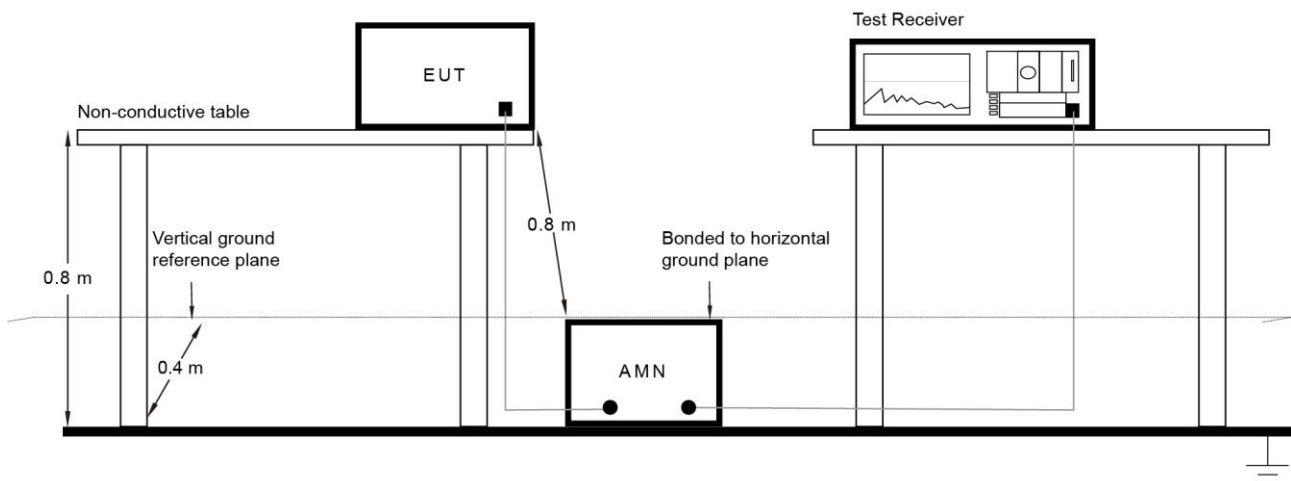

6.10.3. Test Result

Refer to Appendix A.8.

Appendix A – Test Result

A.1 Duty Cycle Test Result

Test Site	NS-TR2	Test Engineer	Summer Tang
Test Date	2023-07-27		

Test Mode	Duty Cycle
802.11a	94.27%
802.11ac-VHT20	90.93%
802.11ac-VHT40	89.78%
802.11ac-VHT80	90.00%
802.11ac-VHT160	90.43%
802.11ax-HE20	90.30%
802.11ax-HE40	91.18%
802.11ax-HE80	90.30%
802.11ax-HE160	90.25%

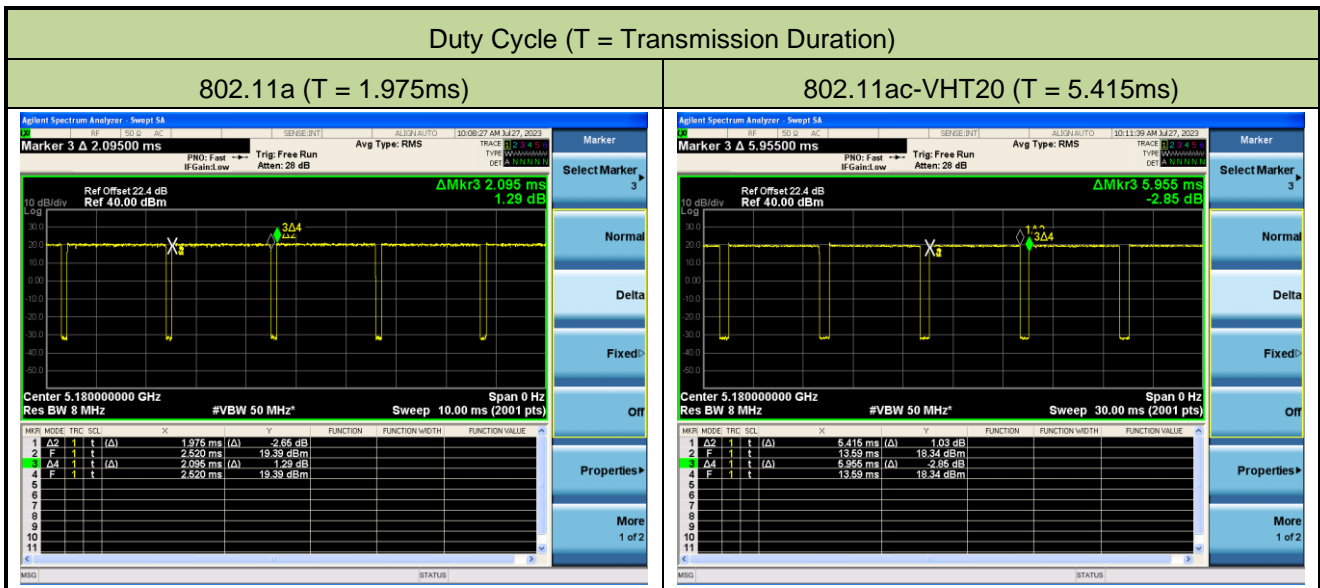

Duty Cycle (T = Transmission Duration)

802.11ac-VHT40 (T = 5.400ms)

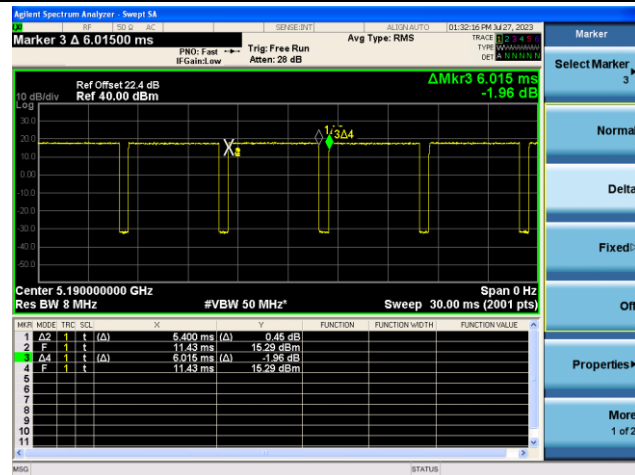

802.11ac-VHT80 (T = 5.400ms)

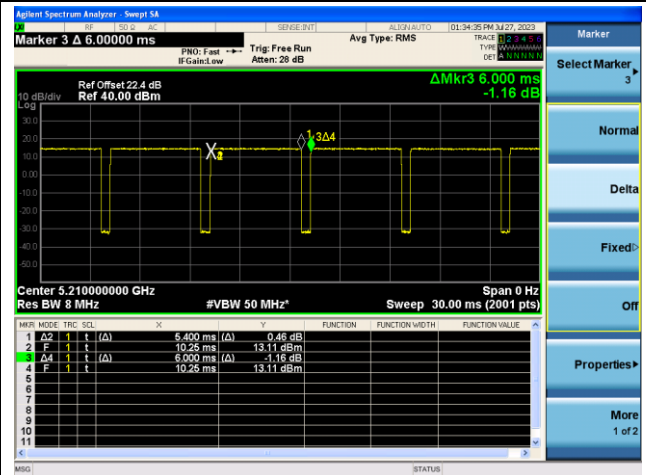

802.11ac-VHT160 (T = 5.385ms)

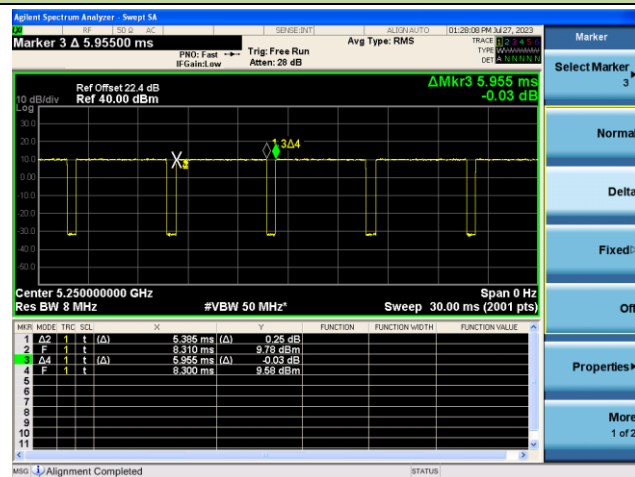

802.11ax-HE20 (T = 5.445ms)

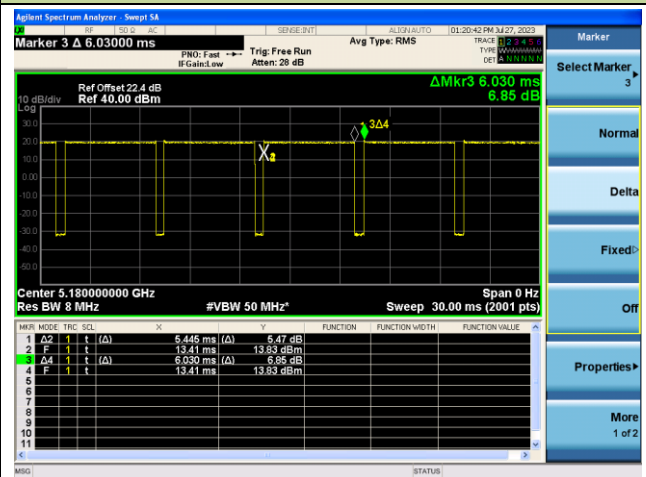

802.11ax-HE40 (T = 5.430ms)

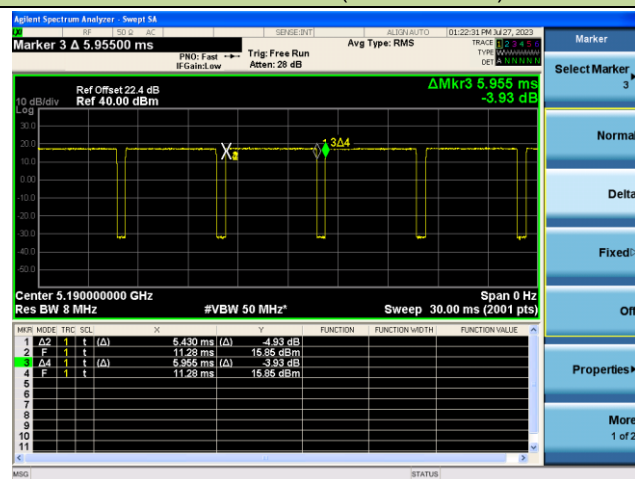

802.11ax-HE80 (T = 5.445ms)

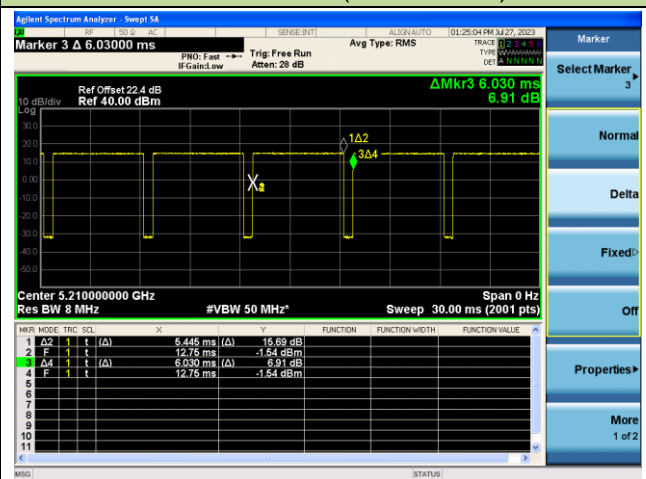

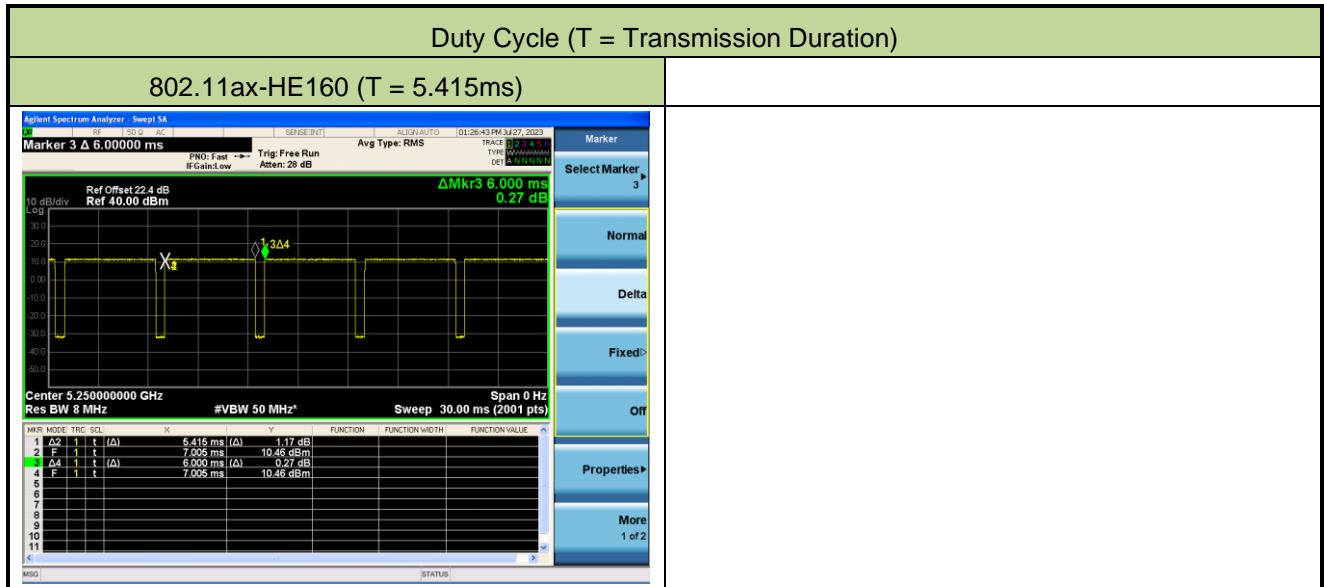

A.2 26dB Bandwidth Test Result

Test Site	NS-TR2	Test Engineer	Summer Tang
Test Date	2023-08-05		

Test Mode	Data Rate/ MCS	Channel No.	Frequency (MHz)	26dB Bandwidth (MHz)	99% Bandwidth (MHz)
11a	6Mbps	36	5180	18.82	16.299
11a	6Mbps	44	5220	18.74	16.312
11a	6Mbps	48	5240	18.89	16.340
11a	6Mbps	52	5260	18.78	16.318
11a	6Mbps	60	5300	19.38	16.302
11a	6Mbps	64	5320	18.87	16.319
11a	6Mbps	100	5500	18.94	16.314
11a	6Mbps	116	5580	19.22	16.320
11a	6Mbps	132	5660	18.88	16.314
11a	6Mbps	140	5700	18.75	16.304
11a	6Mbps	144	5720	19.98	16.317
11a	6Mbps	149	5745	19.37	16.299
11a	6Mbps	157	5785	18.76	16.309
11a	6Mbps	165	5825	28.41	16.968
11ac-VHT20	MCS0	36	5180	19.90	17.551
11ac-VHT20	MCS0	44	5220	20.07	17.512
11ac-VHT20	MCS0	48	5240	20.10	17.489
11ac-VHT20	MCS0	52	5260	20.12	17.513
11ac-VHT20	MCS0	60	5300	20.26	17.523
11ac-VHT20	MCS0	64	5320	20.63	17.528
11ac-VHT20	MCS0	100	5500	20.41	17.537
11ac-VHT20	MCS0	116	5580	20.54	17.525
11ac-VHT20	MCS0	132	5660	20.41	17.528
11ac-VHT20	MCS0	140	5700	20.55	17.513
11ac-VHT20	MCS0	144	5720	20.35	17.559
11ac-VHT20	MCS0	149	5745	19.65	17.536
11ac-VHT20	MCS0	157	5785	20.11	17.560
11ac-VHT20	MCS0	165	5825	19.63	17.550

Test Mode	Data Rate/ MCS	Channel No.	Frequency (MHz)	26dB Bandwidth (MHz)	99% Bandwidth (MHz)
11ac-VHT40	MCS0	38	5190	39.52	35.844
11ac-VHT40	MCS0	46	5230	39.20	35.926
11ac-VHT40	MCS0	54	5270	39.42	35.907
11ac-VHT40	MCS0	62	5310	39.32	35.862
11ac-VHT40	MCS0	102	5510	39.07	35.894
11ac-VHT40	MCS0	110	5550	39.18	35.908
11ac-VHT40	MCS0	134	5670	39.16	35.904
11ac-VHT40	MCS0	142	5710	39.13	35.884
11ac-VHT40	MCS0	151	5755	39.16	35.893
11ac-VHT40	MCS0	159	5795	39.17	35.936
11ac-VHT80	MCS0	42	5210	80.95	75.155
11ac-VHT80	MCS0	58	5290	80.14	74.944
11ac-VHT80	MCS0	106	5530	79.94	74.956
11ac-VHT80	MCS0	122	5610	80.65	75.034
11ac-VHT80	MCS0	138	5690	80.52	75.014
11ac-VHT80	MCS0	155	5775	80.73	74.891
11ac-VHT160	MCS0	50	5250	163.80	153.61
11ac-VHT160	MCS0	114	5570	162.90	153.46
11ax-HE20	MCS0	36	5180	21.08	18.910
11ax-HE20	MCS0	44	5220	20.51	18.834
11ax-HE20	MCS0	48	5240	20.43	18.859
11ax-HE20	MCS0	52	5260	20.56	18.830
11ax-HE20	MCS0	60	5300	20.54	18.843
11ax-HE20	MCS0	64	5320	20.30	18.842
11ax-HE20	MCS0	100	5500	20.58	18.895
11ax-HE20	MCS0	116	5580	20.39	18.891
11ax-HE20	MCS0	132	5660	20.95	18.872
11ax-HE20	MCS0	140	5700	20.61	18.848
11ax-HE20	MCS0	144	5720	20.38	18.880
11ax-HE20	MCS0	149	5745	20.50	18.871
11ax-HE20	MCS0	157	5785	20.73	18.883
11ax-HE20	MCS0	165	5825	20.55	18.891

Test Mode	Data Rate/ MCS	Channel No.	Frequency (MHz)	26dB Bandwidth (MHz)	99% Bandwidth (MHz)
11ax-HE40	MCS0	38	5190	39.73	37.674
11ax-HE40	MCS0	46	5230	40.11	37.679
11ax-HE40	MCS0	54	5270	40.09	37.541
11ax-HE40	MCS0	62	5310	39.81	37.586
11ax-HE40	MCS0	102	5510	39.99	37.666
11ax-HE40	MCS0	110	5550	40.03	37.626
11ax-HE40	MCS0	134	5670	39.96	37.585
11ax-HE40	MCS0	142	5710	39.79	37.629
11ax-HE40	MCS0	151	5755	40.19	37.698
11ax-HE40	MCS0	159	5795	40.02	37.568
11ax-HE80	MCS0	42	5210	81.32	76.818
11ax-HE80	MCS0	58	5290	80.45	76.720
11ax-HE80	MCS0	106	5530	80.78	76.652
11ax-HE80	MCS0	122	5610	80.72	76.781
11ax-HE80	MCS0	138	5690	81.11	76.964
11ax-HE80	MCS0	155	5775	80.94	76.635
11ax-HE160	MCS0	50	5250	163.60	154.80
11ax-HE160	MCS0	114	5570	163.20	154.98

Test Mode	Data Rate/ MCS	Channel No.	Frequency (MHz)	F _H (MHz)	Limit (MHz)
802.11a	6Mbps	48	5240	5248.170	< 5250
802.11ac-VHT20	MCS0	48	5240	5248.745	< 5250
802.11ac-VHT40	MCS0	46	5230	5247.963	< 5250
802.11ac-VHT80	MCS0	42	5210	5247.578	< 5250
802.11ax-HE20	MCS0	48	5240	5249.430	< 5250
802.11ax-HE40	MCS0	46	5230	5248.840	< 5250
802.11ax-HE80	MCS0	42	5210	5248.409	< 5250

Note: $F_H = \text{Centre frequency} + 99\% \text{ OBW} / 2$.

For example, 802.11a 5240MHz, $F_H = 5240 \text{ MHz} + 16.340 \text{ MHz} / 2 = 5248.170 \text{ MHz}$.

80.211a 26dB Bandwidth & 99% Bandwidth

Channel 36 (5180MHz)

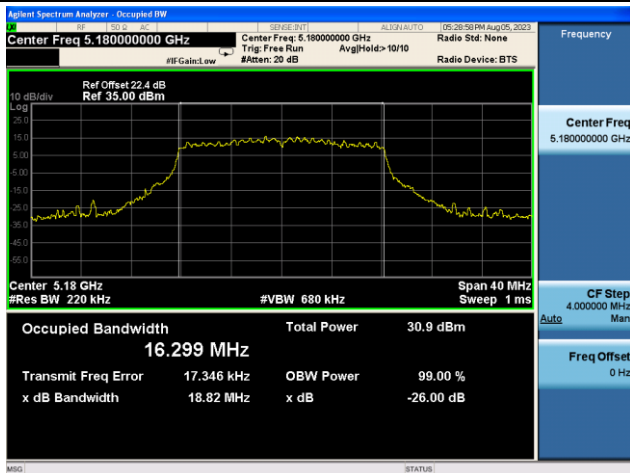

Channel 44 (5220MHz)

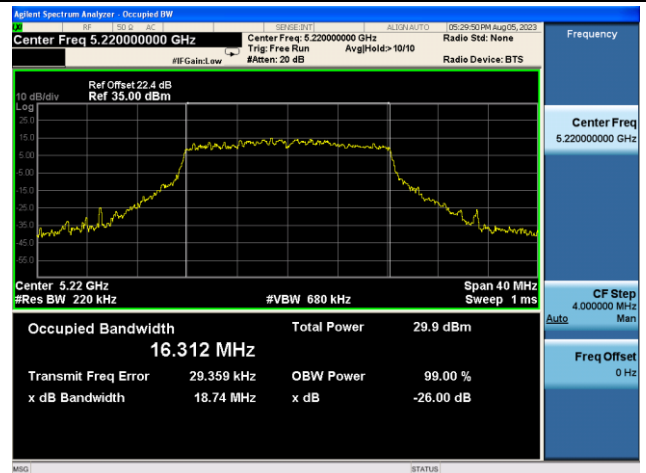

Channel 48 (5240MHz)

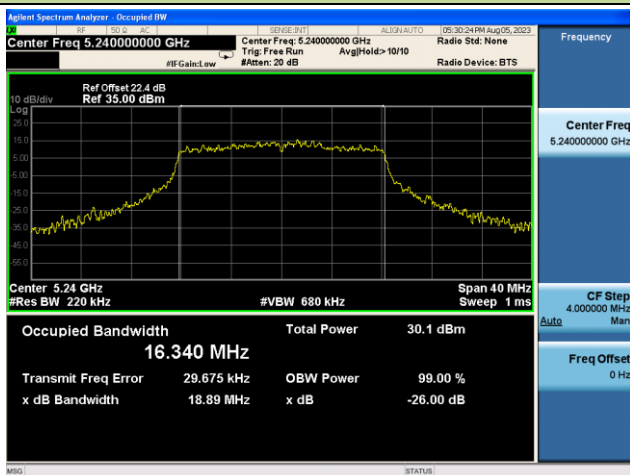

Channel 52 (5260MHz)

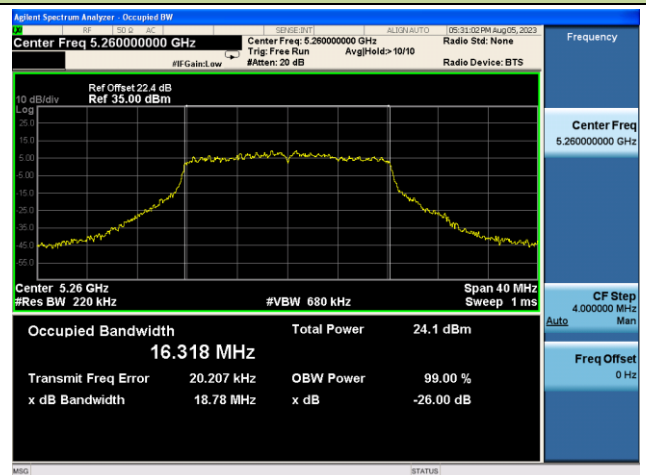

Channel 60 (5300MHz)

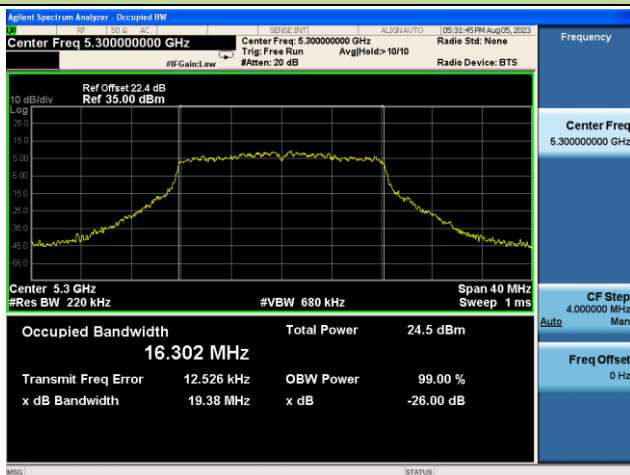

Channel 64 (5320MHz)

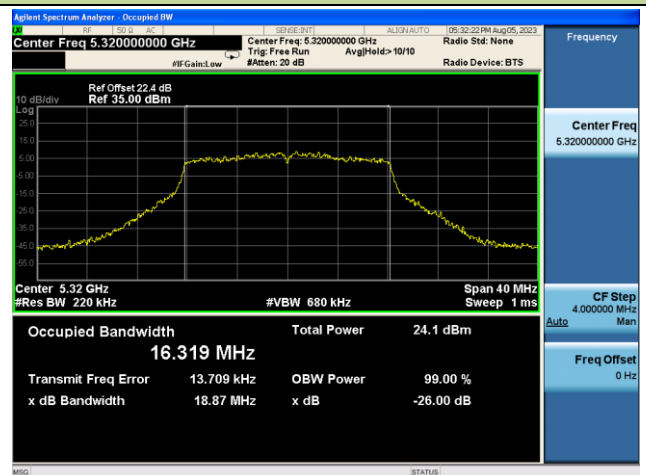

80.211a 26dB Bandwidth & 99% Bandwidth

Channel 100 (5500MHz)

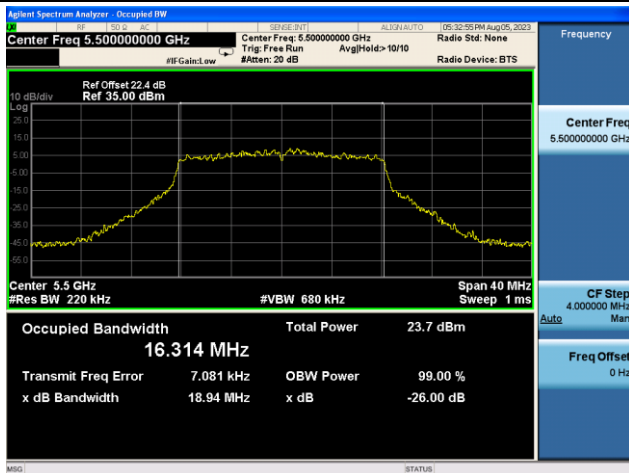

Channel 116 (5580MHz)

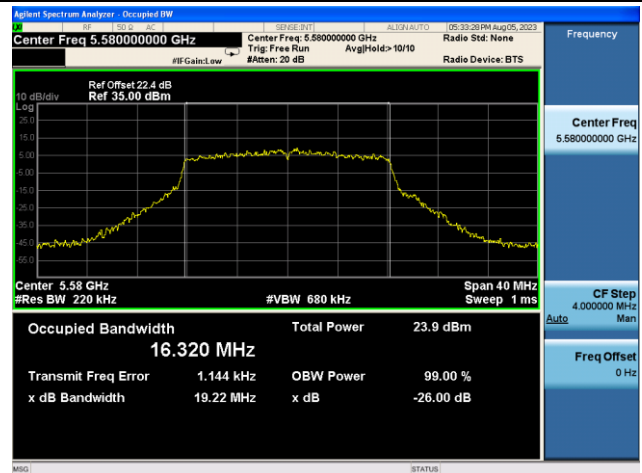

Channel 132 (5660MHz)

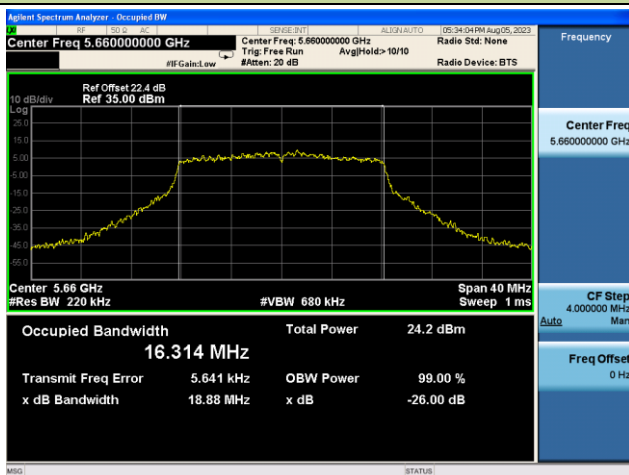

Channel 140 (5700MHz)

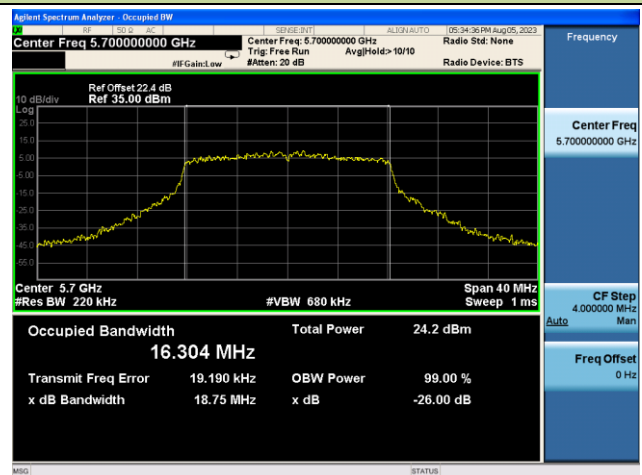

Channel 144(5720MHz)

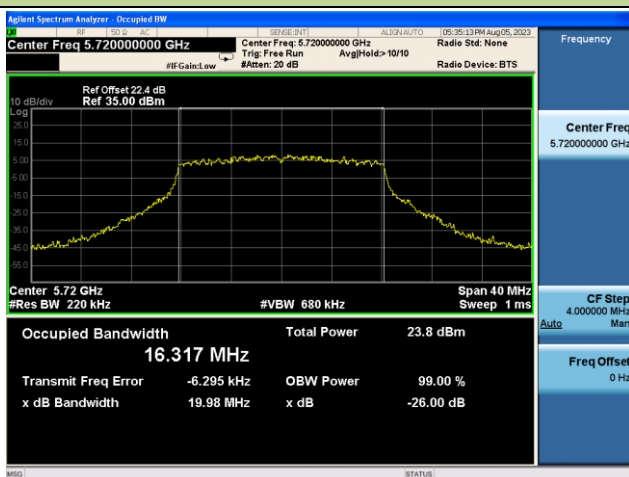

Channel 149 (5745MHz)

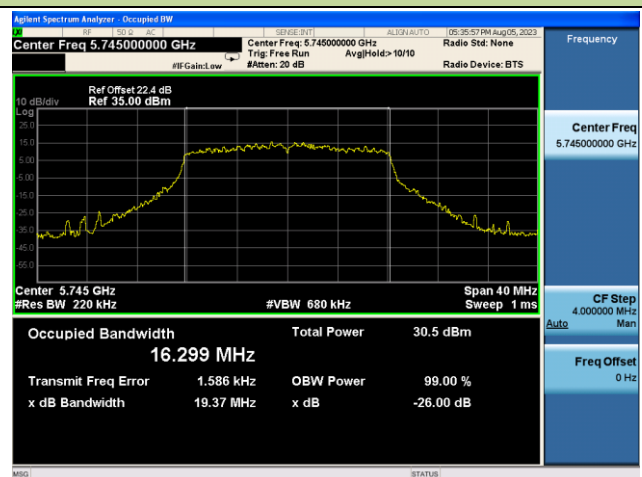

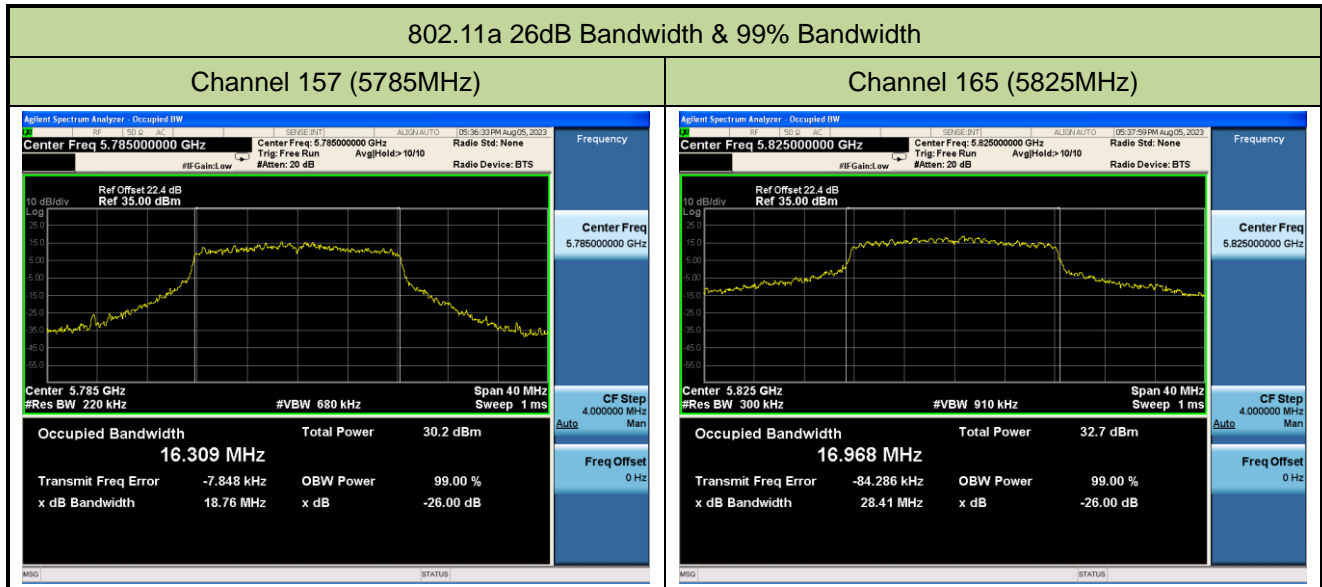

802.11ac-VHT20 26dB Bandwidth & 99% Bandwidth

Channel 36 (5180MHz)

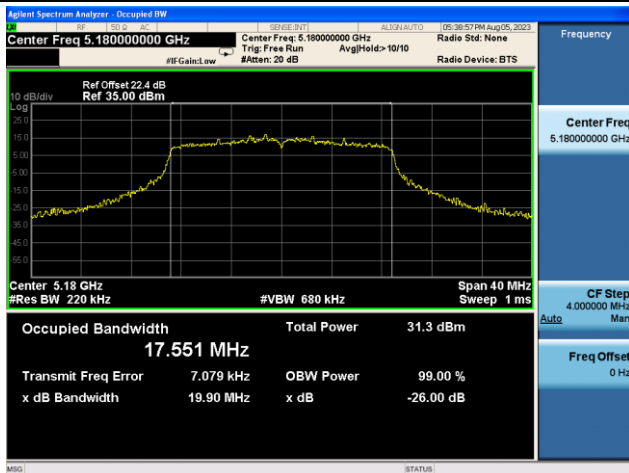

Channel 44 (5220MHz)

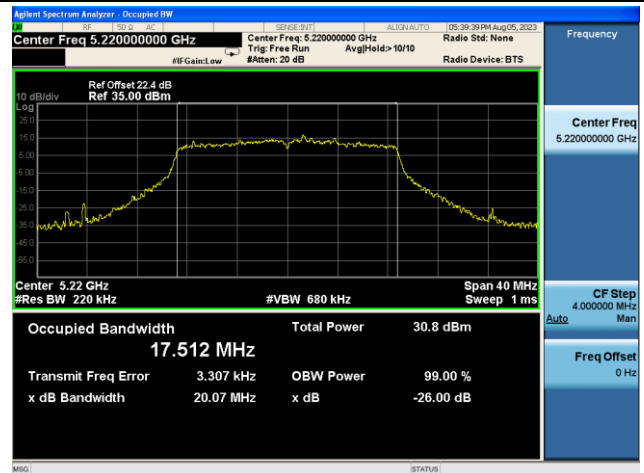

Channel 48 (5240MHz)

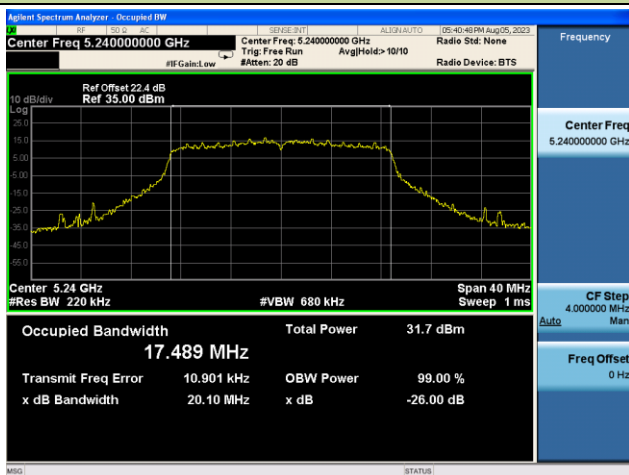

Channel 52 (5260MHz)

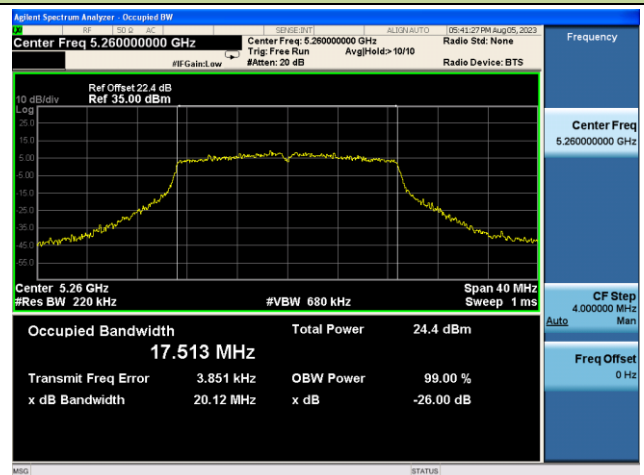

Channel 60 (5300MHz)

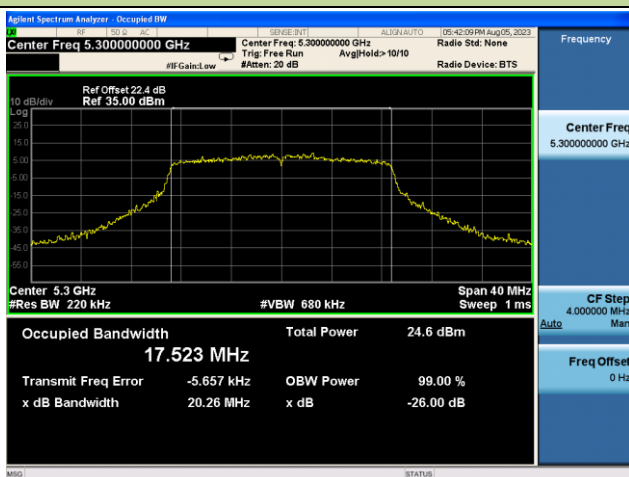

Channel 64 (5320MHz)

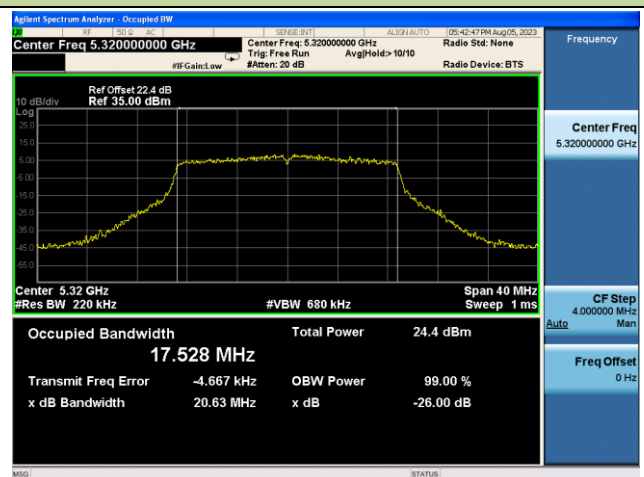

802.11ac-VHT20 26dB Bandwidth & 99% Bandwidth

Channel 100 (5500MHz)

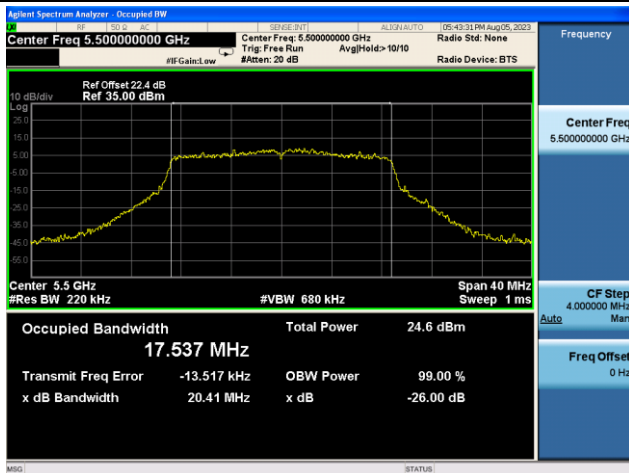

Channel 116 (5580MHz)

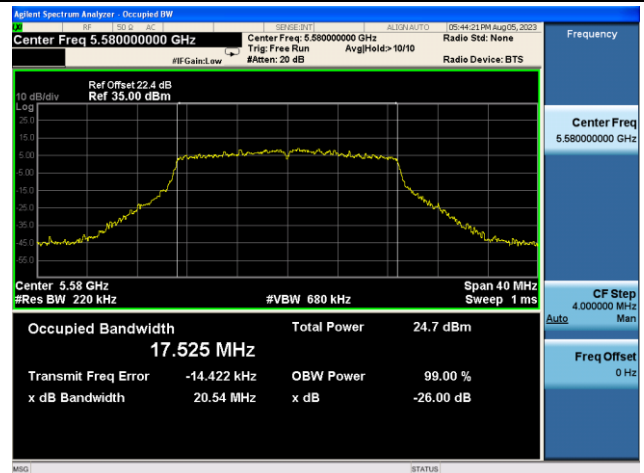

Channel 132 (5660MHz)

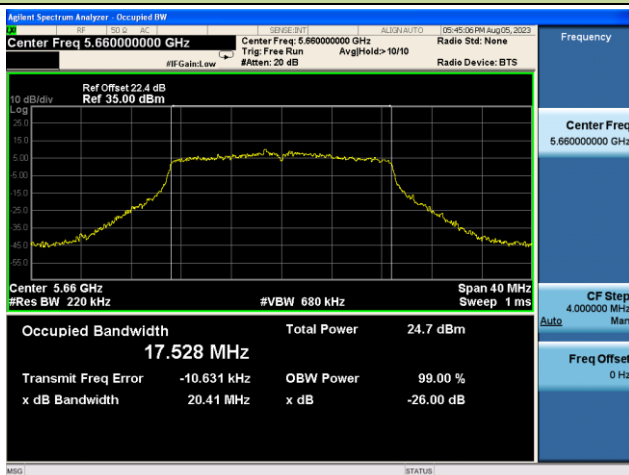

Channel 140 (5700MHz)

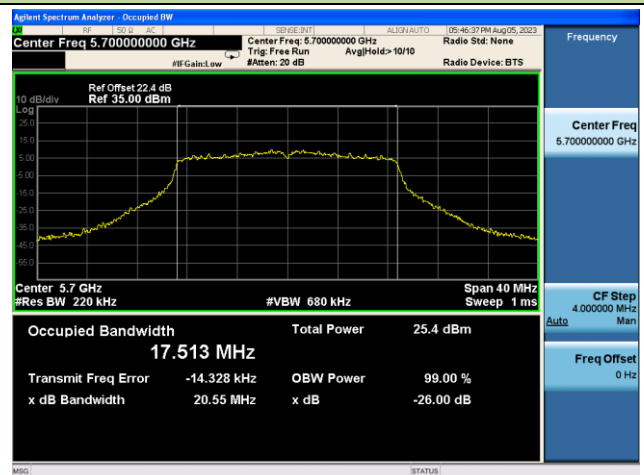

Channel 144(5720MHz)

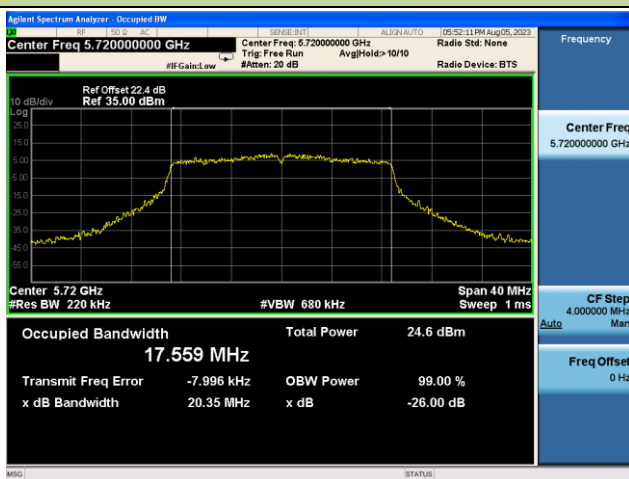

Channel 149 (5745MHz)

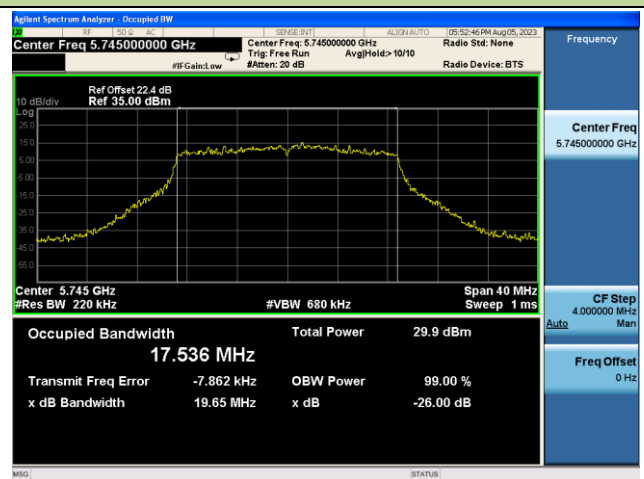

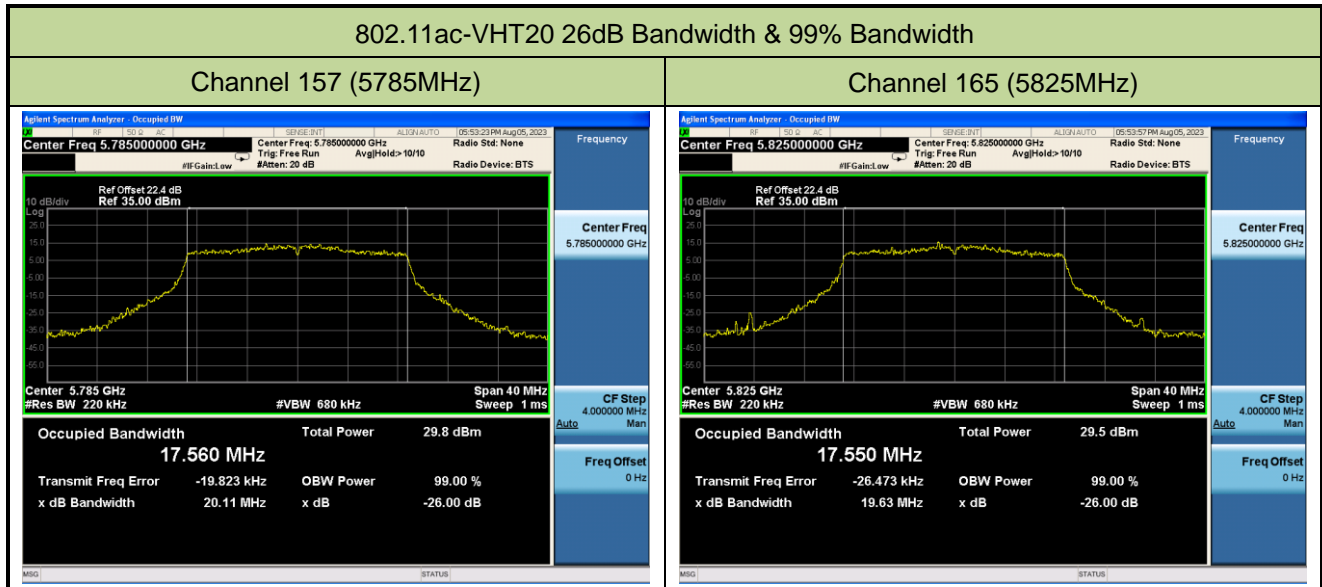

802.11ac-VHT40 26dB Bandwidth & 99% Bandwidth

Channel 38 (5190MHz)

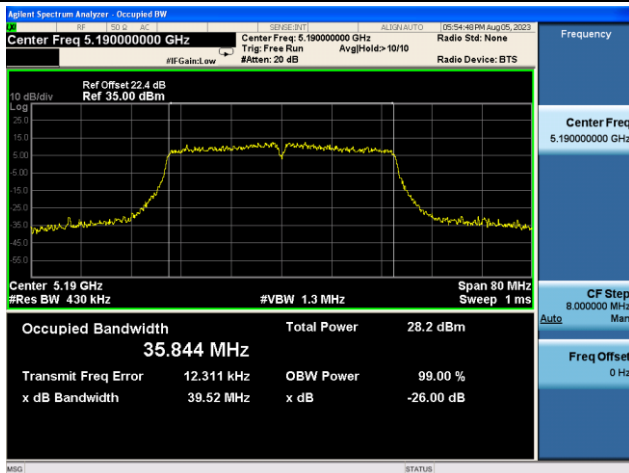

Channel 46 (5230MHz)

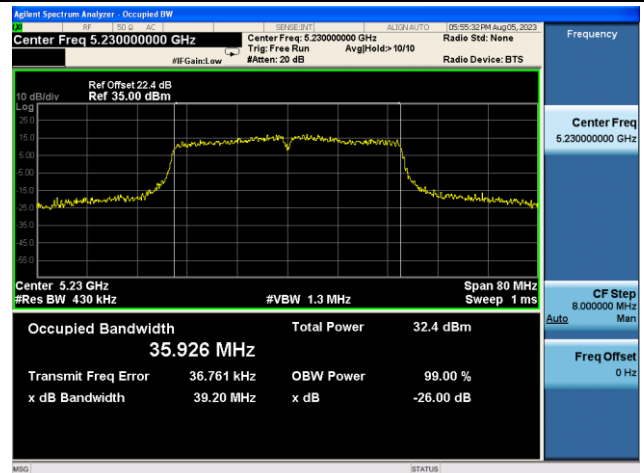

Channel 54 (5270MHz)

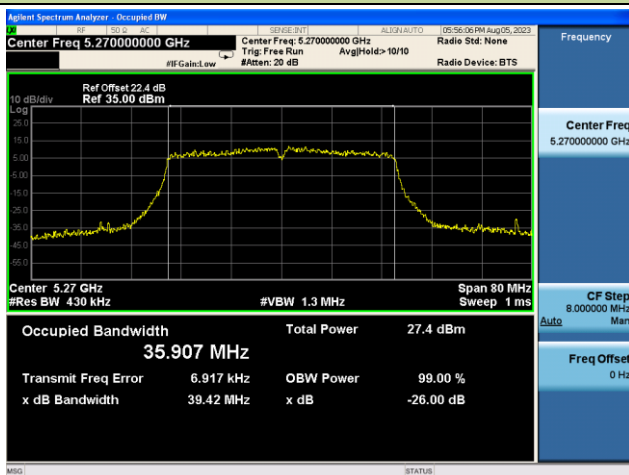

Channel 62 (5310MHz)

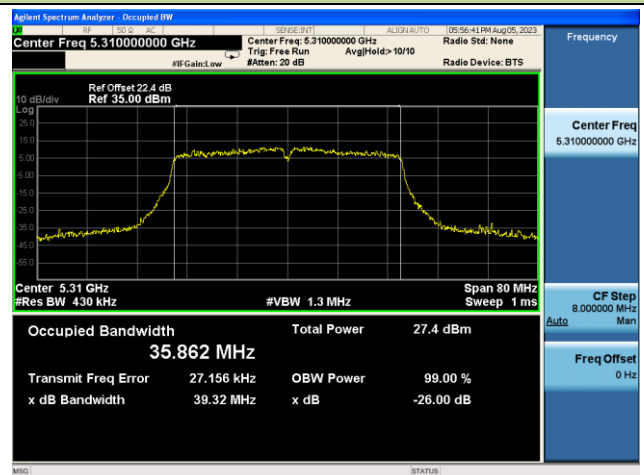

Channel 102 (5510MHz)

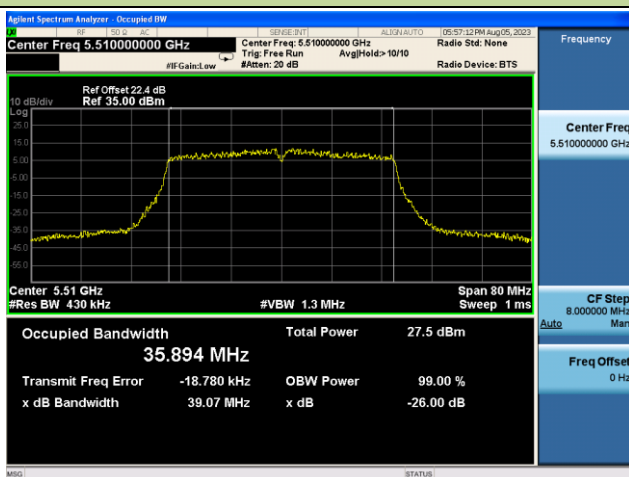

Channel 110 (5550MHz)

