

FCC Radio Test Report

FCC ID: 2BCGWHS200BLE

Report No. : eLab-FCCP-2-2310G045
Equipment : Kasa Smart Wi-Fi Light Switch, Single Pole
Model Name : HS200-LA
Series Model : HS200-BL
Brand Name : tp-link, kasa
Applicant : Big Field Global PTE. Ltd.
Address : 7 Temasek Boulevard #29-03 Suntec Tower One, Singapore 038987
Manufacturer : Big Field Global PTE. Ltd.
Address : 7 Temasek Boulevard #29-03 Suntec Tower One, Singapore 038987

Radio Function : WLAN 2.4 GHz

FCC Rule Part(s) : FCC CFR Title 47, Part 15, Subpart C (15.247)
Measurement Procedure(s) : ANSI C63.10-2013

Date of Receipt : 2023/10/17
Date of Test : 2023/10/18 ~ 2023/12/27
Issued Date : 2023/12/27

The above equipment has been tested and found in compliance with the requirement of the above standards by eLab Inc.

Prepared by : 
Hunter Chiang, Engineer

Approved by : 
Sam Chuang, Supervisor



eLab Inc.

10F., No. 167, Sec. 2, Datong Rd., Xizhi Dist., New Taipei City 221, Taiwan
Tel: +886-2-8692-6160 Fax: +886-2-8692-6170

Declaration

eLab represents to the client that testing is done in accordance with standard procedures as applicable and that test instruments used has been calibrated with standards traceable to international standard(s) and/or national standard(s).

eLab's reports apply only to the specific samples tested under conditions. It is manufacture's responsibility to ensure that additional production units of this model are manufactured with the identical electrical and mechanical components. **eLab** shall have no liability for any declarations, inferences or generalizations drawn by the client or others from **eLab** issued reports.

This report is the confidential property of the client. As a mutual protection to the clients, the public and ourselves, the test report shall not be reproduced, except in full, without our written approval.

eLab's laboratory quality assurance procedures are in compliance with the **ISO/IEC 17025** requirements, and accredited by the conformity assessment authorities listed in this test report.

eLab is not responsible for the sampling stage, so the results only apply to the sample as received.

The information, data and test plan are provided by manufacturer which may affect the validity of results, so it is manufacturer's responsibility to ensure that the apparatus meets the essential requirements of applied standards and in all the possible configurations as representative of its intended use.

Limitation

For the use of the authority's logo is limited unless the Test Standard(s)/Scope(s)/Item(s) mentioned in this test report is (are) included in the conformity assessment authorities acceptance respective.

Please note that the measurement uncertainty is provided for informational purpose only and are not use in determining the Pass/Fail results.

CONTENTS

REVISION HISTORY	5
1 SUMMARY OF TEST RESULTS	6
1.1 TEST FACILITY	7
1.2 MEASUREMENT UNCERTAINTY	7
1.3 TEST ENVIRONMENT CONDITIONS	7
1.4 DUTY CYCLE	8
2 GENERAL INFORMATION	9
2.1 DESCRIPTION OF EUT	9
2.2 TEST MODES	10
2.3 BLOCK DIAGRAM SHOWING THE CONFIGURATION OF SYSTEM TESTED	11
2.4 SUPPORT UNITS	11
3 AC POWER LINE CONDUCTED EMISSIONS TEST	12
3.1 LIMIT	12
3.2 TEST PROCEDURE	12
3.3 TEST SETUP	13
3.4 TEST RESULT	13
4 RADIATED EMISSIONS TEST	14
4.1 LIMIT	14
4.2 TEST PROCEDURE	15
4.3 TEST SETUP	15
4.4 EUT OPERATING CONDITIONS	16
4.5 TEST RESULT – BELOW 30 MHZ	17
4.6 TEST RESULT – 30 MHZ TO 1 GHZ	17
4.7 TEST RESULT – ABOVE 1 GHZ	17
5 BANDWIDTH TEST	18
5.1 LIMIT	18
5.2 TEST PROCEDURE	18
5.3 TEST SETUP	18
5.4 EUT OPERATING CONDITIONS	18
5.5 TEST RESULT	18
6 OUTPUT POWER TEST	19
6.1 LIMIT	19
6.2 TEST PROCEDURE	19
6.3 TEST SETUP	19
6.4 EUT OPERATING CONDITIONS	19
6.5 TEST RESULT	19
7 POWER SPECTRAL DENSITY	20
7.1 LIMIT	20
7.2 TEST PROCEDURE	20
7.3 TEST SETUP	20
7.4 EUT OPERATING CONDITIONS	20
7.5 TEST RESULT	20
8 ANTENNA CONDUCTED SPURIOUS EMISSIONS TEST	21
8.1 LIMIT	21
8.2 TEST PROCEDURE	21
8.3 TEST SETUP	21
8.4 EUT OPERATING CONDITIONS	21

8.5	TEST RESULT	21
9	LIST OF MEASURING EQUIPMENTS	22
10	EUT TEST PHOTO	24
11	EUT PHOTOS	24
APPENDIX A	AC POWER LINE CONDUCTED EMISSIONS	25
APPENDIX B	RADIATED EMISSIONS - 30 MHZ TO 1 GHZ	30
APPENDIX C	RADIATED EMISSIONS - ABOVE 1 GHZ	33
APPENDIX D	BANDWIDTH	79
APPENDIX E	OUTPUT POWER	86
APPENDIX F	POWER SPECTRAL DENSITY	88
APPENDIX G	ANTENNA CONDUCTED SPURIOUS EMISSIONS	92

REVISION HISTORY

Report No.	Version	Description	Issued Date	Note
eLab-FCCP-2-2310G045	R00	Original Report.	2023/12/05	Invalid
eLab-FCCP-2-2310G045	R01	Updated the data of 6dB Bandwidth and output power.	2023/12/14	Invalid
eLab-FCCP-2-2310G045	R02	Added the data of 2417MHz, 2437MHz and 2457MHz.	2023/12/27	Valid

1 SUMMARY OF TEST RESULTS

Test procedures according to the technical standards.

Standard(s) Section	Description	Result	Remark
15.207	AC Power Line Conducted Emissions	Pass	-----
15.205 15.209 15.247(d)	Radiated Emissions	Pass	-----
15.247(a)	Bandwidth	Pass	-----
15.247(b)	Output Power	Pass	-----
15.247(e)	Power Spectral Density	Pass	-----
15.247(d)	Antenna conducted Spurious Emission	Pass	-----
15.203	Antenna Requirement	Pass	-----

NOTE:

- (1) "N/A" denotes test is not applicable in this Test Report.
- (2) The report format version is FR15CWL2.4_V1.0

1.1 TEST FACILITY

The test facilities used to collect the test data in this report:

No.64, Ln. 169, Sec. 2, Datong Rd., Xizhi Dist., New Taipei City 221, Taiwan

The test sites and facilities are covered under FCC RN 681248 and DN: TW4045.

C01 CB01 TR01

1.2 MEASUREMENT UNCERTAINTY

The reported uncertainty of measurement $y \pm U$, where expanded uncertainty U is based on a standard uncertainty multiplied by a coverage factor of $k = 2$, providing a level of confidence of approximately **95 %**.

The measurement instrumentation uncertainty considerations contained in CISPR 16-4-2. The eLab measurement uncertainty is less than the CISPR 16-4-2 U_{CISPR} requirement.

A. AC power line conducted emissions test:

Test Site	Method	Measurement Frequency Range	U (dB)
C01	CISPR	150 kHz ~ 30MHz	3.44

B. Radiated emissions test :

Test Site	Measurement Frequency Range	U,(dB)
CB01	0.03 GHz ~ 0.2 GHz	4.4417
	0.2 GHz ~ 1 GHz	4.5567
	1 GHz ~ 6 GHz	3.9930
	6 GHz ~ 18 GHz	4.4555
	18 GHz ~ 26 GHz	3.8333
	26 GHz ~ 40 GHz	3.8241

C. Conducted test :

Test Item	U,(dB)
Occupied Bandwidth	1.0502
Output power	1.0406
Power Spectral Density	1.0502
Conducted Spurious emissions	1.1484
Conducted Band edges	1.0518

NOTE:

Unless specifically mentioned, the uncertainty of measurement has not been taken into account to declare the compliance or non-compliance to the specification.

1.3 TEST ENVIRONMENT CONDITIONS

Test Item	Environment Condition	Test Voltage	Tested by
AC Power Line Conducted Emissions	25 °C, 45 %	DC 5V	Hunter Chiang
Radiated emissions below 1 GHz	Refer to data	DC 5V	Hunter Chiang
Radiated emissions above 1 GHz	Refer to data	DC 5V	Hunter Chiang
Bandwidth	25 °C, 59 %	DC 5V	Hunter Chiang
Output Power	25 °C, 59 %	DC 5V	Hunter Chiang
Power Spectral Density	25 °C, 59 %	DC 5V	Hunter Chiang
Antenna conducted Spurious Emission	25 °C, 59 %	DC 5V	Hunter Chiang

1.4 DUTY CYCLE

If duty cycle is $\geq 98\%$, duty factor is not required.
 If duty cycle is $< 98\%$, duty factor shall be considered.

Mode	ON (ms)	Numbers (ON)	On Time (B) (ms)	Period (ON+OFF) (ms)	Duty Cycle (%)	Duty Factor (dB)
IEEE 802.11b	12.464	1	12.464	12.578	99.09%	0.04
IEEE 802.11g	2.075	1	2.075	2.205	94.10%	0.26
IEEE 802.11n (HT20)	1.928	1	1.928	2.056	93.77%	0.28

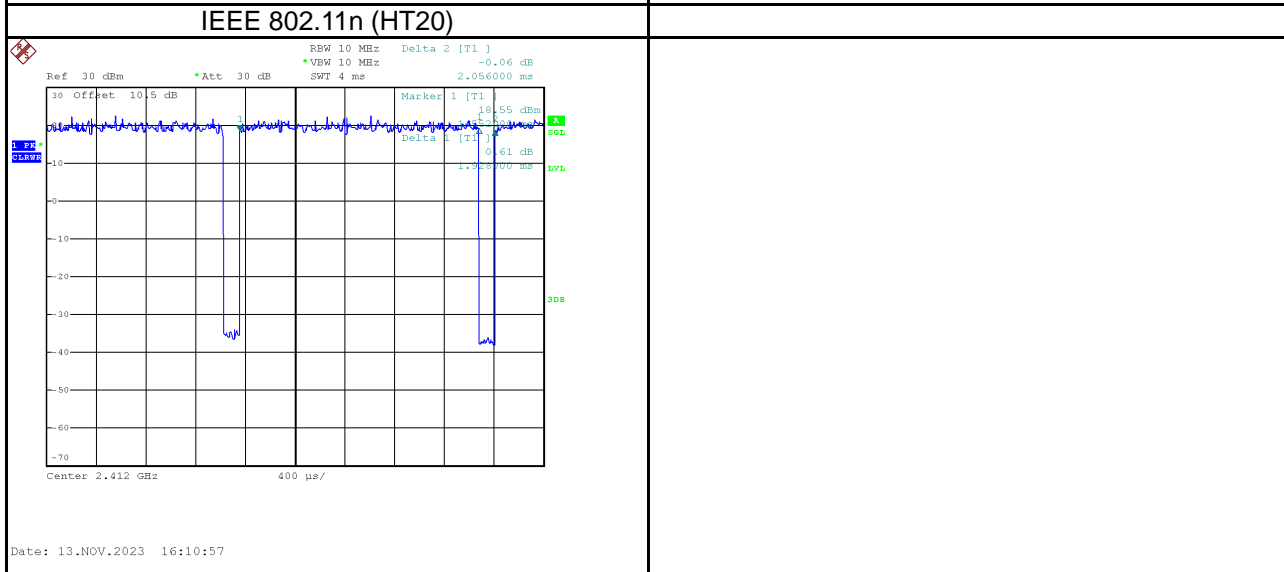
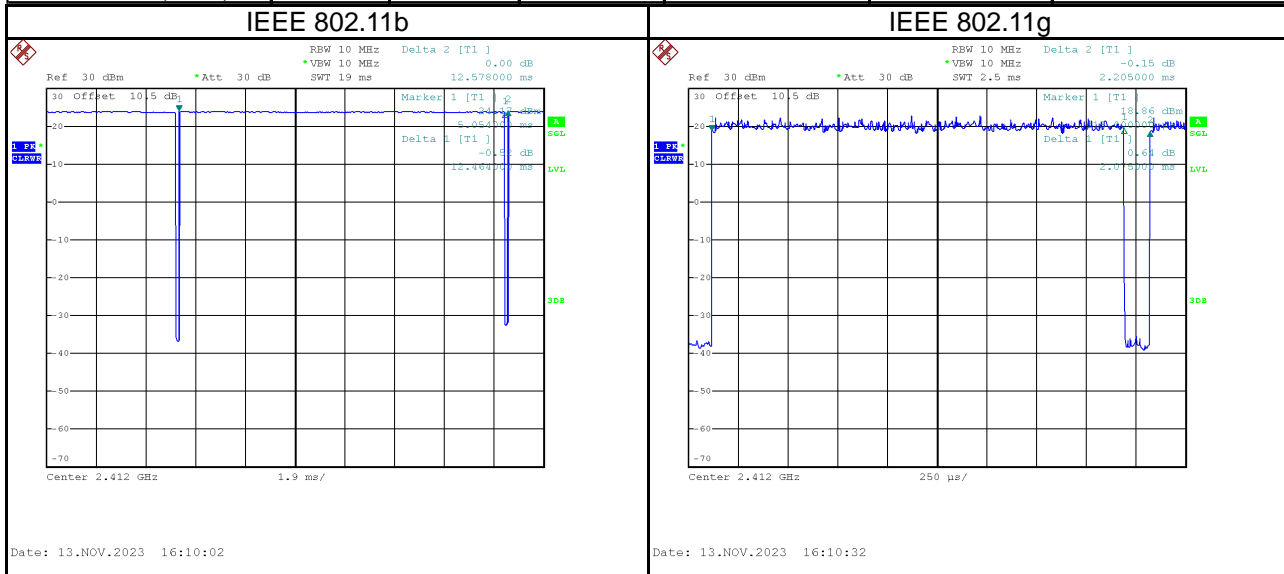

2 GENERAL INFORMATION

2.1 DESCRIPTION OF EUT

Equipment	Kasa Smart Wi-Fi Light Switch, Single Pole
Model Name	HS200-LA
Series Model	HS200-BL
Model Difference(s)	Only differ in model name and colour, HS200-LA is light apricot, HS200-BL is black, and everything else is exactly the same.
Brand Name	tp-link, kasa
Serial Number	N/A
Power Source	AC Mains.
Power Rating	100-120V~ 50/60Hz 15A General Use 600W Incandescent 1/6 HP Motor
Operation Band	2400 MHz ~ 2483.5 MHz
Operation Frequency	2412 MHz ~ 2462 MHz
Modulation Technology	IEEE 802.11b: DSSS IEEE 802.11g: OFDM IEEE 802.11n: OFDM
Transfer Rate	IEEE 802.11b: 11/5.5/2/1 Mbps IEEE 802.11g: 54/48/36/24/18/12/9/6 Mbps IEEE 802.11n: up to 72.2 Mbps
Output Power (Max).	IEEE 802.11b: 19.91 dBm (0.0979 W) IEEE 802.11g: 19.96 dBm (0.0991 W) IEEE 802.11n (HT20): 19.92 dBm (0.0982 W)

NOTE:

(1) The above EUT information is declared by manufacturer and for more detailed features description, please refers to the manufacturer's specifications or user's manual.

(2) Channel List:

CH01 - CH11 for IEEE 802.11b, IEEE 802.11g, IEEE 802.11n (HT20)					
Channel	Frequency (MHz)	Channel	Frequency (MHz)	Channel	Frequency (MHz)
01	2412	05	2432	09	2452
02	2417	06	2437	10	2457
03	2422	07	2442	11	2462
04	2427	08	2447		

(3) Table for Filed Antenna:

Ant.	Manufacturer	P/N	Type	Frequency (MHz)	Gain (dBi)
1	BIG FIELD GLOBAL PTE. LTD	6035500141	PIFA	2400-2500	2.98

(4) The above Antenna information are derived from the antenna data sheet provided by manufacturer and for more detailed features description, please refer to the manufacturer's specifications, the laboratory shall not be held responsible.

2.2 TEST MODES

Test Items	Test mode	Channel	Note
AC power line conducted emissions	Normal/Idle	-	-
Transmitter Radiated Emissions (below 1GHz)	TX Mode_IEEE 802.11b	11	-
Transmitter Radiated Emissions (above 1GHz)	TX Mode_IEEE 802.11b	01/02/06/10/11	Bandedge
	TX Mode_IEEE 802.11g		
	TX Mode_IEEE 802.11n (HT20)		
Transmitter Radiated Emissions (above 1GHz)	TX Mode_IEEE 802.11b	01/02/06/10/11	Harmonic
	TX Mode_IEEE 802.11g		
	TX Mode_IEEE 802.11n (HT20)		
Bandwidth & Output Power & Power Spectral Density & Antenna conducted Spurious Emission	TX Mode_IEEE 802.11b	01/02/06/10/11	-
	TX Mode_IEEE 802.11g		
	TX Mode_IEEE 802.11n (HT20)		

NOTE:

- (1) For radiated emission band edge test, both Vertical and Horizontal are evaluated, but only the worst case is recorded.
- (2) For AC power line conducted emissions and radiated emission below 1 GHz test, the IEEE 802.11g channel 06 is found to be the worst case and recorded.

2.3 BLOCK DIAGRAM SHOWING THE CONFIGURATION OF SYSTEM TESTED

Equipment letters and Cable numbers refer to item numbers described in the tables of clause 2.4.

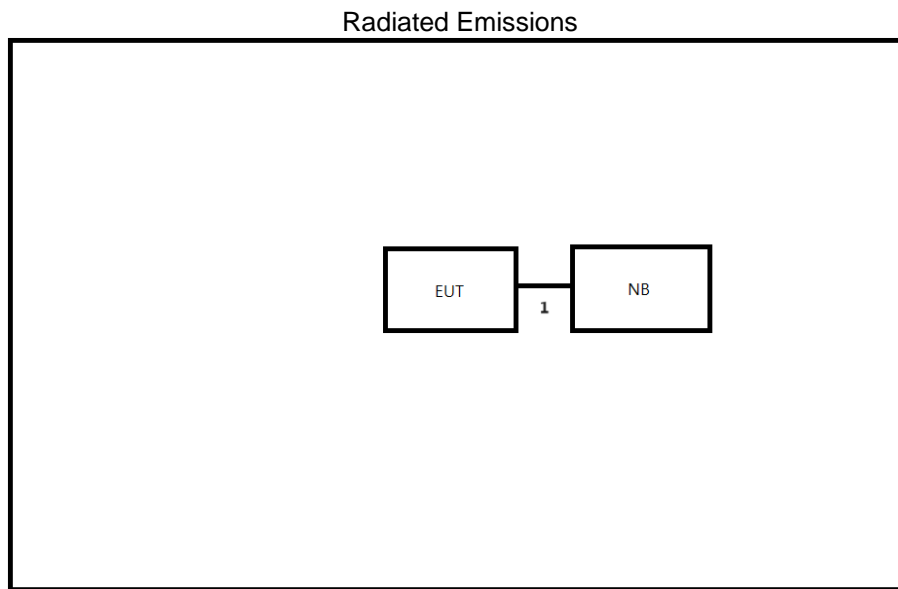
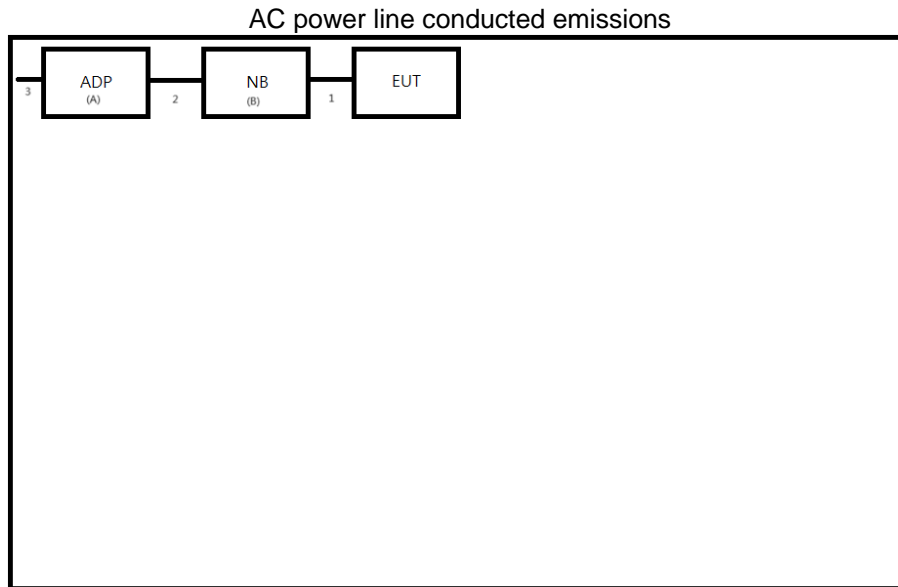

2.4 SUPPORT UNITS

Item	Equipment	Brand	Model No.	Remarks
A	ADP	TOSHIBA	PA5279E-1AC3	Supplied by test lab.
B	NB	Dynabook	TECRA A40-J	Supplied by test lab.

Item	Cable Type	Ferrite Core	Length	Shielded	Remarks
1	USB Cable	NO	1.5m	NO	Supplied by test lab.
2	DC Cable	YES	1.5m	NO	Supplied by test lab.
3	AC Cable	NO	1.5m	NO	Supplied by test lab.

3 AC POWER LINE CONDUCTED EMISSIONS TEST

3.1 LIMIT

Frequency (MHz)	Limit (dB μ V)	
	Quasi-peak	Average
0.15 - 0.5	66 - 56 *	56 - 46 *
0.50 - 5.0	56	46
5.0 - 30.0	60	50

NOTE:

- (1) The tighter limit applies at the band edges.
- (2) The limit of " * " marked band means the limitation decreases linearly with the logarithm of the frequency in the range.
- (3) The test result calculated as following:
 Measurement Value = Reading Level + Correct Factor
 Correct Factor = Insertion Loss + Cable Loss + Attenuator Factor (if use)
 Margin Level = Measurement Value – Limit Value
 Calculation example:

Reading Level		Correct Factor		Measurement Value
38.22	+	3.45	=	41.67

Measurement Value		Limit Value		Margin Level
41.67	-	60	=	-18.33

The following table is the setting of the receiver.

Receiver Parameter	Setting
Attenuation	10 dB
Start Frequency	0.15 MHz
Stop Frequency	30 MHz
IF Bandwidth	9 KHz

3.2 TEST PROCEDURE

- a. The EUT was placed 0.8 m above the horizontal ground plane with the EUT being connected to the power mains through a line impedance stabilization network (LISN).
 All other support equipment were powered from an additional LISN(s).
 The LISN provides 50 Ohm/50uH of impedance for the measuring instrument.
- b. Interconnecting cables that hang closer than 40 cm to the ground plane shall be folded back and forth in the center forming a bundle to keep the cable above 40 cm.
- c. Excess I/O cables that are not connected to a peripheral shall be bundled in the center.
 The end of the cable will be terminated, using the correct terminating impedance.
 The overall length shall not exceed 1 m.
- d. The LISN is spaced at least 80 cm from the nearest part of the EUT chassis.
- e. For the actual test configuration, please refer to the related Item - EUT TEST PHOTO.

NOTE:

- (1) In the results, each reading is marked as Peak, QP or AVG per the detector used.
 BW=9 kHz (6 dB Bandwidth)
- (2) All readings are Peak unless otherwise stated QP or AVG in column of Note. Both the QP and the AVG readings must be less than the limit for compliance.

3.3 TEST SETUP

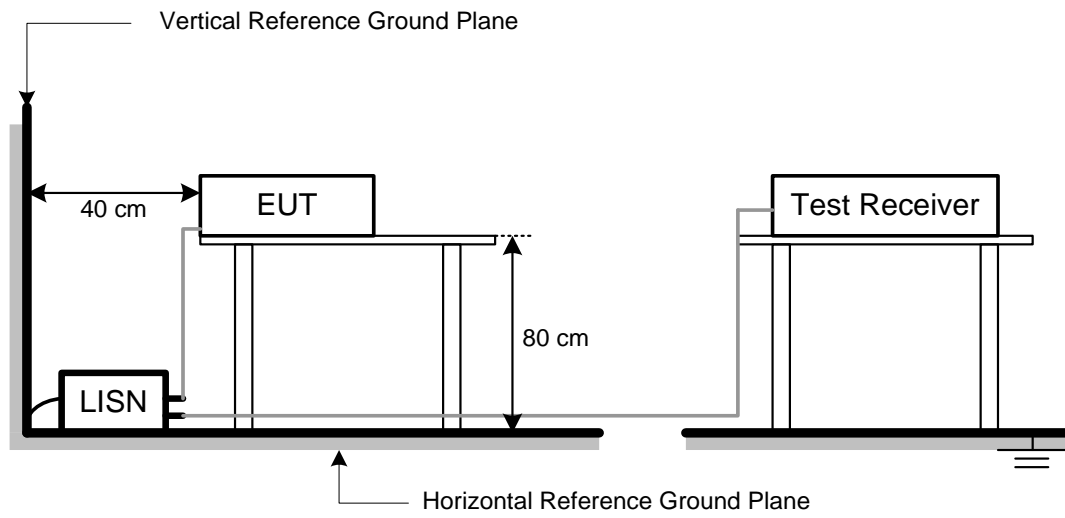

3.4 TEST RESULT

Please refer to the **APPENDIX A**.

4 RADIATED EMISSIONS TEST

4.1 LIMIT

In case the emission fall within the restricted band specified on 15.205, then the 15.209 limit in the table below has to be followed.

LIMITS OF RADIATED EMISSIONS MEASUREMENT (9 kHz to 1000 MHz)

Frequency (MHz)	Field Strength (microvolts/meter)	Measurement Distance (meters)
0.009~0.490	2400/F(KHz)	300
0.490~1.705	24000/F(KHz)	30
1.705~30.0	30	30
30~88	100	3
88~216	150	3
216~960	200	3
960~1000	500	3

LIMITS OF RADIATED EMISSIONS MEASUREMENT (Above 1000 MHz)

Frequency (MHz)	Radiated Emissions (dBuV/m)		Measurement Distance (meters)
	Peak	Average	
Above 1000	74	54	3

NOTE:

- (1) The limit for radiated test was performed according to FCC CFR Title 47, Part 15, Subpart C.
- (2) The tighter limit applies at the band edges.
- (3) Emission level (dBuV/m)=20log Emission level (uV/m).
- (4) The test result calculated as following:
 Measurement Value = Reading Level + Correct Factor
 Correct Factor = Antenna Factor + Cable Loss - Amplifier Gain(if use)
 Margin Level = Measurement Value - Limit Value
 Calculation example:

Reading Level		Correct Factor		Measurement Value
19.11	+	2.11	=	21.22

Measurement Value		Limit Value		Margin Level
21.22	-	54	=	-32.78

Spectrum Parameter	Setting
Attenuation	Auto
Start Frequency	1000 MHz
Stop Frequency	10th carrier harmonic
RBW / VBW (Emission in restricted band)	1MHz / 3MHz for Peak, 1MHz / 1/T for Average

Spectrum Parameter	Setting
Attenuation	Auto
Start ~ Stop Frequency	9KHz~90KHz for PK/AVG detector
Start ~ Stop Frequency	90KHz~110KHz for QP detector
Start ~ Stop Frequency	110KHz~490KHz for PK/AVG detector
Start ~ Stop Frequency	490KHz~30MHz for QP detector
Start ~ Stop Frequency	30MHz~1000MHz for QP detector

4.2 TEST PROCEDURE

- a. The measuring distance of 3 m shall be used for measurements. The EUT was placed on the top of a rotating table 0.8 meter above the ground at a 3 meter semi-anechoic chamber. The table was rotated 360 degrees to determine the position of the highest radiation.(below 1GHz)
- b. The measuring distance of 3 m shall be used for measurements. The EUT was placed on the top of a rotating table 1.5 meter above the ground at a 3 meter semi-anechoic chamber. The table was rotated 360 degrees to determine the position of the highest radiation.(above 1GHz)
- c. The height of the equipment or of the substitution antenna shall be 0.8 m or 1.5 m, the height of the test antenna shall vary between 1 m to 4 m. Both horizontal and vertical polarizations of the antenna are set to make the measurement.
- d. For each suspected emission, the EUT was arranged to its worst case and then the antenna was tuned to heights find the maximum reading (used Bore sight function).
- e. The receiver system was set to peak and average detect function and specified bandwidth with maximum hold mode when the test frequency is above 1GHz.
- f. The initial step in collecting radiated emission data is a receiver peak detector mode pre-scanning the measurement frequency range. Significant peaks are then marked and then Quasi Peak detector mode re-measured.
- g. All readings are Peak unless otherwise stated QP in column of Note. Peak denotes that the Peak reading compliance with the QP Limits and then QP Mode measurement didn't perform. (below 1GHz)
- h. All readings are Peak Mode value unless otherwise stated AVG in column of Note. If the Peak Mode Measured value compliance with the Peak Limits and lower than AVG Limits, the EUT shall be deemed to meet both Peak & AVG Limits and then only Peak Mode was measured, but AVG Mode didn't perform. (above 1GHz)
- i. For the actual test configuration, please refer to the related Item – EUT TEST PHOTO.

4.3 TEST SETUP

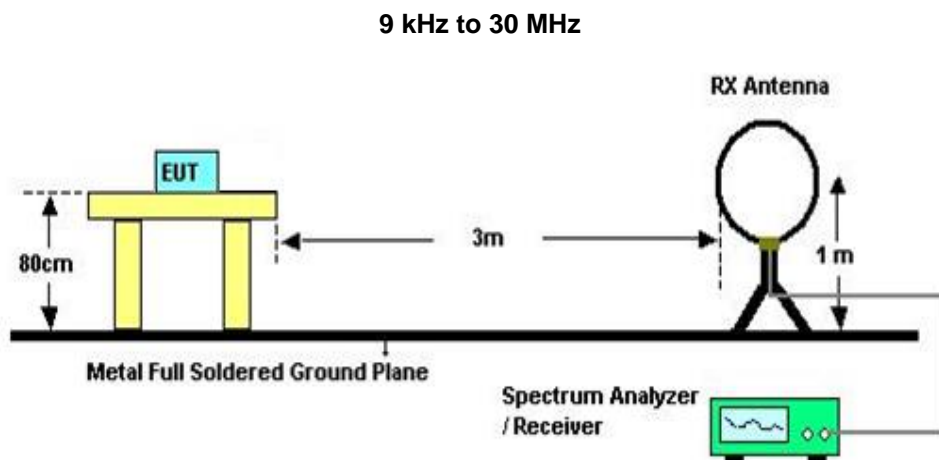

30 MHz to 1 GHz

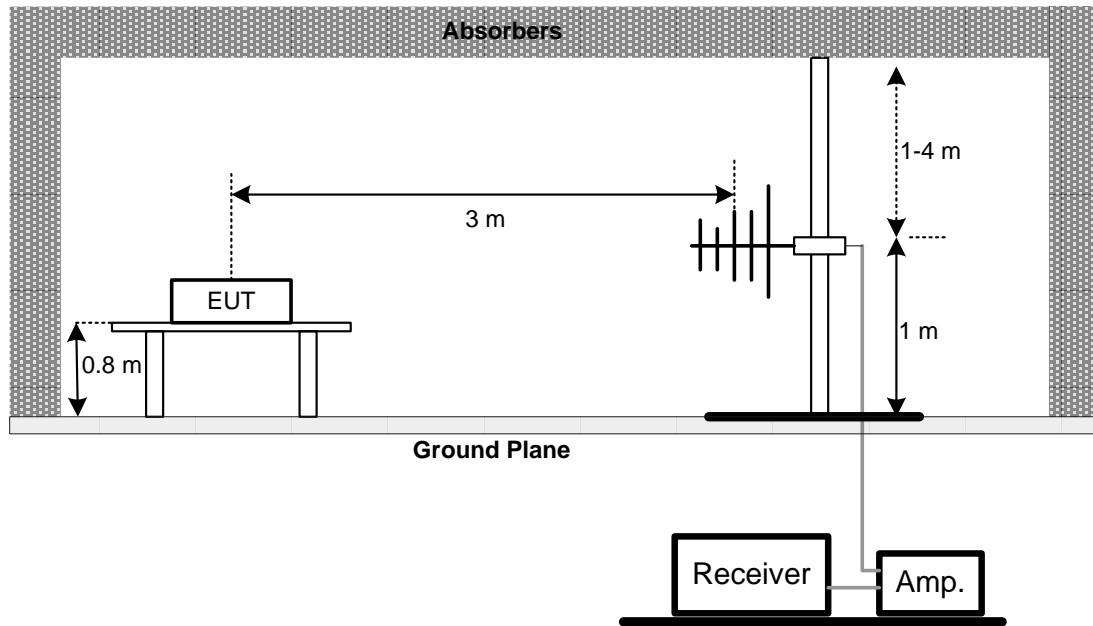

Above 1 GHz

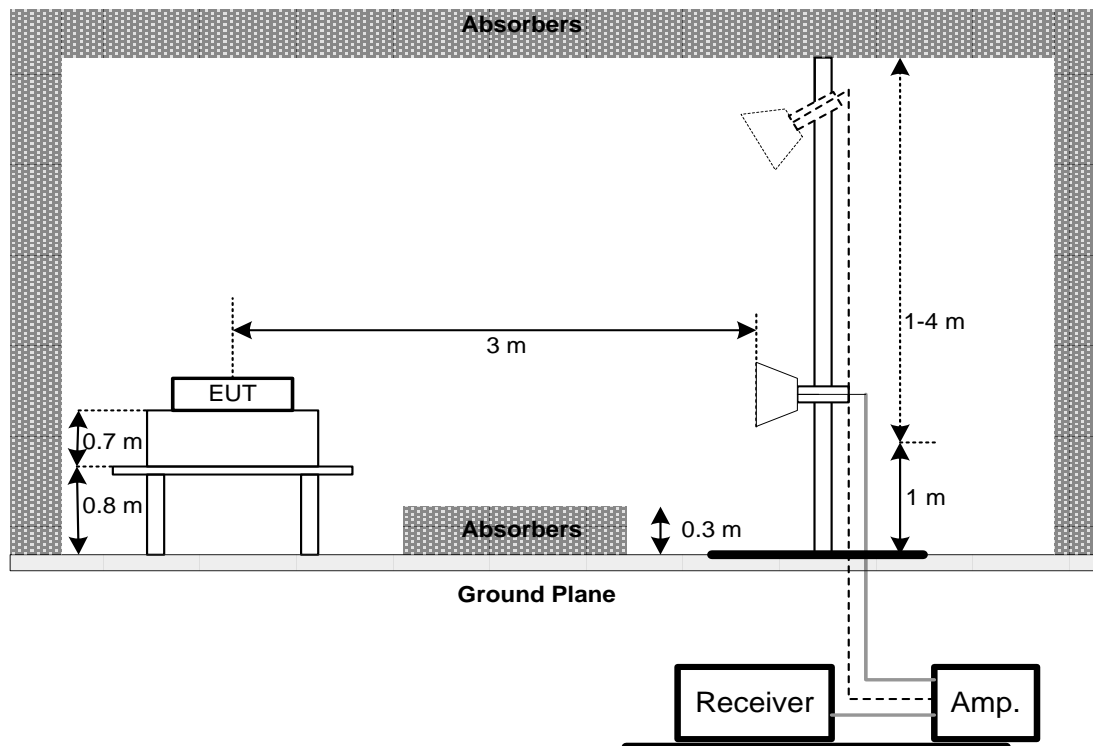

4.4 EUT OPERATING CONDITIONS

The EUT was programmed to be in continuously transmitting mode.

4.5 TEST RESULT – BELOW 30 MHZ

There were no emissions found below 30 MHz within 20 dB of the limit.

4.6 TEST RESULT – 30 MHZ TO 1 GHZ

Please refer to the APPENDIX B.

4.7 TEST RESULT – ABOVE 1 GHZ

Please refer to the APPENDIX C.

NOTE:

- (1) No limit: This is fundamental signal, the judgment is not applicable.
For fundamental signal judgment was referred to Peak output test.

5 BANDWIDTH TEST

5.1 LIMIT

FCC Part15, Subpart C (15.247)		
Section	Test Item	Limit
15.247(a)	6 dB Bandwidth	500 kHz

5.2 TEST PROCEDURE

- a. The EUT was directly connected to the spectrum analyzer and antenna output port as show in the block diagram below.
- b. Spectrum Setting: RBW= 100KHz, VBW=300KHz, Sweep time = 2.5 ms.

5.3 TEST SETUP



5.4 EUT OPERATING CONDITIONS

The EUT was programmed to be in continuously transmitting mode.

5.5 TEST RESULT

Please refer to the APPENDIX D.

6 OUTPUT POWER TEST

6.1 LIMIT

FCC Part15, Subpart C (15.247)		
Section	Test Item	Limit
15.247(b)	Maximum Output Power	1 Watt or 30dBm

6.2 TEST PROCEDURE

- The EUT was directly connected to the power meter and antenna output port as show in the block diagram below.
- The maximum peak conducted output power was performed in accordance with FCC KDB 558074 D01 15.247 Meas Guidance.
- Subclause 11.9.1.1 of ANSI C63.10 is applied. The maximum peak conducted output power may be measured using a broadband peak RF power meter. The power meter shall have a video bandwidth that is greater than or equal to the DTS bandwidth and shall use a fast-responding diode detector.

6.3 TEST SETUP

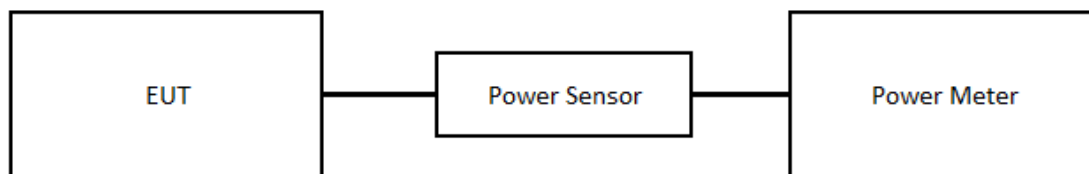

6.4 EUT OPERATING CONDITIONS

The EUT was programmed to be in continuously transmitting mode.

6.5 TEST RESULT

Please refer to the APPENDIX E.

7 POWER SPECTRAL DENSITY

7.1 LIMIT

FCC Part15, Subpart C (15.247)		
Section	Test Item	Limit
15.247(e)	Power Spectral Density	8 dBm (in any 3 kHz)

7.2 TEST PROCEDURE

- a. The EUT was directly connected to the spectrum analyzer and antenna output port as show in the block diagram below.
- b. Spectrum Setting: RBW = 3 kHz, VBW = 10 kHz, Sweep time = Auto.

7.3 TEST SETUP

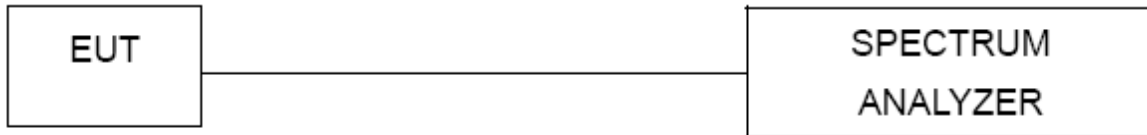

7.4 EUT OPERATING CONDITIONS

The EUT was programmed to be in continuously transmitting mode.

7.5 TEST RESULT

Please refer to the APPENDIX F.

8 ANTENNA CONDUCTED SPURIOUS EMISSIONS TEST

8.1 LIMIT

In any 100 kHz bandwidth outside the frequency band in which the spread spectrum or digitally modulated device is operating, the RF power that is produced shall be at least 30 dB below that in the 100 kHz bandwidth within the band that contains the highest level of the desired power, based on either an RF conducted or a radiated measurement, provided that the transmitter demonstrates compliance with the peak conducted power limits.

8.2 TEST PROCEDURE

- The EUT was directly connected to the spectrum analyzer and antenna output port as show in the block diagram below.
- Spectrum Setting: RBW = 100 kHz, VBW=300 kHz, Sweep time = Auto.
- Offset = antenna gain + cable loss.

8.3 TEST SETUP



8.4 EUT OPERATING CONDITIONS

The EUT was programmed to be in continuously transmitting mode.

8.5 TEST RESULT

Please refer to the APPENDIX G.

9 LIST OF MEASURING EQUIPMENTS

AC Power Line Conducted Emissions						
Item	Kind of Equipment	Manufacturer	Type No.	Serial No.	Calibrated Date	Calibrated Until
1	TWO-LINE V-NETWORK	R&S	ENV216	101051	2023/7/21	2024/7/20
2	Test Cable	EMCI	EMCRG58-BM-B M-9000	210501	2022/12/15 2023/12/14	2023/12/14 2024/12/13
3	MXE EMI Receiver	Agilent	N9038A	MY54130009	2023/06/26	2024/06/25
4	Measurement Software	EZ	EZ EMC (Version NB-03A1-01)	N/A	N/A	N/A

Radiated Emissions						
Item	Kind of Equipment	Manufacturer	Type No.	Serial No.	Calibrated Date	Calibrated Until
1	Preamplifier	EMCI	EMC051845SE	980779	2022/12/19 2023/12/18	2023/12/18 2024/12/17
2	Preamplifier	EMCI	EMC184045SE	980512	2022/12/02 2023/12/01	2023/12/01 2024/11/30
3	Preamplifier	EMCI	EMC001340	980555	2022/12/05 2023/12/04	2023/12/04 2024/12/03
4	Test Cable	EMCI	EMCCFD400-NM -NM-8000	200343	2023/11/14	2024/11/13
5	Test Cable	EMCI	EMC105-SM-SM-3000	210118	2022/12/08 2023/12/07	2023/12/07 2024/12/06
6	Test Cable	EMCI	EMC105-SM-SM-7000	210117	2023/11/14	2024/11/13
7	Test Cable	EMCI	EMCCFD400-NM -NM-3300	200348	2023/11/14	2024/11/13
8	EXA Signal Analyzer	keysight	N9010A	MY56480554	2023/9/12	2024/9/11
9	Loop Ant	Electro-Metrics	EMCI-LPA600	274	2023/06/28	2024/06/27
10	Horn Antenna	RFSPIN	DRH18-E	BBHA9170340	2023/02/10	2024/02/09
11	Horn Ant	Schwarzbeck	BBHA 9170D	210109A18E	2023/06/29	2024/06/28
12	Log-bicon Antenna	Schwarzbeck	VULB9168	9168-1207	2023/01/13	2024/01/12
13	6dB Attenuator	EMCI	EMCI-N-6-06	AT-N0690	2023/01/13	2024/01/12
14	Measurement Software	EZ	EZ EMC (Version NB-03A1-01)	N/A	N/A	N/A

Bandwidth						
Item	Kind of Equipment	Manufacturer	Type No.	Serial No.	Calibrated Date	Calibrated Until
1	Spectrum Analyzer	R&S	FSP30	100854	2023/06/26	2024/06/25

Output Power						
Item	Kind of Equipment	Manufacturer	Type No.	Serial No.	Calibrated Date	Calibrated Until
1	Spectrum Analyzer	R&S	FSP30	100854	2023/06/26	2024/06/25

Power Spectral Density						
Item	Kind of Equipment	Manufacturer	Type No.	Serial No.	Calibrated Date	Calibrated Until
1	Spectrum Analyzer	R&S	FSP30	100854	2023/06/26	2024/06/25

Antenna conducted Spurious Emission						
Item	Kind of Equipment	Manufacturer	Type No.	Serial No.	Calibrated Date	Calibrated Until
1	Spectrum Analyzer	R&S	FSP30	100854	2023/06/26	2024/06/25

Remark: "N/A" denotes no model name, no serial no. or no calibration specified.
All calibration period of equipment list is one year.

10 EUT TEST PHOTO

Please refer to APPENDIX-TEST PHOTOS.

11 EUT PHOTOS

Please refer to APPENDIX-EUT PHOTOS.

APPENDIX A AC POWER LINE CONDUCTED EMISSIONS

Test Mode	Normal	Tested Date	2023/11/16
Test Frequency	-	Phase	Line

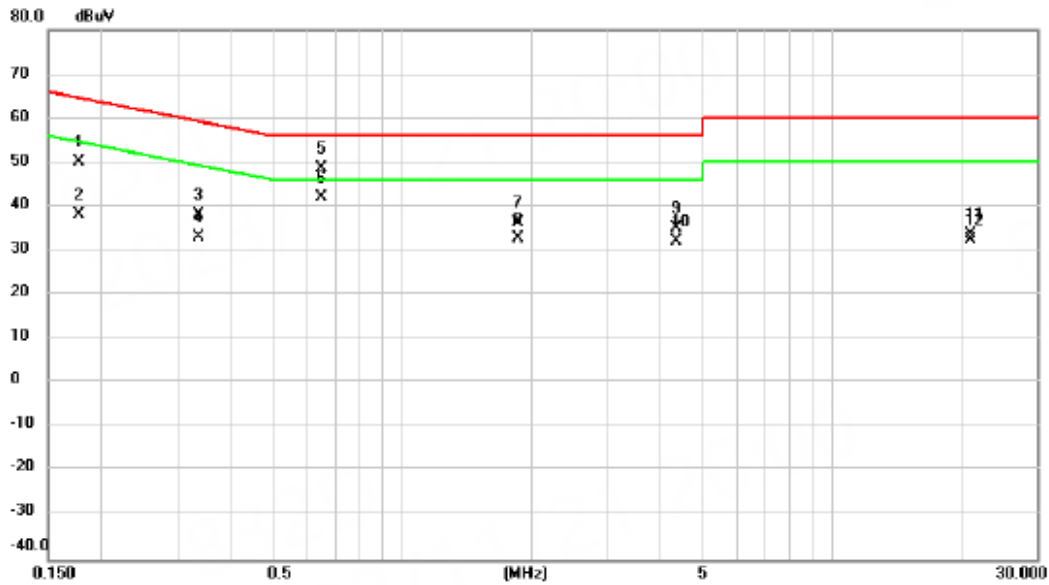

No.	Mk.	Freq. MHz	Reading Level dBuV	Correct Factor dB	Measure- ment dBuV	Limit dBuV	Margin dB	Detector	Comment
1		0.1776	40.53	9.67	50.20	64.60	-14.40	QP	
2		0.1776	28.57	9.67	38.24	54.60	-16.36	AVG	
3		0.3373	28.63	9.66	38.29	59.27	-20.98	QP	
4		0.3373	23.28	9.66	32.94	49.27	-16.33	AVG	
5		0.6485	39.08	9.70	48.78	56.00	-7.22	QP	
6	*	0.6485	32.43	9.70	42.13	46.00	-3.87	AVG	
7		1.8590	26.53	9.77	36.30	56.00	-19.70	QP	
8		1.8590	22.92	9.77	32.69	46.00	-13.31	AVG	
9		4.3475	25.19	9.88	35.07	56.00	-20.93	QP	
10		4.3475	22.39	9.88	32.27	46.00	-13.73	AVG	
11		20.9750	23.47	10.20	33.67	60.00	-26.33	QP	
12		20.9750	22.36	10.20	32.56	50.00	-17.44	AVG	

REMARKS:

- (1) Measurement Value = Reading Level + Correct Factor.
- (2) Margin Level = Measurement Value - Limit Value.

Test Mode	Normal	Tested Date	2023/11/16
Test Frequency	-	Phase	Neutral

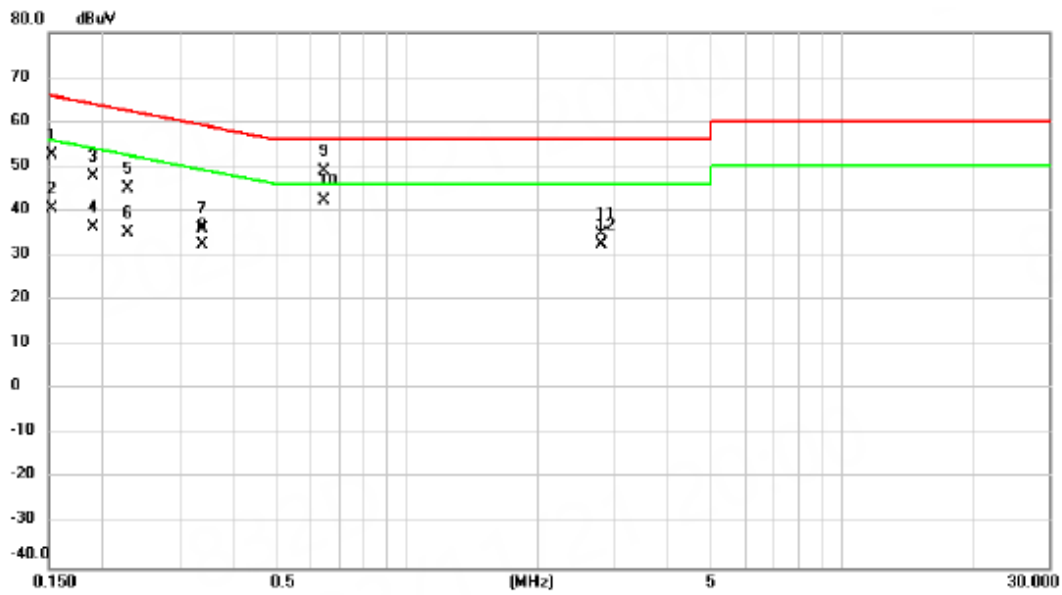

No.	Mk.	Freq.	Reading Level	Correct Factor	Measurement	Limit	Margin		
		MHz	dBuV	dB	dBuV	dBuV	dB	Detector	Comment
1		0.1524	42.98	9.67	52.65	65.87	-13.22	QP	
2		0.1524	30.85	9.67	40.52	55.87	-15.35	AVG	
3		0.1895	38.16	9.66	47.82	64.06	-16.24	QP	
4		0.1895	26.80	9.66	36.46	54.06	-17.60	AVG	
5		0.2277	35.40	9.66	45.06	62.53	-17.47	QP	
6		0.2277	25.62	9.66	35.28	52.53	-17.25	AVG	
7		0.3380	26.44	9.66	36.10	59.25	-23.15	QP	
8		0.3380	22.93	9.66	32.59	49.25	-16.66	AVG	
9		0.6440	39.18	9.70	48.88	56.00	-7.12	QP	
10	*	0.6440	32.78	9.70	42.48	46.00	-3.52	AVG	
11		2.8130	24.97	9.84	34.81	56.00	-21.19	QP	
12		2.8130	22.57	9.84	32.41	46.00	-13.59	AVG	

REMARKS:

- (1) Measurement Value = Reading Level + Correct Factor.
- (2) Margin Level = Measurement Value - Limit Value.

Test Mode	Idle	Tested Date	2023/11/16
Test Frequency	-	Phase	Line

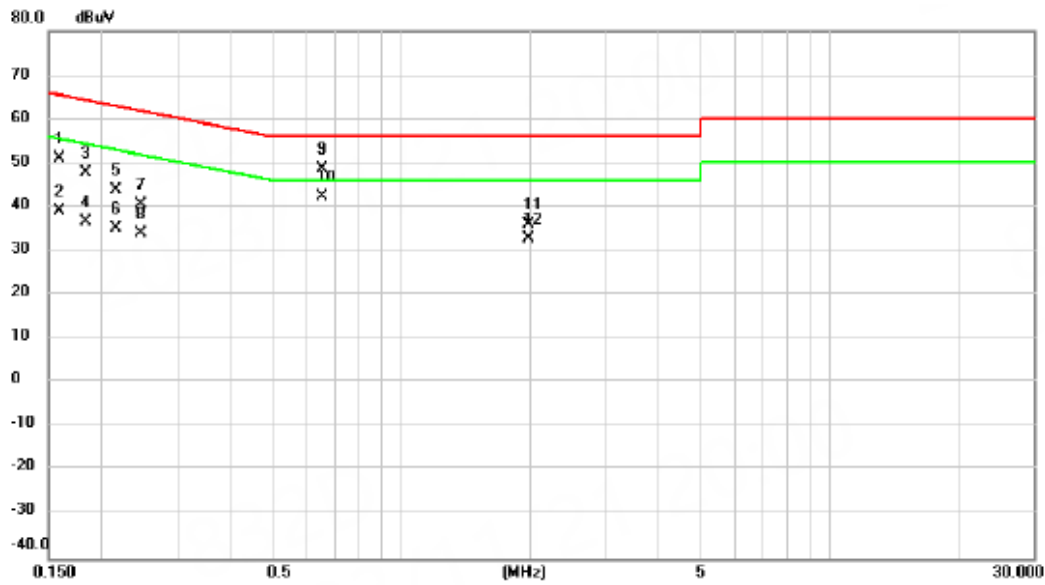

No. Mk.	Freq. MHz	Reading Level dBuV	Correct Factor dB	Measurement dBuV	Limit dBuV	Margin dB	Detector	Comment
1	0.1598	41.39	9.67	51.06	65.47	-14.41	QP	
2	0.1598	29.27	9.67	38.94	55.47	-16.53	AVG	
3	0.1836	38.11	9.67	47.78	64.32	-16.54	QP	
4	0.1836	26.91	9.67	36.58	54.32	-17.74	AVG	
5	0.2151	34.06	9.67	43.73	63.01	-19.28	QP	
6	0.2151	25.35	9.67	35.02	53.01	-17.99	AVG	
7	0.2476	30.97	9.67	40.64	61.84	-21.20	QP	
8	0.2476	24.31	9.67	33.98	51.84	-17.86	AVG	
9	0.6530	38.92	9.70	48.62	56.00	-7.38	QP	
10 *	0.6530	32.52	9.70	42.22	46.00	-3.78	AVG	
11	1.9850	26.20	9.78	35.98	56.00	-20.02	QP	
12	1.9850	23.04	9.78	32.82	46.00	-13.18	AVG	

REMARKS:

- (1) Measurement Value = Reading Level + Correct Factor.
- (2) Margin Level = Measurement Value - Limit Value.

Test Mode	Idle	Tested Date	2023/11/16
Test Frequency	-	Phase	Neutral

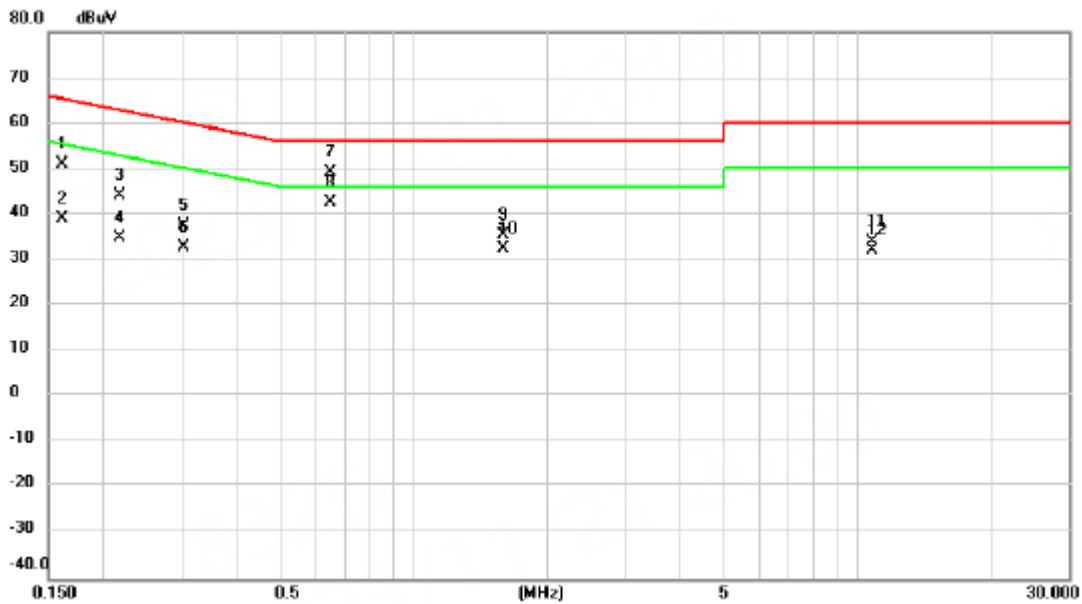

No.	Mk.	Freq. MHz	Reading Level dBuV	Correct Factor dB	Measure- ment dBuV	Limit dBuV	Margin dB	Detector	Comment
1		0.1621	41.34	9.67	51.01	65.36	-14.35	QP	
2		0.1621	29.24	9.67	38.91	55.36	-16.45	AVG	
3		0.2180	34.36	9.66	44.02	62.89	-18.87	QP	
4		0.2180	25.19	9.66	34.85	52.89	-18.04	AVG	
5		0.3026	27.91	9.65	37.56	60.17	-22.61	QP	
6		0.3026	23.24	9.65	32.89	50.17	-17.28	AVG	
7		0.6485	39.47	9.70	49.17	56.00	-6.83	QP	
8	*	0.6485	32.93	9.70	42.63	46.00	-3.37	AVG	
9		1.5980	25.80	9.78	35.58	56.00	-20.42	QP	
10		1.5980	22.79	9.78	32.57	46.00	-13.43	AVG	
11		10.8000	23.80	10.11	33.91	60.00	-26.09	QP	
12		10.8000	21.99	10.11	32.10	50.00	-17.90	AVG	

REMARKS:

- (1) Measurement Value = Reading Level + Correct Factor.
- (2) Margin Level = Measurement Value - Limit Value.

APPENDIX B RADIATED EMISSIONS - 30 MHZ TO 1 GHZ

Test Mode	IEEE 802.11g	Tested Date	2023/11/15
Test Frequency	2437MHz	Polarization	Vertical
Temp	25°C	Hum.	60%

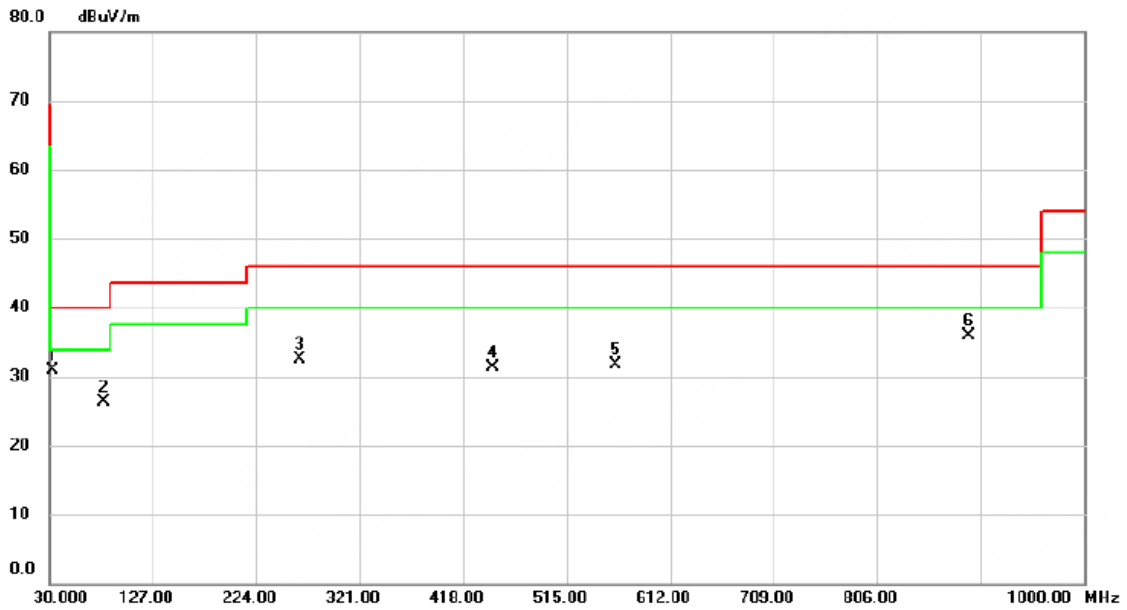

No.	Mk.	Freq.	Reading Level	Correct Factor	Measurement	Limit	Margin	Antenna Height	Table Degree	Comment
		MHz	dBuV	dB	dBuV/m	dBuV/m	dB	cm	degree	
1	*	32.9100	44.24	-13.42	30.82	40.00	-9.18	peak 100	104	
2		80.4400	42.68	-16.33	26.35	40.00	-13.65	peak 200	240	
3		264.7400	44.00	-11.46	32.54	46.00	-13.46	peak 100	131	
4		445.1600	37.60	-6.38	31.22	46.00	-14.78	peak 100	72	
5		561.5600	35.61	-3.94	31.67	46.00	-14.33	peak 200	137	
6		892.3300	34.61	1.39	36.00	46.00	-10.00	peak 200	53	

REMARKS:

- (1) Measurement Value = Reading Level + Correct Factor.
- (2) Margin Level = Measurement Value - Limit Value.

Test Mode	IEEE 802.11g	Tested Date	2023/11/15
Test Frequency	2437MHz	Polarization	Horizontal
Temp	25°C	Hum.	60%

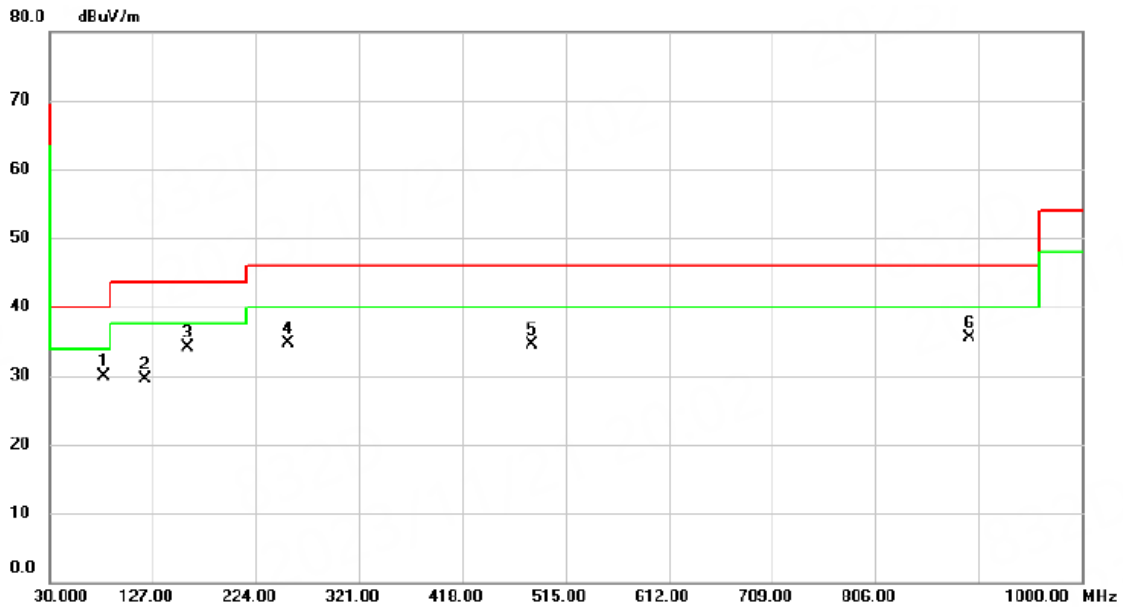

No.	Mk.	Freq. MHz	Reading Level dBuV	Correct Factor dB	Measure- ment dBuV/m	Limit dBuV/m	Margin dB	Antenna Height cm	Table Degree	Comment
1		80.4400	46.19	-16.33	29.86	40.00	-10.14	peak	200	189
2		120.2100	43.62	-14.02	29.60	43.50	-13.90	peak	200	165
3	*	159.9800	45.41	-11.30	34.11	43.50	-9.39	peak	182	360
4		254.0700	46.56	-11.86	34.70	46.00	-11.30	peak	100	265
5		482.9900	40.08	-5.63	34.45	46.00	-11.55	peak	200	227
6		894.2700	34.06	1.40	35.46	46.00	-10.54	peak	200	255

REMARKS:

- (1) Measurement Value = Reading Level + Correct Factor.
- (2) Margin Level = Measurement Value - Limit Value.

APPENDIX C RADIATED EMISSIONS - ABOVE 1 GHZ

Test Mode	IEEE 802.11b	Tested Date	2023/11/14
Test Frequency	2412MHz	Polarization	Horizontal
Temp	25°C	Hum.	60%

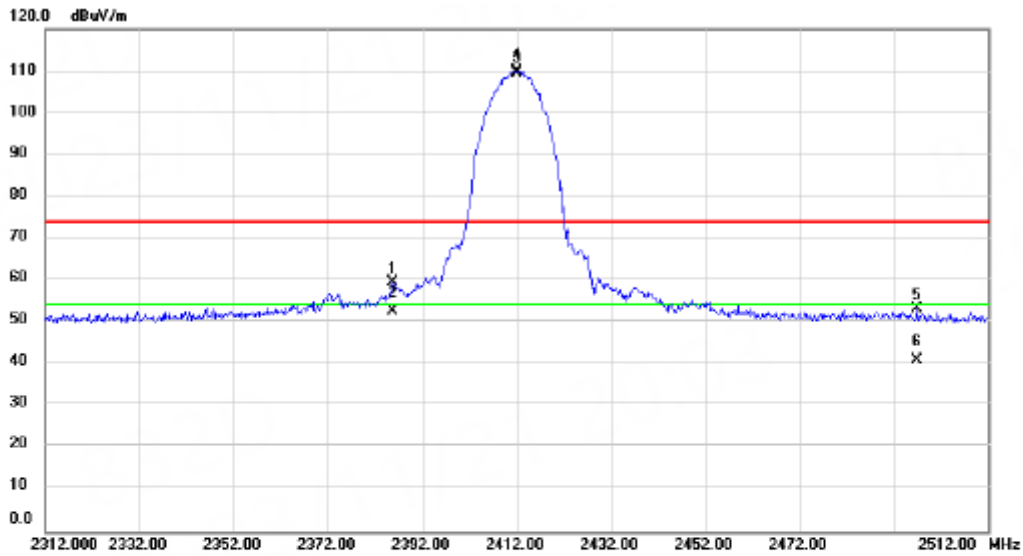

No. Mk.	Freq.	Reading Level	Correct Factor	Measurement	Limit	Margin	Antenna Height	Table Degree
	MHz	dBuV	dB	dBuV/m	dBuV/m	dB	cm	degree
1	2385.800	55.41	4.10	59.51	74.00	-14.49	peak	
2	2385.800	48.48	4.10	52.58	54.00	-1.42	AVG	
3 X	2412.000	105.90	4.13	110.03	74.00	36.03	peak	
4 *	2412.000	105.28	4.13	109.41	54.00	55.41	AVG	
5	2496.800	49.08	4.22	53.30	74.00	-20.70	peak	
6	2496.800	36.81	4.22	41.03	54.00	-12.97	AVG	

REMARKS:

- (1) Measurement Value = Reading Level + Correct Factor.
- (2) Margin Level = Measurement Value - Limit Value.

Test Mode	IEEE 802.11b	Tested Date	2023/12/25
Test Frequency	2417MHz	Polarization	Vertical
Temp	25°C	Hum.	60%

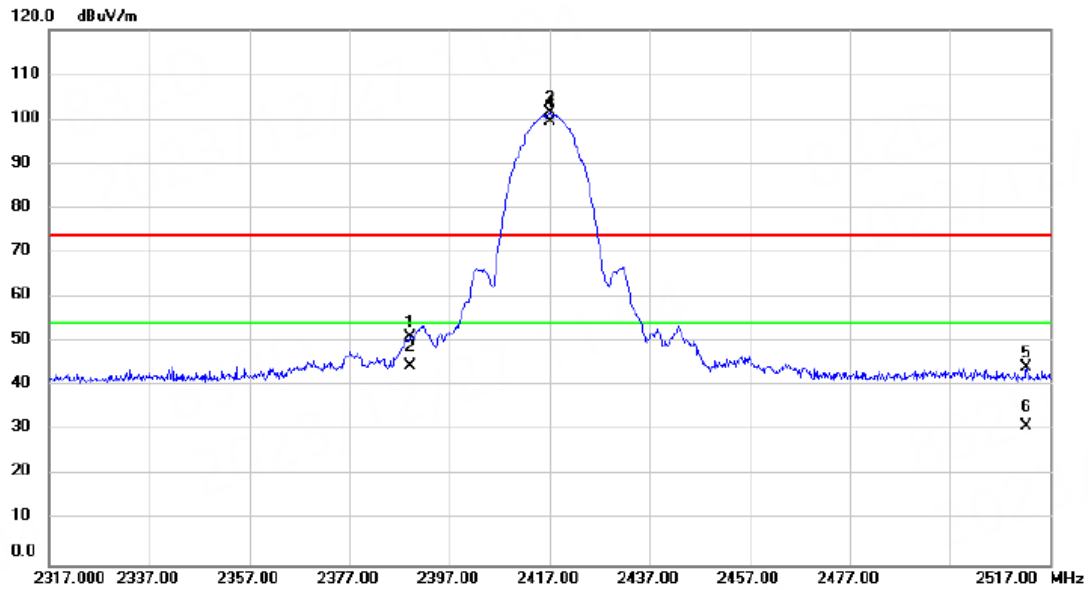

No.	Mk.	Freq. MHz	Reading Level dBuV	Correct Factor dB	Measure- ment dBuV/m	Limit dBuV/m	Margin dB	Detector	Antenna Height cm	Table Degree	Comment
1		2389.000	57.56	-6.45	51.11	74.00	-22.89	peak			
2		2389.000	51.13	-6.45	44.68	54.00	-9.32	AVG			
3	X	2417.000	107.85	-6.40	101.45	74.00	27.45	peak			
4	*	2417.000	105.85	-6.40	99.45	54.00	45.45	AVG			
5		2512.400	50.34	-6.23	44.11	74.00	-29.89	peak			
6		2512.400	37.15	-6.23	30.92	54.00	-23.08	AVG			

REMARKS:

- (1) Measurement Value = Reading Level + Correct Factor.
- (2) Margin Level = Measurement Value - Limit Value.

Test Mode	IEEE 802.11b	Tested Date	2023/12/25
Test Frequency	2437MHz	Polarization	Vertical
Temp	25°C	Hum.	60%

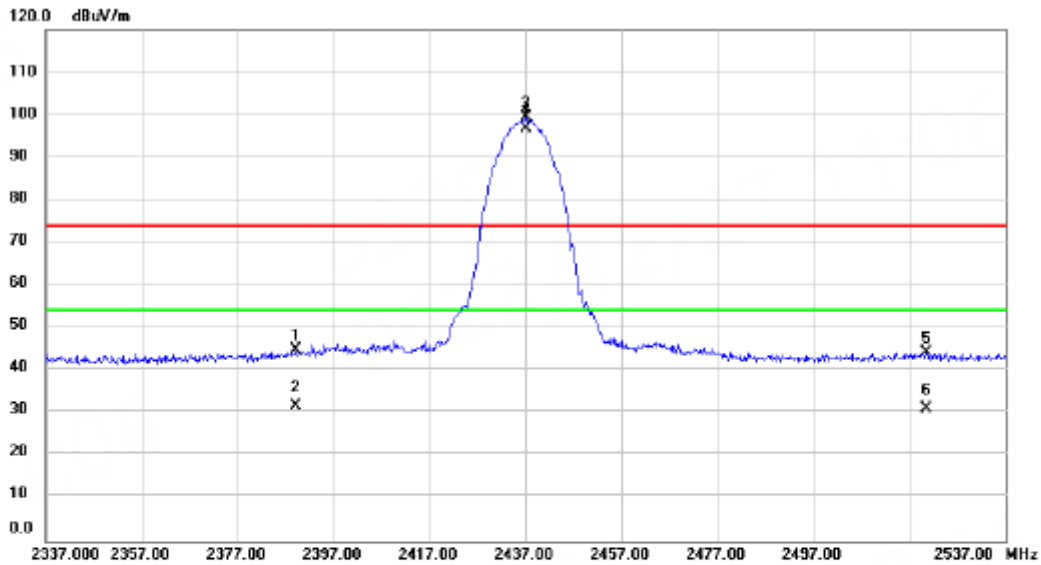

No. Mk.	Freq. MHz	Reading Level dBuV	Correct Factor dB	Measure- ment dBuV/m	Limit dBuV/m	Margin dB	Detector	Antenna Height cm	Table Degree degree	Comment
1	2389.000	51.24	-6.45	44.79	74.00	-29.21	peak			
2	2389.000	38.00	-6.45	31.55	54.00	-22.45	AVG			
3 X	2437.000	105.69	-6.38	99.31	74.00	25.31	peak			
4 *	2437.000	103.27	-6.38	96.89	54.00	42.89	AVG			
5	2520.600	50.45	-6.19	44.26	74.00	-29.74	peak			
6	2520.600	37.39	-6.19	31.20	54.00	-22.80	AVG			

REMARKS:

- (1) Measurement Value = Reading Level + Correct Factor.
- (2) Margin Level = Measurement Value - Limit Value.

Test Mode	IEEE 802.11b	Tested Date	2023/12/25
Test Frequency	2457MHz	Polarization	Vertical
Temp	25°C	Hum.	60%

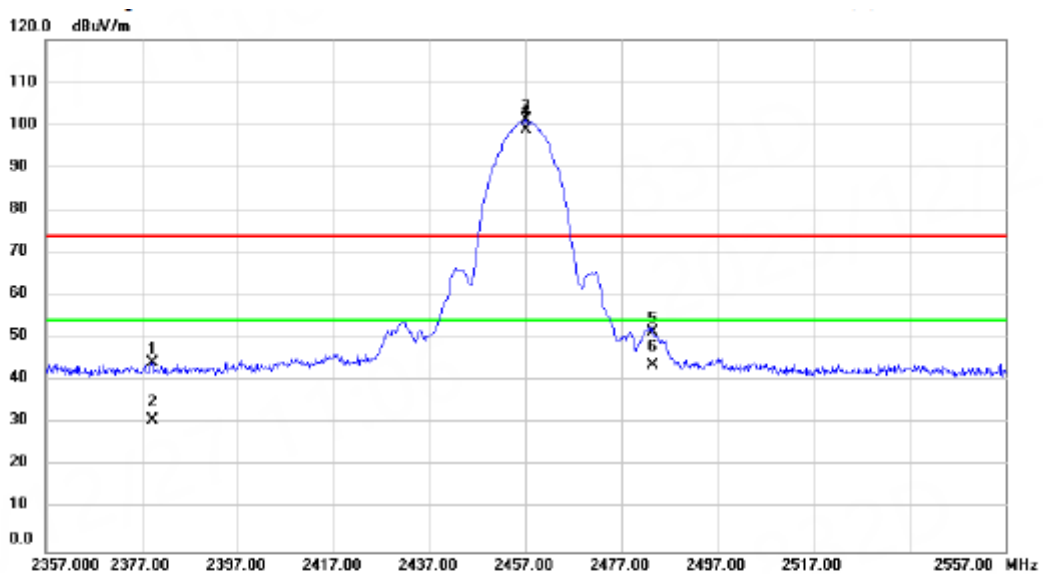

No.	Mk.	Freq.	Reading Level	Correct Factor	Measurement	Limit	Margin	Antenna Height	Table Degree	
		MHz	dBuV	dB	dBuV/m	dBuV/m	dB	cm	degree	Comment
1		2379.200	50.78	-6.46	44.32	74.00	-29.68			peak
2		2379.200	37.07	-6.46	30.61	54.00	-23.39			AVG
3	X	2457.000	107.54	-6.35	101.19	74.00	27.19			peak
4	*	2457.000	105.23	-6.35	98.88	54.00	44.88			AVG
5		2483.500	57.66	-6.30	51.36	74.00	-22.64			peak
6		2483.500	50.06	-6.30	43.76	54.00	-10.24			AVG

REMARKS:

- (1) Measurement Value = Reading Level + Correct Factor.
- (2) Margin Level = Measurement Value - Limit Value.

Test Mode	IEEE 802.11b	Tested Date	2023/11/14
Test Frequency	2462MHz	Polarization	Horizontal
Temp	25°C	Hum.	60%

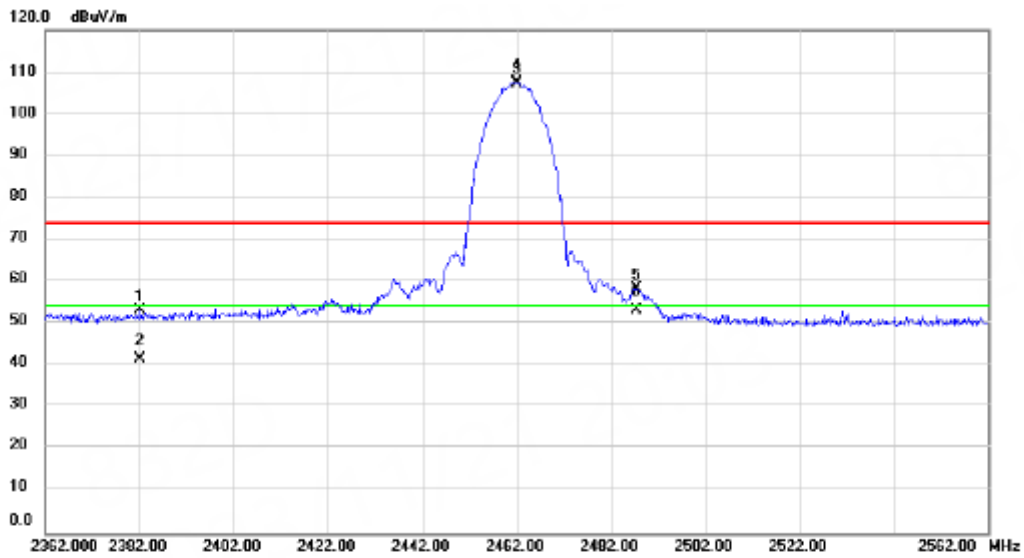

No.	Mk.	Freq.	Reading Level	Correct Factor	Measurement	Limit	Margin	Antenna Height	Table Degree	Detector	Comment
		MHz	dBuV	dB	dBuV/m	dBuV/m	dB	cm	degree		
1		2382.200	49.28	4.09	53.37	74.00	-20.63			peak	
2		2382.200	37.42	4.09	41.51	54.00	-12.49			AVG	
3	X	2462.000	103.41	4.19	107.60	74.00	33.60			peak	
4	*	2462.000	102.98	4.19	107.17	54.00	53.17			AVG	
5		2487.400	54.22	4.21	58.43	74.00	-15.57			peak	
6		2487.400	49.11	4.21	53.32	54.00	-0.68			AVG	

REMARKS:

- (1) Measurement Value = Reading Level + Correct Factor.
- (2) Margin Level = Measurement Value - Limit Value.

Test Mode	IEEE 802.11g	Tested Date	2023/11/14
Test Frequency	2412MHz	Polarization	Horizontal
Temp	25°C	Hum.	60%

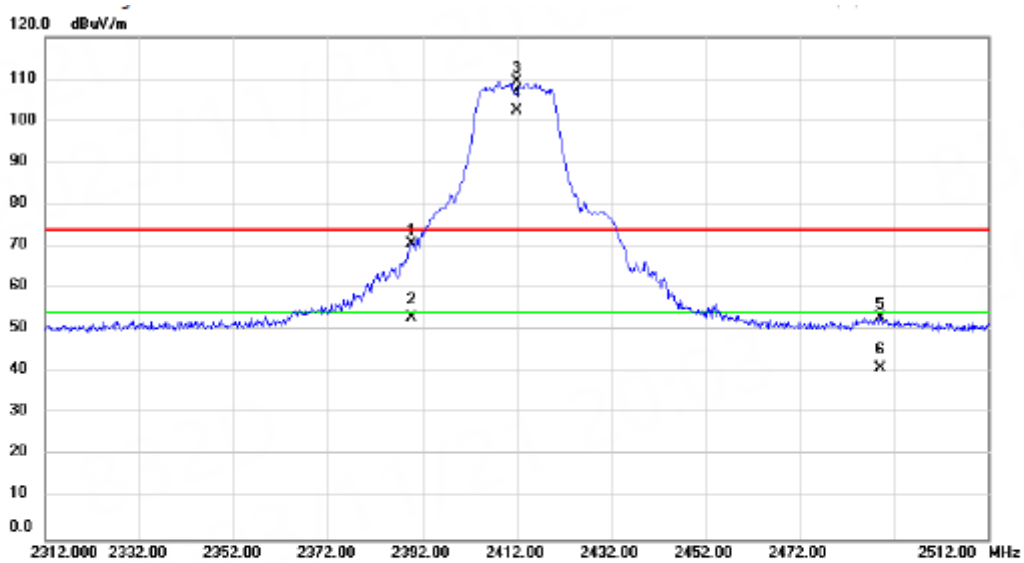

No. Mk.	Freq. MHz	Reading Level dBuV	Correct Factor dB	Measurement dBuV/m	Limit dBuV/m	Margin dB	Detector	Antenna Height cm	Table Degree degree	Comment
1	2389.800	66.53	4.10	70.63	74.00	-3.37	peak			
2	2389.800	49.00	4.10	53.10	54.00	-0.90	AVG			
3 X	2412.000	105.24	4.13	109.37	74.00	35.37	peak			
4 *	2412.000	98.32	4.13	102.45	54.00	48.45	AVG			
5	2489.200	48.80	4.20	53.00	74.00	-21.00	peak			
6	2489.200	36.84	4.20	41.04	54.00	-12.96	AVG			

REMARKS:

- (1) Measurement Value = Reading Level + Correct Factor.
- (2) Margin Level = Measurement Value - Limit Value.

Test Mode	IEEE 802.11g	Tested Date	2023/12/25
Test Frequency	2417MHz	Polarization	Vertical
Temp	25°C	Hum.	60%

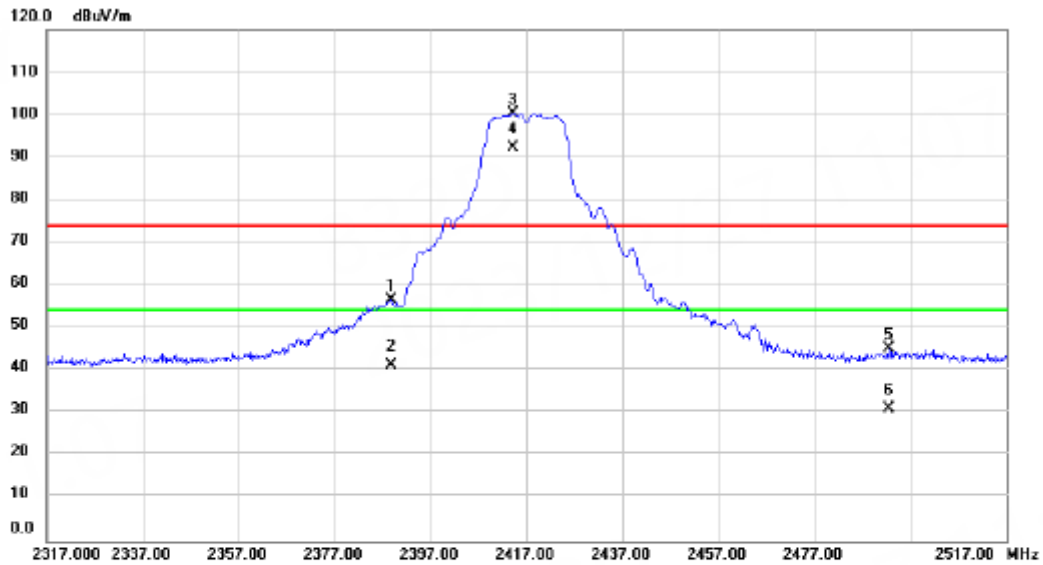

No. Mk.	Freq. MHz	Reading Level dBuV	Correct Factor dB	Measure- ment dBuV/m	Limit dBuV/m	Margin dB	Detector	Antenna Height cm	Table Degree degree	Comment
1	2388.800	63.01	-6.45	56.56	74.00	-17.44	peak			
2	2388.800	47.79	-6.45	41.34	54.00	-12.66	AVG			
3 X	2414.200	106.82	-6.41	100.41	74.00	26.41	peak			
4 *	2414.200	98.78	-6.41	92.37	54.00	38.37	AVG			
5	2492.600	51.54	-6.29	45.25	74.00	-28.75	peak			
6	2492.600	37.33	-6.29	31.04	54.00	-22.96	AVG			

REMARKS:

- (1) Measurement Value = Reading Level + Correct Factor.
- (2) Margin Level = Measurement Value - Limit Value.

Test Mode	IEEE 802.11g	Tested Date	2023/12/25
Test Frequency	2437MHz	Polarization	Vertical
Temp	25°C	Hum.	60%

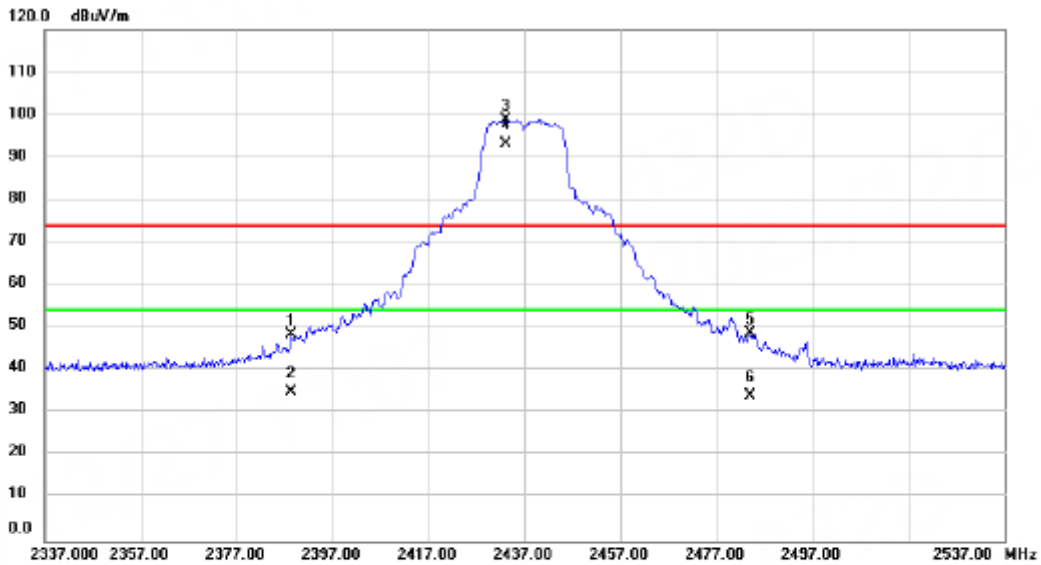

No.	Mk.	Freq. MHz	Reading Level dBuV	Correct Factor dB	Measure- ment dBuV/m	Limit dBuV/m	Margin dB	Detector	Antenna Height cm	Table Degree	Comment
1		2388.400	54.87	-6.45	48.42	74.00	-25.58	peak			
2		2388.400	41.46	-6.45	35.01	54.00	-18.99	AVG			
3	X	2433.000	105.22	-6.38	98.84	74.00	24.84	peak			
4	*	2433.000	99.62	-6.38	93.24	54.00	39.24	AVG			
5		2484.200	55.05	-6.30	48.75	74.00	-25.25	peak			
6		2484.200	40.31	-6.30	34.01	54.00	-19.99	AVG			

REMARKS:

- (1) Measurement Value = Reading Level + Correct Factor.
- (2) Margin Level = Measurement Value - Limit Value.

Test Mode	IEEE 802.11g	Tested Date	2023/12/25
Test Frequency	2457MHz	Polarization	Vertical
Temp	25°C	Hum.	60%

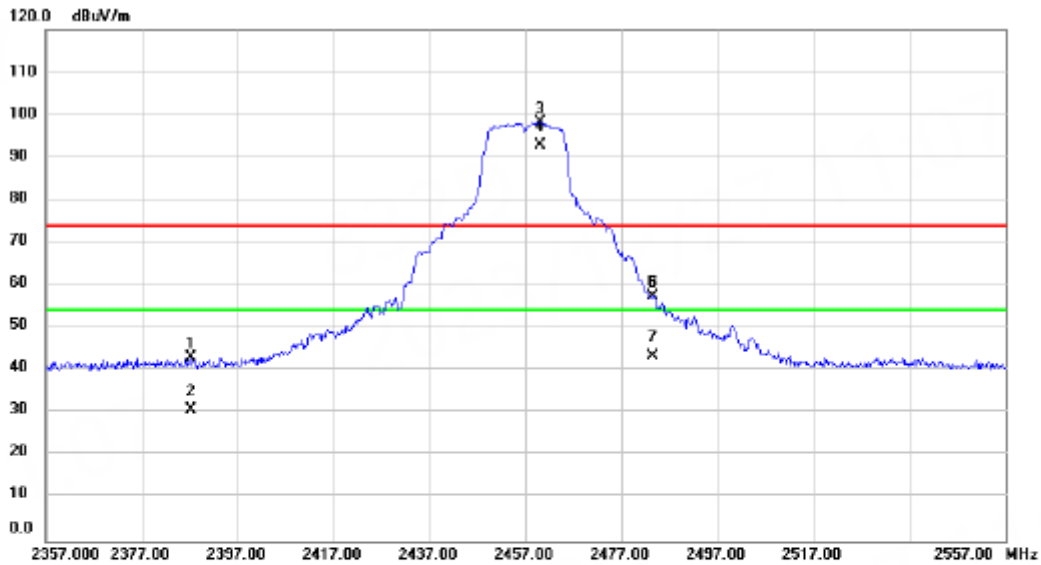

No.	Mk.	Freq. MHz	Reading Level dBuV	Correct Factor dB	Measure- ment dBuV/m	Limit dBuV/m	Margin dB	Detector	Antenna Height cm	Table Degree	Comment
1		2387.200	49.45	-6.45	43.00	74.00	-31.00	peak			
2		2387.200	37.11	-6.45	30.66	54.00	-23.34	AVG			
3	X	2460.200	104.68	-6.34	98.34	74.00	24.34	peak			
4	*	2460.200	99.13	-6.34	92.79	54.00	38.79	AVG			
5		2483.500	63.66	-6.30	57.36	74.00	-16.64	peak			
6		2483.600	63.66	-6.30	57.36	74.00	-16.64	peak			
7		2483.600	49.70	-6.30	43.40	54.00	-10.60	AVG			

REMARKS:

- (1) Measurement Value = Reading Level + Correct Factor.
- (2) Margin Level = Measurement Value - Limit Value.

Test Mode	IEEE 802.11g	Tested Date	2023/11/14
Test Frequency	2462MHz	Polarization	Horizontal
Temp	25°C	Hum.	60%

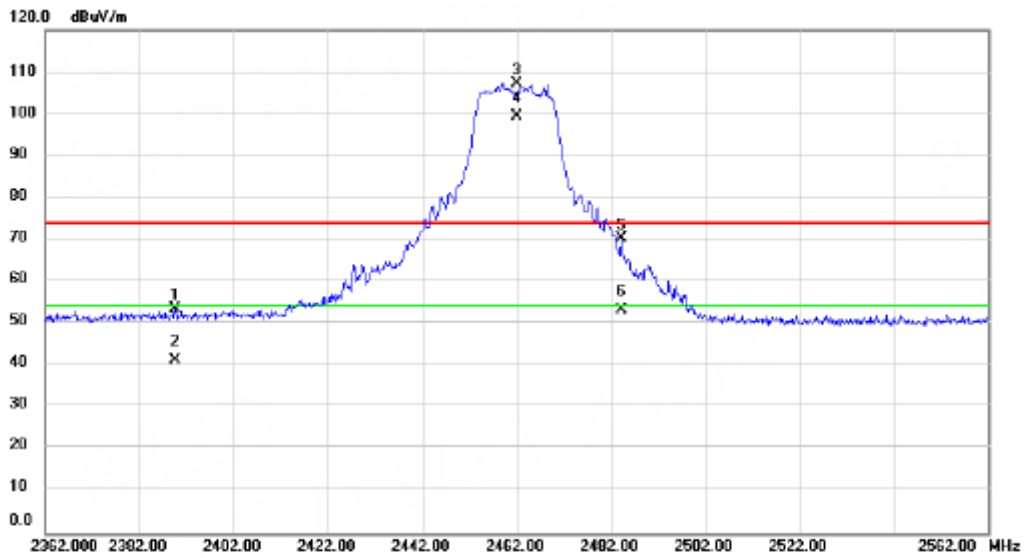

No.	Mk.	Freq.	Reading Level	Correct Factor	Measurement	Limit	Margin	Antenna Height	Table Degree	Comment
		MHz	dBuV	dB	dBuV/m	dBuV/m	dB	cm	degree	
1		2389.600	49.48	4.10	53.58	74.00	-20.42			peak
2		2389.600	37.02	4.10	41.12	54.00	-12.88			AVG
3	X	2462.000	102.94	4.19	107.13	74.00	33.13			peak
4	*	2462.000	95.15	4.19	99.34	54.00	45.34			AVG
5		2484.200	66.02	4.21	70.23	74.00	-3.77			peak
6		2484.200	48.93	4.21	53.14	54.00	-0.86			AVG

REMARKS:

- (1) Measurement Value = Reading Level + Correct Factor.
 (2) Margin Level = Measurement Value - Limit Value.

Test Mode	IEEE 802.11n (HT20)	Tested Date	2023/11/14
Test Frequency	2412MHz	Polarization	Horizontal
Temp	25°C	Hum.	60%

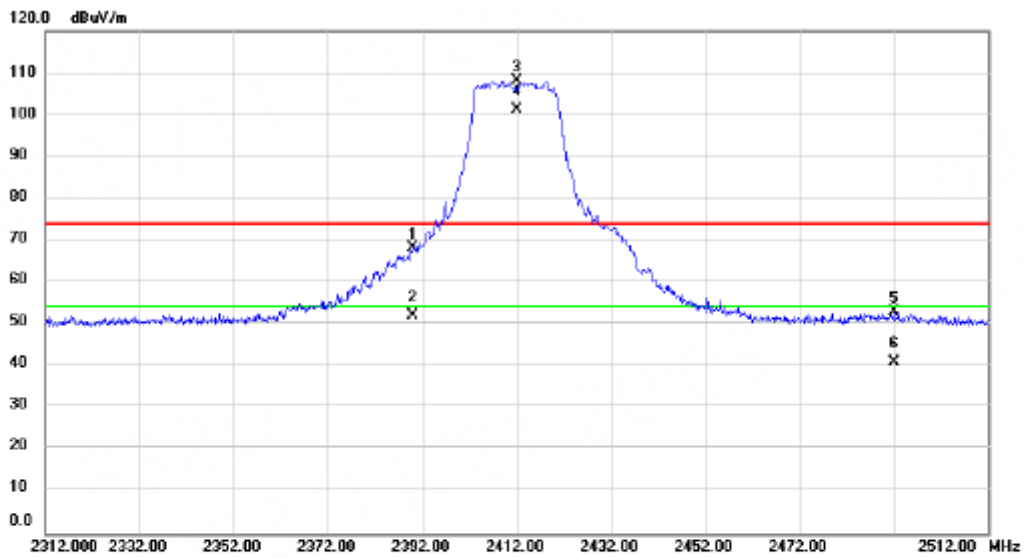

No. Mk.	Freq. MHz	Reading Level dBuV	Correct Factor dB	Measurement dBuV/m	Limit dBuV/m	Margin dB	Detector	Antenna Height cm	Table Degree	Comment
1	2390.000	64.02	4.10	68.12	74.00	-5.88	peak			
2	2390.000	47.95	4.10	52.05	54.00	-1.95	AVG			
3 X	2412.000	104.11	4.13	108.24	74.00	34.24	peak			
4 *	2412.000	97.25	4.13	101.38	54.00	47.38	AVG			
5	2492.000	48.63	4.21	52.84	74.00	-21.16	peak			
6	2492.000	36.66	4.21	40.87	54.00	-13.13	AVG			

REMARKS:

- (1) Measurement Value = Reading Level + Correct Factor.
- (2) Margin Level = Measurement Value - Limit Value.

Test Mode	IEEE 802.11n (HT20)	Tested Date	2023/12/25
Test Frequency	2417MHz	Polarization	Vertical
Temp	25°C	Hum.	60%

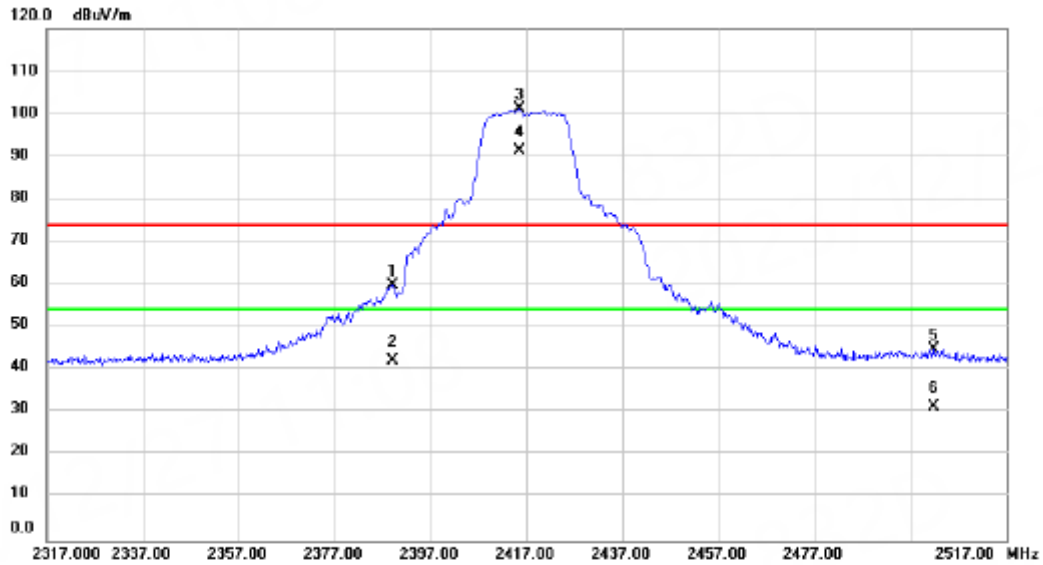

No.	Mk.	Freq.	Reading Level	Correct Factor	Measurement	Limit	Margin	Antenna Height	Table Degree	
		MHz	dBuV	dB	dBuV/m	dBuV/m	dB	cm	degree	Comment
1		2389.000	66.33	-6.45	59.88	74.00	-14.12			peak
2		2389.000	48.72	-6.45	42.27	54.00	-11.73			AVG
3	X	2415.400	107.67	-6.41	101.26	74.00	27.26			peak
4	*	2415.400	97.87	-6.41	91.46	54.00	37.46			AVG
5		2501.800	51.19	-6.27	44.92	74.00	-29.08			peak
6		2501.800	37.49	-6.27	31.22	54.00	-22.78			AVG

REMARKS:

- (1) Measurement Value = Reading Level + Correct Factor.
- (2) Margin Level = Measurement Value - Limit Value.

Test Mode	IEEE 802.11n (HT20)	Tested Date	2023/12/25
Test Frequency	2437MHz	Polarization	Vertical
Temp	25°C	Hum.	60%

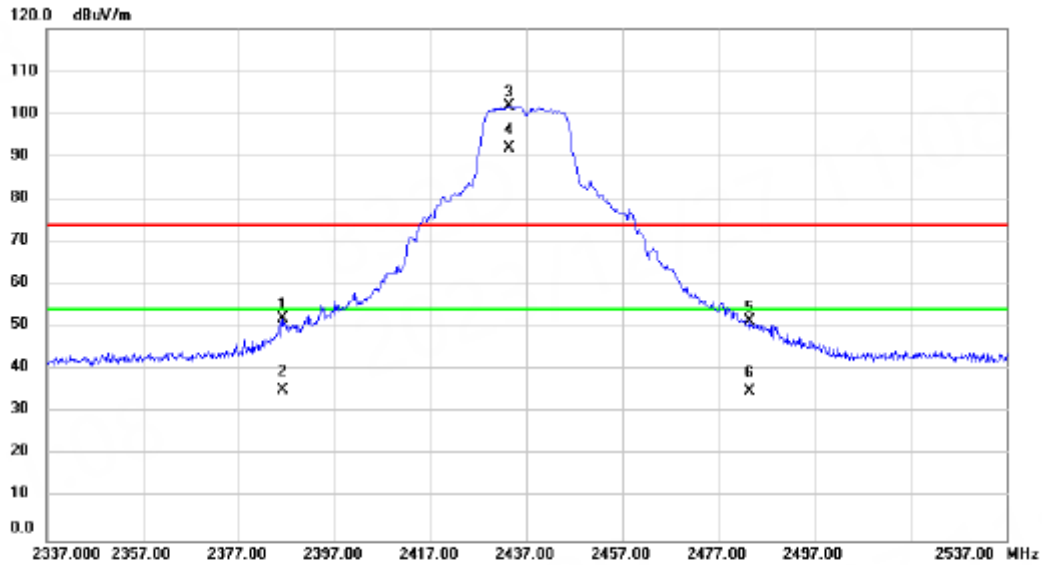

No.	Mk.	Freq.	Reading Level	Correct Factor	Measurement	Limit	Margin	Antenna Height	Table Degree	Comment
		MHz	dBuV	dB	dBuV/m	dBuV/m	dB	cm	degree	
1		2386.200	58.48	-6.45	52.03	74.00	-21.97			peak
2		2386.200	41.82	-6.45	35.37	54.00	-18.63			AVG
3	X	2433.400	108.18	-6.38	101.80	74.00	27.80			peak
4	*	2433.400	98.45	-6.38	92.07	54.00	38.07			AVG
5		2483.600	57.82	-6.30	51.52	74.00	-22.48			peak
6		2483.600	41.12	-6.30	34.82	54.00	-19.18			AVG

REMARKS:

(1) Measurement Value = Reading Level + Correct Factor.

(2) Margin Level = Measurement Value - Limit Value.

Test Mode	IEEE 802.11n (HT20)	Tested Date	2023/12/25
Test Frequency	2457MHz	Polarization	Vertical
Temp	25°C	Hum.	60%

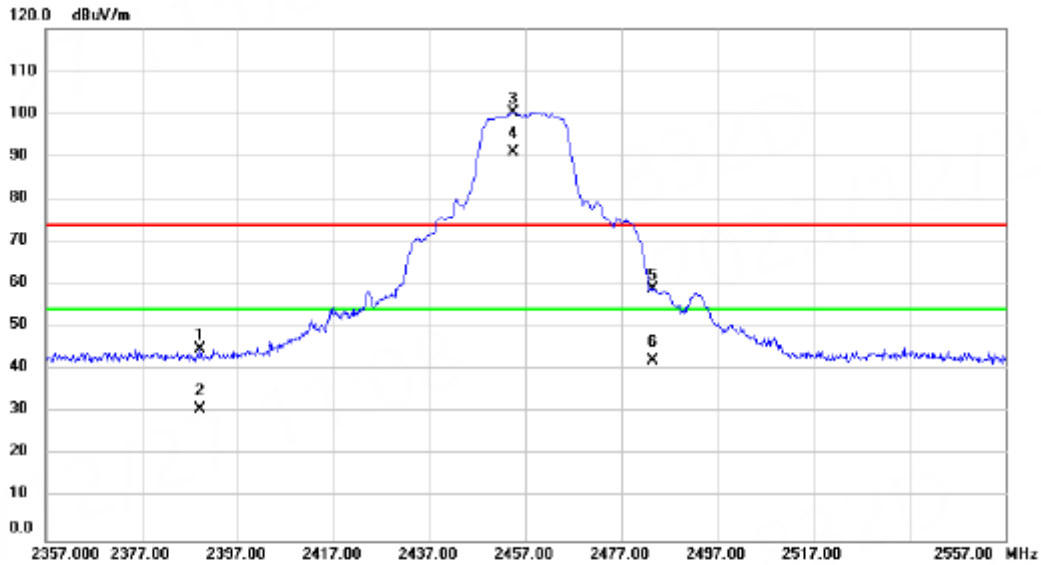

No.	Mk.	Freq.	Reading Level	Correct Factor	Measurement	Limit	Margin	Antenna Height	Table Degree	
		MHz	dBuV	dB	dBuV/m	dBuV/m	dB	cm	degree	Comment
1		2389.200	51.34	-6.45	44.89	74.00	-29.11			peak
2		2389.200	37.35	-6.45	30.90	54.00	-23.10			AVG
3	X	2454.600	106.66	-6.35	100.31	74.00	26.31			peak
4	*	2454.600	97.32	-6.35	90.97	54.00	36.97			AVG
5		2483.600	65.40	-6.30	59.10	74.00	-14.90			peak
6		2483.600	48.35	-6.30	42.05	54.00	-11.95			AVG

- (1) Measurement Value = Reading Level + Correct Factor.
- (2) Margin Level = Measurement Value - Limit Value.

Test Mode	IEEE 802.11n (HT20)	Tested Date	2023/11/14
Test Frequency	2462MHz	Polarization	Horizontal
Temp	25°C	Hum.	60%

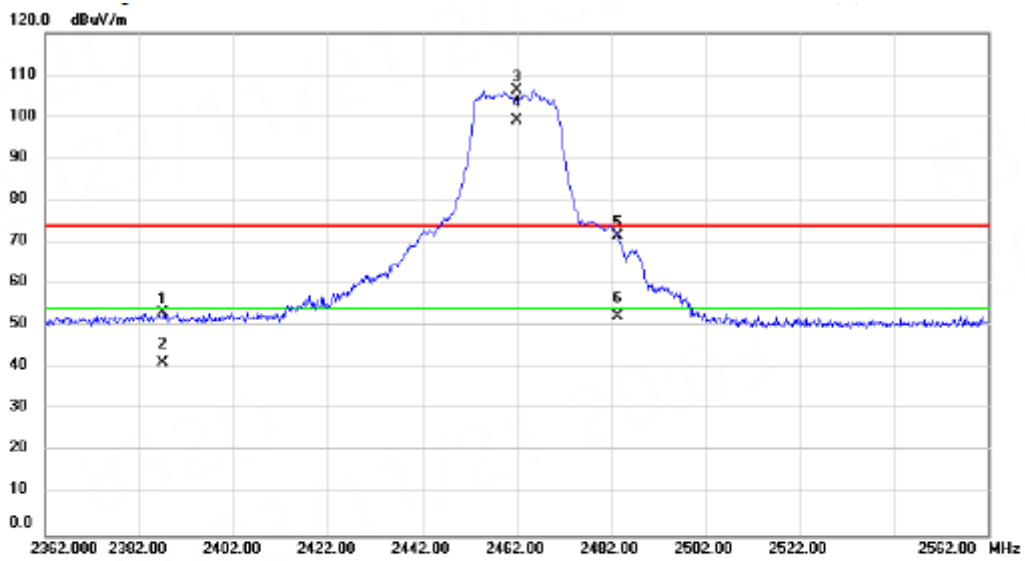

No.	Mk.	Freq.	Reading Level	Correct Factor	Measurement	Limit	Margin	Antenna Height	Table Degree	
		MHz	dBuV	dB	dBuV/m	dBuV/m	dB	cm	degree	Comment
1		2387.000	49.13	4.10	53.23	74.00	-20.77			peak
2		2387.000	37.06	4.10	41.16	54.00	-12.84			AVG
3	X	2462.000	102.22	4.19	106.41	74.00	32.41			peak
4	*	2462.000	94.99	4.19	99.18	54.00	45.18			AVG
5		2483.500	67.32	4.21	71.53	74.00	-2.47			peak
6		2483.500	48.20	4.21	52.41	54.00	-1.59			AVG

- (1) Measurement Value = Reading Level + Correct Factor.
 (2) Margin Level = Measurement Value - Limit Value.

Test Mode	IEEE 802.11b	Tested Date	2023/11/14
Test Frequency	2412MHz	Polarization	Vertical
Temp	25°C	Hum.	60%

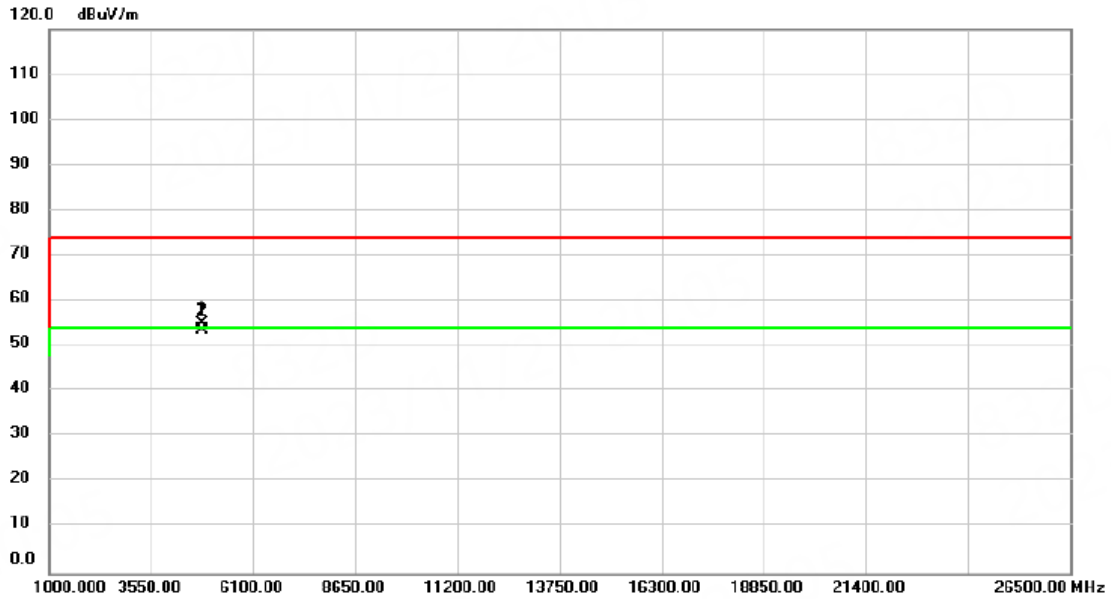

No.	Mk.	Freq.	Reading Level	Correct Factor	Measurement	Limit	Margin	Antenna Height	Table Degree	Comment
		MHz	dBuV	dB	dBuV/m	dBuV/m	dB	cm	degree	
1		4824.000	54.27	0.77	55.04	74.00	-18.96			peak
2	*	4824.000	52.64	0.77	53.41	54.00	-0.59			AVG

REMARKS:

- (1) Measurement Value = Reading Level + Correct Factor.
- (2) Margin Level = Measurement Value - Limit Value.

Test Mode	IEEE 802.11b	Tested Date	2023/11/14
Test Frequency	2412MHz	Polarization	Horizontal
Temp	25°C	Hum.	60%

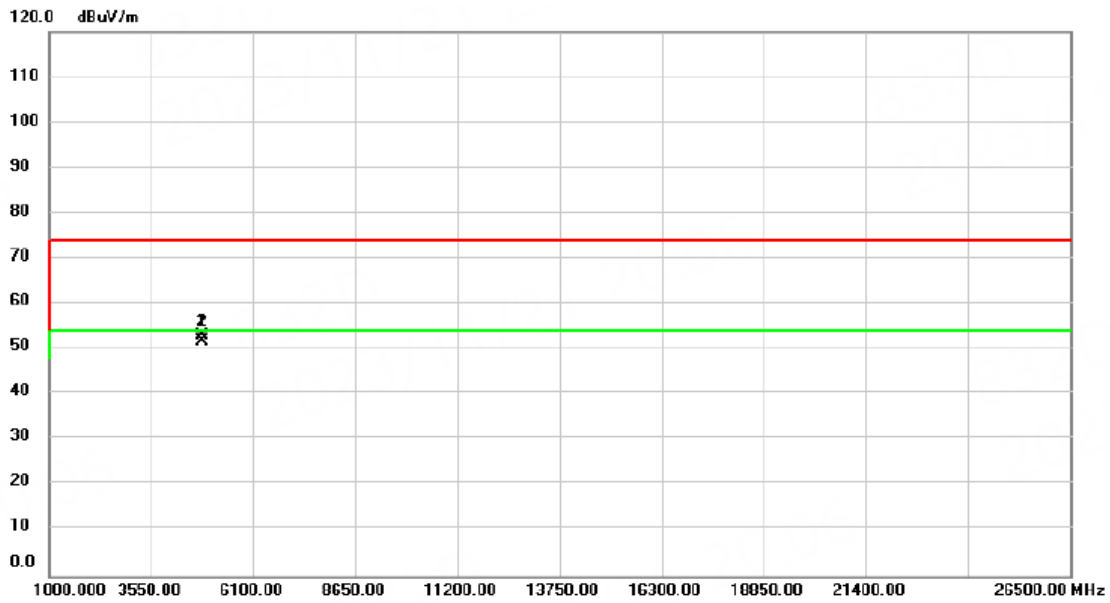

No.	Mk.	Freq.	Reading Level	Correct Factor	Measurement	Limit	Margin	Antenna Height	Table Degree	
		MHz	dBuV	dB	dBuV/m	dBuV/m	dB	cm	degree	Comment
1		4825.000	52.32	0.77	53.09	74.00	-20.91			peak
2	*	4825.000	50.93	0.77	51.70	54.00	-2.30			AVG

REMARKS:

- (1) Measurement Value = Reading Level + Correct Factor.
- (2) Margin Level = Measurement Value - Limit Value.

Test Mode	IEEE 802.11b	Tested Date	2023/12/25
Test Frequency	2417MHz	Polarization	Vertical
Temp	25°C	Hum.	60%

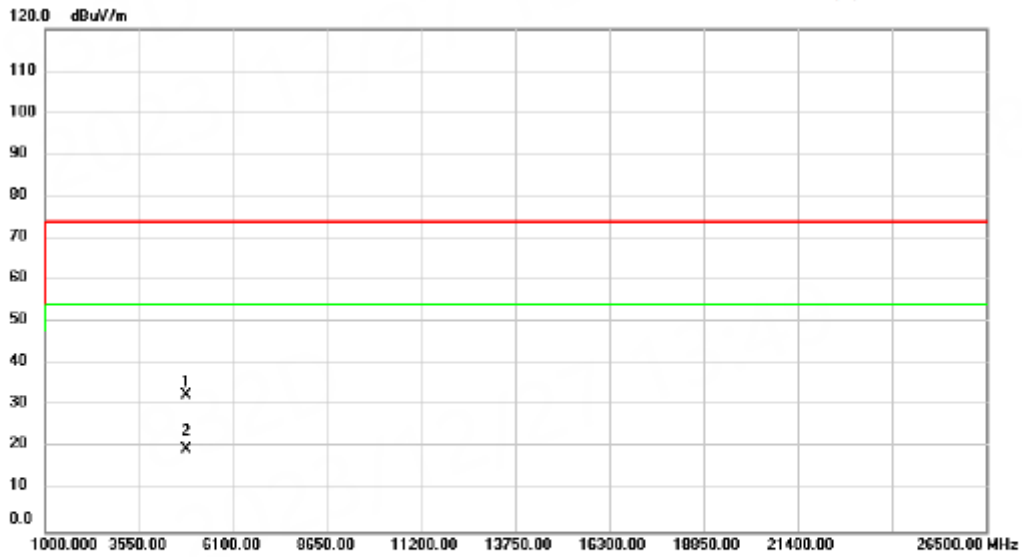

No.	Mk.	Freq.	Reading Level	Correct Factor	Measurement	Limit	Margin	Antenna Height	Table Degree	
		MHz	dBuV	dB	dBuV/m	dBuV/m	dB	cm	degree	Comment
1		4834.000	41.32	-8.80	32.52	74.00	-41.48			peak
2	*	4834.000	28.59	-8.80	19.79	54.00	-34.21			AVG

REMARKS:

- (1) Measurement Value = Reading Level + Correct Factor.
- (2) Margin Level = Measurement Value - Limit Value.

Test Mode	IEEE 802.11b	Tested Date	2023/12/25
Test Frequency	2417MHz	Polarization	Horizontal
Temp	25°C	Hum.	60%

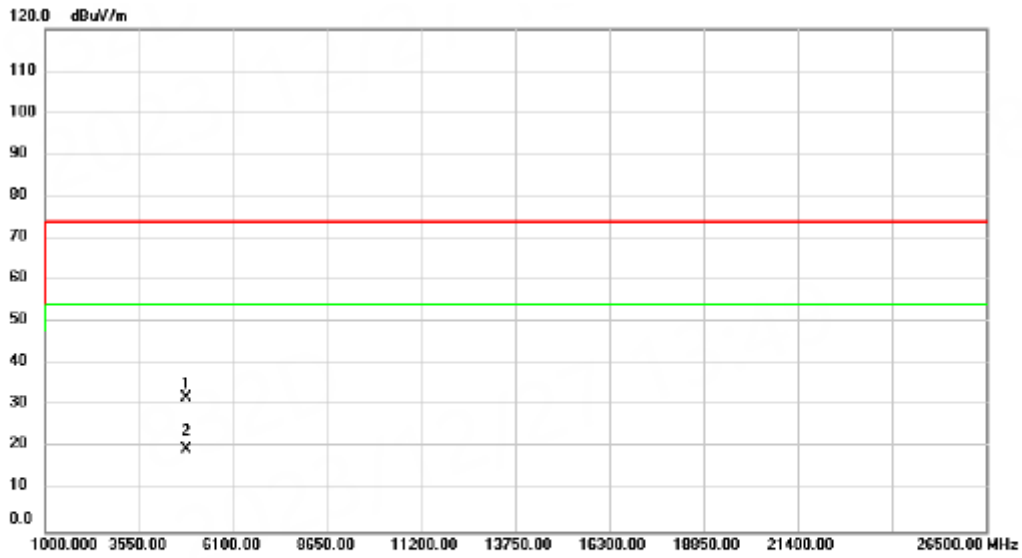

No.	Mk.	Freq.	Reading Level	Correct Factor	Measurement	Limit	Margin	Antenna Height	Table Degree	
		MHz	dBuV	dB	dBuV/m	dBuV/m	dB	cm	degree	Comment
1		4834.000	40.88	-8.80	32.08	74.00	-41.92			peak
2	*	4834.000	28.60	-8.80	19.80	54.00	-34.20			AVG

REMARKS:

- (1) Measurement Value = Reading Level + Correct Factor.
- (2) Margin Level = Measurement Value - Limit Value.

Test Mode	IEEE 802.11b	Tested Date	2023/11/14
Test Frequency	2437MHz	Polarization	Vertical
Temp	25°C	Hum.	60%

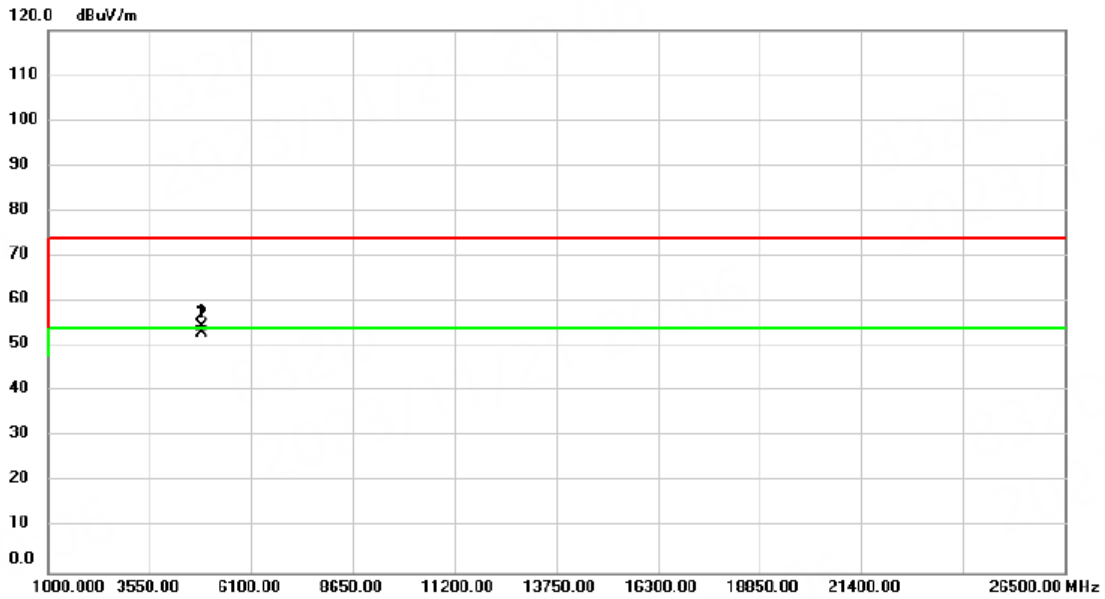

No.	Mk.	Freq. MHz	Reading Level dBuV	Correct Factor dB	Measure- ment dBuV/m	Limit dBuV/m	Margin dB	Detector	Antenna Height cm	Table Degree	Comment
1		4874.000	53.54	0.91	54.45	74.00	-19.55	peak			
2	*	4874.000	52.11	0.91	53.02	54.00	-0.98	AVG			

REMARKS:

- (1) Measurement Value = Reading Level + Correct Factor.
- (2) Margin Level = Measurement Value - Limit Value.

Test Mode	IEEE 802.11b	Tested Date	2023/11/14
Test Frequency	2437MHz	Polarization	Horizontal
Temp	25°C	Hum.	60%

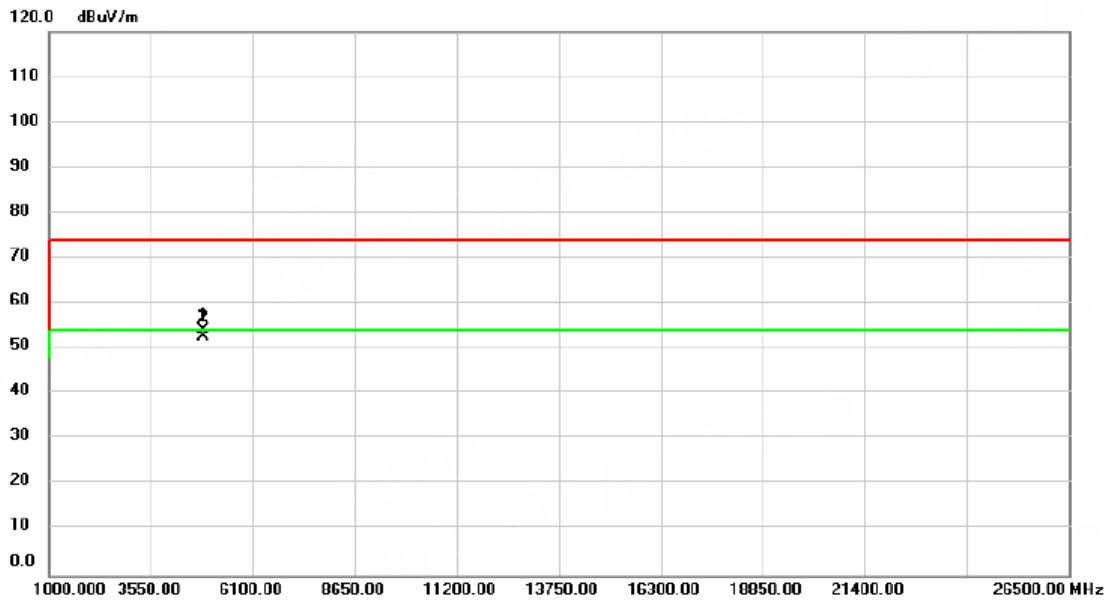

No.	Mk.	Freq. MHz	Reading Level dBuV	Correct Factor dB	Measure- ment dBuV/m	Limit dBuV/m	Margin dB	Detector	Antenna Height cm	Table Degree	Comment
1		4874.000	53.22	0.91	54.13	74.00	-19.87	peak			
2	*	4874.000	51.77	0.91	52.68	54.00	-1.32	AVG			

REMARKS:

- (1) Measurement Value = Reading Level + Correct Factor.
- (2) Margin Level = Measurement Value - Limit Value.

Test Mode	IEEE 802.11b	Tested Date	2023/12/25
Test Frequency	2457MHz	Polarization	Vertical
Temp	25°C	Hum.	60%

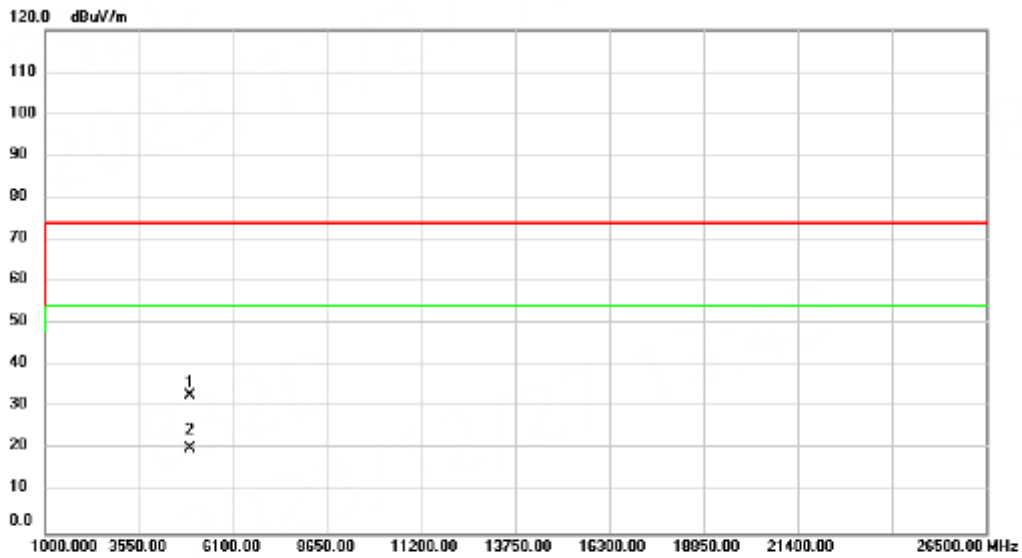

No.	Mk.	Freq.	Reading Level	Correct Factor	Measurement	Limit	Margin	Antenna Height	Table Degree	
		MHz	dBuV	dB	dBuV/m	dBuV/m	dB	cm	degree	Comment
1		4914.000	41.39	-8.55	32.84	74.00	-41.16			peak
2	*	4914.000	28.91	-8.55	20.36	54.00	-33.64			AVG

REMARKS:

- (1) Measurement Value = Reading Level + Correct Factor.
- (2) Margin Level = Measurement Value - Limit Value.

Test Mode	IEEE 802.11b	Tested Date	2023/12/25
Test Frequency	2457MHz	Polarization	Horizontal
Temp	25°C	Hum.	60%

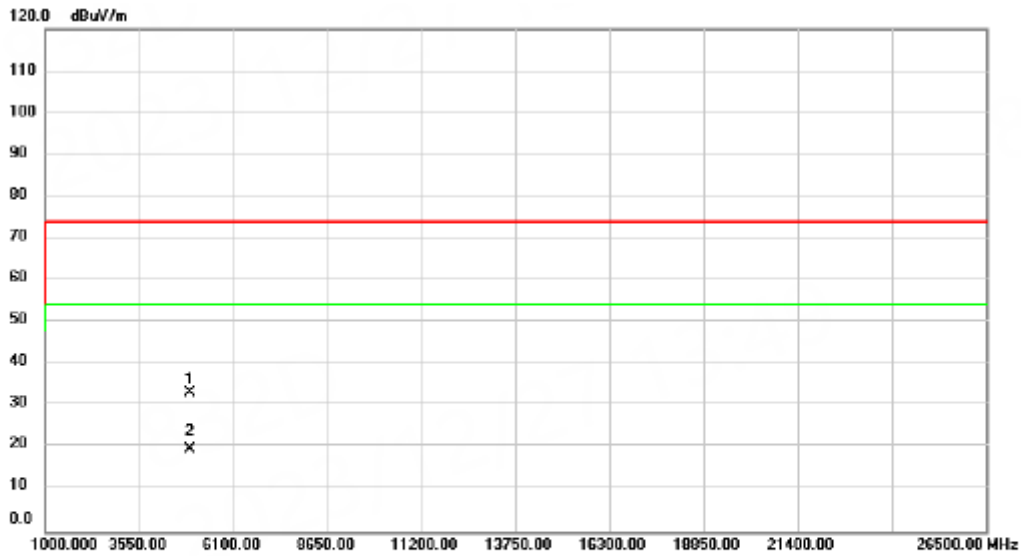

No.	Mk.	Freq.	Reading Level	Correct Factor	Measurement	Limit	Margin	Antenna Height	Table Degree		
		MHz	dBuV	dB	dBuV/m	dBuV/m	dB	Detector	cm	degree	Comment
1		4914.000	41.67	-8.55	33.12	74.00	-40.88	peak			
2	*	4914.000	28.22	-8.55	19.67	54.00	-34.33	AVG			

REMARKS:

- (1) Measurement Value = Reading Level + Correct Factor.
- (2) Margin Level = Measurement Value - Limit Value.

Test Mode	IEEE 802.11b	Tested Date	2023/11/14
Test Frequency	2462MHz	Polarization	Vertical
Temp	25°C	Hum.	60%

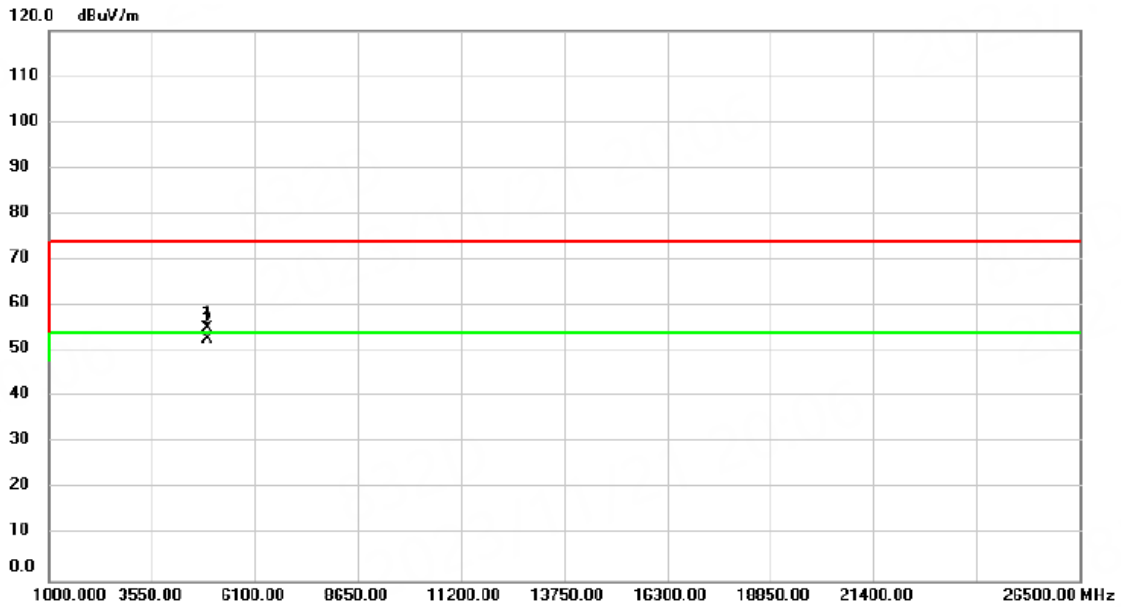

No.	Mk.	Freq. MHz	Reading Level dBuV	Correct Factor dB	Measure- ment dBuV/m	Limit dBuV/m	Margin dB	Detector	Antenna Height cm	Table Degree	Comment
1		4924.000	53.87	1.05	54.92	74.00	-19.08	peak			
2	*	4924.000	51.60	1.05	52.65	54.00	-1.35	AVG			

REMARKS:

- (1) Measurement Value = Reading Level + Correct Factor.
- (2) Margin Level = Measurement Value - Limit Value.

Test Mode	IEEE 802.11b	Tested Date	2023/11/14
Test Frequency	2462MHz	Polarization	Horizontal
Temp	25°C	Hum.	60%

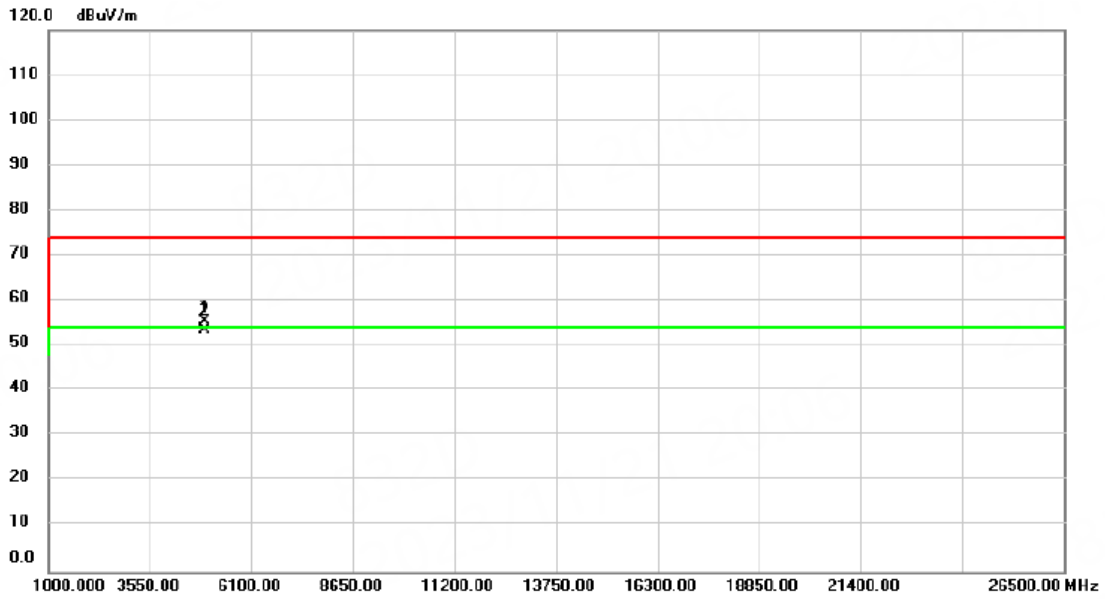

No. Mk.	Freq. MHz	Reading Level dBuV	Correct Factor dB	Measurement dBuV/m	Limit dBuV/m	Margin dB	Detector	Antenna Height cm	Table Degree	Comment
1	4924.000	54.17	1.05	55.22	74.00	-18.78	peak			
2 *	4924.000	52.61	1.05	53.66	54.00	-0.34	AVG			

REMARKS:

- (1) Measurement Value = Reading Level + Correct Factor.
- (2) Margin Level = Measurement Value - Limit Value.

Test Mode	IEEE 802.11g	Tested Date	2023/11/14
Test Frequency	2412MHz	Polarization	Vertical
Temp	25°C	Hum.	60%

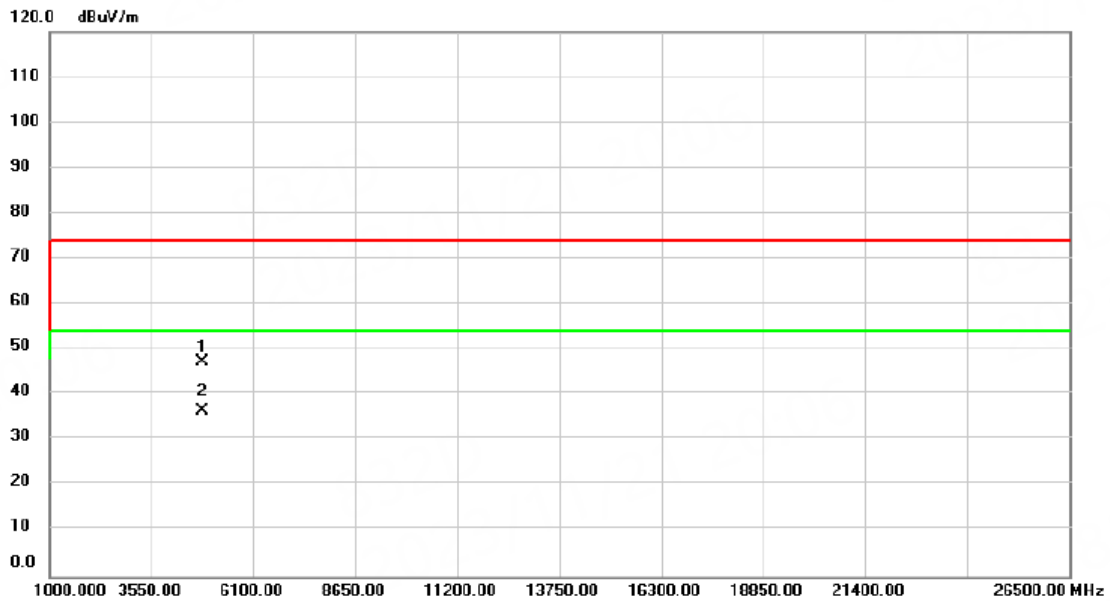

No.	Mk.	Freq.	Reading Level	Correct Factor	Measurement	Limit	Margin	Antenna Height	Table Degree	
		MHz	dBuV	dB	dBuV/m	dBuV/m	dB	cm	degree	Comment
1		4824.000	46.41	0.77	47.18	74.00	-26.82	peak		
2	*	4824.000	35.79	0.77	36.56	54.00	-17.44	AVG		

REMARKS:

- (1) Measurement Value = Reading Level + Correct Factor.
- (2) Margin Level = Measurement Value - Limit Value.

Test Mode	IEEE 802.11g	Tested Date	2023/11/14
Test Frequency	2412MHz	Polarization	Horizontal
Temp	25°C	Hum.	60%

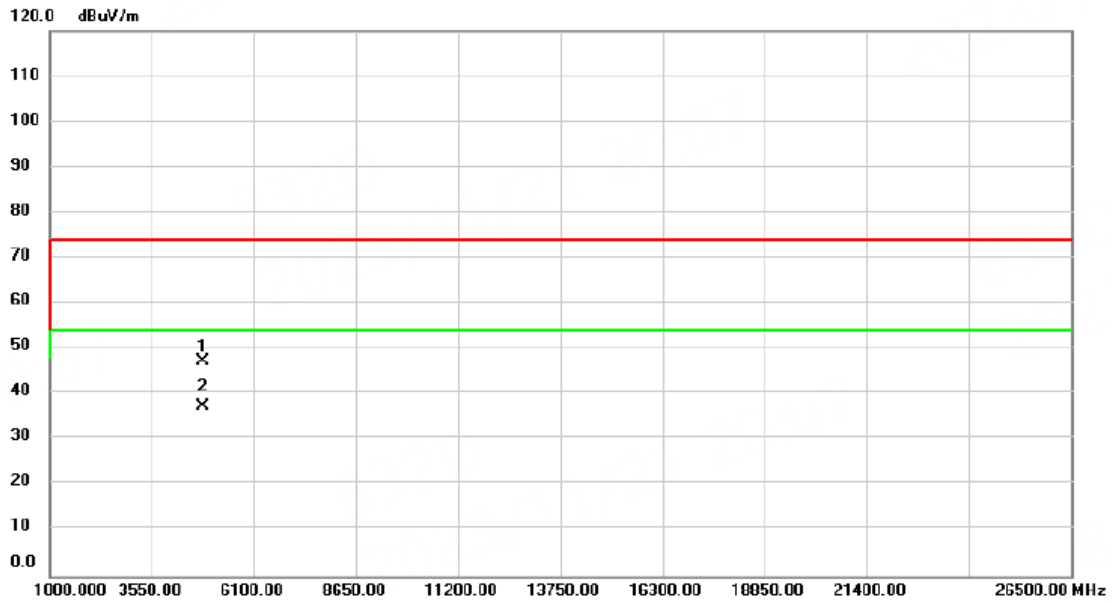

No.	Mk.	Freq. MHz	Reading Level dBuV	Correct Factor dB	Measure- ment dBuV/m	Limit dBuV/m	Margin dB	Antenna Height cm	Table Degree	Comment
1		4824.000	46.50	0.77	47.27	74.00	-26.73	peak		
2	*	4824.000	36.62	0.77	37.39	54.00	-16.61	AVG		

REMARKS:

- (1) Measurement Value = Reading Level + Correct Factor.
- (2) Margin Level = Measurement Value - Limit Value.

Test Mode	IEEE 802.11g	Tested Date	2023/12/25
Test Frequency	2417MHz	Polarization	Vertical
Temp	25°C	Hum.	60%

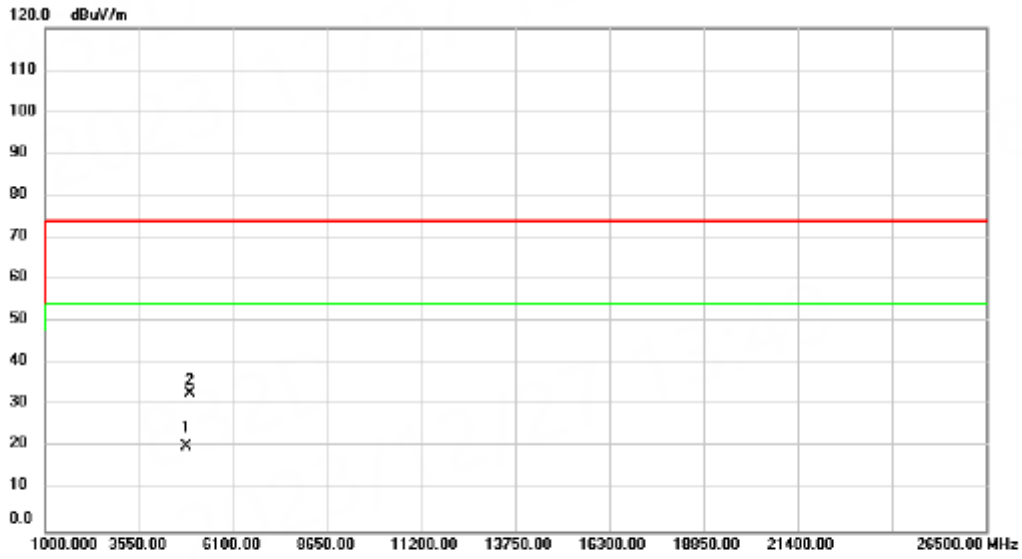

No.	Mk.	Freq.	Reading Level	Correct Factor	Measurement	Limit	Margin	Antenna Height	Table Degree	Comment
		MHz	dBuV	dB	dBuV/m	dBuV/m	dB	cm	degree	
1	*	4834.000	28.94	-8.80	20.14	54.00	-33.86	AVG		
2		4934.000	41.36	-8.47	32.89	74.00	-41.11	peak		

REMARKS:

- (1) Measurement Value = Reading Level + Correct Factor.
- (2) Margin Level = Measurement Value - Limit Value.

Test Mode	IEEE 802.11g	Tested Date	2023/12/25
Test Frequency	2417MHz	Polarization	Horizontal
Temp	25°C	Hum.	60%

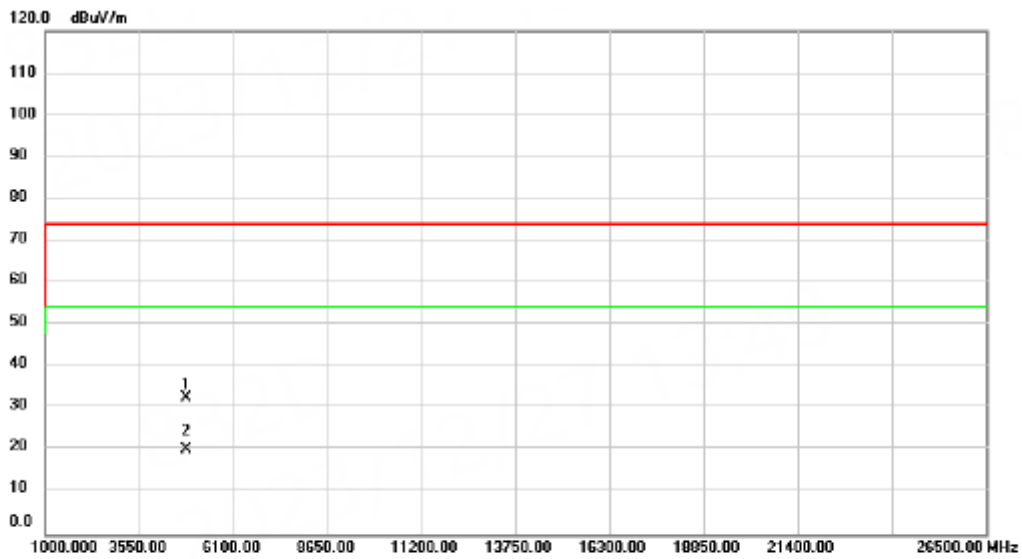

No.	Mk.	Freq.	Reading Level	Correct Factor	Measurement	Limit	Margin	Antenna Height	Table Degree	
		MHz	dBuV	dB	dBuV/m	dBuV/m	dB	cm	degree	Comment
1		4834.000	41.38	-8.80	32.58	74.00	-41.42	peak		
2	*	4834.000	29.10	-8.80	20.30	54.00	-33.70	AVG		

REMARKS:

- (1) Measurement Value = Reading Level + Correct Factor.
- (2) Margin Level = Measurement Value - Limit Value.

Test Mode	IEEE 802.11g	Tested Date	2023/11/14
Test Frequency	2437MHz	Polarization	Vertical
Temp	25°C	Hum.	60%

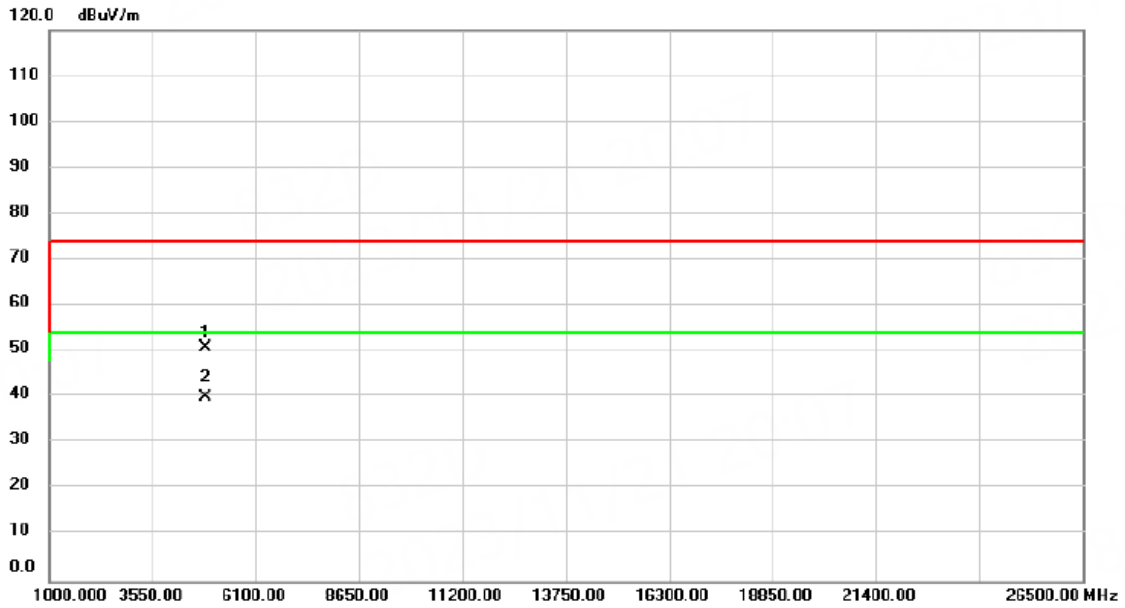

No.	Mk.	Freq. MHz	Reading Level dBuV	Correct Factor dB	Measure- ment dBuV/m	Limit dBuV/m	Margin dB	Detector	Antenna Height cm	Table Degree degree	Comment
1		4874.000	49.87	0.91	50.78	74.00	-23.22	peak			
2	*	4874.000	39.09	0.91	40.00	54.00	-14.00	AVG			

REMARKS:

- (1) Measurement Value = Reading Level + Correct Factor.
- (2) Margin Level = Measurement Value - Limit Value.

Test Mode	IEEE 802.11g	Tested Date	2023/11/14
Test Frequency	2437MHz	Polarization	Horizontal
Temp	25°C	Hum.	60%

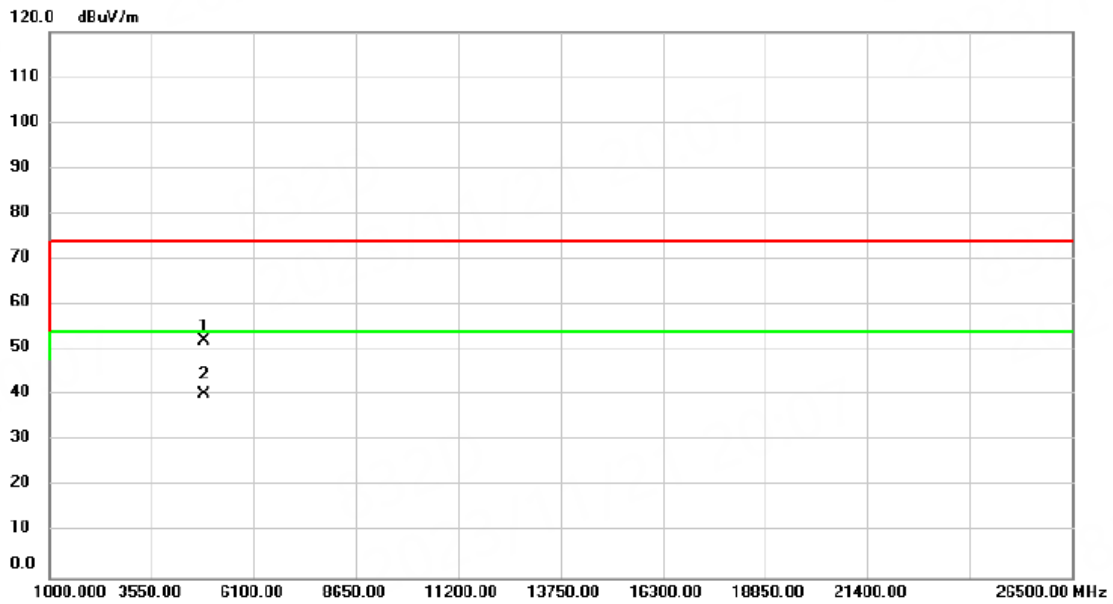

No.	Mk.	Freq.	Reading Level	Correct Factor	Measurement	Limit	Margin	Antenna Height	Table Degree	
		MHz	dBuV	dB	dBuV/m	dBuV/m	dB	cm	degree	Comment
1		4874.000	51.07	0.91	51.98	74.00	-22.02	peak		
2	*	4874.000	39.52	0.91	40.43	54.00	-13.57	AVG		

REMARKS:

- (1) Measurement Value = Reading Level + Correct Factor.
- (2) Margin Level = Measurement Value - Limit Value.

Test Mode	IEEE 802.11g	Tested Date	2023/12/25
Test Frequency	2457MHz	Polarization	Vertical
Temp	25°C	Hum.	60%

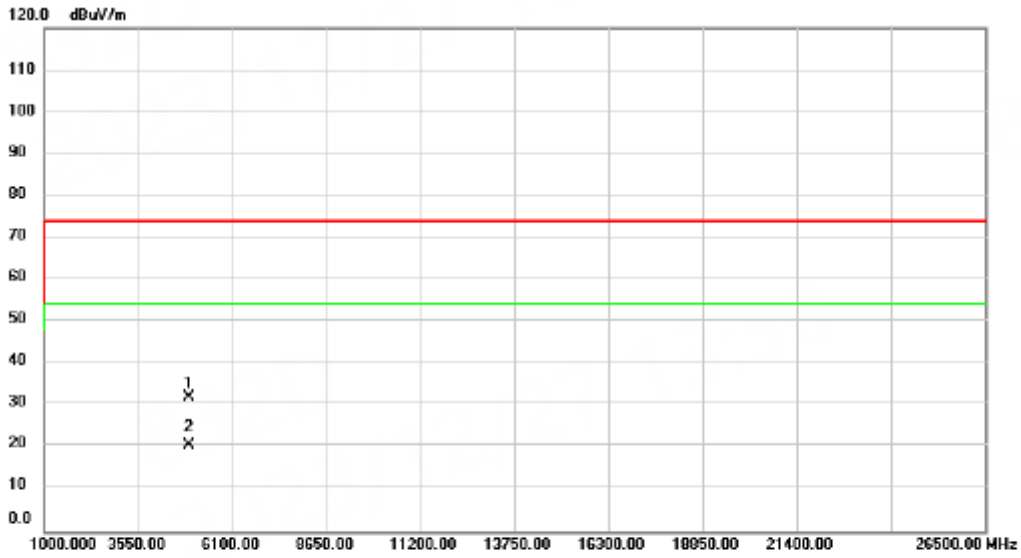

No.	Mk.	Freq.	Reading Level	Correct Factor	Measurement	Limit	Margin	Antenna Height	Table Degree	
		MHz	dBuV	dB	dBuV/m	dBuV/m	dB	cm	degree	Comment
1		4914.000	40.40	-8.55	31.85	74.00	-42.15			peak
2	*	4914.000	29.05	-8.55	20.50	54.00	-33.50			AVG

REMARKS:

- (1) Measurement Value = Reading Level + Correct Factor.
- (2) Margin Level = Measurement Value - Limit Value.

Test Mode	IEEE 802.11g	Tested Date	2023/12/25
Test Frequency	2457MHz	Polarization	Horizontal
Temp	25°C	Hum.	60%

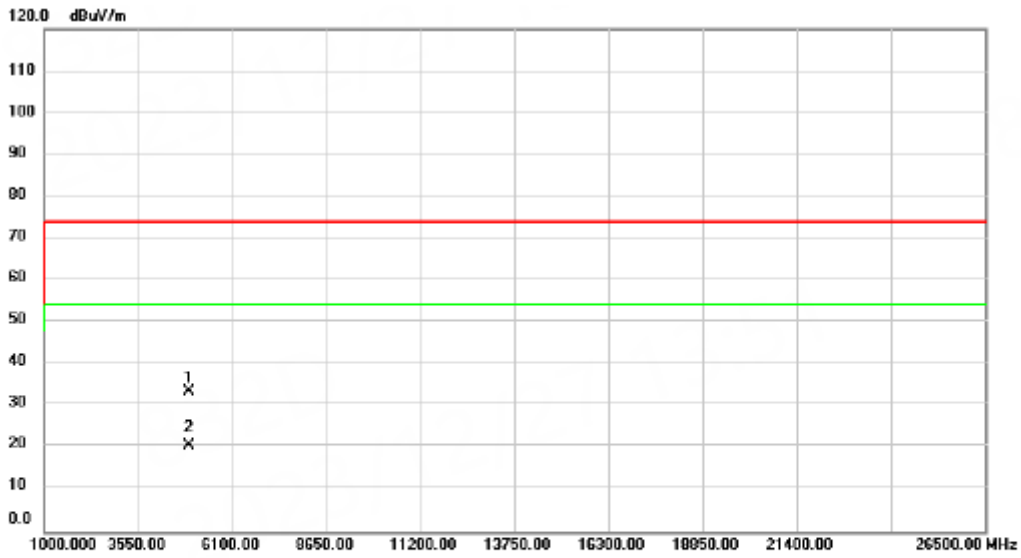

No.	Mk.	Freq.	Reading Level	Correct Factor	Measurement	Limit	Margin	Antenna Height	Table Degree	
		MHz	dBuV	dB	dBuV/m	dBuV/m	dB	cm	degree	Comment
1		4914.000	41.92	-8.55	33.37	74.00	-40.63			peak
2	*	4914.000	29.07	-8.55	20.52	54.00	-33.48			AVG

REMARKS:

- (1) Measurement Value = Reading Level + Correct Factor.
- (2) Margin Level = Measurement Value - Limit Value.

Test Mode	IEEE 802.11g	Tested Date	2023/11/14
Test Frequency	2462MHz	Polarization	Vertical
Temp	25°C	Hum.	60%

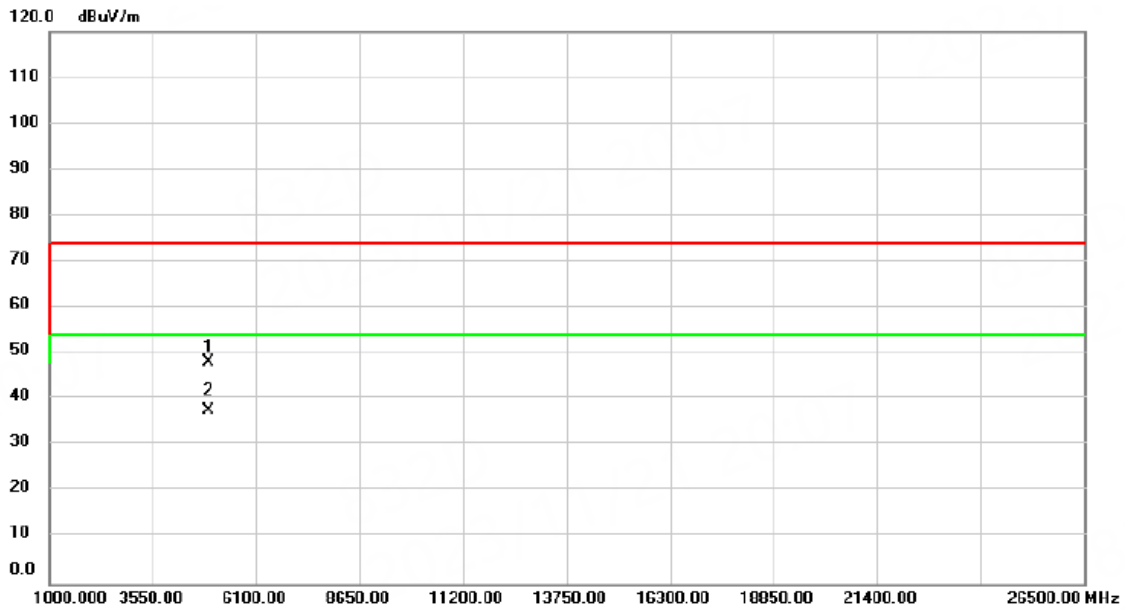

No.	Mk.	Freq.	Reading Level	Correct Factor	Measurement	Limit	Margin	Antenna Height	Table Degree	Comment
		MHz	dBuV	dB	dBuV/m	dBuV/m	dB	cm	degree	
1		4924.000	46.97	1.05	48.02	74.00	-25.98	peak		
2	*	4924.000	36.50	1.05	37.55	54.00	-16.45	AVG		

REMARKS:

- (1) Measurement Value = Reading Level + Correct Factor.
- (2) Margin Level = Measurement Value - Limit Value.

Test Mode	IEEE 802.11g	Tested Date	2023/11/14
Test Frequency	2462MHz	Polarization	Horizontal
Temp	25°C	Hum.	60%

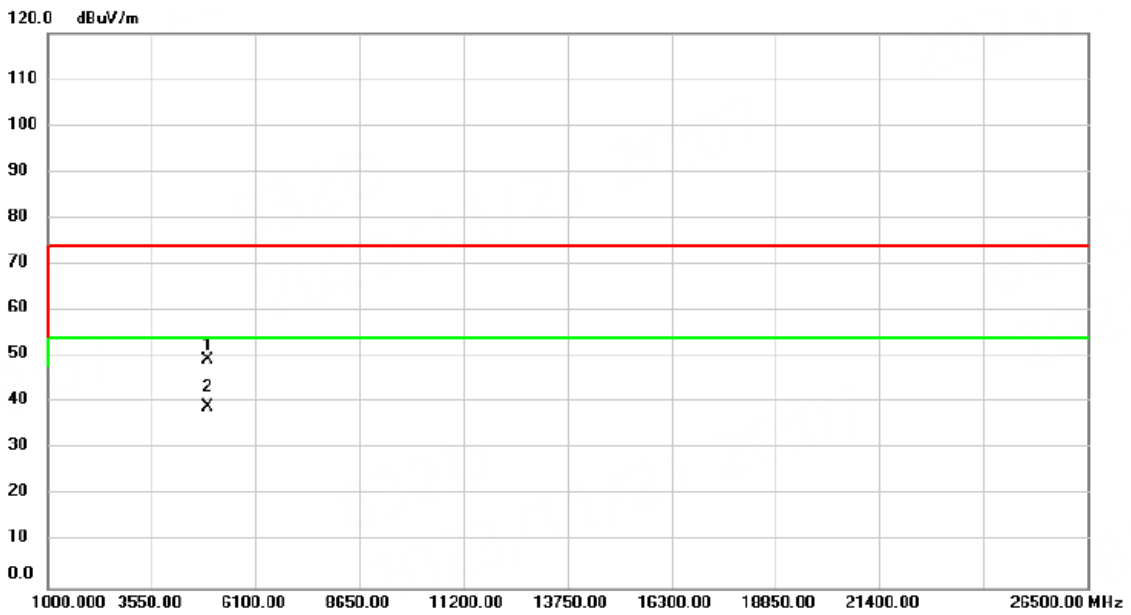

No.	Mk.	Freq. MHz	Reading Level dBuV	Correct Factor dB	Measure- ment dBuV/m	Limit dBuV/m	Margin dB	Detector	Antenna Height cm	Table Degree	Comment
1		4924.000	48.35	1.05	49.40	74.00	-24.60	peak			
2	*	4924.000	38.04	1.05	39.09	54.00	-14.91	AVG			

REMARKS:

- (1) Measurement Value = Reading Level + Correct Factor.
- (2) Margin Level = Measurement Value - Limit Value.

Test Mode	IEEE 802.11n (HT20)	Tested Date	2023/11/14
Test Frequency	2412MHz	Polarization	Vertical
Temp	25°C	Hum.	60%

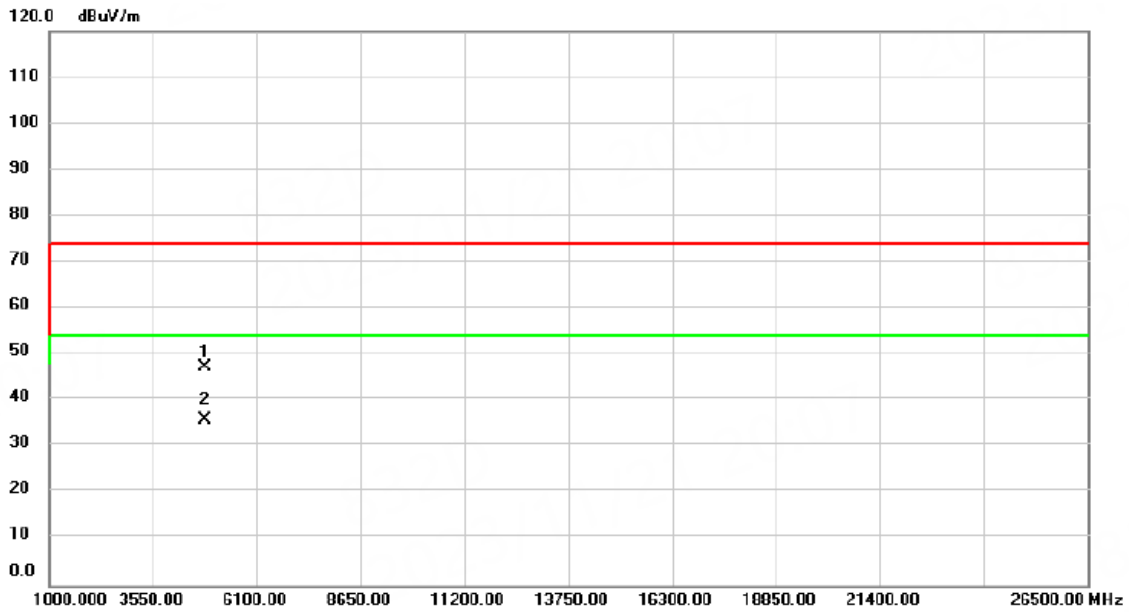

No.	Mk.	Freq.	Reading Level	Correct Factor	Measurement	Limit	Margin	Antenna Height	Table Degree	
		MHz	dBuV	dB	dBuV/m	dBuV/m	dB	cm	degree	Comment
1		4824.000	46.49	0.77	47.26	74.00	-26.74			peak
2	*	4824.000	35.18	0.77	35.95	54.00	-18.05			AVG

REMARKS:

- (1) Measurement Value = Reading Level + Correct Factor.
- (2) Margin Level = Measurement Value - Limit Value.

Test Mode	IEEE 802.11n (HT20)	Tested Date	2023/11/14
Test Frequency	2412MHz	Polarization	Horizontal
Temp	25°C	Hum.	60%

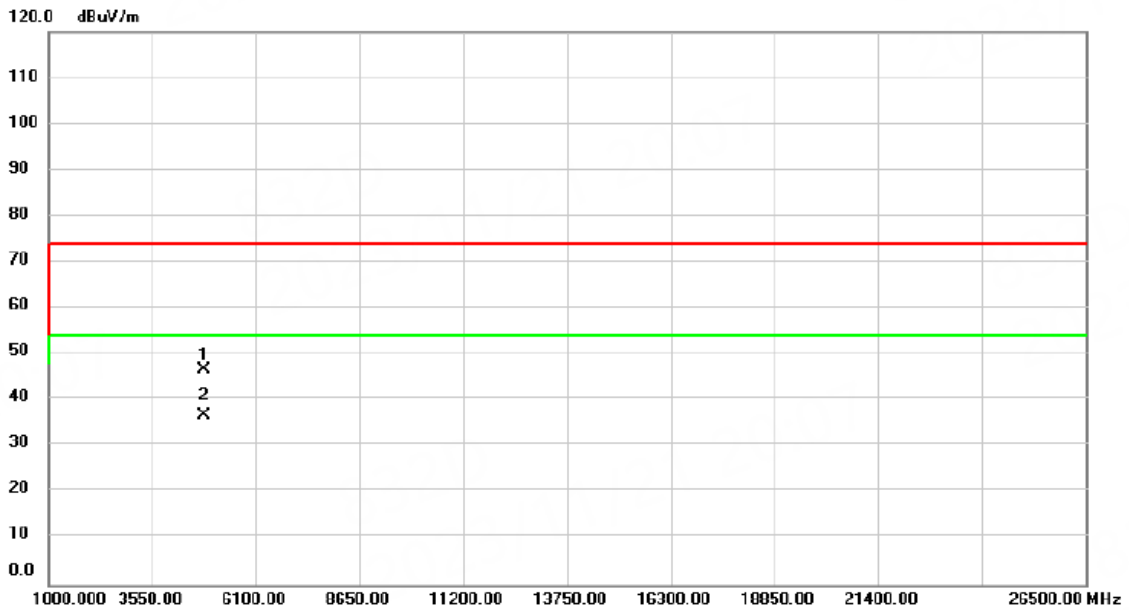

No.	Mk.	Freq. MHz	Reading Level dBuV	Correct Factor dB	Measure- ment dBuV/m	Limit dBuV/m	Margin dB	Detector	Antenna Height cm	Table Degree	Comment
1		4824.000	45.76	0.77	46.53	74.00	-27.47	peak			
2	*	4824.000	36.13	0.77	36.90	54.00	-17.10	AVG			

REMARKS:

- (1) Measurement Value = Reading Level + Correct Factor.
- (2) Margin Level = Measurement Value - Limit Value.

Test Mode	IEEE 802.11n (HT20)	Tested Date	2023/12/25
Test Frequency	2417MHz	Polarization	Vertical
Temp	25°C	Hum.	60%

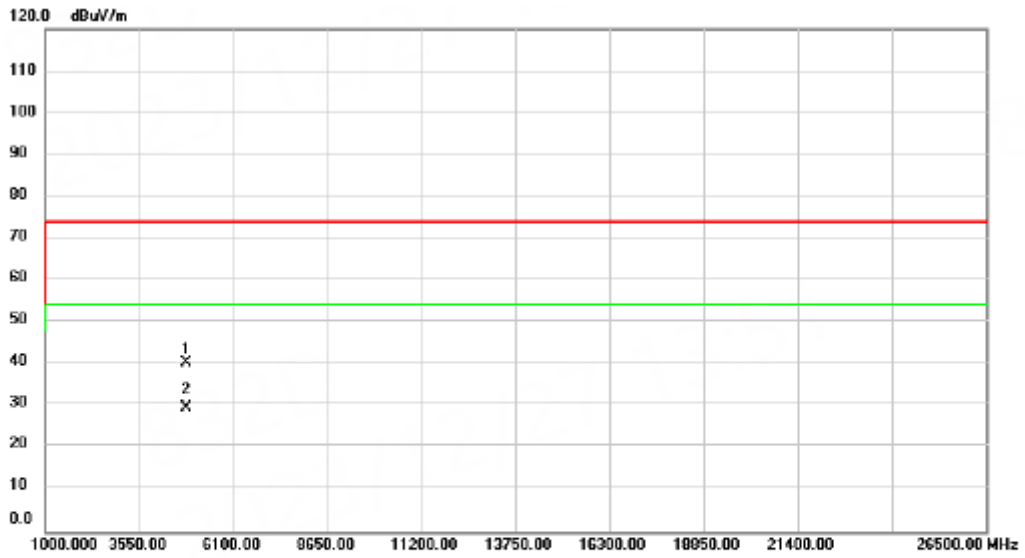

No.	Mk.	Freq.	Reading Level	Correct Factor	Measurement	Limit	Margin	Antenna Height	Table Degree	
		MHz	dBuV	dB	dBuV/m	dBuV/m	dB	cm	degree	Comment
1		4834.000	49.15	-8.80	40.35	74.00	-33.65			peak
2	*	4834.000	38.46	-8.80	29.66	54.00	-24.34			AVG

REMARKS:

- (1) Measurement Value = Reading Level + Correct Factor.
- (2) Margin Level = Measurement Value - Limit Value.

Test Mode	IEEE 802.11n (HT20)	Tested Date	2023/12/25
Test Frequency	2417MHz	Polarization	Horizontal
Temp	25°C	Hum.	60%

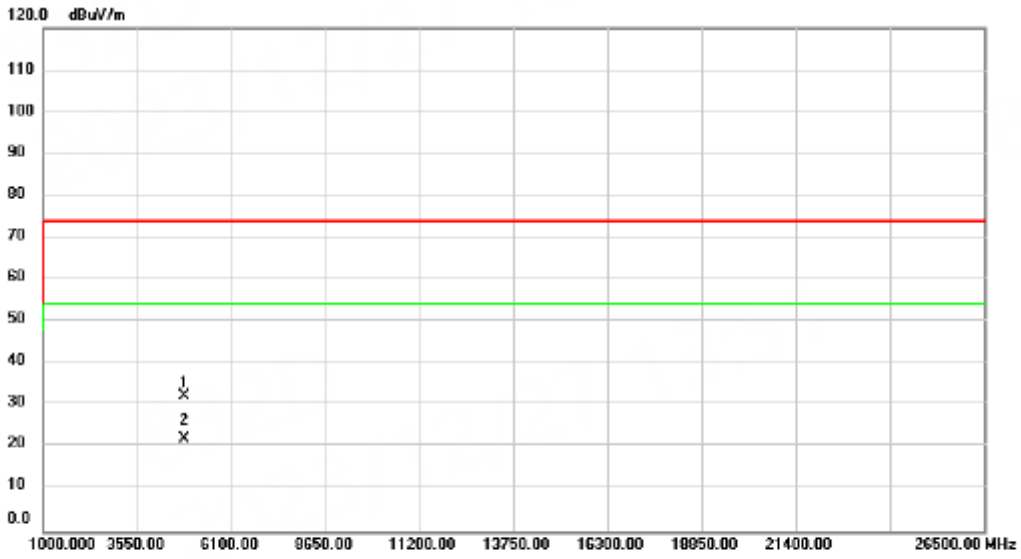

No.	Mk.	Freq.	Reading Level	Correct Factor	Measurement	Limit	Margin	Antenna Height	Table Degree	
		MHz	dBuV	dB	dBuV/m	dBuV/m	dB	cm	degree	Comment
1		4834.000	41.18	-8.80	32.38	74.00	-41.62			peak
2	*	4834.000	30.87	-8.80	22.07	54.00	-31.93			AVG

REMARKS:

- (1) Measurement Value = Reading Level + Correct Factor.
- (2) Margin Level = Measurement Value - Limit Value.

Test Mode	IEEE 802.11n (HT20)	Tested Date	2023/11/14
Test Frequency	2437MHz	Polarization	Vertical
Temp	25°C	Hum.	60%

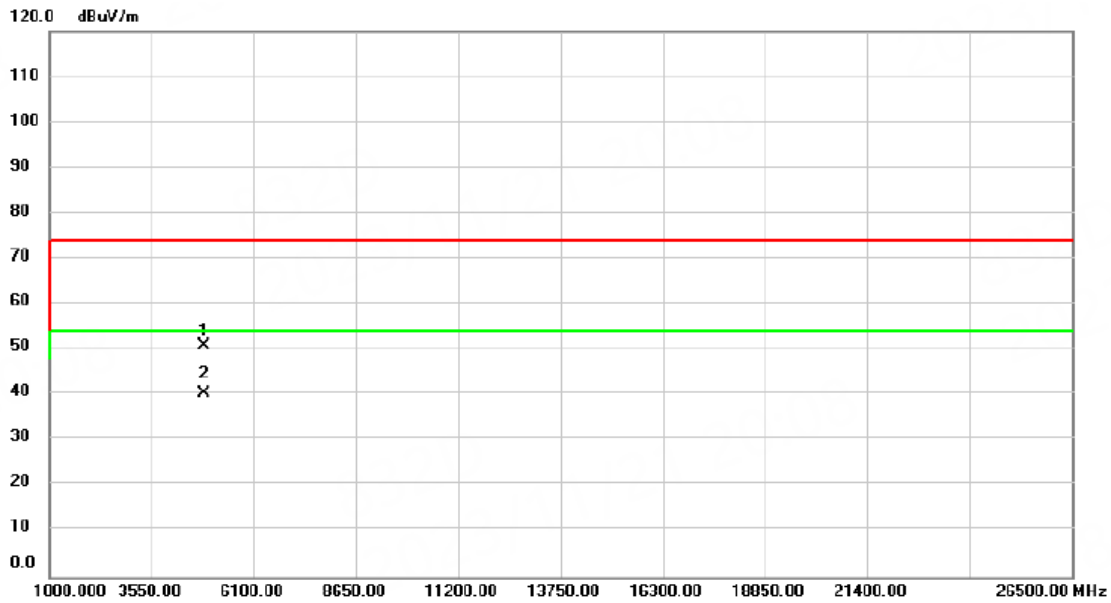

No.	Mk.	Freq. MHz	Reading Level dBuV	Correct Factor dB	Measure- ment dBuV/m	Limit dBuV/m	Margin dB	Detector	Antenna Height cm	Table Degree	Comment
1		4874.000	49.92	0.91	50.83	74.00	-23.17	peak			
2	*	4874.000	39.37	0.91	40.28	54.00	-13.72	AVG			

REMARKS:

- (1) Measurement Value = Reading Level + Correct Factor.
- (2) Margin Level = Measurement Value - Limit Value.

Test Mode	IEEE 802.11n (HT20)	Tested Date	2023/11/14
Test Frequency	2437MHz	Polarization	Horizontal
Temp	25°C	Hum.	60%

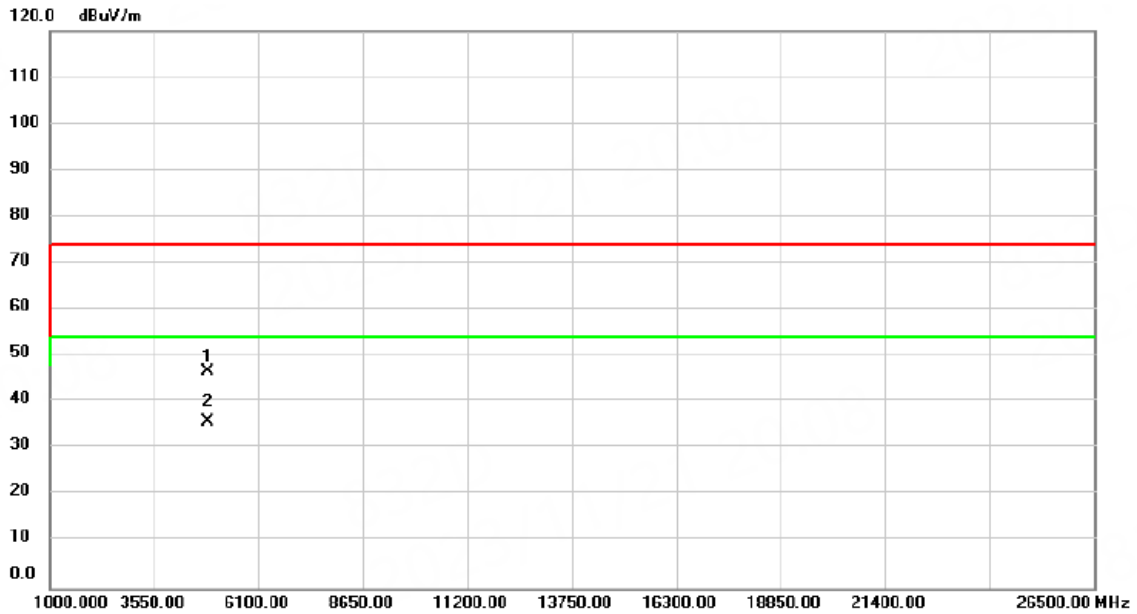

No. Mk.	Freq. MHz	Reading Level dBuV	Correct Factor dB	Measurement dBuV/m	Limit dBuV/m	Margin dB	Detector	Antenna Height cm	Table Degree	Comment
1	4874.000	45.82	0.91	46.73	74.00	-27.27	peak			
2 *	4874.000	35.05	0.91	35.96	54.00	-18.04	AVG			

REMARKS:

- (1) Measurement Value = Reading Level + Correct Factor.
- (2) Margin Level = Measurement Value - Limit Value.

Test Mode	IEEE 802.11n (HT20)	Tested Date	2023/12/25
Test Frequency	2457MHz	Polarization	Vertical
Temp	25°C	Hum.	60%

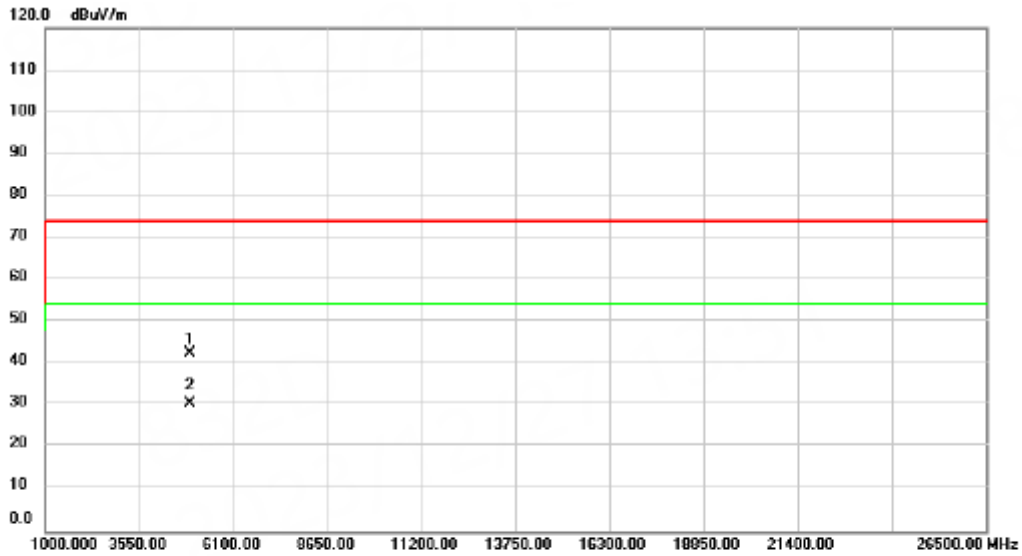

No.	Mk.	Freq.	Reading Level	Correct Factor	Measurement	Limit	Margin	Antenna Height	Table Degree	
		MHz	dBuV	dB	dBuV/m	dBuV/m	dB	cm	degree	Comment
1		4914.000	51.11	-8.55	42.56	74.00	-31.44			peak
2	*	4914.000	38.91	-8.55	30.36	54.00	-23.64			AVG

REMARKS:

- (1) Measurement Value = Reading Level + Correct Factor.
- (2) Margin Level = Measurement Value - Limit Value.

Test Mode	IEEE 802.11n (HT20)	Tested Date	2023/12/25
Test Frequency	2457MHz	Polarization	Horizontal
Temp	25°C	Hum.	60%

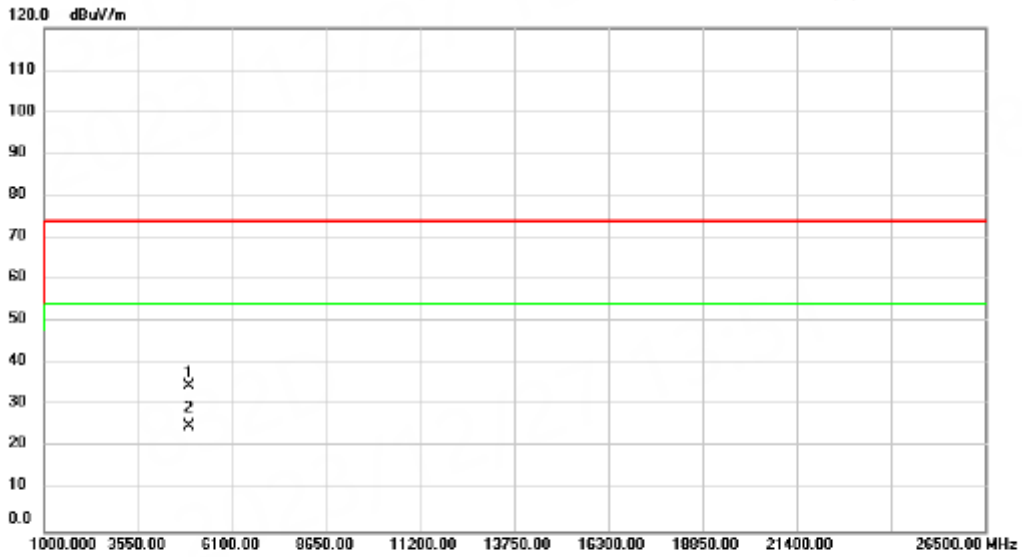

No.	Mk.	Freq.	Reading Level	Correct Factor	Measurement	Limit	Margin	Antenna Height	Table Degree	Comment
		MHz	dBuV	dB	dBuV/m	dBuV/m	dB	cm	degree	
1		4914.000	43.25	-8.55	34.70	74.00	-39.30	peak		
2	*	4914.000	33.57	-8.55	25.02	54.00	-28.98	AVG		

REMARKS:

- (1) Measurement Value = Reading Level + Correct Factor.
- (2) Margin Level = Measurement Value - Limit Value.

Test Mode	IEEE 802.11n (HT20)	Tested Date	2023/11/14
Test Frequency	2462MHz	Polarization	Vertical
Temp	25°C	Hum.	60%

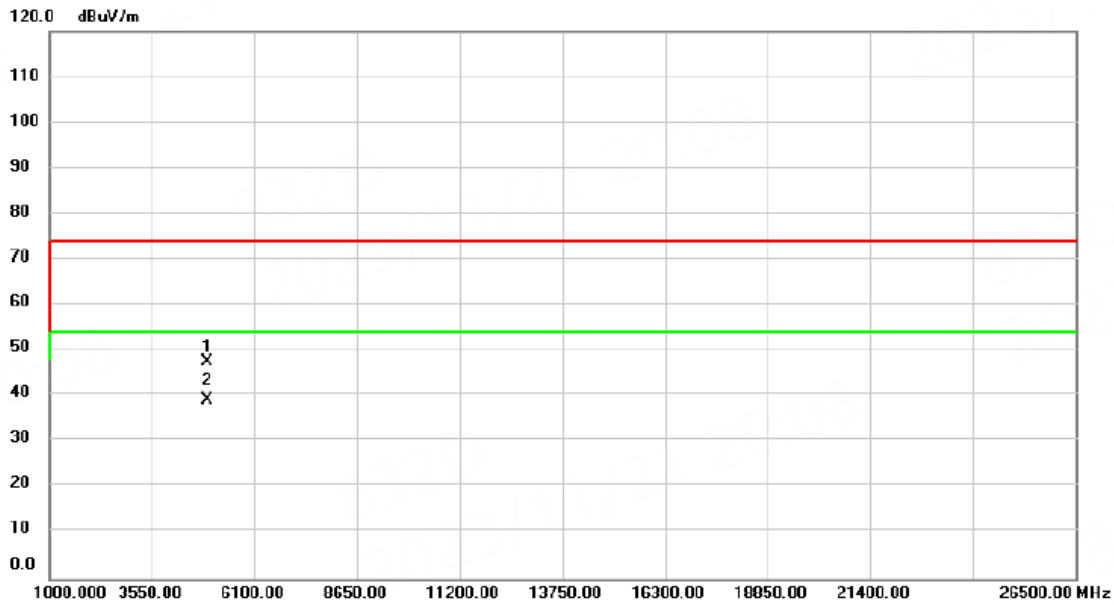

No.	Mk.	Freq. MHz	Reading Level dBuV	Correct Factor dB	Measure- ment dBuV/m	Limit dBuV/m	Margin dB	Detector	Antenna Height cm	Table Degree	Comment
1		4924.000	46.46	1.05	47.51	74.00	-26.49	peak			
2	*	4924.000	37.97	1.05	39.02	54.00	-14.98	AVG			

- (1) Measurement Value = Reading Level + Correct Factor.
- (2) Margin Level = Measurement Value - Limit Value.

Test Mode	IEEE 802.11n (HT20)	Tested Date	2023/11/14
Test Frequency	2462MHz	Polarization	Horizontal
Temp	25°C	Hum.	60%

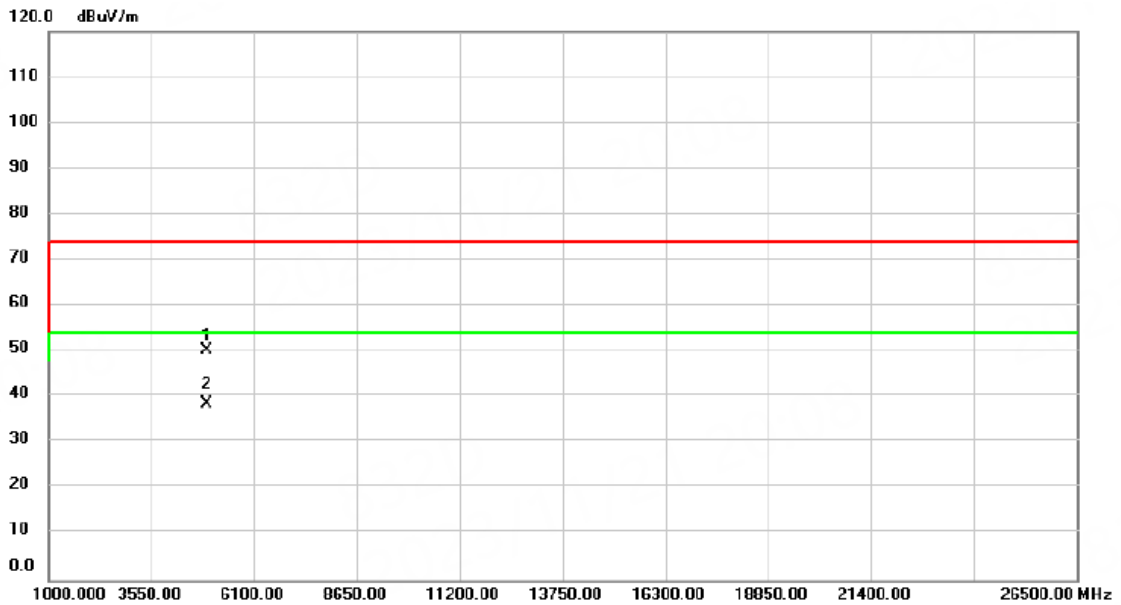

No.	Mk.	Freq. MHz	Reading Level dBuV	Correct Factor dB	Measure- ment dBuV/m	Limit dBuV/m	Margin dB	Detector	Antenna Height cm	Table Degree degree	Comment
1		4924.000	49.14	1.05	50.19	74.00	-23.81	peak			
2	*	4924.000	37.57	1.05	38.62	54.00	-15.38	AVG			

REMARKS:

- (1) Measurement Value = Reading Level + Correct Factor.
- (2) Margin Level = Measurement Value - Limit Value.

APPENDIX D BANDWIDTH

Test Mode	IEEE 802.11b
-----------	--------------

Test Frequency (MHz)	6 dB Bandwidth (MHz)	99 % Occupied Bandwidth (MHz)	Minimum 6 dB Bandwidth Limit (kHz)	Result
2412	10.090	14.88	≥ 500	Pass
2417	7.960	14.24	≥ 500	Pass
2437	9.560	15.20	≥ 500	Pass
2457	9.840	14.88	≥ 500	Pass
2462	9.140	14.80	≥ 500	Pass

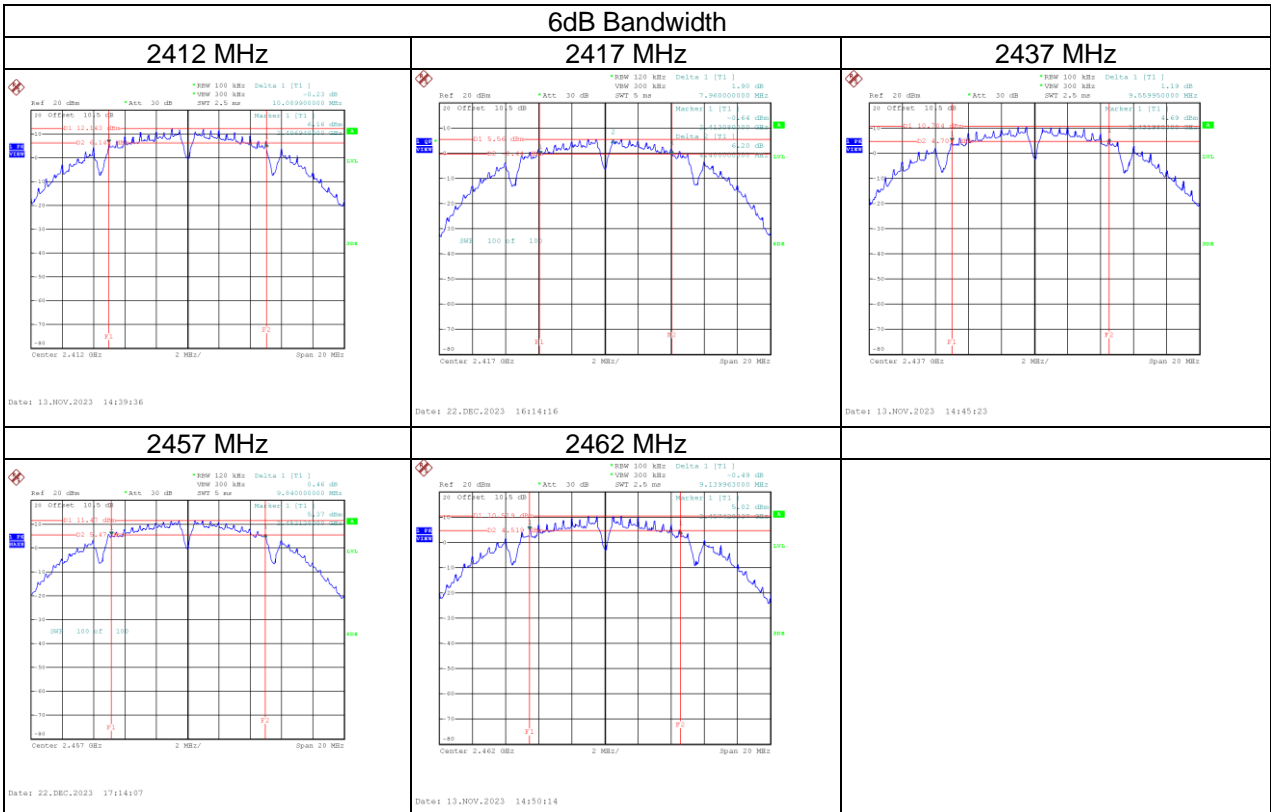

99% Occupied BW

2412 MHz

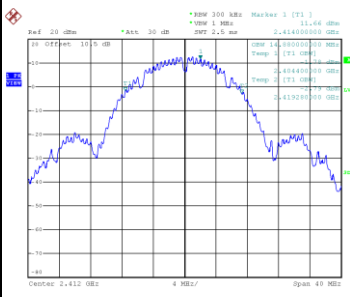

Date: 13.NOV.2023 14:39:45

2417 MHz

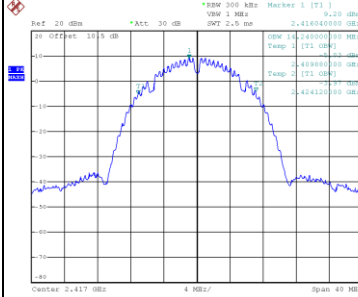

Date: 22.DEC.2023 16:20:13

2437 MHz

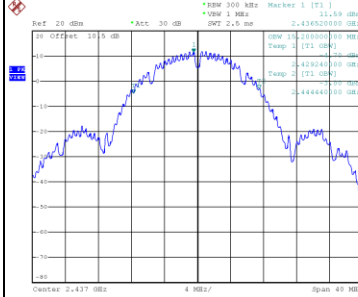

Date: 13.NOV.2023 14:45:32

2457 MHz

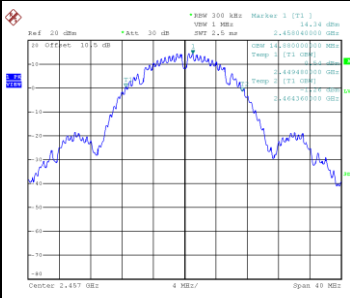

Date: 22.DEC.2023 17:16:44

2462 MHz

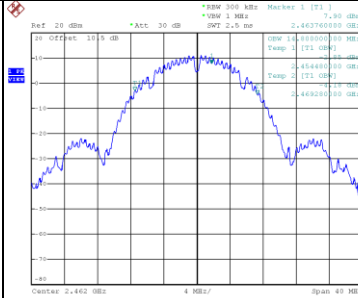

Date: 13.NOV.2023 14:50:23

Test Mode	IEEE 802.11g
-----------	--------------

Test Frequency (MHz)	6 dB Bandwidth (MHz)	99 % Occupied Bandwidth (MHz)	Minimum 6 dB Bandwidth Limit (kHz)	Result
2412	16.380	17.36	≥ 500	Pass
2417	16.600	17.52	≥ 500	Pass
2437	16.390	19.52	≥ 500	Pass
2457	16.560	17.52	≥ 500	Pass
2462	16.420	19.36	≥ 500	Pass

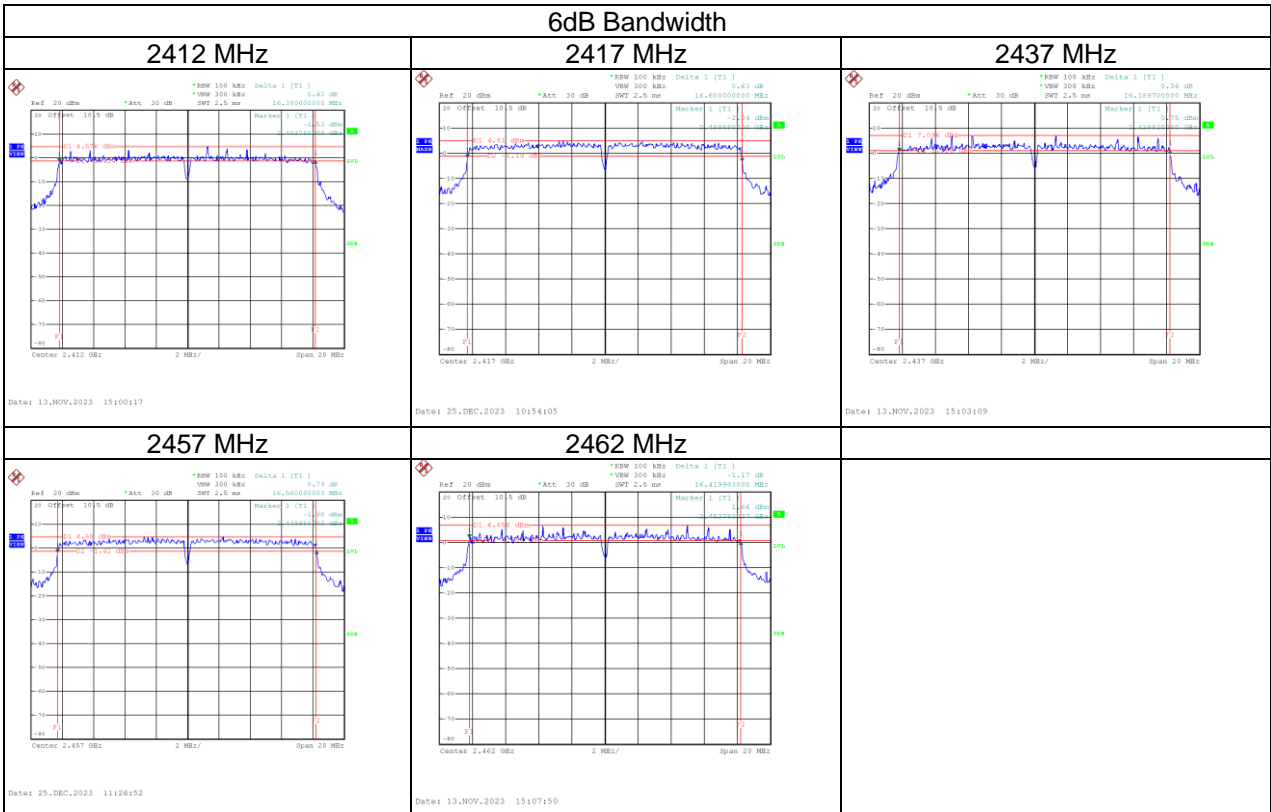

99% Occupied BW

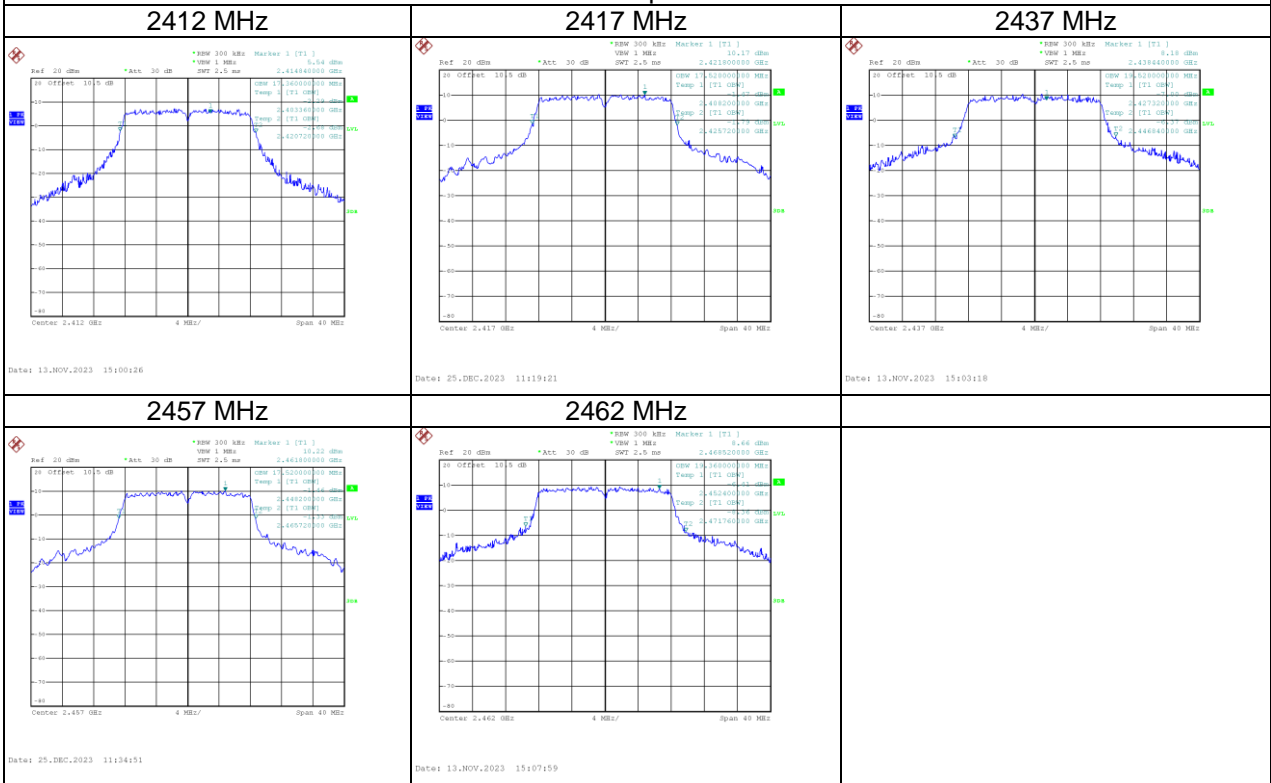

Test Mode	IEEE 802.11n (HT20)
-----------	---------------------

Test Frequency (MHz)	6 dB Bandwidth (MHz)	99 % Occupied Bandwidth (MHz)	Minimum 6 dB Bandwidth Limit (kHz)	Result
2412	17.600	19.28	≥ 500	Pass
2417	17.800	18.40	≥ 500	Pass
2437	17.620	20.24	≥ 500	Pass
2457	17.800	18.96	≥ 500	Pass
2462	17.620	20.40	≥ 500	Pass

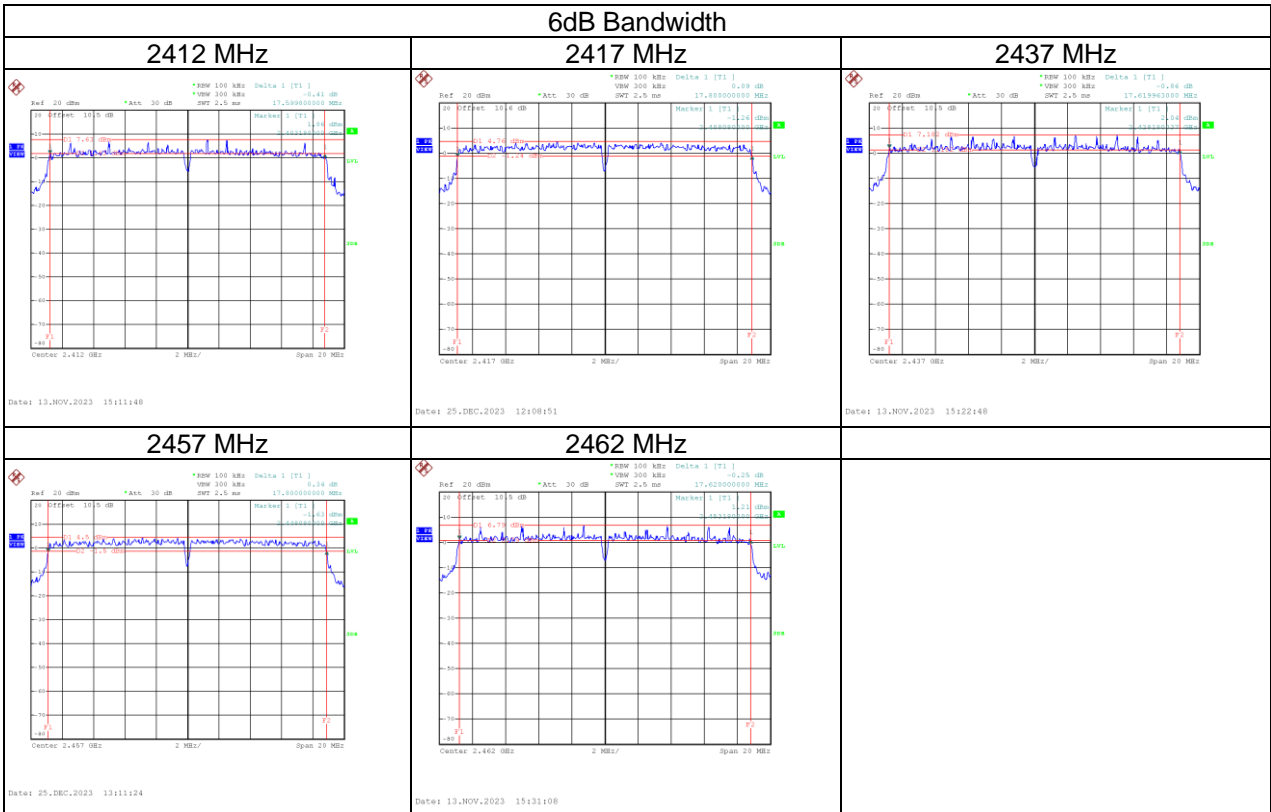

99% Occupied BW

2412 MHz

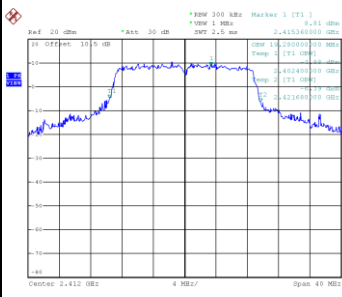

Date: 13.NOV.2023 15:11:57

2417 MHz

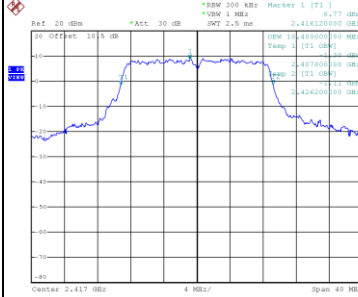

Date: 25.DEC.2023 12:46:19

2437 MHz

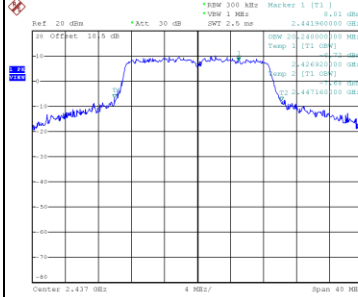

Date: 13.NOV.2023 15:22:57

2457 MHz

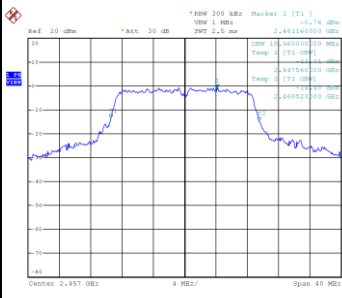

Date: 25.DEC.2023 13:16:06

2462 MHz

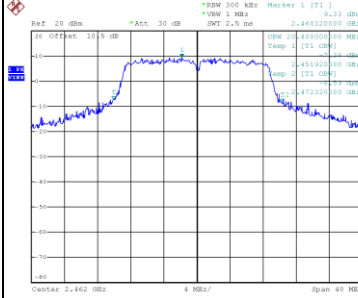

Date: 13.NOV.2023 15:31:17

APPENDIX E OUTPUT POWER

Test Mode	IEEE 802.11b	Tested Date	2023/11/13 2023/12/26
-----------	--------------	-------------	--------------------------

Frequency (MHz)	Conducted Power (dBm)	Conducted Power (W)	Duty Factor	Conducted Power + Duty Factor (dBm)	Conducted Power + Duty Factor (W)	Limit (dBm)	Limit (W)	Result
2412	17.80	0.0603	0.04	17.84	0.0608	30.00	1.0000	Complies
2417	19.34	0.0859	0.04	19.38	0.0867	30.00	1.0000	Complies
2437	18.30	0.0676	0.04	18.34	0.0682	30.00	1.0000	Complies
2457	19.87	0.0971	0.04	19.91	0.0979	30.00	1.0000	Complies
2462	18.66	0.0735	0.04	18.70	0.0741	30.00	1.0000	Complies

Test Mode	IEEE 802.11g	Tested Date	2023/11/13 2023/12/26
-----------	--------------	-------------	--------------------------

Frequency (MHz)	Conducted Power (dBm)	Conducted Power (W)	Duty Factor	Conducted Power + Duty Factor (dBm)	Conducted Power + Duty Factor (W)	Limit (dBm)	Limit (W)	Result
2412	17.43	0.0553	0.26	17.69	0.0587	30.00	1.0000	Complies
2417	18.61	0.0726	0.26	18.87	0.0771	30.00	1.0000	Complies
2437	19.70	0.0933	0.26	19.96	0.0991	30.00	1.0000	Complies
2457	19.45	0.0881	0.26	19.71	0.0935	30.00	1.0000	Complies
2462	17.95	0.0624	0.26	18.21	0.0662	30.00	1.0000	Complies

Test Mode	IEEE 802.11n (HT20)	Tested Date	2023/11/13 2023/12/26
-----------	---------------------	-------------	--------------------------

Frequency (MHz)	Conducted Power (dBm)	Conducted Power (W)	Duty Factor	Conducted Power + Duty Factor (dBm)	Conducted Power + Duty Factor (W)	Limit (dBm)	Limit (W)	Result
2412	17.04	0.0506	0.28	17.32	0.0540	30.00	1.0000	Complies
2417	18.74	0.0748	0.28	19.02	0.0798	30.00	1.0000	Complies
2437	19.64	0.0920	0.28	19.92	0.0982	30.00	1.0000	Complies
2457	19.24	0.0839	0.28	19.52	0.0895	30.00	1.0000	Complies
2462	17.51	0.0564	0.28	17.79	0.0601	30.00	1.0000	Complies

APPENDIX F POWER SPECTRAL DENSITY

Test Mode	IEEE 802.11b
-----------	--------------

Test Frequency (MHz)	Power Spectral Density (dBm/3kHz)	Maximum Limit (dBm/3kHz)	Result
2412	-3.94	8	Pass
2417	-13.15	8	Pass
2437	-2.45	8	Pass
2457	-7.98	8	Pass
2462	-0.53	8	Pass

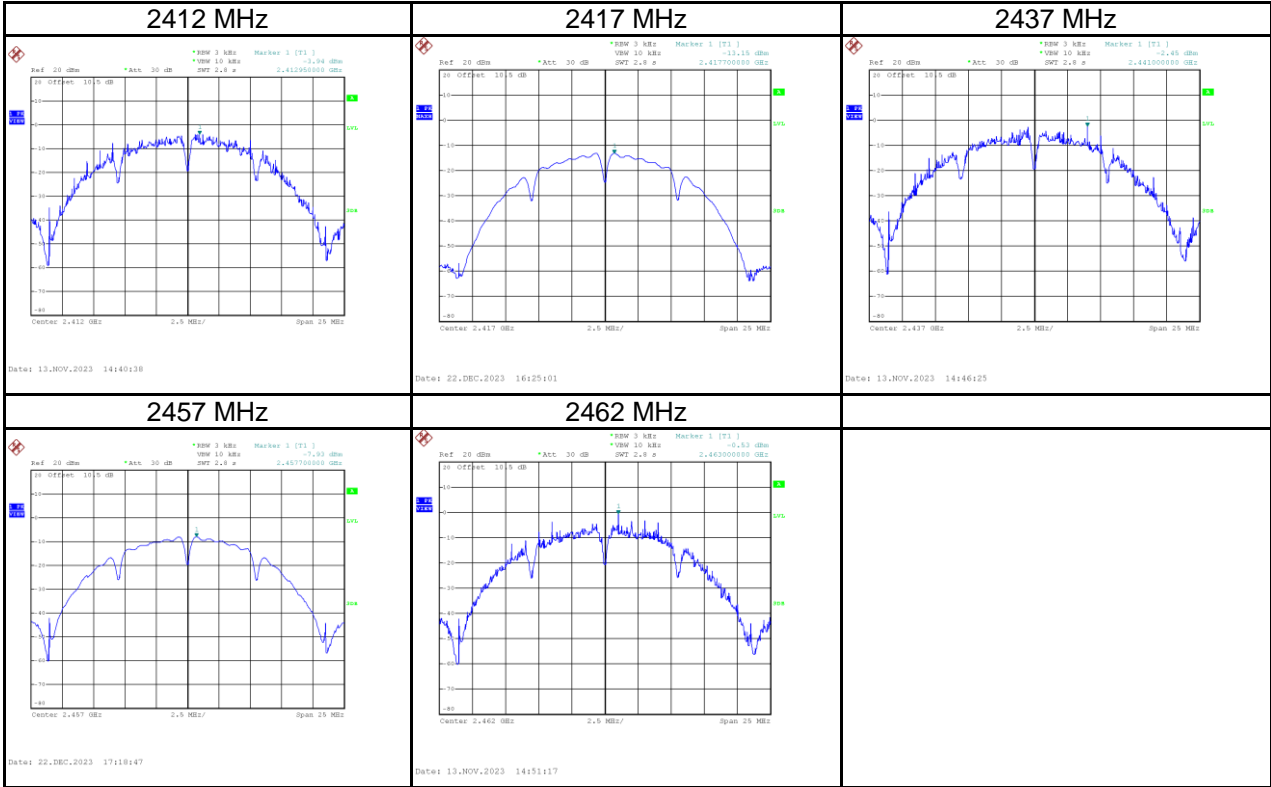

Test Mode	IEEE 802.11g
-----------	--------------

Test Frequency (MHz)	Power Spectral Density (dBm/3kHz)	Maximum Limit (dBm/3kHz)	Result
2412	-10.83	8	Pass
2417	-9.88	8	Pass
2437	-8.12	8	Pass
2457	-10.44	8	Pass
2462	-7.55	8	Pass

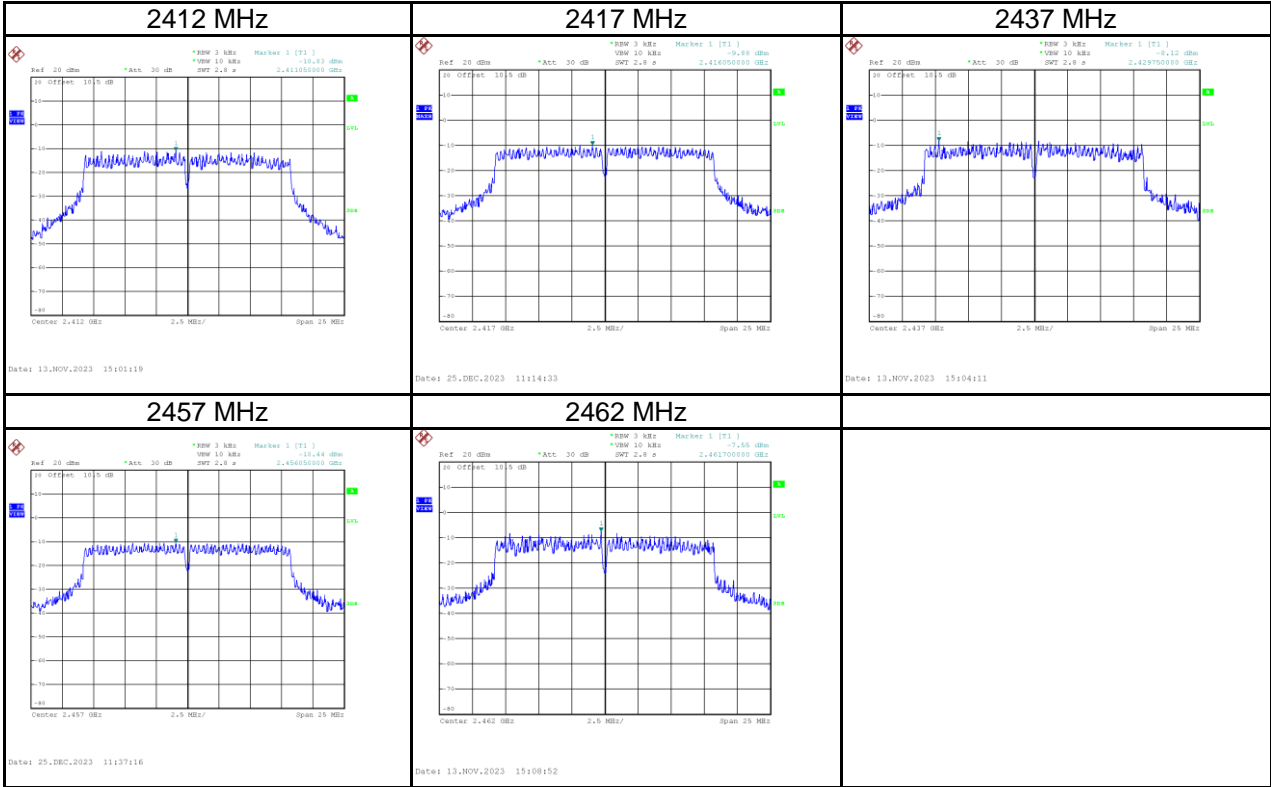

Test Mode	IEEE 802.11n (HT20)
-----------	---------------------

Test Frequency (MHz)	Power Spectral Density (dBm/3kHz)	Maximum Limit (dBm/3kHz)	Result
2412	-8.13	8	Pass
2417	-9.89	8	Pass
2437	-7.16	8	Pass
2457	-9.88	8	Pass
2462	-7.88	8	Pass

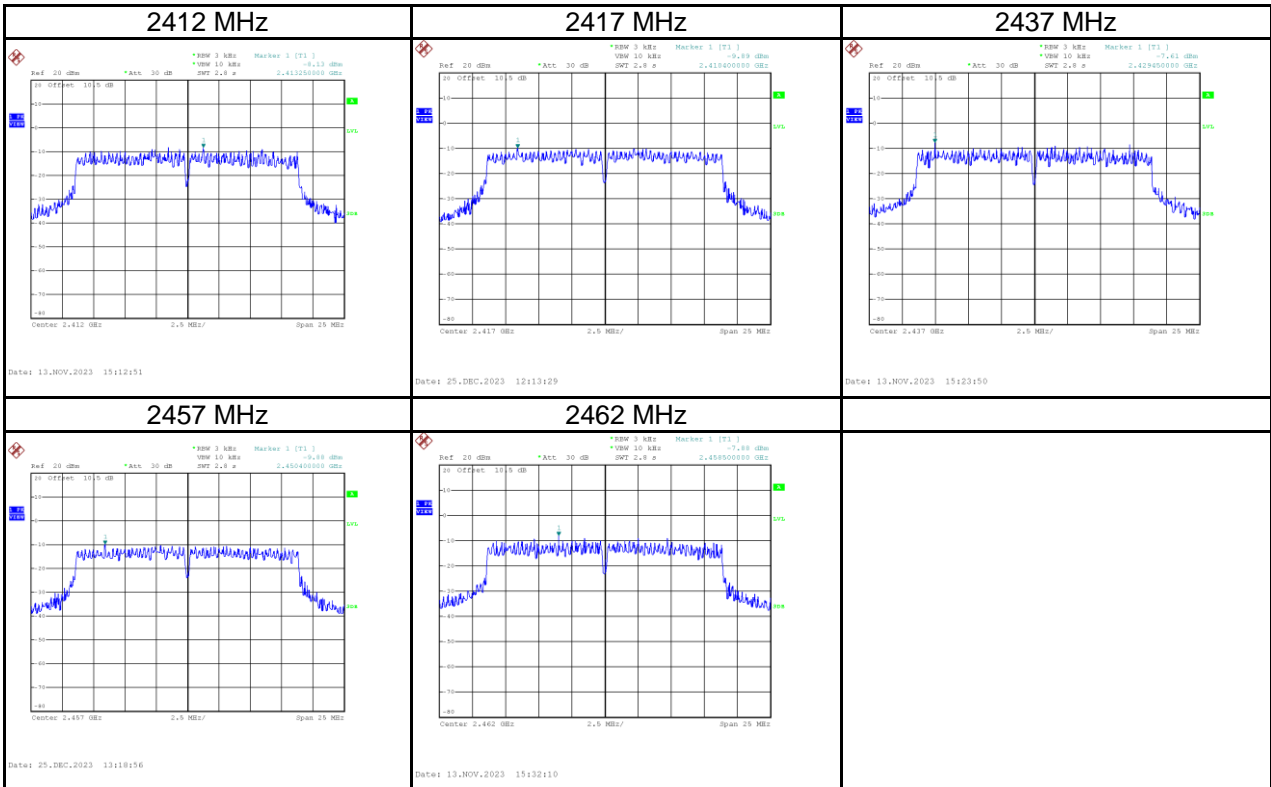

APPENDIX G ANTENNA CONDUCTED SPURIOUS EMISSIONS

Test Mode | IEEE 802.11b

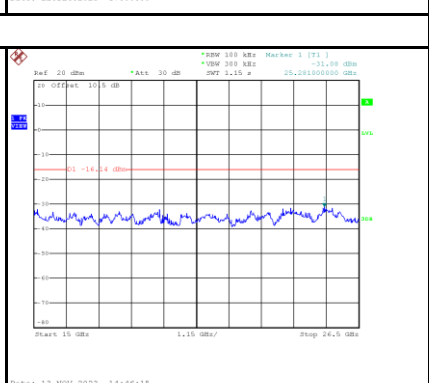
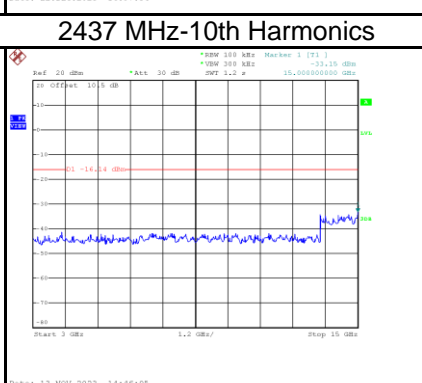
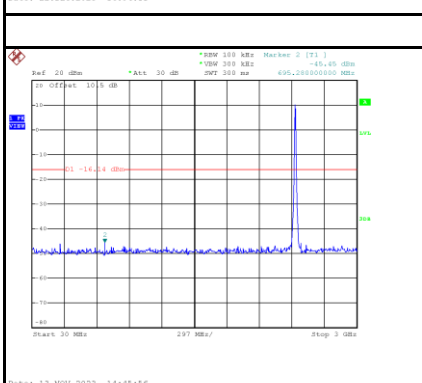
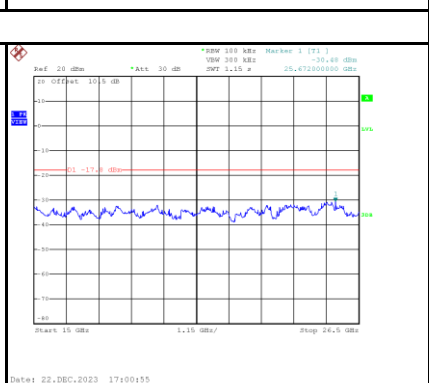
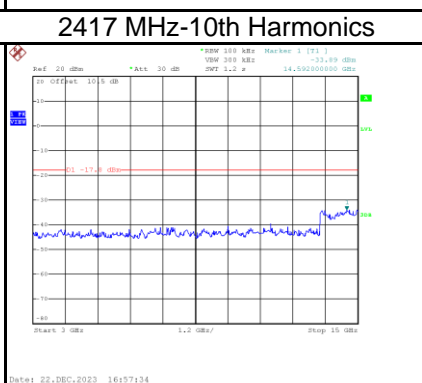
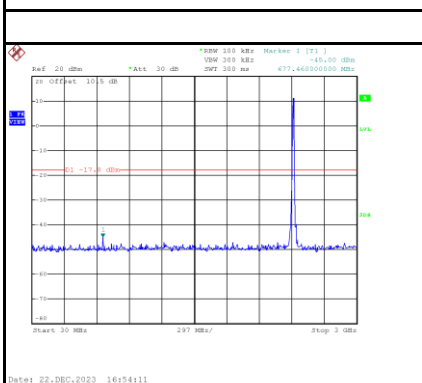
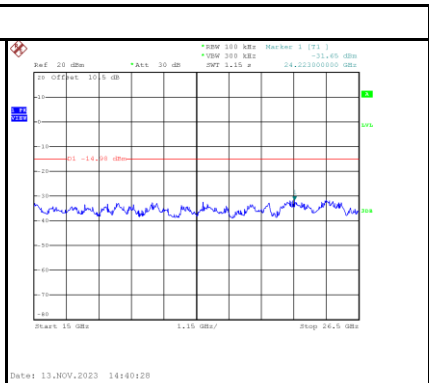
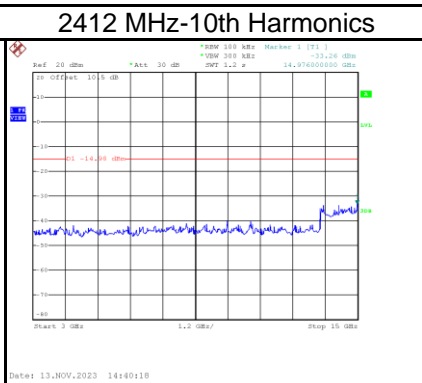
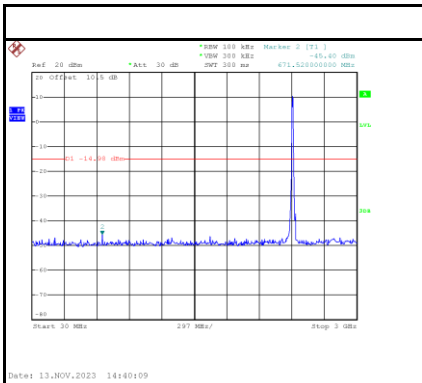
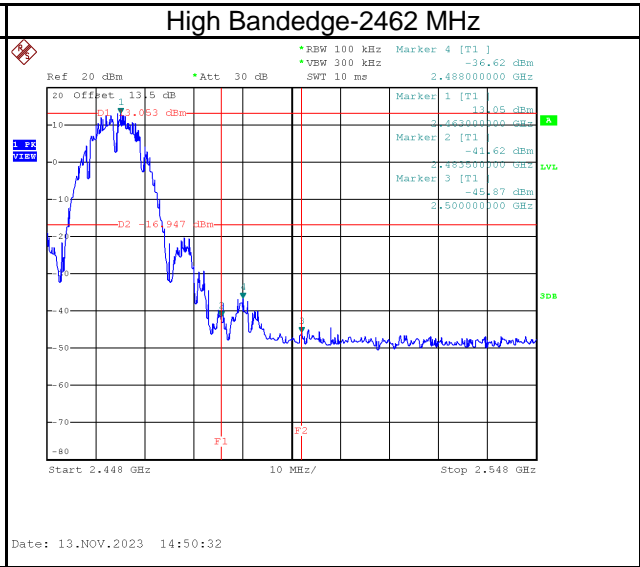
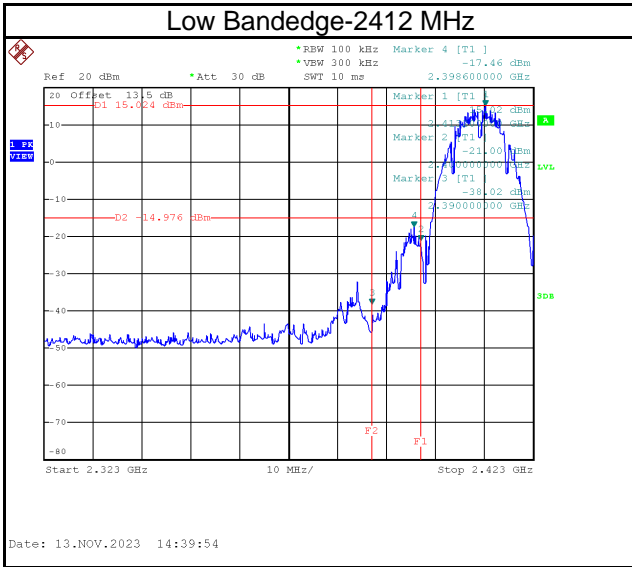

2457 MHz-10th Harmonics

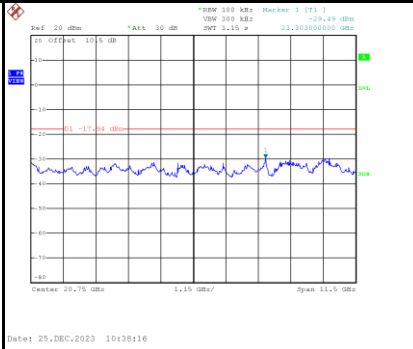
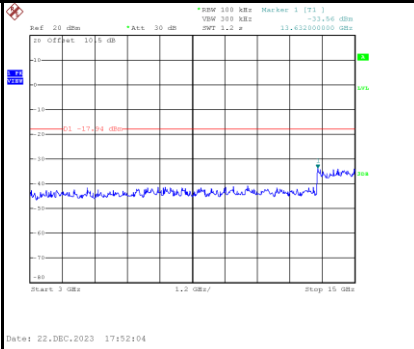
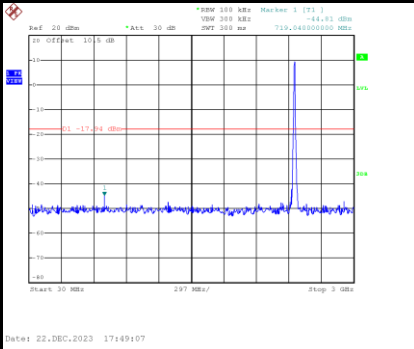

2462 MHz-10th Harmonics

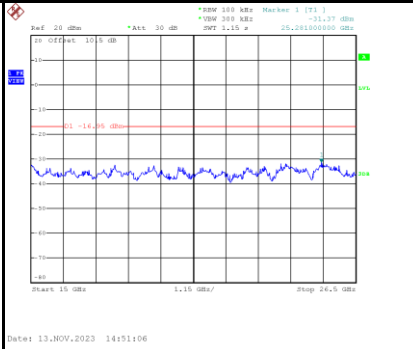
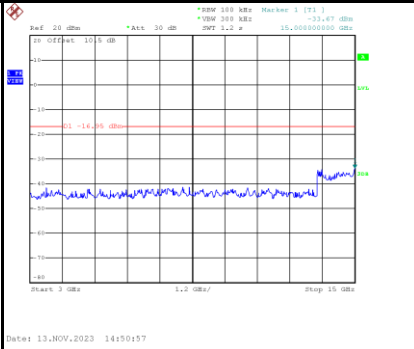
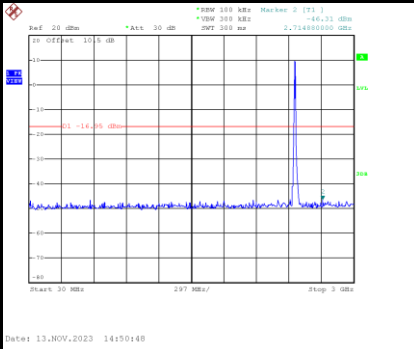

Test Mode | IEEE 802.11g

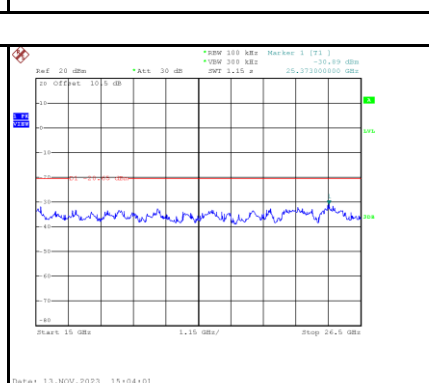
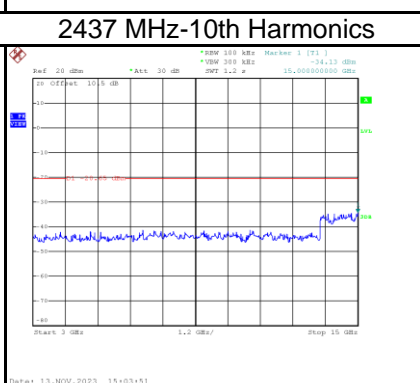
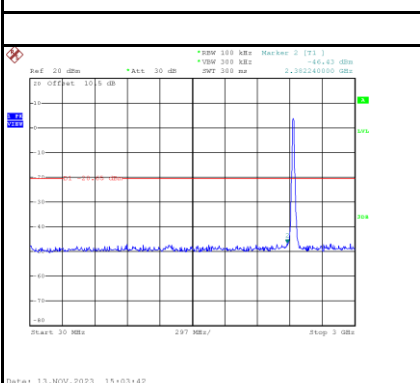
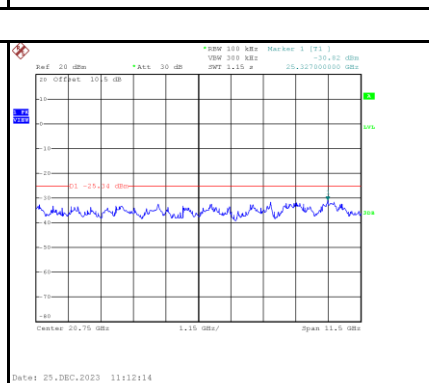
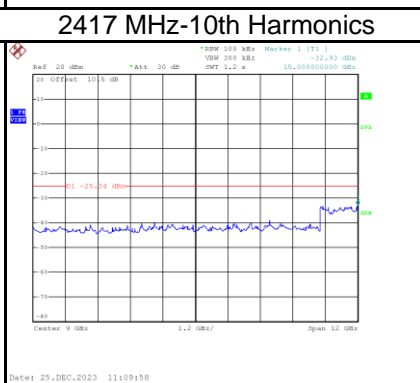
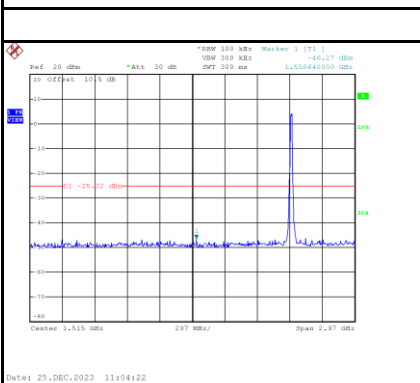
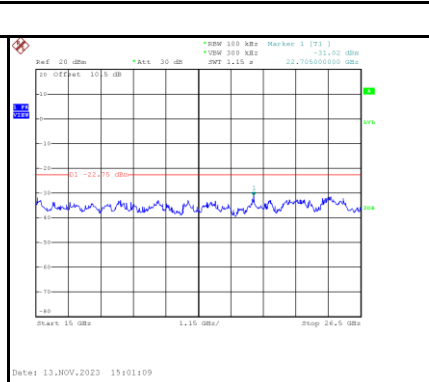
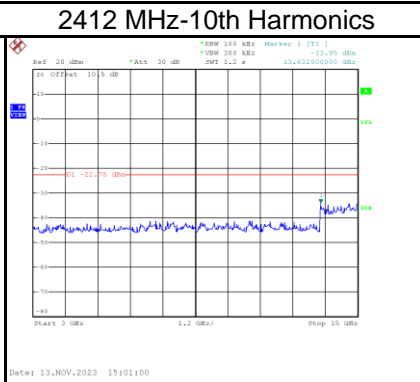
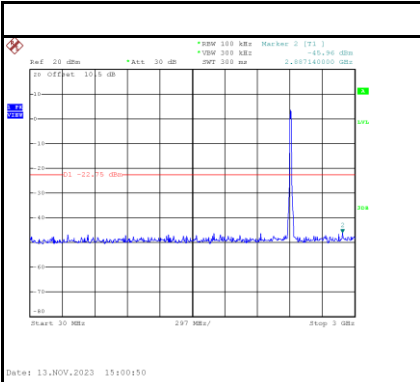
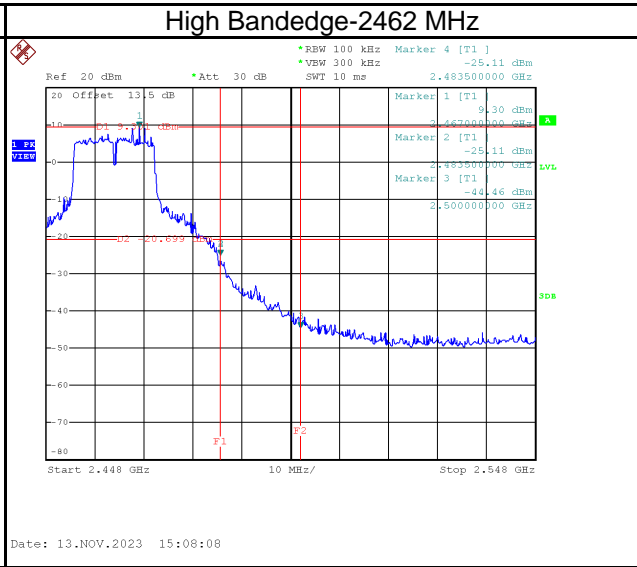
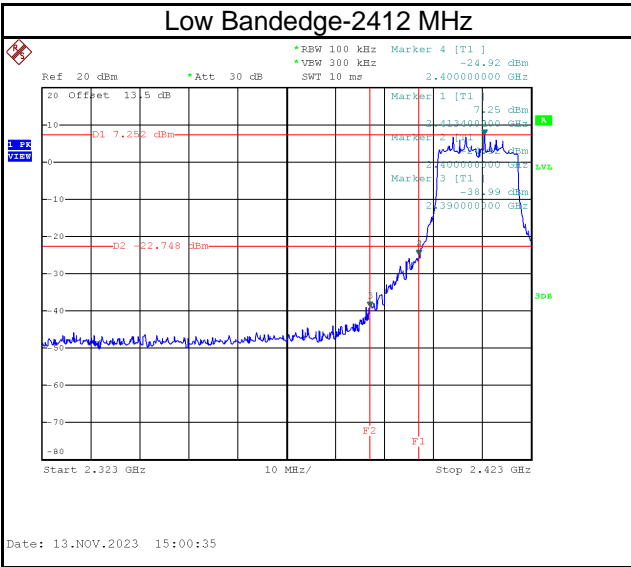

2457 MHz-10th Harmonics

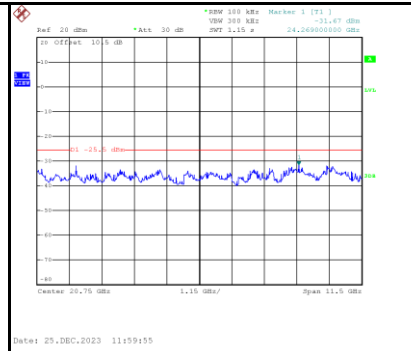
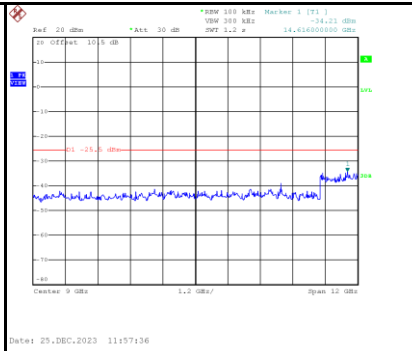
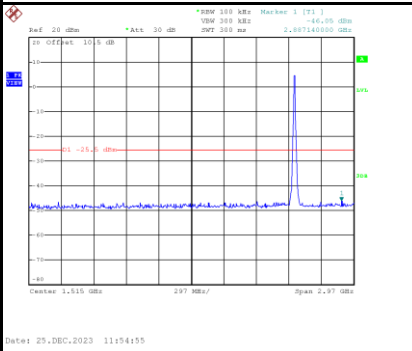

2462 MHz-10th Harmonics

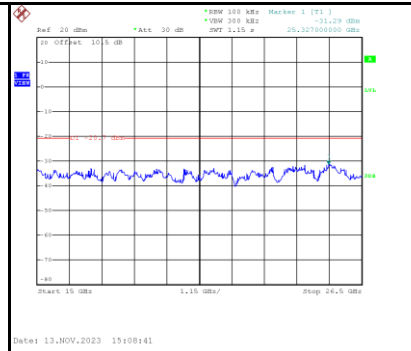
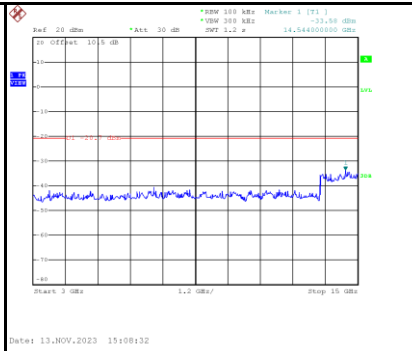
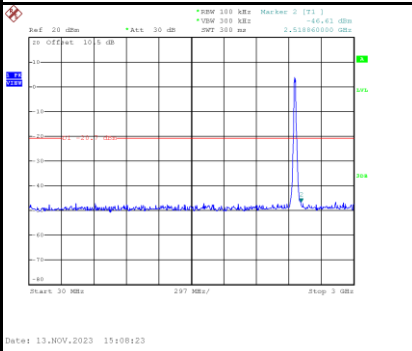

Test Mode | IEEE 802.11n (HT20)

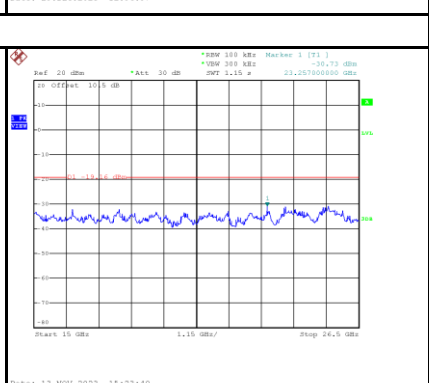
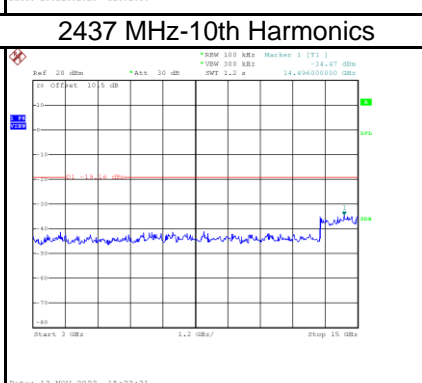
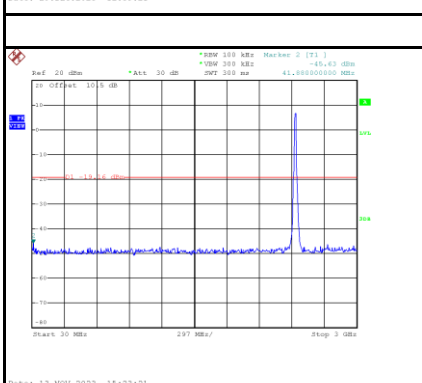
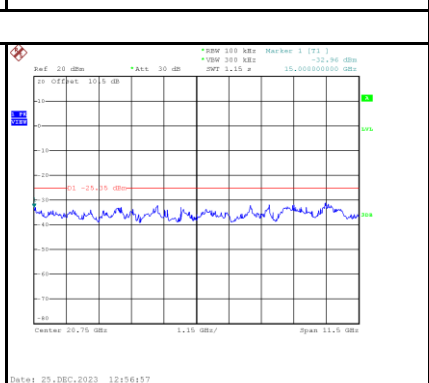
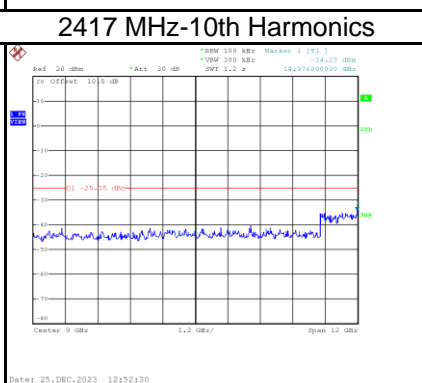
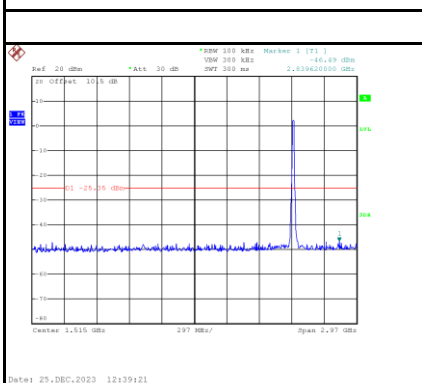
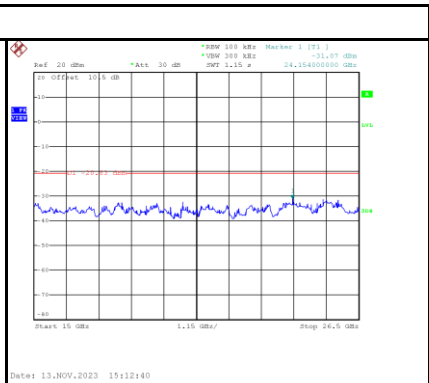
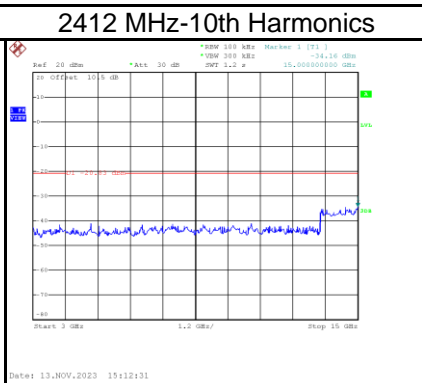
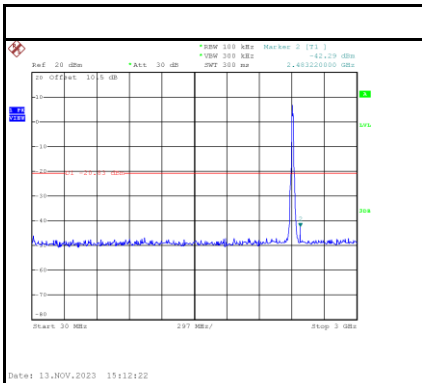
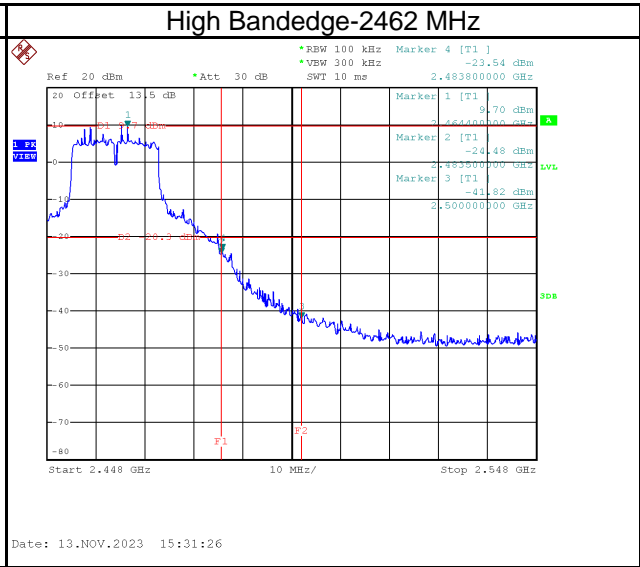
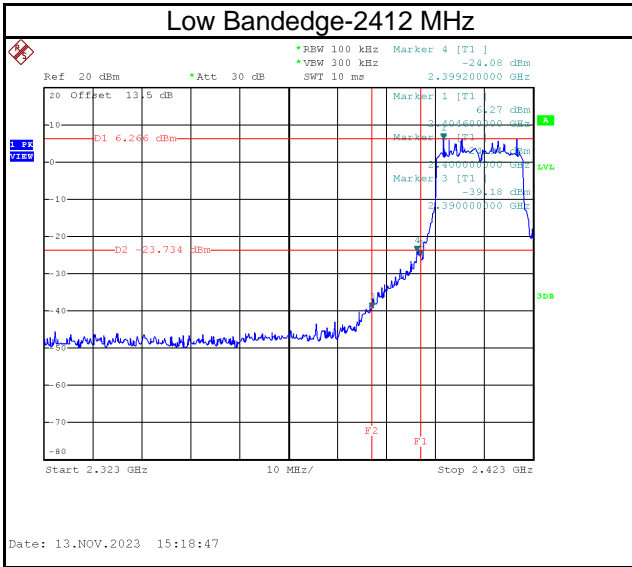

2457 MHz-10th Harmonics

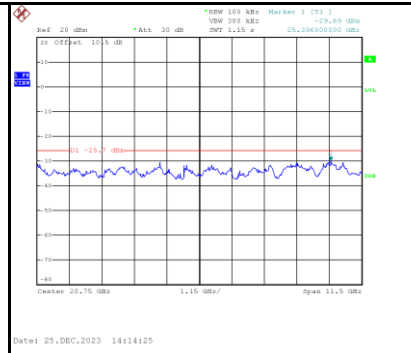
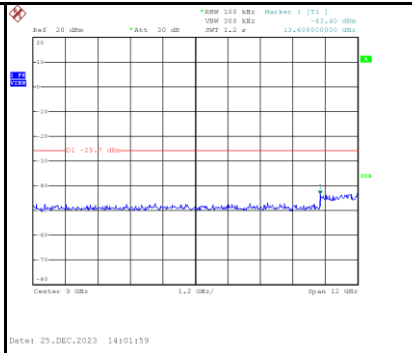
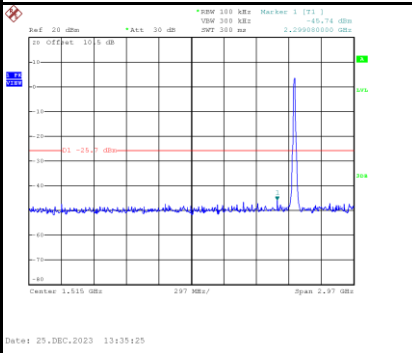

2462 MHz-10th Harmonics

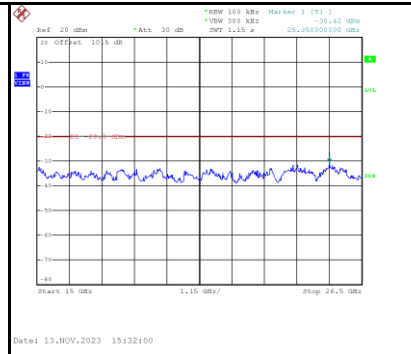
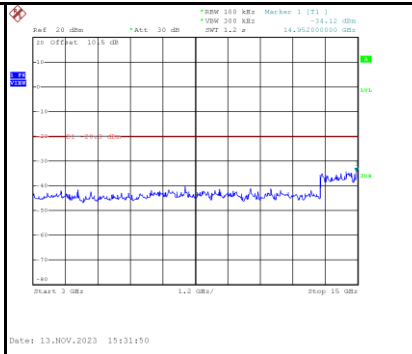
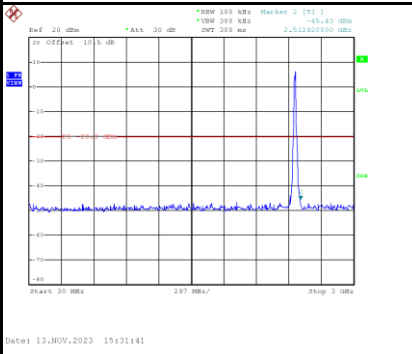

End of Test Report