

FCC Radio Test Report

FCC ID: 2BCGWGXE75

Report No. : BTL-FCCP-4-2402G042
Equipment : AXE5400 Tri-Band Wi-Fi 6E Gaming Router
Model Name : Archer GXE75
Brand Name : tp-link
Applicant : TP-LINK CORPORATION PTE. LTD.
Address : 7 Temasek Boulevard #29-03 Suntec Tower One, Singapore 038987

Radio Function : RLAN 5 GHz (U-NII 2A, U-NII 2C)

FCC Rule Part(s) : FCC CFR Title 47, Part 15, Subpart E (15.407)
(Only DFS)

Date of Receipt : 2024/2/21
Date of Test : 2024/5/7 ~ 2024/7/4
Issued Date : 2024/7/23

The above equipment has been tested and found in compliance with the requirement of the above standards by BTL Inc.

Prepared by : 
Eddie Lee, Engineer

Approved by : 
Jerry Chuang, Supervisor

**BTL Inc.**

No.18, Ln. 171, Sec. 2, Jiuzong Rd., Neihu Dist., Taipei City 114, Taiwan

Tel: +886-2-2657-3299 Fax: +886-2-2657-3331 Web: www.newbtl.com Service mail: btl_qa@newbtl.com

Declaration

BTL represents to the client that testing is done in accordance with standard procedures as applicable and that test instruments used has been calibrated with standards traceable to international standard(s) and/or national standard(s).

BTL's reports apply only to the specific samples tested under conditions. It is manufacture's responsibility to ensure that additional production units of this model are manufactured with the identical electrical and mechanical components. **BTL** assumes no responsibility for the data provided by the Customer, any statements, inferences or generalizations drawn by the customer or others from the reports issued by **BTL**.

This report is the confidential property of the client. As a mutual protection to the clients, the public and ourselves, the test report shall not be reproduced, except in full, without our written approval.

BTL's laboratory quality assurance procedures are in compliance with the **ISO/IEC 17025** requirements, and accredited by the conformity assessment authorities listed in this test report.

BTL is not responsible for the sampling stage, so the results only apply to the sample as received.

The information, data and test plan are provided by manufacturer which may affect the validity of results, so it is manufacturer's responsibility to ensure that the apparatus meets the essential requirements of applied standards and in all the possible configurations as representative of its intended use.

Limitation

For the use of the authority's logo is limited unless the Test Standard(s)/Scope(s)/Item(s) mentioned in this test report is (are) included in the conformity assessment authorities acceptance respective.

Please note that the measurement uncertainty is provided for informational purpose only and are not use in determining the Pass/Fail results.

CONTENTS

REVISION HISTORY	4
1 SUMMARY OF TEST RESULTS	5
1.1 REFERENCE TEST GUIDANCE	5
1.2 TEST FACILITY	5
1.3 TEST ENVIRONMENT CONDITIONS	5
2 EUT INFORMATION	6
2.1 EUT SPECIFICATION TABLE	6
2.2 EIRP POWER	8
3 U-NII DFS RULE REQUIREMENTS	9
3.1 WORKING MODES AND REQUIRED TEST ITEMS	9
3.2 TEST LIMITS AND RADAR SIGNAL PARAMETERS	10
4 DYNAMIC FREQUENCY SELECTION (DFS) TEST	14
4.1 DFS MEASUREMENT SYSTEM	14
4.2 CALIBRATION OF DFS DETECTION THRESHOLD LEVEL	17
4.3 DEVIATION FROM TEST STANDARD	17
5 LIST OF MEASURING EQUIPMENTS	18
6 EUT TEST PHOTO	18
7 EUT PHOTOS	18
8 TEST RESULTS	19
8.1 SUMMARY OF TEST RESULT	19
8.2 DFS DETECTION THRESHOLD	20
8.3 RADAR TEST WAVEFORMS	24
8.4 CHANNEL AVAILABILITY CHECK TIME	209
8.5 CHANNEL MOVE TIME AND CHANNEL CLOSING TRANSMISSION TIME	215
8.6 PROBABILITY OF SUCCEED	219
8.7 NON-OCCUPANCY PERIOD	221
8.8 U-NII DETECTION BANDWIDTH	223

REVISION HISTORY

Report No.	Version	Description	Issued Date	Note
BTL-FCCP-4-2402G042	R00	Original Report.	2024/7/23	Valid

1 SUMMARY OF TEST RESULTS

Test procedures according to the technical standards.

Standard(s) Section	Description	Test Result	Judgement	Remark
15.407(h)	Dynamic Frequency Selection (DFS)	-----	Pass	-----

NOTE:

(1) The report format version is TP.1.1.1.

1.1 REFERENCE TEST GUIDANCE

FCC KDB 789033 D02 General UNII Test Procedures New Rules v02r01
 FCC KDB 905462 D02 UNII DFS Compliance Procedures New Rules v02

1.2 TEST FACILITY

The test locations stated below are under the TAF Accreditation Number 0659.

The test location(s) used to collect the test data in this report are:

No. 68-1, Ln. 169, Sec. 2, Datong Rd., Xizhi Dist., New Taipei City 221, Taiwan
 (FCC DN: TW0659)

C05
 CB08
 CB11
 SR10
 SR11

1.3 TEST ENVIRONMENT CONDITIONS

Test Item	Environment Condition	Test Voltage	Tested by
Dynamic Frequency Selection (DFS)	23.4 °C, 53 %	AC 120V	Cora Lin

2 EUT INFORMATION

2.1 EUT SPECIFICATION TABLE

Equipment	AXE5400 Tri-Band Wi-Fi 6E Gaming Router
Model Name	Archer GXE75
Brand Name	tp-link
Model Difference	N/A
Power Source	DC voltage supplied from AC Adapter.
Power Rating	I/P: 100-240V~, 50/60Hz, 0.8A O/P: 12.0V --- 2.5A
Products Covered	1 * Adapter: MASS POWER / NBS30D120250VU 1 * LAN Cable
Operational Mode	<input checked="" type="checkbox"/> Master <input type="checkbox"/> Slave with radar detection <input type="checkbox"/> Slave without radar detection
Operation Band	UNII-2A: 5250 MHz to 5350 MHz UNII-2C: 5470 MHz to 5725 MHz
Operating Frequency	UNII-2A: 5250 MHz to 5320 MHz UNII-2C: 5500 MHz to 5720 MHz
Modulation	OFDM, OFDMA
Test Model	Archer GXE75
Sample Status	Engineering Sample
EUT Modification(s)	N/A

NOTE:

(1) The above EUT information is declared by manufacturer and for more detailed features description, please refers to the manufacturer's specifications or user's manual.

(2) Channel List:

IEEE 802.11a IEEE 802.11n (HT20) IEEE 802.11ac (VHT20) IEEE 802.11ax (HE20)		IEEE 802.11n (HT40) IEEE 802.11ac (VHT40) IEEE 802.11ax (HE40)		IEEE 802.11ac (VHT80) IEEE 802.11ax (HE80)	
UNII-2A		UNII-2A		UNII-2A	
Channel	Frequency (MHz)	Channel	Frequency (MHz)	Channel	Frequency (MHz)
52	5260	54	5270	58	5290
56	5280	62	5310		
60	5300				
64	5320				

IEEE 802.11a IEEE 802.11n (HT20) IEEE 802.11ac (VHT20) IEEE 802.11ax (HE20)		IEEE 802.11n (HT40) IEEE 802.11ac (VHT40) IEEE 802.11ax (HE40)		IEEE 802.11ac (VHT80) IEEE 802.11ax (HE80)	
UNII-2C		UNII-2C		UNII-2C	
Channel	Frequency (MHz)	Channel	Frequency (MHz)	Channel	Frequency (MHz)
100	5500	102	5510	106	5530
104	5520	110	5550	122	5610
108	5540	118	5590	138	5690
112	5560	126	5630		
116	5580	134	5670		
120	5600	142	5710		
124	5620				
128	5640				
132	5660				
136	5680				
140	5700				
144	5720				

802.11ac (VHT160) 802.11ax (HE160)	
Channel	Frequency (MHz)
114	5570

(3) Table for Filed Antenna:

Ant	Manufacturer	Product Model	Antenna Type	Connector	Frequency (MHz)	Gain (dBi)
3	TP-LINK CORPORATION PTE. LTD.	Archer GXE75	Dipole	I-PEX	5150~5250	2.82
					5250~5350	2.82
					5470~5725	2.94
					5725~5850	3.06
4	TP-LINK CORPORATION PTE. LTD.	Archer GXE75	Dipole	I-PEX	5150~5250	2.84
					5250~5350	2.84
					5470~5725	2.88
					5725~5850	3.04

(4) The above Antenna information are derived from the antenna data sheet provided by manufacturer and for more detailed features description, please refer to the manufacturer's specifications, the laboratory shall not be held responsible.

(5) Operating Mode and Antenna Configuration

TX Mode	Operating Mode	2TX
	IEEE 802.11a	V (Ant 3+Ant 4)
	IEEE 802.11ac (VHT20)	V (Ant 3+Ant 4)
	IEEE 802.11ac (VHT40)	V (Ant 3+Ant 4)
	IEEE 802.11ac (VHT80)	V (Ant 3+Ant 4)
	IEEE 802.11ac (VHT160)	V (Ant 3+Ant 4)
	IEEE 802.11ax (HE20)	V (Ant 3+Ant 4)
	IEEE 802.11ax (HE40)	V (Ant 3+Ant 4)
	IEEE 802.11ax (HE80)	V (Ant 3+Ant 4)
	IEEE 802.11ax (HE160)	V (Ant 3+Ant 4)

2.2 EIRP POWER

Test Mode	UNII-2C
-----------	---------

Frequency (MHz)	Maximum Conducted Power (dBm)	Antenna Gain (dBi)	Maximum EIRP Power (dBm)	Maximum EIRP Power (mW)	Remark
5470 to 5725	23.38	2.94	26.32	428.55	NOTE (1)

NOTE:

- (1) EIRP Power (dBm) = Conducted Power (dBm) + Antenna Gain (dBi).
Power (mW) = $1 \text{ mW} * 10^{(\text{dBm} / 10)}$.

3 U-NII DFS RULE REQUIREMENTS

3.1 WORKING MODES AND REQUIRED TEST ITEMS

The manufacturer shall state whether the UUT is capable of operating as a Master and/or a Client. If the UUT is capable of operating in more than one operating mode then each operating mode shall be tested separately. See tables below for the applicability of DFS requirements for each of the operational modes.

Applicability of DFS requirements prior to use a channel

Requirement	Operational Mode		
	Master	Client without radar detection	Client with radar detection
Non-Occupancy Period	√	√	√
DFS Detection Threshold	√	Not required	√
Channel Availability Check Time	√	Not required	Not required
U-NII Detection Bandwidth	√	Not required	√

Applicability of DFS requirements during normal operation

Requirement	Operational Mode		
	Master	Client without radar detection	Client with radar detection
DFS Detection Threshold	√	Not required	√
Channel Closing Transmission Time	√	√	√
Channel Move Time	√	√	√
U-NII Detection Bandwidth	√	Not required	√

Additional requirements for devices with multiple bandwidth modes	Master Device or Client with Radar Detection	Client Without Radar Detection
U-NII Detection Bandwidth and Statistical Performance Check	All BW modes must be tested	Not required
Channel Move Time and Channel Closing Transmission Time	Test using widest BW mode available	Test using the widest BW mode available for the link
All other tests	Any single BW mode	Not required

Note: Frequencies selected for statistical performance check should include several frequencies within the radar detection bandwidth and frequencies near the edge of the radar detection bandwidth. For 802.11 devices it is suggested to select frequencies in each of the bonded 20 MHz channels and the channel center frequency.

3.2 TEST LIMITS AND RADAR SIGNAL PARAMETERS

DETECTION THRESHOLD VALUES

DFS Detection Thresholds for Master Devices and Client Devices with Radar Detection.

Maximum Transmit Power	Value (See Notes 1, 2 and 3)
e.i.r.p. \geq 200 milliwatt	-64 dBm
e.i.r.p. < 200 milliwatt and power spectral density < 10 dBm/MHz	-62 dBm
e.i.r.p. < 200 milliwatt that do not meet the power spectral density requirement	-64 dBm

Note 1: This is the level at the input of the receiver assuming a 0 dBi receive antenna.

Note 2: Throughout these test procedures an additional 1 dB has been added to the amplitude of the test transmission waveforms to account for variations in measurement equipment. This will ensure that the test signal is at or above the detection threshold level to trigger a DFS response.

Note 3: EIRP is based on the highest antenna gain. For MIMO devices refer to KDB Publication 662911 D01.

TEST LIMIT

DFS Response Requirement Values

Parameter	Value
Non-occupancy period	Minimum 30 minutes
Channel Availability Check Time	60 seconds
Channel Move Time	10 seconds. See Note 1.
Channel Closing Transmission Time	200 milliseconds + an aggregate of 60 milliseconds over remaining 10 second period. See Notes 1 and 2.
U-NII Detection Bandwidth	Minimum 100% of the UNII 99% transmission power bandwidth. See Note 3.

Note 1: Channel Move Time and the Channel Closing Transmission Time should be performed with Radar Type 0. The measurement timing begins at the end of the Radar Type 0 burst.

Note 2: The Channel Closing Transmission Time is comprised of 200 milliseconds starting at the beginning of the Channel Move Time plus any additional intermittent control signals required to facilitate a Channel move (an aggregate of 60 milliseconds) during the remainder of the 10 second period. The aggregate duration of control signals will not count quiet periods in between transmissions.

Note 3: During the U-NII Detection Bandwidth detection test, radar type 0 should be used. For each frequency step the minimum percentage of detection is 90 percent. Measurements are performed with no data traffic.

PARAMETERS OF DFS TEST SIGNALS AND MINIMUM PERCENTAGE OF SUCCESSFUL DETECTIONS

Step intervals of 0.1 microsecond for Pulse Width, 1 microsecond for PRI, 1 MHz for chirp width and 1 for the number of pulses will be utilized for the random determination of specific test waveforms.

Short Pulse Radar Test Waveforms

Radar Type	Pulse Width (μsec)	PRI (μsec)	Number of Pulses	Minimum Percentage of Successful Detection	Minimum Number of Trials
0	1	1428	18	See Note 1	See Note 1
1	1	Test A: 15 unique PRI values randomly selected from the list of 23 PRI values in Table 5a	Roundup $\left\{ \left(\frac{1}{360} \right) \cdot \left(\frac{19 \cdot 10^6}{PRI_{\mu sec}} \right) \right\}$	60%	30
		Test B: 15 unique PRI values randomly selected within the range of 518-3066 μsec, with a minimum increment of 1 μsec, excluding PRI values selected in Test A			
2	1-5	150-230	23-29	60%	30
3	6-10	200-500	16-18	60%	30
4	11-20	200-500	12-16	60%	30
Aggregate (Radar Types 1-4)				80%	120
Note 1: Short Pulse Radar Type 0 should be used for the detection bandwidth test, channel move time, and channel closing time tests.					

A minimum of 30 unique waveforms are required for each of the Short Pulse Radar Types 2 through 4. If more than 30 waveforms are used for Short Pulse Radar Types 2 through 4, then each additional waveform must also be unique and not repeated from the previous waveforms. If more than 30 waveforms are used for Short Pulse Radar Type 1, then each additional waveform is generated with Test B and must also be unique and not repeated from the previous waveforms in Tests A or B.

For example if in Short Pulse Radar Type 1 Test B a PRI of 3066 usec is selected, the number of pulses

would be $\text{Roundup} \left\{ \left(\frac{1}{360} \right) \cdot \left(\frac{19 \cdot 10^6}{3066} \right) \right\} = \text{Round up } \{17.2\} = 18.$

Pulse Repetition Intervals Values for Test A

Pulse Repetition Frequency Number	Pulse Repetition Frequency (Pulses Per Second)	Pulse Repetition Interval (Microseconds)
1	1930.5	518
2	1858.7	538
3	1792.1	558
4	1730.1	578
5	1672.2	598
6	1618.1	618
7	1567.4	638
8	1519.8	658
9	1474.9	678
10	1432.7	698
11	1392.8	718
12	1355	738
13	1319.3	758
14	1285.3	778
15	1253.1	798
16	1222.5	818
17	1193.3	838
18	1165.6	858
19	1139	878
20	1113.6	898
21	1089.3	918
22	1066.1	938
23	326.2	3066

The aggregate is the average of the percentage of successful detections of Short Pulse Radar Types 1-4.

Long Pulse Radar Test Waveform

Radar Type	Pulse Width (μsec)	Chirp Width (MHz)	PRI (μsec)	Number of Pulses per Burst	Number of Bursts	Minimum Percentage of Successful Detection	Minimum Number of Trials
5	50-100	5-20	1000-2000	1-3	8-20	80%	30

The parameters for this waveform are randomly chosen (The center frequency for each of the 30 trials of the Bin 5 radar shall be randomly selected within 80% of the Occupied Bandwidth.) Thirty unique waveforms are required for the Long Pulse Radar Type waveforms. If more than 30 waveforms are used for the Long Pulse Radar Type waveforms, then each additional waveform must also be unique and not repeated from the previous waveforms.

Frequency Hopping Radar Test Waveform

Radar Type	Pulse Width (μsec)	Chirp Width (MHz)	PRI (μsec)	Number of Pulses per Burst	Number of Bursts	Minimum Percentage of Successful Detection	Minimum Number of Trials
6	1	333	9	0.333	300	70%	30

For the Frequency Hopping Radar Type, the same Burst parameters are used for each waveform. The hopping sequence is different for each waveform and a 100-length segment is selected from the hopping sequence defined by the following algorithm: If a segment does not contain at least 1 frequency within the U-NII Detection Bandwidth of the UUT, then that segment is not used.

The first frequency in a hopping sequence is selected randomly from the group of 475 integer frequencies from 5250 - 5724 MHz. Next, the frequency that was just chosen is removed from the group and a frequency is randomly selected from the remaining 474 frequencies in the group. This process continues until all 475 frequencies are chosen for the set. For selection of a random frequency, the frequencies remaining within the group are always treated as equally likely.

4 DYNAMIC FREQUENCY SELECTION (DFS) TEST

4.1 DFS MEASUREMENT SYSTEM

Test Procedure

1. Master device and client device are set up by conduction method as the following configuration.
2. The client device is connected to notebook and to access a IP address on wireless connection with the master device.
3. Then the master device is connected to another notebook to access a IP address.
4. Finally, let the two IP addresses run traffic with each other through the Run flow software "Lan test" to reach 17% channel loading as below

Setup for Master with injection at the Master

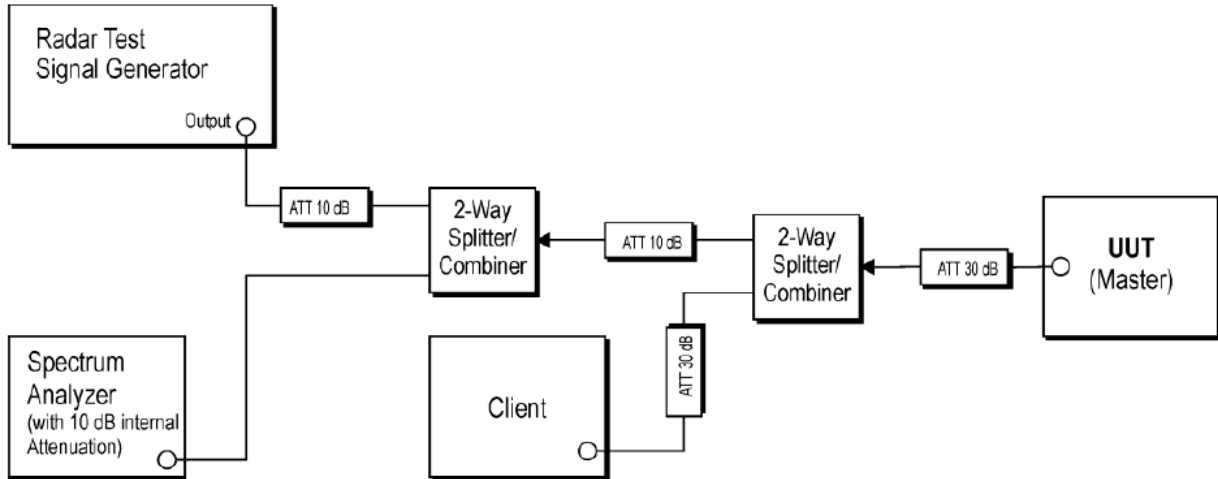

Radar Test Waveforms are injected into the Master.

Setup for Client with injection at the Client

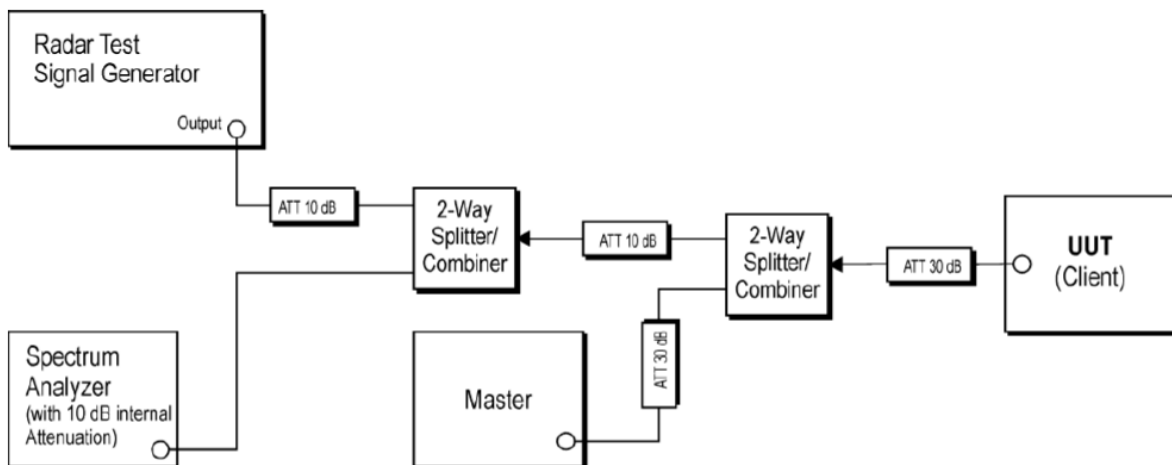

Radar Test Waveforms are injected into the Client

Channel Loading

UNII-2C

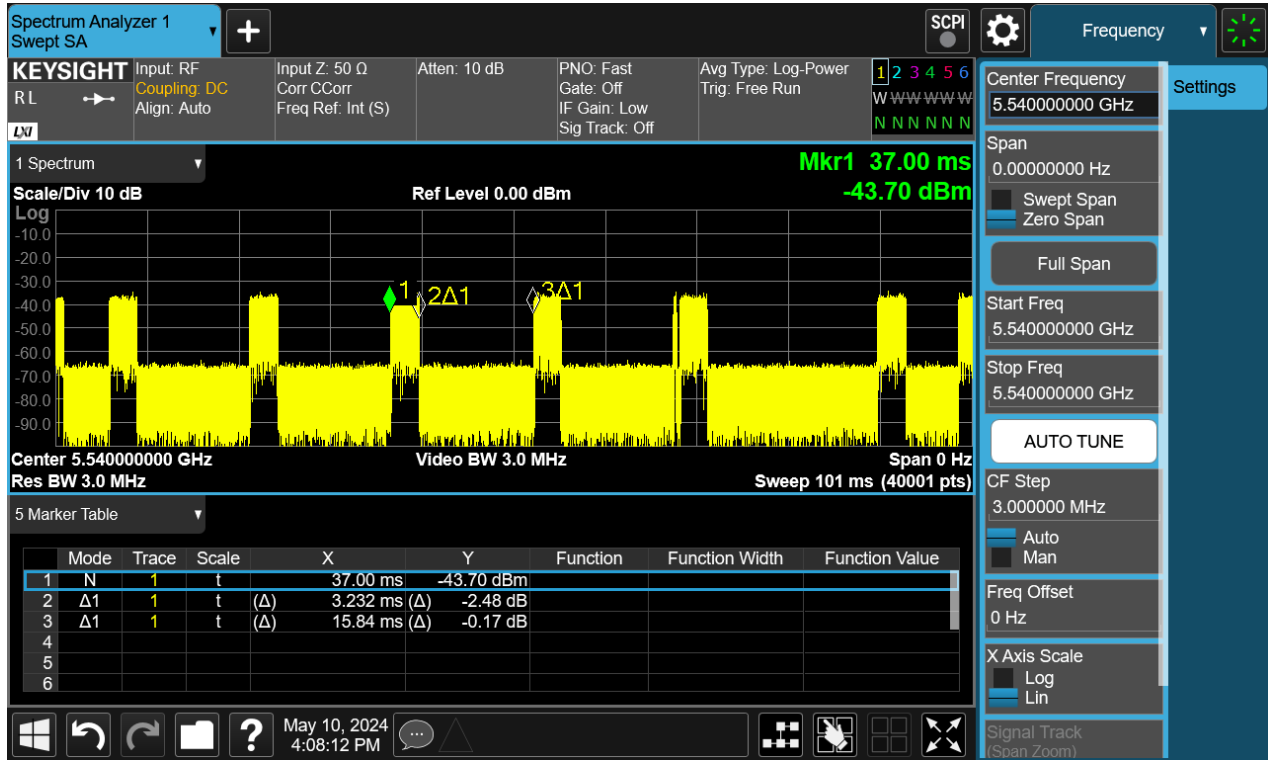

Test Band	ON (ms)	Numbers (ON)	On Time (ms)	Period (ON+OFF) (ms)	Channel Loading Ratio (%)	Required Ratio (%)
5.470 GHz to 5.725 GHz	3.23	1	3.23	15.84	20.39%	≥ 17%

The hopping type 6 pulse parameters are fixed while the hopping sequence is based on the August 2005 NTIA Hopping Frequency List. The initial starting point randomized at run-time and each subsequent starting point is incremented by 475. Each frequency in the 100-length segment is compared to the boundaries of the EUT Detection Bandwidth and the software creates a hopping burst pattern in accordance with Section 7.4.1.3 Method #2 Simulated frequency Hopping Radar Waveform Generating Subsystem of FCC 06-96. The frequency of the signal generator is incremented in 1 MHz steps from FL to FH for each successive trial. This incremental sequence is repeated as required to generate a minimum of 30 total trials and to maintain a uniform frequency distribution over the entire Detection Bandwidth.

The signal monitoring equipment consists of a spectrum analyzer set to display 8001 bins on the horizontal axis. The time-domain resolution is 2 msec / bin with a 16 second sweep time, meeting the 10 second short pulse reporting criteria. The aggregate ON time is calculated by multiplying the number of bins above a threshold during a particular observation period by the dwell time per bin, with the analyzer set to peak detection and max hold.

Should multiple RF ports be utilized for the Master and/or Slave devices (for example, for diversity or MIMO implementations), additional combiner/dividers are inserted between the Master Combiner/Divider and the pad connected to the Master Device (and/or between the Slave Combiner/Divider and the pad connected to the Slave Device). Additional pads are utilized such that there is one pad at each RF port on each EUT.

4.2 CALIBRATION OF DFS DETECTION THRESHOLD LEVEL

A 50 ohm load is connected in place of the spectrum analyzer, and the spectrum analyzer is connected in place of the master device and the signal generator is set to CW mode. The amplitude of the signal generator is adjusted to yield a level of -62 dBm as measured on the spectrum analyzer.

Without changing any of the instrument settings, the spectrum analyzer is reconnected to the Common port of the Spectrum Analyzer Combiner/Divider. Measure the amplitude and calculate the difference from -62 dBm. Adjust the Reference Level Offset of the spectrum analyzer to this difference.

The spectrum analyzer displays the level of the signal generator as received at the antenna ports of the Master Device. The interference detection threshold may be varied from the calibrated value of -62 dBm and the spectrum analyzer will still indicate the level as received by the Master Device.

Set the signal generator to produce a radar waveform, trigger a burst manually and measure the level on the spectrum analyzer. Readjust the amplitude of the signal generator as required so that the peak level of the waveform is at a displayed level equal to the required or desired interference detection threshold. Separate signal generator amplitude settings are determined as required for each radar type.

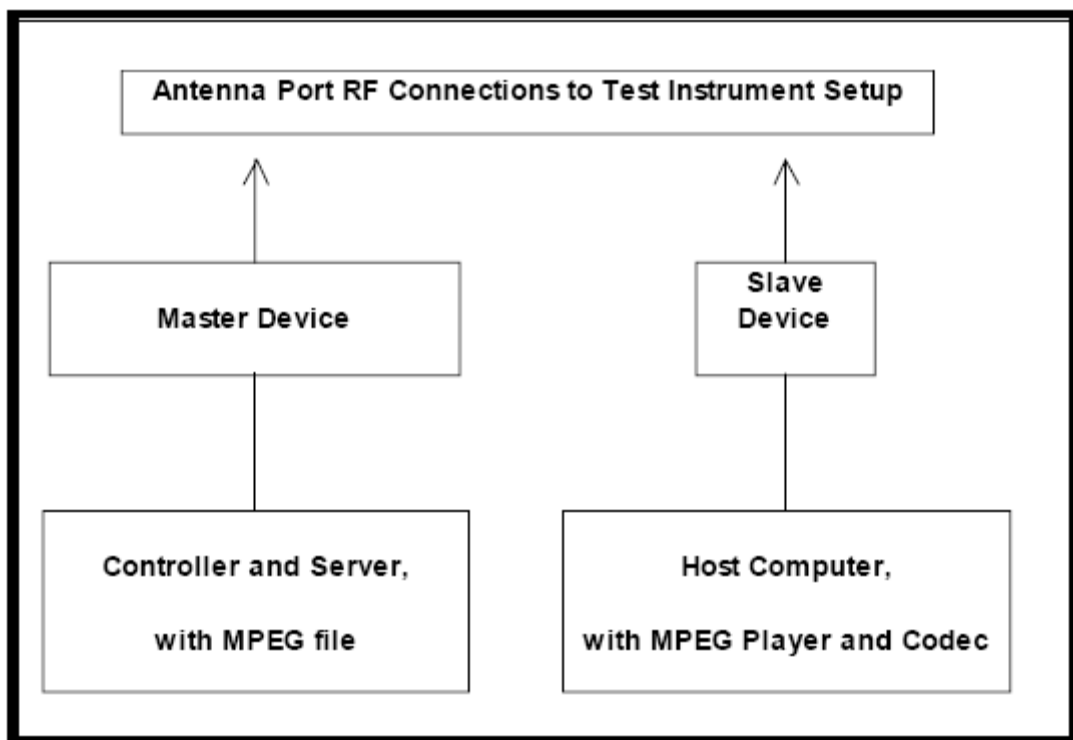

4.3 DEVIATION FROM TEST STANDARD

No deviation.

5 LIST OF MEASURING EQUIPMENTS

Dynamic Frequency Selection (DFS)						
Item	Kind of Equipment	Manufacturer	Type No.	Serial No.	Calibrated Date	Calibrated Until
1	MXG Vector Signal Generator	Agilent	N5182B	MY51350711	2024/2/21	2025/2/20
2	MXA Signal Analyzer	Keysight	N9020B	MY63490160	2024/2/6	2025/2/5

Remark: "N/A" denotes no model name, no serial no. or no calibration specified.
All calibration period of equipment list is one year.

6 EUT TEST PHOTO

Please refer to document Appendix No.: TP-2402G042-FCCP-1 (APPENDIX-TEST PHOTOS).

7 EUT PHOTOS

Please refer to document Appendix No.: EP-2402G042-1 (APPENDIX-EUT PHOTOS).

8 TEST RESULTS

8.1 SUMMARY OF TEST RESULT

Clause	Test Parameter	Test Bandwidth / Channel	Remarks	Pass/Fail
15.407	DFS Detection Threshold	20MHz / 5540 MHz	Applicable	Pass
15.407	Channel Availability Check Time	20MHz / 5540 MHz 40MHz / 5550 MHz 160MHz / 5570 MHz	Applicable	Pass
15.407	Channel Move Time	20MHz / 5540 MHz 40MHz / 5550 MHz 160MHz / 5570 MHz	Applicable	Pass
15.407	Channel Closing Transmission Time	20MHz / 5540 MHz 40MHz / 5550 MHz 160MHz / 5570 MHz	Applicable	Pass
15.407	Probability Of Succeed	20MHz / 5540 MHz 40MHz / 5550 MHz 160MHz / 5570 MHz	Applicable	Pass
15.407	Non- Occupancy Period	20MHz / 5540 MHz 40MHz / 5550 MHz 160MHz / 5570 MHz	Applicable	Pass
15.407	Uniform Spreading	-	Not Applicable	N/A
15.407	U-NII Detection Bandwidth	20MHz / 5540 MHz 40MHz / 5550 MHz 160MHz / 5570 MHz	Applicable	Pass

8.2 DFS DETECTION THRESHOLD

Test Mode UNII-2C, Nominal Bandwidth / Channel: 20 MHz / 5540 MHz

Radar Signal 0

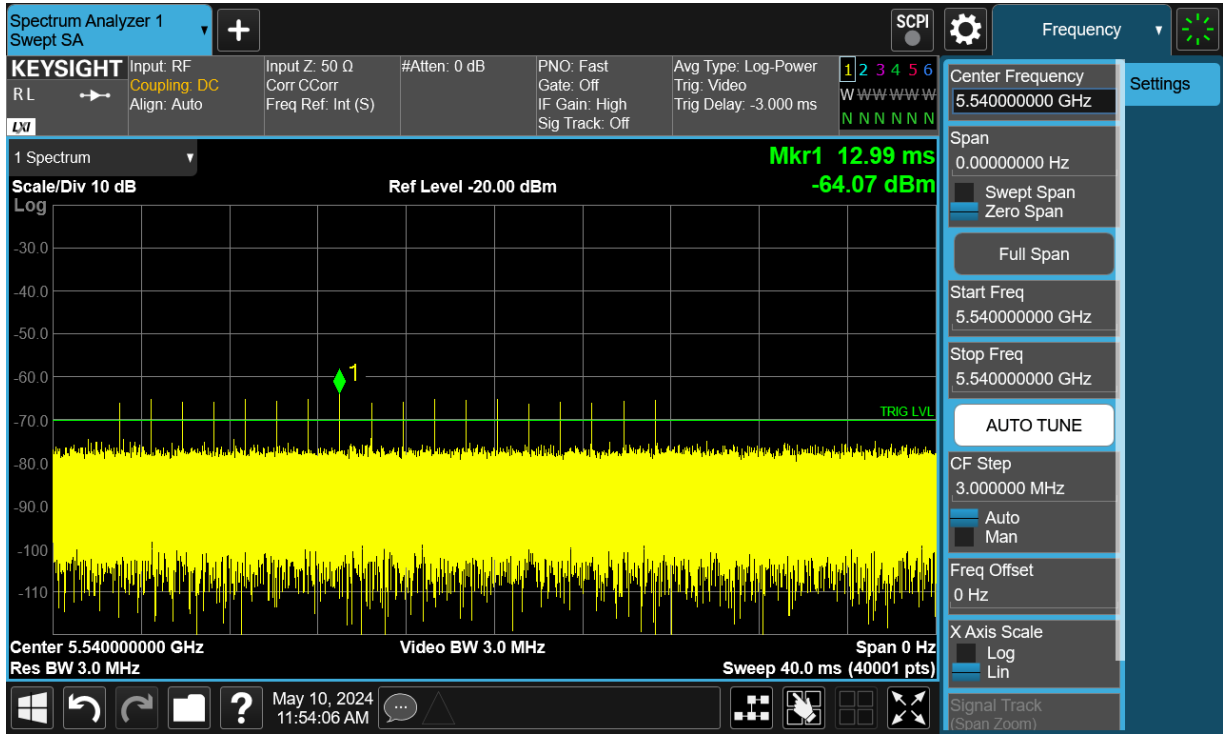

Radar Signal 1

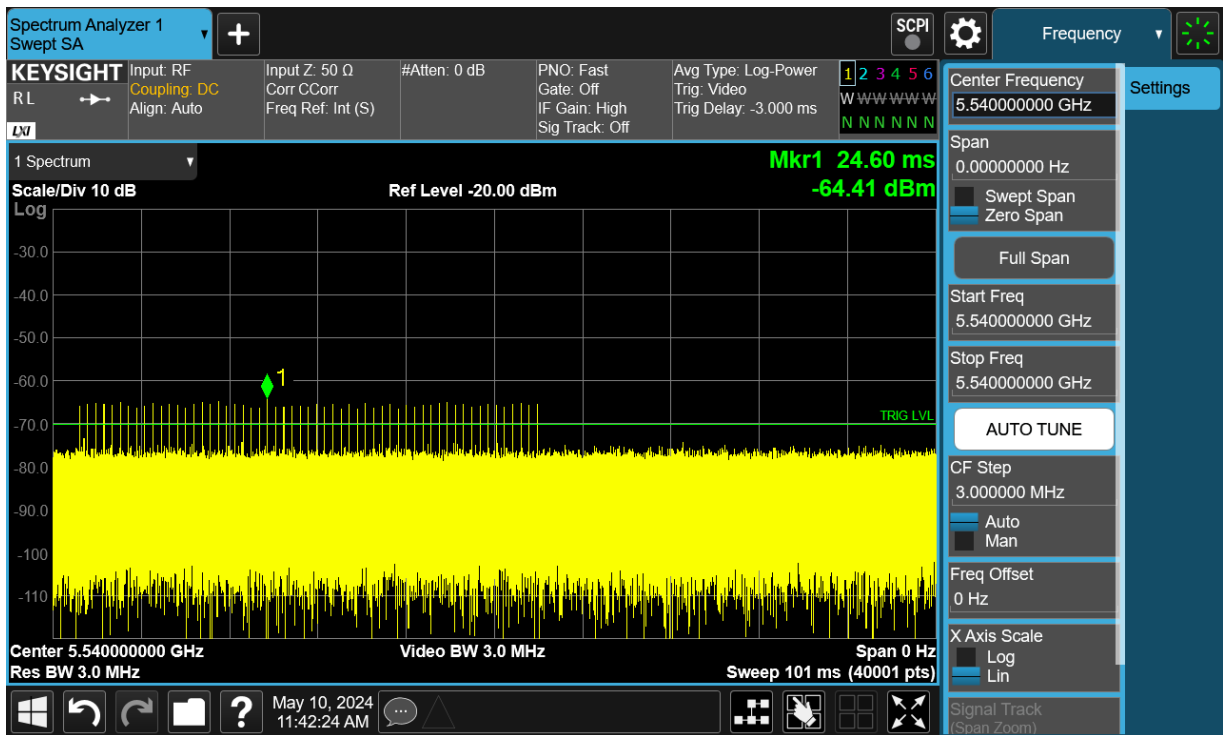

Radar Signal 2

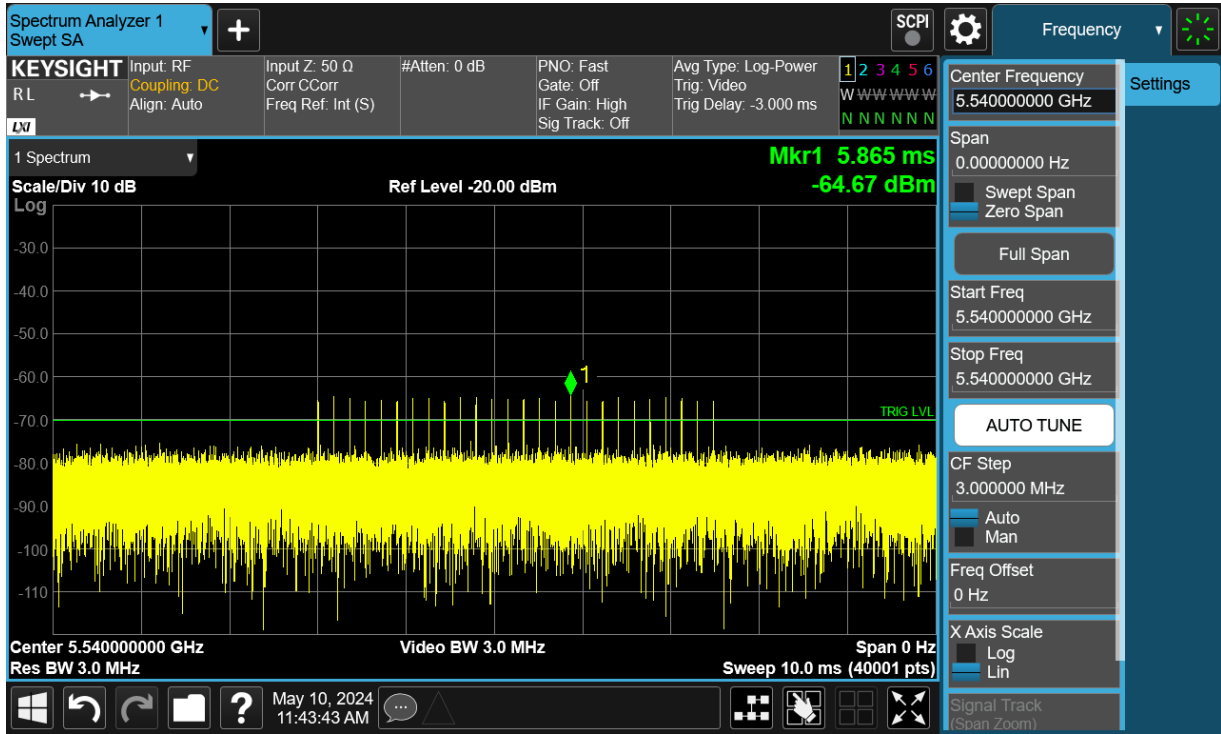

Radar Signal 3

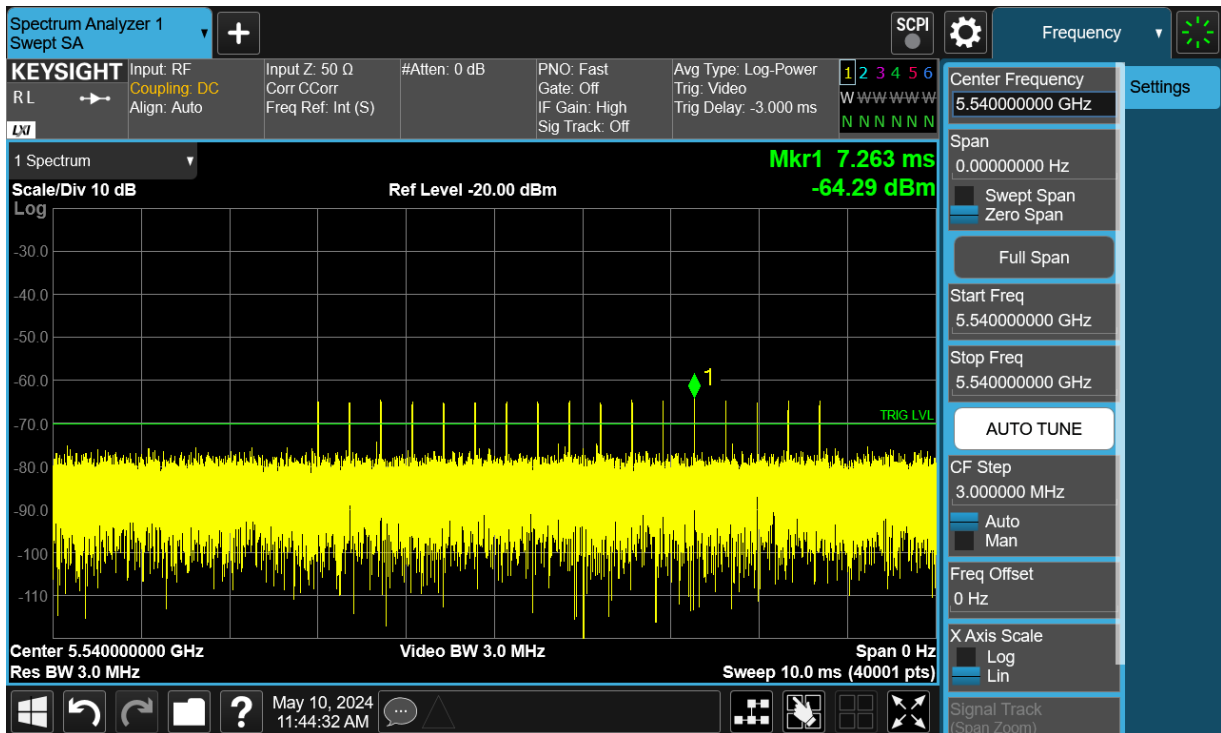

Radar Signal 4

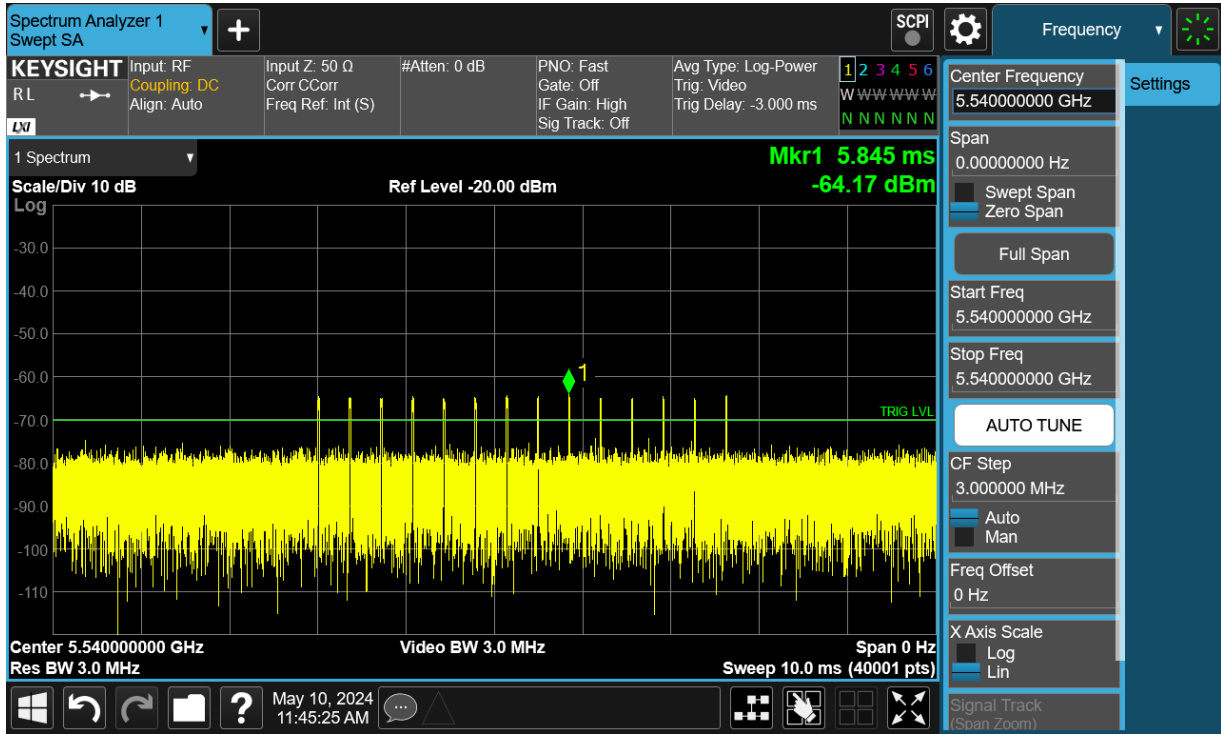

Radar Signal 5

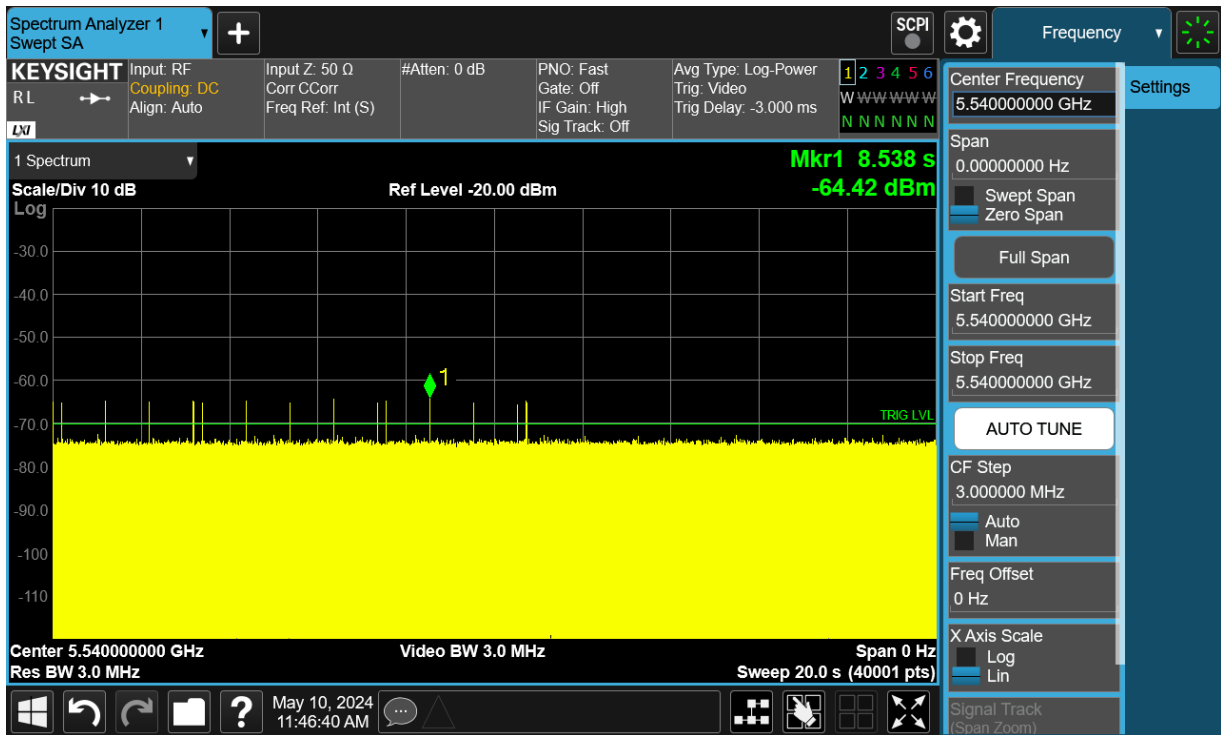

Radar Signal 6

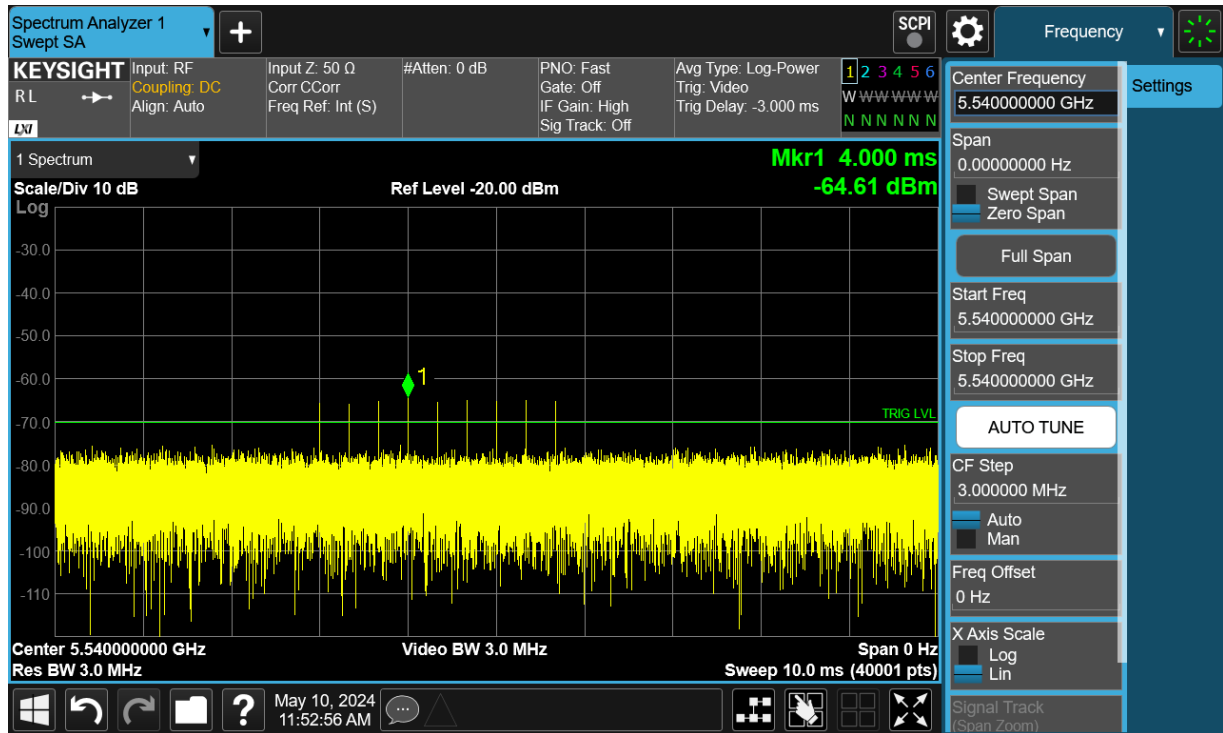

8.3 RADAR TEST WAVEFORMS**Radar Signal 0**

Trial ID	Radar Type	Pulse Width (μs)	PRI (μs)	Number of Pulses	Waveform Length (μs)
0	Type 0	1	1428	18	25704

Radar Signal 1

Trial ID	Radar Type	Pulse Width (μs)	PRI (μs)	Number of Pulses	Waveform Length (μs)
0	Type 1	1	938	57	53466
1	Type 1	1	698	76	53048
2	Type 1	1	618	86	53148
3	Type 1	1	538	99	53262
4	Type 1	1	878	61	53558
5	Type 1	1	3066	18	55188
6	Type 1	1	638	83	52954
7	Type 1	1	918	58	53244
8	Type 1	1	838	63	52794
9	Type 1	1	858	62	53196
10	Type 1	1	798	67	53466
11	Type 1	1	718	74	53132
12	Type 1	1	578	92	53176
13	Type 1	1	598	89	53222
14	Type 1	1	558	95	53010
15	Type 1	1	2536	21	53256
16	Type 1	1	966	55	53130
17	Type 1	1	827	64	52928
18	Type 1	1	2501	22	55022
19	Type 1	1	2595	21	54495
20	Type 1	1	1114	48	53472
21	Type 1	1	1302	41	53382
22	Type 1	1	3045	18	54810
23	Type 1	1	1624	33	53592
24	Type 1	1	2878	19	54682
25	Type 1	1	1027	52	53404
26	Type 1	1	2485	22	54670
27	Type 1	1	1600	33	52800
28	Type 1	1	1172	46	53912
29	Type 1	1	1177	45	52965

Radar Signal 2

Trial ID	Radar Type	Pulse Width (μs)	PRI (μs)	Number of Pulses	Waveform Length (μs)
0	Type 2	3.2	179	26	4654
1	Type 2	1.1	207	23	4761
2	Type 2	2.1	230	24	5520
3	Type 2	4.8	200	29	5800
4	Type 2	3.9	214	28	5992
5	Type 2	2.9	222	26	5772
6	Type 2	3.2	204	26	5304
7	Type 2	2.5	192	25	4800
8	Type 2	3.1	164	26	4264
9	Type 2	1.2	156	23	3588
10	Type 2	3.9	210	27	5670
11	Type 2	4.6	201	29	5829
12	Type 2	3.2	162	26	4212
13	Type 2	2.2	197	25	4925
14	Type 2	4.5	163	29	4727
15	Type 2	3	203	26	5278
16	Type 2	5	168	29	4872
17	Type 2	2.4	217	25	5425
18	Type 2	2.9	191	26	4966
19	Type 2	2.3	166	25	4150
20	Type 2	3.7	150	27	4050
21	Type 2	2.2	176	25	4400
22	Type 2	4.9	195	29	5655
23	Type 2	2.9	202	26	5252
24	Type 2	2.5	178	25	4450
25	Type 2	1.1	206	23	4738
26	Type 2	3.8	155	27	4185
27	Type 2	4.7	157	29	4553
28	Type 2	2.4	224	25	5600
29	Type 2	4.2	159	28	4452

Radar Signal 3

Trial ID	Radar Type	Pulse Width (μs)	PRI (μs)	Number of Pulses	Waveform Length (μs)
0	Type 3	8.2	355	17	6035
1	Type 3	6.1	487	16	7792
2	Type 3	7.1	344	16	5504
3	Type 3	9.8	288	18	5184
4	Type 3	8.9	230	18	4140
5	Type 3	7.9	432	17	7344
6	Type 3	8.2	207	17	3519
7	Type 3	7.5	443	17	7531
8	Type 3	8.1	439	17	7463
9	Type 3	6.2	223	16	3568
10	Type 3	8.9	208	18	3744
11	Type 3	9.6	463	18	8334
12	Type 3	8.2	441	17	7497
13	Type 3	7.2	323	16	5168
14	Type 3	9.5	297	18	5346
15	Type 3	8	412	17	7004
16	Type 3	10	324	18	5832
17	Type 3	7.4	271	17	4607
18	Type 3	7.9	349	17	5933
19	Type 3	7.3	409	16	6544
20	Type 3	8.7	373	18	6714
21	Type 3	7.2	254	16	4064
22	Type 3	9.9	274	18	4932
23	Type 3	7.9	278	17	4726
24	Type 3	7.5	317	17	5389
25	Type 3	6.1	260	16	4160
26	Type 3	8.8	211	18	3798
27	Type 3	9.7	272	18	4896
28	Type 3	7.4	264	17	4488
29	Type 3	9.2	284	18	5112

Radar Signal 4

Trial ID	Radar Type	Pulse Width (µs)	PRI (µs)	Number of Pulses	Waveform Length (µs)
0	Type 4	16	355	14	4970
1	Type 4	11.3	487	12	5844
2	Type 4	13.5	344	13	4472
3	Type 4	19.4	288	16	4608
4	Type 4	17.5	230	15	3450
5	Type 4	15.3	432	14	6048
6	Type 4	15.9	207	14	2898
7	Type 4	14.3	443	13	5759
8	Type 4	15.8	439	14	6146
9	Type 4	11.5	223	12	2676
10	Type 4	17.4	208	15	3120
11	Type 4	19	463	16	7408
12	Type 4	16	441	14	6174
13	Type 4	13.8	323	13	4199
14	Type 4	18.9	297	16	4752
15	Type 4	15.5	412	14	5768
16	Type 4	19.9	324	16	5184
17	Type 4	14.1	271	13	3523
18	Type 4	15.2	349	14	4886
19	Type 4	13.8	409	13	5317
20	Type 4	17.1	373	15	5595
21	Type 4	13.8	254	13	3302
22	Type 4	19.8	274	16	4384
23	Type 4	15.3	278	14	3892
24	Type 4	14.5	317	13	4121
25	Type 4	11.3	260	12	3120
26	Type 4	17.3	211	15	3165
27	Type 4	19.2	272	16	4352
28	Type 4	14.2	264	13	3432
29	Type 4	18.2	284	15	4260

Radar Signal 5_5260 MHz

Trial ID	Radar Type	Number of Bursts	Burst Period(s)	Wave from Length (s)	Center Frequency(GHz)	-		
0	Type 5	15	0.8	12	5.26	-		
	Burst ID	Burst Offset (μs)	Pulse Width (μs)	Chirp Width (MHz)	Number of Pulses per Burst	PRI-1 (μs)	PRI-2 (μs)	PRI-3 (μs)
	0	636185	77.8	13	2	1665	1477	-
	1	32674	51.9	13	1	1074	-	-
	2	226294	63.8	13	1	1584	-	-
	3	417976	96.6	13	3	1682	1786	1843
	4	611152	85.9	13	3	1795	1215	1729
	5	8789	73.7	13	2	1198	1549	-
	6	201917	77.2	13	2	1837	1819	-
	7	395530	68.4	13	2	1587	1114	-
	8	588564	76.7	13	2	2000	1155	-
	9	783794	53.2	13	1	1147	-	-
	10	177933	85.7	13	3	1433	1695	1394
	11	370624	94.3	13	3	1670	1426	1935
	12	564893	77.6	13	2	1294	1671	-
	13	759583	65.7	13	1	1512	-	-
	14	154262	93.5	13	3	1444	1130	1468
1	Type 5	8	1.5	12	5.26			
	Burst ID	Burst Offset (μs)	Pulse Width (μs)	Chirp Width (MHz)	Number of Pulses per Burst	PRI-1 (μs)	PRI-2 (μs)	PRI-3 (μs)
	0	653020	75	5	2	1880	1527	-
	1	1015643	99.4	5	3	1401	1262	1257
	2	1379398	67.4	5	2	1531	1403	-
	3	245489	73.6	5	2	1449	1041	-
	4	609113	65.9	5	1	1432	-	-
	5	970852	83.8	5	3	1356	1292	1419
	6	1335913	65.5	5	1	1543	-	-
	7	200406	98.6	5	3	1548	1796	1728

Trial ID	Radar Type	Number of Bursts	Burst Period(s)	Wave from Length (s)	Center Frequency(GHz)	-		
2	Type 5	11	1.090909	12	5.26			
	Burst ID	Burst Offset (μs)	Pulse Width (μs)	Chirp Width (MHz)	Number of Pulses per Burst	PRI-1 (μs)	PRI-2 (μs)	PRI-3 (μs)
	0	409565	73.8	9	2	1806	1538	-
	1	673692	69.5	9	2	1117	1649	-
	2	938562	51.9	9	1	1651	-	-
	3	113209	84.6	9	3	1976	1032	1271
	4	376726	95.4	9	3	1060	1903	1388
	5	641212	68	9	2	1368	1351	-
	6	903714	89.6	9	3	1338	1514	1573
	7	80863	81.9	9	2	1022	1689	-
	8	344067	88.3	9	3	1810	1330	1838
	9	609331	53.7	9	1	1597	-	-
	10	871542	91.3	9	3	1961	1106	1001
3	Type 5	20	0.6	12	5.26			
	Burst ID	Burst Offset (μs)	Pulse Width (μs)	Chirp Width (MHz)	Number of Pulses per Burst	PRI-1 (μs)	PRI-2 (μs)	PRI-3 (μs)
	0	26541	68.1	19	2	1339	1355	-
	1	171821	58.7	19	1	1251	-	-
	2	316229	75.3	19	2	1136	1640	-
	3	461864	56.4	19	1	1753	-	-
	4	8677	99.7	19	3	1196	1708	1159
	5	153995	57.7	19	1	1013	-	-
	6	299238	59.5	19	1	1072	-	-
	7	443177	80	19	2	1482	1369	-
	8	587671	82	19	2	1993	1197	-
	9	135674	82.8	19	2	1883	1005	-
	10	279928	88	19	3	1061	1928	1101
	11	424279	93.2	19	3	1207	1907	1223
	12	570132	70.4	19	2	1526	1360	-
	13	117439	95.3	19	3	1171	1955	1775
	14	262502	81.9	19	2	1690	1545	-
	15	406573	98.5	19	3	1975	1169	1062
	16	553328	65	19	1	1767	-	-
	17	99799	85.4	19	3	1011	1637	1425
	18	244095	91.6	19	3	1878	1445	1325
	19	390012	67.3	19	2	1091	1218	-

Trial ID	Radar Type	Number of Bursts	Burst Period(s)	Wave from Length (s)	Center Frequency(GHz)	-		
4	Type 5	17	0.705882	12	5.26			
	Burst ID	Burst Offset (μs)	Pulse Width (μs)	Chirp Width (MHz)	Number of Pulses per Burst	PRI-1 (μs)	PRI-2 (μs)	PRI-3 (μs)
	0	629614	67.9	16	2	1320	1133	-
	1	96856	62.3	16	1	1957	-	-
	2	267719	53.3	16	1	1592	-	-
	3	436784	90	16	3	1900	1153	1346
	4	608289	77.1	16	2	1166	1646	-
	5	75610	83.9	16	3	1278	1232	1459
	6	245638	89.1	16	3	1240	1384	1939
	7	416355	81.8	16	2	1833	1676	-
	8	588736	50.3	16	1	1075	-	-
	9	54571	87.1	16	3	1116	1996	1756
	10	225175	71.3	16	2	1225	1815	-
	11	394825	97.5	16	3	1884	1465	1132
	12	565361	90.6	16	3	1561	1040	1354
	13	33643	86.3	16	3	1596	1183	1792
	14	203957	97.6	16	3	1365	1073	1361
	15	373812	84.7	16	3	1021	1718	1854
	16	544060	99.7	16	3	1150	1244	1988
5	Type 5	14	0.857143	12	5.26			
	Burst ID	Burst Offset (μs)	Pulse Width (μs)	Chirp Width (MHz)	Number of Pulses per Burst	PRI-1 (μs)	PRI-2 (μs)	PRI-3 (μs)
	0	15438	92.9	12	3	1085	1564	1407
	1	222486	67.7	12	2	1744	1747	-
	2	430731	65.8	12	1	1092	-	-
	3	637784	56.3	12	1	1851	-	-
	4	845342	53.7	12	1	1727	-	-
	5	196720	83.5	12	3	1679	1930	1025
	6	404955	65.8	12	1	1519	-	-
	7	610711	85.9	12	3	1134	1034	1808
	8	818057	76.3	12	2	1606	1926	-
	9	171459	81.5	12	2	1891	1714	-
	10	377969	89.4	12	3	1310	1594	1827
	11	586875	63.4	12	1	1568	-	-
	12	792834	69.6	12	2	1307	1925	-
	13	146044	74.5	12	2	1264	1846	-

Trial ID	Radar Type	Number of Bursts	Burst Period(s)	Wave from Length (s)	Center Frequency(GHz)	-		
6	Type 5	15	0.8	12	5.26			
	Burst ID	Burst Offset (μs)	Pulse Width (μs)	Chirp Width (MHz)	Number of Pulses per Burst	PRI-1 (μs)	PRI-2 (μs)	PRI-3 (μs)
	0	329022	96.6	13	3	1182	1609	1581
	1	521718	96.7	13	3	1829	1799	1154
	2	714222	86.5	13	3	1923	1396	1865
	3	112450	73.3	13	2	1908	1318	-
	4	306283	55.8	13	1	1688	-	-
	5	500239	55.4	13	1	1145	-	-
	6	690932	85.3	13	3	1336	1504	1820
	7	88645	79.4	13	2	1344	1893	-
	8	282508	65.7	13	1	1476	-	-
	9	475842	68.6	13	2	1008	1028	-
	10	667887	77.7	13	2	1972	1835	-
	11	64845	79.6	13	2	1882	1331	-
	12	257755	94.9	13	3	1830	1070	1349
	13	452335	61.4	13	1	1451	-	-
	14	643395	90.6	13	3	1233	1562	1887
7	Type 5	12	1	12	5.26			
	Burst ID	Burst Offset (μs)	Pulse Width (μs)	Chirp Width (MHz)	Number of Pulses per Burst	PRI-1 (μs)	PRI-2 (μs)	PRI-3 (μs)
	0	51446	52.6	10	1	1210	-	-
	1	292696	84.1	10	3	1314	1725	1529
	2	533989	97.7	10	3	1139	1868	1805
	3	775564	97.3	10	3	1341	1446	1755
	4	21542	98.8	10	3	1544	1386	1302
	5	263385	72.2	10	2	1771	1184	-
	6	505581	67.6	10	2	1175	1027	-
	7	747058	75.7	10	2	1026	1871	-
	8	989976	60.9	10	1	1798	-	-
	9	234024	64.2	10	1	1138	-	-
	10	475207	78.8	10	2	1784	1604	-
	11	715825	87.5	10	3	1511	1712	1683

Trial ID	Radar Type	Number of Bursts	Burst Peried(s)	Wave from Length (s)	Center Frequency(GHz)	-		
8	Type 5	14	0.857143	12	5.26			
	Burst ID	Burst Offset (μs)	Pulse Width (μs)	Chirp Width (MHz)	Number of Pulses per Burst	PRI-1 (μs)	PRI-2 (μs)	PRI-3 (μs)
	0	823112	54.1	13	1	1415	-	-
	1	174965	50.7	13	1	1221	-	-
	2	382216	52.3	13	1	1974	-	-
	3	587395	99.8	13	3	1558	1696	1949
	4	796897	68.4	13	2	1014	1099	-
	5	149042	80.8	13	2	1736	1505	-
	6	356750	62.5	13	1	1778	-	-
	7	563824	74.8	13	2	1149	1204	-
	8	772314	50.8	13	1	1049	-	-
	9	123796	54	13	1	1417	-	-
	10	331215	63	13	1	1730	-	-
	11	537402	91.8	13	3	1143	1270	1347
	12	744805	79.3	13	2	1274	1992	-
	13	98172	64.3	13	1	1937	-	-
9	Type 5	8	1.5	12	5.26			
	Burst ID	Burst Offset (μs)	Pulse Width (μs)	Chirp Width (MHz)	Number of Pulses per Burst	PRI-1 (μs)	PRI-2 (μs)	PRI-3 (μs)
	0	535615	63.4	6	1	1043	-	-
	1	898668	52	6	1	1863	-	-
	2	1259235	97.2	6	3	1973	1605	1583
	3	127106	78.7	6	2	1466	1743	-
	4	490358	74.2	6	2	1280	1219	-
	5	852409	88.7	6	3	1293	1934	1273
	6	1217152	54.3	6	1	1991	-	-
	7	82296	95.4	6	3	1580	1555	1791

Trial ID	Radar Type	Number of Bursts	Burst Period(s)	Wave from Length (s)	Center Frequency(GHz)	-		
10	Type 5	17	0.705882	12	5.2564			
	Burst ID	Burst Offset (μs)	Pulse Width (μs)	Chirp Width (MHz)	Number of Pulses per Burst	PRI-1 (μs)	PRI-2 (μs)	PRI-3 (μs)
	0	209249	73.7	16	2	1208	1497	-
	1	378386	97.4	16	3	1942	1754	1613
	2	548411	91.7	16	3	1999	1702	1462
	3	17733	66.2	16	1	1393	-	-
	4	187952	70.8	16	2	1968	1821	-
	5	359277	52.3	16	1	1740	-	-
	6	528886	78.9	16	2	1308	1984	-
	7	700166	70.9	16	2	1050	1358	-
	8	167197	75.6	16	2	1437	1430	-
	9	338262	59.1	16	1	1697	-	-
	10	508324	77	16	2	1397	1304	-
	11	678689	67.9	16	2	1803	1083	-
	12	146031	81.2	16	2	1720	1932	-
	13	316923	78.7	16	2	1247	1121	-
	14	488056	63.3	16	1	1634	-	-
	15	657326	68.9	16	2	1849	1423	-
	16	125509	59.3	16	1	1093	-	-
11	Type 5	19	0.631579	12	5.2576			
	Burst ID	Burst Offset (μs)	Pulse Width (μs)	Chirp Width (MHz)	Number of Pulses per Burst	PRI-1 (μs)	PRI-2 (μs)	PRI-3 (μs)
	0	263736	98.9	19	3	1381	1680	1488
	1	416459	82.3	19	2	1716	1855	-
	2	567902	86.7	19	3	1211	1400	1919
	3	92979	89.7	19	3	1861	1068	1282
	4	245155	98.6	19	3	1507	1194	1461
	5	397609	71.1	19	2	1921	1789	-
	6	551431	55.9	19	1	1947	-	-
	7	74413	67.9	19	2	1350	1372	-
	8	226559	84.4	19	3	1203	1107	1443
	9	380056	58.8	19	1	1715	-	-
	10	533408	65.6	19	1	1017	-	-
	11	55547	78.5	19	2	1911	1704	-
	12	207876	82.3	19	2	1845	1686	-
	13	359771	90.1	19	3	1938	1071	1266
	14	511297	90.2	19	3	1989	1089	1950
	15	36803	83.1	19	2	1943	1406	-
	16	189652	58.8	19	1	1742	-	-
	17	341809	77	19	2	1187	1657	-
	18	495737	55	19	1	1012	-	-

Trial ID	Radar Type	Number of Bursts	Burst Period(s)	Wave from Length (s)	Center Frequency(GHz)	-		
12	Type 5	15	0.8	12	5.2552			
	Burst ID	Burst Offset (μs)	Pulse Width (μs)	Chirp Width (MHz)	Number of Pulses per Burst	PRI-1 (μs)	PRI-2 (μs)	PRI-3 (μs)
	0	22911	58.1	13	1	1929	-	-
	1	216473	52.1	13	1	1910	-	-
	2	410004	59.9	13	1	1971	-	-
	3	603671	60.2	13	1	1812	-	-
	4	794160	95.9	13	3	1399	1906	1608
	5	192251	79.9	13	2	1626	1859	-
	6	385590	78.5	13	2	1238	1917	-
	7	579862	53.8	13	1	1763	-	-
	8	773423	64.7	13	1	1800	-	-
	9	168898	61.4	13	1	1390	-	-
	10	361606	83.2	13	2	1692	1858	-
	11	553866	84.7	13	3	1533	1677	1638
	12	747241	88.7	13	3	1703	1528	1058
	13	144710	78.3	13	2	1258	1951	-
	14	337856	69.3	13	2	1731	1717	-
13	Type 5	12	1	12	5.254			
	Burst ID	Burst Offset (μs)	Pulse Width (μs)	Chirp Width (MHz)	Number of Pulses per Burst	PRI-1 (μs)	PRI-2 (μs)	PRI-3 (μs)
	0	664275	75.3	10	2	1994	1612	-
	1	907886	56.3	10	1	1456	-	-
	2	151316	67.7	10	2	1617	1185	-
	3	393746	55.6	10	1	1337	-	-
	4	635093	75.2	10	2	1421	1267	-
	5	876993	76.3	10	2	1359	1305	-
	6	121278	85.7	10	3	1547	1362	1924
	7	362696	98.4	10	3	1873	1550	1249
	8	604342	86.4	10	3	1779	1439	1046
	9	846453	93.6	10	3	1059	1031	1452
	10	91871	63.3	10	1	1328	-	-
	11	333050	92.4	10	3	1412	1673	1322

Trial ID	Radar Type	Number of Bursts	Burst Period(s)	Wave from Length (s)	Center Frequency(GHz)	-		
14	Type 5	19	0.631579	12	5.2572			
	Burst ID	Burst Offset (μs)	Pulse Width (μs)	Chirp Width (MHz)	Number of Pulses per Burst	PRI-1 (μs)	PRI-2 (μs)	PRI-3 (μs)
	0	361323	93.3	18	3	1983	1912	1535
	1	515261	69.1	18	2	1102	1794	-
	2	39025	86.9	18	3	1044	1152	1148
	3	190900	84.9	18	3	1894	1948	1118
	4	343941	72.3	18	2	1094	1916	-
	5	497624	51.7	18	1	1447	-	-
	6	20319	58.3	18	1	1429	-	-
	7	172999	60.8	18	1	1979	-	-
	8	325872	57.1	18	1	1641	-	-
	9	475841	88.9	18	3	1886	1964	1489
	10	1489	72	18	2	1909	1297	-
	11	153647	90.9	18	3	1261	1566	1370
	12	307096	59.8	18	1	1552	-	-
	13	458804	70	18	2	1759	1291	-
	14	610798	67.2	18	2	1625	1881	-
	15	134759	91.2	18	3	1382	1832	1661
	16	288306	56.5	18	1	1483	-	-
	17	441296	51.2	18	1	1237	-	-
	18	592780	74.1	18	2	1471	1245	-
15	Type 5	14	0.857143	12	5.2548			
	Burst ID	Burst Offset (μs)	Pulse Width (μs)	Chirp Width (MHz)	Number of Pulses per Burst	PRI-1 (μs)	PRI-2 (μs)	PRI-3 (μs)
	0	158286	76.9	12	2	1110	1140	-
	1	366024	50.2	12	1	1316	-	-
	2	573452	62.9	12	1	1520	-	-
	3	780619	64.7	12	1	1902	-	-
	4	132455	83.8	12	3	1410	1097	1621
	5	340207	65.4	12	1	1944	-	-
	6	548208	53.2	12	1	1024	-	-
	7	755333	51.7	12	1	1603	-	-
	8	107117	78.7	12	2	1804	1168	-
	9	314500	72.4	12	2	1030	1343	-
	10	522447	53.8	12	1	1327	-	-
	11	728517	73.6	12	2	1524	1553	-
	12	81611	66.7	12	2	1722	1122	-
	13	288948	82.5	12	2	1404	1019	-

Trial ID	Radar Type	Number of Bursts	Burst Period(s)	Wave from Length (s)	Center Frequency(GHz)	-		
16	Type 5	20	0.6	12	5.258			
	Burst ID	Burst Offset (µs)	Pulse Width (µs)	Chirp Width (MHz)	Number of Pulses per Burst	PRI-1 (µs)	PRI-2 (µs)	PRI-3 (µs)
	0	345766	87.6	20	3	1565	1055	1840
	1	490019	85.2	20	3	1735	1541	1408
	2	39073	84.8	20	3	1534	1889	1463
	3	183923	77.9	20	2	1749	1460	-
	4	328777	76.5	20	2	1518	1485	-
	5	474728	60.9	20	1	1540	-	-
	6	21394	83	20	2	1080	1010	-
	7	165992	80.4	20	2	1824	1752	-
	8	310973	67.5	20	2	1764	1181	-
	9	456884	62.1	20	1	1495	-	-
	10	3515	86.4	20	3	1773	1966	1263
	11	147928	84.3	20	3	1593	1188	1788
	12	293225	76.9	20	2	1226	1537	-
	13	436922	95.8	20	3	1192	1298	1844
	14	584015	55.2	20	1	1644	-	-
	15	130832	59	20	1	1402	-	-
	16	274684	94.5	20	3	1296	1700	1283
	17	418579	91.9	20	3	1970	1978	1165
	18	563464	85.2	20	3	1732	1551	1189
	19	112787	69.5	20	2	1038	1224	-
17	Type 5	12	1	12	5.254			
	Burst ID	Burst Offset (µs)	Pulse Width (µs)	Chirp Width (MHz)	Number of Pulses per Burst	PRI-1 (µs)	PRI-2 (µs)	PRI-3 (µs)
	0	429224	86.4	10	3	1259	1918	1455
	1	670241	92.2	10	3	1598	1719	1895
	2	912880	80.4	10	2	1816	1899	-
	3	158603	54.3	10	1	1335	-	-
	4	400824	53.1	10	1	1303	-	-
	5	641915	69.4	10	2	1503	1546	-
	6	883823	69.1	10	2	1279	1639	-
	7	128373	100	10	3	1375	1438	1595
	8	370379	79.6	10	2	1239	1705	-
	9	611194	88.4	10	3	1374	1579	1623
	10	855665	53.3	10	1	1016	-	-
	11	98897	65.3	10	1	1709	-	-

Trial ID	Radar Type	Number of Bursts	Burst Period(s)	Wave from Length (s)	Center Frequency(GHz)	-		
18	Type 5	14	0.857143	12	5.2548			
	Burst ID	Burst Offset (μs)	Pulse Width (μs)	Chirp Width (MHz)	Number of Pulses per Burst	PRI-1 (μs)	PRI-2 (μs)	PRI-3 (μs)
	0	292143	55.3	12	1	1920	-	-
	1	499633	58.3	12	1	1797	-	-
	2	706377	72.3	12	2	1610	1039	-
	3	58989	84.8	12	3	1131	1761	1721
	4	266161	82.5	12	2	1875	1431	-
	5	474469	63.3	12	1	1095	-	-
	6	680544	80	12	2	1119	1913	-
	7	33519	90.3	12	3	1660	1853	1123
	8	240319	91.1	12	3	1539	1783	1172
	9	447400	96.6	12	3	1525	1036	1385
	10	654516	82.7	12	2	1710	1990	-
	11	8083	50.7	12	1	1234	-	-
	12	215435	78.4	12	2	1047	1109	-
	13	421325	99.5	12	3	1299	1965	1869
19	Type 5	12	1	12	5.254			
	Burst ID	Burst Offset (μs)	Pulse Width (μs)	Chirp Width (MHz)	Number of Pulses per Burst	PRI-1 (μs)	PRI-2 (μs)	PRI-3 (μs)
	0	733725	88.6	10	3	1501	1067	1927
	1	977882	57.4	10	1	1723	-	-
	2	221197	96.6	10	3	1086	1658	1324
	3	462915	69.7	10	2	1751	1945	-
	4	705071	77.9	10	2	1642	1317	-
	5	947923	62	10	1	1866	-	-
	6	191373	88.4	10	3	1997	1077	1366
	7	432561	97.3	10	3	1790	1896	1367
	8	674004	96.2	10	3	1391	1787	1672
	9	915842	95.4	10	3	1020	1892	1414
	10	162176	54.8	10	1	1084	-	-
	11	403553	80.4	10	2	1850	1436	-

Trial ID	Radar Type	Number of Bursts	Burst Period(s)	Wave from Length (s)	Center Frequency(GHz)	-		
20	Type 5	16	0.75	12	5.264			
	Burst ID	Burst Offset (μs)	Pulse Width (μs)	Chirp Width (MHz)	Number of Pulses per Burst	PRI-1 (μs)	PRI-2 (μs)	PRI-3 (μs)
	0	483470	74.7	15	2	1619	1611	-
	1	666072	57.1	15	1	1560	-	-
	2	98810	91.9	15	3	1392	1475	1276
	3	279914	83.1	15	2	1809	1772	-
	4	462536	50.7	15	1	1003	-	-
	5	642324	79.2	15	2	1574	1600	-
	6	76831	58.7	15	1	1186	-	-
	7	257785	71	15	2	1521	1567	-
	8	438554	79	15	2	1777	1960	-
	9	620397	68.5	15	2	1284	1428	-
	10	54310	73.5	15	2	1904	1352	-
	11	235506	70.5	15	2	1864	1115	-
	12	417036	76.6	15	2	1045	1300	-
	13	597974	81.2	15	2	1160	1675	-
	14	32086	61.8	15	1	1277	-	-
	15	212751	94.9	15	3	1450	1206	1860
21	Type 5	12	1	12	5.2664			
	Burst ID	Burst Offset (μs)	Pulse Width (μs)	Chirp Width (MHz)	Number of Pulses per Burst	PRI-1 (μs)	PRI-2 (μs)	PRI-3 (μs)
	0	526149	78.5	9	2	1653	1698	-
	1	767135	89.8	9	3	1174	1962	1167
	2	12955	59.4	9	1	1982	-	-
	3	254612	79.6	9	2	1633	1890	-
	4	496588	76	9	2	1112	1811	-
	5	739728	53.6	9	1	1144	-	-
	6	980872	80.9	9	2	1220	1053	-
	7	225249	61.6	9	1	1724	-	-
	8	467279	53.4	9	1	1901	-	-
	9	709720	59.9	9	1	1379	-	-
	10	951847	60.4	9	1	1453	-	-
	11	194839	91.4	9	3	1768	1726	1227

Trial ID	Radar Type	Number of Bursts	Burst Period(s)	Wave from Length (s)	Center Frequency(GHz)	-		
22	Type 5	20	0.6	12	5.262			
	Burst ID	Burst Offset (µs)	Pulse Width (µs)	Chirp Width (MHz)	Number of Pulses per Burst	PRI-1 (µs)	PRI-2 (µs)	PRI-3 (µs)
	0	261858	77	20	2	1191	1363	-
	1	407646	58.1	20	1	1248	-	-
	2	552319	62.1	20	1	1836	-	-
	3	99107	76.9	20	2	1334	1236	-
	4	243514	80	20	2	1914	1852	-
	5	389464	52	20	1	1701	-	-
	6	531093	88.6	20	3	1693	1995	1905
	7	81159	72.9	20	2	1922	1387	-
	8	225245	98.5	20	3	1839	1746	1389
	9	371906	57.9	20	1	1193	-	-
	10	514197	95.9	20	3	1659	1870	1066
	11	63561	53.5	20	1	1162	-	-
	12	207510	92	20	3	1745	1654	1458
	13	353638	57.3	20	1	1834	-	-
	14	497515	70.5	20	2	1684	1586	-
	15	45553	70	20	2	1042	1664	-
	16	189821	84	20	3	1765	1630	1176
	17	335330	76.1	20	2	1557	1057	-
	18	478825	93.2	20	3	1985	1018	1340
	19	27594	96.8	20	3	1760	1614	1817
23	Type 5	14	0.857143	12	5.2652			
	Burst ID	Burst Offset (µs)	Pulse Width (µs)	Chirp Width (MHz)	Number of Pulses per Burst	PRI-1 (µs)	PRI-2 (µs)	PRI-3 (µs)
	0	247117	50.1	12	1	1841	-	-
	1	453362	93.5	12	3	1590	1081	1413
	2	660875	68.8	12	2	1707	1577	-
	3	14140	56.3	12	1	1056	-	-
	4	220734	86	12	3	1953	1108	1987
	5	428367	75.2	12	2	1572	1536	-
	6	636681	54.4	12	1	1517	-	-
	7	843157	71.1	12	2	1329	1243	-
	8	195585	76.2	12	2	1940	1770	-
	9	403231	80.2	12	2	1098	1209	-
	10	610202	79.7	12	2	1588	1214	-
	11	815229	90.9	12	3	1615	1862	1601
	12	170267	68.7	12	2	1377	1441	-
	13	377306	67.4	12	2	1872	1313	-

Trial ID	Radar Type	Number of Bursts	Burst Peried(s)	Wave from Length (s)	Center Frequency(GHz)	-		
24	Type 5	13	0.923077	12	5.2656			
	Burst ID	Burst Offset (μs)	Pulse Width (μs)	Chirp Width (MHz)	Number of Pulses per Burst	PRI-1 (μs)	PRI-2 (μs)	PRI-3 (μs)
	0	628071	94	11	3	1643	1748	1941
	1	853391	70.8	11	2	1177	1201	-
	2	156223	56.3	11	1	1006	-	-
	3	378734	96.7	11	3	1230	1163	1332
	4	601331	90.6	11	3	1217	1582	1498
	5	825462	74.5	11	2	1569	1281	-
	6	128265	92.6	11	3	1065	1669	1222
	7	351161	89	11	3	1493	1135	1380
	8	573425	96.5	11	3	1607	1822	1602
	9	798431	70.5	11	2	1141	1178	-
	10	100737	94	11	3	1009	1629	1956
	11	324661	55.8	11	1	1290	-	-
	12	546278	87.7	11	3	1435	1963	1164
25	Type 5	8	1.5	12	5.268			
	Burst ID	Burst Offset (μs)	Pulse Width (μs)	Chirp Width (MHz)	Number of Pulses per Burst	PRI-1 (μs)	PRI-2 (μs)	PRI-3 (μs)
	0	1253842	68.6	5	2	1306	1161	-
	1	119486	83.1	5	2	1420	1315	-
	2	482958	60.9	5	1	1687	-	-
	3	845641	77.7	5	2	1776	1158	-
	4	1208428	77.4	5	2	1793	1510	-
	5	74748	66.8	5	2	1576	1323	-
	6	438300	63.7	5	1	1333	-	-
	7	800152	91.2	5	3	1409	1681	1275

Trial ID	Radar Type	Number of Bursts	Burst Period(s)	Wave from Length (s)	Center Frequency(GHz)	-		
26	Type 5	17	0.705882	12	5.2636			
	Burst ID	Burst Offset (µs)	Pulse Width (µs)	Chirp Width (MHz)	Number of Pulses per Burst	PRI-1 (µs)	PRI-2 (µs)	PRI-3 (µs)
	0	545865	83.6	16	3	1632	1195	1000
	1	14067	89.4	16	3	1173	1627	1656
	2	184953	55.8	16	1	1532	-	-
	3	353759	90.9	16	3	1981	1554	1998
	4	526388	54.7	16	1	1825	-	-
	5	694806	97.7	16	3	1734	1202	1250
	6	163568	67.5	16	2	1571	1434	-
	7	333410	96.7	16	3	1589	1469	1268
	8	504006	68.3	16	2	1750	1954	-
	9	675297	78.3	16	2	1591	1082	-
	10	142890	55	16	1	1427	-	-
	11	312479	84.9	16	3	1129	1936	1199
	12	482953	74.6	16	2	1959	1856	-
	13	655022	63.3	16	1	1885	-	-
	14	121457	99.8	16	3	1035	1515	1120
	15	292606	63.6	16	1	1647	-	-
	16	461322	87.3	16	3	1931	1051	1831
27	Type 5	19	0.631579	12	5.2624			
	Burst ID	Burst Offset (µs)	Pulse Width (µs)	Chirp Width (MHz)	Number of Pulses per Burst	PRI-1 (µs)	PRI-2 (µs)	PRI-3 (µs)
	0	565136	85.6	19	3	1946	1078	1015
	1	89970	68.6	19	2	1029	1780	-
	2	243121	54.2	19	1	1111	-	-
	3	396034	61.2	19	1	1104	-	-
	4	546225	97.1	19	3	1157	1969	1100
	5	70998	98.3	19	3	1142	1699	1622
	6	224093	62.4	19	1	1655	-	-
	7	376127	80.2	19	2	1126	1769	-
	8	527806	87.5	19	3	1216	1448	1179
	9	52247	85.8	19	3	1847	1348	1472
	10	204582	88.1	19	3	1023	1124	1631
	11	357941	65.3	19	1	1848	-	-
	12	510977	52.5	19	1	1470	-	-
	13	33698	52.3	19	1	1312	-	-
	14	186023	74.1	19	2	1915	1200	-
	15	339327	54.9	19	1	1479	-	-
	16	491053	76.2	19	2	1376	1502	-
	17	14858	60.4	19	1	1758	-	-
	18	167387	81.5	19	2	1491	1103	-

Trial ID	Radar Type	Number of Bursts	Burst Peried(s)	Wave from Length (s)	Center Frequency(GHz)	-		
28	Type 5	12	1	12	5.266			
	Burst ID	Burst Offset (μs)	Pulse Width (μs)	Chirp Width (MHz)	Number of Pulses per Burst	PRI-1 (μs)	PRI-2 (μs)	PRI-3 (μs)
	0	507709	50.5	10	1	1857	-	-
	1	750249	55.7	10	1	1246	-	-
	2	989003	85.8	10	3	1774	1002	1967
	3	235634	76.9	10	2	1125	1474	-
	4	477675	75.1	10	2	1254	1052	-
	5	718312	92.3	10	3	1180	1486	1492
	6	960895	78.1	10	2	1301	1757	-
	7	205370	92.2	10	3	1898	1252	1713
	8	446940	89	10	3	1260	1706	1411
	9	689225	70.9	10	2	1578	1620	-
	10	932305	63.1	10	1	1782	-	-
	11	176231	55.3	10	1	1522	-	-
29	Type 5	18	0.666667	12	5.2632			
	Burst ID	Burst Offset (μs)	Pulse Width (μs)	Chirp Width (MHz)	Number of Pulses per Burst	PRI-1 (μs)	PRI-2 (μs)	PRI-3 (μs)
	0	277485	83.4	17	3	1454	1205	1801
	1	437880	97.3	17	3	1319	1826	1635
	2	598445	90.4	17	3	1079	1986	1674
	3	97088	91.8	17	3	1563	1151	1802
	4	257251	98.2	17	3	1876	1977	1766
	5	419893	59.5	17	1	1952	-	-
	6	580724	80	17	2	1253	1137	-
	7	77366	86.5	17	3	1054	1128	1828
	8	238032	91.1	17	3	1105	1599	1442
	9	398605	93.5	17	3	1867	1373	1087
	10	562025	60.7	17	1	1033	-	-
	11	57684	67.2	17	2	1288	1405	-
	12	219083	61.8	17	1	1585	-	-
	13	379234	79.4	17	2	1933	1667	-
	14	540896	81.4	17	2	1096	1464	-
	15	37916	65.7	17	1	1496	-	-
	16	198794	76	17	2	1733	1255	-
	17	359754	81	17	2	1326	1668	-

Radar Signal 5_5270 MHz

Trial ID	Radar Type	Number of Bursts	Burst Period(s)	Wave from Length (s)	Center Frequency(GHz)	-		
0	Type 5	15	0.8	12	5.27	-		
	Burst ID	Burst Offset (μs)	Pulse Width (μs)	Chirp Width (MHz)	Number of Pulses per Burst	PRI-1 (μs)	PRI-2 (μs)	PRI-3 (μs)
	0	636185	77.8	13	2	1665	1477	-
	1	32674	51.9	13	1	1074	-	-
	2	226294	63.8	13	1	1584	-	-
	3	417976	96.6	13	3	1682	1786	1843
	4	611152	85.9	13	3	1795	1215	1729
	5	8789	73.7	13	2	1198	1549	-
	6	201917	77.2	13	2	1837	1819	-
	7	395530	68.4	13	2	1587	1114	-
	8	588564	76.7	13	2	2000	1155	-
	9	783794	53.2	13	1	1147	-	-
	10	177933	85.7	13	3	1433	1695	1394
	11	370624	94.3	13	3	1670	1426	1935
	12	564893	77.6	13	2	1294	1671	-
	13	759583	65.7	13	1	1512	-	-
	14	154262	93.5	13	3	1444	1130	1468
1	Type 5	8	1.5	12	5.27			
	Burst ID	Burst Offset (μs)	Pulse Width (μs)	Chirp Width (MHz)	Number of Pulses per Burst	PRI-1 (μs)	PRI-2 (μs)	PRI-3 (μs)
	0	653020	75	5	2	1880	1527	-
	1	1015643	99.4	5	3	1401	1262	1257
	2	1379398	67.4	5	2	1531	1403	-
	3	245489	73.6	5	2	1449	1041	-
	4	609113	65.9	5	1	1432	-	-
	5	970852	83.8	5	3	1356	1292	1419
	6	1335913	65.5	5	1	1543	-	-
	7	200406	98.6	5	3	1548	1796	1728

Trial ID	Radar Type	Number of Bursts	Burst Period(s)	Wave from Length (s)	Center Frequency(GHz)	-		
2	Type 5	11	1.090909	12	5.27			
	Burst ID	Burst Offset (μs)	Pulse Width (μs)	Chirp Width (MHz)	Number of Pulses per Burst	PRI-1 (μs)	PRI-2 (μs)	PRI-3 (μs)
	0	409565	73.8	9	2	1806	1538	-
	1	673692	69.5	9	2	1117	1649	-
	2	938562	51.9	9	1	1651	-	-
	3	113209	84.6	9	3	1976	1032	1271
	4	376726	95.4	9	3	1060	1903	1388
	5	641212	68	9	2	1368	1351	-
	6	903714	89.6	9	3	1338	1514	1573
	7	80863	81.9	9	2	1022	1689	-
	8	344067	88.3	9	3	1810	1330	1838
	9	609331	53.7	9	1	1597	-	-
	10	871542	91.3	9	3	1961	1106	1001
3	Type 5	20	0.6	12	5.27			
	Burst ID	Burst Offset (μs)	Pulse Width (μs)	Chirp Width (MHz)	Number of Pulses per Burst	PRI-1 (μs)	PRI-2 (μs)	PRI-3 (μs)
	0	26541	68.1	19	2	1339	1355	-
	1	171821	58.7	19	1	1251	-	-
	2	316229	75.3	19	2	1136	1640	-
	3	461864	56.4	19	1	1753	-	-
	4	8677	99.7	19	3	1196	1708	1159
	5	153995	57.7	19	1	1013	-	-
	6	299238	59.5	19	1	1072	-	-
	7	443177	80	19	2	1482	1369	-
	8	587671	82	19	2	1993	1197	-
	9	135674	82.8	19	2	1883	1005	-
	10	279928	88	19	3	1061	1928	1101
	11	424279	93.2	19	3	1207	1907	1223
	12	570132	70.4	19	2	1526	1360	-
	13	117439	95.3	19	3	1171	1955	1775
	14	262502	81.9	19	2	1690	1545	-
	15	406573	98.5	19	3	1975	1169	1062
	16	553328	65	19	1	1767	-	-
	17	99799	85.4	19	3	1011	1637	1425
	18	244095	91.6	19	3	1878	1445	1325
	19	390012	67.3	19	2	1091	1218	-

Trial ID	Radar Type	Number of Bursts	Burst Period(s)	Wave from Length (s)	Center Frequency(GHz)	-		
4	Type 5	17	0.705882	12	5.27			
	Burst ID	Burst Offset (µs)	Pulse Width (µs)	Chirp Width (MHz)	Number of Pulses per Burst	PRI-1 (µs)	PRI-2 (µs)	PRI-3 (µs)
	0	629614	67.9	16	2	1320	1133	-
	1	96856	62.3	16	1	1957	-	-
	2	267719	53.3	16	1	1592	-	-
	3	436784	90	16	3	1900	1153	1346
	4	608289	77.1	16	2	1166	1646	-
	5	75610	83.9	16	3	1278	1232	1459
	6	245638	89.1	16	3	1240	1384	1939
	7	416355	81.8	16	2	1833	1676	-
	8	588736	50.3	16	1	1075	-	-
	9	54571	87.1	16	3	1116	1996	1756
	10	225175	71.3	16	2	1225	1815	-
	11	394825	97.5	16	3	1884	1465	1132
	12	565361	90.6	16	3	1561	1040	1354
	13	33643	86.3	16	3	1596	1183	1792
	14	203957	97.6	16	3	1365	1073	1361
	15	373812	84.7	16	3	1021	1718	1854
	16	544060	99.7	16	3	1150	1244	1988
5	Type 5	14	0.857143	12	5.27			
	Burst ID	Burst Offset (µs)	Pulse Width (µs)	Chirp Width (MHz)	Number of Pulses per Burst	PRI-1 (µs)	PRI-2 (µs)	PRI-3 (µs)
	0	15438	92.9	12	3	1085	1564	1407
	1	222486	67.7	12	2	1744	1747	-
	2	430731	65.8	12	1	1092	-	-
	3	637784	56.3	12	1	1851	-	-
	4	845342	53.7	12	1	1727	-	-
	5	196720	83.5	12	3	1679	1930	1025
	6	404955	65.8	12	1	1519	-	-
	7	610711	85.9	12	3	1134	1034	1808
	8	818057	76.3	12	2	1606	1926	-
	9	171459	81.5	12	2	1891	1714	-
	10	377969	89.4	12	3	1310	1594	1827
	11	586875	63.4	12	1	1568	-	-
	12	792834	69.6	12	2	1307	1925	-
	13	146044	74.5	12	2	1264	1846	-

Trial ID	Radar Type	Number of Bursts	Burst Peried(s)	Wave from Length (s)	Center Frequency(GHz)	-		
6	Type 5	15	0.8	12	5.27			
	Burst ID	Burst Offset (µs)	Pulse Width (µs)	Chirp Width (MHz)	Number of Pulses per Burst	PRI-1 (µs)	PRI-2 (µs)	PRI-3 (µs)
	0	329022	96.6	13	3	1182	1609	1581
	1	521718	96.7	13	3	1829	1799	1154
	2	714222	86.5	13	3	1923	1396	1865
	3	112450	73.3	13	2	1908	1318	-
	4	306283	55.8	13	1	1688	-	-
	5	500239	55.4	13	1	1145	-	-
	6	690932	85.3	13	3	1336	1504	1820
	7	88645	79.4	13	2	1344	1893	-
	8	282508	65.7	13	1	1476	-	-
	9	475842	68.6	13	2	1008	1028	-
	10	667887	77.7	13	2	1972	1835	-
	11	64845	79.6	13	2	1882	1331	-
	12	257755	94.9	13	3	1830	1070	1349
	13	452335	61.4	13	1	1451	-	-
	14	643395	90.6	13	3	1233	1562	1887
7	Type 5	12	1	12	5.27			
	Burst ID	Burst Offset (µs)	Pulse Width (µs)	Chirp Width (MHz)	Number of Pulses per Burst	PRI-1 (µs)	PRI-2 (µs)	PRI-3 (µs)
	0	51446	52.6	10	1	1210	-	-
	1	292696	84.1	10	3	1314	1725	1529
	2	533989	97.7	10	3	1139	1868	1805
	3	775564	97.3	10	3	1341	1446	1755
	4	21542	98.8	10	3	1544	1386	1302
	5	263385	72.2	10	2	1771	1184	-
	6	505581	67.6	10	2	1175	1027	-
	7	747058	75.7	10	2	1026	1871	-
	8	989976	60.9	10	1	1798	-	-
	9	234024	64.2	10	1	1138	-	-
	10	475207	78.8	10	2	1784	1604	-
	11	715825	87.5	10	3	1511	1712	1683

Trial ID	Radar Type	Number of Bursts	Burst Period(s)	Wave from Length (s)	Center Frequency(GHz)	-		
8	Type 5	14	0.857143	12	5.27			
	Burst ID	Burst Offset (μs)	Pulse Width (μs)	Chirp Width (MHz)	Number of Pulses per Burst	PRI-1 (μs)	PRI-2 (μs)	PRI-3 (μs)
	0	823112	54.1	13	1	1415	-	-
	1	174965	50.7	13	1	1221	-	-
	2	382216	52.3	13	1	1974	-	-
	3	587395	99.8	13	3	1558	1696	1949
	4	796897	68.4	13	2	1014	1099	-
	5	149042	80.8	13	2	1736	1505	-
	6	356750	62.5	13	1	1778	-	-
	7	563824	74.8	13	2	1149	1204	-
	8	772314	50.8	13	1	1049	-	-
	9	123796	54	13	1	1417	-	-
	10	331215	63	13	1	1730	-	-
	11	537402	91.8	13	3	1143	1270	1347
	12	744805	79.3	13	2	1274	1992	-
	13	98172	64.3	13	1	1937	-	-
9	Type 5	8	1.5	12	5.27			
	Burst ID	Burst Offset (μs)	Pulse Width (μs)	Chirp Width (MHz)	Number of Pulses per Burst	PRI-1 (μs)	PRI-2 (μs)	PRI-3 (μs)
	0	535615	63.4	6	1	1043	-	-
	1	898668	52	6	1	1863	-	-
	2	1259235	97.2	6	3	1973	1605	1583
	3	127106	78.7	6	2	1466	1743	-
	4	490358	74.2	6	2	1280	1219	-
	5	852409	88.7	6	3	1293	1934	1273
	6	1217152	54.3	6	1	1991	-	-
	7	82296	95.4	6	3	1580	1555	1791

Trial ID	Radar Type	Number of Bursts	Burst Period(s)	Wave from Length (s)	Center Frequency(GHz)	-		
10	Type 5	17	0.705882	12	5.2564			
	Burst ID	Burst Offset (μs)	Pulse Width (μs)	Chirp Width (MHz)	Number of Pulses per Burst	PRI-1 (μs)	PRI-2 (μs)	PRI-3 (μs)
	0	209249	73.7	16	2	1208	1497	-
	1	378386	97.4	16	3	1942	1754	1613
	2	548411	91.7	16	3	1999	1702	1462
	3	17733	66.2	16	1	1393	-	-
	4	187952	70.8	16	2	1968	1821	-
	5	359277	52.3	16	1	1740	-	-
	6	528886	78.9	16	2	1308	1984	-
	7	700166	70.9	16	2	1050	1358	-
	8	167197	75.6	16	2	1437	1430	-
	9	338262	59.1	16	1	1697	-	-
	10	508324	77	16	2	1397	1304	-
	11	678689	67.9	16	2	1803	1083	-
	12	146031	81.2	16	2	1720	1932	-
	13	316923	78.7	16	2	1247	1121	-
	14	488056	63.3	16	1	1634	-	-
	15	657326	68.9	16	2	1849	1423	-
	16	125509	59.3	16	1	1093	-	-
11	Type 5	19	0.631579	12	5.2576			
	Burst ID	Burst Offset (μs)	Pulse Width (μs)	Chirp Width (MHz)	Number of Pulses per Burst	PRI-1 (μs)	PRI-2 (μs)	PRI-3 (μs)
	0	263736	98.9	19	3	1381	1680	1488
	1	416459	82.3	19	2	1716	1855	-
	2	567902	86.7	19	3	1211	1400	1919
	3	92979	89.7	19	3	1861	1068	1282
	4	245155	98.6	19	3	1507	1194	1461
	5	397609	71.1	19	2	1921	1789	-
	6	551431	55.9	19	1	1947	-	-
	7	74413	67.9	19	2	1350	1372	-
	8	226559	84.4	19	3	1203	1107	1443
	9	380056	58.8	19	1	1715	-	-
	10	533408	65.6	19	1	1017	-	-
	11	55547	78.5	19	2	1911	1704	-
	12	207876	82.3	19	2	1845	1686	-
	13	359771	90.1	19	3	1938	1071	1266
	14	511297	90.2	19	3	1989	1089	1950
	15	36803	83.1	19	2	1943	1406	-
	16	189652	58.8	19	1	1742	-	-
	17	341809	77	19	2	1187	1657	-
	18	495737	55	19	1	1012	-	-

Trial ID	Radar Type	Number of Bursts	Burst Period(s)	Wave from Length (s)	Center Frequency(GHz)	-		
12	Type 5	15	0.8	12	5.2552			
	Burst ID	Burst Offset (μs)	Pulse Width (μs)	Chirp Width (MHz)	Number of Pulses per Burst	PRI-1 (μs)	PRI-2 (μs)	PRI-3 (μs)
	0	22911	58.1	13	1	1929	-	-
	1	216473	52.1	13	1	1910	-	-
	2	410004	59.9	13	1	1971	-	-
	3	603671	60.2	13	1	1812	-	-
	4	794160	95.9	13	3	1399	1906	1608
	5	192251	79.9	13	2	1626	1859	-
	6	385590	78.5	13	2	1238	1917	-
	7	579862	53.8	13	1	1763	-	-
	8	773423	64.7	13	1	1800	-	-
	9	168898	61.4	13	1	1390	-	-
	10	361606	83.2	13	2	1692	1858	-
	11	553866	84.7	13	3	1533	1677	1638
	12	747241	88.7	13	3	1703	1528	1058
	13	144710	78.3	13	2	1258	1951	-
	14	337856	69.3	13	2	1731	1717	-
13	Type 5	12	1	12	5.254			
	Burst ID	Burst Offset (μs)	Pulse Width (μs)	Chirp Width (MHz)	Number of Pulses per Burst	PRI-1 (μs)	PRI-2 (μs)	PRI-3 (μs)
	0	664275	75.3	10	2	1994	1612	-
	1	907886	56.3	10	1	1456	-	-
	2	151316	67.7	10	2	1617	1185	-
	3	393746	55.6	10	1	1337	-	-
	4	635093	75.2	10	2	1421	1267	-
	5	876993	76.3	10	2	1359	1305	-
	6	121278	85.7	10	3	1547	1362	1924
	7	362696	98.4	10	3	1873	1550	1249
	8	604342	86.4	10	3	1779	1439	1046
	9	846453	93.6	10	3	1059	1031	1452
	10	91871	63.3	10	1	1328	-	-
	11	333050	92.4	10	3	1412	1673	1322

Trial ID	Radar Type	Number of Bursts	Burst Period(s)	Wave from Length (s)	Center Frequency(GHz)	-		
14	Type 5	19	0.631579	12	5.2572			
	Burst ID	Burst Offset (µs)	Pulse Width (µs)	Chirp Width (MHz)	Number of Pulses per Burst	PRI-1 (µs)	PRI-2 (µs)	PRI-3 (µs)
	0	361323	93.3	18	3	1983	1912	1535
	1	515261	69.1	18	2	1102	1794	-
	2	39025	86.9	18	3	1044	1152	1148
	3	190900	84.9	18	3	1894	1948	1118
	4	343941	72.3	18	2	1094	1916	-
	5	497624	51.7	18	1	1447	-	-
	6	20319	58.3	18	1	1429	-	-
	7	172999	60.8	18	1	1979	-	-
	8	325872	57.1	18	1	1641	-	-
	9	475841	88.9	18	3	1886	1964	1489
	10	1489	72	18	2	1909	1297	-
	11	153647	90.9	18	3	1261	1566	1370
	12	307096	59.8	18	1	1552	-	-
	13	458804	70	18	2	1759	1291	-
	14	610798	67.2	18	2	1625	1881	-
	15	134759	91.2	18	3	1382	1832	1661
	16	288306	56.5	18	1	1483	-	-
	17	441296	51.2	18	1	1237	-	-
	18	592780	74.1	18	2	1471	1245	-
15	Type 5	14	0.857143	12	5.2548			
	Burst ID	Burst Offset (µs)	Pulse Width (µs)	Chirp Width (MHz)	Number of Pulses per Burst	PRI-1 (µs)	PRI-2 (µs)	PRI-3 (µs)
	0	158286	76.9	12	2	1110	1140	-
	1	366024	50.2	12	1	1316	-	-
	2	573452	62.9	12	1	1520	-	-
	3	780619	64.7	12	1	1902	-	-
	4	132455	83.8	12	3	1410	1097	1621
	5	340207	65.4	12	1	1944	-	-
	6	548208	53.2	12	1	1024	-	-
	7	755333	51.7	12	1	1603	-	-
	8	107117	78.7	12	2	1804	1168	-
	9	314500	72.4	12	2	1030	1343	-
	10	522447	53.8	12	1	1327	-	-
	11	728517	73.6	12	2	1524	1553	-
	12	81611	66.7	12	2	1722	1122	-
	13	288948	82.5	12	2	1404	1019	-

Trial ID	Radar Type	Number of Bursts	Burst Period(s)	Wave from Length (s)	Center Frequency(GHz)	-		
16	Type 5	20	0.6	12	5.258			
	Burst ID	Burst Offset (μs)	Pulse Width (μs)	Chirp Width (MHz)	Number of Pulses per Burst	PRI-1 (μs)	PRI-2 (μs)	PRI-3 (μs)
	0	345766	87.6	20	3	1565	1055	1840
	1	490019	85.2	20	3	1735	1541	1408
	2	39073	84.8	20	3	1534	1889	1463
	3	183923	77.9	20	2	1749	1460	-
	4	328777	76.5	20	2	1518	1485	-
	5	474728	60.9	20	1	1540	-	-
	6	21394	83	20	2	1080	1010	-
	7	165992	80.4	20	2	1824	1752	-
	8	310973	67.5	20	2	1764	1181	-
	9	456884	62.1	20	1	1495	-	-
	10	3515	86.4	20	3	1773	1966	1263
	11	147928	84.3	20	3	1593	1188	1788
	12	293225	76.9	20	2	1226	1537	-
	13	436922	95.8	20	3	1192	1298	1844
	14	584015	55.2	20	1	1644	-	-
	15	130832	59	20	1	1402	-	-
	16	274684	94.5	20	3	1296	1700	1283
	17	418579	91.9	20	3	1970	1978	1165
	18	563464	85.2	20	3	1732	1551	1189
	19	112787	69.5	20	2	1038	1224	-
17	Type 5	12	1	12	5.254			
	Burst ID	Burst Offset (μs)	Pulse Width (μs)	Chirp Width (MHz)	Number of Pulses per Burst	PRI-1 (μs)	PRI-2 (μs)	PRI-3 (μs)
	0	429224	86.4	10	3	1259	1918	1455
	1	670241	92.2	10	3	1598	1719	1895
	2	912880	80.4	10	2	1816	1899	-
	3	158603	54.3	10	1	1335	-	-
	4	400824	53.1	10	1	1303	-	-
	5	641915	69.4	10	2	1503	1546	-
	6	883823	69.1	10	2	1279	1639	-
	7	128373	100	10	3	1375	1438	1595
	8	370379	79.6	10	2	1239	1705	-
	9	611194	88.4	10	3	1374	1579	1623
	10	855665	53.3	10	1	1016	-	-
	11	98897	65.3	10	1	1709	-	-

Trial ID	Radar Type	Number of Bursts	Burst Period(s)	Wave from Length (s)	Center Frequency(GHz)	-		
18	Type 5	14	0.857143	12	5.2548			
	Burst ID	Burst Offset (μs)	Pulse Width (μs)	Chirp Width (MHz)	Number of Pulses per Burst	PRI-1 (μs)	PRI-2 (μs)	PRI-3 (μs)
	0	292143	55.3	12	1	1920	-	-
	1	499633	58.3	12	1	1797	-	-
	2	706377	72.3	12	2	1610	1039	-
	3	58989	84.8	12	3	1131	1761	1721
	4	266161	82.5	12	2	1875	1431	-
	5	474469	63.3	12	1	1095	-	-
	6	680544	80	12	2	1119	1913	-
	7	33519	90.3	12	3	1660	1853	1123
	8	240319	91.1	12	3	1539	1783	1172
	9	447400	96.6	12	3	1525	1036	1385
	10	654516	82.7	12	2	1710	1990	-
	11	8083	50.7	12	1	1234	-	-
	12	215435	78.4	12	2	1047	1109	-
	13	421325	99.5	12	3	1299	1965	1869
19	Type 5	12	1	12	5.254			
	Burst ID	Burst Offset (μs)	Pulse Width (μs)	Chirp Width (MHz)	Number of Pulses per Burst	PRI-1 (μs)	PRI-2 (μs)	PRI-3 (μs)
	0	733725	88.6	10	3	1501	1067	1927
	1	977882	57.4	10	1	1723	-	-
	2	221197	96.6	10	3	1086	1658	1324
	3	462915	69.7	10	2	1751	1945	-
	4	705071	77.9	10	2	1642	1317	-
	5	947923	62	10	1	1866	-	-
	6	191373	88.4	10	3	1997	1077	1366
	7	432561	97.3	10	3	1790	1896	1367
	8	674004	96.2	10	3	1391	1787	1672
	9	915842	95.4	10	3	1020	1892	1414
	10	162176	54.8	10	1	1084	-	-
	11	403553	80.4	10	2	1850	1436	-

Trial ID	Radar Type	Number of Bursts	Burst Period(s)	Wave from Length (s)	Center Frequency(GHz)	-		
20	Type 5	16	0.75	12	5.284			
	Burst ID	Burst Offset (μs)	Pulse Width (μs)	Chirp Width (MHz)	Number of Pulses per Burst	PRI-1 (μs)	PRI-2 (μs)	PRI-3 (μs)
	0	483470	74.7	15	2	1619	1611	-
	1	666072	57.1	15	1	1560	-	-
	2	98810	91.9	15	3	1392	1475	1276
	3	279914	83.1	15	2	1809	1772	-
	4	462536	50.7	15	1	1003	-	-
	5	642324	79.2	15	2	1574	1600	-
	6	76831	58.7	15	1	1186	-	-
	7	257785	71	15	2	1521	1567	-
	8	438554	79	15	2	1777	1960	-
	9	620397	68.5	15	2	1284	1428	-
	10	54310	73.5	15	2	1904	1352	-
	11	235506	70.5	15	2	1864	1115	-
	12	417036	76.6	15	2	1045	1300	-
	13	597974	81.2	15	2	1160	1675	-
	14	32086	61.8	15	1	1277	-	-
	15	212751	94.9	15	3	1450	1206	1860
21	Type 5	12	1	12	5.2864			
	Burst ID	Burst Offset (μs)	Pulse Width (μs)	Chirp Width (MHz)	Number of Pulses per Burst	PRI-1 (μs)	PRI-2 (μs)	PRI-3 (μs)
	0	526149	78.5	9	2	1653	1698	-
	1	767135	89.8	9	3	1174	1962	1167
	2	12955	59.4	9	1	1982	-	-
	3	254612	79.6	9	2	1633	1890	-
	4	496588	76	9	2	1112	1811	-
	5	739728	53.6	9	1	1144	-	-
	6	980872	80.9	9	2	1220	1053	-
	7	225249	61.6	9	1	1724	-	-
	8	467279	53.4	9	1	1901	-	-
	9	709720	59.9	9	1	1379	-	-
	10	951847	60.4	9	1	1453	-	-
	11	194839	91.4	9	3	1768	1726	1227

Trial ID	Radar Type	Number of Bursts	Burst Period(s)	Wave from Length (s)	Center Frequency(GHz)	-		
22	Type 5	20	0.6	12	5.282			
	Burst ID	Burst Offset (µs)	Pulse Width (µs)	Chirp Width (MHz)	Number of Pulses per Burst	PRI-1 (µs)	PRI-2 (µs)	PRI-3 (µs)
	0	261858	77	20	2	1191	1363	-
	1	407646	58.1	20	1	1248	-	-
	2	552319	62.1	20	1	1836	-	-
	3	99107	76.9	20	2	1334	1236	-
	4	243514	80	20	2	1914	1852	-
	5	389464	52	20	1	1701	-	-
	6	531093	88.6	20	3	1693	1995	1905
	7	81159	72.9	20	2	1922	1387	-
	8	225245	98.5	20	3	1839	1746	1389
	9	371906	57.9	20	1	1193	-	-
	10	514197	95.9	20	3	1659	1870	1066
	11	63561	53.5	20	1	1162	-	-
	12	207510	92	20	3	1745	1654	1458
	13	353638	57.3	20	1	1834	-	-
	14	497515	70.5	20	2	1684	1586	-
	15	45553	70	20	2	1042	1664	-
	16	189821	84	20	3	1765	1630	1176
	17	335330	76.1	20	2	1557	1057	-
	18	478825	93.2	20	3	1985	1018	1340
	19	27594	96.8	20	3	1760	1614	1817
23	Type 5	14	0.857143	12	5.2852			
	Burst ID	Burst Offset (µs)	Pulse Width (µs)	Chirp Width (MHz)	Number of Pulses per Burst	PRI-1 (µs)	PRI-2 (µs)	PRI-3 (µs)
	0	247117	50.1	12	1	1841	-	-
	1	453362	93.5	12	3	1590	1081	1413
	2	660875	68.8	12	2	1707	1577	-
	3	14140	56.3	12	1	1056	-	-
	4	220734	86	12	3	1953	1108	1987
	5	428367	75.2	12	2	1572	1536	-
	6	636681	54.4	12	1	1517	-	-
	7	843157	71.1	12	2	1329	1243	-
	8	195585	76.2	12	2	1940	1770	-
	9	403231	80.2	12	2	1098	1209	-
	10	610202	79.7	12	2	1588	1214	-
	11	815229	90.9	12	3	1615	1862	1601
	12	170267	68.7	12	2	1377	1441	-
	13	377306	67.4	12	2	1872	1313	-

Trial ID	Radar Type	Number of Bursts	Burst Peried(s)	Wave from Length (s)	Center Frequency(GHz)	-		
24	Type 5	13	0.923077	12	5.2856			
	Burst ID	Burst Offset (μs)	Pulse Width (μs)	Chirp Width (MHz)	Number of Pulses per Burst	PRI-1 (μs)	PRI-2 (μs)	PRI-3 (μs)
	0	628071	94	11	3	1643	1748	1941
	1	853391	70.8	11	2	1177	1201	-
	2	156223	56.3	11	1	1006	-	-
	3	378734	96.7	11	3	1230	1163	1332
	4	601331	90.6	11	3	1217	1582	1498
	5	825462	74.5	11	2	1569	1281	-
	6	128265	92.6	11	3	1065	1669	1222
	7	351161	89	11	3	1493	1135	1380
	8	573425	96.5	11	3	1607	1822	1602
	9	798431	70.5	11	2	1141	1178	-
	10	100737	94	11	3	1009	1629	1956
	11	324661	55.8	11	1	1290	-	-
	12	546278	87.7	11	3	1435	1963	1164
25	Type 5	8	1.5	12	5.288			
	Burst ID	Burst Offset (μs)	Pulse Width (μs)	Chirp Width (MHz)	Number of Pulses per Burst	PRI-1 (μs)	PRI-2 (μs)	PRI-3 (μs)
	0	1253842	68.6	5	2	1306	1161	-
	1	119486	83.1	5	2	1420	1315	-
	2	482958	60.9	5	1	1687	-	-
	3	845641	77.7	5	2	1776	1158	-
	4	1208428	77.4	5	2	1793	1510	-
	5	74748	66.8	5	2	1576	1323	-
	6	438300	63.7	5	1	1333	-	-
	7	800152	91.2	5	3	1409	1681	1275

Trial ID	Radar Type	Number of Bursts	Burst Period(s)	Wave from Length (s)	Center Frequency(GHz)	-		
26	Type 5	17	0.705882	12	5.2836			
	Burst ID	Burst Offset (μs)	Pulse Width (μs)	Chirp Width (MHz)	Number of Pulses per Burst	PRI-1 (μs)	PRI-2 (μs)	PRI-3 (μs)
	0	545865	83.6	16	3	1632	1195	1000
	1	14067	89.4	16	3	1173	1627	1656
	2	184953	55.8	16	1	1532	-	-
	3	353759	90.9	16	3	1981	1554	1998
	4	526388	54.7	16	1	1825	-	-
	5	694806	97.7	16	3	1734	1202	1250
	6	163568	67.5	16	2	1571	1434	-
	7	333410	96.7	16	3	1589	1469	1268
	8	504006	68.3	16	2	1750	1954	-
	9	675297	78.3	16	2	1591	1082	-
	10	142890	55	16	1	1427	-	-
	11	312479	84.9	16	3	1129	1936	1199
	12	482953	74.6	16	2	1959	1856	-
	13	655022	63.3	16	1	1885	-	-
	14	121457	99.8	16	3	1035	1515	1120
	15	292606	63.6	16	1	1647	-	-
	16	461322	87.3	16	3	1931	1051	1831
27	Type 5	19	0.631579	12	5.2824			
	Burst ID	Burst Offset (μs)	Pulse Width (μs)	Chirp Width (MHz)	Number of Pulses per Burst	PRI-1 (μs)	PRI-2 (μs)	PRI-3 (μs)
	0	565136	85.6	19	3	1946	1078	1015
	1	89970	68.6	19	2	1029	1780	-
	2	243121	54.2	19	1	1111	-	-
	3	396034	61.2	19	1	1104	-	-
	4	546225	97.1	19	3	1157	1969	1100
	5	70998	98.3	19	3	1142	1699	1622
	6	224093	62.4	19	1	1655	-	-
	7	376127	80.2	19	2	1126	1769	-
	8	527806	87.5	19	3	1216	1448	1179
	9	52247	85.8	19	3	1847	1348	1472
	10	204582	88.1	19	3	1023	1124	1631
	11	357941	65.3	19	1	1848	-	-
	12	510977	52.5	19	1	1470	-	-
	13	33698	52.3	19	1	1312	-	-
	14	186023	74.1	19	2	1915	1200	-
	15	339327	54.9	19	1	1479	-	-
	16	491053	76.2	19	2	1376	1502	-
	17	14858	60.4	19	1	1758	-	-
	18	167387	81.5	19	2	1491	1103	-

Trial ID	Radar Type	Number of Bursts	Burst Peried(s)	Wave from Length (s)	Center Frequency(GHz)	-		
28	Type 5	12	1	12	5.286			
	Burst ID	Burst Offset (μs)	Pulse Width (μs)	Chirp Width (MHz)	Number of Pulses per Burst	PRI-1 (μs)	PRI-2 (μs)	PRI-3 (μs)
	0	507709	50.5	10	1	1857	-	-
	1	750249	55.7	10	1	1246	-	-
	2	989003	85.8	10	3	1774	1002	1967
	3	235634	76.9	10	2	1125	1474	-
	4	477675	75.1	10	2	1254	1052	-
	5	718312	92.3	10	3	1180	1486	1492
	6	960895	78.1	10	2	1301	1757	-
	7	205370	92.2	10	3	1898	1252	1713
	8	446940	89	10	3	1260	1706	1411
	9	689225	70.9	10	2	1578	1620	-
	10	932305	63.1	10	1	1782	-	-
	11	176231	55.3	10	1	1522	-	-
29	Type 5	18	0.666667	12	5.2832			
	Burst ID	Burst Offset (μs)	Pulse Width (μs)	Chirp Width (MHz)	Number of Pulses per Burst	PRI-1 (μs)	PRI-2 (μs)	PRI-3 (μs)
	0	277485	83.4	17	3	1454	1205	1801
	1	437880	97.3	17	3	1319	1826	1635
	2	598445	90.4	17	3	1079	1986	1674
	3	97088	91.8	17	3	1563	1151	1802
	4	257251	98.2	17	3	1876	1977	1766
	5	419893	59.5	17	1	1952	-	-
	6	580724	80	17	2	1253	1137	-
	7	77366	86.5	17	3	1054	1128	1828
	8	238032	91.1	17	3	1105	1599	1442
	9	398605	93.5	17	3	1867	1373	1087
	10	562025	60.7	17	1	1033	-	-
	11	57684	67.2	17	2	1288	1405	-
	12	219083	61.8	17	1	1585	-	-
	13	379234	79.4	17	2	1933	1667	-
	14	540896	81.4	17	2	1096	1464	-
	15	37916	65.7	17	1	1496	-	-
	16	198794	76	17	2	1733	1255	-
	17	359754	81	17	2	1326	1668	-

Radar Signal 5_5320 MHz

Trial ID	Radar Type	Number of Bursts	Burst Period(s)	Wave from Length (s)	Center Frequency(GHz)	-		
0	Type 5	15	0.8	12	5.32	-		
	Burst ID	Burst Offset (μs)	Pulse Width (μs)	Chirp Width (MHz)	Number of Pulses per Burst	PRI-1 (μs)	PRI-2 (μs)	PRI-3 (μs)
	0	636185	77.8	13	2	1665	1477	-
	1	32674	51.9	13	1	1074	-	-
	2	226294	63.8	13	1	1584	-	-
	3	417976	96.6	13	3	1682	1786	1843
	4	611152	85.9	13	3	1795	1215	1729
	5	8789	73.7	13	2	1198	1549	-
	6	201917	77.2	13	2	1837	1819	-
	7	395530	68.4	13	2	1587	1114	-
	8	588564	76.7	13	2	2000	1155	-
	9	783794	53.2	13	1	1147	-	-
	10	177933	85.7	13	3	1433	1695	1394
	11	370624	94.3	13	3	1670	1426	1935
	12	564893	77.6	13	2	1294	1671	-
	13	759583	65.7	13	1	1512	-	-
	14	154262	93.5	13	3	1444	1130	1468
1	Type 5	8	1.5	12	5.32			
	Burst ID	Burst Offset (μs)	Pulse Width (μs)	Chirp Width (MHz)	Number of Pulses per Burst	PRI-1 (μs)	PRI-2 (μs)	PRI-3 (μs)
	0	653020	75	5	2	1880	1527	-
	1	1015643	99.4	5	3	1401	1262	1257
	2	1379398	67.4	5	2	1531	1403	-
	3	245489	73.6	5	2	1449	1041	-
	4	609113	65.9	5	1	1432	-	-
	5	970852	83.8	5	3	1356	1292	1419
	6	1335913	65.5	5	1	1543	-	-
	7	200406	98.6	5	3	1548	1796	1728

Trial ID	Radar Type	Number of Bursts	Burst Period(s)	Wave from Length (s)	Center Frequency(GHz)	-		
2	Type 5	11	1.090909	12	5.32			
	Burst ID	Burst Offset (μs)	Pulse Width (μs)	Chirp Width (MHz)	Number of Pulses per Burst	PRI-1 (μs)	PRI-2 (μs)	PRI-3 (μs)
	0	409565	73.8	9	2	1806	1538	-
	1	673692	69.5	9	2	1117	1649	-
	2	938562	51.9	9	1	1651	-	-
	3	113209	84.6	9	3	1976	1032	1271
	4	376726	95.4	9	3	1060	1903	1388
	5	641212	68	9	2	1368	1351	-
	6	903714	89.6	9	3	1338	1514	1573
	7	80863	81.9	9	2	1022	1689	-
	8	344067	88.3	9	3	1810	1330	1838
	9	609331	53.7	9	1	1597	-	-
	10	871542	91.3	9	3	1961	1106	1001
3	Type 5	20	0.6	12	5.32			
	Burst ID	Burst Offset (μs)	Pulse Width (μs)	Chirp Width (MHz)	Number of Pulses per Burst	PRI-1 (μs)	PRI-2 (μs)	PRI-3 (μs)
	0	26541	68.1	19	2	1339	1355	-
	1	171821	58.7	19	1	1251	-	-
	2	316229	75.3	19	2	1136	1640	-
	3	461864	56.4	19	1	1753	-	-
	4	8677	99.7	19	3	1196	1708	1159
	5	153995	57.7	19	1	1013	-	-
	6	299238	59.5	19	1	1072	-	-
	7	443177	80	19	2	1482	1369	-
	8	587671	82	19	2	1993	1197	-
	9	135674	82.8	19	2	1883	1005	-
	10	279928	88	19	3	1061	1928	1101
	11	424279	93.2	19	3	1207	1907	1223
	12	570132	70.4	19	2	1526	1360	-
	13	117439	95.3	19	3	1171	1955	1775
	14	262502	81.9	19	2	1690	1545	-
	15	406573	98.5	19	3	1975	1169	1062
	16	553328	65	19	1	1767	-	-
	17	99799	85.4	19	3	1011	1637	1425
	18	244095	91.6	19	3	1878	1445	1325
	19	390012	67.3	19	2	1091	1218	-

Trial ID	Radar Type	Number of Bursts	Burst Period(s)	Wave from Length (s)	Center Frequency(GHz)	-		
4	Type 5	17	0.705882	12	5.32			
	Burst ID	Burst Offset (μs)	Pulse Width (μs)	Chirp Width (MHz)	Number of Pulses per Burst	PRI-1 (μs)	PRI-2 (μs)	PRI-3 (μs)
	0	629614	67.9	16	2	1320	1133	-
	1	96856	62.3	16	1	1957	-	-
	2	267719	53.3	16	1	1592	-	-
	3	436784	90	16	3	1900	1153	1346
	4	608289	77.1	16	2	1166	1646	-
	5	75610	83.9	16	3	1278	1232	1459
	6	245638	89.1	16	3	1240	1384	1939
	7	416355	81.8	16	2	1833	1676	-
	8	588736	50.3	16	1	1075	-	-
	9	54571	87.1	16	3	1116	1996	1756
	10	225175	71.3	16	2	1225	1815	-
	11	394825	97.5	16	3	1884	1465	1132
	12	565361	90.6	16	3	1561	1040	1354
	13	33643	86.3	16	3	1596	1183	1792
	14	203957	97.6	16	3	1365	1073	1361
	15	373812	84.7	16	3	1021	1718	1854
	16	544060	99.7	16	3	1150	1244	1988
5	Type 5	14	0.857143	12	5.32			
	Burst ID	Burst Offset (μs)	Pulse Width (μs)	Chirp Width (MHz)	Number of Pulses per Burst	PRI-1 (μs)	PRI-2 (μs)	PRI-3 (μs)
	0	15438	92.9	12	3	1085	1564	1407
	1	222486	67.7	12	2	1744	1747	-
	2	430731	65.8	12	1	1092	-	-
	3	637784	56.3	12	1	1851	-	-
	4	845342	53.7	12	1	1727	-	-
	5	196720	83.5	12	3	1679	1930	1025
	6	404955	65.8	12	1	1519	-	-
	7	610711	85.9	12	3	1134	1034	1808
	8	818057	76.3	12	2	1606	1926	-
	9	171459	81.5	12	2	1891	1714	-
	10	377969	89.4	12	3	1310	1594	1827
	11	586875	63.4	12	1	1568	-	-
	12	792834	69.6	12	2	1307	1925	-
	13	146044	74.5	12	2	1264	1846	-

Trial ID	Radar Type	Number of Bursts	Burst Peried(s)	Wave from Length (s)	Center Frequency(GHz)	-		
6	Type 5	15	0.8	12	5.32			
	Burst ID	Burst Offset (μs)	Pulse Width (μs)	Chirp Width (MHz)	Number of Pulses per Burst	PRI-1 (μs)	PRI-2 (μs)	PRI-3 (μs)
	0	329022	96.6	13	3	1182	1609	1581
	1	521718	96.7	13	3	1829	1799	1154
	2	714222	86.5	13	3	1923	1396	1865
	3	112450	73.3	13	2	1908	1318	-
	4	306283	55.8	13	1	1688	-	-
	5	500239	55.4	13	1	1145	-	-
	6	690932	85.3	13	3	1336	1504	1820
	7	88645	79.4	13	2	1344	1893	-
	8	282508	65.7	13	1	1476	-	-
	9	475842	68.6	13	2	1008	1028	-
	10	667887	77.7	13	2	1972	1835	-
	11	64845	79.6	13	2	1882	1331	-
	12	257755	94.9	13	3	1830	1070	1349
	13	452335	61.4	13	1	1451	-	-
	14	643395	90.6	13	3	1233	1562	1887
7	Type 5	12	1	12	5.32			
	Burst ID	Burst Offset (μs)	Pulse Width (μs)	Chirp Width (MHz)	Number of Pulses per Burst	PRI-1 (μs)	PRI-2 (μs)	PRI-3 (μs)
	0	51446	52.6	10	1	1210	-	-
	1	292696	84.1	10	3	1314	1725	1529
	2	533989	97.7	10	3	1139	1868	1805
	3	775564	97.3	10	3	1341	1446	1755
	4	21542	98.8	10	3	1544	1386	1302
	5	263385	72.2	10	2	1771	1184	-
	6	505581	67.6	10	2	1175	1027	-
	7	747058	75.7	10	2	1026	1871	-
	8	989976	60.9	10	1	1798	-	-
	9	234024	64.2	10	1	1138	-	-
	10	475207	78.8	10	2	1784	1604	-
	11	715825	87.5	10	3	1511	1712	1683

Trial ID	Radar Type	Number of Bursts	Burst Period(s)	Wave from Length (s)	Center Frequency(GHz)	-		
8	Type 5	14	0.857143	12	5.32			
	Burst ID	Burst Offset (μs)	Pulse Width (μs)	Chirp Width (MHz)	Number of Pulses per Burst	PRI-1 (μs)	PRI-2 (μs)	PRI-3 (μs)
	0	823112	54.1	13	1	1415	-	-
	1	174965	50.7	13	1	1221	-	-
	2	382216	52.3	13	1	1974	-	-
	3	587395	99.8	13	3	1558	1696	1949
	4	796897	68.4	13	2	1014	1099	-
	5	149042	80.8	13	2	1736	1505	-
	6	356750	62.5	13	1	1778	-	-
	7	563824	74.8	13	2	1149	1204	-
	8	772314	50.8	13	1	1049	-	-
	9	123796	54	13	1	1417	-	-
	10	331215	63	13	1	1730	-	-
	11	537402	91.8	13	3	1143	1270	1347
	12	744805	79.3	13	2	1274	1992	-
	13	98172	64.3	13	1	1937	-	-
9	Type 5	8	1.5	12	5.32			
	Burst ID	Burst Offset (μs)	Pulse Width (μs)	Chirp Width (MHz)	Number of Pulses per Burst	PRI-1 (μs)	PRI-2 (μs)	PRI-3 (μs)
	0	535615	63.4	6	1	1043	-	-
	1	898668	52	6	1	1863	-	-
	2	1259235	97.2	6	3	1973	1605	1583
	3	127106	78.7	6	2	1466	1743	-
	4	490358	74.2	6	2	1280	1219	-
	5	852409	88.7	6	3	1293	1934	1273
	6	1217152	54.3	6	1	1991	-	-
	7	82296	95.4	6	3	1580	1555	1791

Trial ID	Radar Type	Number of Bursts	Burst Period(s)	Wave from Length (s)	Center Frequency(GHz)	-		
10	Type 5	17	0.705882	12	5.3164			
	Burst ID	Burst Offset (μs)	Pulse Width (μs)	Chirp Width (MHz)	Number of Pulses per Burst	PRI-1 (μs)	PRI-2 (μs)	PRI-3 (μs)
	0	209249	73.7	16	2	1208	1497	-
	1	378386	97.4	16	3	1942	1754	1613
	2	548411	91.7	16	3	1999	1702	1462
	3	17733	66.2	16	1	1393	-	-
	4	187952	70.8	16	2	1968	1821	-
	5	359277	52.3	16	1	1740	-	-
	6	528886	78.9	16	2	1308	1984	-
	7	700166	70.9	16	2	1050	1358	-
	8	167197	75.6	16	2	1437	1430	-
	9	338262	59.1	16	1	1697	-	-
	10	508324	77	16	2	1397	1304	-
	11	678689	67.9	16	2	1803	1083	-
	12	146031	81.2	16	2	1720	1932	-
	13	316923	78.7	16	2	1247	1121	-
	14	488056	63.3	16	1	1634	-	-
	15	657326	68.9	16	2	1849	1423	-
	16	125509	59.3	16	1	1093	-	-
11	Type 5	19	0.631579	12	5.3176			
	Burst ID	Burst Offset (μs)	Pulse Width (μs)	Chirp Width (MHz)	Number of Pulses per Burst	PRI-1 (μs)	PRI-2 (μs)	PRI-3 (μs)
	0	263736	98.9	19	3	1381	1680	1488
	1	416459	82.3	19	2	1716	1855	-
	2	567902	86.7	19	3	1211	1400	1919
	3	92979	89.7	19	3	1861	1068	1282
	4	245155	98.6	19	3	1507	1194	1461
	5	397609	71.1	19	2	1921	1789	-
	6	551431	55.9	19	1	1947	-	-
	7	74413	67.9	19	2	1350	1372	-
	8	226559	84.4	19	3	1203	1107	1443
	9	380056	58.8	19	1	1715	-	-
	10	533408	65.6	19	1	1017	-	-
	11	55547	78.5	19	2	1911	1704	-
	12	207876	82.3	19	2	1845	1686	-
	13	359771	90.1	19	3	1938	1071	1266
	14	511297	90.2	19	3	1989	1089	1950
	15	36803	83.1	19	2	1943	1406	-
	16	189652	58.8	19	1	1742	-	-
	17	341809	77	19	2	1187	1657	-
	18	495737	55	19	1	1012	-	-

Trial ID	Radar Type	Number of Bursts	Burst Period(s)	Wave from Length (s)	Center Frequency(GHz)	-		
12	Type 5	15	0.8	12	5.3152			
	Burst ID	Burst Offset (µs)	Pulse Width (µs)	Chirp Width (MHz)	Number of Pulses per Burst	PRI-1 (µs)	PRI-2 (µs)	PRI-3 (µs)
	0	22911	58.1	13	1	1929	-	-
	1	216473	52.1	13	1	1910	-	-
	2	410004	59.9	13	1	1971	-	-
	3	603671	60.2	13	1	1812	-	-
	4	794160	95.9	13	3	1399	1906	1608
	5	192251	79.9	13	2	1626	1859	-
	6	385590	78.5	13	2	1238	1917	-
	7	579862	53.8	13	1	1763	-	-
	8	773423	64.7	13	1	1800	-	-
	9	168898	61.4	13	1	1390	-	-
	10	361606	83.2	13	2	1692	1858	-
	11	553866	84.7	13	3	1533	1677	1638
	12	747241	88.7	13	3	1703	1528	1058
	13	144710	78.3	13	2	1258	1951	-
	14	337856	69.3	13	2	1731	1717	-
13	Type 5	12	1	12	5.314			
	Burst ID	Burst Offset (µs)	Pulse Width (µs)	Chirp Width (MHz)	Number of Pulses per Burst	PRI-1 (µs)	PRI-2 (µs)	PRI-3 (µs)
	0	664275	75.3	10	2	1994	1612	-
	1	907886	56.3	10	1	1456	-	-
	2	151316	67.7	10	2	1617	1185	-
	3	393746	55.6	10	1	1337	-	-
	4	635093	75.2	10	2	1421	1267	-
	5	876993	76.3	10	2	1359	1305	-
	6	121278	85.7	10	3	1547	1362	1924
	7	362696	98.4	10	3	1873	1550	1249
	8	604342	86.4	10	3	1779	1439	1046
	9	846453	93.6	10	3	1059	1031	1452
	10	91871	63.3	10	1	1328	-	-
	11	333050	92.4	10	3	1412	1673	1322

Trial ID	Radar Type	Number of Bursts	Burst Period(s)	Wave from Length (s)	Center Frequency(GHz)	-		
14	Type 5	19	0.631579	12	5.3172			
	Burst ID	Burst Offset (µs)	Pulse Width (µs)	Chirp Width (MHz)	Number of Pulses per Burst	PRI-1 (µs)	PRI-2 (µs)	PRI-3 (µs)
	0	361323	93.3	18	3	1983	1912	1535
	1	515261	69.1	18	2	1102	1794	-
	2	39025	86.9	18	3	1044	1152	1148
	3	190900	84.9	18	3	1894	1948	1118
	4	343941	72.3	18	2	1094	1916	-
	5	497624	51.7	18	1	1447	-	-
	6	20319	58.3	18	1	1429	-	-
	7	172999	60.8	18	1	1979	-	-
	8	325872	57.1	18	1	1641	-	-
	9	475841	88.9	18	3	1886	1964	1489
	10	1489	72	18	2	1909	1297	-
	11	153647	90.9	18	3	1261	1566	1370
	12	307096	59.8	18	1	1552	-	-
	13	458804	70	18	2	1759	1291	-
	14	610798	67.2	18	2	1625	1881	-
	15	134759	91.2	18	3	1382	1832	1661
	16	288306	56.5	18	1	1483	-	-
	17	441296	51.2	18	1	1237	-	-
	18	592780	74.1	18	2	1471	1245	-
15	Type 5	14	0.857143	12	5.3148			
	Burst ID	Burst Offset (µs)	Pulse Width (µs)	Chirp Width (MHz)	Number of Pulses per Burst	PRI-1 (µs)	PRI-2 (µs)	PRI-3 (µs)
	0	158286	76.9	12	2	1110	1140	-
	1	366024	50.2	12	1	1316	-	-
	2	573452	62.9	12	1	1520	-	-
	3	780619	64.7	12	1	1902	-	-
	4	132455	83.8	12	3	1410	1097	1621
	5	340207	65.4	12	1	1944	-	-
	6	548208	53.2	12	1	1024	-	-
	7	755333	51.7	12	1	1603	-	-
	8	107117	78.7	12	2	1804	1168	-
	9	314500	72.4	12	2	1030	1343	-
	10	522447	53.8	12	1	1327	-	-
	11	728517	73.6	12	2	1524	1553	-
	12	81611	66.7	12	2	1722	1122	-
	13	288948	82.5	12	2	1404	1019	-

Trial ID	Radar Type	Number of Bursts	Burst Period(s)	Wave from Length (s)	Center Frequency(GHz)	-		
16	Type 5	20	0.6	12	5.318			
	Burst ID	Burst Offset (μs)	Pulse Width (μs)	Chirp Width (MHz)	Number of Pulses per Burst	PRI-1 (μs)	PRI-2 (μs)	PRI-3 (μs)
	0	345766	87.6	20	3	1565	1055	1840
	1	490019	85.2	20	3	1735	1541	1408
	2	39073	84.8	20	3	1534	1889	1463
	3	183923	77.9	20	2	1749	1460	-
	4	328777	76.5	20	2	1518	1485	-
	5	474728	60.9	20	1	1540	-	-
	6	21394	83	20	2	1080	1010	-
	7	165992	80.4	20	2	1824	1752	-
	8	310973	67.5	20	2	1764	1181	-
	9	456884	62.1	20	1	1495	-	-
	10	3515	86.4	20	3	1773	1966	1263
	11	147928	84.3	20	3	1593	1188	1788
	12	293225	76.9	20	2	1226	1537	-
	13	436922	95.8	20	3	1192	1298	1844
	14	584015	55.2	20	1	1644	-	-
	15	130832	59	20	1	1402	-	-
	16	274684	94.5	20	3	1296	1700	1283
	17	418579	91.9	20	3	1970	1978	1165
	18	563464	85.2	20	3	1732	1551	1189
	19	112787	69.5	20	2	1038	1224	-
17	Type 5	12	1	12	5.314			
	Burst ID	Burst Offset (μs)	Pulse Width (μs)	Chirp Width (MHz)	Number of Pulses per Burst	PRI-1 (μs)	PRI-2 (μs)	PRI-3 (μs)
	0	429224	86.4	10	3	1259	1918	1455
	1	670241	92.2	10	3	1598	1719	1895
	2	912880	80.4	10	2	1816	1899	-
	3	158603	54.3	10	1	1335	-	-
	4	400824	53.1	10	1	1303	-	-
	5	641915	69.4	10	2	1503	1546	-
	6	883823	69.1	10	2	1279	1639	-
	7	128373	100	10	3	1375	1438	1595
	8	370379	79.6	10	2	1239	1705	-
	9	611194	88.4	10	3	1374	1579	1623
	10	855665	53.3	10	1	1016	-	-
	11	98897	65.3	10	1	1709	-	-

Trial ID	Radar Type	Number of Bursts	Burst Period(s)	Wave from Length (s)	Center Frequency(GHz)	-		
18	Type 5	14	0.857143	12	5.3148			
	Burst ID	Burst Offset (μs)	Pulse Width (μs)	Chirp Width (MHz)	Number of Pulses per Burst	PRI-1 (μs)	PRI-2 (μs)	PRI-3 (μs)
	0	292143	55.3	12	1	1920	-	-
	1	499633	58.3	12	1	1797	-	-
	2	706377	72.3	12	2	1610	1039	-
	3	58989	84.8	12	3	1131	1761	1721
	4	266161	82.5	12	2	1875	1431	-
	5	474469	63.3	12	1	1095	-	-
	6	680544	80	12	2	1119	1913	-
	7	33519	90.3	12	3	1660	1853	1123
	8	240319	91.1	12	3	1539	1783	1172
	9	447400	96.6	12	3	1525	1036	1385
	10	654516	82.7	12	2	1710	1990	-
	11	8083	50.7	12	1	1234	-	-
	12	215435	78.4	12	2	1047	1109	-
	13	421325	99.5	12	3	1299	1965	1869
19	Type 5	12	1	12	5.314			
	Burst ID	Burst Offset (μs)	Pulse Width (μs)	Chirp Width (MHz)	Number of Pulses per Burst	PRI-1 (μs)	PRI-2 (μs)	PRI-3 (μs)
	0	733725	88.6	10	3	1501	1067	1927
	1	977882	57.4	10	1	1723	-	-
	2	221197	96.6	10	3	1086	1658	1324
	3	462915	69.7	10	2	1751	1945	-
	4	705071	77.9	10	2	1642	1317	-
	5	947923	62	10	1	1866	-	-
	6	191373	88.4	10	3	1997	1077	1366
	7	432561	97.3	10	3	1790	1896	1367
	8	674004	96.2	10	3	1391	1787	1672
	9	915842	95.4	10	3	1020	1892	1414
	10	162176	54.8	10	1	1084	-	-
	11	403553	80.4	10	2	1850	1436	-

Trial ID	Radar Type	Number of Bursts	Burst Period(s)	Wave from Length (s)	Center Frequency(GHz)	-		
20	Type 5	16	0.75	12	5.324			
	Burst ID	Burst Offset (μs)	Pulse Width (μs)	Chirp Width (MHz)	Number of Pulses per Burst	PRI-1 (μs)	PRI-2 (μs)	PRI-3 (μs)
	0	483470	74.7	15	2	1619	1611	-
	1	666072	57.1	15	1	1560	-	-
	2	98810	91.9	15	3	1392	1475	1276
	3	279914	83.1	15	2	1809	1772	-
	4	462536	50.7	15	1	1003	-	-
	5	642324	79.2	15	2	1574	1600	-
	6	76831	58.7	15	1	1186	-	-
	7	257785	71	15	2	1521	1567	-
	8	438554	79	15	2	1777	1960	-
	9	620397	68.5	15	2	1284	1428	-
	10	54310	73.5	15	2	1904	1352	-
	11	235506	70.5	15	2	1864	1115	-
	12	417036	76.6	15	2	1045	1300	-
	13	597974	81.2	15	2	1160	1675	-
	14	32086	61.8	15	1	1277	-	-
	15	212751	94.9	15	3	1450	1206	1860
21	Type 5	12	1	12	5.3264			
	Burst ID	Burst Offset (μs)	Pulse Width (μs)	Chirp Width (MHz)	Number of Pulses per Burst	PRI-1 (μs)	PRI-2 (μs)	PRI-3 (μs)
	0	526149	78.5	9	2	1653	1698	-
	1	767135	89.8	9	3	1174	1962	1167
	2	12955	59.4	9	1	1982	-	-
	3	254612	79.6	9	2	1633	1890	-
	4	496588	76	9	2	1112	1811	-
	5	739728	53.6	9	1	1144	-	-
	6	980872	80.9	9	2	1220	1053	-
	7	225249	61.6	9	1	1724	-	-
	8	467279	53.4	9	1	1901	-	-
	9	709720	59.9	9	1	1379	-	-
	10	951847	60.4	9	1	1453	-	-
	11	194839	91.4	9	3	1768	1726	1227

Trial ID	Radar Type	Number of Bursts	Burst Period(s)	Wave from Length (s)	Center Frequency(GHz)	-		
22	Type 5	20	0.6	12	5.322			
	Burst ID	Burst Offset (µs)	Pulse Width (µs)	Chirp Width (MHz)	Number of Pulses per Burst	PRI-1 (µs)	PRI-2 (µs)	PRI-3 (µs)
	0	261858	77	20	2	1191	1363	-
	1	407646	58.1	20	1	1248	-	-
	2	552319	62.1	20	1	1836	-	-
	3	99107	76.9	20	2	1334	1236	-
	4	243514	80	20	2	1914	1852	-
	5	389464	52	20	1	1701	-	-
	6	531093	88.6	20	3	1693	1995	1905
	7	81159	72.9	20	2	1922	1387	-
	8	225245	98.5	20	3	1839	1746	1389
	9	371906	57.9	20	1	1193	-	-
	10	514197	95.9	20	3	1659	1870	1066
	11	63561	53.5	20	1	1162	-	-
	12	207510	92	20	3	1745	1654	1458
	13	353638	57.3	20	1	1834	-	-
	14	497515	70.5	20	2	1684	1586	-
	15	45553	70	20	2	1042	1664	-
	16	189821	84	20	3	1765	1630	1176
	17	335330	76.1	20	2	1557	1057	-
	18	478825	93.2	20	3	1985	1018	1340
	19	27594	96.8	20	3	1760	1614	1817
23	Type 5	14	0.857143	12	5.3252			
	Burst ID	Burst Offset (µs)	Pulse Width (µs)	Chirp Width (MHz)	Number of Pulses per Burst	PRI-1 (µs)	PRI-2 (µs)	PRI-3 (µs)
	0	247117	50.1	12	1	1841	-	-
	1	453362	93.5	12	3	1590	1081	1413
	2	660875	68.8	12	2	1707	1577	-
	3	14140	56.3	12	1	1056	-	-
	4	220734	86	12	3	1953	1108	1987
	5	428367	75.2	12	2	1572	1536	-
	6	636681	54.4	12	1	1517	-	-
	7	843157	71.1	12	2	1329	1243	-
	8	195585	76.2	12	2	1940	1770	-
	9	403231	80.2	12	2	1098	1209	-
	10	610202	79.7	12	2	1588	1214	-
	11	815229	90.9	12	3	1615	1862	1601
	12	170267	68.7	12	2	1377	1441	-
	13	377306	67.4	12	2	1872	1313	-

Trial ID	Radar Type	Number of Bursts	Burst Peried(s)	Wave from Length (s)	Center Frequency(GHz)	-		
24	Type 5	13	0.923077	12	5.3256			
	Burst ID	Burst Offset (μs)	Pulse Width (μs)	Chirp Width (MHz)	Number of Pulses per Burst	PRI-1 (μs)	PRI-2 (μs)	PRI-3 (μs)
	0	628071	94	11	3	1643	1748	1941
	1	853391	70.8	11	2	1177	1201	-
	2	156223	56.3	11	1	1006	-	-
	3	378734	96.7	11	3	1230	1163	1332
	4	601331	90.6	11	3	1217	1582	1498
	5	825462	74.5	11	2	1569	1281	-
	6	128265	92.6	11	3	1065	1669	1222
	7	351161	89	11	3	1493	1135	1380
	8	573425	96.5	11	3	1607	1822	1602
	9	798431	70.5	11	2	1141	1178	-
	10	100737	94	11	3	1009	1629	1956
	11	324661	55.8	11	1	1290	-	-
	12	546278	87.7	11	3	1435	1963	1164
25	Type 5	8	1.5	12	5.328			
	Burst ID	Burst Offset (μs)	Pulse Width (μs)	Chirp Width (MHz)	Number of Pulses per Burst	PRI-1 (μs)	PRI-2 (μs)	PRI-3 (μs)
	0	1253842	68.6	5	2	1306	1161	-
	1	119486	83.1	5	2	1420	1315	-
	2	482958	60.9	5	1	1687	-	-
	3	845641	77.7	5	2	1776	1158	-
	4	1208428	77.4	5	2	1793	1510	-
	5	74748	66.8	5	2	1576	1323	-
	6	438300	63.7	5	1	1333	-	-
	7	800152	91.2	5	3	1409	1681	1275

Trial ID	Radar Type	Number of Bursts	Burst Period(s)	Wave from Length (s)	Center Frequency(GHz)	-		
26	Type 5	17	0.705882	12	5.3236			
	Burst ID	Burst Offset (μs)	Pulse Width (μs)	Chirp Width (MHz)	Number of Pulses per Burst	PRI-1 (μs)	PRI-2 (μs)	PRI-3 (μs)
	0	545865	83.6	16	3	1632	1195	1000
	1	14067	89.4	16	3	1173	1627	1656
	2	184953	55.8	16	1	1532	-	-
	3	353759	90.9	16	3	1981	1554	1998
	4	526388	54.7	16	1	1825	-	-
	5	694806	97.7	16	3	1734	1202	1250
	6	163568	67.5	16	2	1571	1434	-
	7	333410	96.7	16	3	1589	1469	1268
	8	504006	68.3	16	2	1750	1954	-
	9	675297	78.3	16	2	1591	1082	-
	10	142890	55	16	1	1427	-	-
	11	312479	84.9	16	3	1129	1936	1199
	12	482953	74.6	16	2	1959	1856	-
	13	655022	63.3	16	1	1885	-	-
	14	121457	99.8	16	3	1035	1515	1120
	15	292606	63.6	16	1	1647	-	-
	16	461322	87.3	16	3	1931	1051	1831
27	Type 5	19	0.631579	12	5.3224			
	Burst ID	Burst Offset (μs)	Pulse Width (μs)	Chirp Width (MHz)	Number of Pulses per Burst	PRI-1 (μs)	PRI-2 (μs)	PRI-3 (μs)
	0	565136	85.6	19	3	1946	1078	1015
	1	89970	68.6	19	2	1029	1780	-
	2	243121	54.2	19	1	1111	-	-
	3	396034	61.2	19	1	1104	-	-
	4	546225	97.1	19	3	1157	1969	1100
	5	70998	98.3	19	3	1142	1699	1622
	6	224093	62.4	19	1	1655	-	-
	7	376127	80.2	19	2	1126	1769	-
	8	527806	87.5	19	3	1216	1448	1179
	9	52247	85.8	19	3	1847	1348	1472
	10	204582	88.1	19	3	1023	1124	1631
	11	357941	65.3	19	1	1848	-	-
	12	510977	52.5	19	1	1470	-	-
	13	33698	52.3	19	1	1312	-	-
	14	186023	74.1	19	2	1915	1200	-
	15	339327	54.9	19	1	1479	-	-
	16	491053	76.2	19	2	1376	1502	-
	17	14858	60.4	19	1	1758	-	-
	18	167387	81.5	19	2	1491	1103	-

Trial ID	Radar Type	Number of Bursts	Burst Peried(s)	Wave from Length (s)	Center Frequency(GHz)	-		
28	Type 5	12	1	12	5.326			
	Burst ID	Burst Offset (μs)	Pulse Width (μs)	Chirp Width (MHz)	Number of Pulses per Burst	PRI-1 (μs)	PRI-2 (μs)	PRI-3 (μs)
	0	507709	50.5	10	1	1857	-	-
	1	750249	55.7	10	1	1246	-	-
	2	989003	85.8	10	3	1774	1002	1967
	3	235634	76.9	10	2	1125	1474	-
	4	477675	75.1	10	2	1254	1052	-
	5	718312	92.3	10	3	1180	1486	1492
	6	960895	78.1	10	2	1301	1757	-
	7	205370	92.2	10	3	1898	1252	1713
	8	446940	89	10	3	1260	1706	1411
	9	689225	70.9	10	2	1578	1620	-
	10	932305	63.1	10	1	1782	-	-
	11	176231	55.3	10	1	1522	-	-
29	Type 5	18	0.666667	12	5.3232			
	Burst ID	Burst Offset (μs)	Pulse Width (μs)	Chirp Width (MHz)	Number of Pulses per Burst	PRI-1 (μs)	PRI-2 (μs)	PRI-3 (μs)
	0	277485	83.4	17	3	1454	1205	1801
	1	437880	97.3	17	3	1319	1826	1635
	2	598445	90.4	17	3	1079	1986	1674
	3	97088	91.8	17	3	1563	1151	1802
	4	257251	98.2	17	3	1876	1977	1766
	5	419893	59.5	17	1	1952	-	-
	6	580724	80	17	2	1253	1137	-
	7	77366	86.5	17	3	1054	1128	1828
	8	238032	91.1	17	3	1105	1599	1442
	9	398605	93.5	17	3	1867	1373	1087
	10	562025	60.7	17	1	1033	-	-
	11	57684	67.2	17	2	1288	1405	-
	12	219083	61.8	17	1	1585	-	-
	13	379234	79.4	17	2	1933	1667	-
	14	540896	81.4	17	2	1096	1464	-
	15	37916	65.7	17	1	1496	-	-
	16	198794	76	17	2	1733	1255	-
	17	359754	81	17	2	1326	1668	-

IEEE 802.11ax(HE160)
Radar Signal 5_5290 MHz

Trial ID	Radar Type	Number of Bursts	Burst Period(s)	Wave from Length (s)	Center Frequency(GHz)	-		
0	Type 5	15	0.8	12	5.29	-		
	Burst ID	Burst Offset (μs)	Pulse Width (μs)	Chirp Width (MHz)	Number of Pulses per Burst	PRI-1 (μs)	PRI-2 (μs)	PRI-3 (μs)
	0	636185	77.8	13	2	1665	1477	-
	1	32674	51.9	13	1	1074	-	-
	2	226294	63.8	13	1	1584	-	-
	3	417976	96.6	13	3	1682	1786	1843
	4	611152	85.9	13	3	1795	1215	1729
	5	8789	73.7	13	2	1198	1549	-
	6	201917	77.2	13	2	1837	1819	-
	7	395530	68.4	13	2	1587	1114	-
	8	588564	76.7	13	2	2000	1155	-
	9	783794	53.2	13	1	1147	-	-
	10	177933	85.7	13	3	1433	1695	1394
	11	370624	94.3	13	3	1670	1426	1935
	12	564893	77.6	13	2	1294	1671	-
	13	759583	65.7	13	1	1512	-	-
	14	154262	93.5	13	3	1444	1130	1468
1	Type 5	8	1.5	12	5.29			
	Burst ID	Burst Offset (μs)	Pulse Width (μs)	Chirp Width (MHz)	Number of Pulses per Burst	PRI-1 (μs)	PRI-2 (μs)	PRI-3 (μs)
	0	653020	75	5	2	1880	1527	-
	1	1015643	99.4	5	3	1401	1262	1257
	2	1379398	67.4	5	2	1531	1403	-
	3	245489	73.6	5	2	1449	1041	-
	4	609113	65.9	5	1	1432	-	-
	5	970852	83.8	5	3	1356	1292	1419
	6	1335913	65.5	5	1	1543	-	-
	7	200406	98.6	5	3	1548	1796	1728

Trial ID	Radar Type	Number of Bursts	Burst Period(s)	Wave from Length (s)	Center Frequency(GHz)	-		
2	Type 5	11	1.090909	12	5.29			
	Burst ID	Burst Offset (μs)	Pulse Width (μs)	Chirp Width (MHz)	Number of Pulses per Burst	PRI-1 (μs)	PRI-2 (μs)	PRI-3 (μs)
	0	409565	73.8	9	2	1806	1538	-
	1	673692	69.5	9	2	1117	1649	-
	2	938562	51.9	9	1	1651	-	-
	3	113209	84.6	9	3	1976	1032	1271
	4	376726	95.4	9	3	1060	1903	1388
	5	641212	68	9	2	1368	1351	-
	6	903714	89.6	9	3	1338	1514	1573
	7	80863	81.9	9	2	1022	1689	-
	8	344067	88.3	9	3	1810	1330	1838
	9	609331	53.7	9	1	1597	-	-
	10	871542	91.3	9	3	1961	1106	1001
3	Type 5	20	0.6	12	5.29			
	Burst ID	Burst Offset (μs)	Pulse Width (μs)	Chirp Width (MHz)	Number of Pulses per Burst	PRI-1 (μs)	PRI-2 (μs)	PRI-3 (μs)
	0	26541	68.1	19	2	1339	1355	-
	1	171821	58.7	19	1	1251	-	-
	2	316229	75.3	19	2	1136	1640	-
	3	461864	56.4	19	1	1753	-	-
	4	8677	99.7	19	3	1196	1708	1159
	5	153995	57.7	19	1	1013	-	-
	6	299238	59.5	19	1	1072	-	-
	7	443177	80	19	2	1482	1369	-
	8	587671	82	19	2	1993	1197	-
	9	135674	82.8	19	2	1883	1005	-
	10	279928	88	19	3	1061	1928	1101
	11	424279	93.2	19	3	1207	1907	1223
	12	570132	70.4	19	2	1526	1360	-
	13	117439	95.3	19	3	1171	1955	1775
	14	262502	81.9	19	2	1690	1545	-
	15	406573	98.5	19	3	1975	1169	1062
	16	553328	65	19	1	1767	-	-
	17	99799	85.4	19	3	1011	1637	1425
	18	244095	91.6	19	3	1878	1445	1325
	19	390012	67.3	19	2	1091	1218	-

Trial ID	Radar Type	Number of Bursts	Burst Period(s)	Wave from Length (s)	Center Frequency(GHz)	-		
4	Type 5	17	0.705882	12	5.29			
	Burst ID	Burst Offset (μs)	Pulse Width (μs)	Chirp Width (MHz)	Number of Pulses per Burst	PRI-1 (μs)	PRI-2 (μs)	PRI-3 (μs)
	0	629614	67.9	16	2	1320	1133	-
	1	96856	62.3	16	1	1957	-	-
	2	267719	53.3	16	1	1592	-	-
	3	436784	90	16	3	1900	1153	1346
	4	608289	77.1	16	2	1166	1646	-
	5	75610	83.9	16	3	1278	1232	1459
	6	245638	89.1	16	3	1240	1384	1939
	7	416355	81.8	16	2	1833	1676	-
	8	588736	50.3	16	1	1075	-	-
	9	54571	87.1	16	3	1116	1996	1756
	10	225175	71.3	16	2	1225	1815	-
	11	394825	97.5	16	3	1884	1465	1132
	12	565361	90.6	16	3	1561	1040	1354
	13	33643	86.3	16	3	1596	1183	1792
	14	203957	97.6	16	3	1365	1073	1361
	15	373812	84.7	16	3	1021	1718	1854
	16	544060	99.7	16	3	1150	1244	1988
5	Type 5	14	0.857143	12	5.29			
	Burst ID	Burst Offset (μs)	Pulse Width (μs)	Chirp Width (MHz)	Number of Pulses per Burst	PRI-1 (μs)	PRI-2 (μs)	PRI-3 (μs)
	0	15438	92.9	12	3	1085	1564	1407
	1	222486	67.7	12	2	1744	1747	-
	2	430731	65.8	12	1	1092	-	-
	3	637784	56.3	12	1	1851	-	-
	4	845342	53.7	12	1	1727	-	-
	5	196720	83.5	12	3	1679	1930	1025
	6	404955	65.8	12	1	1519	-	-
	7	610711	85.9	12	3	1134	1034	1808
	8	818057	76.3	12	2	1606	1926	-
	9	171459	81.5	12	2	1891	1714	-
	10	377969	89.4	12	3	1310	1594	1827
	11	586875	63.4	12	1	1568	-	-
	12	792834	69.6	12	2	1307	1925	-
	13	146044	74.5	12	2	1264	1846	-

Trial ID	Radar Type	Number of Bursts	Burst Period(s)	Wave from Length (s)	Center Frequency(GHz)	-		
6	Type 5	15	0.8	12	5.29			
	Burst ID	Burst Offset (μs)	Pulse Width (μs)	Chirp Width (MHz)	Number of Pulses per Burst	PRI-1 (μs)	PRI-2 (μs)	PRI-3 (μs)
	0	329022	96.6	13	3	1182	1609	1581
	1	521718	96.7	13	3	1829	1799	1154
	2	714222	86.5	13	3	1923	1396	1865
	3	112450	73.3	13	2	1908	1318	-
	4	306283	55.8	13	1	1688	-	-
	5	500239	55.4	13	1	1145	-	-
	6	690932	85.3	13	3	1336	1504	1820
	7	88645	79.4	13	2	1344	1893	-
	8	282508	65.7	13	1	1476	-	-
	9	475842	68.6	13	2	1008	1028	-
	10	667887	77.7	13	2	1972	1835	-
	11	64845	79.6	13	2	1882	1331	-
	12	257755	94.9	13	3	1830	1070	1349
	13	452335	61.4	13	1	1451	-	-
	14	643395	90.6	13	3	1233	1562	1887
7	Type 5	12	1	12	5.29			
	Burst ID	Burst Offset (μs)	Pulse Width (μs)	Chirp Width (MHz)	Number of Pulses per Burst	PRI-1 (μs)	PRI-2 (μs)	PRI-3 (μs)
	0	51446	52.6	10	1	1210	-	-
	1	292696	84.1	10	3	1314	1725	1529
	2	533989	97.7	10	3	1139	1868	1805
	3	775564	97.3	10	3	1341	1446	1755
	4	21542	98.8	10	3	1544	1386	1302
	5	263385	72.2	10	2	1771	1184	-
	6	505581	67.6	10	2	1175	1027	-
	7	747058	75.7	10	2	1026	1871	-
	8	989976	60.9	10	1	1798	-	-
	9	234024	64.2	10	1	1138	-	-
	10	475207	78.8	10	2	1784	1604	-
	11	715825	87.5	10	3	1511	1712	1683

Trial ID	Radar Type	Number of Bursts	Burst Peried(s)	Wave from Length (s)	Center Frequency(GHz)	-		
8	Type 5	14	0.857143	12	5.29			
	Burst ID	Burst Offset (μs)	Pulse Width (μs)	Chirp Width (MHz)	Number of Pulses per Burst	PRI-1 (μs)	PRI-2 (μs)	PRI-3 (μs)
	0	823112	54.1	13	1	1415	-	-
	1	174965	50.7	13	1	1221	-	-
	2	382216	52.3	13	1	1974	-	-
	3	587395	99.8	13	3	1558	1696	1949
	4	796897	68.4	13	2	1014	1099	-
	5	149042	80.8	13	2	1736	1505	-
	6	356750	62.5	13	1	1778	-	-
	7	563824	74.8	13	2	1149	1204	-
	8	772314	50.8	13	1	1049	-	-
	9	123796	54	13	1	1417	-	-
	10	331215	63	13	1	1730	-	-
	11	537402	91.8	13	3	1143	1270	1347
	12	744805	79.3	13	2	1274	1992	-
	13	98172	64.3	13	1	1937	-	-
9	Type 5	8	1.5	12	5.29			
	Burst ID	Burst Offset (μs)	Pulse Width (μs)	Chirp Width (MHz)	Number of Pulses per Burst	PRI-1 (μs)	PRI-2 (μs)	PRI-3 (μs)
	0	535615	63.4	6	1	1043	-	-
	1	898668	52	6	1	1863	-	-
	2	1259235	97.2	6	3	1973	1605	1583
	3	127106	78.7	6	2	1466	1743	-
	4	490358	74.2	6	2	1280	1219	-
	5	852409	88.7	6	3	1293	1934	1273
	6	1217152	54.3	6	1	1991	-	-
	7	82296	95.4	6	3	1580	1555	1791

Trial ID	Radar Type	Number of Bursts	Burst Period(s)	Wave from Length (s)	Center Frequency(GHz)	-		
10	Type 5	17	0.705882	12	5.2564			
	Burst ID	Burst Offset (μs)	Pulse Width (μs)	Chirp Width (MHz)	Number of Pulses per Burst	PRI-1 (μs)	PRI-2 (μs)	PRI-3 (μs)
	0	209249	73.7	16	2	1208	1497	-
	1	378386	97.4	16	3	1942	1754	1613
	2	548411	91.7	16	3	1999	1702	1462
	3	17733	66.2	16	1	1393	-	-
	4	187952	70.8	16	2	1968	1821	-
	5	359277	52.3	16	1	1740	-	-
	6	528886	78.9	16	2	1308	1984	-
	7	700166	70.9	16	2	1050	1358	-
	8	167197	75.6	16	2	1437	1430	-
	9	338262	59.1	16	1	1697	-	-
	10	508324	77	16	2	1397	1304	-
	11	678689	67.9	16	2	1803	1083	-
	12	146031	81.2	16	2	1720	1932	-
	13	316923	78.7	16	2	1247	1121	-
	14	488056	63.3	16	1	1634	-	-
	15	657326	68.9	16	2	1849	1423	-
	16	125509	59.3	16	1	1093	-	-
11	Type 5	19	0.631579	12	5.2576			
	Burst ID	Burst Offset (μs)	Pulse Width (μs)	Chirp Width (MHz)	Number of Pulses per Burst	PRI-1 (μs)	PRI-2 (μs)	PRI-3 (μs)
	0	263736	98.9	19	3	1381	1680	1488
	1	416459	82.3	19	2	1716	1855	-
	2	567902	86.7	19	3	1211	1400	1919
	3	92979	89.7	19	3	1861	1068	1282
	4	245155	98.6	19	3	1507	1194	1461
	5	397609	71.1	19	2	1921	1789	-
	6	551431	55.9	19	1	1947	-	-
	7	74413	67.9	19	2	1350	1372	-
	8	226559	84.4	19	3	1203	1107	1443
	9	380056	58.8	19	1	1715	-	-
	10	533408	65.6	19	1	1017	-	-
	11	55547	78.5	19	2	1911	1704	-
	12	207876	82.3	19	2	1845	1686	-
	13	359771	90.1	19	3	1938	1071	1266
	14	511297	90.2	19	3	1989	1089	1950
	15	36803	83.1	19	2	1943	1406	-
	16	189652	58.8	19	1	1742	-	-
	17	341809	77	19	2	1187	1657	-
	18	495737	55	19	1	1012	-	-

Trial ID	Radar Type	Number of Bursts	Burst Period(s)	Wave from Length (s)	Center Frequency(GHz)	-		
12	Type 5	15	0.8	12	5.2552			
	Burst ID	Burst Offset (μs)	Pulse Width (μs)	Chirp Width (MHz)	Number of Pulses per Burst	PRI-1 (μs)	PRI-2 (μs)	PRI-3 (μs)
	0	22911	58.1	13	1	1929	-	-
	1	216473	52.1	13	1	1910	-	-
	2	410004	59.9	13	1	1971	-	-
	3	603671	60.2	13	1	1812	-	-
	4	794160	95.9	13	3	1399	1906	1608
	5	192251	79.9	13	2	1626	1859	-
	6	385590	78.5	13	2	1238	1917	-
	7	579862	53.8	13	1	1763	-	-
	8	773423	64.7	13	1	1800	-	-
	9	168898	61.4	13	1	1390	-	-
	10	361606	83.2	13	2	1692	1858	-
	11	553866	84.7	13	3	1533	1677	1638
	12	747241	88.7	13	3	1703	1528	1058
	13	144710	78.3	13	2	1258	1951	-
	14	337856	69.3	13	2	1731	1717	-
13	Type 5	12	1	12	5.254			
	Burst ID	Burst Offset (μs)	Pulse Width (μs)	Chirp Width (MHz)	Number of Pulses per Burst	PRI-1 (μs)	PRI-2 (μs)	PRI-3 (μs)
	0	664275	75.3	10	2	1994	1612	-
	1	907886	56.3	10	1	1456	-	-
	2	151316	67.7	10	2	1617	1185	-
	3	393746	55.6	10	1	1337	-	-
	4	635093	75.2	10	2	1421	1267	-
	5	876993	76.3	10	2	1359	1305	-
	6	121278	85.7	10	3	1547	1362	1924
	7	362696	98.4	10	3	1873	1550	1249
	8	604342	86.4	10	3	1779	1439	1046
	9	846453	93.6	10	3	1059	1031	1452
	10	91871	63.3	10	1	1328	-	-
	11	333050	92.4	10	3	1412	1673	1322

Trial ID	Radar Type	Number of Bursts	Burst Period(s)	Wave from Length (s)	Center Frequency(GHz)	-		
14	Type 5	19	0.631579	12	5.2572			
	Burst ID	Burst Offset (μs)	Pulse Width (μs)	Chirp Width (MHz)	Number of Pulses per Burst	PRI-1 (μs)	PRI-2 (μs)	PRI-3 (μs)
	0	361323	93.3	18	3	1983	1912	1535
	1	515261	69.1	18	2	1102	1794	-
	2	39025	86.9	18	3	1044	1152	1148
	3	190900	84.9	18	3	1894	1948	1118
	4	343941	72.3	18	2	1094	1916	-
	5	497624	51.7	18	1	1447	-	-
	6	20319	58.3	18	1	1429	-	-
	7	172999	60.8	18	1	1979	-	-
	8	325872	57.1	18	1	1641	-	-
	9	475841	88.9	18	3	1886	1964	1489
	10	1489	72	18	2	1909	1297	-
	11	153647	90.9	18	3	1261	1566	1370
	12	307096	59.8	18	1	1552	-	-
	13	458804	70	18	2	1759	1291	-
	14	610798	67.2	18	2	1625	1881	-
	15	134759	91.2	18	3	1382	1832	1661
	16	288306	56.5	18	1	1483	-	-
	17	441296	51.2	18	1	1237	-	-
	18	592780	74.1	18	2	1471	1245	-
15	Type 5	14	0.857143	12	5.2548			
	Burst ID	Burst Offset (μs)	Pulse Width (μs)	Chirp Width (MHz)	Number of Pulses per Burst	PRI-1 (μs)	PRI-2 (μs)	PRI-3 (μs)
	0	158286	76.9	12	2	1110	1140	-
	1	366024	50.2	12	1	1316	-	-
	2	573452	62.9	12	1	1520	-	-
	3	780619	64.7	12	1	1902	-	-
	4	132455	83.8	12	3	1410	1097	1621
	5	340207	65.4	12	1	1944	-	-
	6	548208	53.2	12	1	1024	-	-
	7	755333	51.7	12	1	1603	-	-
	8	107117	78.7	12	2	1804	1168	-
	9	314500	72.4	12	2	1030	1343	-
	10	522447	53.8	12	1	1327	-	-
	11	728517	73.6	12	2	1524	1553	-
	12	81611	66.7	12	2	1722	1122	-
	13	288948	82.5	12	2	1404	1019	-

Trial ID	Radar Type	Number of Bursts	Burst Period(s)	Wave from Length (s)	Center Frequency(GHz)	-		
16	Type 5	20	0.6	12	5.258			
	Burst ID	Burst Offset (μs)	Pulse Width (μs)	Chirp Width (MHz)	Number of Pulses per Burst	PRI-1 (μs)	PRI-2 (μs)	PRI-3 (μs)
	0	345766	87.6	20	3	1565	1055	1840
	1	490019	85.2	20	3	1735	1541	1408
	2	39073	84.8	20	3	1534	1889	1463
	3	183923	77.9	20	2	1749	1460	-
	4	328777	76.5	20	2	1518	1485	-
	5	474728	60.9	20	1	1540	-	-
	6	21394	83	20	2	1080	1010	-
	7	165992	80.4	20	2	1824	1752	-
	8	310973	67.5	20	2	1764	1181	-
	9	456884	62.1	20	1	1495	-	-
	10	3515	86.4	20	3	1773	1966	1263
	11	147928	84.3	20	3	1593	1188	1788
	12	293225	76.9	20	2	1226	1537	-
	13	436922	95.8	20	3	1192	1298	1844
	14	584015	55.2	20	1	1644	-	-
	15	130832	59	20	1	1402	-	-
	16	274684	94.5	20	3	1296	1700	1283
	17	418579	91.9	20	3	1970	1978	1165
	18	563464	85.2	20	3	1732	1551	1189
	19	112787	69.5	20	2	1038	1224	-
17	Type 5	12	1	12	5.254			
	Burst ID	Burst Offset (μs)	Pulse Width (μs)	Chirp Width (MHz)	Number of Pulses per Burst	PRI-1 (μs)	PRI-2 (μs)	PRI-3 (μs)
	0	429224	86.4	10	3	1259	1918	1455
	1	670241	92.2	10	3	1598	1719	1895
	2	912880	80.4	10	2	1816	1899	-
	3	158603	54.3	10	1	1335	-	-
	4	400824	53.1	10	1	1303	-	-
	5	641915	69.4	10	2	1503	1546	-
	6	883823	69.1	10	2	1279	1639	-
	7	128373	100	10	3	1375	1438	1595
	8	370379	79.6	10	2	1239	1705	-
	9	611194	88.4	10	3	1374	1579	1623
	10	855665	53.3	10	1	1016	-	-
	11	98897	65.3	10	1	1709	-	-

Trial ID	Radar Type	Number of Bursts	Burst Peried(s)	Wave from Length (s)	Center Frequency(GHz)	-		
18	Type 5	14	0.857143	12	5.2548			
	Burst ID	Burst Offset (μs)	Pulse Width (μs)	Chirp Width (MHz)	Number of Pulses per Burst	PRI-1 (μs)	PRI-2 (μs)	PRI-3 (μs)
	0	292143	55.3	12	1	1920	-	-
	1	499633	58.3	12	1	1797	-	-
	2	706377	72.3	12	2	1610	1039	-
	3	58989	84.8	12	3	1131	1761	1721
	4	266161	82.5	12	2	1875	1431	-
	5	474469	63.3	12	1	1095	-	-
	6	680544	80	12	2	1119	1913	-
	7	33519	90.3	12	3	1660	1853	1123
	8	240319	91.1	12	3	1539	1783	1172
	9	447400	96.6	12	3	1525	1036	1385
	10	654516	82.7	12	2	1710	1990	-
	11	8083	50.7	12	1	1234	-	-
	12	215435	78.4	12	2	1047	1109	-
	13	421325	99.5	12	3	1299	1965	1869
19	Type 5	12	1	12	5.254			
	Burst ID	Burst Offset (μs)	Pulse Width (μs)	Chirp Width (MHz)	Number of Pulses per Burst	PRI-1 (μs)	PRI-2 (μs)	PRI-3 (μs)
	0	733725	88.6	10	3	1501	1067	1927
	1	977882	57.4	10	1	1723	-	-
	2	221197	96.6	10	3	1086	1658	1324
	3	462915	69.7	10	2	1751	1945	-
	4	705071	77.9	10	2	1642	1317	-
	5	947923	62	10	1	1866	-	-
	6	191373	88.4	10	3	1997	1077	1366
	7	432561	97.3	10	3	1790	1896	1367
	8	674004	96.2	10	3	1391	1787	1672
	9	915842	95.4	10	3	1020	1892	1414
	10	162176	54.8	10	1	1084	-	-
	11	403553	80.4	10	2	1850	1436	-

Trial ID	Radar Type	Number of Bursts	Burst Period(s)	Wave from Length (s)	Center Frequency(GHz)	-		
20	Type 5	16	0.75	12	5.324			
	Burst ID	Burst Offset (μs)	Pulse Width (μs)	Chirp Width (MHz)	Number of Pulses per Burst	PRI-1 (μs)	PRI-2 (μs)	PRI-3 (μs)
	0	483470	74.7	15	2	1619	1611	-
	1	666072	57.1	15	1	1560	-	-
	2	98810	91.9	15	3	1392	1475	1276
	3	279914	83.1	15	2	1809	1772	-
	4	462536	50.7	15	1	1003	-	-
	5	642324	79.2	15	2	1574	1600	-
	6	76831	58.7	15	1	1186	-	-
	7	257785	71	15	2	1521	1567	-
	8	438554	79	15	2	1777	1960	-
	9	620397	68.5	15	2	1284	1428	-
	10	54310	73.5	15	2	1904	1352	-
	11	235506	70.5	15	2	1864	1115	-
	12	417036	76.6	15	2	1045	1300	-
	13	597974	81.2	15	2	1160	1675	-
	14	32086	61.8	15	1	1277	-	-
	15	212751	94.9	15	3	1450	1206	1860
21	Type 5	12	1	12	5.3264			
	Burst ID	Burst Offset (μs)	Pulse Width (μs)	Chirp Width (MHz)	Number of Pulses per Burst	PRI-1 (μs)	PRI-2 (μs)	PRI-3 (μs)
	0	526149	78.5	9	2	1653	1698	-
	1	767135	89.8	9	3	1174	1962	1167
	2	12955	59.4	9	1	1982	-	-
	3	254612	79.6	9	2	1633	1890	-
	4	496588	76	9	2	1112	1811	-
	5	739728	53.6	9	1	1144	-	-
	6	980872	80.9	9	2	1220	1053	-
	7	225249	61.6	9	1	1724	-	-
	8	467279	53.4	9	1	1901	-	-
	9	709720	59.9	9	1	1379	-	-
	10	951847	60.4	9	1	1453	-	-
	11	194839	91.4	9	3	1768	1726	1227

Trial ID	Radar Type	Number of Bursts	Burst Peried(s)	Wave from Length (s)	Center Frequency(GHz)	-		
22	Type 5	20	0.6	12	5.322			
	Burst ID	Burst Offset (μs)	Pulse Width (μs)	Chirp Width (MHz)	Number of Pulses per Burst	PRI-1 (μs)	PRI-2 (μs)	PRI-3 (μs)
	0	261858	77	20	2	1191	1363	-
	1	407646	58.1	20	1	1248	-	-
	2	552319	62.1	20	1	1836	-	-
	3	99107	76.9	20	2	1334	1236	-
	4	243514	80	20	2	1914	1852	-
	5	389464	52	20	1	1701	-	-
	6	531093	88.6	20	3	1693	1995	1905
	7	81159	72.9	20	2	1922	1387	-
	8	225245	98.5	20	3	1839	1746	1389
	9	371906	57.9	20	1	1193	-	-
	10	514197	95.9	20	3	1659	1870	1066
	11	63561	53.5	20	1	1162	-	-
	12	207510	92	20	3	1745	1654	1458
	13	353638	57.3	20	1	1834	-	-
	14	497515	70.5	20	2	1684	1586	-
	15	45553	70	20	2	1042	1664	-
	16	189821	84	20	3	1765	1630	1176
	17	335330	76.1	20	2	1557	1057	-
	18	478825	93.2	20	3	1985	1018	1340
	19	27594	96.8	20	3	1760	1614	1817
23	Type 5	14	0.857143	12	5.3252			
	Burst ID	Burst Offset (μs)	Pulse Width (μs)	Chirp Width (MHz)	Number of Pulses per Burst	PRI-1 (μs)	PRI-2 (μs)	PRI-3 (μs)
	0	247117	50.1	12	1	1841	-	-
	1	453362	93.5	12	3	1590	1081	1413
	2	660875	68.8	12	2	1707	1577	-
	3	14140	56.3	12	1	1056	-	-
	4	220734	86	12	3	1953	1108	1987
	5	428367	75.2	12	2	1572	1536	-
	6	636681	54.4	12	1	1517	-	-
	7	843157	71.1	12	2	1329	1243	-
	8	195585	76.2	12	2	1940	1770	-
	9	403231	80.2	12	2	1098	1209	-
	10	610202	79.7	12	2	1588	1214	-
	11	815229	90.9	12	3	1615	1862	1601
	12	170267	68.7	12	2	1377	1441	-
	13	377306	67.4	12	2	1872	1313	-

Trial ID	Radar Type	Number of Bursts	Burst Peried(s)	Wave from Length (s)	Center Frequency(GHz)	-		
24	Type 5	13	0.923077	12	5.3256			
	Burst ID	Burst Offset (μs)	Pulse Width (μs)	Chirp Width (MHz)	Number of Pulses per Burst	PRI-1 (μs)	PRI-2 (μs)	PRI-3 (μs)
	0	628071	94	11	3	1643	1748	1941
	1	853391	70.8	11	2	1177	1201	-
	2	156223	56.3	11	1	1006	-	-
	3	378734	96.7	11	3	1230	1163	1332
	4	601331	90.6	11	3	1217	1582	1498
	5	825462	74.5	11	2	1569	1281	-
	6	128265	92.6	11	3	1065	1669	1222
	7	351161	89	11	3	1493	1135	1380
	8	573425	96.5	11	3	1607	1822	1602
	9	798431	70.5	11	2	1141	1178	-
	10	100737	94	11	3	1009	1629	1956
	11	324661	55.8	11	1	1290	-	-
	12	546278	87.7	11	3	1435	1963	1164
25	Type 5	8	1.5	12	5.328			
	Burst ID	Burst Offset (μs)	Pulse Width (μs)	Chirp Width (MHz)	Number of Pulses per Burst	PRI-1 (μs)	PRI-2 (μs)	PRI-3 (μs)
	0	1253842	68.6	5	2	1306	1161	-
	1	119486	83.1	5	2	1420	1315	-
	2	482958	60.9	5	1	1687	-	-
	3	845641	77.7	5	2	1776	1158	-
	4	1208428	77.4	5	2	1793	1510	-
	5	74748	66.8	5	2	1576	1323	-
	6	438300	63.7	5	1	1333	-	-
	7	800152	91.2	5	3	1409	1681	1275

Trial ID	Radar Type	Number of Bursts	Burst Period(s)	Wave from Length (s)	Center Frequency(GHz)	-		
26	Type 5	17	0.705882	12	5.3236			
	Burst ID	Burst Offset (μs)	Pulse Width (μs)	Chirp Width (MHz)	Number of Pulses per Burst	PRI-1 (μs)	PRI-2 (μs)	PRI-3 (μs)
	0	545865	83.6	16	3	1632	1195	1000
	1	14067	89.4	16	3	1173	1627	1656
	2	184953	55.8	16	1	1532	-	-
	3	353759	90.9	16	3	1981	1554	1998
	4	526388	54.7	16	1	1825	-	-
	5	694806	97.7	16	3	1734	1202	1250
	6	163568	67.5	16	2	1571	1434	-
	7	333410	96.7	16	3	1589	1469	1268
	8	504006	68.3	16	2	1750	1954	-
	9	675297	78.3	16	2	1591	1082	-
	10	142890	55	16	1	1427	-	-
	11	312479	84.9	16	3	1129	1936	1199
	12	482953	74.6	16	2	1959	1856	-
	13	655022	63.3	16	1	1885	-	-
	14	121457	99.8	16	3	1035	1515	1120
	15	292606	63.6	16	1	1647	-	-
	16	461322	87.3	16	3	1931	1051	1831
27	Type 5	19	0.631579	12	5.3224			
	Burst ID	Burst Offset (μs)	Pulse Width (μs)	Chirp Width (MHz)	Number of Pulses per Burst	PRI-1 (μs)	PRI-2 (μs)	PRI-3 (μs)
	0	565136	85.6	19	3	1946	1078	1015
	1	89970	68.6	19	2	1029	1780	-
	2	243121	54.2	19	1	1111	-	-
	3	396034	61.2	19	1	1104	-	-
	4	546225	97.1	19	3	1157	1969	1100
	5	70998	98.3	19	3	1142	1699	1622
	6	224093	62.4	19	1	1655	-	-
	7	376127	80.2	19	2	1126	1769	-
	8	527806	87.5	19	3	1216	1448	1179
	9	52247	85.8	19	3	1847	1348	1472
	10	204582	88.1	19	3	1023	1124	1631
	11	357941	65.3	19	1	1848	-	-
	12	510977	52.5	19	1	1470	-	-
	13	33698	52.3	19	1	1312	-	-
	14	186023	74.1	19	2	1915	1200	-
	15	339327	54.9	19	1	1479	-	-
	16	491053	76.2	19	2	1376	1502	-
	17	14858	60.4	19	1	1758	-	-
	18	167387	81.5	19	2	1491	1103	-

Trial ID	Radar Type	Number of Bursts	Burst Peried(s)	Wave from Length (s)	Center Frequency(GHz)	-		
28	Type 5	12	1	12	5.326			
	Burst ID	Burst Offset (μs)	Pulse Width (μs)	Chirp Width (MHz)	Number of Pulses per Burst	PRI-1 (μs)	PRI-2 (μs)	PRI-3 (μs)
	0	507709	50.5	10	1	1857	-	-
	1	750249	55.7	10	1	1246	-	-
	2	989003	85.8	10	3	1774	1002	1967
	3	235634	76.9	10	2	1125	1474	-
	4	477675	75.1	10	2	1254	1052	-
	5	718312	92.3	10	3	1180	1486	1492
	6	960895	78.1	10	2	1301	1757	-
	7	205370	92.2	10	3	1898	1252	1713
	8	446940	89	10	3	1260	1706	1411
	9	689225	70.9	10	2	1578	1620	-
	10	932305	63.1	10	1	1782	-	-
	11	176231	55.3	10	1	1522	-	-
29	Type 5	18	0.666667	12	5.3232			
	Burst ID	Burst Offset (μs)	Pulse Width (μs)	Chirp Width (MHz)	Number of Pulses per Burst	PRI-1 (μs)	PRI-2 (μs)	PRI-3 (μs)
	0	277485	83.4	17	3	1454	1205	1801
	1	437880	97.3	17	3	1319	1826	1635
	2	598445	90.4	17	3	1079	1986	1674
	3	97088	91.8	17	3	1563	1151	1802
	4	257251	98.2	17	3	1876	1977	1766
	5	419893	59.5	17	1	1952	-	-
	6	580724	80	17	2	1253	1137	-
	7	77366	86.5	17	3	1054	1128	1828
	8	238032	91.1	17	3	1105	1599	1442
	9	398605	93.5	17	3	1867	1373	1087
	10	562025	60.7	17	1	1033	-	-
	11	57684	67.2	17	2	1288	1405	-
	12	219083	61.8	17	1	1585	-	-
	13	379234	79.4	17	2	1933	1667	-
	14	540896	81.4	17	2	1096	1464	-
	15	37916	65.7	17	1	1496	-	-
	16	198794	76	17	2	1733	1255	-
	17	359754	81	17	2	1326	1668	-

Radar Signal 6_5290 MHz

Trial ID	Radar Type	Pulse Width (μs)	PRI (μs)	Pulses per Hop	Hopping Rate (kHz)	Hopping Sequence Length (ms)	Visible Frequency Number
0	Type 6	1	333.3	9	0.3333	300	19
	Frequency List (MHz)	0	1	2	3	4	
	0	5364	5717	5334	5705	5549	
	5	5312	5260	5635	5503	5570	
	10	5347	5508	5292	5447	5588	
	15	5621	5638	5296	5482	5455	
	20	5636	5593	5434	5306	5411	
	25	5556	5378	5478	5432	5341	
	30	5438	5294	5496	5285	5327	
	35	5293	5502	5277	5403	5330	
	40	5612	5720	5544	5615	5561	
	45	5676	5704	5366	5290	5387	
	50	5278	5723	5383	5368	5263	
	55	5630	5375	5718	5281	5604	
	60	5453	5509	5479	5400	5262	
	65	5354	5467	5545	5466	5611	
	70	5715	5402	5568	5641	5396	
	75	5567	5557	5674	5359	5392	
	80	5313	5537	5258	5475	5272	
	85	5388	5474	5555	5410	5355	
	90	5517	5382	5386	5664	5697	
	95	5721	5268	5489	5706	5525	

Trial ID	Radar Type	Pulse Width (μs)	PRI (μs)	Pulses per Hop	Hopping Rate (kHz)	Hopping Sequence Length (ms)	Visible Frequency Number
1	Type 6	1	333.3	9	0.3333	300	12
	Frequency List (MHz)	0	1	2	3	4	
	0	5619	5578	5270	5294	5354	
	5	5660	5710	5666	5399	5656	
	10	5297	5333	5642	5609	5709	
	15	5668	5527	5647	5547	5284	
	20	5375	5395	5384	5444	5705	
	25	5584	5536	5480	5658	5453	
	30	5403	5576	5588	5641	5465	
	35	5674	5580	5623	5559	5627	
	40	5553	5704	5673	5633	5724	
	45	5373	5348	5331	5513	5637	
	50	5544	5314	5585	5697	5257	
	55	5672	5471	5423	5424	5638	
	60	5644	5345	5569	5655	5413	
	65	5271	5415	5550	5371	5335	
	70	5382	5416	5533	5706	5558	
	75	5535	5692	5256	5436	5716	
	80	5385	5669	5458	5349	5456	
	85	5336	5634	5703	5352	5280	
	90	5506	5313	5690	5326	5631	
	95	5628	5546	5289	5490	5590	

Trial ID	Radar Type	Pulse Width (μs)	PRI (μs)	Pulses per Hop	Hopping Rate (kHz)	Hopping Sequence Length (ms)	Visible Frequency Number
2	Type 6	1	333.3	9	0.3333	300	17
	Frequency List (MHz)	0	1	2	3	4	
	0	5302	5342	5681	5455	5611	
	5	5493	5682	5310	5257	5606	
	10	5587	5561	5374	5362	5630	
	15	5322	5320	5502	5475	5364	
	20	5555	5353	5316	5387	5357	
	25	5332	5654	5312	5262	5409	
	30	5522	5547	5410	5618	5253	
	35	5311	5683	5556	5470	5258	
	40	5537	5398	5710	5491	5469	
	45	5670	5465	5704	5456	5406	
	50	5384	5400	5513	5720	5365	
	55	5296	5276	5641	5445	5626	
	60	5564	5620	5395	5334	5290	
	65	5401	5578	5359	5569	5586	
	70	5282	5649	5407	5368	5647	
	75	5643	5509	5592	5675	5678	
	80	5581	5275	5381	5512	5600	
	85	5304	5382	5389	5458	5666	
	90	5419	5642	5350	5526	5519	
	95	5709	5692	5418	5653	5354	

Trial ID	Radar Type	Pulse Width (μs)	PRI (μs)	Pulses per Hop	Hopping Rate (kHz)	Hopping Sequence Length (ms)	Visible Frequency Number
3	Type 6	1	333.3	9	0.3333	300	14
	Frequency List (MHz)	0	1	2	3	4	
	0	5557	5581	5617	5616	5356	
	5	5535	5704	5385	5420	5338	
	10	5518	5350	5415	5651	5313	
	15	5447	5605	5520	5653	5563	
	20	5519	5257	5476	5330	5598	
	25	5506	5515	5366	5443	5661	
	30	5533	5367	5358	5502	5606	
	35	5347	5647	5266	5411	5451	
	40	5334	5332	5709	5667	5394	
	45	5684	5539	5464	5437	5665	
	50	5389	5421	5416	5574	5488	
	55	5536	5580	5279	5439	5324	
	60	5499	5710	5708	5404	5305	
	65	5295	5525	5589	5359	5452	
	70	5576	5272	5492	5388	5551	
	75	5547	5323	5724	5256	5721	
	80	5293	5379	5584	5361	5508	
	85	5479	5693	5341	5655	5715	
	90	5629	5494	5401	5637	5423	
	95	5280	5316	5662	5281	5649	

Trial ID	Radar Type	Pulse Width (μs)	PRI (μs)	Pulses per Hop	Hopping Rate (kHz)	Hopping Sequence Length (ms)	Visible Frequency Number
4	Type 6	1	333.3	9	0.3333	300	17
	Frequency List (MHz)	0	1	2	3	4	
	0	5337	5345	5553	5302	5673	
	5	5577	5629	5460	5583	5642	
	10	5352	5614	5456	5655	5672	
	15	5401	5574	5611	5565	5370	
	20	5571	5588	5295	5468	5303	
	25	5486	5358	5718	5470	5380	
	30	5703	5422	5324	5573	5654	
	35	5426	5263	5634	5661	5462	
	40	5648	5498	5270	5474	5664	
	45	5701	5622	5425	5490	5552	
	50	5265	5597	5467	5300	5432	
	55	5724	5437	5469	5258	5715	
	60	5453	5277	5637	5705	5348	
	65	5593	5262	5561	5251	5255	
	70	5275	5341	5364	5510	5516	
	75	5346	5712	5504	5549	5356	
	80	5527	5376	5264	5447	5442	
	85	5454	5658	5428	5544	5374	
	90	5343	5663	5478	5689	5384	
	95	5372	5707	5274	5292	5466	

Trial ID	Radar Type	Pulse Width (μs)	PRI (μs)	Pulses per Hop	Hopping Rate (kHz)	Hopping Sequence Length (ms)	Visible Frequency Number
5	Type 6	1	333.3	9	0.3333	300	18
	Frequency List (MHz)	0	1	2	3	4	
	0	5592	5584	5489	5463	5418	
	5	5619	5651	5535	5271	5374	
	10	5283	5500	5594	5375	5693	
	15	5604	5714	5610	5562	5482	
	20	5279	5711	5557	5276	5277	
	25	5307	5446	5574	5414	5270	
	30	5408	5281	5691	5428	5624	
	35	5625	5354	5430	5339	5376	
	40	5487	5581	5683	5617	5630	
	45	5644	5705	5483	5342	5519	
	50	5298	5518	5563	5598	5437	
	55	5391	5659	5455	5686	5582	
	60	5697	5469	5628	5294	5319	
	65	5597	5631	5521	5436	5423	
	70	5278	5665	5340	5485	5466	
	75	5438	5315	5275	5614	5330	
	80	5520	5590	5596	5264	5289	
	85	5405	5646	5526	5346	5676	
	90	5267	5539	5349	5600	5258	
	95	5671	5533	5345	5587	5523	

Trial ID	Radar Type	Pulse Width (μs)	PRI (μs)	Pulses per Hop	Hopping Rate (kHz)	Hopping Sequence Length (ms)	Visible Frequency Number
6	Type 6	1	333.3	9	0.3333	300	18
	Frequency List (MHz)	0	1	2	3	4	
	0	5372	5348	5425	5624	5260	
	5	5283	5576	5610	5434	5581	
	10	5689	5289	5635	5570	5714	
	15	5577	5256	5342	5558	5279	
	20	5490	5652	5549	5724	5640	
	25	5634	5552	5300	5448	5409	
	30	5297	5713	5431	5580	5444	
	35	5667	5445	5701	5492	5290	
	40	5326	5286	5621	5382	5280	
	45	5559	5313	5541	5499	5704	
	50	5395	5474	5569	5274	5421	
	55	5698	5625	5345	5374	5657	
	60	5711	5519	5642	5301	5454	
	65	5715	5520	5536	5366	5413	
	70	5414	5378	5417	5316	5428	
	75	5357	5586	5484	5296	5430	
	80	5627	5684	5653	5273	5606	
	85	5465	5363	5491	5352	5355	
	90	5518	5631	5688	5588	5329	
	95	5485	5502	5590	5390	5531	

Trial ID	Radar Type	Pulse Width (μs)	PRI (μs)	Pulses per Hop	Hopping Rate (kHz)	Hopping Sequence Length (ms)	Visible Frequency Number
7	Type 6	1	333.3	9	0.3333	300	22
	Frequency List (MHz)	0	1	2	3	4	
	0	5530	5587	5361	5310	5480	
	5	5325	5598	5685	5500	5410	
	10	5523	5553	5676	5290	5260	
	15	5568	5383	5445	5603	5471	
	20	5498	5514	5690	5638	5697	
	25	5431	5583	5280	5404	5482	
	30	5451	5661	5670	5646	5354	
	35	5642	5331	5633	5594	5267	
	40	5301	5640	5369	5559	5622	
	45	5277	5391	5507	5396	5502	
	50	5552	5494	5271	5650	5620	
	55	5363	5719	5545	5338	5299	
	60	5564	5628	5268	5684	5608	
	65	5283	5343	5584	5572	5673	
	70	5683	5517	5492	5381	5266	
	75	5292	5387	5326	5706	5627	
	80	5682	5262	5367	5276	5716	
	85	5270	5511	5428	5458	5359	
	90	5351	5600	5285	5394	5571	
	95	5400	5265	5327	5643	5313	

Trial ID	Radar Type	Pulse Width (μs)	PRI (μs)	Pulses per Hop	Hopping Rate (kHz)	Hopping Sequence Length (ms)	Visible Frequency Number
8	Type 6	1	333.3	9	0.3333	300	19
	Frequency List (MHz)	0	1	2	3	4	
	0	5310	5351	5297	5374	5322	
	5	5367	5523	5285	5663	5617	
	10	5454	5342	5717	5485	5281	
	15	5656	5510	5548	5648	5409	
	20	5680	5631	5630	5670	5319	
	25	5435	5483	5508	5516	5493	
	30	5647	5627	5386	5506	5462	
	35	5470	5724	5390	5420	5690	
	40	5576	5452	5497	5387	5274	
	45	5320	5487	5479	5560	5605	
	50	5381	5622	5671	5445	5489	
	55	5526	5253	5279	5502	5397	
	60	5629	5440	5678	5704	5544	
	65	5533	5608	5408	5478	5655	
	70	5481	5590	5268	5346	5673	
	75	5254	5295	5258	5459	5372	
	80	5623	5401	5267	5706	5545	
	85	5488	5650	5324	5305	5373	
	90	5559	5464	5660	5344	5698	
	95	5394	5378	5363	5321	5311	

Trial ID	Radar Type	Pulse Width (μs)	PRI (μs)	Pulses per Hop	Hopping Rate (kHz)	Hopping Sequence Length (ms)	Visible Frequency Number
9	Type 6	1	333.3	9	0.3333	300	16
	Frequency List (MHz)	0	1	2	3	4	
	0	5565	5590	5708	5535	5542	
	5	5409	5545	5360	5351	5349	
	10	5288	5606	5283	5583	5302	
	15	5269	5637	5554	5693	5380	
	20	5417	5274	5572	5719	5643	
	25	5682	5287	5686	5612	5550	
	30	5632	5536	5584	5504	5280	
	35	5660	5512	5340	5661	5573	
	40	5604	5415	5435	5530	5271	
	45	5627	5467	5562	5618	5658	
	50	5646	5401	5527	5722	5541	
	55	5268	5336	5714	5372	5473	
	60	5526	5539	5574	5369	5650	
	65	5367	5482	5547	5715	5370	
	70	5598	5252	5464	5484	5439	
	75	5622	5305	5642	5374	5341	
	80	5711	5385	5404	5264	5523	
	85	5448	5326	5451	5270	5667	
	90	5356	5621	5303	5724	5470	
	95	5639	5386	5361	5278	5378	

Trial ID	Radar Type	Pulse Width (μs)	PRI (μs)	Pulses per Hop	Hopping Rate (kHz)	Hopping Sequence Length (ms)	Visible Frequency Number
10	Type 6	1	333.3	9	0.3333	300	15
	Frequency List (MHz)	0	1	2	3	4	
	0	5345	5354	5644	5696	5384	
	5	5548	5470	5435	5514	5653	
	10	5694	5492	5324	5303	5323	
	15	5357	5667	5657	5641	5572	
	20	5425	5440	5610	5711	5616	
	25	5473	5414	5338	5584	5674	
	30	5541	5719	5432	5480	5651	
	35	5431	5457	5348	5615	5254	
	40	5715	5373	5295	5365	5556	
	45	5447	5645	5579	5533	5277	
	50	5703	5298	5252	5566	5280	
	55	5330	5636	5562	5403	5444	
	60	5655	5704	5519	5676	5427	
	65	5596	5568	5583	5450	5640	
	70	5304	5421	5547	5288	5598	
	75	5264	5494	5484	5695	5488	
	80	5495	5660	5293	5527	5639	
	85	5718	5351	5643	5511	5462	
	90	5632	5310	5394	5501	5476	
	95	5576	5327	5378	5333	5362	

Trial ID	Radar Type	Pulse Width (μs)	PRI (μs)	Pulses per Hop	Hopping Rate (kHz)	Hopping Sequence Length (ms)	Visible Frequency Number
11	Type 6	1	333.3	9	0.3333	300	13
	Frequency List (MHz)	0	1	2	3	4	
	0	5503	5593	5580	5382	5604	
	5	5590	5492	5510	5385	5625	
	10	5281	5365	5498	5344	5348	
	15	5319	5285	5686	5386	5336	
	20	5509	5551	5325	5589	5361	
	25	5563	5520	5442	5618	5716	
	30	5411	5459	5681	5300	5315	
	35	5522	5350	5501	5529	5568	
	40	5323	5689	5535	5362	5485	
	45	5427	5253	5637	5667	5628	
	50	5404	5349	5341	5389	5602	
	55	5518	5277	5697	5415	5309	
	60	5394	5464	5508	5639	5391	
	65	5380	5282	5532	5582	5493	
	70	5533	5587	5515	5574	5698	
	75	5483	5614	5530	5676	5265	
	80	5605	5441	5360	5636	5438	
	85	5351	5474	5654	5500	5642	
	90	5321	5579	5482	5610	5684	
	95	5388	5443	5547	5581	5527	

Trial ID	Radar Type	Pulse Width (μs)	PRI (μs)	Pulses per Hop	Hopping Rate (kHz)	Hopping Sequence Length (ms)	Visible Frequency Number
12	Type 6	1	333.3	9	0.3333	300	14
	Frequency List (MHz)	0	1	2	3	4	
	0	5283	5357	5516	5543	5446	
	5	5632	5417	5585	5268	5592	
	10	5459	5545	5406	5693	5365	
	15	5436	5388	5256	5578	5344	
	20	5675	5492	5317	5562	5627	
	25	5512	5723	5546	5652	5380	
	30	5300	5455	5674	5358	5498	
	35	5454	5710	5621	5654	5443	
	40	5504	5678	5359	5407	5336	
	45	5695	5720	5685	5580	5400	
	50	5430	5687	5706	5544	5467	
	55	5419	5289	5438	5559	5506	
	60	5340	5554	5329	5558	5327	
	65	5385	5662	5519	5590	5364	
	70	5550	5657	5355	5259	5673	
	75	5420	5618	5697	5524	5275	
	80	5633	5254	5424	5534	5274	
	85	5465	5315	5415	5269	5488	
	90	5547	5566	5616	5509	5427	
	95	5445	5560	5636	5347	5432	

Trial ID	Radar Type	Pulse Width (μs)	PRI (μs)	Pulses per Hop	Hopping Rate (kHz)	Hopping Sequence Length (ms)	Visible Frequency Number
13	Type 6	1	333.3	9	0.3333	300	17
	Frequency List (MHz)	0	1	2	3	4	
	0	5538	5596	5452	5704	5666	
	5	5674	5439	5660	5431	5324	
	10	5390	5334	5544	5413	5386	
	15	5524	5573	5491	5301	5295	
	20	5352	5269	5530	5406	5535	
	25	5515	5364	5451	5650	5686	
	30	5422	5664	5412	5317	5607	
	35	5318	5496	5326	5417	5429	
	40	5454	5343	5489	5565	5443	
	45	5356	5721	5387	5419	5656	
	50	5298	5475	5283	5281	5519	
	55	5393	5498	5657	5713	5260	
	60	5470	5724	5647	5477	5531	
	65	5278	5594	5597	5663	5259	
	70	5505	5690	5688	5526	5282	
	75	5719	5638	5672	5253	5478	
	80	5338	5630	5450	5632	5266	
	85	5497	5466	5333	5366	5339	
	90	5434	5591	5581	5351	5250	
	95	5411	5442	5264	5545	5527	

Trial ID	Radar Type	Pulse Width (μs)	PRI (μs)	Pulses per Hop	Hopping Rate (kHz)	Hopping Sequence Length (ms)	Visible Frequency Number
14	Type 6	1	333.3	9	0.3333	300	16
	Frequency List (MHz)	0	1	2	3	4	
	0	5318	5360	5388	5390	5508	
	5	5338	5364	5260	5594	5628	
	10	5321	5598	5585	5511	5407	
	15	5612	5700	5497	5724	5487	
	20	5263	5435	5471	5398	5306	
	25	5691	5654	5279	5720	5464	
	30	5650	5369	5532	5284	5516	
	35	5635	5417	5310	5582	5368	
	40	5657	5669	5503	5683	5353	
	45	5553	5270	5502	5714	5351	
	50	5362	5634	5457	5608	5711	
	55	5337	5607	5452	5372	5706	
	60	5599	5414	5396	5576	5303	
	65	5574	5616	5702	5533	5534	
	70	5489	5466	5428	5588	5693	
	75	5537	5478	5293	5402	5387	
	80	5716	5449	5266	5259	5377	
	85	5401	5627	5645	5632	5583	
	90	5557	5561	5298	5320	5339	
	95	5597	5518	5708	5262	5543	

Trial ID	Radar Type	Pulse Width (μs)	PRI (μs)	Pulses per Hop	Hopping Rate (kHz)	Hopping Sequence Length (ms)	Visible Frequency Number
15	Type 6	1	333.3	9	0.3333	300	19
	Frequency List (MHz)	0	1	2	3	4	
	0	5573	5599	5324	5551	5253	
	5	5380	5386	5335	5660	5360	
	10	5630	5484	5626	5706	5428	
	15	5603	5255	5600	5294	5679	
	20	5271	5504	5412	5487	5481	
	25	5669	5640	5382	5480	5279	
	30	5506	5539	5326	5272	5533	
	35	5336	5299	5508	5581	5260	
	40	5282	5496	5277	5441	5448	
	45	5447	5482	5250	5585	5297	
	50	5404	5627	5510	5633	5553	
	55	5319	5534	5659	5320	5406	
	60	5562	5351	5677	5579	5438	
	65	5408	5604	5520	5342	5651	
	70	5569	5366	5284	5647	5500	
	75	5574	5318	5289	5381	5437	
	80	5522	5530	5697	5701	5376	
	85	5515	5444	5561	5624	5365	
	90	5535	5278	5641	5371	5587	
	95	5357	5552	5493	5560	5608	

Trial ID	Radar Type	Pulse Width (μs)	PRI (μs)	Pulses per Hop	Hopping Rate (kHz)	Hopping Sequence Length (ms)	Visible Frequency Number
16	Type 6	1	333.3	9	0.3333	300	15
	Frequency List (MHz)	0	1	2	3	4	
	0	5256	5460	5260	5615	5570	
	5	5422	5311	5410	5348	5567	
	10	5561	5273	5667	5426	5449	
	15	5691	5382	5703	5339	5396	
	20	5279	5670	5353	5479	5454	
	25	5557	5492	5488	5584	5313	
	30	5645	5525	5283	5487	5685	
	35	5534	5341	5599	5377	5413	
	40	5671	5335	5360	5379	5591	
	45	5444	5411	5705	5668	5258	
	50	5457	5514	5289	5334	5604	
	55	5408	5357	5603	5263	5655	
	60	5548	5551	5269	5383	5715	
	65	5527	5466	5640	5600	5508	
	70	5576	5651	5450	5669	5560	
	75	5321	5613	5609	5642	5678	
	80	5478	5486	5296	5608	5624	
	85	5524	5438	5364	5580	5470	
	90	5606	5325	5555	5489	5375	
	95	5480	5674	5663	5282	5573	

Trial ID	Radar Type	Pulse Width (μs)	PRI (μs)	Pulses per Hop	Hopping Rate (kHz)	Hopping Sequence Length (ms)	Visible Frequency Number
17	Type 6	1	333.3	9	0.3333	300	18
	Frequency List (MHz)	0	1	2	3	4	
	0	5511	5699	5671	5301	5315	
	5	5464	5333	5485	5396	5492	
	10	5537	5708	5621	5470	5304	
	15	5509	5331	5287	5588	5665	
	20	5264	5391	5568	5427	5348	
	25	5441	5691	5688	5347	5687	
	30	5414	5715	5605	5459	5354	
	35	5480	5312	5648	5663	5682	
	40	5271	5540	5317	5356	5718	
	45	5685	5276	5316	5413	5640	
	50	5510	5655	5497	5558	5450	
	55	5599	5692	5370	5367	5522	
	60	5434	5328	5547	5353	5412	
	65	5366	5549	5544	5408	5446	
	70	5253	5266	5546	5421	5462	
	75	5355	5481	5719	5659	5633	
	80	5499	5552	5297	5521	5280	
	85	5438	5681	5543	5565	5474	
	90	5279	5608	5375	5619	5712	
	95	5523	5257	5541	5507	5261	

Trial ID	Radar Type	Pulse Width (μs)	PRI (μs)	Pulses per Hop	Hopping Rate (kHz)	Hopping Sequence Length (ms)	Visible Frequency Number
18	Type 6	1	333.3	9	0.3333	300	21
	Frequency List (MHz)	0	1	2	3	4	
	0	5291	5463	5607	5462	5632	
	5	5603	5258	5560	5674	5326	
	10	5274	5341	5491	5392	5636	
	15	5434	5332	5305	5673	5430	
	20	5400	5711	5293	5419	5317	
	25	5381	5254	5303	5672	5345	
	30	5611	5649	5619	5403	5541	
	35	5596	5585	5623	5633	5438	
	40	5647	5665	5359	5374	5466	
	45	5666	5516	5589	5706	5586	
	50	5394	5312	5646	5661	5493	
	55	5543	5599	5273	5476	5276	
	60	5455	5664	5498	5580	5618	
	65	5338	5531	5435	5629	5424	
	70	5311	5309	5314	5450	5310	
	75	5290	5640	5410	5609	5333	
	80	5461	5275	5518	5572	5620	
	85	5506	5282	5342	5330	5573	
	90	5718	5557	5517	5601	5708	
	95	5298	5525	5405	5304	5682	

Trial ID	Radar Type	Pulse Width (μs)	PRI (μs)	Pulses per Hop	Hopping Rate (kHz)	Hopping Sequence Length (ms)	Visible Frequency Number
19	Type 6	1	333.3	9	0.3333	300	21
	Frequency List (MHz)	0	1	2	3	4	
	0	5546	5702	5543	5623	5377	
	5	5645	5280	5635	5265	5335	
	10	5257	5590	5315	5439	5512	
	15	5383	5288	5440	5594	5681	
	20	5596	5273	5649	5373	5502	
	25	5620	5622	5518	5415	5393	
	30	5289	5629	5560	5385	5372	
	35	5283	5494	5337	5510	5424	
	40	5706	5571	5361	5435	5479	
	45	5442	5519	5456	5392	5290	
	50	5282	5297	5679	5716	5500	
	55	5600	5275	5464	5672	5308	
	60	5577	5401	5390	5447	5450	
	65	5608	5334	5507	5615	5524	
	70	5285	5322	5430	5433	5621	
	75	5662	5719	5589	5528	5515	
	80	5292	5462	5566	5307	5284	
	85	5296	5474	5724	5399	5710	
	90	5250	5353	5509	5303	5597	
	95	5407	5428	5562	5678	5300	

Trial ID	Radar Type	Pulse Width (μs)	PRI (μs)	Pulses per Hop	Hopping Rate (kHz)	Hopping Sequence Length (ms)	Visible Frequency Number
20	Type 6	1	333.3	9	0.3333	300	14
	Frequency List (MHz)	0	1	2	3	4	
	0	5704	5466	5479	5309	5597	
	5	5687	5680	5710	5428	5639	
	10	5566	5379	5356	5634	5533	
	15	5471	5318	5543	5422	5311	
	20	5592	5665	5641	5443	5390	
	25	5569	5350	5622	5449	5435	
	30	5653	5586	5300	5537	5667	
	35	5325	5585	5608	5269	5521	
	40	5263	5314	5509	5504	5529	
	45	5408	5528	5525	5393	5572	
	50	5343	5646	5333	5386	5502	
	55	5660	5688	5554	5465	5677	
	60	5338	5326	5454	5260	5615	
	65	5403	5347	5591	5396	5555	
	70	5515	5579	5601	5527	5387	
	75	5261	5707	5291	5550	5602	
	80	5439	5257	5370	5692	5498	
	85	5512	5487	5719	5401	5650	
	90	5335	5402	5255	5659	5722	
	95	5364	5493	5676	5510	5700	

Trial ID	Radar Type	Pulse Width (μs)	PRI (μs)	Pulses per Hop	Hopping Rate (kHz)	Hopping Sequence Length (ms)	Visible Frequency Number
21	Type 6	1	333.3	9	0.3333	300	17
	Frequency List (MHz)	0	1	2	3	4	
	0	5484	5705	5415	5470	5439	
	5	5351	5702	5310	5591	5371	
	10	5497	5265	5494	5354	5554	
	15	5559	5445	5646	5370	5503	
	20	5600	5356	5252	5255	5416	
	25	5656	5421	5456	5251	5483	
	30	5477	5542	5543	5418	5311	
	35	5390	5464	5676	5501	5422	
	40	5435	5674	5447	5269	5526	
	45	5337	5508	5608	5451	5625	
	50	5522	5642	5384	5475	5703	
	55	5507	5401	5655	5496	5309	
	60	5455	5619	5680	5326	5414	
	65	5345	5492	5295	5318	5273	
	70	5587	5530	5711	5615	5666	
	75	5638	5670	5622	5583	5691	
	80	5367	5626	5381	5561	5412	
	85	5682	5718	5589	5286	5289	
	90	5553	5314	5329	5261	5465	
	95	5541	5463	5574	5671	5458	

Trial ID	Radar Type	Pulse Width (μs)	PRI (μs)	Pulses per Hop	Hopping Rate (kHz)	Hopping Sequence Length (ms)	Visible Frequency Number
22	Type 6	1	333.3	9	0.3333	300	10
	Frequency List (MHz)	0	1	2	3	4	
	0	5264	5469	5351	5631	5659	
	5	5393	5627	5385	5279	5578	
	10	5428	5529	5535	5549	5575	
	15	5647	5572	5274	5415	5695	
	20	5608	5425	5668	5722	5389	
	25	5544	5370	5355	5517	5616	
	30	5528	5500	5633	5463	5685	
	35	5603	5292	5297	5349	5513	
	40	5577	5509	5523	5644	5488	
	45	5691	5412	5678	5495	5398	
	50	5343	5435	5564	5526	5451	
	55	5589	5462	5315	5280	5584	
	60	5309	5625	5336	5615	5294	
	65	5530	5702	5565	5596	5345	
	70	5670	5630	5560	5591	5607	
	75	5693	5468	5477	5407	5545	
	80	5721	5409	5402	5525	5552	
	85	5381	5483	5340	5326	5609	
	90	5494	5364	5499	5423	5465	
	95	5518	5558	5569	5716	5718	

Trial ID	Radar Type	Pulse Width (μs)	PRI (μs)	Pulses per Hop	Hopping Rate (kHz)	Hopping Sequence Length (ms)	Visible Frequency Number
23	Type 6	1	333.3	9	0.3333	300	15
	Frequency List (MHz)	0	1	2	3	4	
	0	5519	5708	5287	5695	5501	
	5	5435	5649	5460	5442	5407	
	10	5262	5318	5576	5269	5596	
	15	5638	5699	5377	5412	5591	
	20	5706	5336	5362	5432	5697	
	25	5387	5556	5454	5658	5417	
	30	5457	5373	5712	5408	5645	
	35	5480	5568	5350	5360	5352	
	40	5660	5323	5652	5520	5573	
	45	5468	5299	5470	5634	5285	
	50	5274	5486	5275	5349	5298	
	55	5680	5416	5463	5512	5251	
	60	5713	5474	5667	5683	5453	
	65	5282	5438	5718	5566	5534	
	70	5399	5514	5656	5633	5409	
	75	5567	5584	5338	5545	5623	
	80	5490	5663	5612	5309	5406	
	85	5694	5525	5499	5448	5294	
	90	5574	5332	5659	5370	5436	
	95	5477	5415	5542	5467	5319	

Trial ID	Radar Type	Pulse Width (μs)	PRI (μs)	Pulses per Hop	Hopping Rate (kHz)	Hopping Sequence Length (ms)	Visible Frequency Number
24	Type 6	1	333.3	9	0.3333	300	15
	Frequency List (MHz)	0	1	2	3	4	
	0	5299	5472	5698	5381	5721	
	5	5477	5574	5535	5508	5614	
	10	5668	5582	5617	5367	5251	
	15	5351	5383	5505	5604	5527	
	20	5660	5647	5328	5335	5549	
	25	5590	5488	5700	5403	5414	
	30	5588	5389	5703	5309	5571	
	35	5364	5503	5274	5666	5365	
	40	5261	5417	5517	5405	5448	
	45	5382	5528	5687	5695	5537	
	50	5717	5393	5370	5653	5331	
	55	5600	5270	5639	5612	5515	
	60	5376	5667	5269	5252	5677	
	65	5586	5642	5258	5636	5543	
	70	5458	5479	5623	5400	5444	
	75	5301	5372	5428	5341	5575	
	80	5290	5316	5345	5347	5627	
	85	5349	5470	5565	5432	5628	
	90	5676	5447	5672	5552	5468	
	95	5469	5359	5321	5325	5678	

Trial ID	Radar Type	Pulse Width (μs)	PRI (μs)	Pulses per Hop	Hopping Rate (kHz)	Hopping Sequence Length (ms)	Visible Frequency Number
25	Type 6	1	333.3	9	0.3333	300	15
	Frequency List (MHz)	0	1	2	3	4	
	0	5457	5711	5634	5542	5563	
	5	5616	5596	5610	5671	5346	
	10	5599	5371	5658	5562	5638	
	15	5339	5381	5486	5453	5321	
	20	5535	5351	5588	5417	5308	
	25	5586	5498	5318	5289	5522	
	30	5364	5292	5706	5426	5448	
	35	5662	5257	5656	5663	5505	
	40	5674	5657	5514	5334	5428	
	45	5465	5489	5265	5437	5404	
	50	5396	5373	5564	5581	5324	
	55	5368	5625	5571	5399	5329	
	60	5557	5347	5677	5271	5462	
	65	5541	5576	5383	5280	5250	
	70	5261	5485	5519	5502	5578	
	75	5525	5604	5652	5613	5700	
	80	5435	5400	5609	5331	5635	
	85	5385	5281	5299	5595	5350	
	90	5382	5407	5695	5546	5683	
	95	5607	5263	5655	5550	5459	

Trial ID	Radar Type	Pulse Width (μs)	PRI (μs)	Pulses per Hop	Hopping Rate (kHz)	Hopping Sequence Length (ms)	Visible Frequency Number
26	Type 6	1	333.3	9	0.3333	300	16
	Frequency List (MHz)	0	1	2	3	4	
	0	5712	5475	5570	5703	5308	
	5	5658	5521	5685	5359	5650	
	10	5433	5257	5699	5282	5659	
	15	5427	5508	5589	5498	5610	
	20	5446	5420	5626	5409	5281	
	25	5377	5350	5424	5393	5556	
	30	5406	5656	5328	5315	5721	
	35	5587	5278	5528	5431	5674	
	40	5441	5531	5515	5422	5608	
	45	5263	5408	5548	5547	5318	
	50	5324	5280	5572	5639	5542	
	55	5671	5294	5558	5347	5494	
	60	5502	5654	5600	5692	5663	
	65	5662	5577	5311	5414	5661	
	70	5352	5711	5361	5334	5398	
	75	5461	5289	5698	5668	5585	
	80	5429	5723	5481	5629	5595	
	85	5300	5329	5331	5597	5598	
	90	5624	5368	5645	5679	5485	
	95	5707	5563	5591	5636	5537	

Trial ID	Radar Type	Pulse Width (μs)	PRI (μs)	Pulses per Hop	Hopping Rate (kHz)	Hopping Sequence Length (ms)	Visible Frequency Number
27	Type 6	1	333.3	9	0.3333	300	16
	Frequency List (MHz)	0	1	2	3	4	
	0	5492	5714	5506	5389	5625	
	5	5700	5543	5285	5522	5382	
	10	5364	5521	5265	5477	5680	
	15	5418	5635	5692	5327	5454	
	20	5586	5567	5498	5254	5299	
	25	5627	5594	5590	5448	5642	
	30	5661	5564	5541	5629	5369	
	35	5324	5584	5588	5280	5614	
	40	5453	5565	5605	5570	5291	
	45	5631	5371	5589	5534	5273	
	50	5690	5494	5355	5482	5707	
	55	5641	5513	5657	5659	5544	
	60	5486	5426	5638	5611	5516	
	65	5618	5684	5464	5697	5658	
	70	5374	5420	5258	5721	5566	
	75	5681	5358	5262	5696	5297	
	80	5621	5709	5439	5672	5304	
	85	5616	5368	5491	5475	5341	
	90	5580	5318	5281	5380	5519	
	95	5537	5362	5645	5524	5325	

Trial ID	Radar Type	Pulse Width (μs)	PRI (μs)	Pulses per Hop	Hopping Rate (kHz)	Hopping Sequence Length (ms)	Visible Frequency Number
28	Type 6	1	333.3	9	0.3333	300	19
	Frequency List (MHz)	0	1	2	3	4	
	0	5272	5478	5539	5550	5370	
	5	5267	5565	5360	5588	5589	
	10	5295	5310	5306	5672	5701	
	15	5506	5287	5320	5491	5519	
	20	5462	5655	5508	5490	5702	
	25	5531	5626	5355	5698	5624	
	30	5717	5401	5716	5264	5293	
	35	5557	5692	5262	5502	5594	
	40	5319	5391	5330	5602	5499	
	45	5271	5336	5663	5424	5476	
	50	5410	5449	5266	5342	5317	
	55	5299	5670	5564	5463	5460	
	60	5387	5311	5349	5489	5415	
	65	5252	5681	5687	5560	5552	
	70	5353	5576	5593	5683	5464	
	75	5507	5350	5379	5605	5366	
	80	5382	5547	5361	5371	5518	
	85	5385	5721	5294	5341	5612	
	90	5378	5621	5389	5457	5292	
	95	5534	5497	5412	5374	5597	

Trial ID	Radar Type	Pulse Width (μs)	PRI (μs)	Pulses per Hop	Hopping Rate (kHz)	Hopping Sequence Length (ms)	Visible Frequency Number
29	Type 6	1	333.3	9	0.3333	300	17
	Frequency List (MHz)	0	1	2	3	4	
	0	5430	5717	5475	5711	5687	
	5	5406	5490	5435	5276	5321	
	10	5604	5574	5444	5295	5722	
	15	5594	5414	5326	5536	5373	
	20	5346	5546	5579	5675	5419	
	25	5478	5558	5327	5658	5629	
	30	5420	5674	5519	5559	5432	
	35	5648	5488	5512	5513	5433	
	40	5402	5329	5570	5599	5331	
	45	5251	5624	5477	5266	5286	
	50	5625	5317	5431	5518	5621	
	55	5653	5279	5358	5343	5514	
	60	5434	5650	5627	5413	5509	
	65	5491	5660	5371	5545	5665	
	70	5291	5467	5259	5338	5486	
	75	5428	5528	5613	5481	5299	
	80	5549	5309	5612	5695	5681	
	85	5581	5422	5540	5386	5699	
	90	5503	5446	5256	5462	5640	
	95	5427	5377	5487	5398	5307	

Radar Signal 6_5320 MHz

Trial ID	Radar Type	Pulse Width (μs)	PRI (μs)	Pulses per Hop	Hopping Rate (kHz)	Hopping Sequence Length (ms)	Visible Frequency Number
0	Type 6	1	333.3	9	0.3333	300	3
	Frequency List (MHz)	0	1	2	3	4	
	0	5364	5717	5334	5705	5549	
	5	5312	5260	5635	5503	5570	
	10	5347	5508	5292	5447	5588	
	15	5621	5638	5296	5482	5455	
	20	5636	5593	5434	5306	5411	
	25	5556	5378	5478	5432	5341	
	30	5438	5294	5496	5285	5327	
	35	5293	5502	5277	5403	5330	
	40	5612	5720	5544	5615	5561	
	45	5676	5704	5366	5290	5387	
	50	5278	5723	5383	5368	5263	
	55	5630	5375	5718	5281	5604	
	60	5453	5509	5479	5400	5262	
	65	5354	5467	5545	5466	5611	
	70	5715	5402	5568	5641	5396	
	75	5567	5557	5674	5359	5392	
	80	5313	5537	5258	5475	5272	
	85	5388	5474	5555	5410	5355	
	90	5517	5382	5386	5664	5697	
	95	5721	5268	5489	5706	5525	

Trial ID	Radar Type	Pulse Width (μs)	PRI (μs)	Pulses per Hop	Hopping Rate (kHz)	Hopping Sequence Length (ms)	Visible Frequency Number
1	Type 6	1	333.3	9	0.3333	300	3
	Frequency List (MHz)	0	1	2	3	4	
	0	5619	5578	5270	5294	5354	
	5	5660	5710	5666	5399	5656	
	10	5297	5333	5642	5609	5709	
	15	5668	5527	5647	5547	5284	
	20	5375	5395	5384	5444	5705	
	25	5584	5536	5480	5658	5453	
	30	5403	5576	5588	5641	5465	
	35	5674	5580	5623	5559	5627	
	40	5553	5704	5673	5633	5724	
	45	5373	5348	5331	5513	5637	
	50	5544	5314	5585	5697	5257	
	55	5672	5471	5423	5424	5638	
	60	5644	5345	5569	5655	5413	
	65	5271	5415	5550	5371	5335	
	70	5382	5416	5533	5706	5558	
	75	5535	5692	5256	5436	5716	
	80	5385	5669	5458	5349	5456	
	85	5336	5634	5703	5352	5280	
	90	5506	5313	5690	5326	5631	
	95	5628	5546	5289	5490	5590	

Trial ID	Radar Type	Pulse Width (μs)	PRI (μs)	Pulses per Hop	Hopping Rate (kHz)	Hopping Sequence Length (ms)	Visible Frequency Number
2	Type 6	1	333.3	9	0.3333	300	5
	Frequency List (MHz)	0	1	2	3	4	
	0	5302	5342	5681	5455	5611	
	5	5493	5682	5310	5257	5606	
	10	5587	5561	5374	5362	5630	
	15	5322	5320	5502	5475	5364	
	20	5555	5353	5316	5387	5357	
	25	5332	5654	5312	5262	5409	
	30	5522	5547	5410	5618	5253	
	35	5311	5683	5556	5470	5258	
	40	5537	5398	5710	5491	5469	
	45	5670	5465	5704	5456	5406	
	50	5384	5400	5513	5720	5365	
	55	5296	5276	5641	5445	5626	
	60	5564	5620	5395	5334	5290	
	65	5401	5578	5359	5569	5586	
	70	5282	5649	5407	5368	5647	
	75	5643	5509	5592	5675	5678	
	80	5581	5275	5381	5512	5600	
	85	5304	5382	5389	5458	5666	
	90	5419	5642	5350	5526	5519	
	95	5709	5692	5418	5653	5354	

Trial ID	Radar Type	Pulse Width (μs)	PRI (μs)	Pulses per Hop	Hopping Rate (kHz)	Hopping Sequence Length (ms)	Visible Frequency Number
3	Type 6	1	333.3	9	0.3333	300	4
	Frequency List (MHz)	0	1	2	3	4	
	0	5557	5581	5617	5616	5356	
	5	5535	5704	5385	5420	5338	
	10	5518	5350	5415	5651	5313	
	15	5447	5605	5520	5653	5563	
	20	5519	5257	5476	5330	5598	
	25	5506	5515	5366	5443	5661	
	30	5533	5367	5358	5502	5606	
	35	5347	5647	5266	5411	5451	
	40	5334	5332	5709	5667	5394	
	45	5684	5539	5464	5437	5665	
	50	5389	5421	5416	5574	5488	
	55	5536	5580	5279	5439	5324	
	60	5499	5710	5708	5404	5305	
	65	5295	5525	5589	5359	5452	
	70	5576	5272	5492	5388	5551	
	75	5547	5323	5724	5256	5721	
	80	5293	5379	5584	5361	5508	
	85	5479	5693	5341	5655	5715	
	90	5629	5494	5401	5637	5423	
	95	5280	5316	5662	5281	5649	

Trial ID	Radar Type	Pulse Width (μs)	PRI (μs)	Pulses per Hop	Hopping Rate (kHz)	Hopping Sequence Length (ms)	Visible Frequency Number
4	Type 6	1	333.3	9	0.3333	300	1
	Frequency List (MHz)	0	1	2	3	4	
	0	5337	5345	5553	5302	5673	
	5	5577	5629	5460	5583	5642	
	10	5352	5614	5456	5655	5672	
	15	5401	5574	5611	5565	5370	
	20	5571	5588	5295	5468	5303	
	25	5486	5358	5718	5470	5380	
	30	5703	5422	5324	5573	5654	
	35	5426	5263	5634	5661	5462	
	40	5648	5498	5270	5474	5664	
	45	5701	5622	5425	5490	5552	
	50	5265	5597	5467	5300	5432	
	55	5724	5437	5469	5258	5715	
	60	5453	5277	5637	5705	5348	
	65	5593	5262	5561	5251	5255	
	70	5275	5341	5364	5510	5516	
	75	5346	5712	5504	5549	5356	
	80	5527	5376	5264	5447	5442	
	85	5454	5658	5428	5544	5374	
	90	5343	5663	5478	5689	5384	
	95	5372	5707	5274	5292	5466	

Trial ID	Radar Type	Pulse Width (μs)	PRI (μs)	Pulses per Hop	Hopping Rate (kHz)	Hopping Sequence Length (ms)	Visible Frequency Number
5	Type 6	1	333.3	9	0.3333	300	2
	Frequency List (MHz)	0	1	2	3	4	
	0	5592	5584	5489	5463	5418	
	5	5619	5651	5535	5271	5374	
	10	5283	5500	5594	5375	5693	
	15	5604	5714	5610	5562	5482	
	20	5279	5711	5557	5276	5277	
	25	5307	5446	5574	5414	5270	
	30	5408	5281	5691	5428	5624	
	35	5625	5354	5430	5339	5376	
	40	5487	5581	5683	5617	5630	
	45	5644	5705	5483	5342	5519	
	50	5298	5518	5563	5598	5437	
	55	5391	5659	5455	5686	5582	
	60	5697	5469	5628	5294	5319	
	65	5597	5631	5521	5436	5423	
	70	5278	5665	5340	5485	5466	
	75	5438	5315	5275	5614	5330	
	80	5520	5590	5596	5264	5289	
	85	5405	5646	5526	5346	5676	
	90	5267	5539	5349	5600	5258	
	95	5671	5533	5345	5587	5523	

Trial ID	Radar Type	Pulse Width (μs)	PRI (μs)	Pulses per Hop	Hopping Rate (kHz)	Hopping Sequence Length (ms)	Visible Frequency Number
6	Type 6	1	333.3	9	0.3333	300	4
	Frequency List (MHz)	0	1	2	3	4	
	0	5372	5348	5425	5624	5260	
	5	5283	5576	5610	5434	5581	
	10	5689	5289	5635	5570	5714	
	15	5577	5256	5342	5558	5279	
	20	5490	5652	5549	5724	5640	
	25	5634	5552	5300	5448	5409	
	30	5297	5713	5431	5580	5444	
	35	5667	5445	5701	5492	5290	
	40	5326	5286	5621	5382	5280	
	45	5559	5313	5541	5499	5704	
	50	5395	5474	5569	5274	5421	
	55	5698	5625	5345	5374	5657	
	60	5711	5519	5642	5301	5454	
	65	5715	5520	5536	5366	5413	
	70	5414	5378	5417	5316	5428	
	75	5357	5586	5484	5296	5430	
	80	5627	5684	5653	5273	5606	
	85	5465	5363	5491	5352	5355	
	90	5518	5631	5688	5588	5329	
	95	5485	5502	5590	5390	5531	

Trial ID	Radar Type	Pulse Width (μs)	PRI (μs)	Pulses per Hop	Hopping Rate (kHz)	Hopping Sequence Length (ms)	Visible Frequency Number
7	Type 6	1	333.3	9	0.3333	300	4
	Frequency List (MHz)	0	1	2	3	4	
	0	5530	5587	5361	5310	5480	
	5	5325	5598	5685	5500	5410	
	10	5523	5553	5676	5290	5260	
	15	5568	5383	5445	5603	5471	
	20	5498	5514	5690	5638	5697	
	25	5431	5583	5280	5404	5482	
	30	5451	5661	5670	5646	5354	
	35	5642	5331	5633	5594	5267	
	40	5301	5640	5369	5559	5622	
	45	5277	5391	5507	5396	5502	
	50	5552	5494	5271	5650	5620	
	55	5363	5719	5545	5338	5299	
	60	5564	5628	5268	5684	5608	
	65	5283	5343	5584	5572	5673	
	70	5683	5517	5492	5381	5266	
	75	5292	5387	5326	5706	5627	
	80	5682	5262	5367	5276	5716	
	85	5270	5511	5428	5458	5359	
	90	5351	5600	5285	5394	5571	
	95	5400	5265	5327	5643	5313	

Trial ID	Radar Type	Pulse Width (μs)	PRI (μs)	Pulses per Hop	Hopping Rate (kHz)	Hopping Sequence Length (ms)	Visible Frequency Number
8	Type 6	1	333.3	9	0.3333	300	6
	Frequency List (MHz)	0	1	2	3	4	
	0	5310	5351	5297	5374	5322	
	5	5367	5523	5285	5663	5617	
	10	5454	5342	5717	5485	5281	
	15	5656	5510	5548	5648	5409	
	20	5680	5631	5630	5670	5319	
	25	5435	5483	5508	5516	5493	
	30	5647	5627	5386	5506	5462	
	35	5470	5724	5390	5420	5690	
	40	5576	5452	5497	5387	5274	
	45	5320	5487	5479	5560	5605	
	50	5381	5622	5671	5445	5489	
	55	5526	5253	5279	5502	5397	
	60	5629	5440	5678	5704	5544	
	65	5533	5608	5408	5478	5655	
	70	5481	5590	5268	5346	5673	
	75	5254	5295	5258	5459	5372	
	80	5623	5401	5267	5706	5545	
	85	5488	5650	5324	5305	5373	
	90	5559	5464	5660	5344	5698	
	95	5394	5378	5363	5321	5311	

Trial ID	Radar Type	Pulse Width (μs)	PRI (μs)	Pulses per Hop	Hopping Rate (kHz)	Hopping Sequence Length (ms)	Visible Frequency Number
9	Type 6	1	333.3	9	0.3333	300	1
	Frequency List (MHz)	0	1	2	3	4	
	0	5565	5590	5708	5535	5542	
	5	5409	5545	5360	5351	5349	
	10	5288	5606	5283	5583	5302	
	15	5269	5637	5554	5693	5380	
	20	5417	5274	5572	5719	5643	
	25	5682	5287	5686	5612	5550	
	30	5632	5536	5584	5504	5280	
	35	5660	5512	5340	5661	5573	
	40	5604	5415	5435	5530	5271	
	45	5627	5467	5562	5618	5658	
	50	5646	5401	5527	5722	5541	
	55	5268	5336	5714	5372	5473	
	60	5526	5539	5574	5369	5650	
	65	5367	5482	5547	5715	5370	
	70	5598	5252	5464	5484	5439	
	75	5622	5305	5642	5374	5341	
	80	5711	5385	5404	5264	5523	
	85	5448	5326	5451	5270	5667	
	90	5356	5621	5303	5724	5470	
	95	5639	5386	5361	5278	5378	

Trial ID	Radar Type	Pulse Width (μs)	PRI (μs)	Pulses per Hop	Hopping Rate (kHz)	Hopping Sequence Length (ms)	Visible Frequency Number
10	Type 6	1	333.3	9	0.3333	300	3
	Frequency List (MHz)	0	1	2	3	4	
	0	5345	5354	5644	5696	5384	
	5	5548	5470	5435	5514	5653	
	10	5694	5492	5324	5303	5323	
	15	5357	5667	5657	5641	5572	
	20	5425	5440	5610	5711	5616	
	25	5473	5414	5338	5584	5674	
	30	5541	5719	5432	5480	5651	
	35	5431	5457	5348	5615	5254	
	40	5715	5373	5295	5365	5556	
	45	5447	5645	5579	5533	5277	
	50	5703	5298	5252	5566	5280	
	55	5330	5636	5562	5403	5444	
	60	5655	5704	5519	5676	5427	
	65	5596	5568	5583	5450	5640	
	70	5304	5421	5547	5288	5598	
	75	5264	5494	5484	5695	5488	
	80	5495	5660	5293	5527	5639	
	85	5718	5351	5643	5511	5462	
	90	5632	5310	5394	5501	5476	
	95	5576	5327	5378	5333	5362	

Trial ID	Radar Type	Pulse Width (μs)	PRI (μs)	Pulses per Hop	Hopping Rate (kHz)	Hopping Sequence Length (ms)	Visible Frequency Number
11	Type 6	1	333.3	9	0.3333	300	5
	Frequency List (MHz)	0	1	2	3	4	
	0	5503	5593	5580	5382	5604	
	5	5590	5492	5510	5385	5625	
	10	5281	5365	5498	5344	5348	
	15	5319	5285	5686	5386	5336	
	20	5509	5551	5325	5589	5361	
	25	5563	5520	5442	5618	5716	
	30	5411	5459	5681	5300	5315	
	35	5522	5350	5501	5529	5568	
	40	5323	5689	5535	5362	5485	
	45	5427	5253	5637	5667	5628	
	50	5404	5349	5341	5389	5602	
	55	5518	5277	5697	5415	5309	
	60	5394	5464	5508	5639	5391	
	65	5380	5282	5532	5582	5493	
	70	5533	5587	5515	5574	5698	
	75	5483	5614	5530	5676	5265	
	80	5605	5441	5360	5636	5438	
	85	5351	5474	5654	5500	5642	
	90	5321	5579	5482	5610	5684	
	95	5388	5443	5547	5581	5527	

Trial ID	Radar Type	Pulse Width (μs)	PRI (μs)	Pulses per Hop	Hopping Rate (kHz)	Hopping Sequence Length (ms)	Visible Frequency Number
12	Type 6	1	333.3	9	0.3333	300	4
	Frequency List (MHz)	0	1	2	3	4	
	0	5283	5357	5516	5543	5446	
	5	5632	5417	5585	5268	5592	
	10	5459	5545	5406	5693	5365	
	15	5436	5388	5256	5578	5344	
	20	5675	5492	5317	5562	5627	
	25	5512	5723	5546	5652	5380	
	30	5300	5455	5674	5358	5498	
	35	5454	5710	5621	5654	5443	
	40	5504	5678	5359	5407	5336	
	45	5695	5720	5685	5580	5400	
	50	5430	5687	5706	5544	5467	
	55	5419	5289	5438	5559	5506	
	60	5340	5554	5329	5558	5327	
	65	5385	5662	5519	5590	5364	
	70	5550	5657	5355	5259	5673	
	75	5420	5618	5697	5524	5275	
	80	5633	5254	5424	5534	5274	
	85	5465	5315	5415	5269	5488	
	90	5547	5566	5616	5509	5427	
	95	5445	5560	5636	5347	5432	

Trial ID	Radar Type	Pulse Width (μs)	PRI (μs)	Pulses per Hop	Hopping Rate (kHz)	Hopping Sequence Length (ms)	Visible Frequency Number
13	Type 6	1	333.3	9	0.3333	300	4
	Frequency List (MHz)	0	1	2	3	4	
	0	5538	5596	5452	5704	5666	
	5	5674	5439	5660	5431	5324	
	10	5390	5334	5544	5413	5386	
	15	5524	5573	5491	5301	5295	
	20	5352	5269	5530	5406	5535	
	25	5515	5364	5451	5650	5686	
	30	5422	5664	5412	5317	5607	
	35	5318	5496	5326	5417	5429	
	40	5454	5343	5489	5565	5443	
	45	5356	5721	5387	5419	5656	
	50	5298	5475	5283	5281	5519	
	55	5393	5498	5657	5713	5260	
	60	5470	5724	5647	5477	5531	
	65	5278	5594	5597	5663	5259	
	70	5505	5690	5688	5526	5282	
	75	5719	5638	5672	5253	5478	
	80	5338	5630	5450	5632	5266	
	85	5497	5466	5333	5366	5339	
	90	5434	5591	5581	5351	5250	
	95	5411	5442	5264	5545	5527	

Trial ID	Radar Type	Pulse Width (μs)	PRI (μs)	Pulses per Hop	Hopping Rate (kHz)	Hopping Sequence Length (ms)	Visible Frequency Number
14	Type 6	1	333.3	9	0.3333	300	3
	Frequency List (MHz)	0	1	2	3	4	
	0	5318	5360	5388	5390	5508	
	5	5338	5364	5260	5594	5628	
	10	5321	5598	5585	5511	5407	
	15	5612	5700	5497	5724	5487	
	20	5263	5435	5471	5398	5306	
	25	5691	5654	5279	5720	5464	
	30	5650	5369	5532	5284	5516	
	35	5635	5417	5310	5582	5368	
	40	5657	5669	5503	5683	5353	
	45	5553	5270	5502	5714	5351	
	50	5362	5634	5457	5608	5711	
	55	5337	5607	5452	5372	5706	
	60	5599	5414	5396	5576	5303	
	65	5574	5616	5702	5533	5534	
	70	5489	5466	5428	5588	5693	
	75	5537	5478	5293	5402	5387	
	80	5716	5449	5266	5259	5377	
	85	5401	5627	5645	5632	5583	
	90	5557	5561	5298	5320	5339	
	95	5597	5518	5708	5262	5543	

Trial ID	Radar Type	Pulse Width (μs)	PRI (μs)	Pulses per Hop	Hopping Rate (kHz)	Hopping Sequence Length (ms)	Visible Frequency Number
15	Type 6	1	333.3	9	0.3333	300	5
	Frequency List (MHz)	0	1	2	3	4	
	0	5573	5599	5324	5551	5253	
	5	5380	5386	5335	5660	5360	
	10	5630	5484	5626	5706	5428	
	15	5603	5255	5600	5294	5679	
	20	5271	5504	5412	5487	5481	
	25	5669	5640	5382	5480	5279	
	30	5506	5539	5326	5272	5533	
	35	5336	5299	5508	5581	5260	
	40	5282	5496	5277	5441	5448	
	45	5447	5482	5250	5585	5297	
	50	5404	5627	5510	5633	5553	
	55	5319	5534	5659	5320	5406	
	60	5562	5351	5677	5579	5438	
	65	5408	5604	5520	5342	5651	
	70	5569	5366	5284	5647	5500	
	75	5574	5318	5289	5381	5437	
	80	5522	5530	5697	5701	5376	
	85	5515	5444	5561	5624	5365	
	90	5535	5278	5641	5371	5587	
	95	5357	5552	5493	5560	5608	

Trial ID	Radar Type	Pulse Width (μs)	PRI (μs)	Pulses per Hop	Hopping Rate (kHz)	Hopping Sequence Length (ms)	Visible Frequency Number
16	Type 6	1	333.3	9	0.3333	300	4
	Frequency List (MHz)	0	1	2	3	4	
	0	5256	5460	5260	5615	5570	
	5	5422	5311	5410	5348	5567	
	10	5561	5273	5667	5426	5449	
	15	5691	5382	5703	5339	5396	
	20	5279	5670	5353	5479	5454	
	25	5557	5492	5488	5584	5313	
	30	5645	5525	5283	5487	5685	
	35	5534	5341	5599	5377	5413	
	40	5671	5335	5360	5379	5591	
	45	5444	5411	5705	5668	5258	
	50	5457	5514	5289	5334	5604	
	55	5408	5357	5603	5263	5655	
	60	5548	5551	5269	5383	5715	
	65	5527	5466	5640	5600	5508	
	70	5576	5651	5450	5669	5560	
	75	5321	5613	5609	5642	5678	
	80	5478	5486	5296	5608	5624	
	85	5524	5438	5364	5580	5470	
	90	5606	5325	5555	5489	5375	
	95	5480	5674	5663	5282	5573	

Trial ID	Radar Type	Pulse Width (μs)	PRI (μs)	Pulses per Hop	Hopping Rate (kHz)	Hopping Sequence Length (ms)	Visible Frequency Number
17	Type 6	1	333.3	9	0.3333	300	5
	Frequency List (MHz)	0	1	2	3	4	
	0	5511	5699	5671	5301	5315	
	5	5464	5333	5485	5396	5492	
	10	5537	5708	5621	5470	5304	
	15	5509	5331	5287	5588	5665	
	20	5264	5391	5568	5427	5348	
	25	5441	5691	5688	5347	5687	
	30	5414	5715	5605	5459	5354	
	35	5480	5312	5648	5663	5682	
	40	5271	5540	5317	5356	5718	
	45	5685	5276	5316	5413	5640	
	50	5510	5655	5497	5558	5450	
	55	5599	5692	5370	5367	5522	
	60	5434	5328	5547	5353	5412	
	65	5366	5549	5544	5408	5446	
	70	5253	5266	5546	5421	5462	
	75	5355	5481	5719	5659	5633	
	80	5499	5552	5297	5521	5280	
	85	5438	5681	5543	5565	5474	
	90	5279	5608	5375	5619	5712	
	95	5523	5257	5541	5507	5261	

Trial ID	Radar Type	Pulse Width (μs)	PRI (μs)	Pulses per Hop	Hopping Rate (kHz)	Hopping Sequence Length (ms)	Visible Frequency Number
18	Type 6	1	333.3	9	0.3333	300	5
	Frequency List (MHz)	0	1	2	3	4	
	0	5291	5463	5607	5462	5632	
	5	5603	5258	5560	5674	5326	
	10	5274	5341	5491	5392	5636	
	15	5434	5332	5305	5673	5430	
	20	5400	5711	5293	5419	5317	
	25	5381	5254	5303	5672	5345	
	30	5611	5649	5619	5403	5541	
	35	5596	5585	5623	5633	5438	
	40	5647	5665	5359	5374	5466	
	45	5666	5516	5589	5706	5586	
	50	5394	5312	5646	5661	5493	
	55	5543	5599	5273	5476	5276	
	60	5455	5664	5498	5580	5618	
	65	5338	5531	5435	5629	5424	
	70	5311	5309	5314	5450	5310	
	75	5290	5640	5410	5609	5333	
	80	5461	5275	5518	5572	5620	
	85	5506	5282	5342	5330	5573	
	90	5718	5557	5517	5601	5708	
	95	5298	5525	5405	5304	5682	

Trial ID	Radar Type	Pulse Width (μs)	PRI (μs)	Pulses per Hop	Hopping Rate (kHz)	Hopping Sequence Length (ms)	Visible Frequency Number
19	Type 6	1	333.3	9	0.3333	300	2
	Frequency List (MHz)	0	1	2	3	4	
	0	5546	5702	5543	5623	5377	
	5	5645	5280	5635	5265	5335	
	10	5257	5590	5315	5439	5512	
	15	5383	5288	5440	5594	5681	
	20	5596	5273	5649	5373	5502	
	25	5620	5622	5518	5415	5393	
	30	5289	5629	5560	5385	5372	
	35	5283	5494	5337	5510	5424	
	40	5706	5571	5361	5435	5479	
	45	5442	5519	5456	5392	5290	
	50	5282	5297	5679	5716	5500	
	55	5600	5275	5464	5672	5308	
	60	5577	5401	5390	5447	5450	
	65	5608	5334	5507	5615	5524	
	70	5285	5322	5430	5433	5621	
	75	5662	5719	5589	5528	5515	
	80	5292	5462	5566	5307	5284	
	85	5296	5474	5724	5399	5710	
	90	5250	5353	5509	5303	5597	
	95	5407	5428	5562	5678	5300	

Trial ID	Radar Type	Pulse Width (μs)	PRI (μs)	Pulses per Hop	Hopping Rate (kHz)	Hopping Sequence Length (ms)	Visible Frequency Number
20	Type 6	1	333.3	9	0.3333	300	5
	Frequency List (MHz)	0	1	2	3	4	
	0	5704	5466	5479	5309	5597	
	5	5687	5680	5710	5428	5639	
	10	5566	5379	5356	5634	5533	
	15	5471	5318	5543	5422	5311	
	20	5592	5665	5641	5443	5390	
	25	5569	5350	5622	5449	5435	
	30	5653	5586	5300	5537	5667	
	35	5325	5585	5608	5269	5521	
	40	5263	5314	5509	5504	5529	
	45	5408	5528	5525	5393	5572	
	50	5343	5646	5333	5386	5502	
	55	5660	5688	5554	5465	5677	
	60	5338	5326	5454	5260	5615	
	65	5403	5347	5591	5396	5555	
	70	5515	5579	5601	5527	5387	
	75	5261	5707	5291	5550	5602	
	80	5439	5257	5370	5692	5498	
	85	5512	5487	5719	5401	5650	
	90	5335	5402	5255	5659	5722	
	95	5364	5493	5676	5510	5700	

Trial ID	Radar Type	Pulse Width (μs)	PRI (μs)	Pulses per Hop	Hopping Rate (kHz)	Hopping Sequence Length (ms)	Visible Frequency Number
21	Type 6	1	333.3	9	0.3333	300	5
	Frequency List (MHz)	0	1	2	3	4	
	0	5484	5705	5415	5470	5439	
	5	5351	5702	5310	5591	5371	
	10	5497	5265	5494	5354	5554	
	15	5559	5445	5646	5370	5503	
	20	5600	5356	5252	5255	5416	
	25	5656	5421	5456	5251	5483	
	30	5477	5542	5543	5418	5311	
	35	5390	5464	5676	5501	5422	
	40	5435	5674	5447	5269	5526	
	45	5337	5508	5608	5451	5625	
	50	5522	5642	5384	5475	5703	
	55	5507	5401	5655	5496	5309	
	60	5455	5619	5680	5326	5414	
	65	5345	5492	5295	5318	5273	
	70	5587	5530	5711	5615	5666	
	75	5638	5670	5622	5583	5691	
	80	5367	5626	5381	5561	5412	
	85	5682	5718	5589	5286	5289	
	90	5553	5314	5329	5261	5465	
	95	5541	5463	5574	5671	5458	

Trial ID	Radar Type	Pulse Width (μs)	PRI (μs)	Pulses per Hop	Hopping Rate (kHz)	Hopping Sequence Length (ms)	Visible Frequency Number
22	Type 6	1	333.3	9	0.3333	300	2
	Frequency List (MHz)	0	1	2	3	4	
	0	5264	5469	5351	5631	5659	
	5	5393	5627	5385	5279	5578	
	10	5428	5529	5535	5549	5575	
	15	5647	5572	5274	5415	5695	
	20	5608	5425	5668	5722	5389	
	25	5544	5370	5355	5517	5616	
	30	5528	5500	5633	5463	5685	
	35	5603	5292	5297	5349	5513	
	40	5577	5509	5523	5644	5488	
	45	5691	5412	5678	5495	5398	
	50	5343	5435	5564	5526	5451	
	55	5589	5462	5315	5280	5584	
	60	5309	5625	5336	5615	5294	
	65	5530	5702	5565	5596	5345	
	70	5670	5630	5560	5591	5607	
	75	5693	5468	5477	5407	5545	
	80	5721	5409	5402	5525	5552	
	85	5381	5483	5340	5326	5609	
	90	5494	5364	5499	5423	5465	
	95	5518	5558	5569	5716	5718	

Trial ID	Radar Type	Pulse Width (μs)	PRI (μs)	Pulses per Hop	Hopping Rate (kHz)	Hopping Sequence Length (ms)	Visible Frequency Number
23	Type 6	1	333.3	9	0.3333	300	3
	Frequency List (MHz)	0	1	2	3	4	
	0	5519	5708	5287	5695	5501	
	5	5435	5649	5460	5442	5407	
	10	5262	5318	5576	5269	5596	
	15	5638	5699	5377	5412	5591	
	20	5706	5336	5362	5432	5697	
	25	5387	5556	5454	5658	5417	
	30	5457	5373	5712	5408	5645	
	35	5480	5568	5350	5360	5352	
	40	5660	5323	5652	5520	5573	
	45	5468	5299	5470	5634	5285	
	50	5274	5486	5275	5349	5298	
	55	5680	5416	5463	5512	5251	
	60	5713	5474	5667	5683	5453	
	65	5282	5438	5718	5566	5534	
	70	5399	5514	5656	5633	5409	
	75	5567	5584	5338	5545	5623	
	80	5490	5663	5612	5309	5406	
	85	5694	5525	5499	5448	5294	
	90	5574	5332	5659	5370	5436	
	95	5477	5415	5542	5467	5319	

Trial ID	Radar Type	Pulse Width (μs)	PRI (μs)	Pulses per Hop	Hopping Rate (kHz)	Hopping Sequence Length (ms)	Visible Frequency Number
24	Type 6	1	333.3	9	0.3333	300	4
	Frequency List (MHz)	0	1	2	3	4	
	0	5299	5472	5698	5381	5721	
	5	5477	5574	5535	5508	5614	
	10	5668	5582	5617	5367	5251	
	15	5351	5383	5505	5604	5527	
	20	5660	5647	5328	5335	5549	
	25	5590	5488	5700	5403	5414	
	30	5588	5389	5703	5309	5571	
	35	5364	5503	5274	5666	5365	
	40	5261	5417	5517	5405	5448	
	45	5382	5528	5687	5695	5537	
	50	5717	5393	5370	5653	5331	
	55	5600	5270	5639	5612	5515	
	60	5376	5667	5269	5252	5677	
	65	5586	5642	5258	5636	5543	
	70	5458	5479	5623	5400	5444	
	75	5301	5372	5428	5341	5575	
	80	5290	5316	5345	5347	5627	
	85	5349	5470	5565	5432	5628	
	90	5676	5447	5672	5552	5468	
	95	5469	5359	5321	5325	5678	

Trial ID	Radar Type	Pulse Width (μs)	PRI (μs)	Pulses per Hop	Hopping Rate (kHz)	Hopping Sequence Length (ms)	Visible Frequency Number
25	Type 6	1	333.3	9	0.3333	300	4
	Frequency List (MHz)	0	1	2	3	4	
	0	5457	5711	5634	5542	5563	
	5	5616	5596	5610	5671	5346	
	10	5599	5371	5658	5562	5638	
	15	5339	5381	5486	5453	5321	
	20	5535	5351	5588	5417	5308	
	25	5586	5498	5318	5289	5522	
	30	5364	5292	5706	5426	5448	
	35	5662	5257	5656	5663	5505	
	40	5674	5657	5514	5334	5428	
	45	5465	5489	5265	5437	5404	
	50	5396	5373	5564	5581	5324	
	55	5368	5625	5571	5399	5329	
	60	5557	5347	5677	5271	5462	
	65	5541	5576	5383	5280	5250	
	70	5261	5485	5519	5502	5578	
	75	5525	5604	5652	5613	5700	
	80	5435	5400	5609	5331	5635	
	85	5385	5281	5299	5595	5350	
	90	5382	5407	5695	5546	5683	
	95	5607	5263	5655	5550	5459	

Trial ID	Radar Type	Pulse Width (μs)	PRI (μs)	Pulses per Hop	Hopping Rate (kHz)	Hopping Sequence Length (ms)	Visible Frequency Number
26	Type 6	1	333.3	9	0.3333	300	4
	Frequency List (MHz)	0	1	2	3	4	
	0	5712	5475	5570	5703	5308	
	5	5658	5521	5685	5359	5650	
	10	5433	5257	5699	5282	5659	
	15	5427	5508	5589	5498	5610	
	20	5446	5420	5626	5409	5281	
	25	5377	5350	5424	5393	5556	
	30	5406	5656	5328	5315	5721	
	35	5587	5278	5528	5431	5674	
	40	5441	5531	5515	5422	5608	
	45	5263	5408	5548	5547	5318	
	50	5324	5280	5572	5639	5542	
	55	5671	5294	5558	5347	5494	
	60	5502	5654	5600	5692	5663	
	65	5662	5577	5311	5414	5661	
	70	5352	5711	5361	5334	5398	
	75	5461	5289	5698	5668	5585	
	80	5429	5723	5481	5629	5595	
	85	5300	5329	5331	5597	5598	
	90	5624	5368	5645	5679	5485	
	95	5707	5563	5591	5636	5537	

Trial ID	Radar Type	Pulse Width (μs)	PRI (μs)	Pulses per Hop	Hopping Rate (kHz)	Hopping Sequence Length (ms)	Visible Frequency Number
27	Type 6	1	333.3	9	0.3333	300	4
	Frequency List (MHz)	0	1	2	3	4	
	0	5492	5714	5506	5389	5625	
	5	5700	5543	5285	5522	5382	
	10	5364	5521	5265	5477	5680	
	15	5418	5635	5692	5327	5454	
	20	5586	5567	5498	5254	5299	
	25	5627	5594	5590	5448	5642	
	30	5661	5564	5541	5629	5369	
	35	5324	5584	5588	5280	5614	
	40	5453	5565	5605	5570	5291	
	45	5631	5371	5589	5534	5273	
	50	5690	5494	5355	5482	5707	
	55	5641	5513	5657	5659	5544	
	60	5486	5426	5638	5611	5516	
	65	5618	5684	5464	5697	5658	
	70	5374	5420	5258	5721	5566	
	75	5681	5358	5262	5696	5297	
	80	5621	5709	5439	5672	5304	
	85	5616	5368	5491	5475	5341	
	90	5580	5318	5281	5380	5519	
	95	5537	5362	5645	5524	5325	

Trial ID	Radar Type	Pulse Width (μs)	PRI (μs)	Pulses per Hop	Hopping Rate (kHz)	Hopping Sequence Length (ms)	Visible Frequency Number
28	Type 6	1	333.3	9	0.3333	300	4
	Frequency List (MHz)	0	1	2	3	4	
	0	5272	5478	5539	5550	5370	
	5	5267	5565	5360	5588	5589	
	10	5295	5310	5306	5672	5701	
	15	5506	5287	5320	5491	5519	
	20	5462	5655	5508	5490	5702	
	25	5531	5626	5355	5698	5624	
	30	5717	5401	5716	5264	5293	
	35	5557	5692	5262	5502	5594	
	40	5319	5391	5330	5602	5499	
	45	5271	5336	5663	5424	5476	
	50	5410	5449	5266	5342	5317	
	55	5299	5670	5564	5463	5460	
	60	5387	5311	5349	5489	5415	
	65	5252	5681	5687	5560	5552	
	70	5353	5576	5593	5683	5464	
	75	5507	5350	5379	5605	5366	
	80	5382	5547	5361	5371	5518	
	85	5385	5721	5294	5341	5612	
	90	5378	5621	5389	5457	5292	
	95	5534	5497	5412	5374	5597	

Trial ID	Radar Type	Pulse Width (μs)	PRI (μs)	Pulses per Hop	Hopping Rate (kHz)	Hopping Sequence Length (ms)	Visible Frequency Number
29	Type 6	1	333.3	9	0.3333	300	5
	Frequency List (MHz)	0	1	2	3	4	
	0	5430	5717	5475	5711	5687	
	5	5406	5490	5435	5276	5321	
	10	5604	5574	5444	5295	5722	
	15	5594	5414	5326	5536	5373	
	20	5346	5546	5579	5675	5419	
	25	5478	5558	5327	5658	5629	
	30	5420	5674	5519	5559	5432	
	35	5648	5488	5512	5513	5433	
	40	5402	5329	5570	5599	5331	
	45	5251	5624	5477	5266	5286	
	50	5625	5317	5431	5518	5621	
	55	5653	5279	5358	5343	5514	
	60	5434	5650	5627	5413	5509	
	65	5491	5660	5371	5545	5665	
	70	5291	5467	5259	5338	5486	
	75	5428	5528	5613	5481	5299	
	80	5549	5309	5612	5695	5681	
	85	5581	5422	5540	5386	5699	
	90	5503	5446	5256	5462	5640	
	95	5427	5377	5487	5398	5307	

Radar Signal 6_5310 MHz

Trial ID	Radar Type	Pulse Width (μs)	PRI (μs)	Pulses per Hop	Hopping Rate (kHz)	Hopping Sequence Length (ms)	Visible Frequency Number
0	Type 6	1	333.3	9	0.3333	300	8
	Frequency List (MHz)	0	1	2	3	4	
	0	5364	5717	5334	5705	5549	
	5	5312	5260	5635	5503	5570	
	10	5347	5508	5292	5447	5588	
	15	5621	5638	5296	5482	5455	
	20	5636	5593	5434	5306	5411	
	25	5556	5378	5478	5432	5341	
	30	5438	5294	5496	5285	5327	
	35	5293	5502	5277	5403	5330	
	40	5612	5720	5544	5615	5561	
	45	5676	5704	5366	5290	5387	
	50	5278	5723	5383	5368	5263	
	55	5630	5375	5718	5281	5604	
	60	5453	5509	5479	5400	5262	
	65	5354	5467	5545	5466	5611	
	70	5715	5402	5568	5641	5396	
	75	5567	5557	5674	5359	5392	
	80	5313	5537	5258	5475	5272	
	85	5388	5474	5555	5410	5355	
	90	5517	5382	5386	5664	5697	
	95	5721	5268	5489	5706	5525	

Trial ID	Radar Type	Pulse Width (μs)	PRI (μs)	Pulses per Hop	Hopping Rate (kHz)	Hopping Sequence Length (ms)	Visible Frequency Number
1	Type 6	1	333.3	9	0.3333	300	5
	Frequency List (MHz)	0	1	2	3	4	
	0	5619	5578	5270	5294	5354	
	5	5660	5710	5666	5399	5656	
	10	5297	5333	5642	5609	5709	
	15	5668	5527	5647	5547	5284	
	20	5375	5395	5384	5444	5705	
	25	5584	5536	5480	5658	5453	
	30	5403	5576	5588	5641	5465	
	35	5674	5580	5623	5559	5627	
	40	5553	5704	5673	5633	5724	
	45	5373	5348	5331	5513	5637	
	50	5544	5314	5585	5697	5257	
	55	5672	5471	5423	5424	5638	
	60	5644	5345	5569	5655	5413	
	65	5271	5415	5550	5371	5335	
	70	5382	5416	5533	5706	5558	
	75	5535	5692	5256	5436	5716	
	80	5385	5669	5458	5349	5456	
	85	5336	5634	5703	5352	5280	
	90	5506	5313	5690	5326	5631	
	95	5628	5546	5289	5490	5590	

Trial ID	Radar Type	Pulse Width (μs)	PRI (μs)	Pulses per Hop	Hopping Rate (kHz)	Hopping Sequence Length (ms)	Visible Frequency Number
2	Type 6	1	333.3	9	0.3333	300	9
	Frequency List (MHz)	0	1	2	3	4	
	0	5302	5342	5681	5455	5611	
	5	5493	5682	5310	5257	5606	
	10	5587	5561	5374	5362	5630	
	15	5322	5320	5502	5475	5364	
	20	5555	5353	5316	5387	5357	
	25	5332	5654	5312	5262	5409	
	30	5522	5547	5410	5618	5253	
	35	5311	5683	5556	5470	5258	
	40	5537	5398	5710	5491	5469	
	45	5670	5465	5704	5456	5406	
	50	5384	5400	5513	5720	5365	
	55	5296	5276	5641	5445	5626	
	60	5564	5620	5395	5334	5290	
	65	5401	5578	5359	5569	5586	
	70	5282	5649	5407	5368	5647	
	75	5643	5509	5592	5675	5678	
	80	5581	5275	5381	5512	5600	
	85	5304	5382	5389	5458	5666	
	90	5419	5642	5350	5526	5519	
	95	5709	5692	5418	5653	5354	

Trial ID	Radar Type	Pulse Width (μs)	PRI (μs)	Pulses per Hop	Hopping Rate (kHz)	Hopping Sequence Length (ms)	Visible Frequency Number
3	Type 6	1	333.3	9	0.3333	300	7
	Frequency List (MHz)	0	1	2	3	4	
	0	5557	5581	5617	5616	5356	
	5	5535	5704	5385	5420	5338	
	10	5518	5350	5415	5651	5313	
	15	5447	5605	5520	5653	5563	
	20	5519	5257	5476	5330	5598	
	25	5506	5515	5366	5443	5661	
	30	5533	5367	5358	5502	5606	
	35	5347	5647	5266	5411	5451	
	40	5334	5332	5709	5667	5394	
	45	5684	5539	5464	5437	5665	
	50	5389	5421	5416	5574	5488	
	55	5536	5580	5279	5439	5324	
	60	5499	5710	5708	5404	5305	
	65	5295	5525	5589	5359	5452	
	70	5576	5272	5492	5388	5551	
	75	5547	5323	5724	5256	5721	
	80	5293	5379	5584	5361	5508	
	85	5479	5693	5341	5655	5715	
	90	5629	5494	5401	5637	5423	
	95	5280	5316	5662	5281	5649	

Trial ID	Radar Type	Pulse Width (μs)	PRI (μs)	Pulses per Hop	Hopping Rate (kHz)	Hopping Sequence Length (ms)	Visible Frequency Number
4	Type 6	1	333.3	9	0.3333	300	6
	Frequency List (MHz)	0	1	2	3	4	
	0	5337	5345	5553	5302	5673	
	5	5577	5629	5460	5583	5642	
	10	5352	5614	5456	5655	5672	
	15	5401	5574	5611	5565	5370	
	20	5571	5588	5295	5468	5303	
	25	5486	5358	5718	5470	5380	
	30	5703	5422	5324	5573	5654	
	35	5426	5263	5634	5661	5462	
	40	5648	5498	5270	5474	5664	
	45	5701	5622	5425	5490	5552	
	50	5265	5597	5467	5300	5432	
	55	5724	5437	5469	5258	5715	
	60	5453	5277	5637	5705	5348	
	65	5593	5262	5561	5251	5255	
	70	5275	5341	5364	5510	5516	
	75	5346	5712	5504	5549	5356	
	80	5527	5376	5264	5447	5442	
	85	5454	5658	5428	5544	5374	
	90	5343	5663	5478	5689	5384	
	95	5372	5707	5274	5292	5466	

Trial ID	Radar Type	Pulse Width (μs)	PRI (μs)	Pulses per Hop	Hopping Rate (kHz)	Hopping Sequence Length (ms)	Visible Frequency Number
5	Type 6	1	333.3	9	0.3333	300	5
	Frequency List (MHz)	0	1	2	3	4	
	0	5592	5584	5489	5463	5418	
	5	5619	5651	5535	5271	5374	
	10	5283	5500	5594	5375	5693	
	15	5604	5714	5610	5562	5482	
	20	5279	5711	5557	5276	5277	
	25	5307	5446	5574	5414	5270	
	30	5408	5281	5691	5428	5624	
	35	5625	5354	5430	5339	5376	
	40	5487	5581	5683	5617	5630	
	45	5644	5705	5483	5342	5519	
	50	5298	5518	5563	5598	5437	
	55	5391	5659	5455	5686	5582	
	60	5697	5469	5628	5294	5319	
	65	5597	5631	5521	5436	5423	
	70	5278	5665	5340	5485	5466	
	75	5438	5315	5275	5614	5330	
	80	5520	5590	5596	5264	5289	
	85	5405	5646	5526	5346	5676	
	90	5267	5539	5349	5600	5258	
	95	5671	5533	5345	5587	5523	

Trial ID	Radar Type	Pulse Width (μs)	PRI (μs)	Pulses per Hop	Hopping Rate (kHz)	Hopping Sequence Length (ms)	Visible Frequency Number
6	Type 6	1	333.3	9	0.3333	300	8
	Frequency List (MHz)	0	1	2	3	4	
	0	5372	5348	5425	5624	5260	
	5	5283	5576	5610	5434	5581	
	10	5689	5289	5635	5570	5714	
	15	5577	5256	5342	5558	5279	
	20	5490	5652	5549	5724	5640	
	25	5634	5552	5300	5448	5409	
	30	5297	5713	5431	5580	5444	
	35	5667	5445	5701	5492	5290	
	40	5326	5286	5621	5382	5280	
	45	5559	5313	5541	5499	5704	
	50	5395	5474	5569	5274	5421	
	55	5698	5625	5345	5374	5657	
	60	5711	5519	5642	5301	5454	
	65	5715	5520	5536	5366	5413	
	70	5414	5378	5417	5316	5428	
	75	5357	5586	5484	5296	5430	
	80	5627	5684	5653	5273	5606	
	85	5465	5363	5491	5352	5355	
	90	5518	5631	5688	5588	5329	
	95	5485	5502	5590	5390	5531	

Trial ID	Radar Type	Pulse Width (μs)	PRI (μs)	Pulses per Hop	Hopping Rate (kHz)	Hopping Sequence Length (ms)	Visible Frequency Number
7	Type 6	1	333.3	9	0.3333	300	8
	Frequency List (MHz)	0	1	2	3	4	
	0	5530	5587	5361	5310	5480	
	5	5325	5598	5685	5500	5410	
	10	5523	5553	5676	5290	5260	
	15	5568	5383	5445	5603	5471	
	20	5498	5514	5690	5638	5697	
	25	5431	5583	5280	5404	5482	
	30	5451	5661	5670	5646	5354	
	35	5642	5331	5633	5594	5267	
	40	5301	5640	5369	5559	5622	
	45	5277	5391	5507	5396	5502	
	50	5552	5494	5271	5650	5620	
	55	5363	5719	5545	5338	5299	
	60	5564	5628	5268	5684	5608	
	65	5283	5343	5584	5572	5673	
	70	5683	5517	5492	5381	5266	
	75	5292	5387	5326	5706	5627	
	80	5682	5262	5367	5276	5716	
	85	5270	5511	5428	5458	5359	
	90	5351	5600	5285	5394	5571	
	95	5400	5265	5327	5643	5313	

Trial ID	Radar Type	Pulse Width (μs)	PRI (μs)	Pulses per Hop	Hopping Rate (kHz)	Hopping Sequence Length (ms)	Visible Frequency Number
8	Type 6	1	333.3	9	0.3333	300	10
	Frequency List (MHz)	0	1	2	3	4	
	0	5310	5351	5297	5374	5322	
	5	5367	5523	5285	5663	5617	
	10	5454	5342	5717	5485	5281	
	15	5656	5510	5548	5648	5409	
	20	5680	5631	5630	5670	5319	
	25	5435	5483	5508	5516	5493	
	30	5647	5627	5386	5506	5462	
	35	5470	5724	5390	5420	5690	
	40	5576	5452	5497	5387	5274	
	45	5320	5487	5479	5560	5605	
	50	5381	5622	5671	5445	5489	
	55	5526	5253	5279	5502	5397	
	60	5629	5440	5678	5704	5544	
	65	5533	5608	5408	5478	5655	
	70	5481	5590	5268	5346	5673	
	75	5254	5295	5258	5459	5372	
	80	5623	5401	5267	5706	5545	
	85	5488	5650	5324	5305	5373	
	90	5559	5464	5660	5344	5698	
	95	5394	5378	5363	5321	5311	

Trial ID	Radar Type	Pulse Width (μs)	PRI (μs)	Pulses per Hop	Hopping Rate (kHz)	Hopping Sequence Length (ms)	Visible Frequency Number
9	Type 6	1	333.3	9	0.3333	300	4
	Frequency List (MHz)	0	1	2	3	4	
	0	5565	5590	5708	5535	5542	
	5	5409	5545	5360	5351	5349	
	10	5288	5606	5283	5583	5302	
	15	5269	5637	5554	5693	5380	
	20	5417	5274	5572	5719	5643	
	25	5682	5287	5686	5612	5550	
	30	5632	5536	5584	5504	5280	
	35	5660	5512	5340	5661	5573	
	40	5604	5415	5435	5530	5271	
	45	5627	5467	5562	5618	5658	
	50	5646	5401	5527	5722	5541	
	55	5268	5336	5714	5372	5473	
	60	5526	5539	5574	5369	5650	
	65	5367	5482	5547	5715	5370	
	70	5598	5252	5464	5484	5439	
	75	5622	5305	5642	5374	5341	
	80	5711	5385	5404	5264	5523	
	85	5448	5326	5451	5270	5667	
	90	5356	5621	5303	5724	5470	
	95	5639	5386	5361	5278	5378	

Trial ID	Radar Type	Pulse Width (μs)	PRI (μs)	Pulses per Hop	Hopping Rate (kHz)	Hopping Sequence Length (ms)	Visible Frequency Number
10	Type 6	1	333.3	9	0.3333	300	9
	Frequency List (MHz)	0	1	2	3	4	
	0	5345	5354	5644	5696	5384	
	5	5548	5470	5435	5514	5653	
	10	5694	5492	5324	5303	5323	
	15	5357	5667	5657	5641	5572	
	20	5425	5440	5610	5711	5616	
	25	5473	5414	5338	5584	5674	
	30	5541	5719	5432	5480	5651	
	35	5431	5457	5348	5615	5254	
	40	5715	5373	5295	5365	5556	
	45	5447	5645	5579	5533	5277	
	50	5703	5298	5252	5566	5280	
	55	5330	5636	5562	5403	5444	
	60	5655	5704	5519	5676	5427	
	65	5596	5568	5583	5450	5640	
	70	5304	5421	5547	5288	5598	
	75	5264	5494	5484	5695	5488	
	80	5495	5660	5293	5527	5639	
	85	5718	5351	5643	5511	5462	
	90	5632	5310	5394	5501	5476	
	95	5576	5327	5378	5333	5362	

Trial ID	Radar Type	Pulse Width (μs)	PRI (μs)	Pulses per Hop	Hopping Rate (kHz)	Hopping Sequence Length (ms)	Visible Frequency Number
11	Type 6	1	333.3	9	0.3333	300	7
	Frequency List (MHz)	0	1	2	3	4	
	0	5503	5593	5580	5382	5604	
	5	5590	5492	5510	5385	5625	
	10	5281	5365	5498	5344	5348	
	15	5319	5285	5686	5386	5336	
	20	5509	5551	5325	5589	5361	
	25	5563	5520	5442	5618	5716	
	30	5411	5459	5681	5300	5315	
	35	5522	5350	5501	5529	5568	
	40	5323	5689	5535	5362	5485	
	45	5427	5253	5637	5667	5628	
	50	5404	5349	5341	5389	5602	
	55	5518	5277	5697	5415	5309	
	60	5394	5464	5508	5639	5391	
	65	5380	5282	5532	5582	5493	
	70	5533	5587	5515	5574	5698	
	75	5483	5614	5530	5676	5265	
	80	5605	5441	5360	5636	5438	
	85	5351	5474	5654	5500	5642	
	90	5321	5579	5482	5610	5684	
	95	5388	5443	5547	5581	5527	

Trial ID	Radar Type	Pulse Width (μs)	PRI (μs)	Pulses per Hop	Hopping Rate (kHz)	Hopping Sequence Length (ms)	Visible Frequency Number
12	Type 6	1	333.3	9	0.3333	300	5
	Frequency List (MHz)	0	1	2	3	4	
	0	5283	5357	5516	5543	5446	
	5	5632	5417	5585	5268	5592	
	10	5459	5545	5406	5693	5365	
	15	5436	5388	5256	5578	5344	
	20	5675	5492	5317	5562	5627	
	25	5512	5723	5546	5652	5380	
	30	5300	5455	5674	5358	5498	
	35	5454	5710	5621	5654	5443	
	40	5504	5678	5359	5407	5336	
	45	5695	5720	5685	5580	5400	
	50	5430	5687	5706	5544	5467	
	55	5419	5289	5438	5559	5506	
	60	5340	5554	5329	5558	5327	
	65	5385	5662	5519	5590	5364	
	70	5550	5657	5355	5259	5673	
	75	5420	5618	5697	5524	5275	
	80	5633	5254	5424	5534	5274	
	85	5465	5315	5415	5269	5488	
	90	5547	5566	5616	5509	5427	
	95	5445	5560	5636	5347	5432	

Trial ID	Radar Type	Pulse Width (μs)	PRI (μs)	Pulses per Hop	Hopping Rate (kHz)	Hopping Sequence Length (ms)	Visible Frequency Number
13	Type 6	1	333.3	9	0.3333	300	7
	Frequency List (MHz)	0	1	2	3	4	
	0	5538	5596	5452	5704	5666	
	5	5674	5439	5660	5431	5324	
	10	5390	5334	5544	5413	5386	
	15	5524	5573	5491	5301	5295	
	20	5352	5269	5530	5406	5535	
	25	5515	5364	5451	5650	5686	
	30	5422	5664	5412	5317	5607	
	35	5318	5496	5326	5417	5429	
	40	5454	5343	5489	5565	5443	
	45	5356	5721	5387	5419	5656	
	50	5298	5475	5283	5281	5519	
	55	5393	5498	5657	5713	5260	
	60	5470	5724	5647	5477	5531	
	65	5278	5594	5597	5663	5259	
	70	5505	5690	5688	5526	5282	
	75	5719	5638	5672	5253	5478	
	80	5338	5630	5450	5632	5266	
	85	5497	5466	5333	5366	5339	
	90	5434	5591	5581	5351	5250	
	95	5411	5442	5264	5545	5527	

Trial ID	Radar Type	Pulse Width (μs)	PRI (μs)	Pulses per Hop	Hopping Rate (kHz)	Hopping Sequence Length (ms)	Visible Frequency Number
14	Type 6	1	333.3	9	0.3333	300	8
	Frequency List (MHz)	0	1	2	3	4	
	0	5318	5360	5388	5390	5508	
	5	5338	5364	5260	5594	5628	
	10	5321	5598	5585	5511	5407	
	15	5612	5700	5497	5724	5487	
	20	5263	5435	5471	5398	5306	
	25	5691	5654	5279	5720	5464	
	30	5650	5369	5532	5284	5516	
	35	5635	5417	5310	5582	5368	
	40	5657	5669	5503	5683	5353	
	45	5553	5270	5502	5714	5351	
	50	5362	5634	5457	5608	5711	
	55	5337	5607	5452	5372	5706	
	60	5599	5414	5396	5576	5303	
	65	5574	5616	5702	5533	5534	
	70	5489	5466	5428	5588	5693	
	75	5537	5478	5293	5402	5387	
	80	5716	5449	5266	5259	5377	
	85	5401	5627	5645	5632	5583	
	90	5557	5561	5298	5320	5339	
	95	5597	5518	5708	5262	5543	

Trial ID	Radar Type	Pulse Width (μs)	PRI (μs)	Pulses per Hop	Hopping Rate (kHz)	Hopping Sequence Length (ms)	Visible Frequency Number
15	Type 6	1	333.3	9	0.3333	300	8
	Frequency List (MHz)	0	1	2	3	4	
	0	5573	5599	5324	5551	5253	
	5	5380	5386	5335	5660	5360	
	10	5630	5484	5626	5706	5428	
	15	5603	5255	5600	5294	5679	
	20	5271	5504	5412	5487	5481	
	25	5669	5640	5382	5480	5279	
	30	5506	5539	5326	5272	5533	
	35	5336	5299	5508	5581	5260	
	40	5282	5496	5277	5441	5448	
	45	5447	5482	5250	5585	5297	
	50	5404	5627	5510	5633	5553	
	55	5319	5534	5659	5320	5406	
	60	5562	5351	5677	5579	5438	
	65	5408	5604	5520	5342	5651	
	70	5569	5366	5284	5647	5500	
	75	5574	5318	5289	5381	5437	
	80	5522	5530	5697	5701	5376	
	85	5515	5444	5561	5624	5365	
	90	5535	5278	5641	5371	5587	
	95	5357	5552	5493	5560	5608	

Trial ID	Radar Type	Pulse Width (μs)	PRI (μs)	Pulses per Hop	Hopping Rate (kHz)	Hopping Sequence Length (ms)	Visible Frequency Number
16	Type 6	1	333.3	9	0.3333	300	5
	Frequency List (MHz)	0	1	2	3	4	
	0	5256	5460	5260	5615	5570	
	5	5422	5311	5410	5348	5567	
	10	5561	5273	5667	5426	5449	
	15	5691	5382	5703	5339	5396	
	20	5279	5670	5353	5479	5454	
	25	5557	5492	5488	5584	5313	
	30	5645	5525	5283	5487	5685	
	35	5534	5341	5599	5377	5413	
	40	5671	5335	5360	5379	5591	
	45	5444	5411	5705	5668	5258	
	50	5457	5514	5289	5334	5604	
	55	5408	5357	5603	5263	5655	
	60	5548	5551	5269	5383	5715	
	65	5527	5466	5640	5600	5508	
	70	5576	5651	5450	5669	5560	
	75	5321	5613	5609	5642	5678	
	80	5478	5486	5296	5608	5624	
	85	5524	5438	5364	5580	5470	
	90	5606	5325	5555	5489	5375	
	95	5480	5674	5663	5282	5573	

Trial ID	Radar Type	Pulse Width (μs)	PRI (μs)	Pulses per Hop	Hopping Rate (kHz)	Hopping Sequence Length (ms)	Visible Frequency Number
17	Type 6	1	333.3	9	0.3333	300	8
	Frequency List (MHz)	0	1	2	3	4	
	0	5511	5699	5671	5301	5315	
	5	5464	5333	5485	5396	5492	
	10	5537	5708	5621	5470	5304	
	15	5509	5331	5287	5588	5665	
	20	5264	5391	5568	5427	5348	
	25	5441	5691	5688	5347	5687	
	30	5414	5715	5605	5459	5354	
	35	5480	5312	5648	5663	5682	
	40	5271	5540	5317	5356	5718	
	45	5685	5276	5316	5413	5640	
	50	5510	5655	5497	5558	5450	
	55	5599	5692	5370	5367	5522	
	60	5434	5328	5547	5353	5412	
	65	5366	5549	5544	5408	5446	
	70	5253	5266	5546	5421	5462	
	75	5355	5481	5719	5659	5633	
	80	5499	5552	5297	5521	5280	
	85	5438	5681	5543	5565	5474	
	90	5279	5608	5375	5619	5712	
	95	5523	5257	5541	5507	5261	

Trial ID	Radar Type	Pulse Width (μs)	PRI (μs)	Pulses per Hop	Hopping Rate (kHz)	Hopping Sequence Length (ms)	Visible Frequency Number
18	Type 6	1	333.3	9	0.3333	300	13
	Frequency List (MHz)	0	1	2	3	4	
	0	5291	5463	5607	5462	5632	
	5	5603	5258	5560	5674	5326	
	10	5274	5341	5491	5392	5636	
	15	5434	5332	5305	5673	5430	
	20	5400	5711	5293	5419	5317	
	25	5381	5254	5303	5672	5345	
	30	5611	5649	5619	5403	5541	
	35	5596	5585	5623	5633	5438	
	40	5647	5665	5359	5374	5466	
	45	5666	5516	5589	5706	5586	
	50	5394	5312	5646	5661	5493	
	55	5543	5599	5273	5476	5276	
	60	5455	5664	5498	5580	5618	
	65	5338	5531	5435	5629	5424	
	70	5311	5309	5314	5450	5310	
	75	5290	5640	5410	5609	5333	
	80	5461	5275	5518	5572	5620	
	85	5506	5282	5342	5330	5573	
	90	5718	5557	5517	5601	5708	
	95	5298	5525	5405	5304	5682	

Trial ID	Radar Type	Pulse Width (μs)	PRI (μs)	Pulses per Hop	Hopping Rate (kHz)	Hopping Sequence Length (ms)	Visible Frequency Number
19	Type 6	1	333.3	9	0.3333	300	9
	Frequency List (MHz)	0	1	2	3	4	
	0	5546	5702	5543	5623	5377	
	5	5645	5280	5635	5265	5335	
	10	5257	5590	5315	5439	5512	
	15	5383	5288	5440	5594	5681	
	20	5596	5273	5649	5373	5502	
	25	5620	5622	5518	5415	5393	
	30	5289	5629	5560	5385	5372	
	35	5283	5494	5337	5510	5424	
	40	5706	5571	5361	5435	5479	
	45	5442	5519	5456	5392	5290	
	50	5282	5297	5679	5716	5500	
	55	5600	5275	5464	5672	5308	
	60	5577	5401	5390	5447	5450	
	65	5608	5334	5507	5615	5524	
	70	5285	5322	5430	5433	5621	
	75	5662	5719	5589	5528	5515	
	80	5292	5462	5566	5307	5284	
	85	5296	5474	5724	5399	5710	
	90	5250	5353	5509	5303	5597	
	95	5407	5428	5562	5678	5300	

Trial ID	Radar Type	Pulse Width (μs)	PRI (μs)	Pulses per Hop	Hopping Rate (kHz)	Hopping Sequence Length (ms)	Visible Frequency Number
20	Type 6	1	333.3	9	0.3333	300	8
	Frequency List (MHz)	0	1	2	3	4	
	0	5704	5466	5479	5309	5597	
	5	5687	5680	5710	5428	5639	
	10	5566	5379	5356	5634	5533	
	15	5471	5318	5543	5422	5311	
	20	5592	5665	5641	5443	5390	
	25	5569	5350	5622	5449	5435	
	30	5653	5586	5300	5537	5667	
	35	5325	5585	5608	5269	5521	
	40	5263	5314	5509	5504	5529	
	45	5408	5528	5525	5393	5572	
	50	5343	5646	5333	5386	5502	
	55	5660	5688	5554	5465	5677	
	60	5338	5326	5454	5260	5615	
	65	5403	5347	5591	5396	5555	
	70	5515	5579	5601	5527	5387	
	75	5261	5707	5291	5550	5602	
	80	5439	5257	5370	5692	5498	
	85	5512	5487	5719	5401	5650	
	90	5335	5402	5255	5659	5722	
	95	5364	5493	5676	5510	5700	

Trial ID	Radar Type	Pulse Width (μs)	PRI (μs)	Pulses per Hop	Hopping Rate (kHz)	Hopping Sequence Length (ms)	Visible Frequency Number
21	Type 6	1	333.3	9	0.3333	300	8
	Frequency List (MHz)	0	1	2	3	4	
	0	5484	5705	5415	5470	5439	
	5	5351	5702	5310	5591	5371	
	10	5497	5265	5494	5354	5554	
	15	5559	5445	5646	5370	5503	
	20	5600	5356	5252	5255	5416	
	25	5656	5421	5456	5251	5483	
	30	5477	5542	5543	5418	5311	
	35	5390	5464	5676	5501	5422	
	40	5435	5674	5447	5269	5526	
	45	5337	5508	5608	5451	5625	
	50	5522	5642	5384	5475	5703	
	55	5507	5401	5655	5496	5309	
	60	5455	5619	5680	5326	5414	
	65	5345	5492	5295	5318	5273	
	70	5587	5530	5711	5615	5666	
	75	5638	5670	5622	5583	5691	
	80	5367	5626	5381	5561	5412	
	85	5682	5718	5589	5286	5289	
	90	5553	5314	5329	5261	5465	
	95	5541	5463	5574	5671	5458	

Trial ID	Radar Type	Pulse Width (μs)	PRI (μs)	Pulses per Hop	Hopping Rate (kHz)	Hopping Sequence Length (ms)	Visible Frequency Number
22	Type 6	1	333.3	9	0.3333	300	6
	Frequency List (MHz)	0	1	2	3	4	
	0	5264	5469	5351	5631	5659	
	5	5393	5627	5385	5279	5578	
	10	5428	5529	5535	5549	5575	
	15	5647	5572	5274	5415	5695	
	20	5608	5425	5668	5722	5389	
	25	5544	5370	5355	5517	5616	
	30	5528	5500	5633	5463	5685	
	35	5603	5292	5297	5349	5513	
	40	5577	5509	5523	5644	5488	
	45	5691	5412	5678	5495	5398	
	50	5343	5435	5564	5526	5451	
	55	5589	5462	5315	5280	5584	
	60	5309	5625	5336	5615	5294	
	65	5530	5702	5565	5596	5345	
	70	5670	5630	5560	5591	5607	
	75	5693	5468	5477	5407	5545	
	80	5721	5409	5402	5525	5552	
	85	5381	5483	5340	5326	5609	
	90	5494	5364	5499	5423	5465	
	95	5518	5558	5569	5716	5718	

Trial ID	Radar Type	Pulse Width (μs)	PRI (μs)	Pulses per Hop	Hopping Rate (kHz)	Hopping Sequence Length (ms)	Visible Frequency Number
23	Type 6	1	333.3	9	0.3333	300	7
	Frequency List (MHz)	0	1	2	3	4	
	0	5519	5708	5287	5695	5501	
	5	5435	5649	5460	5442	5407	
	10	5262	5318	5576	5269	5596	
	15	5638	5699	5377	5412	5591	
	20	5706	5336	5362	5432	5697	
	25	5387	5556	5454	5658	5417	
	30	5457	5373	5712	5408	5645	
	35	5480	5568	5350	5360	5352	
	40	5660	5323	5652	5520	5573	
	45	5468	5299	5470	5634	5285	
	50	5274	5486	5275	5349	5298	
	55	5680	5416	5463	5512	5251	
	60	5713	5474	5667	5683	5453	
	65	5282	5438	5718	5566	5534	
	70	5399	5514	5656	5633	5409	
	75	5567	5584	5338	5545	5623	
	80	5490	5663	5612	5309	5406	
	85	5694	5525	5499	5448	5294	
	90	5574	5332	5659	5370	5436	
	95	5477	5415	5542	5467	5319	

Trial ID	Radar Type	Pulse Width (μs)	PRI (μs)	Pulses per Hop	Hopping Rate (kHz)	Hopping Sequence Length (ms)	Visible Frequency Number
24	Type 6	1	333.3	9	0.3333	300	7
	Frequency List (MHz)	0	1	2	3	4	
	0	5299	5472	5698	5381	5721	
	5	5477	5574	5535	5508	5614	
	10	5668	5582	5617	5367	5251	
	15	5351	5383	5505	5604	5527	
	20	5660	5647	5328	5335	5549	
	25	5590	5488	5700	5403	5414	
	30	5588	5389	5703	5309	5571	
	35	5364	5503	5274	5666	5365	
	40	5261	5417	5517	5405	5448	
	45	5382	5528	5687	5695	5537	
	50	5717	5393	5370	5653	5331	
	55	5600	5270	5639	5612	5515	
	60	5376	5667	5269	5252	5677	
	65	5586	5642	5258	5636	5543	
	70	5458	5479	5623	5400	5444	
	75	5301	5372	5428	5341	5575	
	80	5290	5316	5345	5347	5627	
	85	5349	5470	5565	5432	5628	
	90	5676	5447	5672	5552	5468	
	95	5469	5359	5321	5325	5678	

Trial ID	Radar Type	Pulse Width (μs)	PRI (μs)	Pulses per Hop	Hopping Rate (kHz)	Hopping Sequence Length (ms)	Visible Frequency Number
25	Type 6	1	333.3	9	0.3333	300	7
	Frequency List (MHz)	0	1	2	3	4	
	0	5457	5711	5634	5542	5563	
	5	5616	5596	5610	5671	5346	
	10	5599	5371	5658	5562	5638	
	15	5339	5381	5486	5453	5321	
	20	5535	5351	5588	5417	5308	
	25	5586	5498	5318	5289	5522	
	30	5364	5292	5706	5426	5448	
	35	5662	5257	5656	5663	5505	
	40	5674	5657	5514	5334	5428	
	45	5465	5489	5265	5437	5404	
	50	5396	5373	5564	5581	5324	
	55	5368	5625	5571	5399	5329	
	60	5557	5347	5677	5271	5462	
	65	5541	5576	5383	5280	5250	
	70	5261	5485	5519	5502	5578	
	75	5525	5604	5652	5613	5700	
	80	5435	5400	5609	5331	5635	
	85	5385	5281	5299	5595	5350	
	90	5382	5407	5695	5546	5683	
	95	5607	5263	5655	5550	5459	

Trial ID	Radar Type	Pulse Width (μs)	PRI (μs)	Pulses per Hop	Hopping Rate (kHz)	Hopping Sequence Length (ms)	Visible Frequency Number
26	Type 6	1	333.3	9	0.3333	300	9
	Frequency List (MHz)	0	1	2	3	4	
	0	5712	5475	5570	5703	5308	
	5	5658	5521	5685	5359	5650	
	10	5433	5257	5699	5282	5659	
	15	5427	5508	5589	5498	5610	
	20	5446	5420	5626	5409	5281	
	25	5377	5350	5424	5393	5556	
	30	5406	5656	5328	5315	5721	
	35	5587	5278	5528	5431	5674	
	40	5441	5531	5515	5422	5608	
	45	5263	5408	5548	5547	5318	
	50	5324	5280	5572	5639	5542	
	55	5671	5294	5558	5347	5494	
	60	5502	5654	5600	5692	5663	
	65	5662	5577	5311	5414	5661	
	70	5352	5711	5361	5334	5398	
	75	5461	5289	5698	5668	5585	
	80	5429	5723	5481	5629	5595	
	85	5300	5329	5331	5597	5598	
	90	5624	5368	5645	5679	5485	
	95	5707	5563	5591	5636	5537	

Trial ID	Radar Type	Pulse Width (μs)	PRI (μs)	Pulses per Hop	Hopping Rate (kHz)	Hopping Sequence Length (ms)	Visible Frequency Number
27	Type 6	1	333.3	9	0.3333	300	8
	Frequency List (MHz)	0	1	2	3	4	
	0	5492	5714	5506	5389	5625	
	5	5700	5543	5285	5522	5382	
	10	5364	5521	5265	5477	5680	
	15	5418	5635	5692	5327	5454	
	20	5586	5567	5498	5254	5299	
	25	5627	5594	5590	5448	5642	
	30	5661	5564	5541	5629	5369	
	35	5324	5584	5588	5280	5614	
	40	5453	5565	5605	5570	5291	
	45	5631	5371	5589	5534	5273	
	50	5690	5494	5355	5482	5707	
	55	5641	5513	5657	5659	5544	
	60	5486	5426	5638	5611	5516	
	65	5618	5684	5464	5697	5658	
	70	5374	5420	5258	5721	5566	
	75	5681	5358	5262	5696	5297	
	80	5621	5709	5439	5672	5304	
	85	5616	5368	5491	5475	5341	
	90	5580	5318	5281	5380	5519	
	95	5537	5362	5645	5524	5325	

Trial ID	Radar Type	Pulse Width (μs)	PRI (μs)	Pulses per Hop	Hopping Rate (kHz)	Hopping Sequence Length (ms)	Visible Frequency Number
28	Type 6	1	333.3	9	0.3333	300	11
	Frequency List (MHz)	0	1	2	3	4	
	0	5272	5478	5539	5550	5370	
	5	5267	5565	5360	5588	5589	
	10	5295	5310	5306	5672	5701	
	15	5506	5287	5320	5491	5519	
	20	5462	5655	5508	5490	5702	
	25	5531	5626	5355	5698	5624	
	30	5717	5401	5716	5264	5293	
	35	5557	5692	5262	5502	5594	
	40	5319	5391	5330	5602	5499	
	45	5271	5336	5663	5424	5476	
	50	5410	5449	5266	5342	5317	
	55	5299	5670	5564	5463	5460	
	60	5387	5311	5349	5489	5415	
	65	5252	5681	5687	5560	5552	
	70	5353	5576	5593	5683	5464	
	75	5507	5350	5379	5605	5366	
	80	5382	5547	5361	5371	5518	
	85	5385	5721	5294	5341	5612	
	90	5378	5621	5389	5457	5292	
	95	5534	5497	5412	5374	5597	

Trial ID	Radar Type	Pulse Width (μs)	PRI (μs)	Pulses per Hop	Hopping Rate (kHz)	Hopping Sequence Length (ms)	Visible Frequency Number
29	Type 6	1	333.3	9	0.3333	300	10
	Frequency List (MHz)	0	1	2	3	4	
	0	5430	5717	5475	5711	5687	
	5	5406	5490	5435	5276	5321	
	10	5604	5574	5444	5295	5722	
	15	5594	5414	5326	5536	5373	
	20	5346	5546	5579	5675	5419	
	25	5478	5558	5327	5658	5629	
	30	5420	5674	5519	5559	5432	
	35	5648	5488	5512	5513	5433	
	40	5402	5329	5570	5599	5331	
	45	5251	5624	5477	5266	5286	
	50	5625	5317	5431	5518	5621	
	55	5653	5279	5358	5343	5514	
	60	5434	5650	5627	5413	5509	
	65	5491	5660	5371	5545	5665	
	70	5291	5467	5259	5338	5486	
	75	5428	5528	5613	5481	5299	
	80	5549	5309	5612	5695	5681	
	85	5581	5422	5540	5386	5699	
	90	5503	5446	5256	5462	5640	
	95	5427	5377	5487	5398	5307	

Radar Signal 6_5250 MHz

Trial ID	Radar Type	Pulse Width (μs)	PRI (μs)	Pulses per Hop	Hopping Rate (kHz)	Hopping Sequence Length (ms)	Visible Frequency Number
0	Type 6	1	333.3	9	0.3333	300	10
	Frequency List (MHz)	0	1	2	3	4	
	0	5364	5717	5334	5705	5549	
	5	5312	5260	5635	5503	5570	
	10	5347	5508	5292	5447	5588	
	15	5621	5638	5296	5482	5455	
	20	5636	5593	5434	5306	5411	
	25	5556	5378	5478	5432	5341	
	30	5438	5294	5496	5285	5327	
	35	5293	5502	5277	5403	5330	
	40	5612	5720	5544	5615	5561	
	45	5676	5704	5366	5290	5387	
	50	5278	5723	5383	5368	5263	
	55	5630	5375	5718	5281	5604	
	60	5453	5509	5479	5400	5262	
	65	5354	5467	5545	5466	5611	
	70	5715	5402	5568	5641	5396	
	75	5567	5557	5674	5359	5392	
	80	5313	5537	5258	5475	5272	
	85	5388	5474	5555	5410	5355	
	90	5517	5382	5386	5664	5697	
	95	5721	5268	5489	5706	5525	

Trial ID	Radar Type	Pulse Width (μs)	PRI (μs)	Pulses per Hop	Hopping Rate (kHz)	Hopping Sequence Length (ms)	Visible Frequency Number
1	Type 6	1	333.3	9	0.3333	300	7
	Frequency List (MHz)	0	1	2	3	4	
	0	5619	5578	5270	5294	5354	
	5	5660	5710	5666	5399	5656	
	10	5297	5333	5642	5609	5709	
	15	5668	5527	5647	5547	5284	
	20	5375	5395	5384	5444	5705	
	25	5584	5536	5480	5658	5453	
	30	5403	5576	5588	5641	5465	
	35	5674	5580	5623	5559	5627	
	40	5553	5704	5673	5633	5724	
	45	5373	5348	5331	5513	5637	
	50	5544	5314	5585	5697	5257	
	55	5672	5471	5423	5424	5638	
	60	5644	5345	5569	5655	5413	
	65	5271	5415	5550	5371	5335	
	70	5382	5416	5533	5706	5558	
	75	5535	5692	5256	5436	5716	
	80	5385	5669	5458	5349	5456	
	85	5336	5634	5703	5352	5280	
	90	5506	5313	5690	5326	5631	
	95	5628	5546	5289	5490	5590	

Trial ID	Radar Type	Pulse Width (μs)	PRI (μs)	Pulses per Hop	Hopping Rate (kHz)	Hopping Sequence Length (ms)	Visible Frequency Number
2	Type 6	1	333.3	9	0.3333	300	7
	Frequency List (MHz)	0	1	2	3	4	
	0	5302	5342	5681	5455	5611	
	5	5493	5682	5310	5257	5606	
	10	5587	5561	5374	5362	5630	
	15	5322	5320	5502	5475	5364	
	20	5555	5353	5316	5387	5357	
	25	5332	5654	5312	5262	5409	
	30	5522	5547	5410	5618	5253	
	35	5311	5683	5556	5470	5258	
	40	5537	5398	5710	5491	5469	
	45	5670	5465	5704	5456	5406	
	50	5384	5400	5513	5720	5365	
	55	5296	5276	5641	5445	5626	
	60	5564	5620	5395	5334	5290	
	65	5401	5578	5359	5569	5586	
	70	5282	5649	5407	5368	5647	
	75	5643	5509	5592	5675	5678	
	80	5581	5275	5381	5512	5600	
	85	5304	5382	5389	5458	5666	
	90	5419	5642	5350	5526	5519	
	95	5709	5692	5418	5653	5354	

Trial ID	Radar Type	Pulse Width (μs)	PRI (μs)	Pulses per Hop	Hopping Rate (kHz)	Hopping Sequence Length (ms)	Visible Frequency Number
3	Type 6	1	333.3	9	0.3333	300	7
	Frequency List (MHz)	0	1	2	3	4	
	0	5557	5581	5617	5616	5356	
	5	5535	5704	5385	5420	5338	
	10	5518	5350	5415	5651	5313	
	15	5447	5605	5520	5653	5563	
	20	5519	5257	5476	5330	5598	
	25	5506	5515	5366	5443	5661	
	30	5533	5367	5358	5502	5606	
	35	5347	5647	5266	5411	5451	
	40	5334	5332	5709	5667	5394	
	45	5684	5539	5464	5437	5665	
	50	5389	5421	5416	5574	5488	
	55	5536	5580	5279	5439	5324	
	60	5499	5710	5708	5404	5305	
	65	5295	5525	5589	5359	5452	
	70	5576	5272	5492	5388	5551	
	75	5547	5323	5724	5256	5721	
	80	5293	5379	5584	5361	5508	
	85	5479	5693	5341	5655	5715	
	90	5629	5494	5401	5637	5423	
	95	5280	5316	5662	5281	5649	

Trial ID	Radar Type	Pulse Width (μs)	PRI (μs)	Pulses per Hop	Hopping Rate (kHz)	Hopping Sequence Length (ms)	Visible Frequency Number
4	Type 6	1	333.3	9	0.3333	300	11
	Frequency List (MHz)	0	1	2	3	4	
	0	5337	5345	5553	5302	5673	
	5	5577	5629	5460	5583	5642	
	10	5352	5614	5456	5655	5672	
	15	5401	5574	5611	5565	5370	
	20	5571	5588	5295	5468	5303	
	25	5486	5358	5718	5470	5380	
	30	5703	5422	5324	5573	5654	
	35	5426	5263	5634	5661	5462	
	40	5648	5498	5270	5474	5664	
	45	5701	5622	5425	5490	5552	
	50	5265	5597	5467	5300	5432	
	55	5724	5437	5469	5258	5715	
	60	5453	5277	5637	5705	5348	
	65	5593	5262	5561	5251	5255	
	70	5275	5341	5364	5510	5516	
	75	5346	5712	5504	5549	5356	
	80	5527	5376	5264	5447	5442	
	85	5454	5658	5428	5544	5374	
	90	5343	5663	5478	5689	5384	
	95	5372	5707	5274	5292	5466	

Trial ID	Radar Type	Pulse Width (μs)	PRI (μs)	Pulses per Hop	Hopping Rate (kHz)	Hopping Sequence Length (ms)	Visible Frequency Number
5	Type 6	1	333.3	9	0.3333	300	13
	Frequency List (MHz)	0	1	2	3	4	
	0	5592	5584	5489	5463	5418	
	5	5619	5651	5535	5271	5374	
	10	5283	5500	5594	5375	5693	
	15	5604	5714	5610	5562	5482	
	20	5279	5711	5557	5276	5277	
	25	5307	5446	5574	5414	5270	
	30	5408	5281	5691	5428	5624	
	35	5625	5354	5430	5339	5376	
	40	5487	5581	5683	5617	5630	
	45	5644	5705	5483	5342	5519	
	50	5298	5518	5563	5598	5437	
	55	5391	5659	5455	5686	5582	
	60	5697	5469	5628	5294	5319	
	65	5597	5631	5521	5436	5423	
	70	5278	5665	5340	5485	5466	
	75	5438	5315	5275	5614	5330	
	80	5520	5590	5596	5264	5289	
	85	5405	5646	5526	5346	5676	
	90	5267	5539	5349	5600	5258	
	95	5671	5533	5345	5587	5523	

Trial ID	Radar Type	Pulse Width (μs)	PRI (μs)	Pulses per Hop	Hopping Rate (kHz)	Hopping Sequence Length (ms)	Visible Frequency Number
6	Type 6	1	333.3	9	0.3333	300	9
	Frequency List (MHz)	0	1	2	3	4	
	0	5372	5348	5425	5624	5260	
	5	5283	5576	5610	5434	5581	
	10	5689	5289	5635	5570	5714	
	15	5577	5256	5342	5558	5279	
	20	5490	5652	5549	5724	5640	
	25	5634	5552	5300	5448	5409	
	30	5297	5713	5431	5580	5444	
	35	5667	5445	5701	5492	5290	
	40	5326	5286	5621	5382	5280	
	45	5559	5313	5541	5499	5704	
	50	5395	5474	5569	5274	5421	
	55	5698	5625	5345	5374	5657	
	60	5711	5519	5642	5301	5454	
	65	5715	5520	5536	5366	5413	
	70	5414	5378	5417	5316	5428	
	75	5357	5586	5484	5296	5430	
	80	5627	5684	5653	5273	5606	
	85	5465	5363	5491	5352	5355	
	90	5518	5631	5688	5588	5329	
	95	5485	5502	5590	5390	5531	

Trial ID	Radar Type	Pulse Width (μs)	PRI (μs)	Pulses per Hop	Hopping Rate (kHz)	Hopping Sequence Length (ms)	Visible Frequency Number
7	Type 6	1	333.3	9	0.3333	300	13
	Frequency List (MHz)	0	1	2	3	4	
	0	5530	5587	5361	5310	5480	
	5	5325	5598	5685	5500	5410	
	10	5523	5553	5676	5290	5260	
	15	5568	5383	5445	5603	5471	
	20	5498	5514	5690	5638	5697	
	25	5431	5583	5280	5404	5482	
	30	5451	5661	5670	5646	5354	
	35	5642	5331	5633	5594	5267	
	40	5301	5640	5369	5559	5622	
	45	5277	5391	5507	5396	5502	
	50	5552	5494	5271	5650	5620	
	55	5363	5719	5545	5338	5299	
	60	5564	5628	5268	5684	5608	
	65	5283	5343	5584	5572	5673	
	70	5683	5517	5492	5381	5266	
	75	5292	5387	5326	5706	5627	
	80	5682	5262	5367	5276	5716	
	85	5270	5511	5428	5458	5359	
	90	5351	5600	5285	5394	5571	
	95	5400	5265	5327	5643	5313	

Trial ID	Radar Type	Pulse Width (μs)	PRI (μs)	Pulses per Hop	Hopping Rate (kHz)	Hopping Sequence Length (ms)	Visible Frequency Number
8	Type 6	1	333.3	9	0.3333	300	9
	Frequency List (MHz)	0	1	2	3	4	
	0	5310	5351	5297	5374	5322	
	5	5367	5523	5285	5663	5617	
	10	5454	5342	5717	5485	5281	
	15	5656	5510	5548	5648	5409	
	20	5680	5631	5630	5670	5319	
	25	5435	5483	5508	5516	5493	
	30	5647	5627	5386	5506	5462	
	35	5470	5724	5390	5420	5690	
	40	5576	5452	5497	5387	5274	
	45	5320	5487	5479	5560	5605	
	50	5381	5622	5671	5445	5489	
	55	5526	5253	5279	5502	5397	
	60	5629	5440	5678	5704	5544	
	65	5533	5608	5408	5478	5655	
	70	5481	5590	5268	5346	5673	
	75	5254	5295	5258	5459	5372	
	80	5623	5401	5267	5706	5545	
	85	5488	5650	5324	5305	5373	
	90	5559	5464	5660	5344	5698	
	95	5394	5378	5363	5321	5311	

Trial ID	Radar Type	Pulse Width (μs)	PRI (μs)	Pulses per Hop	Hopping Rate (kHz)	Hopping Sequence Length (ms)	Visible Frequency Number
9	Type 6	1	333.3	9	0.3333	300	12
	Frequency List (MHz)	0	1	2	3	4	
	0	5565	5590	5708	5535	5542	
	5	5409	5545	5360	5351	5349	
	10	5288	5606	5283	5583	5302	
	15	5269	5637	5554	5693	5380	
	20	5417	5274	5572	5719	5643	
	25	5682	5287	5686	5612	5550	
	30	5632	5536	5584	5504	5280	
	35	5660	5512	5340	5661	5573	
	40	5604	5415	5435	5530	5271	
	45	5627	5467	5562	5618	5658	
	50	5646	5401	5527	5722	5541	
	55	5268	5336	5714	5372	5473	
	60	5526	5539	5574	5369	5650	
	65	5367	5482	5547	5715	5370	
	70	5598	5252	5464	5484	5439	
	75	5622	5305	5642	5374	5341	
	80	5711	5385	5404	5264	5523	
	85	5448	5326	5451	5270	5667	
	90	5356	5621	5303	5724	5470	
	95	5639	5386	5361	5278	5378	

Trial ID	Radar Type	Pulse Width (μs)	PRI (μs)	Pulses per Hop	Hopping Rate (kHz)	Hopping Sequence Length (ms)	Visible Frequency Number
10	Type 6	1	333.3	9	0.3333	300	6
	Frequency List (MHz)	0	1	2	3	4	
	0	5345	5354	5644	5696	5384	
	5	5548	5470	5435	5514	5653	
	10	5694	5492	5324	5303	5323	
	15	5357	5667	5657	5641	5572	
	20	5425	5440	5610	5711	5616	
	25	5473	5414	5338	5584	5674	
	30	5541	5719	5432	5480	5651	
	35	5431	5457	5348	5615	5254	
	40	5715	5373	5295	5365	5556	
	45	5447	5645	5579	5533	5277	
	50	5703	5298	5252	5566	5280	
	55	5330	5636	5562	5403	5444	
	60	5655	5704	5519	5676	5427	
	65	5596	5568	5583	5450	5640	
	70	5304	5421	5547	5288	5598	
	75	5264	5494	5484	5695	5488	
	80	5495	5660	5293	5527	5639	
	85	5718	5351	5643	5511	5462	
	90	5632	5310	5394	5501	5476	
	95	5576	5327	5378	5333	5362	

Trial ID	Radar Type	Pulse Width (μs)	PRI (μs)	Pulses per Hop	Hopping Rate (kHz)	Hopping Sequence Length (ms)	Visible Frequency Number
11	Type 6	1	333.3	9	0.3333	300	6
	Frequency List (MHz)	0	1	2	3	4	
	0	5503	5593	5580	5382	5604	
	5	5590	5492	5510	5385	5625	
	10	5281	5365	5498	5344	5348	
	15	5319	5285	5686	5386	5336	
	20	5509	5551	5325	5589	5361	
	25	5563	5520	5442	5618	5716	
	30	5411	5459	5681	5300	5315	
	35	5522	5350	5501	5529	5568	
	40	5323	5689	5535	5362	5485	
	45	5427	5253	5637	5667	5628	
	50	5404	5349	5341	5389	5602	
	55	5518	5277	5697	5415	5309	
	60	5394	5464	5508	5639	5391	
	65	5380	5282	5532	5582	5493	
	70	5533	5587	5515	5574	5698	
	75	5483	5614	5530	5676	5265	
	80	5605	5441	5360	5636	5438	
	85	5351	5474	5654	5500	5642	
	90	5321	5579	5482	5610	5684	
	95	5388	5443	5547	5581	5527	

Trial ID	Radar Type	Pulse Width (μs)	PRI (μs)	Pulses per Hop	Hopping Rate (kHz)	Hopping Sequence Length (ms)	Visible Frequency Number
12	Type 6	1	333.3	9	0.3333	300	9
	Frequency List (MHz)	0	1	2	3	4	
	0	5283	5357	5516	5543	5446	
	5	5632	5417	5585	5268	5592	
	10	5459	5545	5406	5693	5365	
	15	5436	5388	5256	5578	5344	
	20	5675	5492	5317	5562	5627	
	25	5512	5723	5546	5652	5380	
	30	5300	5455	5674	5358	5498	
	35	5454	5710	5621	5654	5443	
	40	5504	5678	5359	5407	5336	
	45	5695	5720	5685	5580	5400	
	50	5430	5687	5706	5544	5467	
	55	5419	5289	5438	5559	5506	
	60	5340	5554	5329	5558	5327	
	65	5385	5662	5519	5590	5364	
	70	5550	5657	5355	5259	5673	
	75	5420	5618	5697	5524	5275	
	80	5633	5254	5424	5534	5274	
	85	5465	5315	5415	5269	5488	
	90	5547	5566	5616	5509	5427	
	95	5445	5560	5636	5347	5432	

Trial ID	Radar Type	Pulse Width (μs)	PRI (μs)	Pulses per Hop	Hopping Rate (kHz)	Hopping Sequence Length (ms)	Visible Frequency Number
13	Type 6	1	333.3	9	0.3333	300	11
	Frequency List (MHz)	0	1	2	3	4	
	0	5538	5596	5452	5704	5666	
	5	5674	5439	5660	5431	5324	
	10	5390	5334	5544	5413	5386	
	15	5524	5573	5491	5301	5295	
	20	5352	5269	5530	5406	5535	
	25	5515	5364	5451	5650	5686	
	30	5422	5664	5412	5317	5607	
	35	5318	5496	5326	5417	5429	
	40	5454	5343	5489	5565	5443	
	45	5356	5721	5387	5419	5656	
	50	5298	5475	5283	5281	5519	
	55	5393	5498	5657	5713	5260	
	60	5470	5724	5647	5477	5531	
	65	5278	5594	5597	5663	5259	
	70	5505	5690	5688	5526	5282	
	75	5719	5638	5672	5253	5478	
	80	5338	5630	5450	5632	5266	
	85	5497	5466	5333	5366	5339	
	90	5434	5591	5581	5351	5250	
	95	5411	5442	5264	5545	5527	

Trial ID	Radar Type	Pulse Width (μs)	PRI (μs)	Pulses per Hop	Hopping Rate (kHz)	Hopping Sequence Length (ms)	Visible Frequency Number
14	Type 6	1	333.3	9	0.3333	300	8
	Frequency List (MHz)	0	1	2	3	4	
	0	5318	5360	5388	5390	5508	
	5	5338	5364	5260	5594	5628	
	10	5321	5598	5585	5511	5407	
	15	5612	5700	5497	5724	5487	
	20	5263	5435	5471	5398	5306	
	25	5691	5654	5279	5720	5464	
	30	5650	5369	5532	5284	5516	
	35	5635	5417	5310	5582	5368	
	40	5657	5669	5503	5683	5353	
	45	5553	5270	5502	5714	5351	
	50	5362	5634	5457	5608	5711	
	55	5337	5607	5452	5372	5706	
	60	5599	5414	5396	5576	5303	
	65	5574	5616	5702	5533	5534	
	70	5489	5466	5428	5588	5693	
	75	5537	5478	5293	5402	5387	
	80	5716	5449	5266	5259	5377	
	85	5401	5627	5645	5632	5583	
	90	5557	5561	5298	5320	5339	
	95	5597	5518	5708	5262	5543	

Trial ID	Radar Type	Pulse Width (μs)	PRI (μs)	Pulses per Hop	Hopping Rate (kHz)	Hopping Sequence Length (ms)	Visible Frequency Number
15	Type 6	1	333.3	9	0.3333	300	12
	Frequency List (MHz)	0	1	2	3	4	
	0	5573	5599	5324	5551	5253	
	5	5380	5386	5335	5660	5360	
	10	5630	5484	5626	5706	5428	
	15	5603	5255	5600	5294	5679	
	20	5271	5504	5412	5487	5481	
	25	5669	5640	5382	5480	5279	
	30	5506	5539	5326	5272	5533	
	35	5336	5299	5508	5581	5260	
	40	5282	5496	5277	5441	5448	
	45	5447	5482	5250	5585	5297	
	50	5404	5627	5510	5633	5553	
	55	5319	5534	5659	5320	5406	
	60	5562	5351	5677	5579	5438	
	65	5408	5604	5520	5342	5651	
	70	5569	5366	5284	5647	5500	
	75	5574	5318	5289	5381	5437	
	80	5522	5530	5697	5701	5376	
	85	5515	5444	5561	5624	5365	
	90	5535	5278	5641	5371	5587	
	95	5357	5552	5493	5560	5608	

Trial ID	Radar Type	Pulse Width (μs)	PRI (μs)	Pulses per Hop	Hopping Rate (kHz)	Hopping Sequence Length (ms)	Visible Frequency Number
16	Type 6	1	333.3	9	0.3333	300	10
	Frequency List (MHz)	0	1	2	3	4	
	0	5256	5460	5260	5615	5570	
	5	5422	5311	5410	5348	5567	
	10	5561	5273	5667	5426	5449	
	15	5691	5382	5703	5339	5396	
	20	5279	5670	5353	5479	5454	
	25	5557	5492	5488	5584	5313	
	30	5645	5525	5283	5487	5685	
	35	5534	5341	5599	5377	5413	
	40	5671	5335	5360	5379	5591	
	45	5444	5411	5705	5668	5258	
	50	5457	5514	5289	5334	5604	
	55	5408	5357	5603	5263	5655	
	60	5548	5551	5269	5383	5715	
	65	5527	5466	5640	5600	5508	
	70	5576	5651	5450	5669	5560	
	75	5321	5613	5609	5642	5678	
	80	5478	5486	5296	5608	5624	
	85	5524	5438	5364	5580	5470	
	90	5606	5325	5555	5489	5375	
	95	5480	5674	5663	5282	5573	

Trial ID	Radar Type	Pulse Width (μs)	PRI (μs)	Pulses per Hop	Hopping Rate (kHz)	Hopping Sequence Length (ms)	Visible Frequency Number
17	Type 6	1	333.3	9	0.3333	300	10
	Frequency List (MHz)	0	1	2	3	4	
	0	5511	5699	5671	5301	5315	
	5	5464	5333	5485	5396	5492	
	10	5537	5708	5621	5470	5304	
	15	5509	5331	5287	5588	5665	
	20	5264	5391	5568	5427	5348	
	25	5441	5691	5688	5347	5687	
	30	5414	5715	5605	5459	5354	
	35	5480	5312	5648	5663	5682	
	40	5271	5540	5317	5356	5718	
	45	5685	5276	5316	5413	5640	
	50	5510	5655	5497	5558	5450	
	55	5599	5692	5370	5367	5522	
	60	5434	5328	5547	5353	5412	
	65	5366	5549	5544	5408	5446	
	70	5253	5266	5546	5421	5462	
	75	5355	5481	5719	5659	5633	
	80	5499	5552	5297	5521	5280	
	85	5438	5681	5543	5565	5474	
	90	5279	5608	5375	5619	5712	
	95	5523	5257	5541	5507	5261	

Trial ID	Radar Type	Pulse Width (μs)	PRI (μs)	Pulses per Hop	Hopping Rate (kHz)	Hopping Sequence Length (ms)	Visible Frequency Number
18	Type 6	1	333.3	9	0.3333	300	7
	Frequency List (MHz)	0	1	2	3	4	
	0	5291	5463	5607	5462	5632	
	5	5603	5258	5560	5674	5326	
	10	5274	5341	5491	5392	5636	
	15	5434	5332	5305	5673	5430	
	20	5400	5711	5293	5419	5317	
	25	5381	5254	5303	5672	5345	
	30	5611	5649	5619	5403	5541	
	35	5596	5585	5623	5633	5438	
	40	5647	5665	5359	5374	5466	
	45	5666	5516	5589	5706	5586	
	50	5394	5312	5646	5661	5493	
	55	5543	5599	5273	5476	5276	
	60	5455	5664	5498	5580	5618	
	65	5338	5531	5435	5629	5424	
	70	5311	5309	5314	5450	5310	
	75	5290	5640	5410	5609	5333	
	80	5461	5275	5518	5572	5620	
	85	5506	5282	5342	5330	5573	
	90	5718	5557	5517	5601	5708	
	95	5298	5525	5405	5304	5682	

Trial ID	Radar Type	Pulse Width (μs)	PRI (μs)	Pulses per Hop	Hopping Rate (kHz)	Hopping Sequence Length (ms)	Visible Frequency Number
19	Type 6	1	333.3	9	0.3333	300	12
	Frequency List (MHz)	0	1	2	3	4	
	0	5546	5702	5543	5623	5377	
	5	5645	5280	5635	5265	5335	
	10	5257	5590	5315	5439	5512	
	15	5383	5288	5440	5594	5681	
	20	5596	5273	5649	5373	5502	
	25	5620	5622	5518	5415	5393	
	30	5289	5629	5560	5385	5372	
	35	5283	5494	5337	5510	5424	
	40	5706	5571	5361	5435	5479	
	45	5442	5519	5456	5392	5290	
	50	5282	5297	5679	5716	5500	
	55	5600	5275	5464	5672	5308	
	60	5577	5401	5390	5447	5450	
	65	5608	5334	5507	5615	5524	
	70	5285	5322	5430	5433	5621	
	75	5662	5719	5589	5528	5515	
	80	5292	5462	5566	5307	5284	
	85	5296	5474	5724	5399	5710	
	90	5250	5353	5509	5303	5597	
	95	5407	5428	5562	5678	5300	

Trial ID	Radar Type	Pulse Width (μs)	PRI (μs)	Pulses per Hop	Hopping Rate (kHz)	Hopping Sequence Length (ms)	Visible Frequency Number
20	Type 6	1	333.3	9	0.3333	300	6
	Frequency List (MHz)	0	1	2	3	4	
	0	5704	5466	5479	5309	5597	
	5	5687	5680	5710	5428	5639	
	10	5566	5379	5356	5634	5533	
	15	5471	5318	5543	5422	5311	
	20	5592	5665	5641	5443	5390	
	25	5569	5350	5622	5449	5435	
	30	5653	5586	5300	5537	5667	
	35	5325	5585	5608	5269	5521	
	40	5263	5314	5509	5504	5529	
	45	5408	5528	5525	5393	5572	
	50	5343	5646	5333	5386	5502	
	55	5660	5688	5554	5465	5677	
	60	5338	5326	5454	5260	5615	
	65	5403	5347	5591	5396	5555	
	70	5515	5579	5601	5527	5387	
	75	5261	5707	5291	5550	5602	
	80	5439	5257	5370	5692	5498	
	85	5512	5487	5719	5401	5650	
	90	5335	5402	5255	5659	5722	
	95	5364	5493	5676	5510	5700	

Trial ID	Radar Type	Pulse Width (μs)	PRI (μs)	Pulses per Hop	Hopping Rate (kHz)	Hopping Sequence Length (ms)	Visible Frequency Number
21	Type 6	1	333.3	9	0.3333	300	9
	Frequency List (MHz)	0	1	2	3	4	
	0	5484	5705	5415	5470	5439	
	5	5351	5702	5310	5591	5371	
	10	5497	5265	5494	5354	5554	
	15	5559	5445	5646	5370	5503	
	20	5600	5356	5252	5255	5416	
	25	5656	5421	5456	5251	5483	
	30	5477	5542	5543	5418	5311	
	35	5390	5464	5676	5501	5422	
	40	5435	5674	5447	5269	5526	
	45	5337	5508	5608	5451	5625	
	50	5522	5642	5384	5475	5703	
	55	5507	5401	5655	5496	5309	
	60	5455	5619	5680	5326	5414	
	65	5345	5492	5295	5318	5273	
	70	5587	5530	5711	5615	5666	
	75	5638	5670	5622	5583	5691	
	80	5367	5626	5381	5561	5412	
	85	5682	5718	5589	5286	5289	
	90	5553	5314	5329	5261	5465	
	95	5541	5463	5574	5671	5458	

Trial ID	Radar Type	Pulse Width (μs)	PRI (μs)	Pulses per Hop	Hopping Rate (kHz)	Hopping Sequence Length (ms)	Visible Frequency Number
22	Type 6	1	333.3	9	0.3333	300	4
	Frequency List (MHz)	0	1	2	3	4	
	0	5264	5469	5351	5631	5659	
	5	5393	5627	5385	5279	5578	
	10	5428	5529	5535	5549	5575	
	15	5647	5572	5274	5415	5695	
	20	5608	5425	5668	5722	5389	
	25	5544	5370	5355	5517	5616	
	30	5528	5500	5633	5463	5685	
	35	5603	5292	5297	5349	5513	
	40	5577	5509	5523	5644	5488	
	45	5691	5412	5678	5495	5398	
	50	5343	5435	5564	5526	5451	
	55	5589	5462	5315	5280	5584	
	60	5309	5625	5336	5615	5294	
	65	5530	5702	5565	5596	5345	
	70	5670	5630	5560	5591	5607	
	75	5693	5468	5477	5407	5545	
	80	5721	5409	5402	5525	5552	
	85	5381	5483	5340	5326	5609	
	90	5494	5364	5499	5423	5465	
	95	5518	5558	5569	5716	5718	

Trial ID	Radar Type	Pulse Width (μs)	PRI (μs)	Pulses per Hop	Hopping Rate (kHz)	Hopping Sequence Length (ms)	Visible Frequency Number
23	Type 6	1	333.3	9	0.3333	300	8
	Frequency List (MHz)	0	1	2	3	4	
	0	5519	5708	5287	5695	5501	
	5	5435	5649	5460	5442	5407	
	10	5262	5318	5576	5269	5596	
	15	5638	5699	5377	5412	5591	
	20	5706	5336	5362	5432	5697	
	25	5387	5556	5454	5658	5417	
	30	5457	5373	5712	5408	5645	
	35	5480	5568	5350	5360	5352	
	40	5660	5323	5652	5520	5573	
	45	5468	5299	5470	5634	5285	
	50	5274	5486	5275	5349	5298	
	55	5680	5416	5463	5512	5251	
	60	5713	5474	5667	5683	5453	
	65	5282	5438	5718	5566	5534	
	70	5399	5514	5656	5633	5409	
	75	5567	5584	5338	5545	5623	
	80	5490	5663	5612	5309	5406	
	85	5694	5525	5499	5448	5294	
	90	5574	5332	5659	5370	5436	
	95	5477	5415	5542	5467	5319	

Trial ID	Radar Type	Pulse Width (μs)	PRI (μs)	Pulses per Hop	Hopping Rate (kHz)	Hopping Sequence Length (ms)	Visible Frequency Number
24	Type 6	1	333.3	9	0.3333	300	7
	Frequency List (MHz)	0	1	2	3	4	
	0	5299	5472	5698	5381	5721	
	5	5477	5574	5535	5508	5614	
	10	5668	5582	5617	5367	5251	
	15	5351	5383	5505	5604	5527	
	20	5660	5647	5328	5335	5549	
	25	5590	5488	5700	5403	5414	
	30	5588	5389	5703	5309	5571	
	35	5364	5503	5274	5666	5365	
	40	5261	5417	5517	5405	5448	
	45	5382	5528	5687	5695	5537	
	50	5717	5393	5370	5653	5331	
	55	5600	5270	5639	5612	5515	
	60	5376	5667	5269	5252	5677	
	65	5586	5642	5258	5636	5543	
	70	5458	5479	5623	5400	5444	
	75	5301	5372	5428	5341	5575	
	80	5290	5316	5345	5347	5627	
	85	5349	5470	5565	5432	5628	
	90	5676	5447	5672	5552	5468	
	95	5469	5359	5321	5325	5678	

Trial ID	Radar Type	Pulse Width (μs)	PRI (μs)	Pulses per Hop	Hopping Rate (kHz)	Hopping Sequence Length (ms)	Visible Frequency Number
25	Type 6	1	333.3	9	0.3333	300	9
	Frequency List (MHz)	0	1	2	3	4	
	0	5457	5711	5634	5542	5563	
	5	5616	5596	5610	5671	5346	
	10	5599	5371	5658	5562	5638	
	15	5339	5381	5486	5453	5321	
	20	5535	5351	5588	5417	5308	
	25	5586	5498	5318	5289	5522	
	30	5364	5292	5706	5426	5448	
	35	5662	5257	5656	5663	5505	
	40	5674	5657	5514	5334	5428	
	45	5465	5489	5265	5437	5404	
	50	5396	5373	5564	5581	5324	
	55	5368	5625	5571	5399	5329	
	60	5557	5347	5677	5271	5462	
	65	5541	5576	5383	5280	5250	
	70	5261	5485	5519	5502	5578	
	75	5525	5604	5652	5613	5700	
	80	5435	5400	5609	5331	5635	
	85	5385	5281	5299	5595	5350	
	90	5382	5407	5695	5546	5683	
	95	5607	5263	5655	5550	5459	

Trial ID	Radar Type	Pulse Width (μs)	PRI (μs)	Pulses per Hop	Hopping Rate (kHz)	Hopping Sequence Length (ms)	Visible Frequency Number
26	Type 6	1	333.3	9	0.3333	300	7
	Frequency List (MHz)	0	1	2	3	4	
	0	5712	5475	5570	5703	5308	
	5	5658	5521	5685	5359	5650	
	10	5433	5257	5699	5282	5659	
	15	5427	5508	5589	5498	5610	
	20	5446	5420	5626	5409	5281	
	25	5377	5350	5424	5393	5556	
	30	5406	5656	5328	5315	5721	
	35	5587	5278	5528	5431	5674	
	40	5441	5531	5515	5422	5608	
	45	5263	5408	5548	5547	5318	
	50	5324	5280	5572	5639	5542	
	55	5671	5294	5558	5347	5494	
	60	5502	5654	5600	5692	5663	
	65	5662	5577	5311	5414	5661	
	70	5352	5711	5361	5334	5398	
	75	5461	5289	5698	5668	5585	
	80	5429	5723	5481	5629	5595	
	85	5300	5329	5331	5597	5598	
	90	5624	5368	5645	5679	5485	
	95	5707	5563	5591	5636	5537	

Trial ID	Radar Type	Pulse Width (μs)	PRI (μs)	Pulses per Hop	Hopping Rate (kHz)	Hopping Sequence Length (ms)	Visible Frequency Number
27	Type 6	1	333.3	9	0.3333	300	8
	Frequency List (MHz)	0	1	2	3	4	
	0	5492	5714	5506	5389	5625	
	5	5700	5543	5285	5522	5382	
	10	5364	5521	5265	5477	5680	
	15	5418	5635	5692	5327	5454	
	20	5586	5567	5498	5254	5299	
	25	5627	5594	5590	5448	5642	
	30	5661	5564	5541	5629	5369	
	35	5324	5584	5588	5280	5614	
	40	5453	5565	5605	5570	5291	
	45	5631	5371	5589	5534	5273	
	50	5690	5494	5355	5482	5707	
	55	5641	5513	5657	5659	5544	
	60	5486	5426	5638	5611	5516	
	65	5618	5684	5464	5697	5658	
	70	5374	5420	5258	5721	5566	
	75	5681	5358	5262	5696	5297	
	80	5621	5709	5439	5672	5304	
	85	5616	5368	5491	5475	5341	
	90	5580	5318	5281	5380	5519	
	95	5537	5362	5645	5524	5325	

Trial ID	Radar Type	Pulse Width (μs)	PRI (μs)	Pulses per Hop	Hopping Rate (kHz)	Hopping Sequence Length (ms)	Visible Frequency Number
28	Type 6	1	333.3	9	0.3333	300	8
	Frequency List (MHz)	0	1	2	3	4	
	0	5272	5478	5539	5550	5370	
	5	5267	5565	5360	5588	5589	
	10	5295	5310	5306	5672	5701	
	15	5506	5287	5320	5491	5519	
	20	5462	5655	5508	5490	5702	
	25	5531	5626	5355	5698	5624	
	30	5717	5401	5716	5264	5293	
	35	5557	5692	5262	5502	5594	
	40	5319	5391	5330	5602	5499	
	45	5271	5336	5663	5424	5476	
	50	5410	5449	5266	5342	5317	
	55	5299	5670	5564	5463	5460	
	60	5387	5311	5349	5489	5415	
	65	5252	5681	5687	5560	5552	
	70	5353	5576	5593	5683	5464	
	75	5507	5350	5379	5605	5366	
	80	5382	5547	5361	5371	5518	
	85	5385	5721	5294	5341	5612	
	90	5378	5621	5389	5457	5292	
	95	5534	5497	5412	5374	5597	

Trial ID	Radar Type	Pulse Width (μs)	PRI (μs)	Pulses per Hop	Hopping Rate (kHz)	Hopping Sequence Length (ms)	Visible Frequency Number
29	Type 6	1	333.3	9	0.3333	300	7
	Frequency List (MHz)	0	1	2	3	4	
	0	5430	5717	5475	5711	5687	
	5	5406	5490	5435	5276	5321	
	10	5604	5574	5444	5295	5722	
	15	5594	5414	5326	5536	5373	
	20	5346	5546	5579	5675	5419	
	25	5478	5558	5327	5658	5629	
	30	5420	5674	5519	5559	5432	
	35	5648	5488	5512	5513	5433	
	40	5402	5329	5570	5599	5331	
	45	5251	5624	5477	5266	5286	
	50	5625	5317	5431	5518	5621	
	55	5653	5279	5358	5343	5514	
	60	5434	5650	5627	5413	5509	
	65	5491	5660	5371	5545	5665	
	70	5291	5467	5259	5338	5486	
	75	5428	5528	5613	5481	5299	
	80	5549	5309	5612	5695	5681	
	85	5581	5422	5540	5386	5699	
	90	5503	5446	5256	5462	5640	
	95	5427	5377	5487	5398	5307	

8.4 CHANNEL AVAILABILITY CHECK TIME

If the UUT successfully detected the radar burst, it should be observed as the UUT has no transmissions occurred until the UUT starts transmitting on another channel.

Test Mode UNII-2C, Nominal Bandwidth / Channel: 20 MHz / 5540 MHz

Initial Channel Availability Check Time

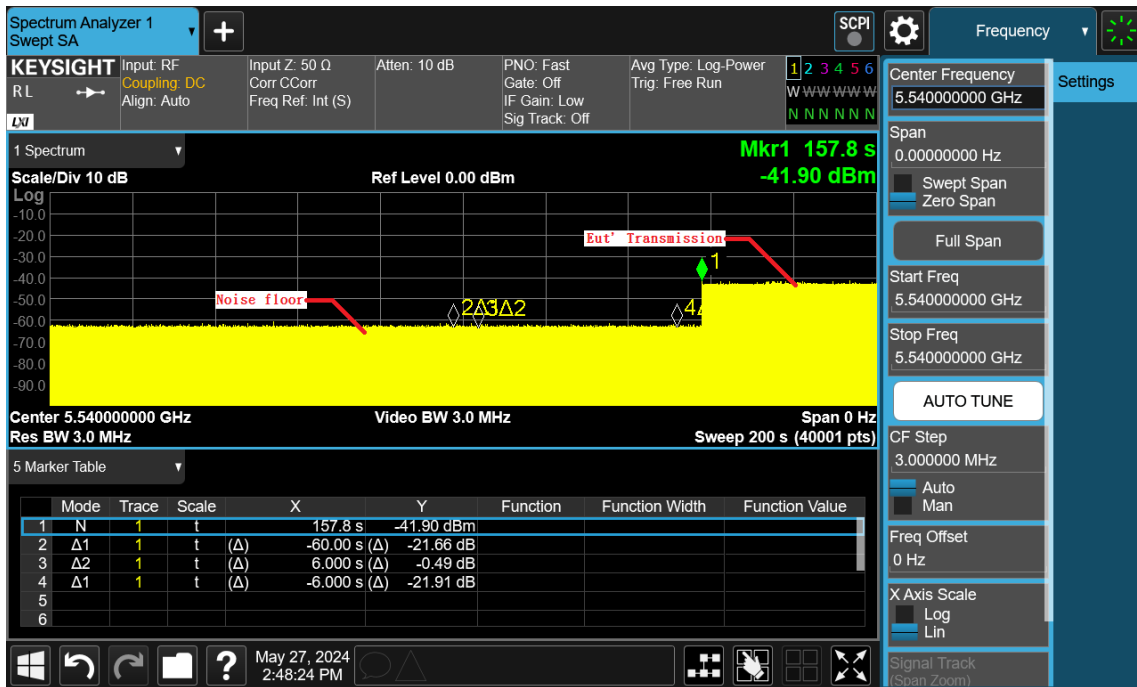

Radar Burst at the Beginning of the Channel Availability Check Time

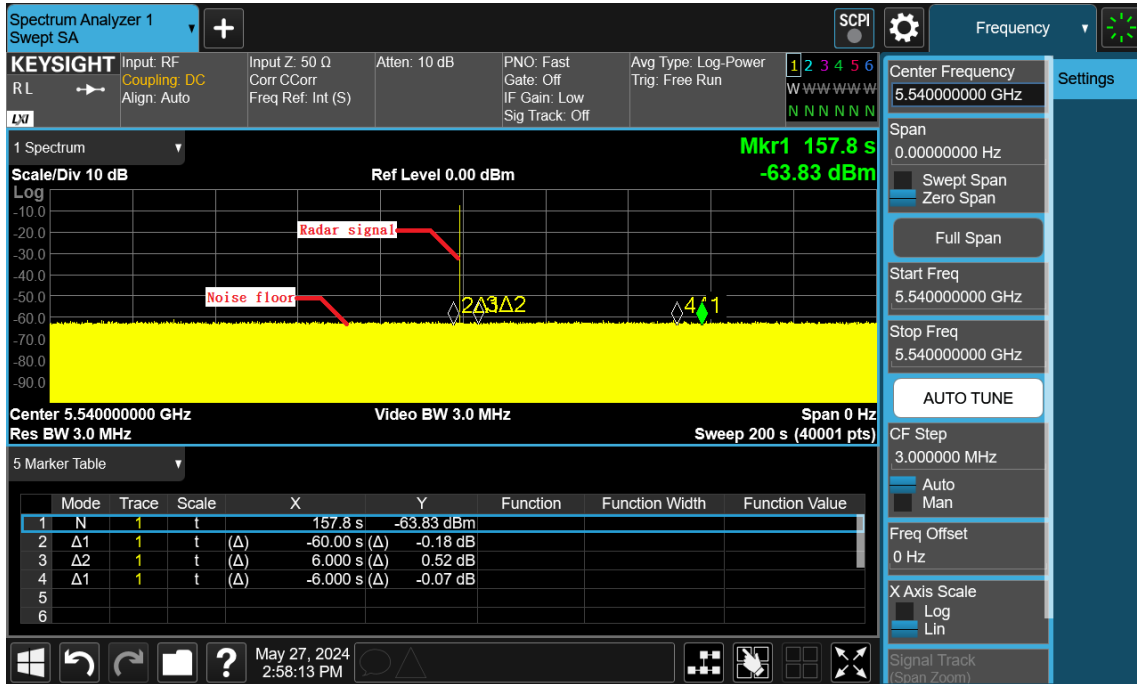

Radar Burst at the End of the Channel Availability Check Time

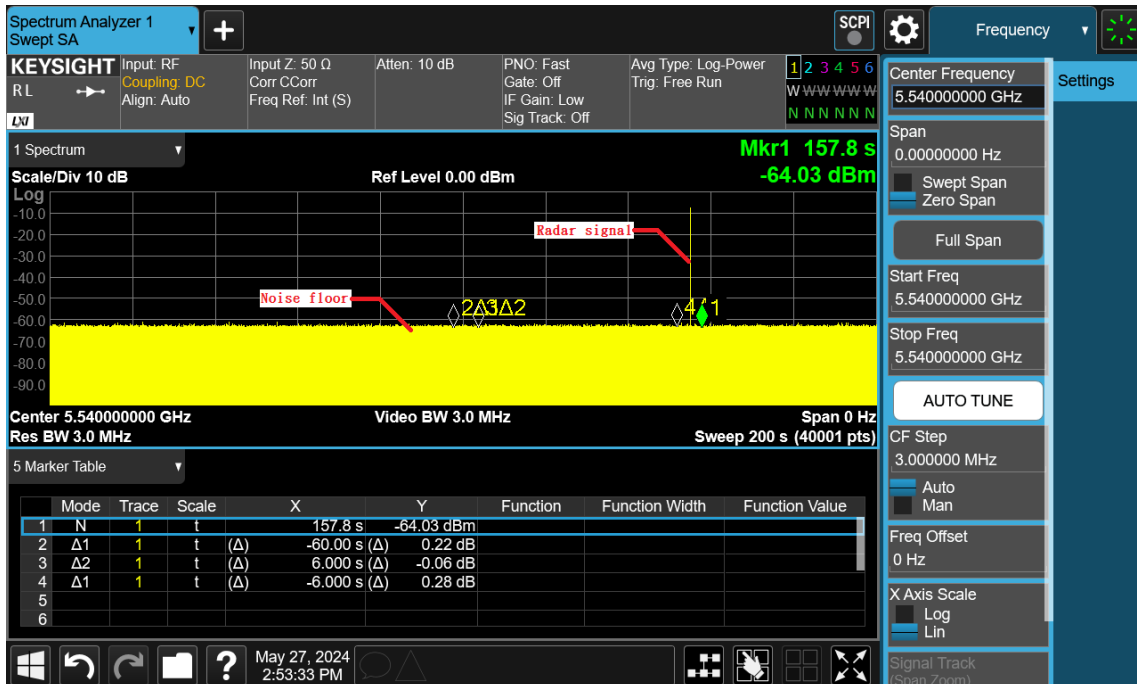

Test Mode UNII-2C, Nominal Bandwidth / Channel: 40 MHz / 5550 MHz

Initial Channel Availability Check Time



Radar Burst at the Beginning of the Channel Availability Check Time



Radar Burst at the End of the Channel Availability Check Time

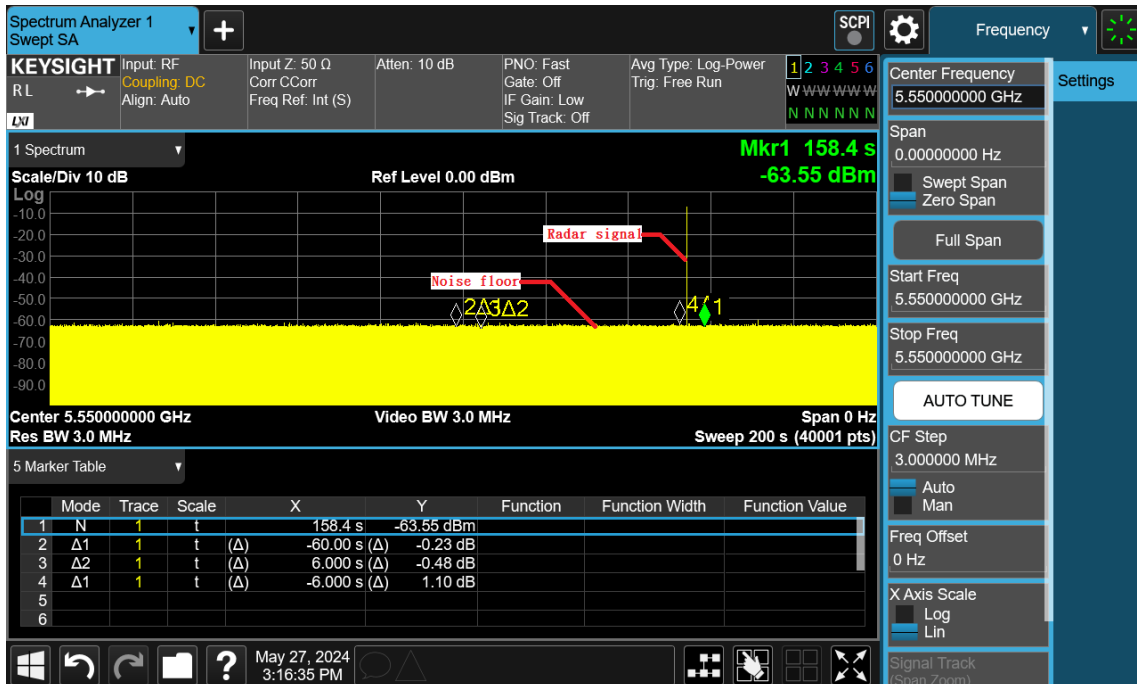

Test Mode UNII-2C, Nominal Bandwidth / Channel: 160 MHz / 5570 MHz

Initial Channel Availability Check Time

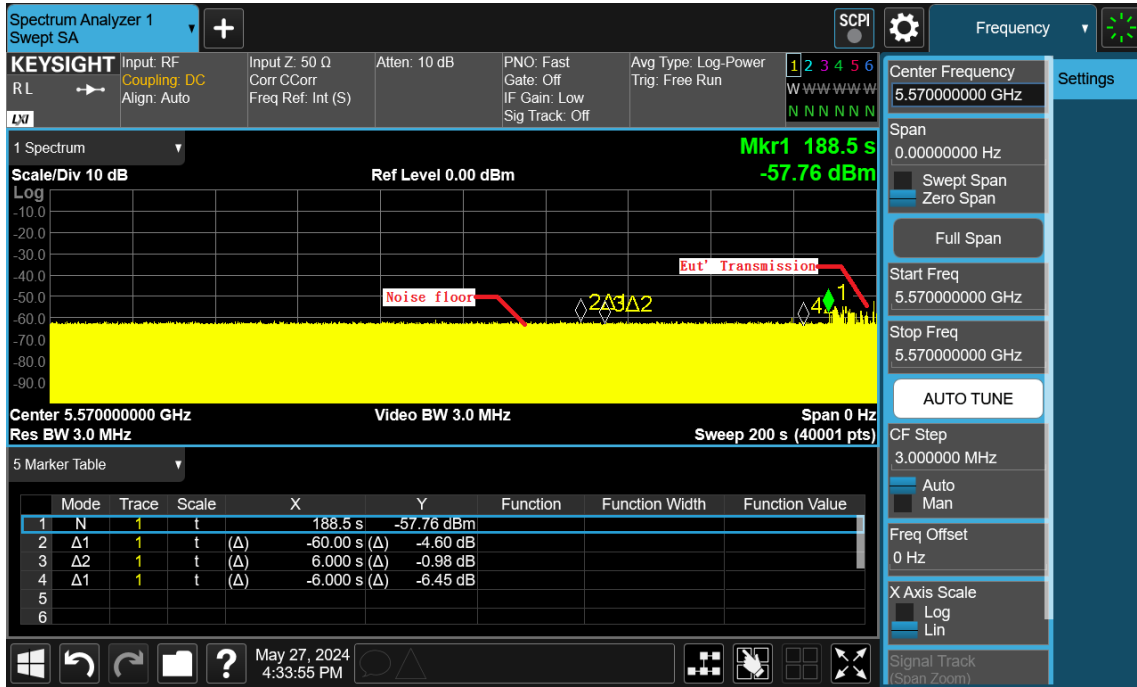

Radar Burst at the Beginning of the Channel Availability Check Time

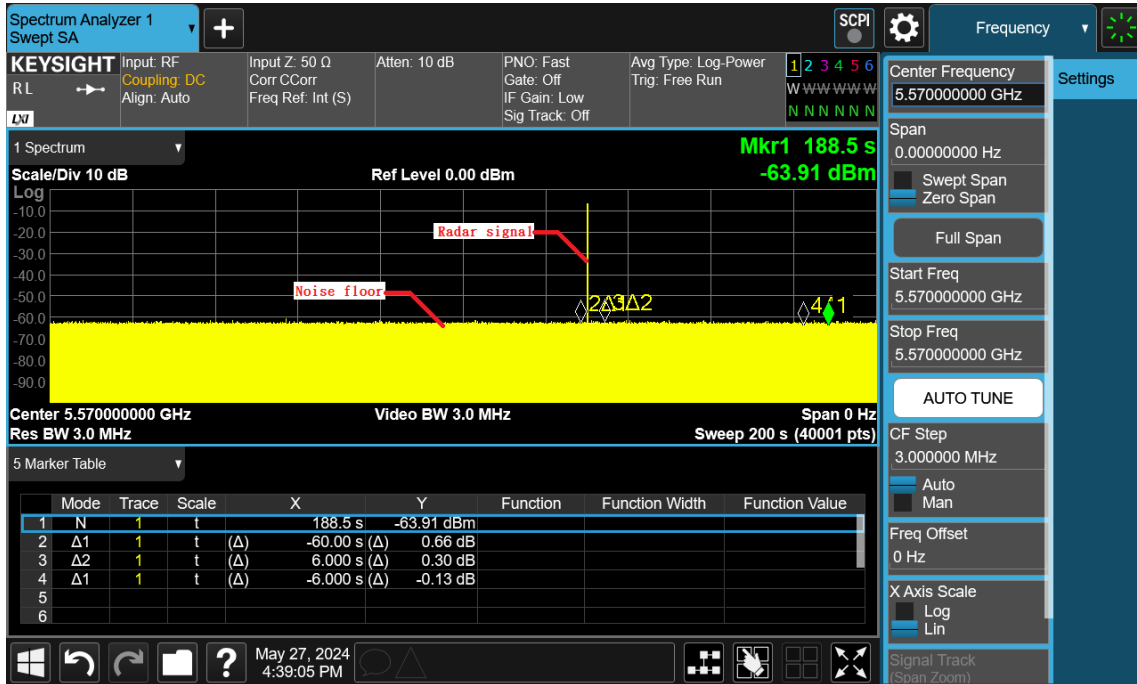

Radar Burst at the End of the Channel Availability Check Time

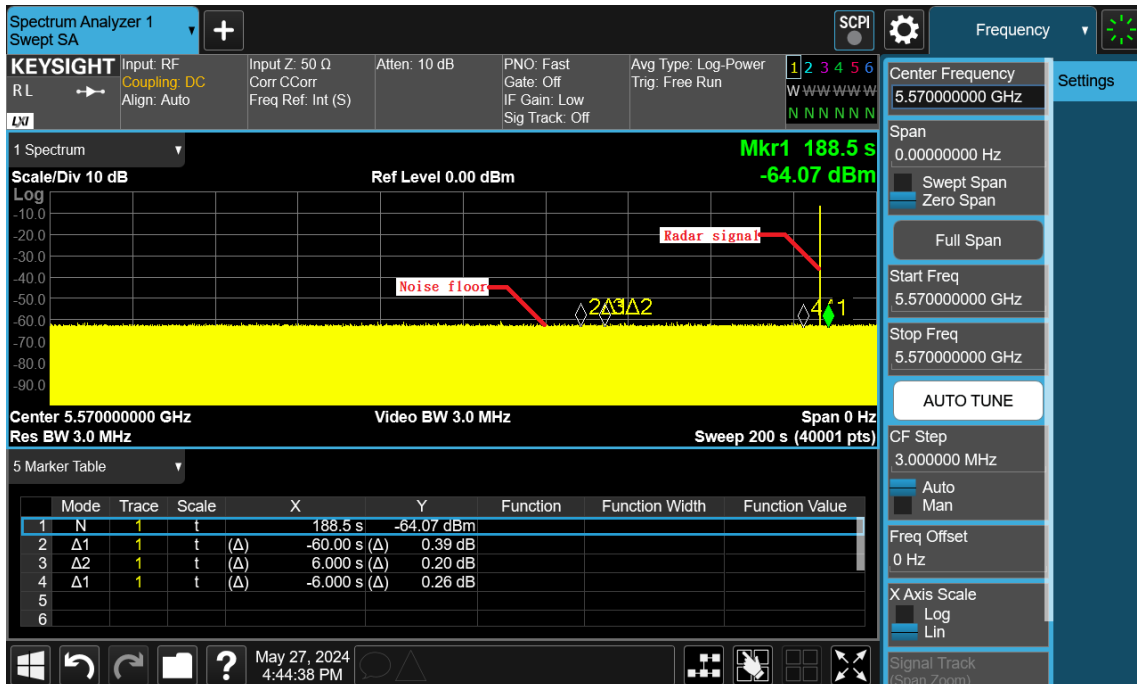

8.5 CHANNEL MOVE TIME AND CHANNEL CLOSING TRANSMISSION TIME

Test Mode | UNII-2C, Nominal Bandwidth / Channel: 20 MHz / 5540 MHz

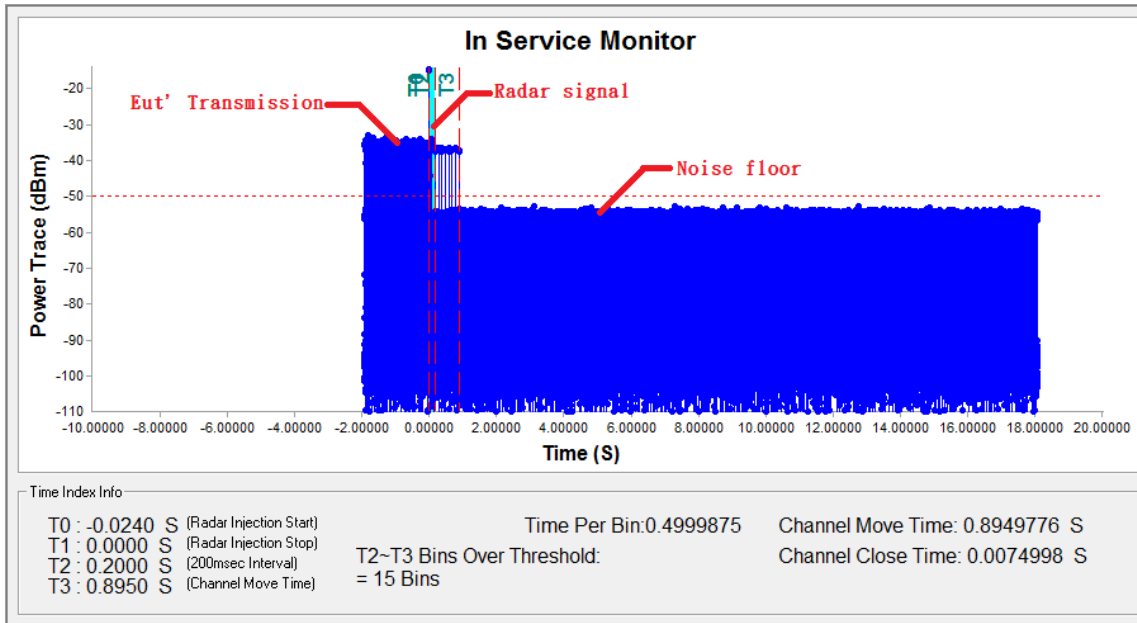

Note: T0 denotes the radar injection start.
 T1 denotes the radar injection stop.
 T2 denotes the data transmission time of 200ms from T1.
 T3 denotes the end of Channel Move Time.



Note: An expanded plot for the device vacates the channel in the required 500ms

Test Mode UNII-2C, Nominal Bandwidth / Channel: 40 MHz / 5550 MHz

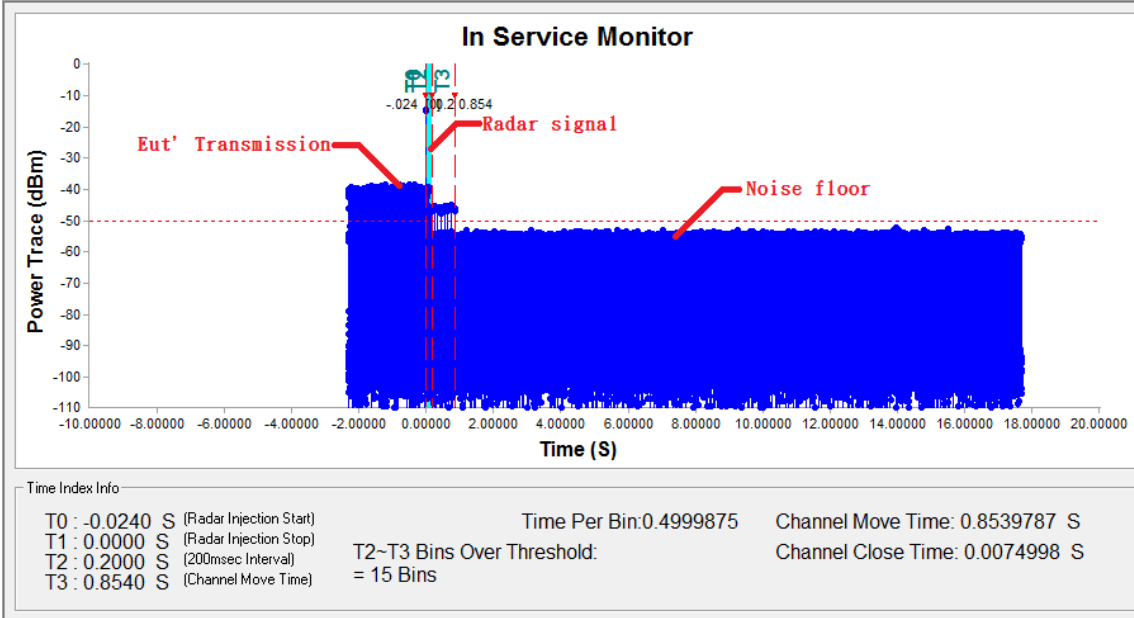

Note: T0 denotes the radar injection start.
 T1 denotes the radar injection stop.
 T2 denotes the data transmission time of 200ms from T1.
 T3 denotes the end of Channel Move Time.



Note: An expanded plot for the device vacates the channel in the required 500ms

Test Mode UNII-2C, Nominal Bandwidth / Channel: 160 MHz / 5570 MHz

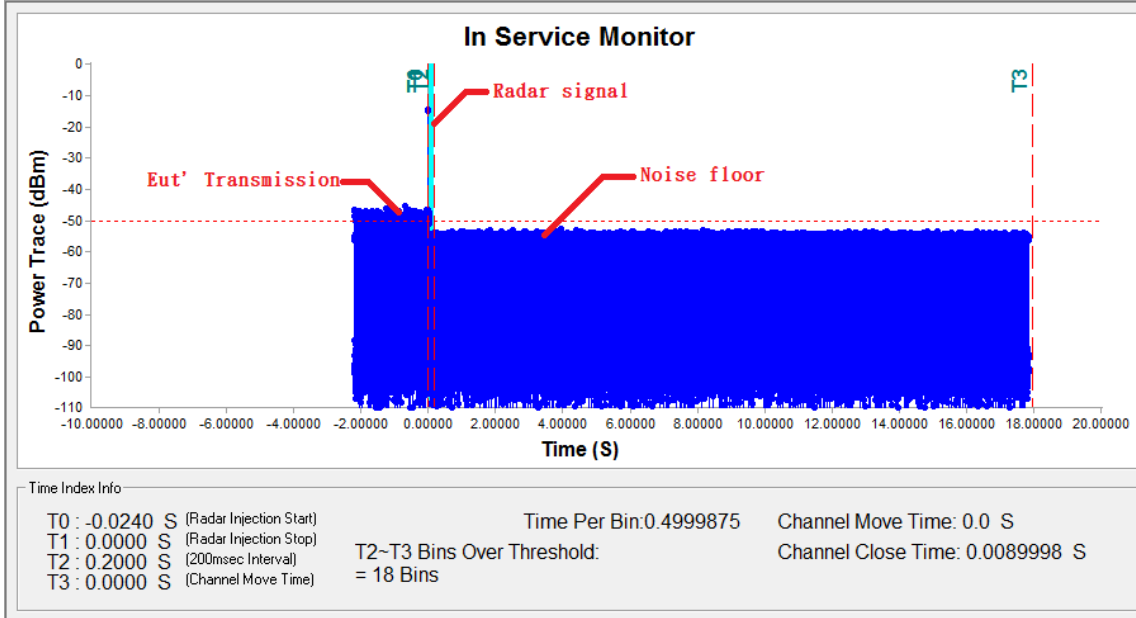

Note: T0 denotes the radar injection start.
 T1 denotes the radar injection stop.
 T2 denotes the data transmission time of 200ms from T1.
 T3 denotes the end of Channel Move Time.



Note: An expanded plot for the device vacates the channel in the required 500ms

Bandwidth	20 MHz	
Item	Measured Value(s)	Limit(s)
Channel Move Time	0.8949776	10
Channel Close Time	0.0074998	200 milliseconds + an aggregate of 60 milliseconds over remaining 10 second period

Bandwidth	40 MHz	
Item	Measured Value(s)	Limit(s)
Channel Move Time	0.8539787	10
Channel Close Time	0.0074998	200 milliseconds + an aggregate of 60 milliseconds over remaining 10 second period

Bandwidth	160 MHz	
Item	Measured Value(s)	Limit(s)
Channel Move Time	0.0	10
Channel Close Time	0.0089998	200 milliseconds + an aggregate of 60 milliseconds over remaining 10 second period

8.6 PROBABILITY OF SUCCEED

Test Mode	UNII-2C, Nominal Bandwidth / Channel: 20 MHz / 5540 MHz
-----------	---

Short Pulse Radar Test Waveforms

Radar signal	Pass times	Fail times	Probability	Minimum Percentage of Successful Detection
Type 1	30	0	100%	60%
Type 2	30	0	100%	60%
Type 3	30	0	100%	60%
Type 4	30	0	100%	60%
Aggregate (Radar Types 1-4)	120	0	100%	80%

Long Pulse Radar Test Waveform

Radar signal	Pass times	Fail times	Probability	Minimum Percentage of Successful Detection
Type 5	30	0	100%	80%

Frequency Hopping Radar Test Waveform

Radar signal	Pass times	Fail times	Probability	Minimum Percentage of Successful Detection
Type 6	30	0	100%	70%

Test Mode	UNII-2C, Nominal Bandwidth / Channel: 40 MHz / 5550 MHz
-----------	---

Short Pulse Radar Test Waveforms

Radar signal	Pass times	Fail times	Probability	Minimum Percentage of Successful Detection
Type 1	30	0	100%	60%
Type 2	30	0	100%	60%
Type 3	29	1	97%	60%
Type 4	28	2	93%	60%
Aggregate (Radar Types 1-4)	117	3	98%	80%

Long Pulse Radar Test Waveform

Radar signal	Pass times	Fail times	Probability	Minimum Percentage of Successful Detection
Type 5	30	0	100%	80%

Frequency Hopping Radar Test Waveform

Radar signal	Pass times	Fail times	Probability	Minimum Percentage of Successful Detection
Type 6	30	0	100%	70%

Test Mode	UNII-2C, Nominal Bandwidth / Channel: 160 MHz / 5570 MHz
-----------	--

Short Pulse Radar Test Waveforms

Radar signal	Pass times	Fail times	Probability	Minimum Percentage of Successful Detection
Type 1	30	0	100%	60%
Type 2	30	0	100%	60%
Type 3	30	0	100%	60%
Type 4	30	0	100%	60%
Aggregate (Radar Types 1-4)	120	0	100%	80%

Long Pulse Radar Test Waveform

Radar signal	Pass times	Fail times	Probability	Minimum Percentage of Successful Detection
Type 5	30	0	100%	80%

Frequency Hopping Radar Test Waveform

Radar signal	Pass times	Fail times	Probability	Minimum Percentage of Successful Detection
Type 6	30	0	100%	70%

8.7 NON-OCCUPANCY PERIOD

During the 30 minutes observation time, UUT did not make any transmissions on a channel after a radar signal was detected on that channel by either the Channel Availability Check or the In-Service Monitoring.

Test Mode: UNII-2C, Nominal Bandwidth / Channel: 20 MHz / 5540 MHz

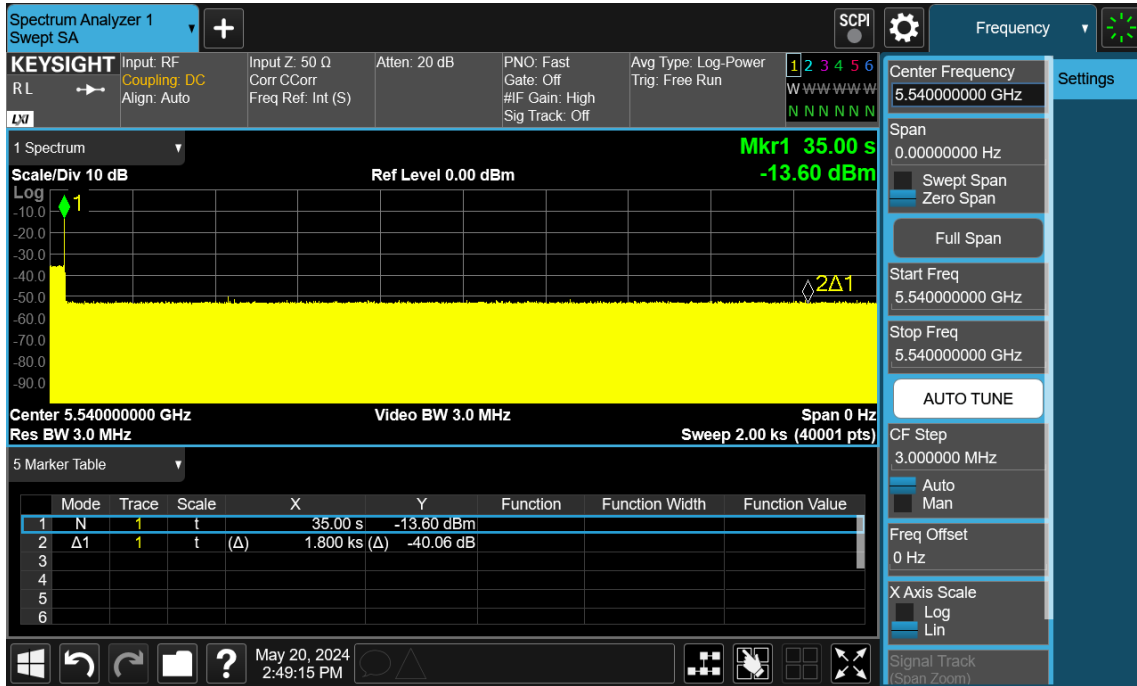

Test Mode: UNII-2C, Nominal Bandwidth / Channel: 40 MHz / 5550 MHz



Test Mode: UNII-2C, Nominal Bandwidth / Channel: 160 MHz / 5570 MHz



8.8 U-NII DETECTION BANDWIDTH

Test Mode	UNII-2C, Nominal Bandwidth / Channel: 20 MHz / 5540 MHz
-----------	---

Detection Bandwidth test transmission	20M										
EUT FREQUENCY	5540M										
EUT power bandwidth	17.007MHz										
Detection Bandwidth limit(100%of EUT 99% Power bandwidth)	17.007MHz										
Detection Bandwidth(5549(FH)-5531(FL))	5550(FH)	5530(FL)	21								
Test Result	PASS										
	DFS Detection Trials (1=Detection, 0= No Detection)										
Radar Freq (MHz)	1	2	3	4	5	6	7	8	9	10	Detection Rate (%)
5530(FL)	1	1	1	1	1	1	1	1	1	1	100
5535	1	1	1	1	1	1	1	1	1	1	100
5540	1	1	1	1	1	1	1	1	1	1	100
5545	1	1	1	1	1	1	1	1	1	1	100
5550(FH)	1	1	1	1	1	1	1	1	1	1	100

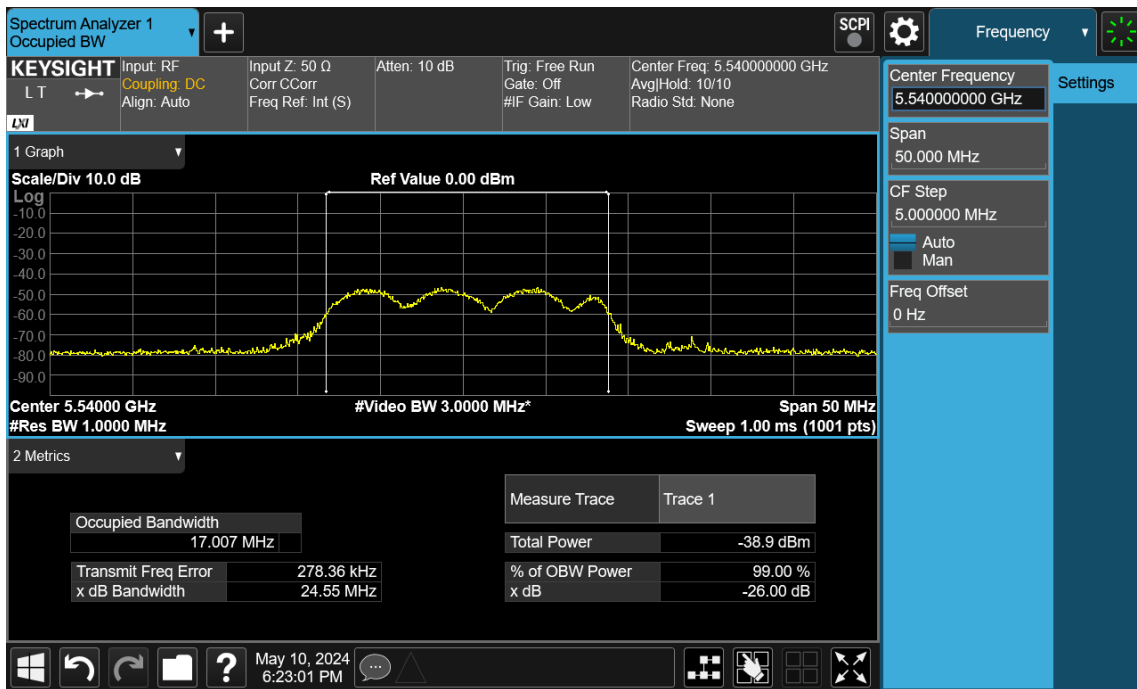

Test Mode UNII-2C, Nominal Bandwidth / Channel: 40 MHz / 5550 MHz

Detection Bandwidth test transmission	40M										
EUT FREQUENCY	5550M										
EUT power bandwidth	37.138MHz										
Detection Bandwidth limit(100%of EUT 99% Power bandwidth)	37.138MHz										
Detection Bandwidth(5570(FH)-5530(FL))	41										
Test Result	PASS										
	DFS Detection Trials (1=Detection, 0= No Detection)										
Radar Freq (MHz)	1	2	3	4	5	6	7	8	9	10	Detection Rate (%)
5530(FL)	1	1	1	1	1	1	1	1	1	1	100
5535	1	1	1	1	1	1	1	1	1	1	100
5540	1	1	1	1	1	1	1	1	1	1	100
5545	1	1	1	1	1	1	1	1	1	1	100
5550	1	1	1	1	1	1	1	1	1	1	100
5555	1	1	1	1	1	1	1	1	1	1	100
5560	1	1	1	1	1	1	1	1	1	1	100
5565	1	1	1	1	1	1	1	1	1	1	100
5570(FH)	1	1	1	1	1	1	1	1	1	1	100

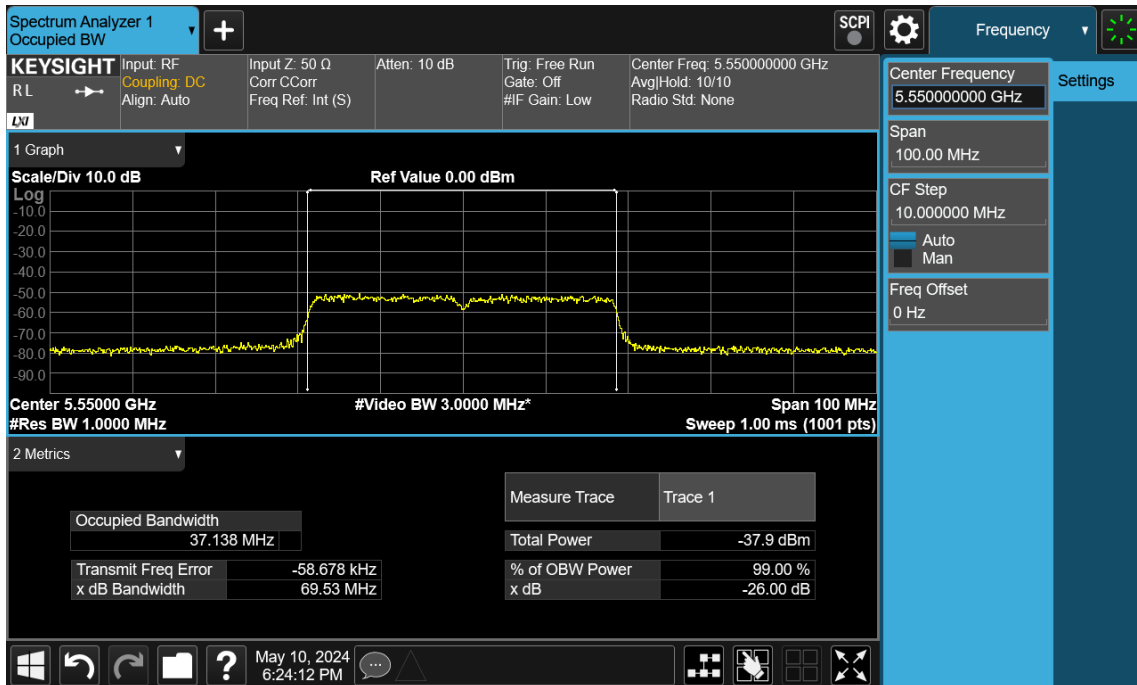

Test Mode	UNII-2C, Nominal Bandwidth / Channel: 160 MHz / 5570 MHz
-----------	--

Detection Bandwidth test transmission	160M										
EUT FREQUENCY	5570M										
EUT power bandwidth	156.25MHz										
Detection Bandwidth limit(100%of EUT 99% Power bandwidth)	156.25MHz										
Detection Bandwidth(5650(FH)-5490(FL))	161										
Test Result	PASS										
	DFS Detection Trials (1=Detection, 0= No Detection)										
Radar Freq (MHz)	1	2	3	4	5	6	7	8	9	10	Detection Rate (%)
5490(FL)	1	1	1	1	1	1	1	1	1	1	100%
5495	1	1	1	1	1	1	1	1	1	1	100%
5500	1	1	1	1	1	1	1	1	1	1	100%
5505	1	1	1	1	1	1	1	1	1	1	100%
5510	1	1	1	1	1	1	1	1	1	1	100%
5515	1	1	1	1	1	1	1	1	1	1	100%
5520	1	1	1	1	1	1	1	1	1	1	100%
5525	1	1	1	1	1	1	1	1	1	1	100%
5530	1	1	1	1	1	1	1	1	1	1	100%
5535	1	1	1	1	1	1	1	1	1	1	100%
5540	1	1	1	1	1	1	1	1	1	1	100%
5545	1	1	1	1	1	1	1	1	1	1	100%
5550	1	1	1	1	1	1	1	1	1	1	100%
5555	1	1	1	1	1	1	1	1	1	1	100%
5560	1	1	1	1	1	1	1	1	1	1	100%
5565	1	1	1	1	1	1	1	1	1	1	100%
5570	1	1	1	1	1	1	1	1	1	1	100%
5575	1	1	1	1	1	1	1	1	1	1	100%
5580	1	1	1	1	1	1	1	1	1	1	100%
5585	1	1	1	1	1	1	1	1	1	1	100%
5590	1	1	1	1	1	1	1	1	1	1	100%
5595	1	1	1	1	1	1	1	1	1	1	100%
5600	1	1	1	1	1	1	1	1	1	1	100%
5605	1	1	1	1	1	1	1	1	1	1	100%
5610	1	1	1	1	1	1	1	1	1	1	100%
5615	1	1	1	1	1	1	1	1	1	1	100%
5620	1	1	1	1	1	1	1	1	1	1	100%
5625	1	1	1	1	1	1	1	1	1	1	100%
5630	1	1	1	1	1	1	1	1	1	1	100%
5635	1	1	1	1	1	1	1	1	1	1	100%
5640	1	1	1	1	1	1	1	1	1	1	100%
5645	1	1	1	1	1	1	1	1	1	1	100%
5650(FH)	1	1	1	1	1	1	1	1	1	1	100%

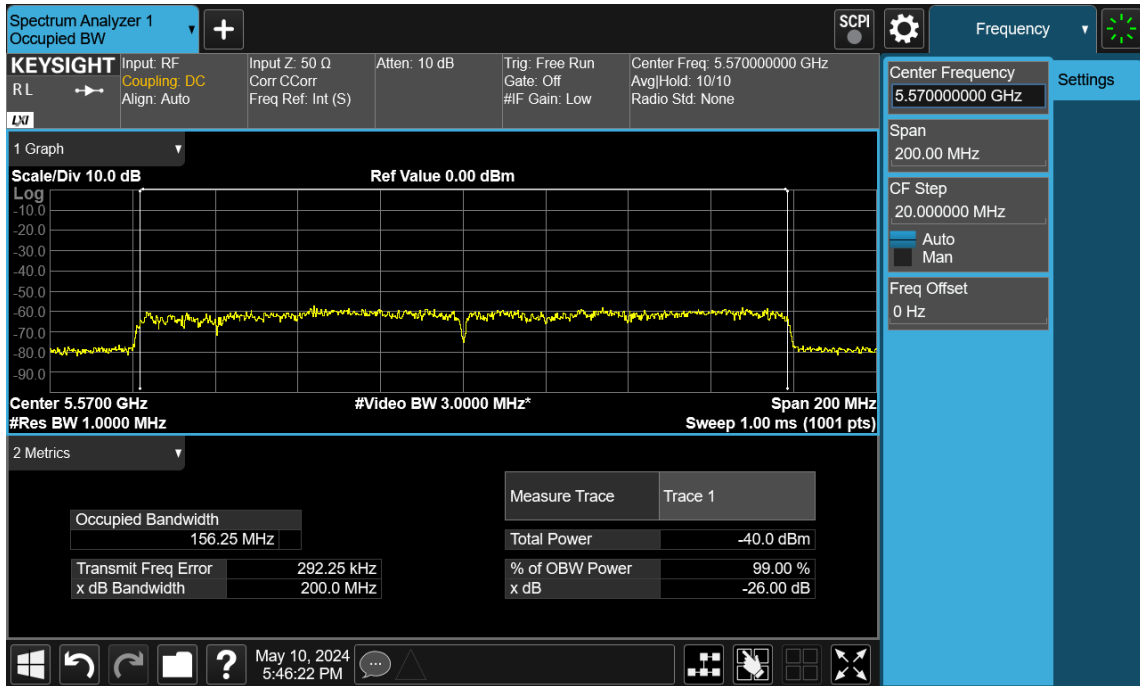

End of Test Report