



RF MEASUREMENT REPORT

FCC ID : 2BCGWEAP653UR
APPLICANT : TP-LINK CORPORATION PTE. LTD.
Application Type : Certification
Product : AX3000 Ceiling Mount Wi-Fi 6 Access Point
Model No. : EAP653 UR
Brand Name : tp-link
FCC Classification : Digital Transmission System (DTS)
FCC Rule Part(s) : Part 15.247
Test Procedure(s) : ANSI C63.10-2013
Received Date : February 5, 2024
Test Date : February 20, 2024~March 6, 2024
Tested By : Owen Tsai
(Owen Tsai)
Reviewed By : Paddy Chen
(Paddy Chen)
Approved By : Chenz Ker
(Chenz Ker)



The test results only relate to the tested sample.

This equipment has been shown to be capable of compliance with the applicable technical standards as indicated in the measurement report and was tested in accordance with the measurement procedures specified in ANSI C63.10. Test results reported herein relate only to the item(s) tested.

The test report shall not be reproduced except in full without the written approval of MRT Technology (Taiwan) Co., Ltd.

Revision History

Report No.	Version	Description	Issue Date	Note
2402TW0104-U2	1.0	Original Report	2024-04-11	Valid

CONTENTS

Description	Page
§2.1033 General Information.....	5
1. INTRODUCTION	6
1.1. Scope.....	6
1.2. MRT Test Location.....	6
2. PRODUCT INFORMATION.....	7
2.1. Equipment Description.....	7
2.2. Product Specification Subjective to this Standard.....	7
2.3. Test Mode.....	7
2.4. Operation Frequency / Channel List.....	8
2.5. Test Configuration.....	9
2.6. Test System Details.....	9
2.7. Test Software.....	10
2.8. Applied Standards.....	10
2.9. Duty Cycle.....	10
2.10. EMI Suppression Device(s)/Modifications.....	11
2.11. Labeling Requirements.....	11
3. DESCRIPTION of TEST.....	12
3.1. Evaluation Procedure.....	12
3.2. AC Line Conducted Emissions.....	12
3.3. Radiated Emissions.....	13
4. ANTENNA REQUIREMENTS	14
5. TEST EQUIPMENT CALIBRATION DATE	15
6. MEASUREMENT UNCERTAINTY	16
7. TEST RESULT	17
7.1. Summary.....	17
7.2. 6dB Bandwidth Measurement.....	18
7.2.1. Test Limit.....	18
7.2.2. Test Procedure used.....	18
7.2.3. Test Setting.....	18
7.2.4. Test Setup.....	18
7.2.5. Test Result.....	19
7.3. Output Power Measurement.....	20
7.3.1. Test Limit.....	20
7.3.2. Test Procedure Used.....	20
7.3.3. Test Setting.....	20
7.3.4. Test Setup.....	21
7.3.5. Test Result of Output Power.....	22
7.4. Power Spectral Density Measurement.....	23
7.4.1. Test Limit.....	23
7.4.2. Test Procedure Used.....	23

7.4.3.	Test Setting	23
7.4.4.	Test Setup	24
7.4.5.	Test Result	25
7.5.	Out-of-Band Spurious Emissions Emissions Measurement.....	26
7.5.1.	Test Limit	26
7.5.2.	Test Procedure Used.....	26
7.5.3.	Test Settintg	26
7.5.4.	Test Setup	26
7.5.5.	Test Result	27
7.6.	Radiated Spurious Emission Measurement.....	29
7.6.1.	Test Limit	29
7.6.2.	Test Procedure Used.....	29
7.6.3.	Test Setting	29
7.6.4.	Test Setup	31
7.6.5.	Test Result	33
7.7.	Radiated Restricted Band Edge Measurement.....	43
7.7.1.	Test Limit	43
7.7.2.	Test Procedure Used.....	43
7.7.3.	Test Setting	43
7.7.4.	Test Setup	45
7.7.5.	Test Result	46
7.8.	AC Conducted Emissions Measurement	54
7.8.1.	Test Limit	54
7.8.2.	Test Setup	54
7.8.3.	Test Result	55
8.	CONCLUSION	59
	Appendix A : Test Photograph.....	60
	Appendix B : External Photograph	60
	Appendix C : Internal Photograph.....	60

§2.1033 General Information

Applicant	TP-LINK CORPORATION PTE. LTD.
Applicant Address	7 Temasek Boulevard #29-03 Suntec Tower One, Singapore 038987
Manufacturer	TP-LINK CORPORATION PTE. LTD.
Manufacturer Address	7 Temasek Boulevard #29-03 Suntec Tower One, Singapore 038987
Test Site	MRT Technology (Taiwan) Co., Ltd
Test Site Address	No. 38, Fuxing Second Rd., Guishan Dist., Taoyuan City 333, Taiwan (R.O.C)
MRT FCC Registration No.	291082
FCC Rule Part(s)	Part 15.247

Test Facility / Accreditations

1. MRT facility is a FCC registered (Reg. No. 291082) test facility with the site description report on file and is designated by the FCC as an Accredited Test Firm.
2. MRT facility is an IC registered (MRT Reg. No. 21723) test laboratory with the site description on file at Industry Canada.
3. MRT Lab is accredited to ISO 17025 by the Taiwan Accreditation Foundation (TAF Cert. No. 3261) in EMC, Telecommunications and Radio testing for FCC (Designation Number: TW3261), Industry Canada, EU and TELEC Rules.

1. INTRODUCTION

1.1. Scope

Measurement and determination of electromagnetic emissions (EMC) of radio frequency devices including intentional and/or unintentional radiators for compliance with the technical rules and regulations of the Federal Communications Commission and the Industry Canada Certification and Engineering Bureau.

1.2. MRT Test Location

The map below shows the location of the MRT LABORATORY, its proximity to the Taoyuan City. These measurement tests were conducted at the MRT Technology (Taiwan) Co., Ltd. Facility located at No.38, Fuxing 2nd Rd., Guishan Dist., Taoyuan City 33377, Taiwan (R.O.C).

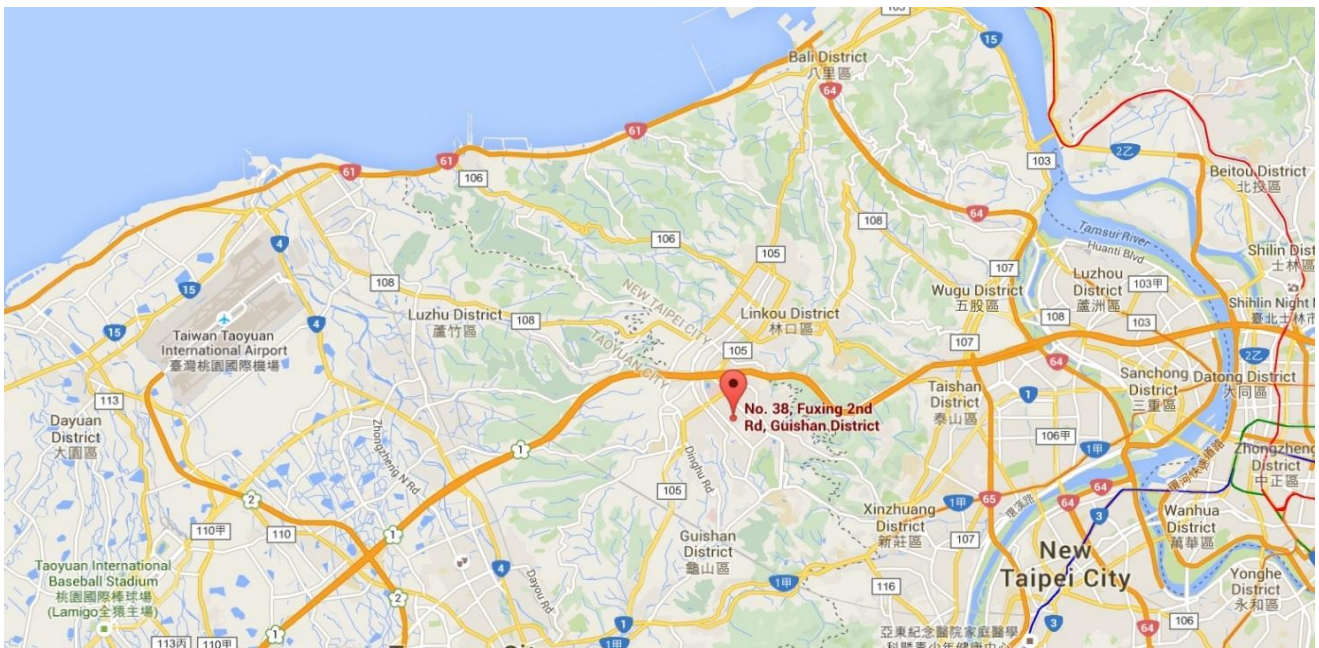

2. PRODUCT INFORMATION

2.1. Equipment Description

Product Name	AX3000 Ceiling Mount Wi-Fi 6 Access Point
Model No.	EAP653 UR
Brand Name	tp-link
Bluetooth Specification	Bluetooth Mode: V4.2 Single mode
Wi-Fi Specification:	802.11a/b/g/n/ac/ax
EUT Identification No.:	#1-1 (Conducted) #1-2 (Radiated)
Power Supply:	Power: 12V 1.5A 802.3at PoE: 42.5-57V 0.6A

2.2. Product Specification Subjective to this Standard

Operating Frequency	2402~2480MHz
Type of modulation	GFSK
Data Rate	1Mbps
Antenna Type	PIFA Antenna
Antenna Gain	3.0dBi

2.3. Test Mode

Test Mode	Mode 1: Transmit - LE (GFSK)
-----------	------------------------------

Note: Regarding to the operation frequency, the lowest, middle and highest frequency are selected to perform the test.

2.4. Operation Frequency / Channel List

Channel	Frequency	Channel	Frequency	Channel	Frequency
00	2402 MHz	01	2404 MHz	02	2406 MHz
03	2408 MHz	04	2410 MHz	05	2412 MHz
06	2414 MHz	07	2416 MHz	08	2418 MHz
09	2420 MHz	10	2422 MHz	11	2424 MHz
12	2426 MHz	13	2428 MHz	14	2430 MHz
15	2432 MHz	16	2434 MHz	17	2436 MHz
18	2438 MHz	19	2440 MHz	20	2442 MHz
21	2444 MHz	22	2446 MHz	23	2448 MHz
24	2450 MHz	25	2452 MHz	26	2454 MHz
27	2456 MHz	28	2458 MHz	29	2460 MHz
30	2462 MHz	31	2464 MHz	32	2466 MHz
33	2468 MHz	34	2470 MHz	35	2472 MHz
36	2474 MHz	37	2476 MHz	38	2478 MHz
39	2480 MHz	N/A	N/A	N/A	N/A

2.5. Test Configuration

This device was tested per the guidance of ANSI C63.10-2013. ANSI C63.10-2013 was used to reference the appropriate EUT setup for radiated spurious emissions testing and AC line conducted testing.

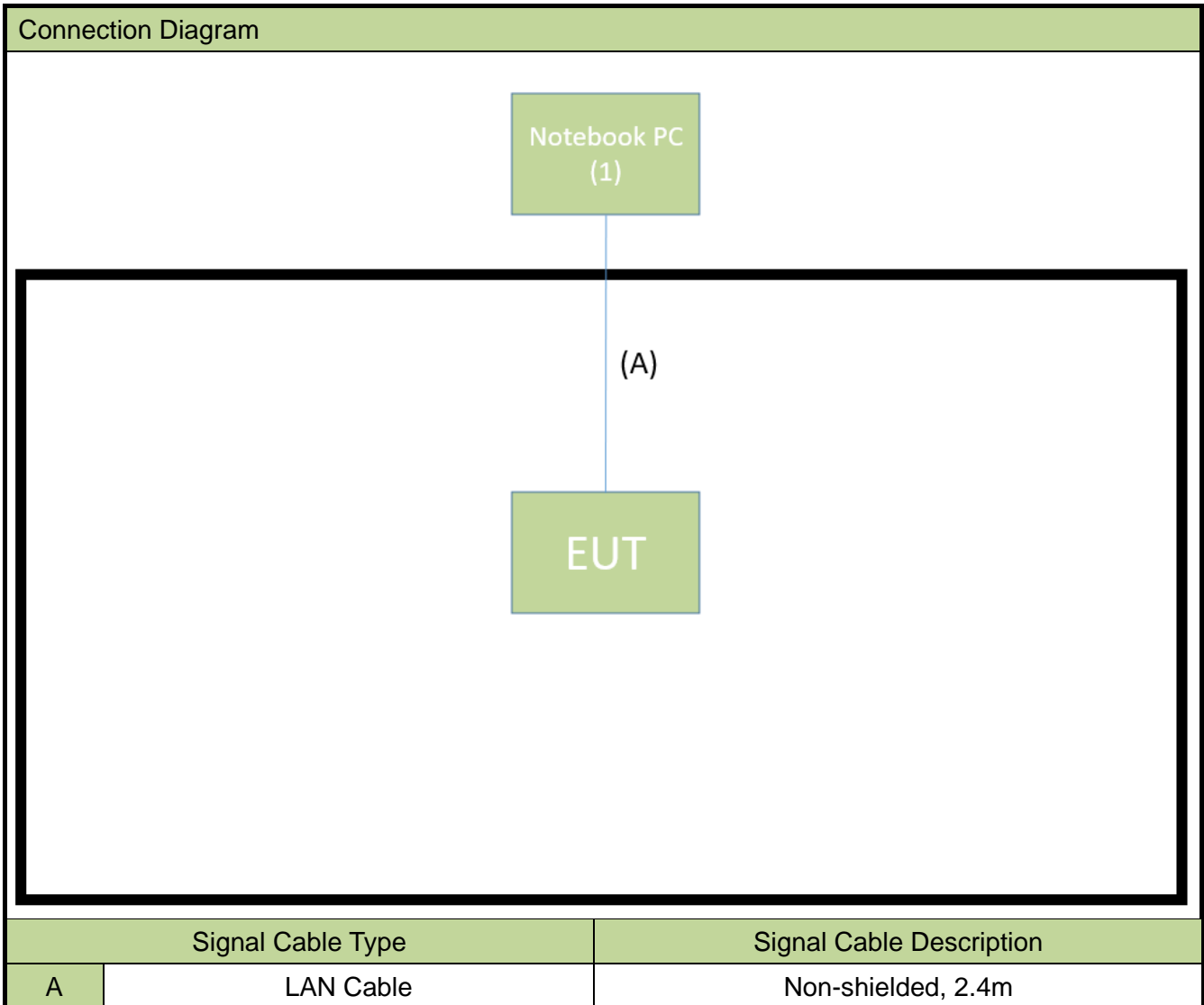

2.6. Test System Details

The types for all equipments, plus descriptions of all cables used in the tested system (including inserted cards) are:

No.	Product	Brand	Model No.	Serial No.	Power Cord
1	Notebook PC	Lenovo	V14 G3 ABA	N/A	Non-shielded, 0.8m

2.7. Test Software

The test utility software used during testing was “SecureCRT v7.1.1”.

2.8. Applied Standards

According to the specifications of the manufacturer, the EUT must comply with the requirements of the following standards:

- FCC Part 15.247
- KDB 558074 D01v05r02
- ANSI C63.10-2013

2.9. Duty Cycle

Test Mode	Duty Cycle
BLE-1Mbps	19%

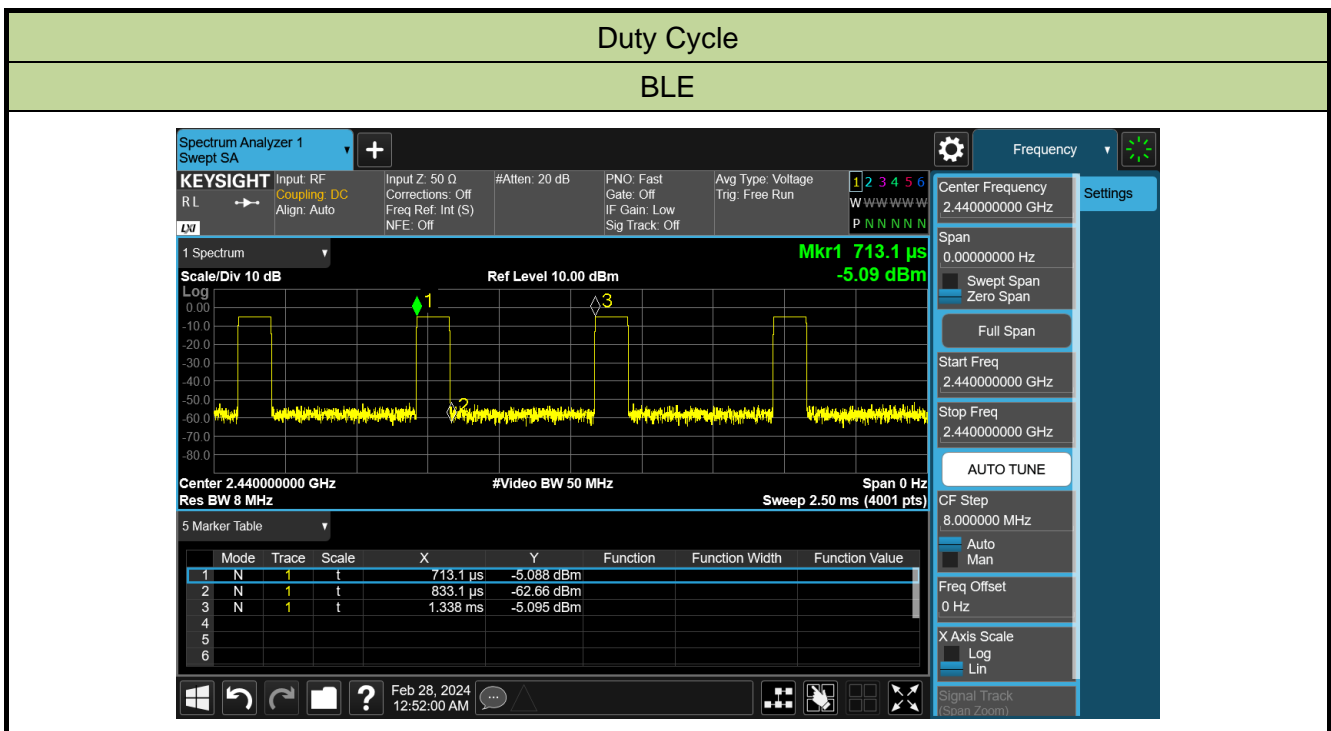

2.10. EMI Suppression Device(s)/Modifications

No EMI suppression device(s) were added and/or no modifications were made during testing.

2.11. Labeling Requirements

Per 2.1074 & 15.19; Docket 95-19

The label shall be permanently affixed at a conspicuous location on the device; instruction manual or pamphlet supplied to the user and be readily visible to the purchaser at the time of purchase.

However, when the device is so small wherein placement of the label with specified statement is not practical, only the FCC ID must be displayed on the device per Section 15.19(a)(5). Please see attachment for FCC ID label and label location.

3. DESCRIPTION of TEST

3.1. Evaluation Procedure

The measurement procedures described in the American National Standard for Testing Unlicensed Wireless Devices (ANSI C63.10-2013), and the guidance was used in the measurement of the **AX3000 Ceiling Mount Wi-Fi 6 Access Point**.

Deviation from measurement procedure.....None

3.2. AC Line Conducted Emissions

The line-conducted facility is located inside an 9'x4'x3' shielded enclosure. A 1m x 2m wooden table 80cm high is placed 40cm away from the vertical wall and 80cm away from the sidewall of the shielded room. Two 10kHz-30MHz, 50Ω/50uH Line-Impedance Stabilization Networks (LISNs) are bonded to the shielded room floor. Power to the LISNs is filtered by external high-current high-insertion loss power line filters. These filters attenuate ambient signal noise from entering the measurement lines. These filters are also bonded to the shielded enclosure.

The EUT is powered from one LISN and the support equipment is powered from the second LISN. All interconnecting cables more than 1 meter were shortened to a 1 meter length by non-inductive bundling (serpentine fashion) and draped over the back edge of the test table. All cables were at least 40cm above the horizontal reference ground-plane. Power cables for support equipment were routed down to the second LISN while ensuring that that cables were not draped over the second LISN.

Sufficient time for the EUT, support equipment, and test equipment was allowed in order for them to warm up to their normal operating condition. The RF output of the LISN was connected to the receiver and exploratory measurements were made to determine the frequencies producing the maximum emission from the EUT. The receiver was scanned from 150kHz to 30MHz. The detector function was set to peak mode for exploratory measurements while the bandwidth of the analyzer was set to 9kHz. The EUT, support equipment, and interconnecting cables were arranged and manipulated to maximize each emission. Each emission was also maximized by varying: power lines, the mode of operation or data exchange speed, or support equipment which determined the worst-case emission. Once the worst case emissions have been identified, the one EUT cable configuration/arrangement and mode of operation that produced these emissions are used for final measurements on the same test site. The analyzer is set to CISPR quasi-peak and average detectors with a 9kHz resolution bandwidth for final measurements.

An extension cord was used to connect to a single LISN which powered by EUT. The extension cord was calibrated with LISN, the impedance and insertion loss are compliance with the requirements as stated in ANSI C63.10-2013.

Line conducted emissions test results are shown in Section 7.8.

3.3. Radiated Emissions

The radiated test facilities consisted of an indoor 3 meter semi-anechoic chamber used for final measurements and exploratory measurements, when necessary. The measurement area is contained within the semi-anechoic chamber which is shielded from any ambient interference. For measurements above 1GHz absorbers are arranged on the floor between the turn table and the antenna mast in such a way so as to maximize the reduction of reflections. For measurements below 1GHz, the absorbers are removed. A MF Model 210SS turntable is used for radiated measurement. It is a continuously rotatable, remote controlled, metallic turntable and 2 meters (6.56 ft.) in diameter. The turn table is flush with the raised floor of the chamber in order to maintain its function as a ground plane. An 80cm high PVC support structure is placed on top of the turntable.

For all measurements, the spectrum was scanned through all EUT azimuths and from 1 to 4 meter receive antenna height using a broadband antenna from 30MHz up to the upper frequency shown in 15.33(b)(1) depending on the highest frequency generated or used in the device or on which the device operates or tunes. For frequencies above 1GHz, linearly polarized double ridge horn antennas were used. For frequencies below 30MHz, a calibrated loop antenna was used. When exploratory measurements were necessary, they were performed at 1 meter test distance inside the semi-anechoic chamber using broadband antennas, broadband amplifiers, and spectrum analyzers to determine the frequencies and modes producing the maximum emissions. Sufficient time for the EUT, support equipment, and test equipment was allowed in order for them to warm up to their normal operating condition. The test set-up for frequencies below 1GHz was placed on top of the 0.8 meter high, 1 x 1.5 meter table; and test set-up for frequencies 1-40GHz was placed on top of the 1.5 meter high, 1 x 1.5 meter table. The EUT, support equipment, and interconnecting cables were arranged and manipulated to maximize each emission. Appropriate precaution was taken to ensure that all emissions from the EUT were maximized and investigated. The system configuration, clock speed, mode of operation or video resolution, if applicable, turntable azimuth, and receive antenna height was noted for each frequency found.

Final measurements were made in the semi-anechoic chamber using calibrated, linearly polarized broadband and horn antennas. The test setup was configured to the setup that produced the worst case emissions. The spectrum analyzer was set to investigate all frequencies required for testing to compare the highest radiated disturbances with respect to the specified limits. The turntable containing the EUT was rotated through 360 degrees and the height of the receive antenna was varied 1 to 4 meters and stopped at the azimuth and height producing the maximum emission. Each emission was maximized by changing the orientation of the EUT through three orthogonal planes and changing the polarity of the receive antenna, which produced the worst-case emissions. According to 3dB Beam-Width of horn antenna, the horn antenna should be always directed to the EUT when rising height.

Radiated emissions test results are shown in Section 7.6 & 7.7 .

4. ANTENNA REQUIREMENTS

Excerpt from §15.203 of the FCC Rules/Regulations:

“An intentional radiator antenna shall be designed to ensure that no antenna other than that furnished by the responsible party can be used with the device. The use of a permanently attached antenna or of an antenna that uses a unique coupling to the intentional radiator shall be considered sufficient to comply with the provisions of this section.”

- The antenna of the **AX3000 Ceiling Mount Wi-Fi 6 Access Point**, is permanently attached.
- There are no provisions for connection to an external antenna.

Conclusion:

The EUT unit complies with the requirement of §15.203.

5. TEST EQUIPMENT CALIBRATION DATE

Conducted Emissions – SR2

Instrument	Manufacturer	Type No.	Asset No.	Cali. Interval	Cali. Due Date
Two-Line V-Network	R&S	ENV216	MRTTWA00020	1 year	2024/3/7
Cable	Rosnol	N1C50-RG400-B 1C50-500CM	MRTTWE00013	1 year	2024/4/17
EMI Test Receiver	R&S	ESR3	MRTTWA00009	1 year	2024/3/8

Radiated Emissions – AC2

Instrument	Manufacturer	Type No.	Asset No.	Cali. Interval	Cali. Due Date
Active Loop Antenna	SCHWARZBECK	FMZB 1519B	MRTTWA00002	1 year	2024/5/22
Broadband TRILOG Antenna	SCHWARZBECK	VULB 9162	MRTTWA00001	1 year	2024/10/31
Broadband Hornantenna	RFSPIN	DRH18-E	MRTTWA00087	1 year	2024/5/17
Broadband Preamplicifier	EMC Instruments corporation	EMC118A45SE	MRTTWA00088	1 year	2024/5/17
Breitband Hornantenna	SCHWARZBECK	BBHA 9170	MRTTWA00004	1 year	2024/3/20
Broadband Amplifier	SCHWARZBECK	BBV 9721	MRTTWA00006	1 year	2024/3/27
EMI Test Receiver	R&S	ESR3	MRTTWA00009	1 year	2024/3/8
Signal Analyzer	R&S	FSVA3044	MRTTWA00092	1 year	2024/6/29
Antenna Cable	HUBERSUHNER	SF106	MRTTWE00034	1 year	2024/6/26
Cable	HUBERSUHNER	EMC105-NM-NM -3000	MRTTWE00035	1 year	2024/6/26
Temperature/Humidity Meter	TFA	35.1078.10.IT	MRTTWA00032	1 year	2024/6/4

Conducted Test Equipment – SR6

Instrument	Manufacturer	Type No.	Asset No.	Cali. Interval	Cali. Due Date
EXA Signal Analyzer	KEYSIGHT	N9010A	MRTTWA00012	1 year	2024/10/17
EXA Signal Analyzer	KEYSIGHT	N9010B	MRTTWA00074	1 year	2024/7/19
USB Wideband Power Sensor	KEYSIGHT	U2021XA	MRTTWA00015	1 year	2024/3/16

Test Software

Software	Version	Function
e3	9.160520a	EMI Test Software
EMI	V3	EMI Test Software

6. MEASUREMENT UNCERTAINTY

Where relevant, the following test uncertainty levels have been estimated for tests performed on the EUT as specified in CISPR 16-4-2. This uncertainty represents an expanded uncertainty expressed at approximately the 95% confidence level using a coverage factor of $k = 2$.

Conducted Emission- Power Line
Measuring Uncertainty for a Level of Confidence of 95% ($U=2Uc(y)$): 0.15MHz~30MHz: $\pm 2.53\text{dB}$
Radiated Spurious Emission
Measuring Uncertainty for a Level of Confidence of 95% ($U=2Uc(y)$): 9kHz~30MHz: $\pm 3.92\text{dB}$ 30MHz~1GHz: $\pm 4.25\text{dB}$ 1GHz~18GHz: $\pm 4.40\text{dB}$ 18GHz~40GHz: $\pm 4.45\text{dB}$
Frequency Error
Measuring Uncertainty for a Level of Confidence of 95% ($U=2Uc(y)$): $\pm 78.4\text{Hz}$
Conducted Power
Measuring Uncertainty for a Level of Confidence of 95% ($U=2Uc(y)$): $\pm 0.84\text{dB}$
Conducted Spurious Emission
Measuring Uncertainty for a Level of Confidence of 95% ($U=2Uc(y)$): $\pm 2.65\text{ dB}$
Occupied Bandwidth
Measuring Uncertainty for a Level of Confidence of 95% ($U=2Uc(y)$): $\pm 3.3\%$
Temp. / Humidity
Measuring Uncertainty for a Level of Confidence of 95% ($U=2Uc(y)$): $\pm 0.82^\circ\text{C}/ \pm 3\%$
DC Voltage
Measuring Uncertainty for a Level of Confidence of 95% ($U=2Uc(y)$): $\pm 0.3\%$

7. TEST RESULT

7.1. Summary

FCC Part Section(s)	Test Description	Test Limit	Test Condition	Test Result	Reference
15.247(a)(2)	6dB Bandwidth	$\geq 500\text{kHz}$	Conducted	Pass	Section 7.2
15.247(b)(3)	Output Power	$\leq 30.00\text{dBm}$		Pass	Section 7.3
15.247(e)	Power Spectral Density	$\leq 8.00\text{dBm}/3\text{kHz}$		Pass	Section 7.4
15.247(d)	Out-of-Band Emissions	Conducted $\geq 30\text{dBc}$		Pass	Section 7.5
15.205 15.209	Spurious Emission	< FCC 15.209 limits	Radiated	Pass	Section 7.6
15.205 15.209	Band Edge Measurement	$\leq 74\text{dBuV/m(Peak)}$ $\leq 54\text{dBuV/m(Average)}$		Pass	Section 7.7
15.207	AC Conducted Emissions 150kHz - 30MHz	< FCC 15.207 limits	Line Conducted	Pass	Section 7.8

Notes:

- 1) Determining compliance is based on the test results met the regulation limits or requirements declared by clients, and the test results don't take into account the value of measurement uncertainty.
- 2) For radiated emission test, every axis (X, Y, Z) was also verified when applicable. The test results shown in the following sections represent the worst case emissions.
- 3) The analyzer plots shown in this section were all taken with a correction table loaded into the analyzer. The correction table was used to account for the losses of the cables and attenuators used as part of the system to connect the EUT to the analyzer at all frequencies of interest.

7.2. 6dB Bandwidth Measurement

7.2.1. Test Limit

The minimum 6dB bandwidth shall be at least 500 kHz.

7.2.2. Test Procedure used

ANSI C63.10 - 2013 Section 11.8

7.2.3. Test Setting

1. The Spectrum's automatic bandwidth measurement capability was used to perform the 6dB bandwidth measurement. The "X" dB bandwidth parameter was set to $X = 6$. The bandwidth measurement was not influenced by any intermediate power nulls in the fundamental emission.
2. Set RBW = 100 kHz
3. $VBW \geq 3 \times RBW$
4. Detector = Peak
5. Trace mode = max hold
6. Sweep = auto couple
7. Allow the trace was allowed to stabilize

7.2.4. Test Setup

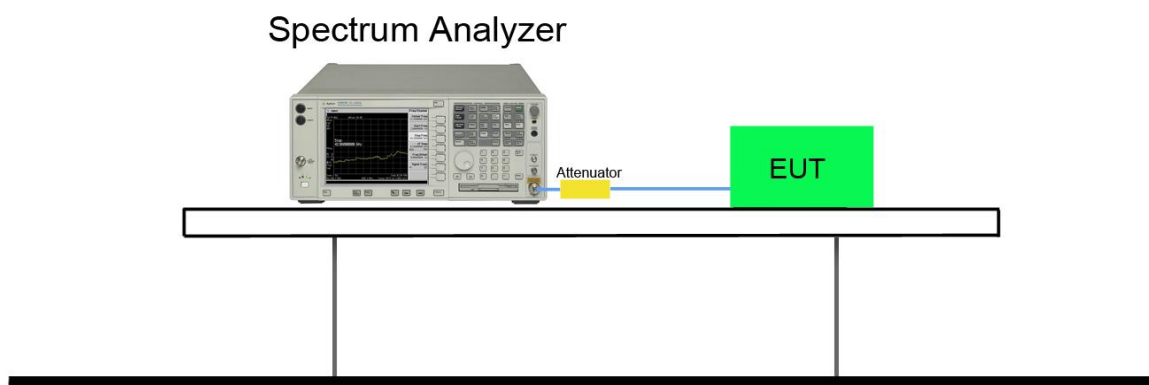

7.2.5. Test Result

Product	AX3000 Ceiling Mount Wi-Fi 6 Access Point	Temperature	25°C
Test Engineer	Xuan Yu	Relative Humidity	54%
Test Site	SR6	Test Date	2024/2/28

Test Mode	Channel No.	Frequency (MHz)	6dB Bandwidth (MHz)	Limit (MHz)	Result
LE	00	2402	0.5026	≥ 0.5	Pass
LE	19	2440	0.5083	≥ 0.5	Pass
LE	39	2480	0.5033	≥ 0.5	Pass

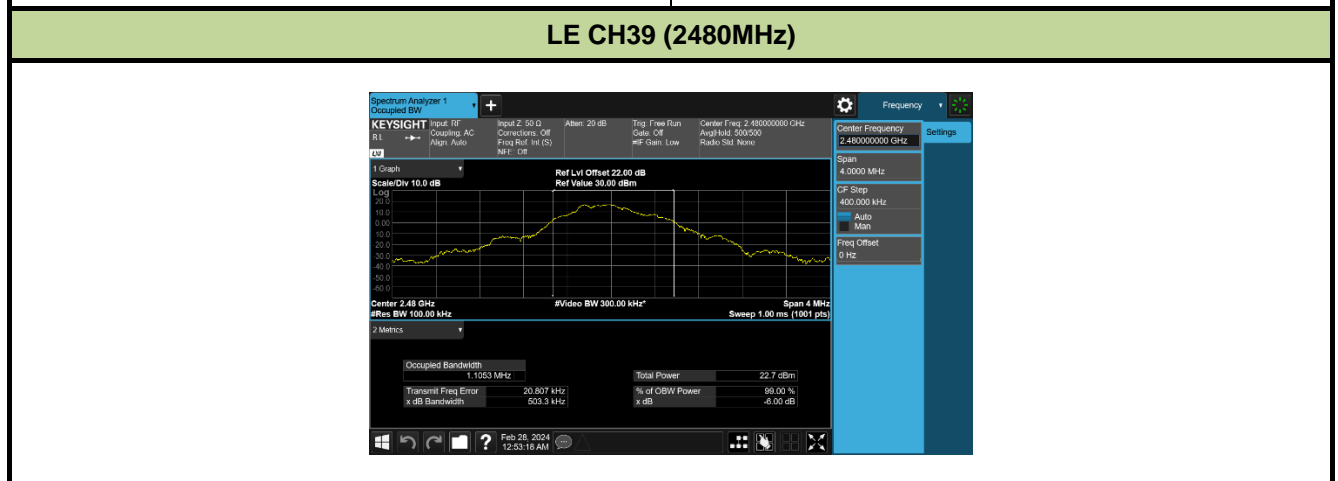
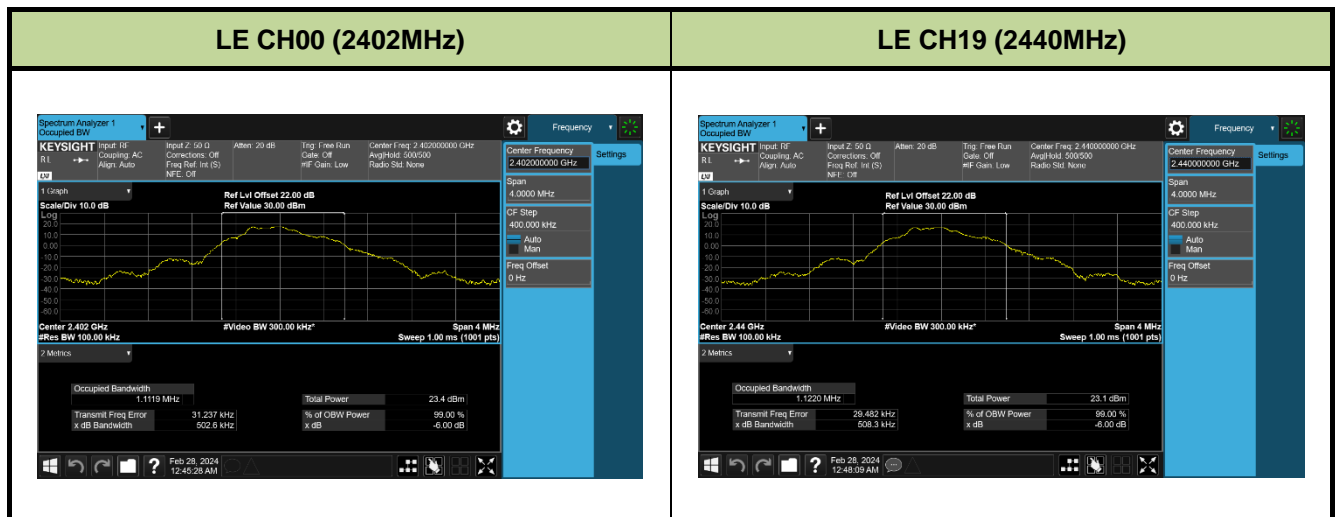

7.3. Output Power Measurement

7.3.1. Test Limit

The maximum out power shall be less 1 Watt (30dBm).

The conducted output power limit specified in paragraph FCC Part 15.247(b) of this section is based on the use of antennas with directional gains that do not exceed 6 dBi. If transmitting antennas of directional gain greater than 6 dBi are used, the conducted output power from the intentional radiator shall be reduced below the stated values in paragraphs FCC Part 15.247(b)(3) of this section, as appropriate, by the amount in dB that the directional gain of the antenna exceeds 6 dBi.

7.3.2. Test Procedure Used

ANSI C63.10 - 2013 Section 11.9.2.3.2

7.3.3. Test Setting

Peak Power Measurement

The maximum peak conducted output power may be measured using a broadband peak RF power meter. The power meter shall have a video bandwidth that is greater than or equal to the DTS bandwidth and shall utilize a fast-responding diode detector.

Average Power Measurement

Average power measurements were performed only when the EUT was transmitting at its maximum power control level using a broadband power meter with a pulse sensor. The power meter implemented triggering and gating capabilities which were set up such that power measurements were recorded only during the ON time of the transmitter. The trace was averaged over 100 traces to obtain the final measured average power.

7.3.4. Test Setup



7.3.5. Test Result of Output Power

Product	AX3000 Ceiling Mount Wi-Fi 6 Access Point	Temperature	25°C
Test Engineer	Xuan Yu	Relative Humidity	54%
Test Site	SR6	Test Date	2024/2/28

Test Mode	Channel No.	Frequency (MHz)	Average Power (dBm) [Report only]	Peak Power (dBm)	Power Limit (dBm)
LE	00	2402	19.08	24.45	< 30
LE	19	2440	19.11	24.52	< 30
LE	39	2480	19.19	24.72	< 30

Note1: Output power = Reading value on power meter + cable loss.

Note2: Antenna Gain: 3.00dBi.

7.4. Power Spectral Density Measurement

7.4.1. Test Limit

The maximum permissible power spectral density is 8dBm in any 3 kHz band.

7.4.2. Test Procedure Used

ANSI C63.10 Section 11.10.5

7.4.3. Test Setting

1. Measure the duty cycle (x) of the transmitter output signal.
2. Set instrument center frequency to DTS channel center frequency.
3. Set span to at least 1.5 times the OBW.
4. RBW = 10 kHz.
5. VBW = 30 kHz.
6. Detector = RMS.
7. Ensure that the number of measurement points in the sweep $\geq 2 \times \text{span}/\text{RBW}$.
8. Sweep time = auto couple.
9. Don't use sweep triggering. Allow sweep to "free run".
10. Employ trace averaging (RMS) mode over a minimum of 100 traces.
11. Use the peak marker function to determine the maximum amplitude level.
12. Add $10 \log (1/x)$, where x is the duty cycle measured in step (a), to the measured PSD to compute the average PSD during the actual transmission time.

7.4.4. Test Setup

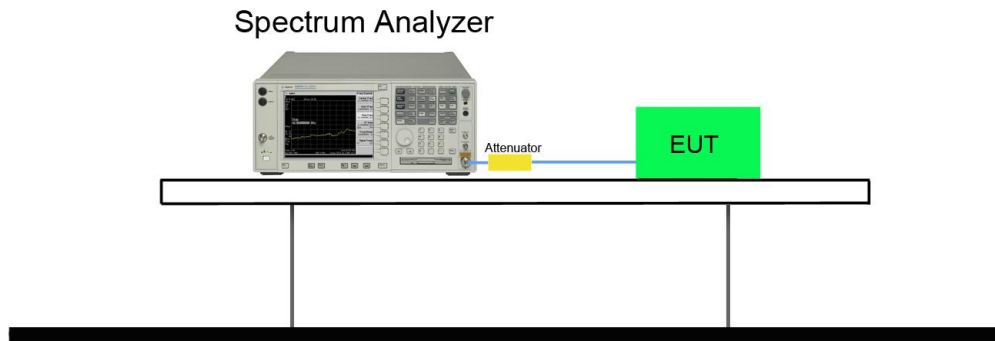

7.4.5. Test Result

Product	AX3000 Ceiling Mount Wi-Fi 6 Access Point	Temperature	25°C
Test Engineer	Xuan Yu	Relative Humidity	54%
Test Site	SR6	Test Date	2024/2/28

Test Mode	Channel No.	Frequency (MHz)	PSD (dBm/10kHz)	Duty Cycle (%)	Total PSD (dBm/10kHz)	Limit (dBm/3kHz)	Result
LE	00	2402	-0.280	19.20%	6.887	≤ 8	Pass
LE	19	2440	0.094	19.20%	7.261	≤ 8	Pass
LE	39	2480	0.077	19.20%	7.244	≤ 8	Pass

Note: Total Average PSD= Average PSD + 10*log (1/Duty Cycle).

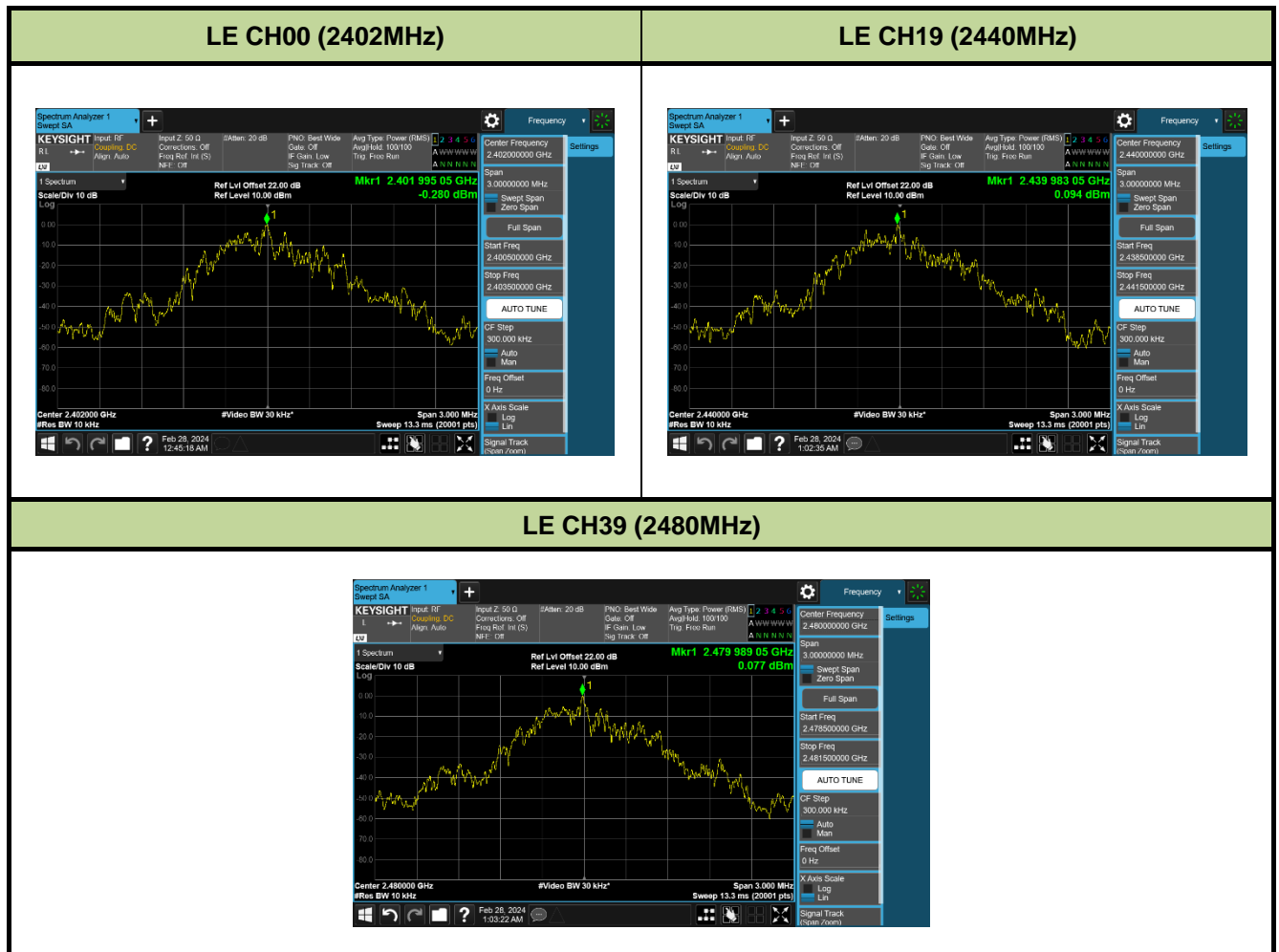

7.5. Out-of-Band Spurious Emissions Emissions Measurement

7.5.1. Test Limit

In any 100 kHz bandwidth outside the frequency band in which the spread spectrum or digitally modulated intentional radiator is operating, the radio frequency power that is produced by the intentional radiator shall be at least 30 dB below that in the 100 kHz bandwidth within the band that contains the highest level of the desired power, based on RF conducted measurement, provided the transmitter demonstrates compliance with the peak conducted power limits.

7.5.2. Test Procedure Used

ANSI C63.10 - 2013 Section 11.1 & 11.2

7.5.3. Test Setting

- (a) Set instrument center frequency to DTS channel center frequency
- (b) Set the span to ≥ 1.5 times the DTS bandwidth
- (c) Set the RBW = 100 kHz
- (d) Set the VBW $\geq 3 \times$ RBW
- (e) Detector = peak
- (f) Sweep time = auto couple
- (g) Trace mode = max hold
- (h) Allow trace to fully stabilize

7.5.4. Test Setup

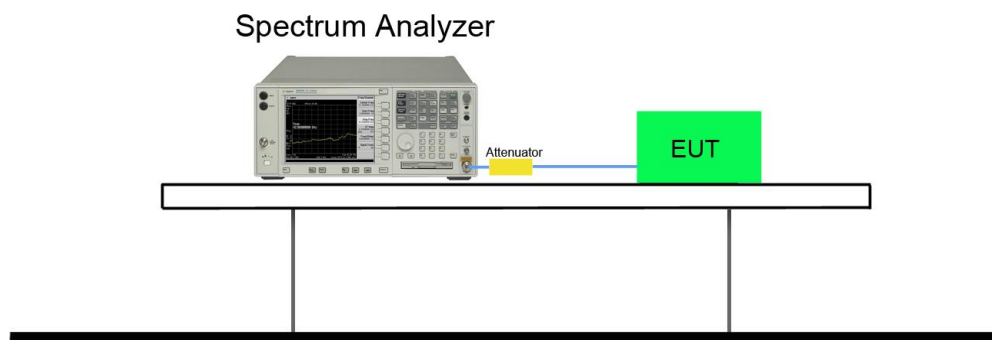

7.5.5. Test Result

Product	AX3000 Ceiling Mount Wi-Fi 6 Access Point	Temperature	25°C
Test Engineer	Xuan Yu	Relative Humidity	54%
Test Site	SR6	Test Date	2024/2/28

Test Mode	Channel No.	Frequency (MHz)	Limit	Result
LE	00	2402	30dBc	Pass
LE	19	2440	30dBc	Pass
LE	39	2480	30dBc	Pass

CH00 (2402MHz) LE(1Mbps)

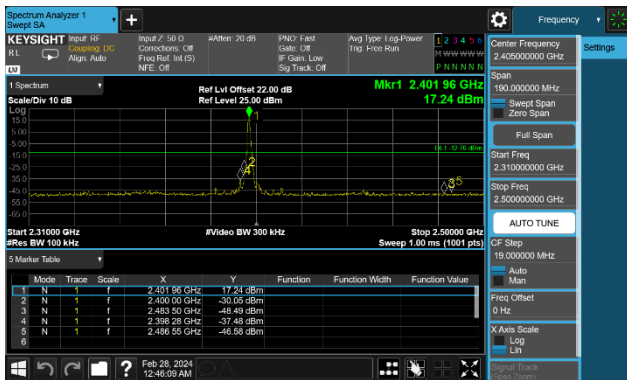

CH00 (2402MHz) LE(1Mbps)

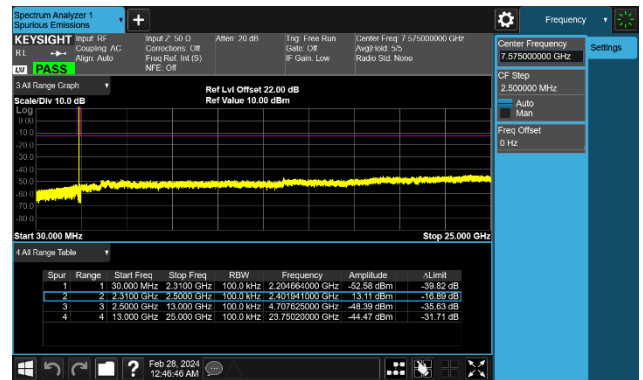

CH19 (2440MHz) LE(1Mbps)

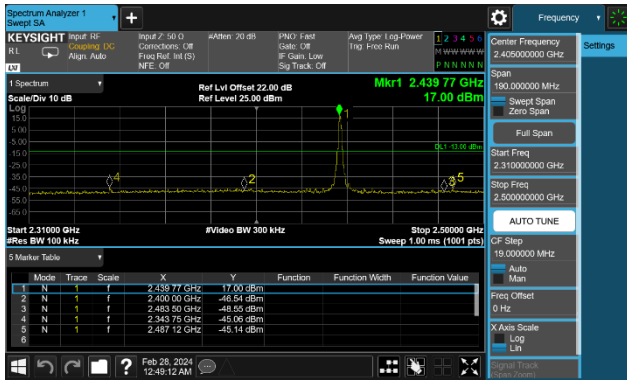

CH19 (2440MHz) LE(1Mbps)

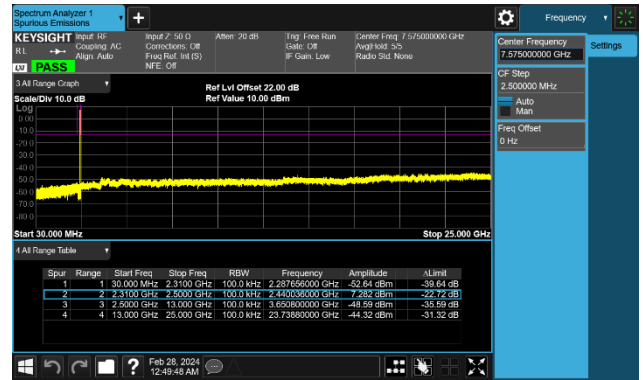

CH39 (2480MHz) LE(1Mbps)

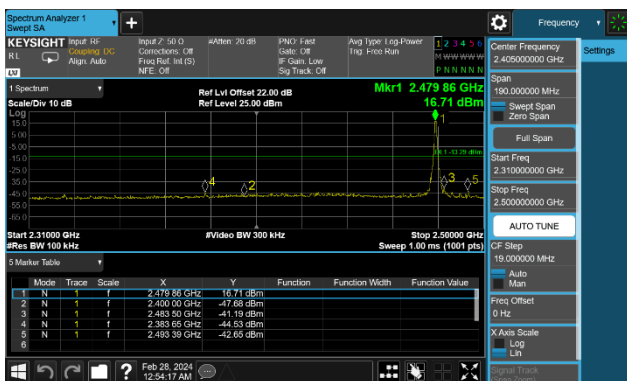

CH39 (2480MHz) LE(1Mbps)

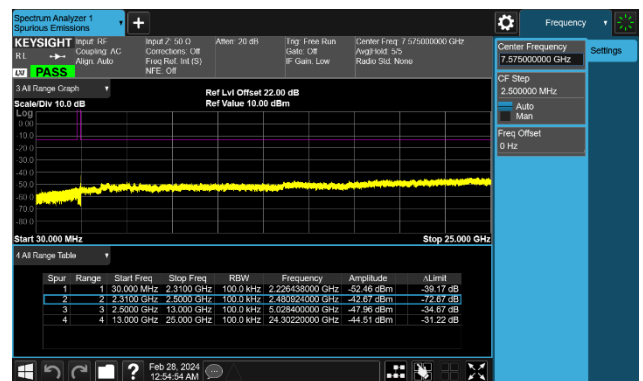

7.6. Radiated Spurious Emission Measurement

7.6.1. Test Limit

All out of band emissions appearing in a restricted band as specified in Section 15.205 of the Title 47 CFR must not exceed the limits shown in Table per Section 15.209.

FCC Part 15 Subpart C Paragraph 15.209		
Frequency [MHz]	Field Strength [V/m]	Measured Distance [Meters]
0.009 - 0.490	2400/F (kHz)	300
0.490 - 1.705	24000/F (kHz)	30
1.705 - 30	30	30
30 - 88	100	3
88 - 216	150	3
216 - 960	200	3
Above 960	500	3

7.6.2. Test Procedure Used

ANSI C63.10 - 2013 Section 11.12.2.3 (quasi-peak measurements)

ANSI C63.10 - 2013 Section 11.12.2.4 (peak power measurements)

ANSI C63.10 - 2013 Section 11.12.2.5 (average power measurements)

7.6.3. Test Setting

Peak Field Strength Measurements

1. Analyzer center frequency was set to the frequency of the radiated spurious emission of interest
2. RBW = as specified in Table 1
3. VBW = 3MHz
4. Detector = peak
5. Sweep time = auto couple

6. Trace mode = max hold

7. Trace was allowed to stabilize

Table 1 - RBW as a function of frequency

Frequency	RBW
9 ~ 150 kHz	200 ~ 300 Hz
0.15 ~ 30 MHz	9 ~ 10 kHz
30 ~ 1000 MHz	100 ~ 120 kHz
> 1000 MHz	1 MHz

Average Field Strength Measurements

1. Analyzer center frequency was set to the frequency of the radiated spurious emission of interest

2. RBW = 1MHz

3. VBW \geq 1/T

4. De As an alternative, the instrument may be set to linear detector mode. Ensure that video filtering is applied in linear voltage domain (rather than in a log or dB domain). Some instruments require linear display mode in order to accomplish this. Others have a setting for Average-VBW Type, which can be set to "Voltage" regardless of the display mode

5. Detector = Peak

6. Sweep time = auto

7. Trace mode = max hold

8. Allow max hold to run for at least 50 times (1/duty cycle) traces

7.6.4. Test Setup

9kHz ~ 30MHz Test Setup:

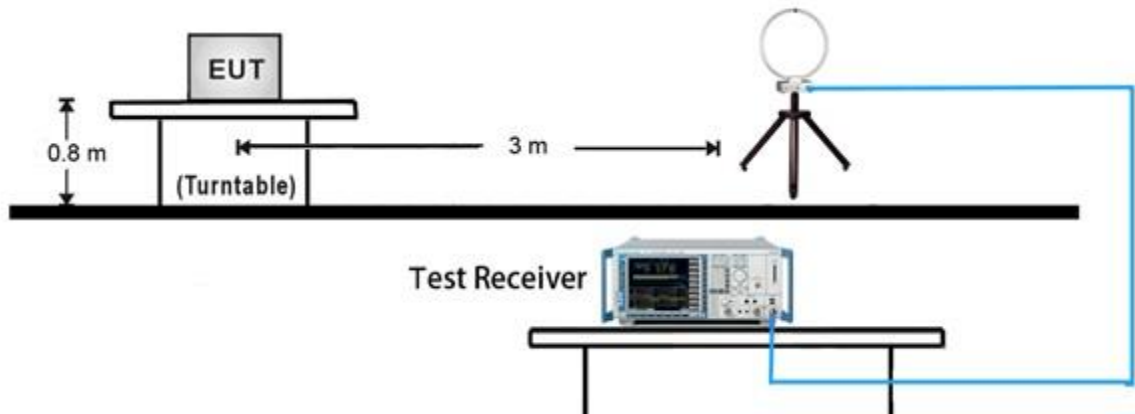

30MHz ~ 1GHz Test Setup:

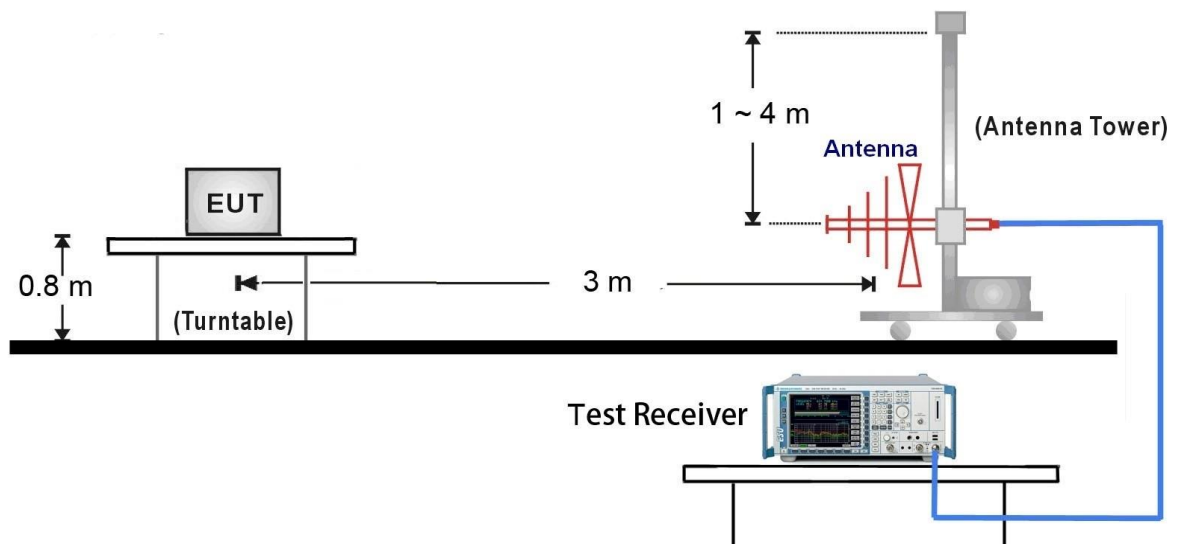

1GHz ~ 25GHz Test Setup:

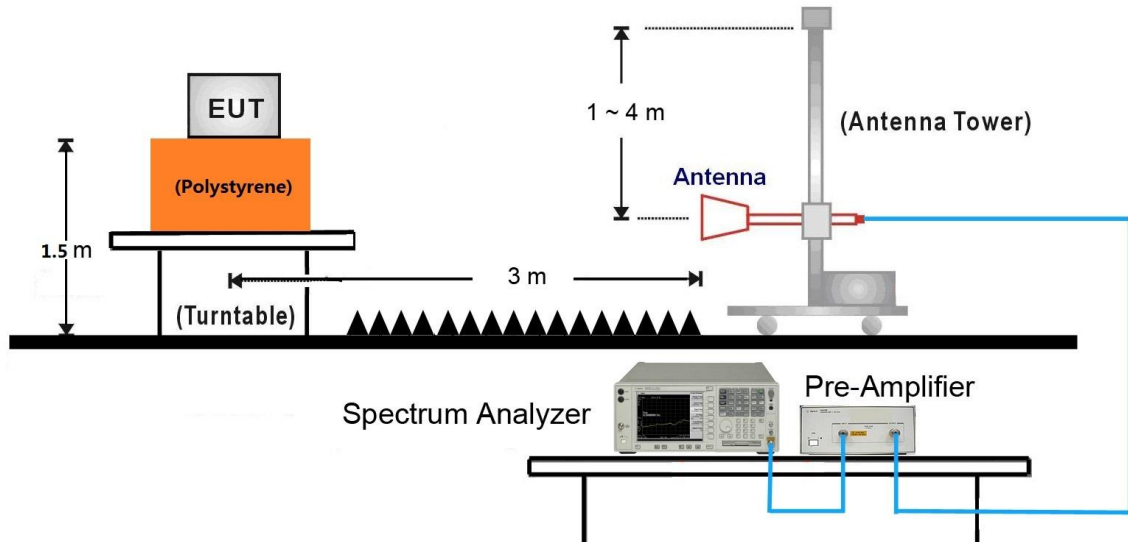

7.6.5. Test Result

EUT	AX3000 Ceiling Mount Wi-Fi 6 Access Point	Date of Test	2024-02-21
Factor	VULB 9162	Temp. / Humidity	22°C /61%
Polarity	Horizontal	Site / Test Engineer	AC2 / Stanley
Test Mode	BLE_1Mbps_TX_CH 19	Test Voltage	AC 120V/60Hz

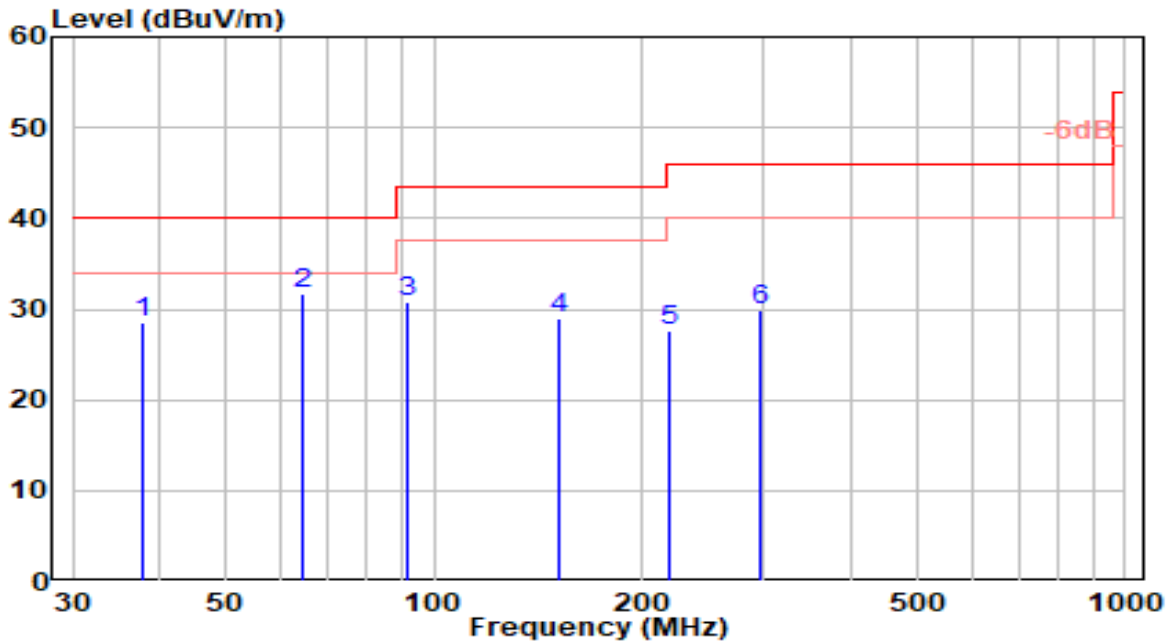

No	Frequency (MHz)	Reading (dBuV)	C.F (dB/m)	Measurement (dBuV/m)	Margin (dB)	Limit (dBuV/m)	Height (cm)	Angle (deg)	Remark (QP/PK/AV)
1	37.780	9.70	18.88	28.58	-11.42	40.00	100	234	QP
2	* 64.760	14.25	17.51	31.76	-8.24	40.00	150	51	QP
3	91.370	13.87	17.03	30.90	-12.60	43.50	200	16	QP
4	151.210	13.68	15.19	28.87	-14.63	43.50	100	30	QP
5	218.900	9.29	18.27	27.56	-18.44	46.00	200	42	QP
6	297.510	9.26	20.57	29.84	-16.16	46.00	150	153	QP

Note:

1. " *", means this data is the worst emission level.
2. C.F (Correction Factor) = Antenna Factor (dB/m) + Cable Loss (dB).
3. Measurement (dBuV/m) = Reading(dBuV) + C.F (Correction Factor).
4. The emission levels of other frequencies are very lower than the limit and not show in test report.
5. The amplitude of radiated emissions (frequency range from 9kHz to 30MHz) is that proximity to ambient noise, which also are attenuated more than 20dB below the permissible value. Therefore, the data is not presented in the report.

EUT	AX3000 Ceiling Mount Wi-Fi 6 Access Point	Date of Test	2024-02-21
Factor	VULB 9162	Temp. / Humidity	22°C /61%
Polarity	Vertical	Site / Test Engineer	AC2 / Stanley
Test Mode	BLE_1Mbps_TX_CH 19	Test Voltage	AC 120V/60Hz

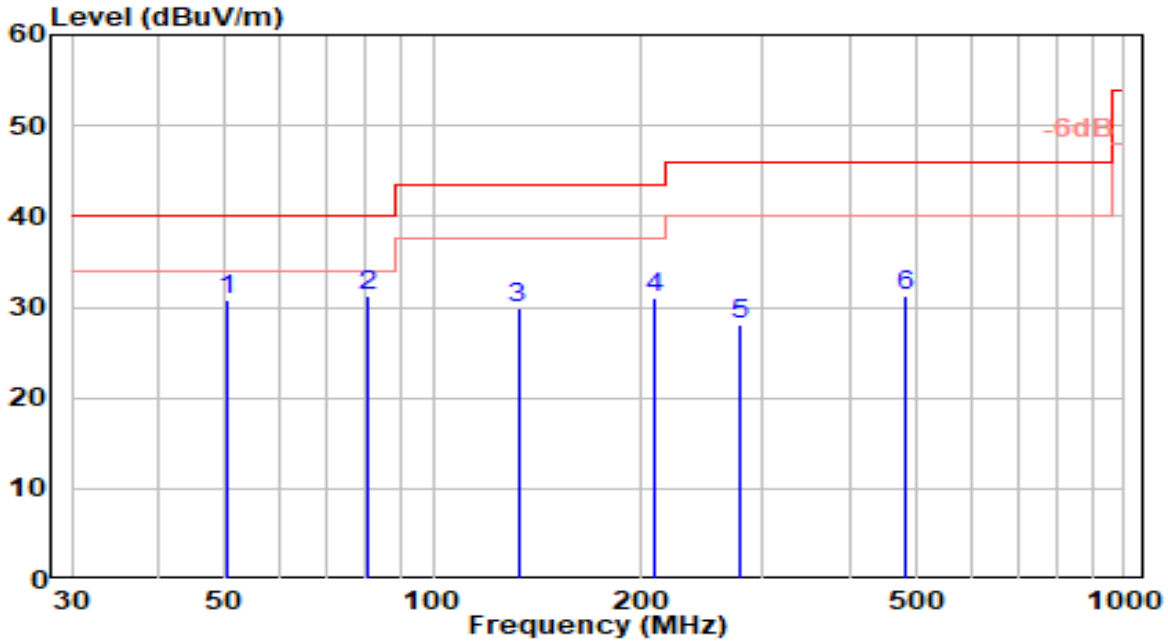

No	Frequency (MHz)	Reading (dBuV)	C.F (dB/m)	Measurement (dBuV/m)	Margin (dB)	Limit (dBuV/m)	Height (cm)	Angle (deg)	Remark (QP/PK/AV)
1	50.230	10.43	20.41	30.84	-9.16	40.00	150	42	QP
2	* 80.240	17.39	13.90	31.29	-8.71	40.00	150	42	QP
3	132.730	14.69	15.14	29.83	-13.67	43.50	100	243	QP
4	209.590	13.23	17.73	30.96	-12.54	43.50	200	102	QP
5	277.400	7.94	20.06	27.99	-18.01	46.00	100	18	QP
6	481.540	6.71	24.57	31.28	-14.72	46.00	200	287	QP

Note:

- "*" means this data is the worst emission level.
- C.F (Correction Factor) = Antenna Factor (dB/m) + Cable Loss (dB).
- Measurement (dBuV/m) = Reading(dBuV) + C.F (Correction Factor).
- The emission levels of other frequencies are very lower than the limit and not show in test report.
- The amplitude of radiated emissions (frequency range from 9kHz to 30MHz) is that proximity to ambient noise, which also are attenuated more than 20dB below the permissible value. Therefore, the data is not presented in the report.

EUT	AX3000 Ceiling Mount Wi-Fi 6 Access Point	Date of Test	2024-02-20
Factor	DRH18-E	Temp. / Humidity	22°C /61%
Polarity	Horizontal	Site / Test Engineer	AC2 / Marvin
Test Mode	BLE_TX_1Mbps_CH 00	Test Voltage	AC 120V/60Hz

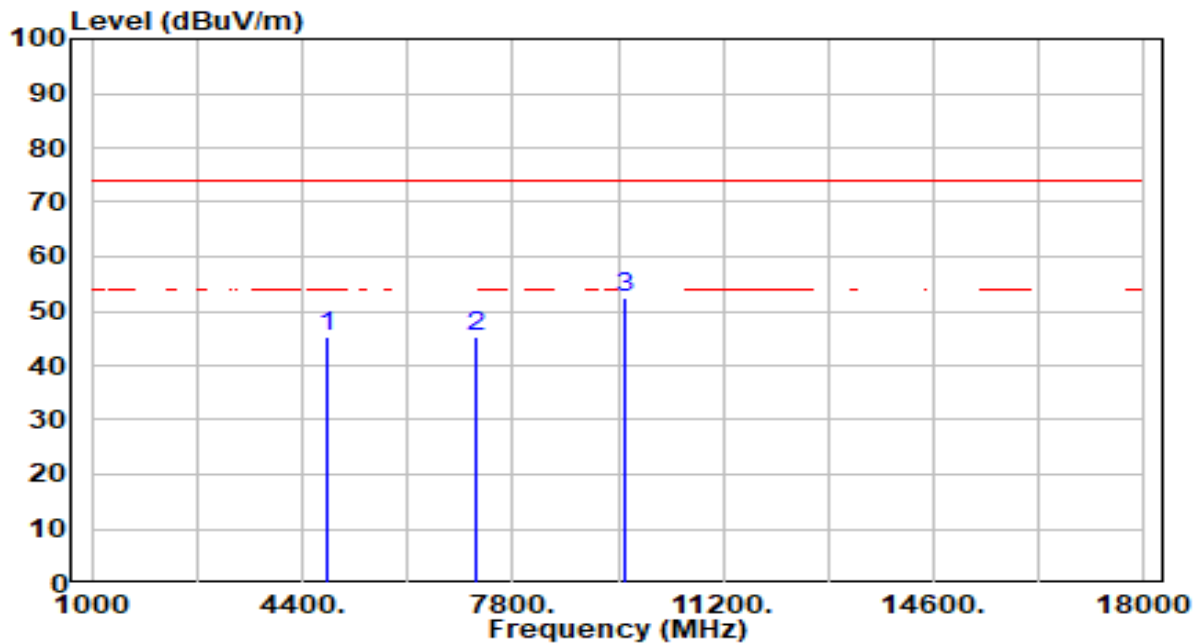

No	Frequency (MHz)	Reading (dBuV)	C.F (dB/m)	Measurement (dBuV/m)	Margin (dB)	Limit (dBuV/m)	Height (cm)	Angle (deg)	Remark (QP/PK/AV)
1	4804.000	45.25	0.18	45.44	-28.56	74.00	100	195	Peak
2	7206.000	39.77	5.53	45.30	-28.70	74.00	100	20	Peak
3	* 9608.000	47.13	5.29	52.42	-21.58	74.00	100	103	Peak

Note:

- "*", means this data is the worst emission level.
- C.F (Correction Factor) = Antenna Factor (dB/m)+ Cable Loss (dB) – Pre-amplifier(dB).
- Measurement (dBuV/m) = Reading(dBuV) + C.F (Correction Factor).
- The emission levels of other frequencies are very lower than the limit and not show in test report.

EUT	AX3000 Ceiling Mount Wi-Fi 6 Access Point	Date of Test	2024-02-20
Factor	DRH18-E	Temp. / Humidity	22°C /61%
Polarity	Vertical	Site / Test Engineer	AC2 / Marvin
Test Mode	BLE_TX_1Mbps_CH 00	Test Voltage	AC 120V/60Hz

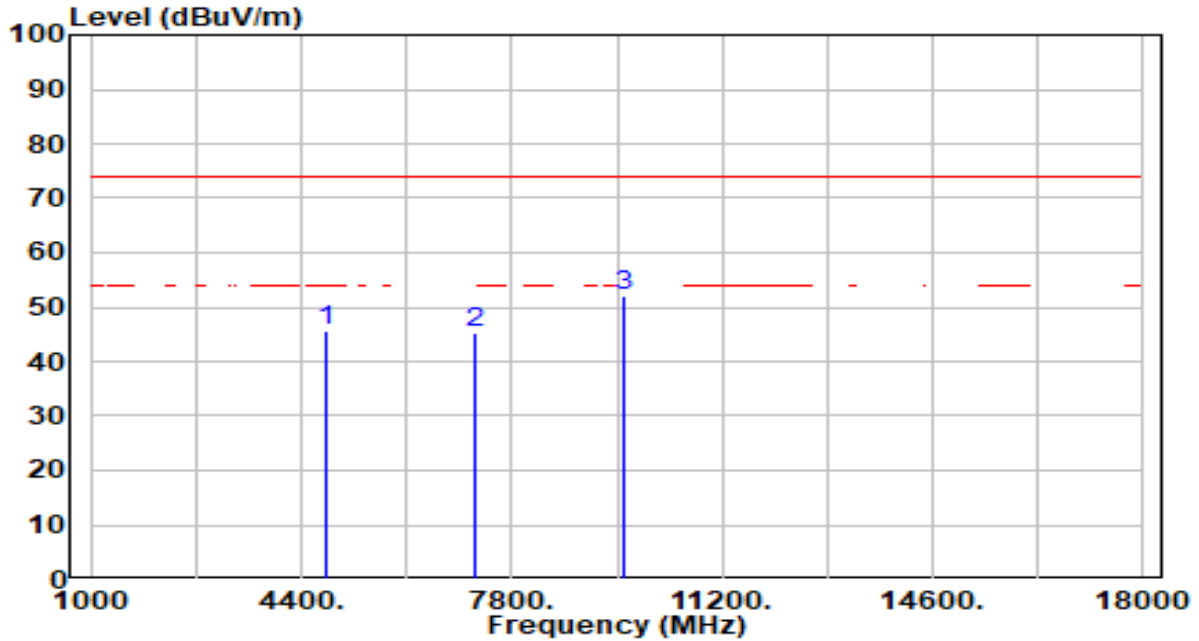

No	Frequency (MHz)	Reading (dBuV)	C.F (dB/m)	Measurement (dBuV/m)	Margin (dB)	Limit (dBuV/m)	Height (cm)	Angle (deg)	Remark (QP/PK/AV)
1	4804.000	45.45	0.18	45.63	-28.37	74.00	200	232	Peak
2	7206.000	39.90	5.53	45.42	-28.58	74.00	200	189	Peak
3	* 9608.000	46.91	5.29	52.19	-21.81	74.00	200	169	Peak

Note:

1. " *" , means this data is the worst emission level.
2. C.F (Correction Factor) = Antenna Factor (dB/m)+ Cable Loss (dB) – Preamplifier(dB).
3. Measurement (dBuV/m) = Reading(dBuV) + C.F (Correction Factor).
4. The emission levels of other frequencies are very lower than the limit and not show in test report.

EUT	AX3000 Ceiling Mount Wi-Fi 6 Access Point	Date of Test	2024-02-20
Factor	DRH18-E	Temp. / Humidity	22°C /61%
Polarity	Horizontal	Site / Test Engineer	AC2 / Marvin
Test Mode	BLE_TX_1Mbps_CH 19	Test Voltage	AC 120V/60Hz

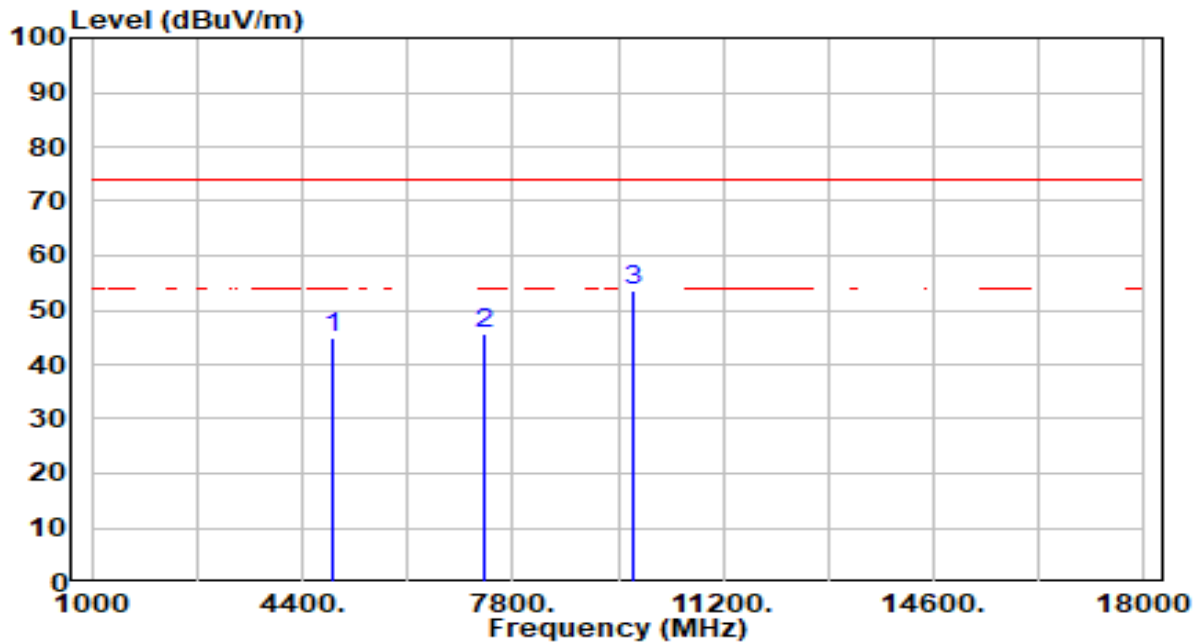

No	Frequency (MHz)	Reading (dBuV)	C.F (dB/m)	Measurement (dBuV/m)	Margin (dB)	Limit (dBuV/m)	Height (cm)	Angle (deg)	Remark (QP/PK/AV)
1	4880.000	44.60	0.38	44.97	-29.03	74.00	100	143	Peak
2	7320.000	39.93	5.60	45.53	-28.47	74.00	300	61	Peak
3	* 9760.000	48.36	5.35	53.71	-20.29	74.00	100	212	Peak

Note:

1. " *" , means this data is the worst emission level.
2. C.F (Correction Factor) = Antenna Factor (dB/m)+ Cable Loss (dB) – Preamplifier(dB).
3. Measurement (dBuV/m) = Reading(dBuV) + C.F (Correction Factor).
4. The emission levels of other frequencies are very lower than the limit and not show in test report.

EUT	AX3000 Ceiling Mount Wi-Fi 6 Access Point	Date of Test	2024-02-20
Factor	DRH18-E	Temp. / Humidity	22°C /61%
Polarity	Vertical	Site / Test Engineer	AC2 / Marvin
Test Mode	BLE_TX_1Mbps_CH 19	Test Voltage	AC 120V/60Hz

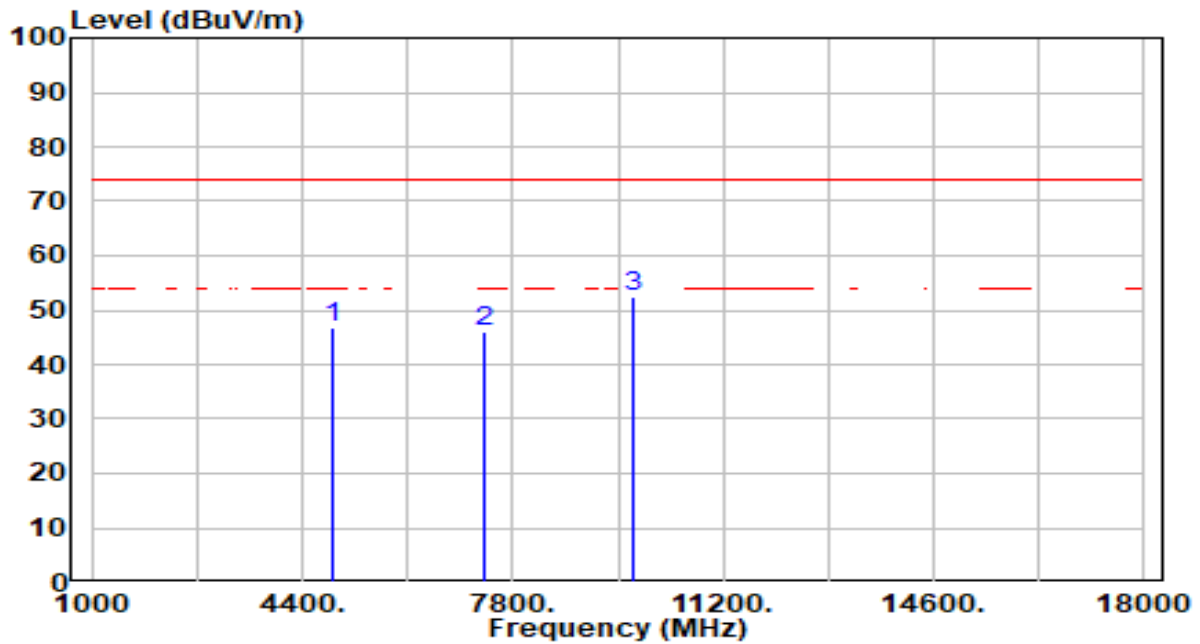

No	Frequency (MHz)	Reading (dBuV)	C.F (dB/m)	Measurement (dBuV/m)	Margin (dB)	Limit (dBuV/m)	Height (cm)	Angle (deg)	Remark (QP/PK/AV)
1	4880.000	46.31	0.38	46.68	-27.32	74.00	300	203	Peak
2	7320.000	40.52	5.60	46.11	-27.89	74.00	200	294	Peak
3	* 9760.000	47.26	5.35	52.61	-21.39	74.00	200	185	Peak

Note:

1. " *" , means this data is the worst emission level.
2. C.F (Correction Factor) = Antenna Factor (dB/m)+ Cable Loss (dB) – Pre-amplifier(dB).
3. Measurement (dBuV/m) = Reading(dBuV) + C.F (Correction Factor).
4. The emission levels of other frequencies are very lower than the limit and not show in test report.

EUT	AX3000 Ceiling Mount Wi-Fi 6 Access Point	Date of Test	2024-02-20
Factor	DRH18-E	Temp. / Humidity	22°C /61%
Polarity	Horizontal	Site / Test Engineer	AC2 / Marvin
Test Mode	BLE_TX_1Mbps_CH 39	Test Voltage	AC 120V/60Hz

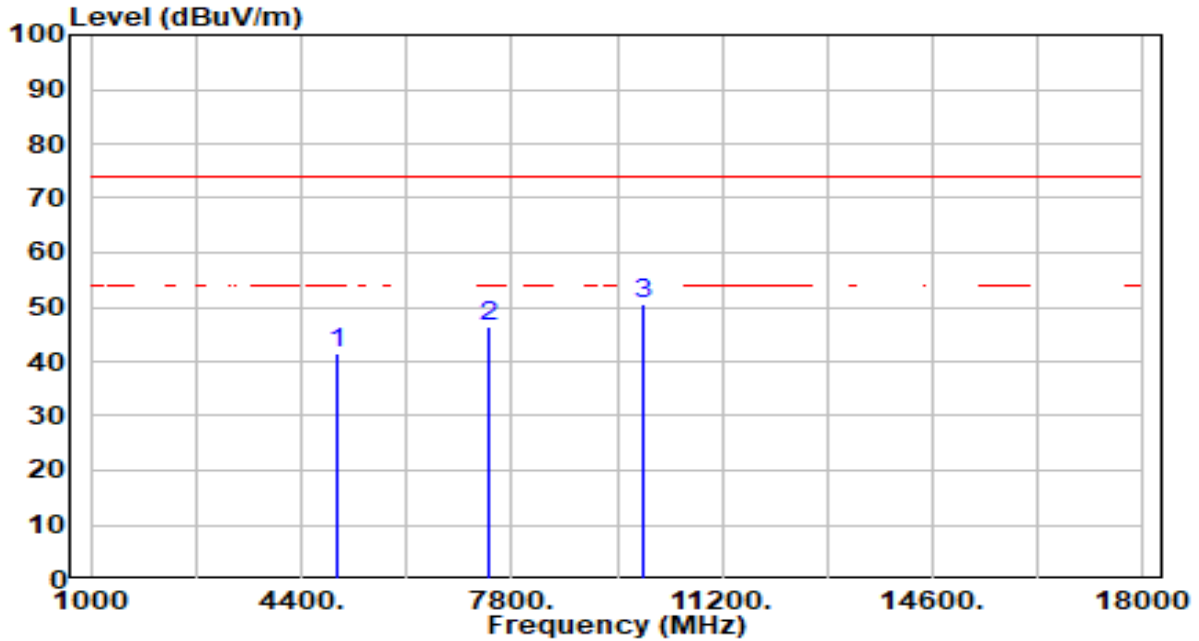

No	Frequency (MHz)	Reading (dBuV)	C.F (dB/m)	Measurement (dBuV/m)	Margin (dB)	Limit (dBuV/m)	Height (cm)	Angle (deg)	Remark (QP/PK/AV)
1	4960.000	41.10	0.59	41.68	-32.32	74.00	100	32	Peak
2	7440.000	40.81	5.63	46.44	-27.56	74.00	100	176	Peak
3	* 9920.000	45.32	5.42	50.73	-23.27	74.00	100	213	Peak

Note:

1. " *" , means this data is the worst emission level.
2. C.F (Correction Factor) = Antenna Factor (dB/m)+ Cable Loss (dB) – Preamplifier(dB).
3. Measurement (dBuV/m) = Reading(dBuV) + C.F (Correction Factor).
4. The emission levels of other frequencies are very lower than the limit and not show in test report.

EUT	AX3000 Ceiling Mount Wi-Fi 6 Access Point	Date of Test	2024-02-20
Factor	DRH18-E	Temp. / Humidity	22°C /61%
Polarity	Vertical	Site / Test Engineer	AC2 / Marvin
Test Mode	BLE_TX_1Mbps_CH 39	Test Voltage	AC 120V/60Hz

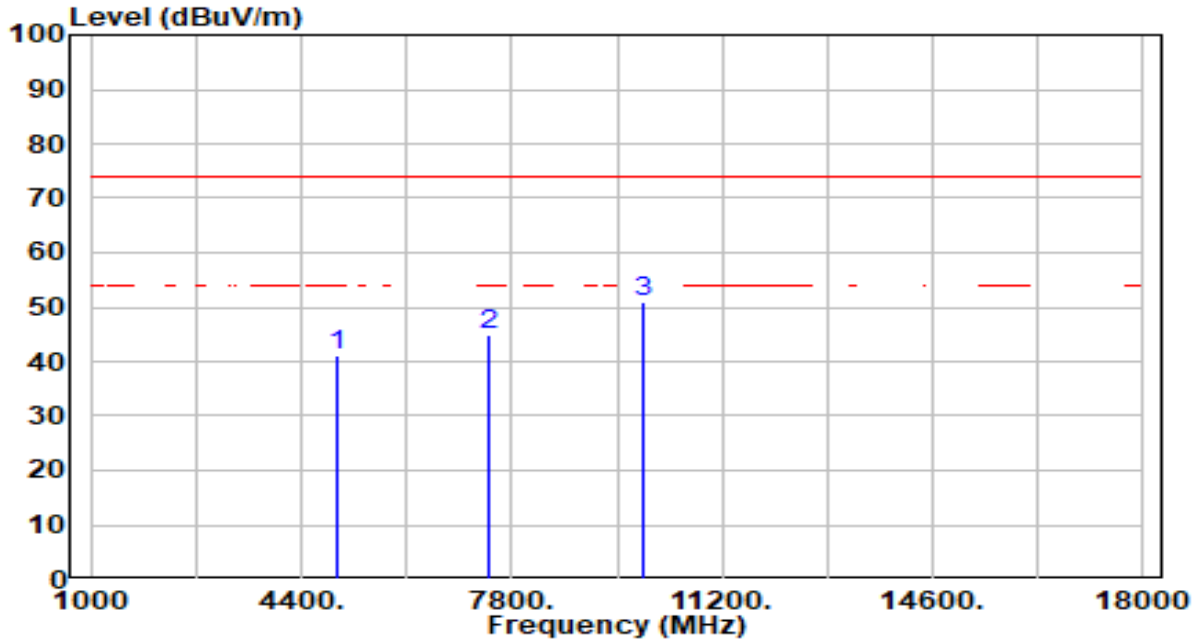

No	Frequency (MHz)	Reading (dBuV)	C.F (dB/m)	Measurement (dBuV/m)	Margin (dB)	Limit (dBuV/m)	Height (cm)	Angle (deg)	Remark (QP/PK/AV)
1	4960.000	40.64	0.59	41.23	-32.77	74.00	200	20	Peak
2	7440.000	39.36	5.63	44.99	-29.01	74.00	200	25	Peak
3	* 9920.000	45.63	5.42	51.05	-22.95	74.00	200	281	Peak

Note:

1. " *" , means this data is the worst emission level.
2. C.F (Correction Factor) = Antenna Factor (dB/m)+ Cable Loss (dB) – Preamplifier(dB).
3. Measurement (dBuV/m) = Reading(dBuV) + C.F (Correction Factor).
4. The emission levels of other frequencies are very lower than the limit and not show in test report.

EUT	AX3000 Ceiling Mount Wi-Fi 6 Access Point	Date of Test	2024-02-21
Factor	BBHA 9170	Temp. / Humidity	22°C /61%
Polarity	Horizontal	Site / Test Engineer	AC2 / Stanley
Test Mode	BLE_1Mbps_TX_CH 19	Test Voltage	AC 120V/60Hz

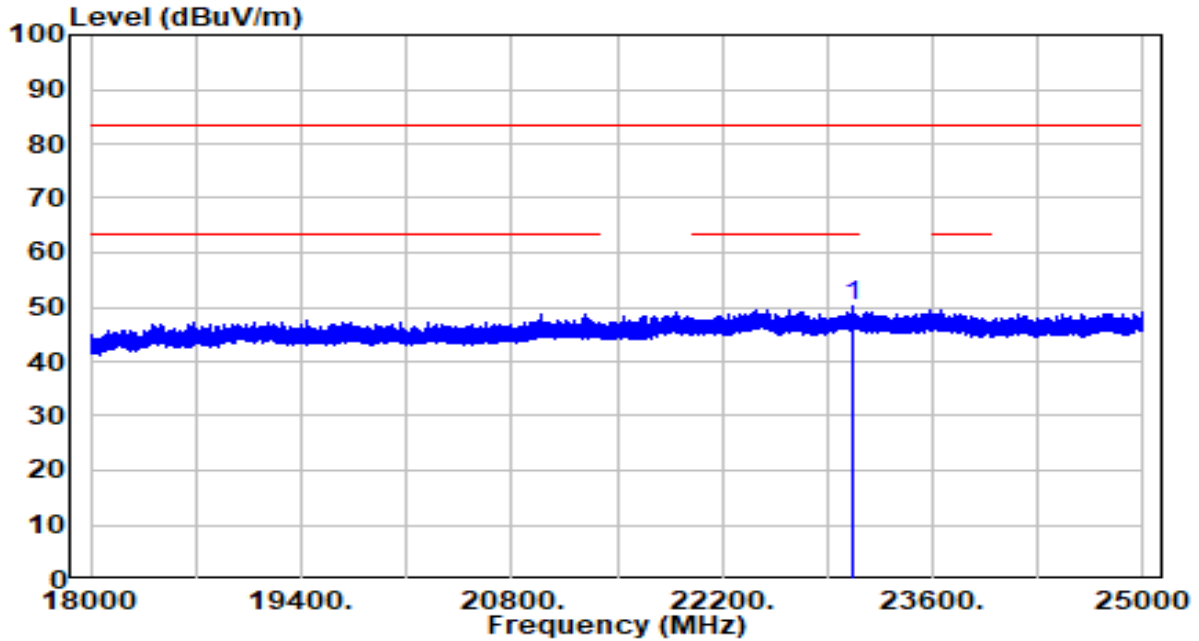

No	Frequency (MHz)	Reading (dBuV)	C.F (dB/m)	Measurement (dBuV/m)	Margin (dB)	Limit (dBuV/m)	Height (cm)	Angle (deg)	Remark (QP/PK/AV)	
1	*	23069.530	37.72	12.35	50.07	-33.43	83.50	150	360	Peak

Note:

1. " *", means this data is the worst emission level.
2. C.F (Correction Factor) = Antenna Factor (dB/m) + Cable Loss (dB) – Preamplifier(dB).
3. Measurement (dBuV/m) = Reading(dBuV) + C.F (Correction Factor).
4. The emission levels of other frequencies are very lower than the limit and not show in test report.

EUT	AX3000 Ceiling Mount Wi-Fi 6 Access Point	Date of Test	2024-02-21
Factor	BBHA 9170	Temp. / Humidity	22°C /61%
Polarity	Vertical	Site / Test Engineer	AC2 / Stanley
Test Mode	BLE_1Mbps_TX_CH 19	Test Voltage	AC 120V/60Hz

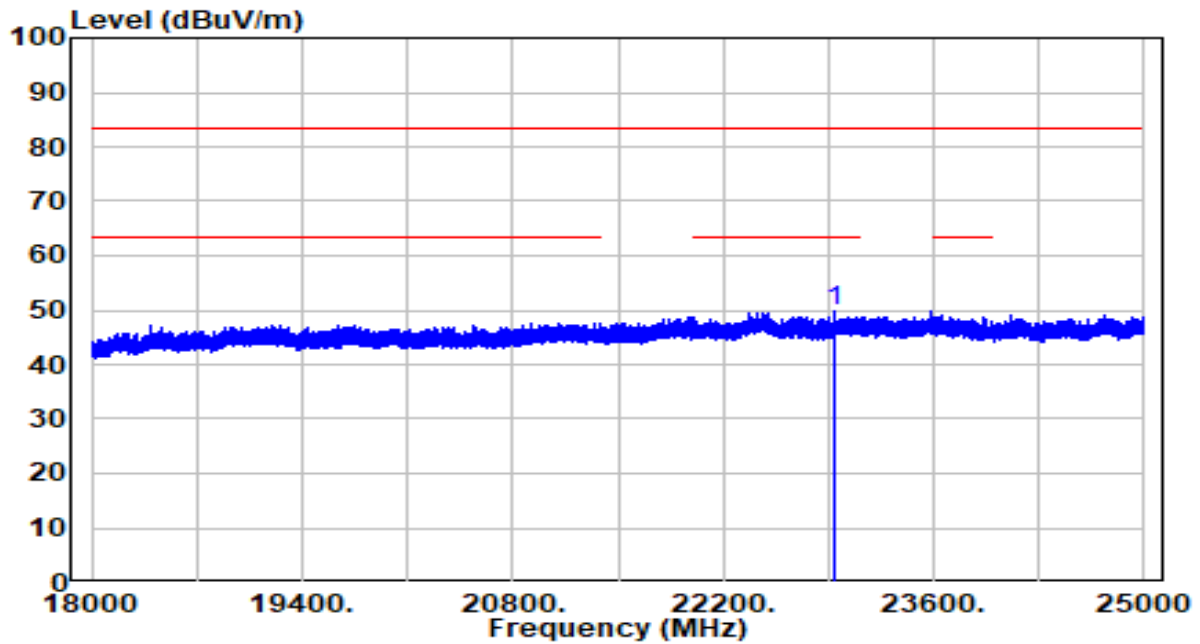

No	Frequency (MHz)	Reading (dBuV)	C.F (dB/m)	Measurement (dBuV/m)	Margin (dB)	Limit (dBuV/m)	Height (cm)	Angle (deg)	Remark (QP/PK/AV)	
1	*	22944.410	37.59	12.25	49.84	-33.66	83.50	150	360	Peak

Note:

1. " *", means this data is the worst emission level.
2. C.F (Correction Factor) = Antenna Factor (dB/m) + Cable Loss (dB) – Preamplifier(dB).
3. Measurement (dBuV/m) = Reading(dBuV) + C.F (Correction Factor).
4. The emission levels of other frequencies are very lower than the limit and not show in test report.

7.7. Radiated Restricted Band Edge Measurement

7.7.1. Test Limit

All out of band emissions appearing in a restricted band as specified in Section 15.205 of the Title 47 CFR must not exceed the limits shown in Table per Section 15.209.

FCC Part 15 Subpart C Paragraph 15.209		
Frequency [MHz]	Field Strength [V/m]	Measured Distance [Meters]
0.009 - 0.490	2400/F (kHz)	300
0.490 - 1.705	24000/F (kHz)	30
1.705 – 30	30	30
30 – 88	100	3
88 – 216	150	3
216 – 960	200	3
Above 960	500	3

7.7.2. Test Procedure Used

ANSI C63.10-2013 - Section 11.13

7.7.3. Test Setting

Peak Field Strength Measurements

1. Analyzer center frequency was set to the frequency of the radiated spurious emission of interest
2. RBW = as specified in Table 1
3. VBW = 3 * RBW
4. Detector = peak
5. Sweep time = auto couple
6. Trace mode = max hold
7. Trace was allowed to stabilize

Table 1 - RBW as a function of frequency

Frequency	RBW
9 ~ 150 kHz	200 ~ 300 Hz
0.15 ~ 30 MHz	9 ~ 10 kHz
30 ~ 1000 MHz	100 ~ 120 kHz
> 1000 MHz	1 MHz

Average Field Strength Measurements

1. Analyzer center frequency was set to the frequency of the radiated spurious emission of interest
2. RBW = 1MHz
3. VBW $\geq 1/T$
4. De As an alternative, the instrument may be set to linear detector mode. Ensure that video filtering is applied in linear voltage domain (rather than in a log or dB domain). Some instruments require linear display mode in order to accomplish this. Others have a setting for Average-VBW Type, which can be set to "Voltage" regardless of the display mode
5. Detector = Peak
6. Sweep time = auto
7. Trace mode = max hold
8. Allow max hold to run for at least 50 times (1/duty cycle) traces

7.7.4. Test Setup

1GHz ~ 25GHz Test Setup:

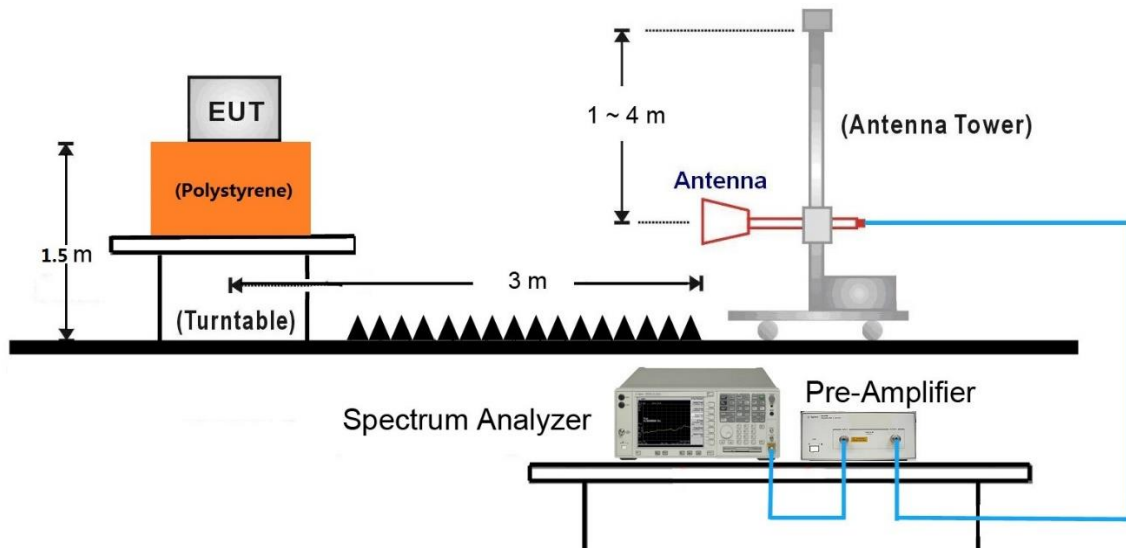

7.7.5. Test Result

EUT	AX3000 Ceiling Mount Wi-Fi 6 Access Point	Date of Test	2024-02-20
Factor	DRH18-E	Temp. / Humidity	22°C /61%
Polarity	Horizontal	Site / Test Engineer	AC2 / Marvin
Test Mode	BLE_TX_1Mbps_CH 00	Test Voltage	AC 120V/60Hz

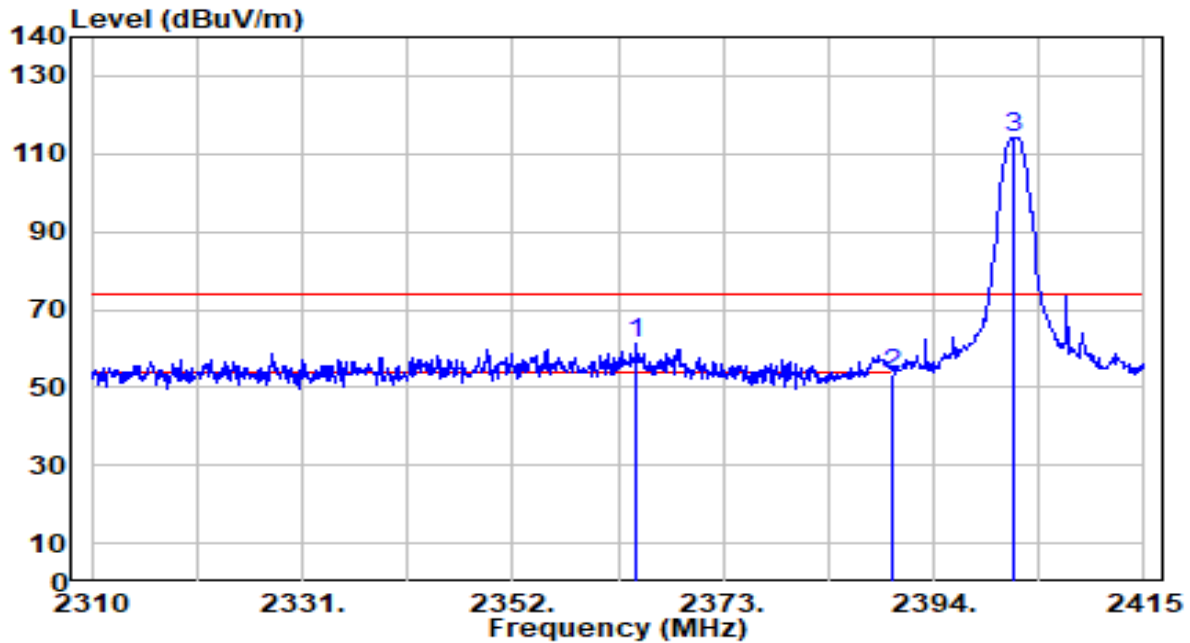

No	Frequency (MHz)	Reading (dBuV)	C.F (dB/m)	Measurement (dBuV/m)	Margin (dB)	Limit (dBuV/m)	Height (cm)	Angle (deg)	Remark (QP/PK/AV)	
1	*	2364.285	66.55	-5.19	61.35	-12.65	74.00	222	225	Peak
2		2390.000	58.34	-5.14	53.19	-20.81	74.00	222	225	Peak
3		2401.980	119.46	-5.13	114.34	N/A	N/A	222	225	Peak

Note:

1. " *", means this data is the worst emission level.
2. C.F (Correction Factor) = Antenna Factor (dB/m)+ Cable Loss (dB) – Preamplifier(dB).
3. Measurement (dBuV/m) = Reading(dBuV) + C.F (Correction Factor).
4. The emission levels of other frequencies are very lower than the limit and not show in test report.

EUT	AX3000 Ceiling Mount Wi-Fi 6 Access Point	Date of Test	2024-02-20
Factor	DRH18-E	Temp. / Humidity	22°C /61%
Polarity	Horizontal	Site / Test Engineer	AC2 / Marvin
Test Mode	BLE_TX_1Mbps_CH 00	Test Voltage	AC 120V/60Hz

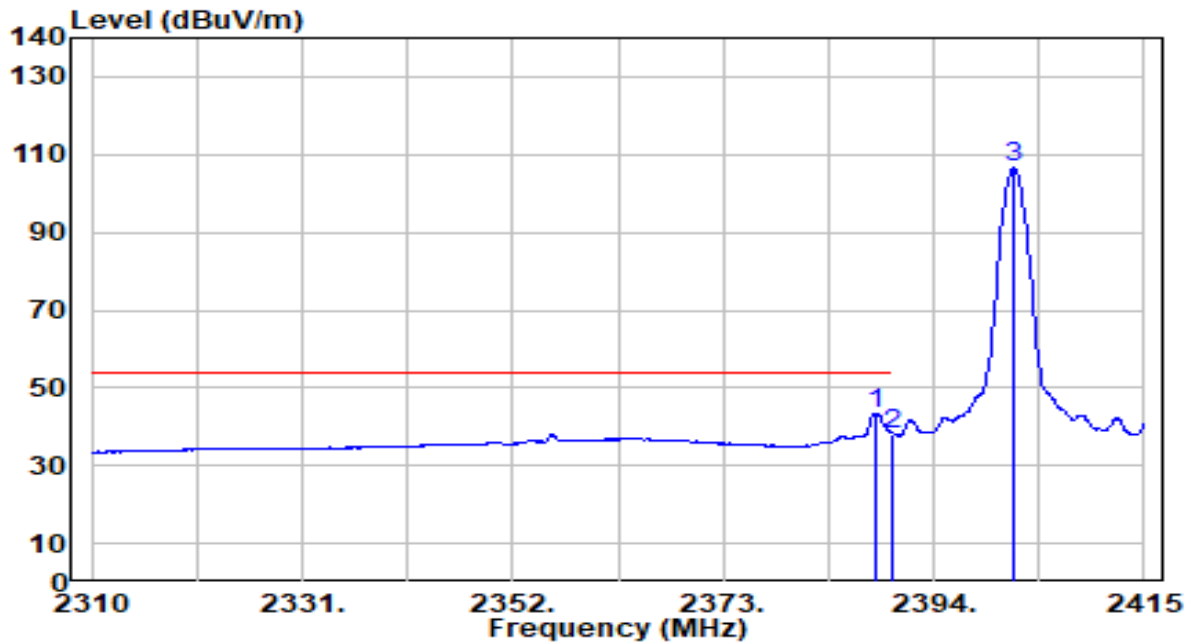

No	Frequency (MHz)	Reading (dBuV)	C.F (dB/m)	Measurement (dBuV/m)	Margin (dB)	Limit (dBuV/m)	Height (cm)	Angle (deg)	Remark (QP/PK/AV)
1	* 2388.225	48.70	-5.15	43.55	-10.45	54.00	222	225	Average
2	2390.000	43.43	-5.14	38.28	-15.72	54.00	222	225	Average
3	2401.980	111.71	-5.13	106.59	N/A	N/A	222	225	Average

Note:

1. " *" , means this data is the worst emission level.
2. C.F (Correction Factor) = Antenna Factor (dB/m)+ Cable Loss (dB) – Pre-amplifier(dB).
3. Measurement (dBuV/m) = Reading(dBuV) + C.F (Correction Factor).
4. The emission levels of other frequencies are very lower than the limit and not show in test report.

EUT	AX3000 Ceiling Mount Wi-Fi 6 Access Point	Date of Test	2024-02-20
Factor	DRH18-E	Temp. / Humidity	22°C /61%
Polarity	Vertical	Site / Test Engineer	AC2 / Marvin
Test Mode	BLE_TX_1Mbps_CH 00	Test Voltage	AC 120V/60Hz

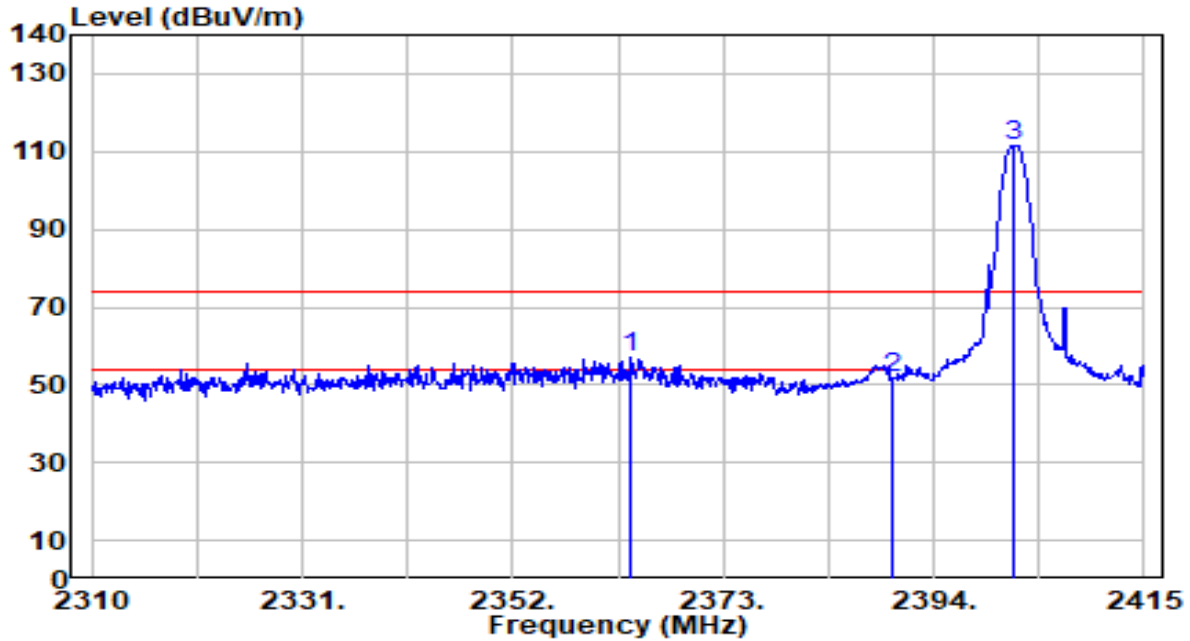

No	Frequency (MHz)	Reading (dBuV)	C.F (dB/m)	Measurement (dBuV/m)	Margin (dB)	Limit (dBuV/m)	Height (cm)	Angle (deg)	Remark (QP/PK/AV)	
1	*	2363.865	62.24	-5.19	57.04	-16.96	74.00	306	187	Peak
2		2390.000	56.89	-5.14	51.74	-22.26	74.00	306	187	Peak
3		2401.980	116.52	-5.13	111.40	N/A	N/A	306	187	Peak

Note:

1. " *" , means this data is the worst emission level.
2. C.F (Correction Factor) = Antenna Factor (dB/m)+ Cable Loss (dB) – Preamplifier(dB).
3. Measurement (dBuV/m) = Reading(dBuV) + C.F (Correction Factor).
4. The emission levels of other frequencies are very lower than the limit and not show in test report.

EUT	AX3000 Ceiling Mount Wi-Fi 6 Access Point	Date of Test	2024-02-20
Factor	DRH18-E	Temp. / Humidity	22°C /61%
Polarity	Vertical	Site / Test Engineer	AC2 / Marvin
Test Mode	BLE_TX_1Mbps_CH 00	Test Voltage	AC 120V/60Hz

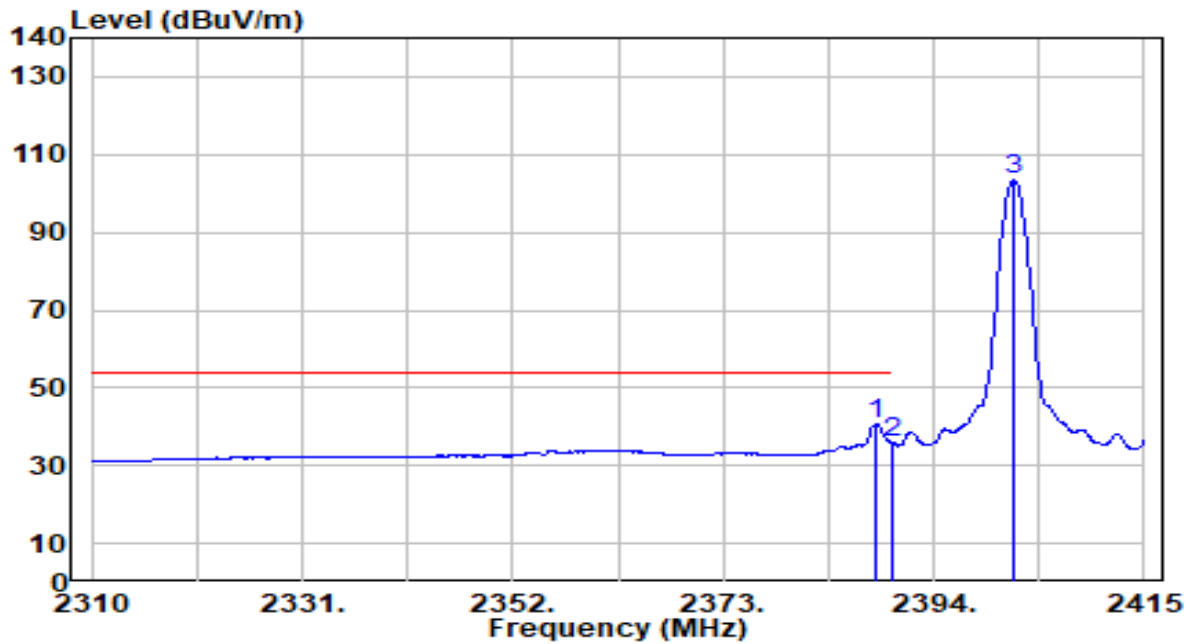

No	Frequency (MHz)	Reading (dBuV)	C.F (dB/m)	Measurement (dBuV/m)	Margin (dB)	Limit (dBuV/m)	Height (cm)	Angle (deg)	Remark (QP/PK/AV)	
1	*	2388.225	45.91	-5.15	40.76	-13.24	54.00	306	187	Average
2		2390.000	40.82	-5.14	35.68	-18.32	54.00	306	187	Average
3		2401.980	108.76	-5.13	103.63	N/A	N/A	306	187	Average

Note:

1. " *" , means this data is the worst emission level.
2. C.F (Correction Factor) = Antenna Factor (dB/m)+ Cable Loss (dB) – Preamplifier(dB).
3. Measurement (dBuV/m) = Reading(dBuV) + C.F (Correction Factor).
4. The emission levels of other frequencies are very lower than the limit and not show in test report.

EUT	AX3000 Ceiling Mount Wi-Fi 6 Access Point	Date of Test	2024-02-20
Factor	DRH18-E	Temp. / Humidity	22°C /61%
Polarity	Horizontal	Site / Test Engineer	AC2 / Marvin
Test Mode	BLE_TX_1Mbps_CH 39	Test Voltage	AC 120V/60Hz

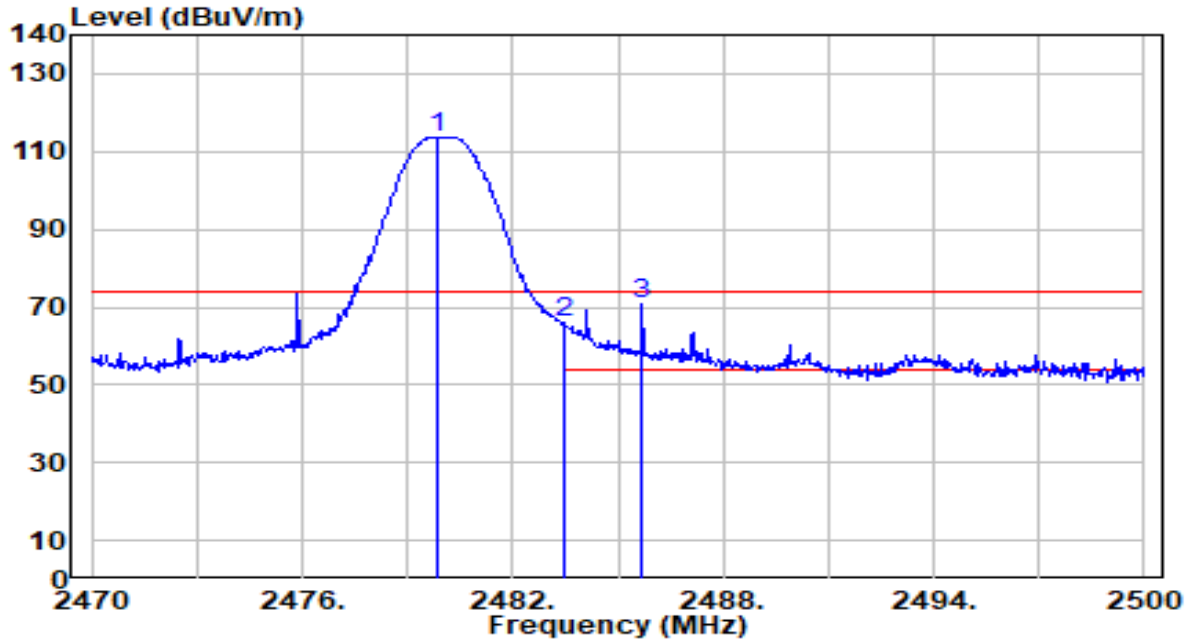

No	Frequency (MHz)	Reading (dBuV)	C.F (dB/m)	Measurement (dBuV/m)	Margin (dB)	Limit (dBuV/m)	Height (cm)	Angle (deg)	Remark (QP/PK/AV)
1	2479.870	118.89	-5.10	113.79	N/A	N/A	236	226	Peak
2	2483.500	71.00	-5.10	65.91	-8.09	74.00	236	226	Peak
3	* 2485.660	76.12	-5.10	71.03	-2.97	74.00	236	226	Peak

Note:

1. " *" , means this data is the worst emission level.
2. C.F (Correction Factor) = Antenna Factor (dB/m)+ Cable Loss (dB) – Preamplifier(dB).
3. Measurement (dBuV/m) = Reading(dBuV) + C.F (Correction Factor).
4. The emission levels of other frequencies are very lower than the limit and not show in test report.

EUT	AX3000 Ceiling Mount Wi-Fi 6 Access Point	Date of Test	2024-02-20
Factor	DRH18-E	Temp. / Humidity	22°C /61%
Polarity	Horizontal	Site / Test Engineer	AC2 / Marvin
Test Mode	BLE_TX_1Mbps_CH 39	Test Voltage	AC 120V/60Hz

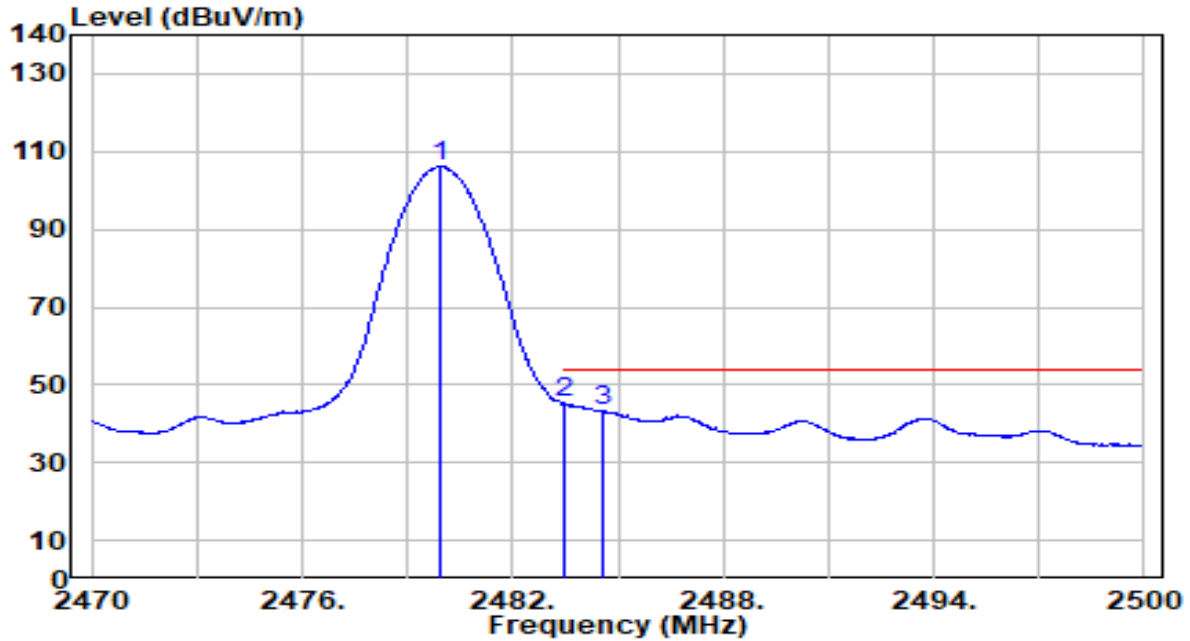

No	Frequency (MHz)	Reading (dBuV)	C.F (dB/m)	Measurement (dBuV/m)	Margin (dB)	Limit (dBuV/m)	Height (cm)	Angle (deg)	Remark (QP/PK/AV)
1	2479.930	111.14	-5.10	106.04	N/A	N/A	236	226	Average
2	* 2483.500	50.37	-5.10	45.28	-8.72	54.00	236	226	Average
3	2484.580	48.50	-5.10	43.41	-10.59	54.00	236	226	Average

Note:

1. " *", means this data is the worst emission level.
2. C.F (Correction Factor) = Antenna Factor (dB/m)+ Cable Loss (dB) – Preamplifier(dB).
3. Measurement (dBuV/m) = Reading(dBuV) + C.F (Correction Factor).
4. The emission levels of other frequencies are very lower than the limit and not show in test report.

EUT	AX3000 Ceiling Mount Wi-Fi 6 Access Point	Date of Test	2024-02-20
Factor	DRH18-E	Temp. / Humidity	22°C /61%
Polarity	Vertical	Site / Test Engineer	AC2 / Marvin
Test Mode	BLE_TX_1Mbps_CH 39	Test Voltage	AC 120V/60Hz

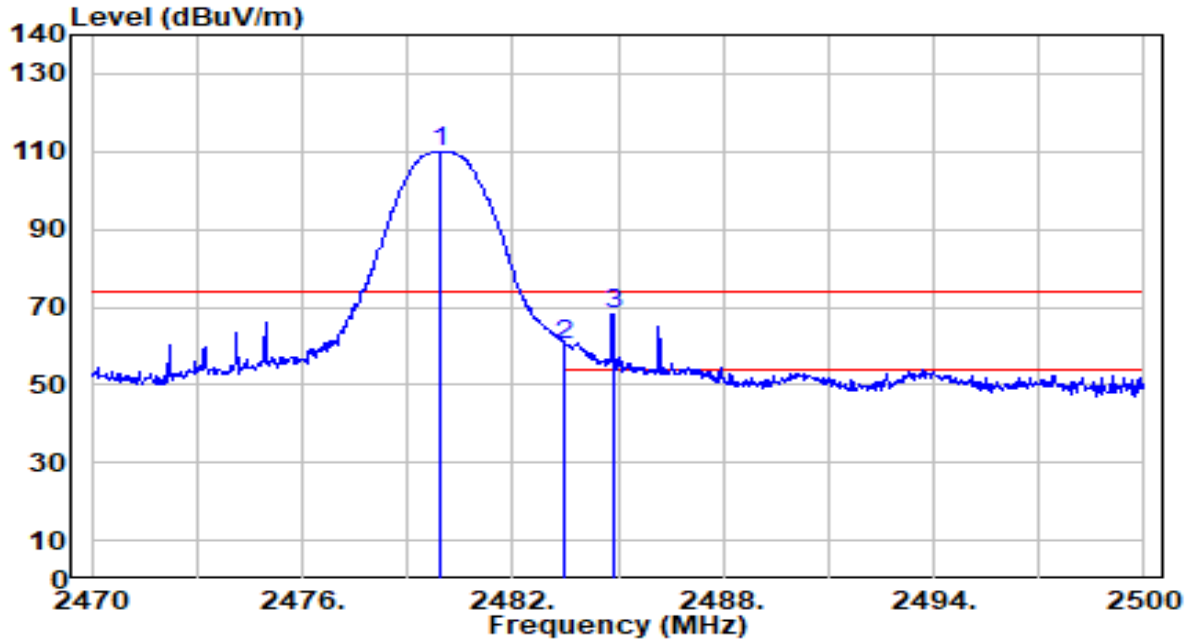

No	Frequency (MHz)	Reading (dBuV)	C.F (dB/m)	Measurement (dBuV/m)	Margin (dB)	Limit (dBuV/m)	Height (cm)	Angle (deg)	Remark (QP/PK/AV)
1	2479.930	114.80	-5.10	109.70	N/A	N/A	321	193	Peak
2	2483.500	65.45	-5.10	60.35	-13.65	74.00	321	193	Peak
3	* 2484.850	73.50	-5.10	68.40	-5.60	74.00	321	193	Peak

Note:

1. " *" , means this data is the worst emission level.
2. C.F (Correction Factor) = Antenna Factor (dB/m)+ Cable Loss (dB) – Preamplifier(dB).
3. Measurement (dBuV/m) = Reading(dBuV) + C.F (Correction Factor).
4. The emission levels of other frequencies are very lower than the limit and not show in test report.

EUT	AX3000 Ceiling Mount Wi-Fi 6 Access Point	Date of Test	2024-02-20
Factor	DRH18-E	Temp. / Humidity	22°C /61%
Polarity	Vertical	Site / Test Engineer	AC2 / Marvin
Test Mode	BLE_TX_1Mbps_CH 39	Test Voltage	AC 120V/60Hz

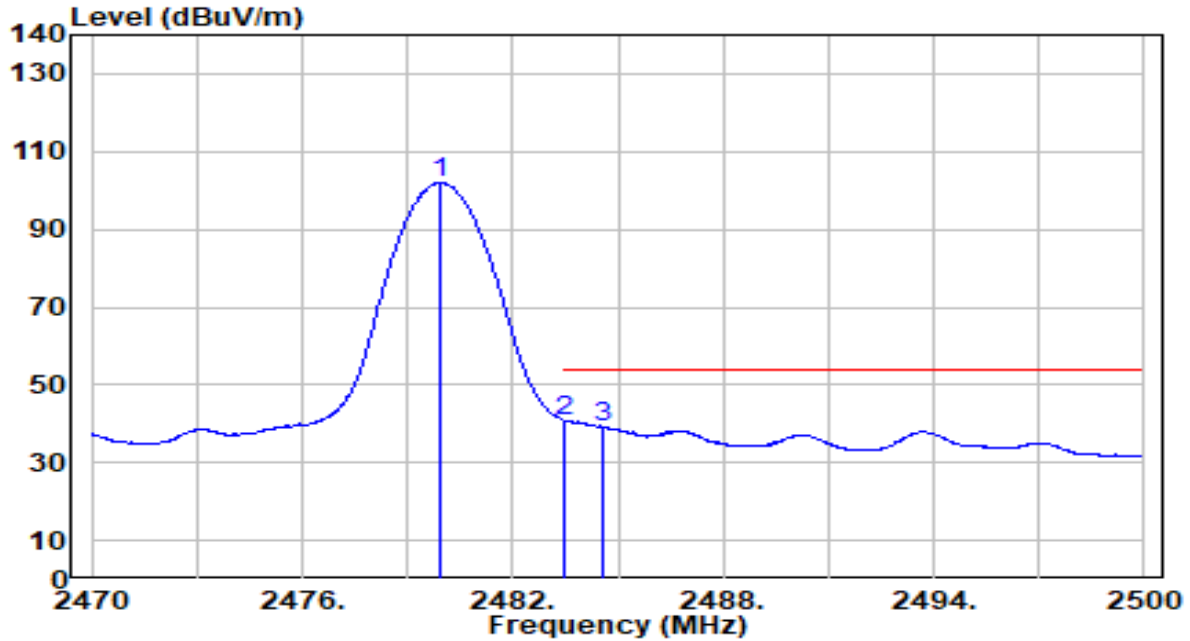

No	Frequency (MHz)	Reading (dBuV)	C.F (dB/m)	Measurement (dBuV/m)	Margin (dB)	Limit (dBuV/m)	Height (cm)	Angle (deg)	Remark (QP/PK/AV)
1	2479.960	107.06	-5.10	101.96	N/A	N/A	321	193	Average
2	* 2483.500	45.88	-5.10	40.78	-13.22	54.00	321	193	Average
3	2484.550	44.24	-5.10	39.14	-14.86	54.00	321	193	Average

Note:

1. " *" , means this data is the worst emission level.
2. C.F (Correction Factor) = Antenna Factor (dB/m)+ Cable Loss (dB) – Preamplifier(dB).
3. Measurement (dBuV/m) = Reading(dBuV) + C.F (Correction Factor).
4. The emission levels of other frequencies are very lower than the limit and not show in test report.

7.8. AC Conducted Emissions Measurement

7.8.1. Test Limit

FCC Part 15 Subpart C Paragraph 15.207 / RSS-Gen Limits		
Frequency (MHz)	QP (dB μ V)	Average (dB μ V)
0.15 - 0.50	66 - 56	56 - 46
0.50 - 5.0	56	46
5.0 - 30	60	50

Note 1: The lower limit shall apply at the transition frequencies.

Note 2: The limit decreases linearly with the logarithm of the frequency in the range 0.15MHz to 0.5MHz.

7.8.2. Test Setup

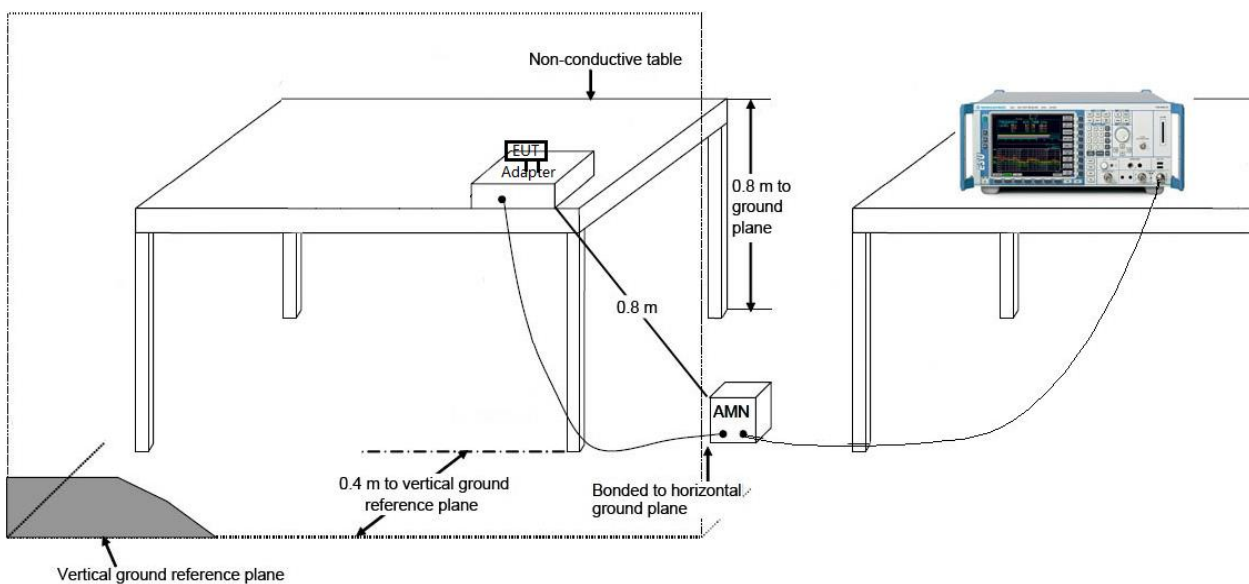

7.8.3. Test Result

EUT	AX3000 Ceiling Mount Wi-Fi 6 Access Point	Date of Test	2024-03-06
Factor	CE_ENV216-L1 (Filter ON)	Temp. / Humidity	23.5°C /60%
Polarity	Line1	Site / Test Engineer	SR2 / Bob
Test Mode	BLE_TX_1Mbps_CH 19	Test Voltage	AC 120V/60Hz

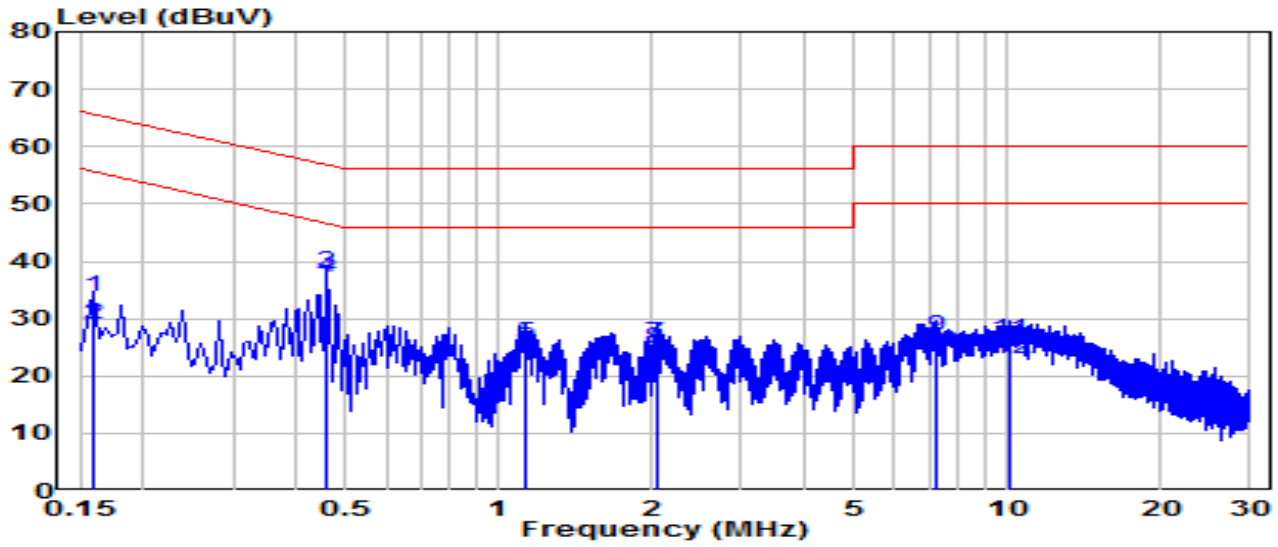

No	Frequency (MHz)	Reading (dBuV)	C.F (dB)	Measurement (dBuV)	Margin (dB)	Limit (dBuV)	Remark (QP/PK/AV)
1	0.159	24.10	9.62	33.73	-31.79	65.52	QP
2	0.159	19.24	9.62	28.86	-26.66	55.52	Average
3	* 0.460	28.27	9.64	37.90	-18.78	56.68	QP
4	* 0.460	27.60	9.64	37.24	-9.44	46.68	Average
5	1.135	15.91	9.67	25.58	-30.42	56.00	QP
6	1.135	14.44	9.67	24.12	-21.88	46.00	Average
7	2.035	16.11	9.69	25.80	-30.20	56.00	QP
8	2.035	14.98	9.69	24.67	-21.33	46.00	Average
9	7.214	17.21	9.80	27.00	-33.00	60.00	QP
10	7.214	14.48	9.80	24.27	-25.73	50.00	Average
11	10.108	16.41	9.86	26.27	-33.73	60.00	QP
12	10.108	13.15	9.86	23.01	-26.99	50.00	Average

Note:

1. " *", means this data is the worst emission level.
2. C.F (Correction Factor) = LISN Factor (dB)+ Cable Loss (dB).
3. Measurement (dBuV) = Reading(dBuV) + C.F (Correction Factor).

EUT	AX3000 Ceiling Mount Wi-Fi 6 Access Point	Date of Test	2024-03-06
Factor	CE_ENV216-N (Filter ON)	Temp. / Humidity	23.5°C /60%
Polarity	Neutral	Site / Test Engineer	SR2 / Bob
Test Mode	BLE_TX_1Mbps_CH 19	Test Voltage	AC 120V/60Hz

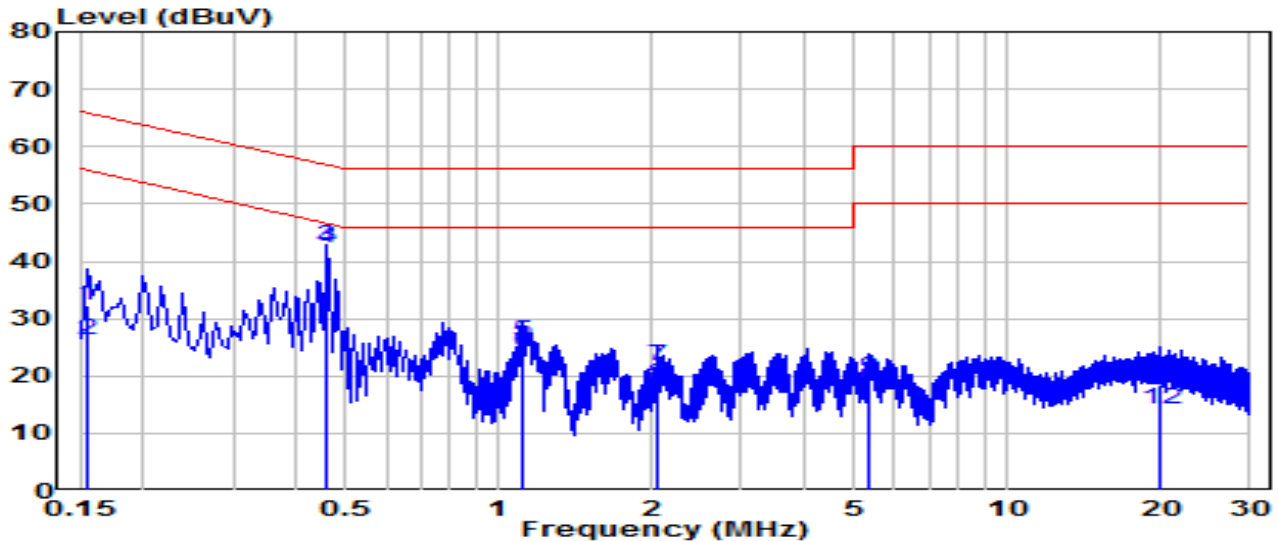

No	Frequency (MHz)	Reading (dBuV)	C.F (dB)	Measurement (dBuV)	Margin (dB)	Limit (dBuV)	Remark (QP/PK/AV)
1	0.154	22.80	9.62	32.42	-33.33	65.75	QP
2	0.154	16.55	9.62	26.17	-29.58	55.75	Average
3	* 0.460	32.78	9.64	42.42	-14.26	56.68	QP
4	* 0.460	32.77	9.64	42.41	-4.28	46.68	Average
5	1.117	16.27	9.67	25.94	-30.06	56.00	QP
6	1.117	14.41	9.67	24.08	-21.92	46.00	Average
7	2.053	11.94	9.69	21.63	-34.37	56.00	QP
8	2.053	8.84	9.69	18.54	-27.46	46.00	Average
9	5.333	9.75	9.75	19.50	-40.50	60.00	QP
10	5.333	7.46	9.75	17.21	-32.79	50.00	Average
11	20.029	8.34	10.00	18.34	-41.66	60.00	QP
12	20.029	4.19	10.00	14.19	-35.81	50.00	Average

Note:

1. " *", means this data is the worst emission level.
2. C.F (Correction Factor) = LISN Factor (dB)+ Cable Loss (dB).
3. Measurement (dBuV) = Reading(dBuV) + C.F (Correction Factor).

EUT	AX3000 Ceiling Mount Wi-Fi 6 Access Point	Date of Test	2024-03-06
Factor	CE_ENV216-L1 (Filter ON)	Temp. / Humidity	23.5°C /60%
Polarity	Line1	Site / Test Engineer	SR2 / Bob
Test Mode	BLE_TX_1Mbps_CH 19	Test Voltage	AC 240V/60Hz

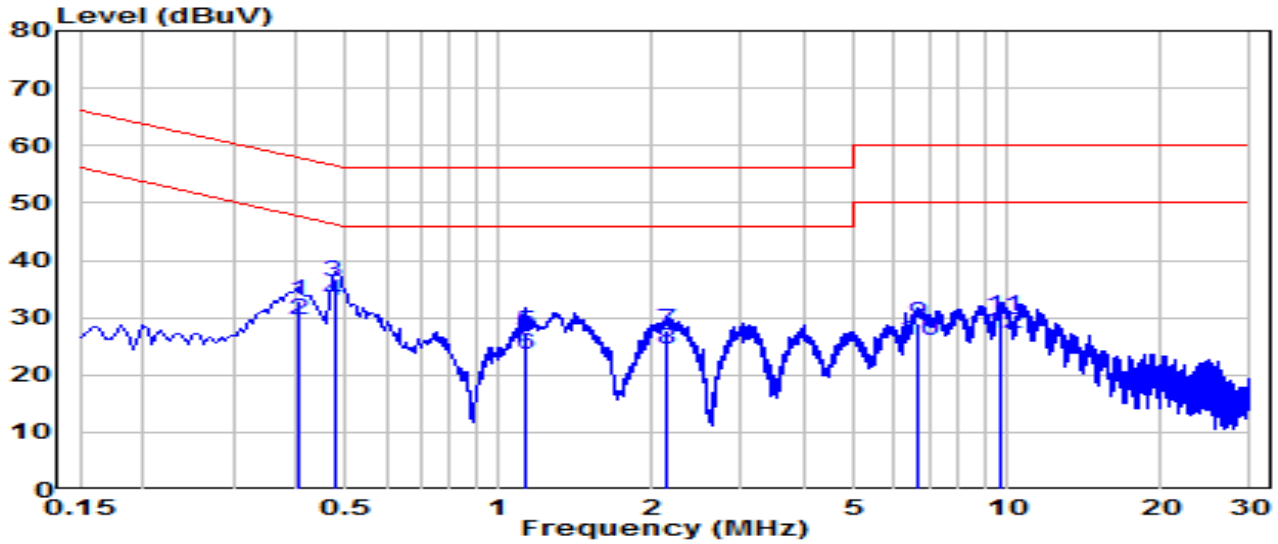

No	Frequency (MHz)	Reading (dBuV)	C.F (dB)	Measurement (dBuV)	Margin (dB)	Limit (dBuV)	Remark (QP/PK/AV)
1	0.402	23.36	9.63	32.99	-24.82	57.81	QP
2	0.402	19.94	9.63	29.57	-18.24	47.81	Average
3	* 0.474	26.64	9.64	36.28	-20.16	56.44	QP
4	* 0.474	23.19	9.64	32.83	-13.62	46.44	Average
5	1.135	17.70	9.67	27.37	-28.63	56.00	QP
6	1.135	14.01	9.67	23.68	-22.32	46.00	Average
7	2.148	17.96	9.69	27.65	-28.35	56.00	QP
8	2.148	14.91	9.69	24.60	-21.40	46.00	Average
9	6.647	19.25	9.78	29.03	-30.97	60.00	QP
10	6.647	16.12	9.78	25.90	-24.10	50.00	Average
11	9.752	20.45	9.85	30.31	-29.69	60.00	QP
12	9.752	17.23	9.85	27.08	-22.92	50.00	Average

Note:

- " *", means this data is the worst emission level.
- C.F (Correction Factor) = LISN Factor (dB)+ Cable Loss (dB).
- Measurement (dBuV) = Reading(dBuV) + C.F (Correction Factor).

EUT	AX3000 Ceiling Mount Wi-Fi 6 Access Point	Date of Test	2024-03-06
Factor	CE_ENV216-N (Filter ON)	Temp. / Humidity	23.5°C /60%
Polarity	Neutral	Site / Test Engineer	SR2 / Bob
Test Mode	BLE_TX_1Mbps_CH 19	Test Voltage	AC 240V/60Hz

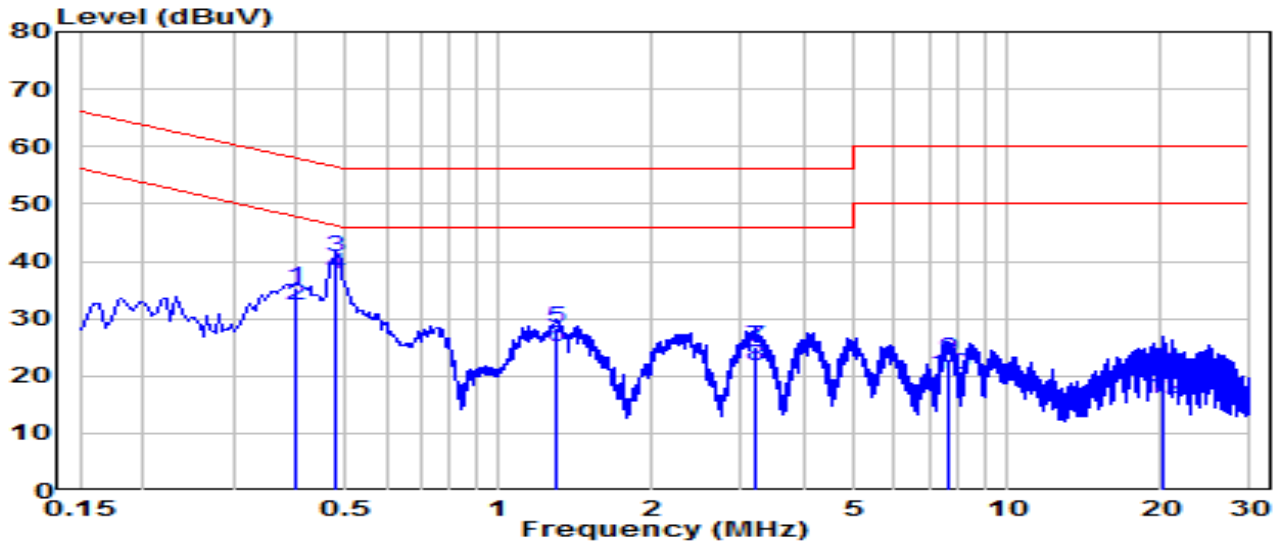

No	Frequency (MHz)	Reading (dBUV)	C.F (dB)	Measurement (dBUV)	Margin (dB)	Limit (dBUV)	Remark (QP/PK/AV)
1	0.397	25.82	9.63	35.45	-22.46	57.91	QP
2	0.397	22.69	9.63	32.32	-15.58	47.91	Average
3	* 0.478	31.26	9.64	40.90	-15.46	56.37	QP
4	* 0.478	27.96	9.64	37.60	-8.77	46.37	Average
5	1.293	18.69	9.68	28.37	-27.63	56.00	QP
6	1.293	15.27	9.68	24.95	-21.05	46.00	Average
7	3.187	15.23	9.71	24.94	-31.06	56.00	QP
8	3.187	11.96	9.71	21.67	-24.33	46.00	Average
9	7.687	13.07	9.81	22.89	-37.11	60.00	QP
10	7.687	10.31	9.81	20.12	-29.88	50.00	Average
11	20.155	10.87	10.00	20.87	-39.13	60.00	QP
12	20.155	6.04	10.00	16.04	-33.96	50.00	Average

Note:

1. " *", means this data is the worst emission level.
2. C.F (Correction Factor) = LISN Factor (dB)+ Cable Loss (dB).
3. Measurement (dBUV) = Reading(dBUV) + C.F (Correction Factor).

8. CONCLUSION

The data collected relate only the item(s) tested and show that the **AX3000 Ceiling Mount Wi-Fi 6 Access Point** is in compliance with Part 15C of the FCC Rules.

Appendix A : Test Photograph

Refer to “2402TW0104-UT” file.

Appendix B : External Photograph

Refer to “2402TW0104-UE” file.

Appendix C : Internal Photograph

Refer to “2402TW0104-UI” file.

————— The End —————