



FCC Radio Test Report

FCC ID: 2BCGWEAP615GPW

This report concerns: Original Grant

Project No. : 2312G170
Equipment : AX1800 Wall Plate Wi-Fi 6 GPON Access Point
Brand Name : tp-link
Test Model : EAP615GP-Wall
Series Model : N/A
Applicant : TP-LINK CORPORATION PTE. LTD.
Address : 7 Temasek Boulevard #29-03 Suntec Tower One, Singapore 038987
Manufacturer : TP-LINK CORPORATION PTE. LTD.
Address : 7 Temasek Boulevard #29-03 Suntec Tower One, Singapore 038987
Date of Receipt : Dec. 20, 2023
Date of Test : Dec. 21, 2023 ~ Jan. 20, 2024
Issued Date : Feb. 02, 2024
Report Version : R00
Test Sample : Engineering Sample No.: SSL2023122074 for conducted and power, SSL2023122075 for others.
Standard(s) : FCC CFR Title 47, Part 15, Subpart C

The above equipment has been tested and found compliance with the requirement of the relative standards by BTL Inc.

Prepared by : Nick Chen
Nick Chen

Approved by : Welly Zhou
Welly Zhou

Room 108, Building 2, No. 1, Yile Road, Songshan Lake Zone, Dongguan City, Guangdong
523000 China

Tel: +86-769-8318-3000 Web: www.newbtl.com Service mail: btl_qa@newbtl.com

Declaration

BTL represents to the client that testing is done in accordance with standard procedures as applicable and that test instruments used has been calibrated with standards traceable to international standard(s) and/or national standard(s).

BTL's reports apply only to the specific samples tested under conditions. It is manufacture's responsibility to ensure that additional production units of this model are manufactured with the identical electrical and mechanical components. **BTL** shall have no liability for any declarations, inferences or generalizations drawn by the client or others from **BTL** issued reports.

The report must not be used by the client to claim product certification, approval, or endorsement by NVLAP, NIST, or any agency of the U.S. Government.

This report is the confidential property of the client. As a mutual protection to the clients, the public and ourselves, the test report shall not be reproduced, except in full, without our written approval.

BTL's laboratory quality assurance procedures are in compliance with the ISO/IEC 17025: 2017 requirements, and accredited by the conformity assessment authorities listed in this test report.

BTL is not responsible for the sampling stage, so the results only apply to the sample as received.

The information, data and test plan are provided by manufacturer which may affect the validity of results, so it is manufacturer's responsibility to ensure that the apparatus meets the essential requirements of applied standards and in all the possible configurations as representative of its intended use.

Limitation

For the use of the authority's logo is limited unless the Test Standard(s)/Scope(s)/Item(s) mentioned in this test report is (are) included in the conformity assessment authorities acceptance respective.

Please note that the measurement uncertainty is provided for informational purpose only and are not use in determining the Pass/Fail results.

Table of Contents	Page
REPORT ISSUED HISTORY	6
1 . APPLICABLE STANDARDS	7
2 . SUMMARY OF TEST RESULTS	7
2.1 TEST FACILITY	8
2.2 MEASUREMENT UNCERTAINTY	8
2.3 TEST ENVIRONMENT CONDITIONS	9
3 . GENERAL INFORMATION	10
3.1 GENERAL DESCRIPTION OF EUT	10
3.2 DESCRIPTION OF TEST MODES	12
3.3 PARAMETERS OF TEST SOFTWARE	15
3.4 DUTY CYCLE	16
3.5 BLOCK DIAGRAM SHOWING THE CONFIGURATION OF SYSTEM TESTED	18
3.6 SUPPORT UNITS	18
4 . AC POWER LINE CONDUCTED EMISSIONS	19
4.1 LIMIT	19
4.2 TEST PROCEDURE	19
4.3 DEVIATION FROM TEST STANDARD	19
4.4 TEST SETUP	20
4.5 EUT OPERATION CONDITIONS	20
4.6 TEST RESULTS	20
5 . RADIATED EMISSIONS	21
5.1 LIMIT	21
5.2 TEST PROCEDURE	22
5.3 DEVIATION FROM TEST STANDARD	23
5.4 TEST SETUP	23
5.5 EUT OPERATION CONDITIONS	24
5.6 TEST RESULTS - 9 KHZ TO 30 MHZ	24
5.7 TEST RESULTS - 30 MHZ TO 1000 MHZ	24
5.8 TEST RESULTS - ABOVE 1000 MHZ	24
6 . BANDWIDTH	25
6.1 LIMIT	25
6.2 TEST PROCEDURE	25
6.3 DEVIATION FROM STANDARD	25

Table of Contents	Page
6.4 TEST SETUP	25
6.5 EUT OPERATION CONDITIONS	25
6.6 TEST RESULTS	25
7 . MAXIMUM OUTPUT POWER	26
7.1 LIMIT	26
7.2 TEST PROCEDURE	26
7.3 DEVIATION FROM STANDARD	26
7.4 TEST SETUP	26
7.5 EUT OPERATION CONDITIONS	26
7.6 TEST RESULTS	26
8 . CONDUCTED SPURIOUS EMISSIONS	27
8.1 LIMIT	27
8.2 TEST PROCEDURE	27
8.3 DEVIATION FROM STANDARD	27
8.4 TEST SETUP	27
8.5 EUT OPERATION CONDITIONS	27
8.6 TEST RESULTS	27
9 . POWER SPECTRAL DENSITY	28
9.1 LIMIT	28
9.2 TEST PROCEDURE	28
9.3 DEVIATION FROM STANDARD	28
9.4 TEST SETUP	28
9.5 EUT OPERATION CONDITIONS	28
9.6 TEST RESULTS	28
10 . MEASUREMENT INSTRUMENTS LIST	29
11 . EUT TEST PHOTO	31
APPENDIX A - AC POWER LINE CONDUCTED EMISSIONS	36
APPENDIX B - RADIATED EMISSION - 9 KHZ TO 30 MHZ	39
APPENDIX C - RADIATED EMISSION - 30 MHZ TO 1000 MHZ	44
APPENDIX D - RADIATED EMISSION- ABOVE 1000 MHZ	47
APPENDIX E - BANDWIDTH	108
APPENDIX F - MAXIMUM OUTPUT POWER	115

Table of Contents**Page****APPENDIX G - CONDUCTED SPURIOUS EMISSIONS****126****APPENDIX H - POWER SPECTRAL DENSITY****139**

REPORT ISSUED HISTORY

Report No.	Version	Description	Issued Date	Note
BTL-FCCP-1-2312G170	R00	Original Report.	Feb. 02, 2024	Valid

1. APPLICABLE STANDARDS

According to the specifications of the manufacturer, the EUT must comply with the requirements of the following standards:

ANSI C63.10-2013

The following reference test guidance is not within the scope of accreditation of NVLAP:

KDB 558074 D01 15.247 Meas Guidance v05r02

KDB 662911 D01 Multiple Transmitter Output v02r01

2. SUMMARY OF TEST RESULTS

Test procedures according to the technical standard(s):

FCC CFR Title 47, Part 15, Subpart C				
Standard(s) Section	Test Item	Test Result	Judgment	Remark
15.207	AC Power Line Conducted Emissions	APPENDIX A	PASS	-----
15.247(d) 15.205(a) 15.209(a)	Radiated Emissions	APPENDIX B APPENDIX C APPENDIX D	PASS	-----
15.247(a)(2)	Bandwidth	APPENDIX E	PASS	-----
15.247(b)(3)	Maximum Output Power	APPENDIX F	PASS	-----
15.247(d)	Conducted Spurious Emissions	APPENDIX G	PASS	-----
15.247(e)	Power Spectral Density	APPENDIX H	PASS	-----
15.203	Antenna Requirement	-----	PASS	Note(2)

Note:

(1) "N/A" denotes test is not applicable in this test report.

(2) The device what use a permanently attached antenna were considered sufficient to comply with the provisions of 15.203.

2.1 TEST FACILITY

The test facilities used to collect the test data in this report is at the location of No. 3 Jinshagang 1st Rd. Shixia, Dalang Town, Dongguan City, Guangdong 523792.

BTL's Registration Number for FCC: 162128

BTL's Designation Number for FCC: CN5042

2.2 MEASUREMENT UNCERTAINTY

ISO/IEC 17025 requires that an estimate of the measurement uncertainties associated with the emissions test results be included in the report. The measurement uncertainties given below are based on a 95% confidence level (based on a coverage factor (k=2))

The BTL measurement uncertainty as below table:

A. AC power line conducted emissions test:

Test Site	Method	Measurement Frequency Range	U,(dB)
DG-C02	CISPR	150kHz ~ 30MHz	2.88

B. Radiated emissions test:

Test Site	Method	Measurement Frequency Range	U,(dB)
DG-CB01	CISPR	9kHz ~ 30MHz	2.36

Test Site	Method	Measurement Frequency Range	Ant. H / V	U,(dB)
DG-CB03 (3m)	CISPR	30MHz ~ 200MHz	V	4.40
		30MHz ~ 200MHz	H	3.62
		200MHz ~ 1,000MHz	V	4.58
		200MHz ~ 1,000MHz	H	3.98

Test Site	Method	Measurement Frequency Range	U,(dB)
DG-CB03 (3m)	CISPR	1GHz ~ 6GHz	4.08
		6GHz ~ 18GHz	4.62

Test Site	Method	Measurement Frequency Range	U,(dB)
DG-CB03 (1m)	CISPR	18 ~ 26.5 GHz	3.36
		26.5 ~ 40 GHz	3.58

C. Other Measurement:

Test Item	Uncertainty
Bandwidth	0.90 %
Maximum Output Power	1.3 dB
Conducted Spurious Emission	1.9 dB
Power Spectral Density	1.4 dB
Temperature	0.8 °C
Humidity	2.2 %

Note: Unless specifically mentioned, the uncertainty of measurement has not been taken into account to declare the compliance or non-compliance to the specification.

2.3 TEST ENVIRONMENT CONDITIONS

Test Item	Temperature	Humidity	Test Voltage	Tested By
AC Power Line Conducted Emissions	22°C	53%	AC 120V/60Hz	Hayden Chen
Radiated Emissions-9kHz to 30 MHz	20°C	51%	AC 120V/60Hz	Hayden Chen
Radiated Emissions-30MHz to 1000MHz	22°C	41%	AC 120V/60Hz	Max Wang
Radiated Emissions-Above 1000MHz	21°C	41%	AC 120V/60Hz	Chen Mo
Bandwidth	24°C	49%	AC 120V/60Hz	Steve Zhou
Maximum Output Power	20°C	49%	AC 120V/60Hz	Oliver Wang Complex Qin
Conducted Spurious Emissions	24°C	49%	AC 120V/60Hz	Steve Zhou
Power Spectral Density	25°C	50%	AC 120V/60Hz	Steve Zhou

3. GENERAL INFORMATION

3.1 GENERAL DESCRIPTION OF EUT

Equipment	AX1800 Wall Plate Wi-Fi 6 GPON Access Point
Brand Name	tp-link
Test Model	EAP615GP-Wall
Series Model	N/A
Model Difference(s)	N/A
Software Version	1.0.0 Build 20231212 Rel. 58299
Hardware Version	1.0
Power Source	AC Mains.
Power Rating	100-240V ~ 50/60Hz 0.5A
Operation Frequency	2412 MHz ~ 2462 MHz
Modulation Type	IEEE 802.11b: DSSS IEEE 802.11g: OFDM IEEE 802.11n: OFDM IEEE 802.11ax: OFDMA
Bit Rate of Transmitter	IEEE 802.11b: 11/5.5/2/1 Mbps IEEE 802.11g: 54/48/36/24/18/12/9/6 Mbps IEEE 802.11n: up to 300 Mbps IEEE 802.11ax: up to 573.6 Mbps
Maximum Output Power Non Beamforming	IEEE 802.11g: 23.02 dBm (0.2004 W)
Maximum Output Power Beamforming	IEEE 802.11n(HT20): 22.33 dBm (0.1710 W)

Note:

1. For a more detailed features description, please refer to the manufacturer's specifications or the user's manual.

2. Channel List:

CH01 - CH11 for IEEE 802.11b, IEEE 802.11g, IEEE 802.11n(HT20), IEEE 802.11ax(HE20) CH03 - CH09 for IEEE 802.11n(HT40), IEEE 802.11ax(HE40)							
Channel	Frequency (MHz)	Channel	Frequency (MHz)	Channel	Frequency (MHz)	Channel	Frequency (MHz)
01	2412	04	2427	07	2442	10	2457
02	2417	05	2432	08	2447	11	2462
03	2422	06	2437	09	2452		

3. Antenna Specification:

Ant.	Brand	Model Name	Antenna Type	Connector	Gain (dBi)
1	BIG FIELD GLOBAL PTE. LTD	EAP615GP-Wall	PIFA	N/A	3
2	BIG FIELD GLOBAL PTE. LTD	EAP615GP-Wall	PIFA	N/A	3

Note:

- This EUT supports CDD, and all antennas have the same gain, Directional gain = $G_{ANT} + \text{Array Gain}$. For power measurements, Array Gain=0dB ($N_{ANT} \leq 4$), so the Directional gain=3. For power spectral density measurements, $N_{ANT}=2$, $N_{SS} = 1$. So the Directional gain= $G_{ANT} + \text{Array Gain} = G_{ANT} + 10\log(N_{ANT}/N_{SS})\text{dBi} = 3 + 10\log(2/1)\text{dBi} = 6.01$. Then, the power spectral density limit is $8 - (6.01 - 6) = 7.99$.
- The beamforming gain is 3dB. So the Directional gain= $3 + 3 = 6$.
- The antenna gain and beamforming gain are provided by the manufacturer.

4. Table for Antenna Configuration:
 For Non Beamforming

Operating Mode	TX Mode	2TX
IEEE 802.11b		V(Ant. 1 + Ant. 2)
IEEE 802.11g		V(Ant. 1 + Ant. 2)
IEEE 802.11n(HT20)		V(Ant. 1 + Ant. 2)
IEEE 802.11n(HT40)		V(Ant. 1 + Ant. 2)
IEEE 802.11ax(HE20)		V(Ant. 1 + Ant. 2)
IEEE 802.11ax(HE40)		V(Ant. 1 + Ant. 2)

For Beamforming

Operating Mode	TX Mode	2TX
IEEE 802.11n(HT20)		V(Ant. 1 + Ant. 2)
IEEE 802.11n(HT40)		V(Ant. 1 + Ant. 2)
IEEE 802.11ax(HE20)		V(Ant. 1 + Ant. 2)
IEEE 802.11ax(HE40)		V(Ant. 1 + Ant. 2)

3.2 DESCRIPTION OF TEST MODES

The test system was pre-tested based on the consideration of all possible combinations of EUT operation mode.

Pretest Mode	Description
Mode 1	TX B Mode Channel 01/06/11
Mode 2	TX G Mode Channel 01/06/11
Mode 3	TX N(HT20) Mode Channel 01/06/11
Mode 4	TX N(HT40) Mode Channel 03/06/09
Mode 5	TX AX(HE20) Mode Channel 01/06/11
Mode 6	TX AX(HE40) Mode Channel 03/06/09
Mode 7	TX G Mode Channel 06
Mode 8	TX B Mode Channel 01/02/06/10/11
Mode 9	TX G Mode Channel 01/02/06/10/11
Mode 10	TX N(HT20) Mode Channel 01/02/06/10/11
Mode 11	TX N(HT40) Mode Channel 03/04/06/08/09
Mode 12	TX AX(HE20) Mode Channel 01/02/06/10/11
Mode 13	TX AX(HE40) Mode Channel 03/04/06/08/09

Following mode(s) was (were) found to be the worst case(s) and selected for the final test.

AC power line conducted emissions test	
Final Test Mode	Description
Mode 7	TX G Mode Channel 06

Radiated emissions test - Below 1GHz	
Final Test Mode	Description
Mode 7	TX G Mode Channel 06

Radiated emissions test- Above 1GHz_Non Beamforming

Final Test Mode	Description
Mode 8	TX B Mode Channel 01/02/06/10/11
Mode 9	TX G Mode Channel 01/02/06/10/11
Mode 10	TX N(HT20) Mode Channel 01/02/06/10/11
Mode 11	TX N(HT40) Mode Channel 03/04/06/08/09
Mode 12	TX AX(HE20) Mode Channel 01/02/06/10/11
Mode 13	TX AX(HE40) Mode Channel 03/04/06/08/09

Maximum output power test_Non Beamforming

Final Test Mode	Description
Mode 1	TX B Mode Channel 01/06/11
Mode 2	TX G Mode Channel 01/06/11
Mode 3	TX N(HT20) Mode Channel 01/06/11
Mode 4	TX N(HT40) Mode Channel 03/06/09
Mode 5	TX AX(HE20) Mode Channel 01/06/11
Mode 6	TX AX(HE40) Mode Channel 03/06/09

Maximum output power test_Beamforming

Final Test Mode	Description
Mode 3	TX N(HT20) Mode Channel 01/06/11
Mode 4	TX N(HT40) Mode Channel 03/06/09
Mode 5	TX AX(HE20) Mode Channel 01/06/11
Mode 6	TX AX(HE40) Mode Channel 03/06/09

Other Conducted test	
Final Test Mode	Description
Mode 1	TX B Mode Channel 01/06/11
Mode 2	TX G Mode Channel 01/06/11
Mode 3	TX N(HT20) Mode Channel 01/06/11
Mode 4	TX N(HT40) Mode Channel 03/06/09
Mode 5	TX AX(HE20) Mode Channel 01/06/11
Mode 6	TX AX(HE40) Mode Channel 03/06/09

NOTE:

- (1) All the bit rate of transmitter have been tested and found the lowest rate is found to be the worst case and recorded.
- (2) For AC power line conducted emissions and radiated emission below 1 GHz test, the TX G Mode Channel 06 is found to be the worst case and recorded.
- (3) For radiated emission above 1 GHz test, the spurious points of 1GHz~26.5GHz have been pre-tested and in this report only recorded the worst case. The remaining spurious points are all below the limit value of 20dB.
- (4) The measurements for Output Power are tested, the Non Beamforming and Beamforming are recorded in the report. The worst case is Non Beamforming and only the worst case is documented for other test items.
- (5) IEEE 802.11ax mode only supports full RU, so only the full RU is evaluated and measured inside report.
- (6) For radiated emission above 1 GHz harmonic test: The polarization of vertical and horizontal are evaluated, the worst case is horizontal and recorded.
For radiated emission above 1 GHz bandedge test: The polarization of vertical and horizontal are evaluated, the worst case is vertical and recorded.

3.3 PARAMETERS OF TEST SOFTWARE

Non Beamforming

Test Software Version	package_Ulv2.13_DLLv5.11_20191004-alpha-RSSI		
Frequency (MHz)	2412	2437	2462
IEEE 802.11b	19.5	19.5	19.5
IEEE 802.11g	17.5	19.5	17.5
IEEE 802.11n(HT20)	17.5	19.5	17
IEEE 802.11ax(HE20)	17	19.5	17
Frequency (MHz)	2422	2437	2452
IEEE 802.11n(HT40)	16	17.5	17
IEEE 802.11ax(HE40)	16.5	17	16

Beamforming

Test Software Version	package_Ulv2.13_DLLv5.11_20191004-alpha-RSSI		
Frequency (MHz)	2412	2437	2462
IEEE 802.11n(HT20)	17	19	16.5
IEEE 802.11ax(HE20)	16.5	19	16.5
Frequency (MHz)	2422	2437	2452
IEEE 802.11n(HT40)	15.5	17	16.5
IEEE 802.11ax(HE40)	16	16.5	15.5

3.4 DUTY CYCLE

If duty cycle is $\geq 98\%$, duty factor is not required.
 If duty cycle is $< 98\%$, duty factor shall be considered.
 The output power = measured power + duty factor.

IEEE 802.11b

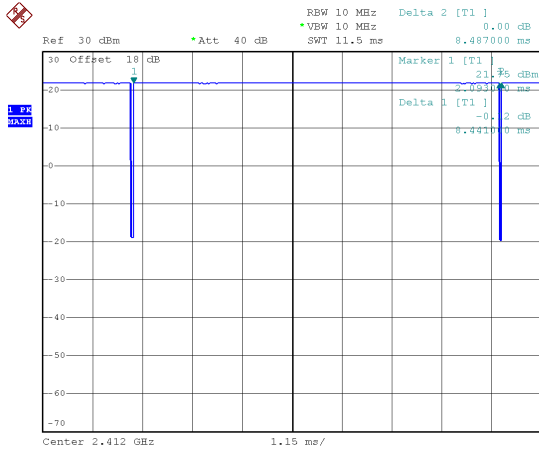

Date: 7.JAN.2024 07:54:56

Duty cycle = $8.441 \text{ ms} / 8.487 \text{ ms} = 99.46\%$
 Duty Factor = $10 \log(1/\text{Duty cycle}) = 0.00$

IEEE 802.11g

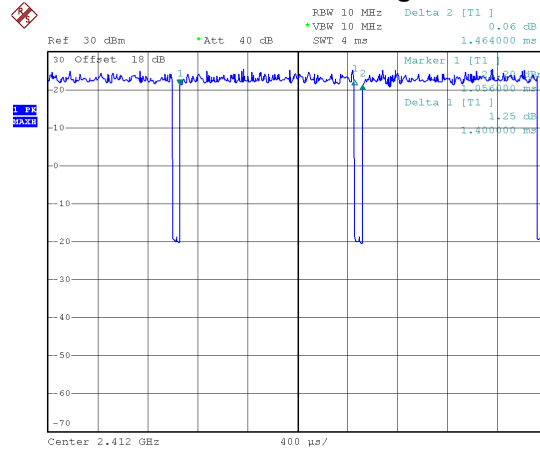

Date: 7.JAN.2024 07:57:00

Duty cycle = $1.400 \text{ ms} / 1.464 \text{ ms} = 95.63\%$
 Duty Factor = $10 \log(1/\text{Duty cycle}) = 0.19$

IEEE 802.11n(HT20)

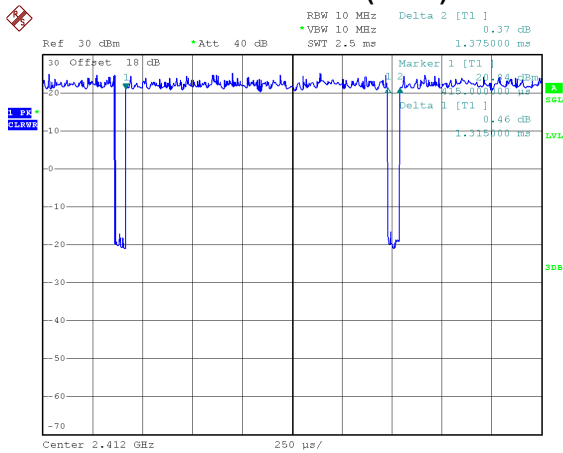

Date: 7.JAN.2024 08:03:41

Duty cycle = $1.315 \text{ ms} / 1.375 \text{ ms} = 95.64\%$
 Duty Factor = $10 \log(1/\text{Duty cycle}) = 0.19$

IEEE 802.11n(HT40)

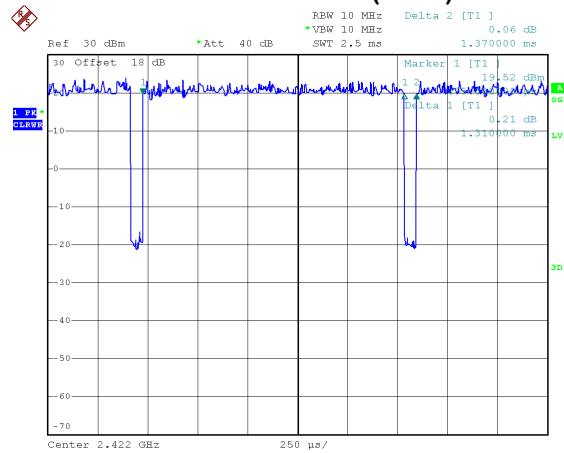

Date: 7.JAN.2024 08:06:02

Duty cycle = $1.310 \text{ ms} / 1.370 \text{ ms} = 95.62\%$
 Duty Factor = $10 \log(1/\text{Duty cycle}) = 0.19$

IEEE 802.11ax(HE20)

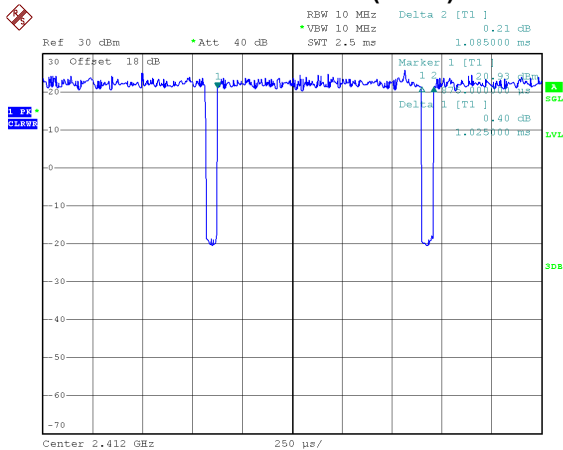

Date: 7.JAN.2024 08:04:22

Duty cycle = 1.025 ms / 1.085 ms = 94.47%
 Duty Factor = 10 log(1/Duty cycle) = 0.25

IEEE 802.11ax(HE40)

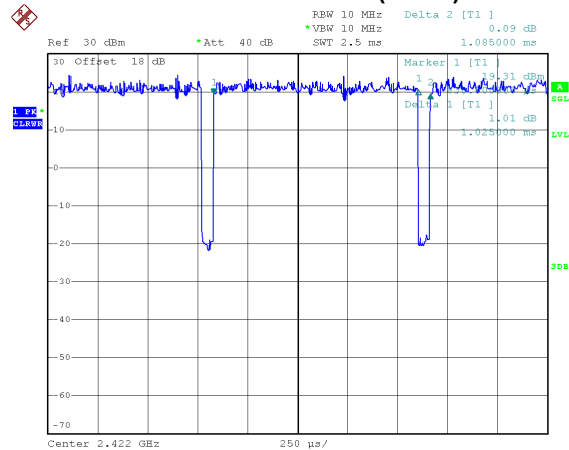

Date: 7.JAN.2024 08:05:32

Duty cycle = 1.025 ms / 1.085 ms = 94.47%
 Duty Factor = 10 log(1/Duty cycle) = 0.25

NOTE:

For IEEE 802.11b:

For radiated emissions frequency above 1 GHz, the resolution bandwidth of test receiver/spectrum analyzer is 1 MHz and the video bandwidth is 1 kHz.

For IEEE 802.11g:

For radiated emissions frequency above 1 GHz, the resolution bandwidth of test receiver/spectrum analyzer is 1 MHz and the video bandwidth is 714 Hz.

For IEEE 802.11n(HT20):

For radiated emissions frequency above 1 GHz, the resolution bandwidth of test receiver/spectrum analyzer is 1 MHz and the video bandwidth is 760 Hz.

For IEEE 802.11n(HT40):

For radiated emissions frequency above 1 GHz, the resolution bandwidth of test receiver/spectrum analyzer is 1 MHz and the video bandwidth is 763 Hz.

For IEEE 802.11ax(HE20):

For radiated emissions frequency above 1 GHz, the resolution bandwidth of test receiver/spectrum analyzer is 1 MHz and the video bandwidth is 976 Hz.

For IEEE 802.11ax(HE40):

For radiated emissions frequency above 1 GHz, the resolution bandwidth of test receiver/spectrum analyzer is 1 MHz and the video bandwidth is 976 Hz.

3.5 BLOCK DIAGRAM SHOWING THE CONFIGURATION OF SYSTEM TESTED

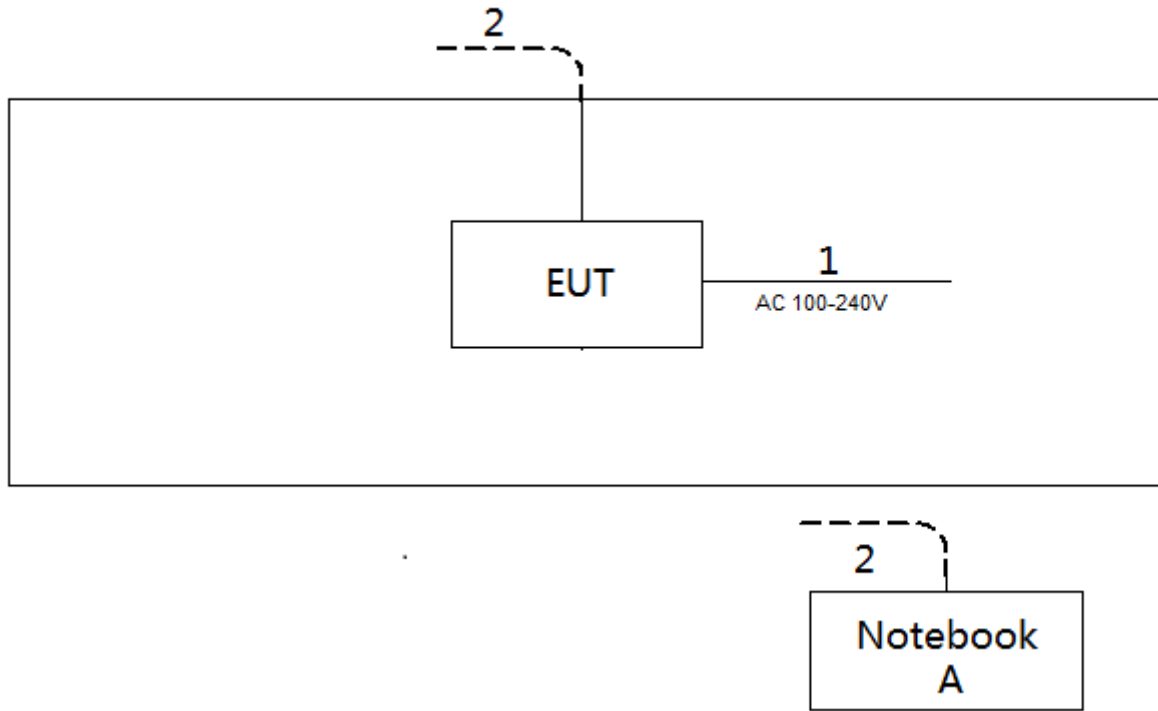

3.6 SUPPORT UNITS

Item	Equipment	Brand	Model No.	Series No.
A	Notebook	HONOR	NBLK-WAX9X	N/A

Item	Cable Type	Shielded Type	Ferrite Core	Length
1	AC Cable	NO	NO	1.5m
2	RJ45 Cable	NO	NO	10m

4. AC POWER LINE CONDUCTED EMISSIONS

4.1 LIMIT

Frequency of Emission (MHz)	Limit (dB μ V)	
	Quasi-peak	Average
0.15 - 0.5	66 to 56*	56 to 46*
0.5 - 5.0	56	46
5.0 - 30.0	60	50

NOTE:

- (1) The tighter limit applies at the band edges.
- (2) The limit of "*" marked band means the limitation decreases linearly with the logarithm of the frequency in the range.

4.2 TEST PROCEDURE

- a. The EUT was placed 0.8 meters from the horizontal ground plane with EUT being connected to the power mains through a line impedance stabilization network (LISN). All other support equipment powered from additional LISN(s). The LISN provide 50 Ohm/ 50uH of coupling impedance for the measuring instrument.
- b. Interconnecting cables that hang closer than 40 cm to the ground plane shall be folded back and forth in the center forming a bundle 30 to 40 cm long.
- c. I/O cables that are not connected to a peripheral shall be bundled in the center. The end of the cable may be terminated, if required, using the correct terminating impedance. The overall length shall not exceed 1 m.
- d. LISN at least 80 cm from nearest part of EUT chassis.
- e. For the actual test configuration, please refer to the related Item -EUT Test Photos.

The following table is the setting of the receiver:

Receiver Parameters	Setting
Start Frequency	0.15 MHz
Stop Frequency	30 MHz
IF Bandwidth	9 kHz

4.3 DEVIATION FROM TEST STANDARD

No deviation.

4.4 TEST SETUP

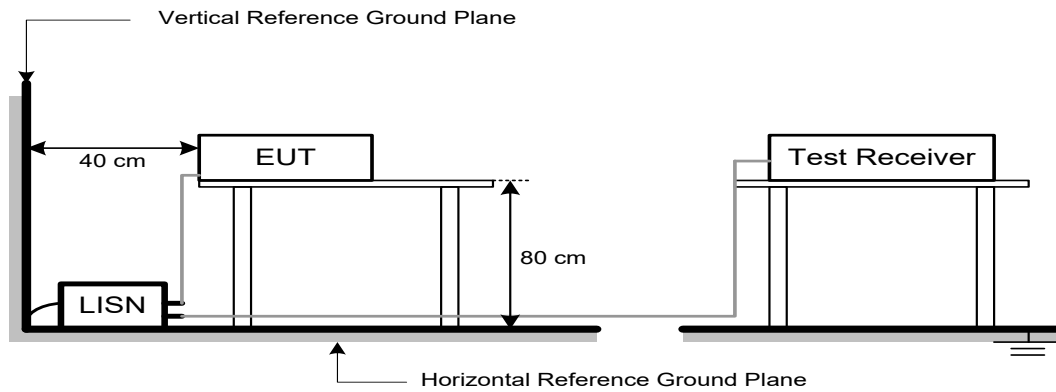

4.5 EUT OPERATION CONDITIONS

EUT was programmed to be in continuously transmitting mode.

4.6 TEST RESULTS

Please refer to the APPENDIX A.

5. RADIATED EMISSIONS

5.1 LIMIT

In case the emission fall within the restricted band specified on 15.205(a), then the 15.209(a) limit in the table below has to be followed.

LIMITS OF RADIATED EMISSION MEASUREMENT (9 kHz-1000 MHz)

Frequency (MHz)	Field Strength (microvolts/meter)	Measurement Distance (meters)
0.009-0.490	2400/F(kHz)	300
0.490-1.705	24000/F(kHz)	30
1.705-30.0	30	30
30-88	100	3
88-216	150	3
216-960	200	3
Above 960	500	3

LIMITS OF RADIATED EMISSION MEASUREMENT (Above 1000 MHz)

Frequency (MHz)	(dBuV/m at 3 m)	
	Peak	Average
Above 1000	74	54

NOTE:

- (1) The limit for radiated test was performed according to FCC CFR Title 47, Part 15, Subpart C.
- (2) The tighter limit applies at the band edges.
- (3) Emission level (dBuV/m)=20log Emission level (uV/m).

5.2 TEST PROCEDURE

- a. The measuring distance of 3 m shall be used for measurements. The EUT was placed on the top of a rotating table 0.8 meter above the ground at a 3 meter semi-anechoic chamber. The table was rotated 360 degrees to determine the position of the highest radiation.(below 1 GHz)
- b. The measuring distance of 3 m shall be used for measurements. The EUT was placed on the top of a rotating table 1.5 meter above the ground at a 3 meter semi-anechoic chamber. The table was rotated 360 degrees to determine the position of the highest radiation.(above 1 GHz)
- c. The height of the equipment or of the substitution antenna shall be 0.8m or 1.5m; the height of the test antenna shall vary between 1 m to 4 m. Both horizontal and vertical polarizations of the antenna are set to make the measurement.
- d. For each suspected emission, the EUT was arranged to its worst case and then the antenna was tuned to heights find the maximum reading (used Bore sight function).
- e. The receiver system was set to peak and average detect function and specified bandwidth with maximum hold mode when the test frequency is above 1 GHz.
- f. The initial step in collecting radiated emission data is a receiver peak detector mode pre-scanning the measurement frequency range. Significant peaks are then marked and then Quasi Peak detector mode re-measured.
- g. All readings are Peak unless otherwise stated QP in column of Note. Peak denotes that the Peak reading compliance with the QP Limits and then QP Mode measurement didn't perform. (below 1 GHz)
- h. All readings are Peak Mode value unless otherwise stated AVG in column of Note. If the Peak Mode Measured value compliance with the Peak Limits and lower than AVG Limits, the EUT shall be deemed to meet both Peak & AVG Limits and then only Peak Mode was measured, but AVG Mode didn't perform. (above 1 GHz)
- i. For the actual test configuration, please refer to the related Item -EUT Test Photos.

The following table is the setting of the receiver:

Spectrum Parameters	Setting
Start ~ Stop Frequency	9 kHz~150 kHz for RBW 200 Hz
Start ~ Stop Frequency	0.15 MHz~30 MHz for RBW 9 kHz
Start ~ Stop Frequency	30 MHz~1000 MHz for RBW 100 kHz

Spectrum Parameters	Setting
Start Frequency	1000 MHz
Stop Frequency	10th carrier harmonic
RBW / VBW (Emission in restricted band)	1 MHz / 3 MHz for PK value 1 MHz / 1/T Hz for AVG value

Receiver Parameters	Setting
Start ~ Stop Frequency	9 kHz~90 kHz for PK/AVG detector
Start ~ Stop Frequency	90 kHz~110 kHz for QP detector
Start ~ Stop Frequency	110 kHz~490 kHz for PK/AVG detector
Start ~ Stop Frequency	490 kHz~30 MHz for QP detector
Start ~ Stop Frequency	30 MHz~1000 MHz for QP detector
Start ~ Stop Frequency	1 GHz~26.5 GHz for PK/AVG detector

5.3 DEVIATION FROM TEST STANDARD

No deviation.

5.4 TEST SETUP

9 kHz to 30 MHz

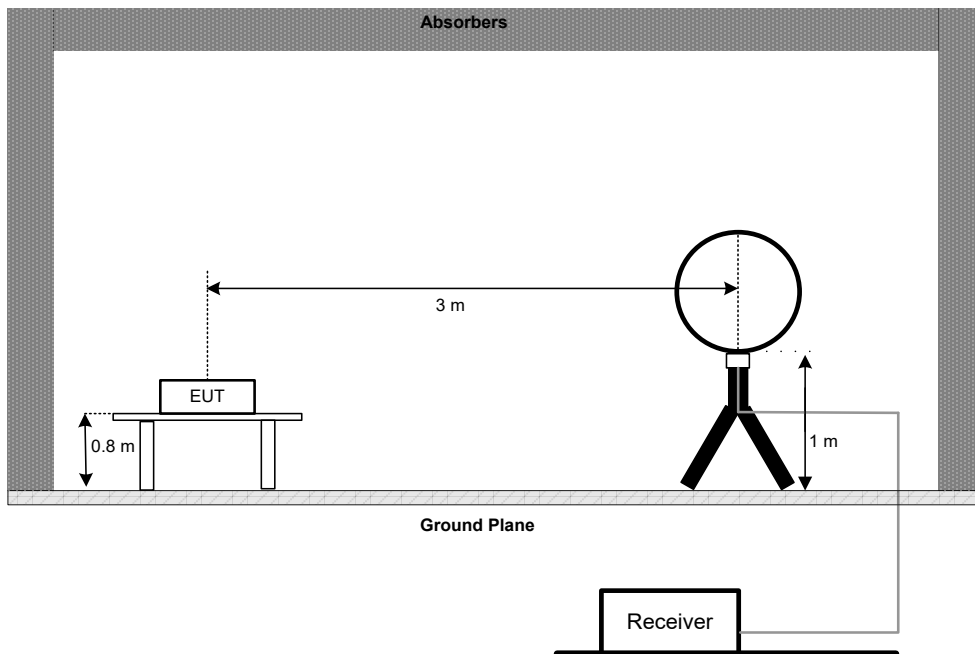

30 MHz to 1 GHz

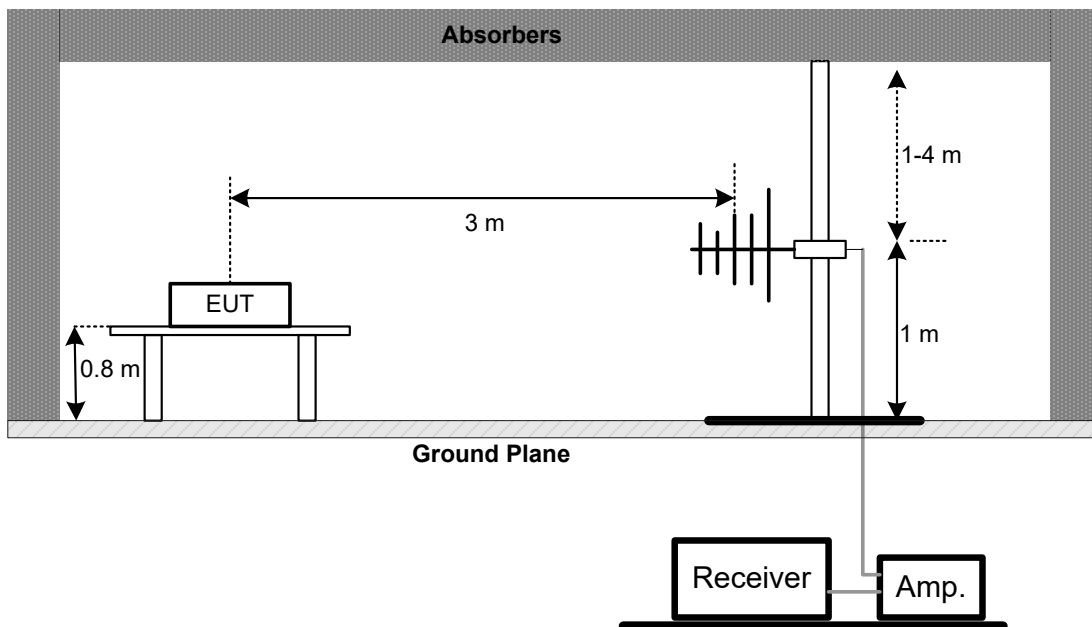

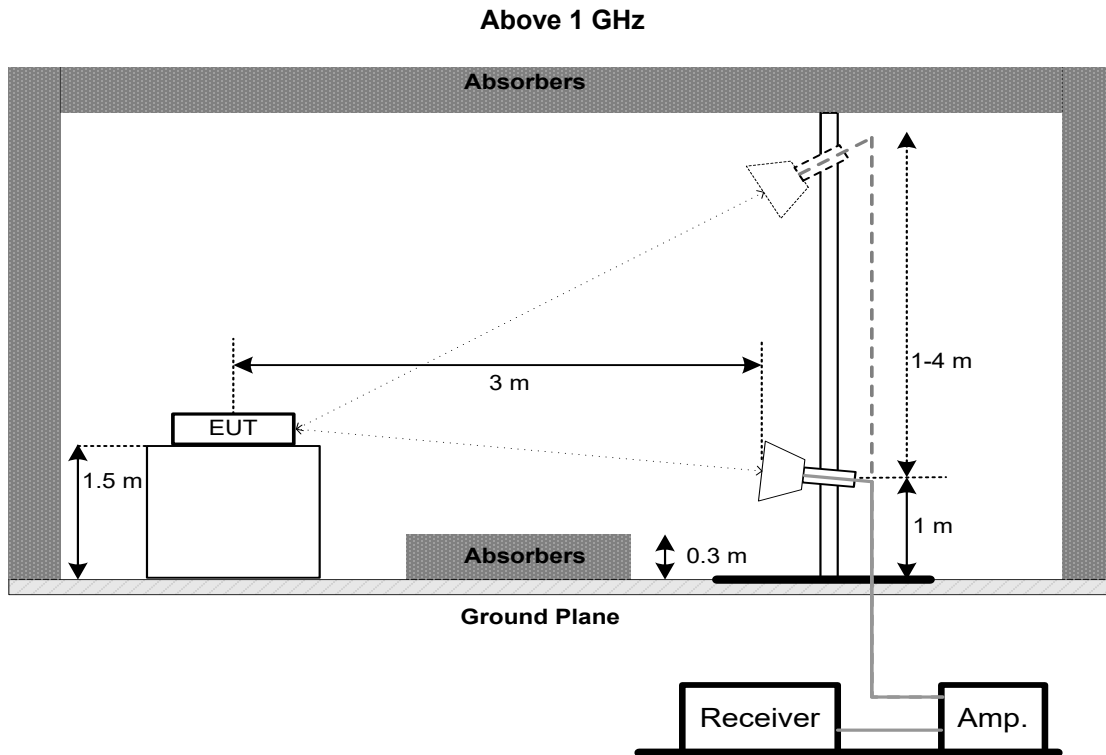

5.5 EUT OPERATION CONDITIONS

The EUT was programmed to be in continuously transmitting mode.

5.6 TEST RESULTS - 9 KHZ TO 30 MHZ

Please refer to the APPENDIX B.

Remark:

- (1) Distance extrapolation factor = $40 \log (\text{specific distance} / \text{test distance})$ (dB).
- (2) Limit line = specific limits (dBuV) + distance extrapolation factor.

5.7 TEST RESULTS - 30 MHZ TO 1000 MHZ

Please refer to the APPENDIX C.

5.8 TEST RESULTS - ABOVE 1000 MHZ

Please refer to the APPENDIX D.

Remark:

- (1) No limit: This is fundamental signal, the judgment is not applicable.
For fundamental signal judgment was referred to Peak output test.

6. BANDWIDTH

6.1 LIMIT

Section	Test Item	Limit
FCC 15.247(a)(2)	6 dB Bandwidth	Minimum 500 kHz
	99% Emission Bandwidth	-

6.2 TEST PROCEDURE

- The EUT was directly connected to the spectrum analyzer and antenna output port as show in the block diagram below.
- The following table is the setting of the spectrum analyzer:

For 6 dB Bandwidth:

Spectrum Parameters	Setting
Span Frequency	> Measurement Bandwidth
RBW	100 kHz
VBW	300 kHz
Detector	Peak
Trace	Max Hold
Sweep Time	Auto

For 99% Emission Bandwidth:

Spectrum Parameters	Setting
Span Frequency	Between 1.5 times and 5.0 times the OBW
RBW	300 kHz For 20MHz 1 MHz For 40MHz
VBW	1 MHz For 20MHz 3 MHz For 40MHz
Detector	Peak
Trace	Max Hold
Sweep Time	Auto

6.3 DEVIATION FROM STANDARD

No deviation.

6.4 TEST SETUP



6.5 EUT OPERATION CONDITIONS

The EUT was programmed to be in continuously transmitting mode.

6.6 TEST RESULTS

Please refer to the APPENDIX E.

7. MAXIMUM OUTPUT POWER

7.1 LIMIT

Section	Test Item	Limit
FCC 15.247(b)(3)	Maximum Output Power	1.0000 Watt or 30.00 dBm

7.2 TEST PROCEDURE

- The EUT was directly connected to the peak power analyzer and antenna output port as show in the block diagram below.
- The maximum conducted output power was performed in accordance with method 11.9.2.3.1 (for AVG power) of ANSI C63.10-2013 and FCC KDB 662911 D01 v02r01 Multiple Transmitter Output.

7.3 DEVIATION FROM STANDARD

No deviation.

7.4 TEST SETUP

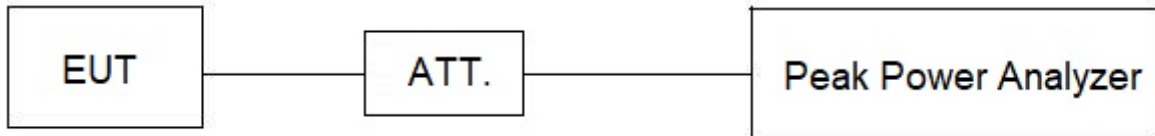

7.5 EUT OPERATION CONDITIONS

The EUT was programmed to be in continuously transmitting mode.

7.6 TEST RESULTS

Please refer to the APPENDIX F.

8. CONDUCTED SPURIOUS EMISSIONS

8.1 LIMIT

In any 100 kHz bandwidth outside the frequency band in which the spread spectrum or digitally modulated intentional radiator is operating, the radio frequency power that is produced by the intentional radiator shall be at least 20 dB below that in the 100 kHz bandwidth within the band that contains the highest level of the desired power, based on either an RF conducted or a radiated measurement, provided the transmitter demonstrates compliance with the peak Output Power limits. If the transmitter complies with the Output Power limits based on the use of RMS averaging over a time interval, as permitted under paragraph (b)(3) of this section, the attenuation required under this paragraph shall be 30 dB instead of 20 dB. Attenuation below the general limits specified in Section 15.209(a) is not required.

8.2 TEST PROCEDURE

- a. The EUT was directly connected to the spectrum analyzer and antenna output port as show in the block diagram below.
- b. The following table is the setting of the spectrum analyzer:

Spectrum Parameters	Setting
Start Frequency	30 MHz
Stop Frequency	26.5 GHz
RBW	100 kHz
VBW	300 kHz
Detector	Peak
Trace	Max Hold
Sweep Time	Auto

8.3 DEVIATION FROM STANDARD

No deviation.

8.4 TEST SETUP



8.5 EUT OPERATION CONDITIONS

The EUT was programmed to be in continuously transmitting mode.

8.6 TEST RESULTS

Please refer to the APPENDIX G.

9. POWER SPECTRAL DENSITY

9.1 LIMIT

Section	Test Item	Limit
FCC 15.247(e)	Power Spectral Density	8 dBm (in any 3 kHz)

9.2 TEST PROCEDURE

- The EUT was directly connected to the spectrum analyzer and antenna output port as show in the block diagram below.
- The following table is the setting of the spectrum analyzer:

Spectrum Parameters	Setting
Span Frequency	25 MHz (20 MHz) / 60 MHz (40 MHz)
RBW	3 kHz
VBW	10 kHz
Detector	Peak
Trace	Max Hold
Sweep Time	Auto

9.3 DEVIATION FROM STANDARD

No deviation.

9.4 TEST SETUP



9.5 EUT OPERATION CONDITIONS

The EUT was programmed to be in continuously transmitting mode.

9.6 TEST RESULTS

Please refer to the APPENDIX H.

10. MEASUREMENT INSTRUMENTS LIST

AC Power Line Conducted Emissions					
Item	Kind of Equipment	Manufacturer	Type No.	Serial No.	Calibrated until
1	EMI Test Receiver	R&S	ESR3	103027	Jun. 16, 2024
2	TWO-LINE V-NETWORK	R&S	ENV216	101447	Dec. 22, 2024
3	Measurement Software	Farad	EZ-EMC Ver.NB-03A1-01	N/A	N/A
4	Cable	N/A	SFT205-NMNM-9 M-001	9M	Nov. 27, 2024
5	643 Shield Room	ETS	6*4*3	N/A	N/A

Radiated Emissions - 9 kHz to 30 MHz					
Item	Kind of Equipment	Manufacturer	Type No.	Serial No.	Calibrated until
1	Active Loop Antenna	Schwarzbeck	FMZB 1513-60B	1513-60 B-034	Apr. 01, 2024
2	MXE EMI Receiver	Keysight	N9038A	MY56400091	Dec. 22, 2024
3	Cable	N/A	RW2350-3.8A-NMB M-1.5M	N/A	Jun. 10, 2024
4	Measurement Software	Farad	EZ-EMC Ver.NB-03A1-01	N/A	N/A
5	966 Chamber room	ETS	9*6*6	N/A	Jul. 11, 2024

Radiated Emissions - 30 MHz to 1 GHz					
Item	Kind of Equipment	Manufacturer	Type No.	Serial No.	Calibrated until
1	Trilog-Broadband Antenna	Schwarzbeck	VULB 9168	1462	Dec.13, 2024
2	Attenuator	EMC INSTRUMENT	EMCI-N-6-06	AT-06009	Dec.13, 2024
3	Preamplifier	EMC INSTRUMENT	EMC001330	980863	Nov. 17, 2024
4	Cable	RegalWay	LMR400-NMNM-12.5m	N/A	Jul. 04, 2024
5	Cable	RegalWay	LMR400-NMNM-3 m	N/A	Jul. 04, 2024
6	Cable	RegalWay	LMR400-NMNM-0.5m	N/A	Jul. 04, 2024
7	Receiver	Agilent	N9038A	MY52130039	Dec. 22, 2024
8	Positioning Controller	MF	MF-7802	N/A	N/A
9	Measurement Software	Farad	EZ-EMC Ver.NB-03A1-01	N/A	N/A
10	966 Chamber room	CM	9*6*6	N/A	May 17, 2024

Radiated Emissions - Above 1 GHz					
Item	Kind of Equipment	Manufacturer	Type No.	Serial No.	Calibrated until
1	Receiver	Agilent	N9038A	MY52130039	Dec. 22, 2024
2	Preamplifier	EMC INSTRUMENT	EMC118A45SE	980888	Nov. 17, 2024
3	EXA Spectrum Analyzer	Keysight	N9010A	MY55150209	Jun. 16, 2024
4	Double Ridged Guide Antenna	ETS	3115	75789	May 31, 2024
5	Cable	RegalWay	A81-SMAMSMAM-12.5M	N/A	Aug. 08, 2024
6	Cable	RegalWay	RWLP50-4.0A-NMRA SM-2.5M	N/A	Aug. 08, 2024
7	Cable	RegalWay	RWLP50-4.0A-NMRA SMRA-0.8M	N/A	Aug. 08, 2024
8	Low Noise Amplifier	CONNPHY	CLN-18G40G-4330-K	619413	Jul. 06, 2024
9	Cable	RegalWay	RWLP50-2.6A-2.92M 2.92M-1.1M	N/A	Jul. 26, 2024
10	Cable	Tonscend	HF160-KMKM-3M	N/A	Jul. 26, 2024
11	Broad-Band Horn Antenna	Schwarzbeck	BBHA9170(3m)	9170-319	Jun. 20, 2024
12	966 Chamber room	CM	9*6*6	N/A	May 17, 2024
13	Attenuator	Talent Microwave	TA10A2-S-18	N/A	N/A
14	Positioning Controller	MF	MF-7802	N/A	N/A
15	Measurement Software	Farad	EZ-EMC Ver.NB-03A1-01	N/A	N/A

Bandwidth & Conducted Spurious Emissions & Power Spectral Density					
Item	Kind of Equipment	Manufacturer	Type No.	Serial No.	Calibrated until
1	Spectrum Analyzer	R&S	FSP40	100185	Jun. 16, 2024
2	Attenuator	Talent Microwave	TA10A0-S-26.5	N/A	N/A
3	EXA Spectrum Analyzer	Keysight	N9010A	MY55150209	Jun. 16, 2024
4	Contact type voltage regulator	SAKO	TDGC2	N/A	Jul. 07, 2024
5	Measurement Software	BTL	BTL Conducted Test	N/A	N/A
6	Attenuator	Talent Microwave	TA10A0-S-26.5	N/A	N/A
7	Attenuator	Talent Microwave	TA10A0-S-26.5	N/A	N/A
8	Attenuator	Talent Microwave	TA10A0-S-26.5	N/A	N/A
9	DC Block	N/A	N/A	N/A	N/A

Maximum Output Power					
Item	Kind of Equipment	Manufacturer	Type No.	Serial No.	Calibrated until
1	Peak Power Analyzer	Keysight	8990B	MY51000506	Jun. 17, 2024
2	Wideband power sensor	Keysight	N1923A	MY58310004	Jun. 17, 2024
3	Attenuator	Talent Microwave	TA10A2-S-18	N/A	N/A

Remark: "N/A" denotes no model name, serial no. or calibration specified.

All calibration period of equipment list is one year.

11. EUT TEST PHOTO**AC Power Line Conducted Emissions Test Photos**

Radiated Emissions Test Photos

9 kHz to 30 MHz

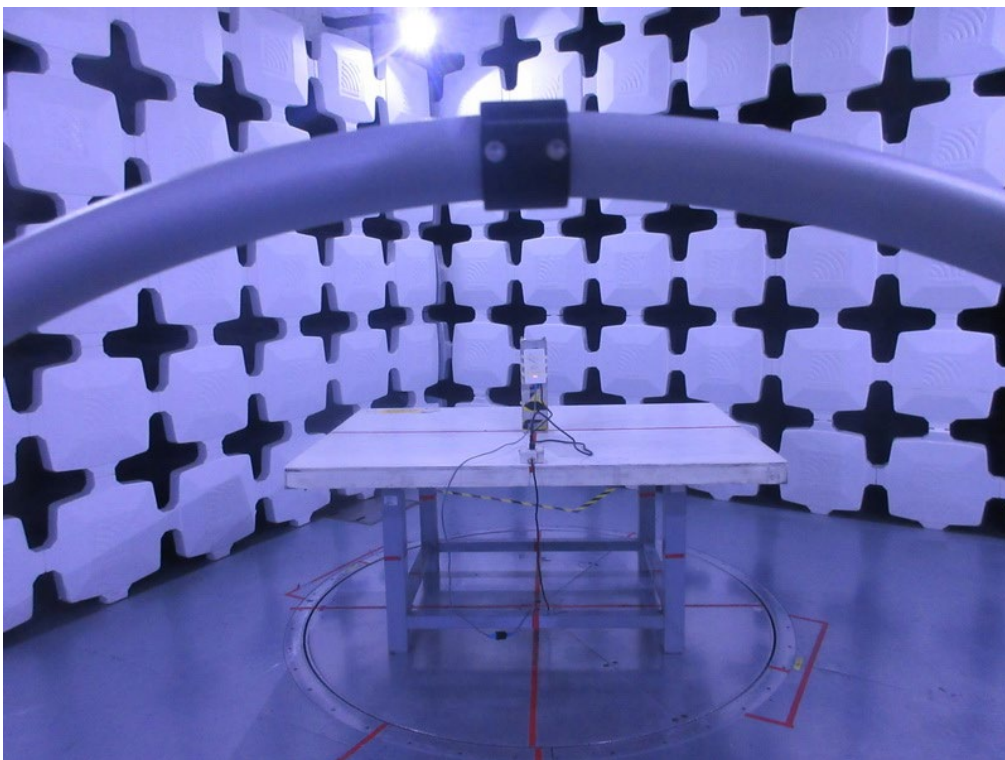
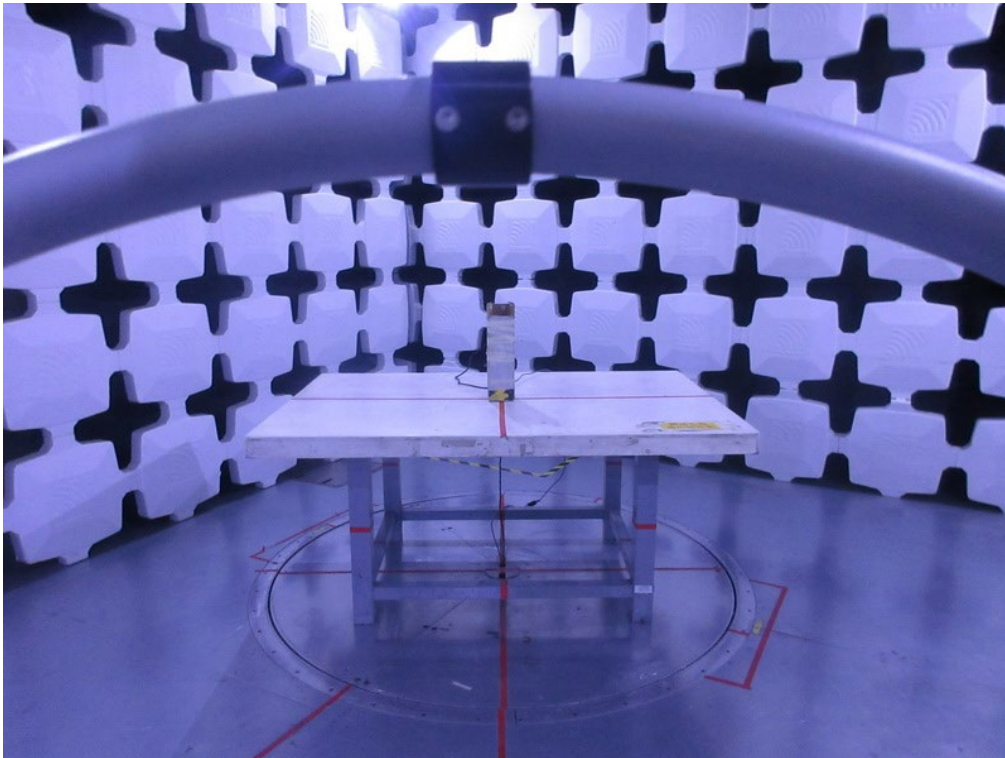

Radiated Emissions Test Photos

30 MHz to 1 GHz

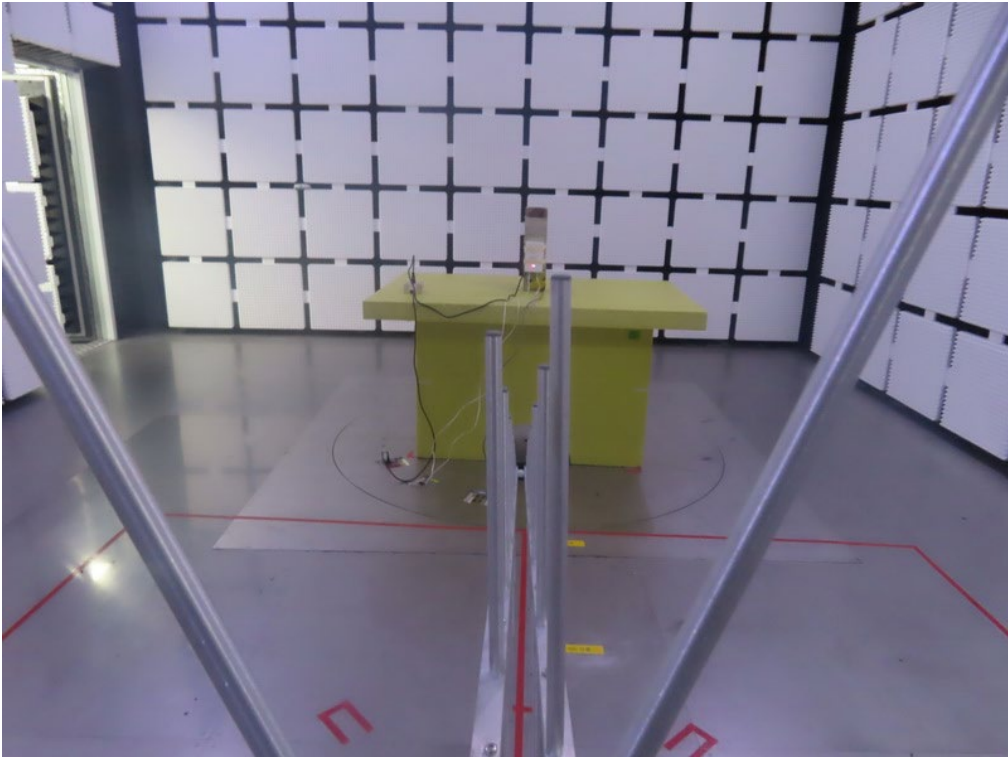
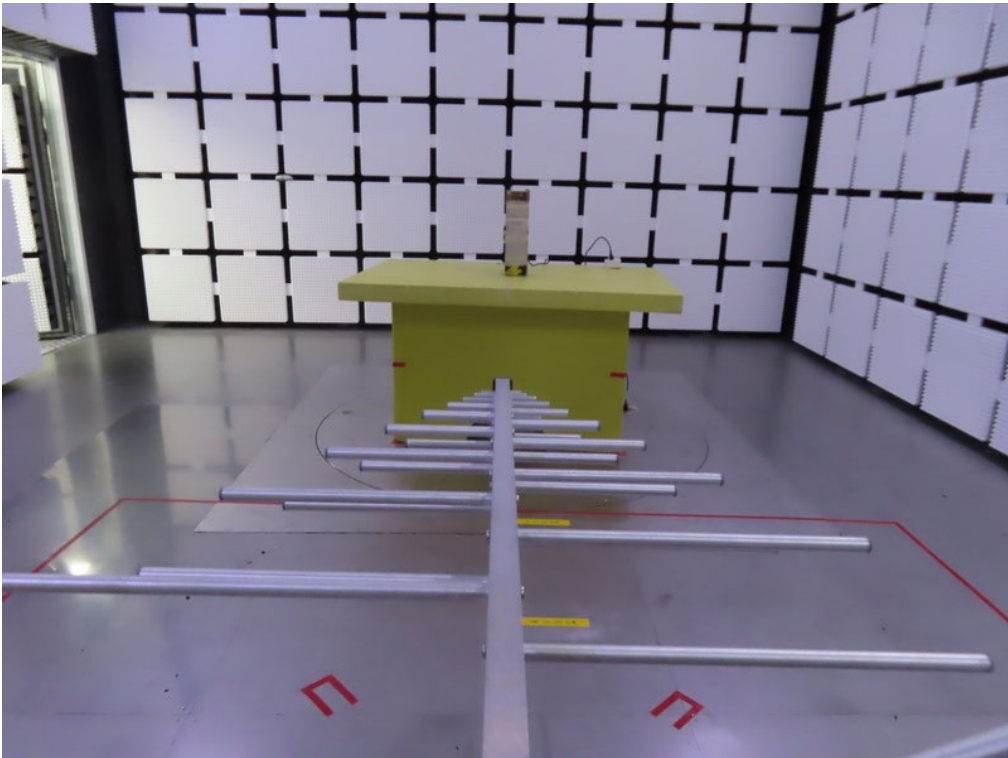

Radiated Emissions Test Photos

Above 1 GHz

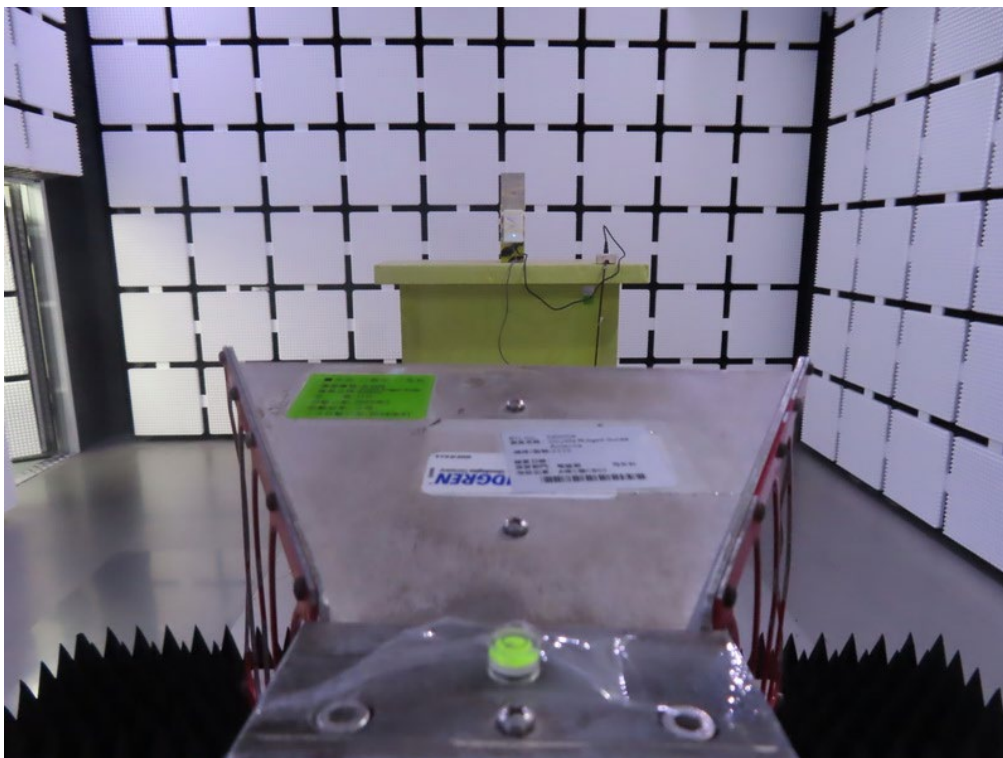
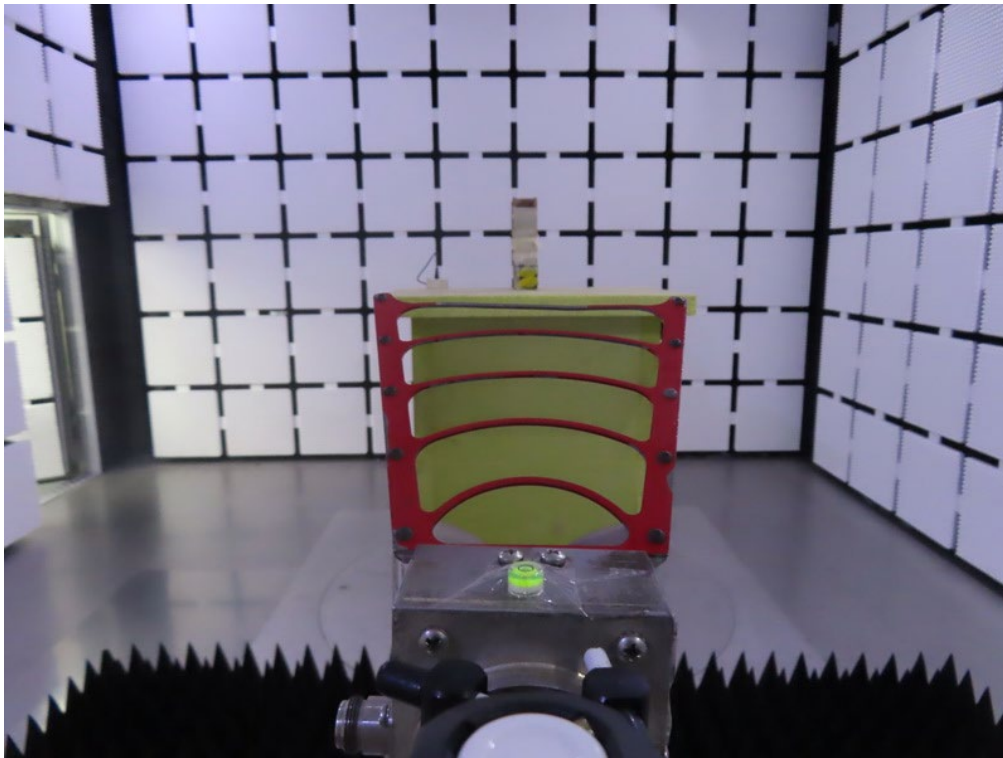

Conducted Test Photos

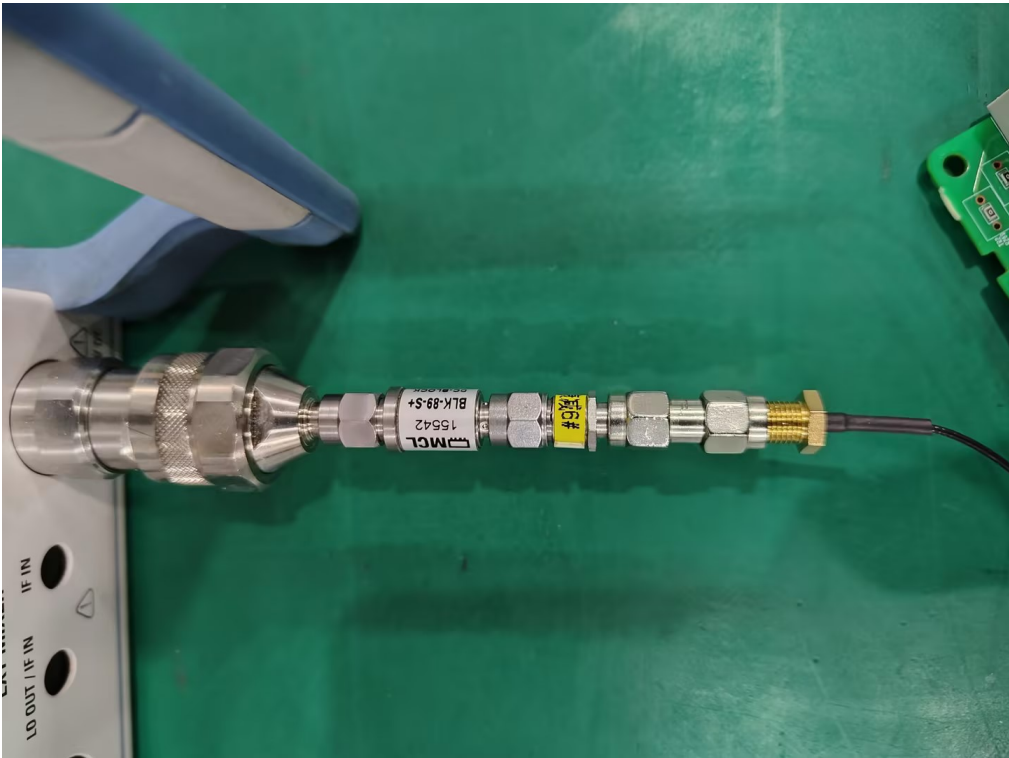
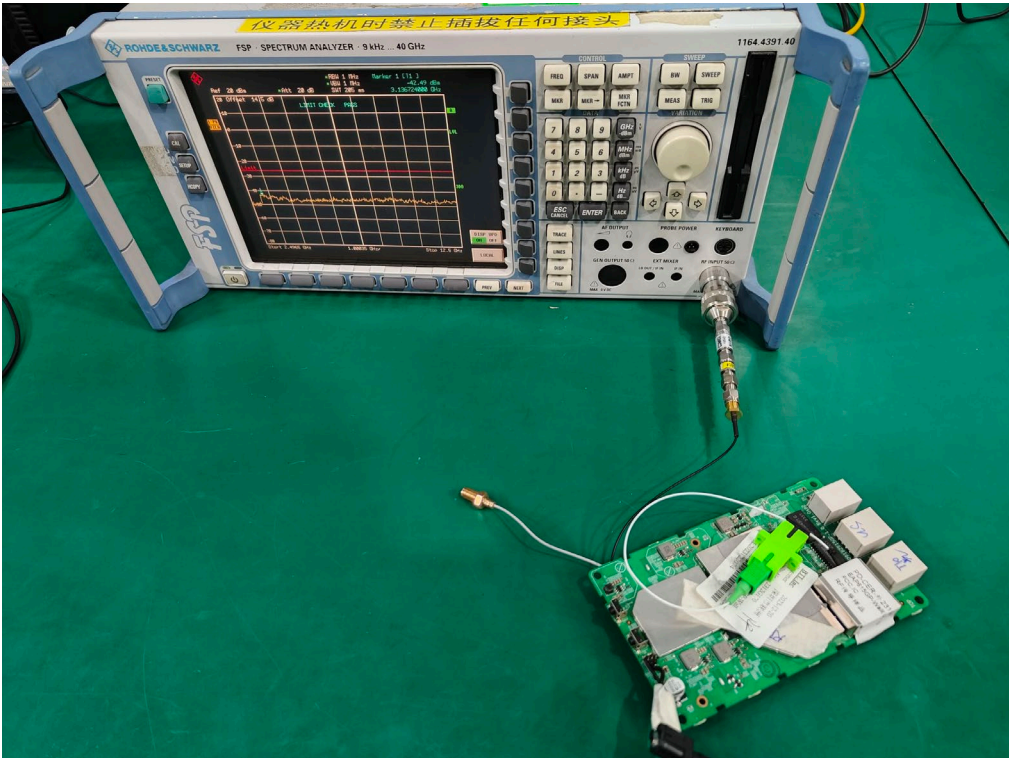

APPENDIX A - AC POWER LINE CONDUCTED EMISSIONS

Test Mode	TX G Mode Channel 06	Phase	Line
-----------	----------------------	-------	------

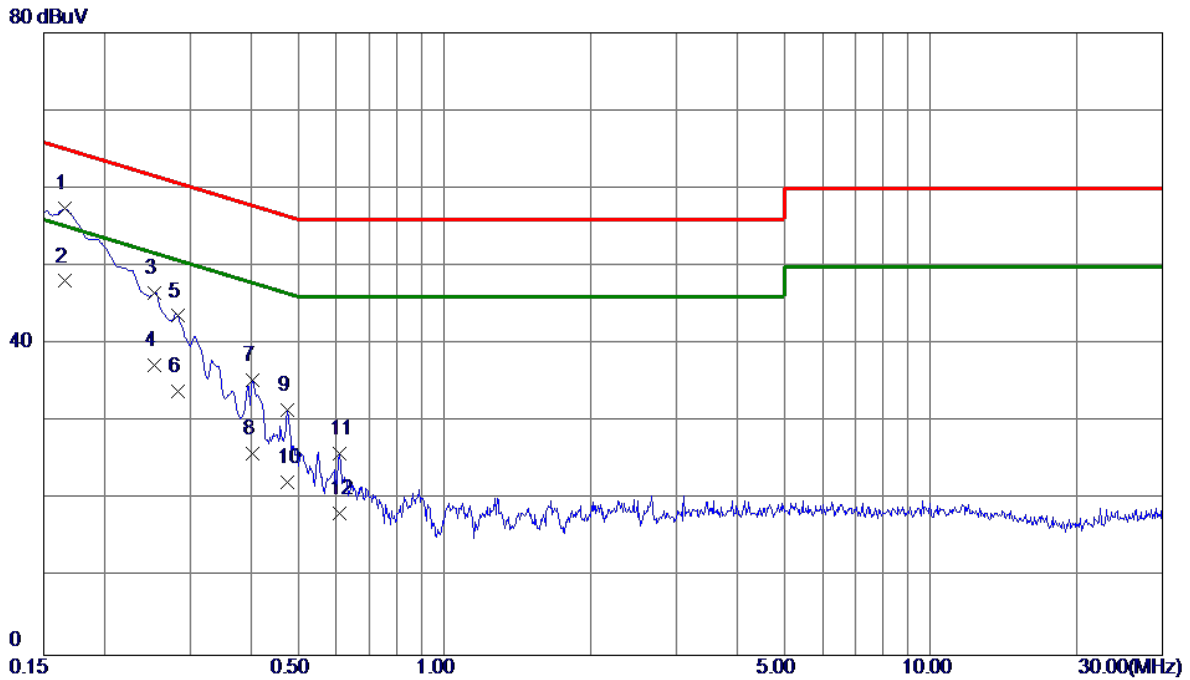

No.	Freq. MHz	Reading Level dBuV	Correct Factor dB	Measure ment dBuV	Limit dBuV	Margin dB	Detector	Comment
1	0.1658	47.71	9.68	57.39	65.17	-7.78	QP	
2 *	0.1658	38.40	9.68	48.08	55.17	-7.09	AVG	
3	0.2535	36.94	9.68	46.62	61.64	-15.02	QP	
4	0.2535	27.60	9.68	37.28	51.64	-14.36	AVG	
5	0.2833	33.92	9.68	43.60	60.72	-17.12	QP	
6	0.2833	24.20	9.68	33.88	50.72	-16.84	AVG	
7	0.4042	25.62	9.69	35.31	57.77	-22.46	QP	
8	0.4042	16.30	9.69	25.99	47.77	-21.78	AVG	
9	0.4762	21.89	9.70	31.59	56.41	-24.82	QP	
10	0.4762	12.50	9.70	22.20	46.41	-24.21	AVG	
11	0.6090	16.16	9.70	25.86	56.00	-30.14	QP	
12	0.6090	8.60	9.70	18.30	46.00	-27.70	AVG	

REMARKS:

- (1) Measurement Value = Reading Level + Correct Factor.
- (2) Margin Level = Measurement Value - Limit Value.

Test Mode	TX G Mode Channel 06	Phase	Neutral
-----------	----------------------	-------	---------

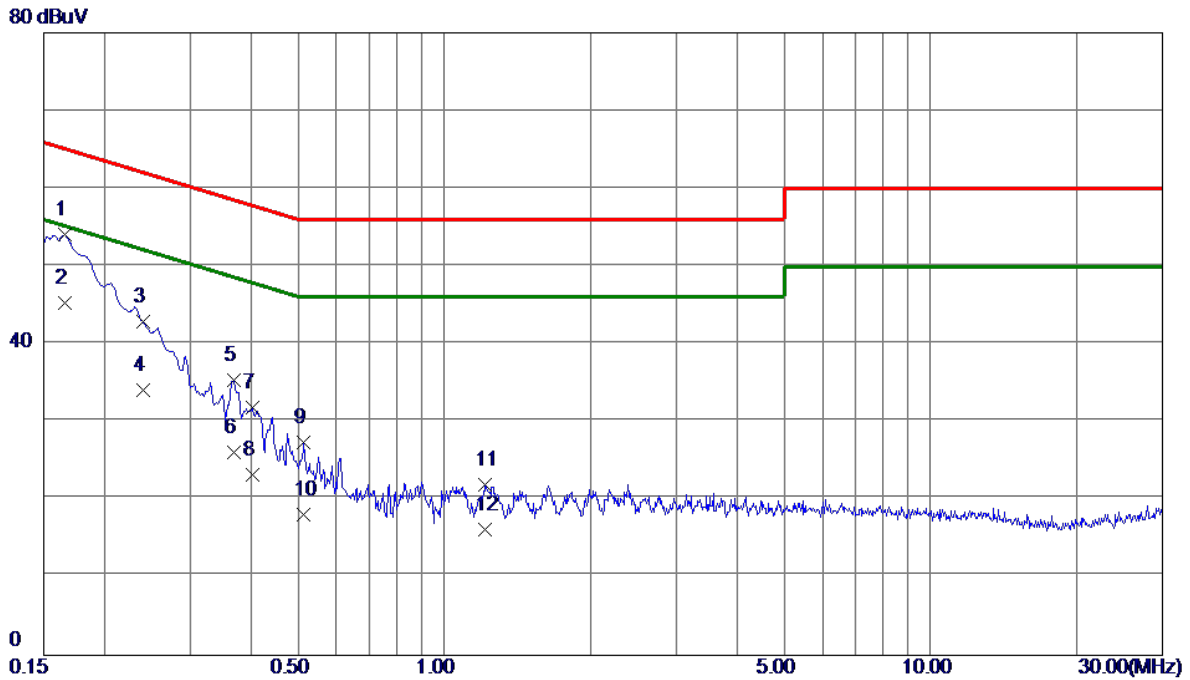

No.	Freq. MHz	Reading Level dBuV	Correct Factor dB	Measure ment dBuV	Limit dBuV	Margin dB	Detector	Comment
1	0.1658	44.37	9.66	54.03	65.17	-11.14	QP	
2 *	0.1658	35.60	9.66	45.26	55.17	-9.91	AVG	
3	0.2400	33.22	9.65	42.87	62.10	-19.23	QP	
4	0.2400	24.50	9.65	34.15	52.10	-17.95	AVG	
5	0.3682	25.69	9.65	35.34	58.54	-23.20	QP	
6	0.3682	16.40	9.65	26.05	48.54	-22.49	AVG	
7	0.4042	22.26	9.65	31.91	57.77	-25.86	QP	
8	0.4042	13.60	9.65	23.25	47.77	-24.52	AVG	
9	0.5144	17.73	9.66	27.39	56.00	-28.61	QP	
10	0.5144	8.40	9.66	18.06	46.00	-27.94	AVG	
11	1.2142	12.27	9.71	21.98	56.00	-34.02	QP	
12	1.2142	6.50	9.71	16.21	46.00	-29.79	AVG	

REMARKS:

- (1) Measurement Value = Reading Level + Correct Factor.
- (2) Margin Level = Measurement Value - Limit Value.

APPENDIX B - RADIATED EMISSION - 9 KHZ TO 30 MHZ

Test Mode	TX G Mode Channel 06	Polarization	Ant 0°
-----------	----------------------	--------------	--------

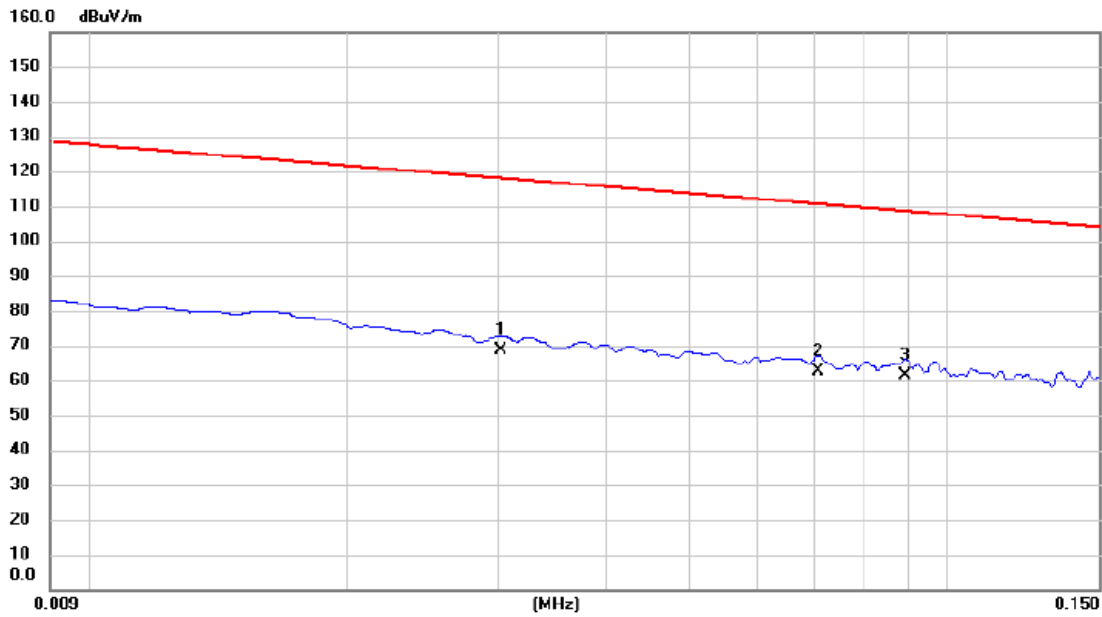

No.	Mk.	Freq. MHz	Reading Level dBuV	Correct Factor dB	Measurement dBuV/m	Limit dBuV/m	Margin dB	Detector	Comment
1		0.0302	48.62	19.80	68.42	118.00	-49.58	AVG	
2		0.0708	42.69	19.87	62.56	110.60	-48.04	AVG	
3	*	0.0892	41.62	19.85	61.47	108.60	-47.13	AVG	

REMARKS:

- (1) Measurement Value = Reading Level + Correct Factor.
- (2) Margin Level = Measurement Value - Limit Value.

Test Mode	TX G Mode Channel 06	Polarization	Ant 0°
-----------	----------------------	--------------	--------

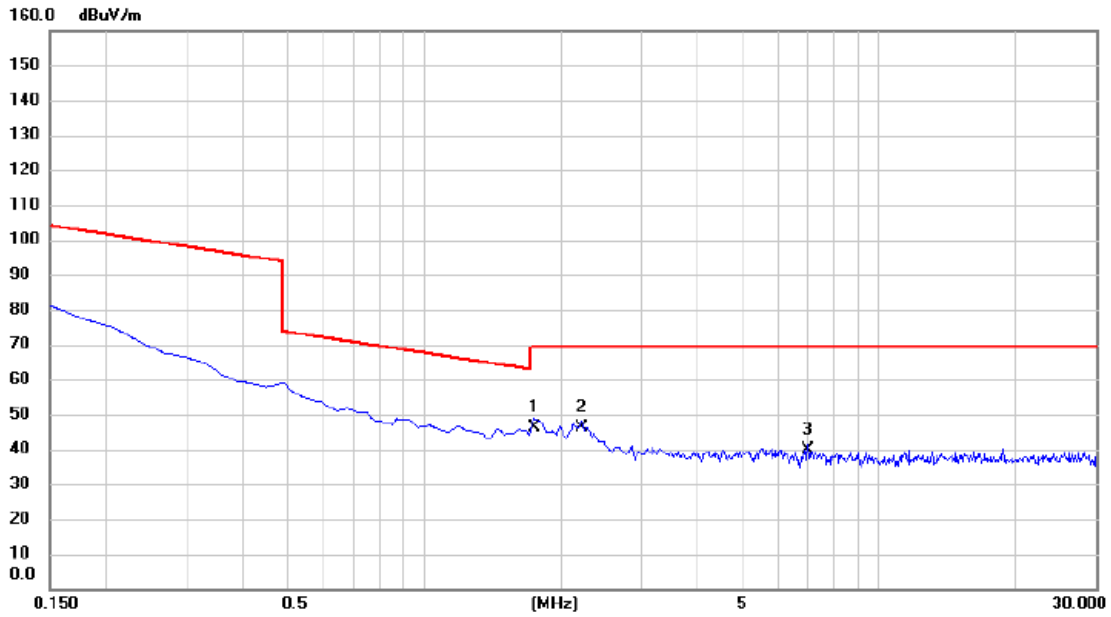

No.	Mk.	Freq. MHz	Reading Level dBuV	Correct Factor dB	Measure- ment dBuV/m	Limit dBuV/m	Margin dB	Detector	Comment
1	*	1.7470	26.51	19.81	46.32	69.54	-23.22	QP	
2		2.2246	26.31	19.81	46.12	69.54	-23.42	QP	
3		6.9707	19.62	20.02	39.64	69.54	-29.90	QP	

REMARKS:

(1) Measurement Value = Reading Level + Correct Factor.

(2) Margin Level = Measurement Value - Limit Value.

Test Mode	TX G Mode Channel 06	Polarization	Ant 90°
-----------	----------------------	--------------	---------

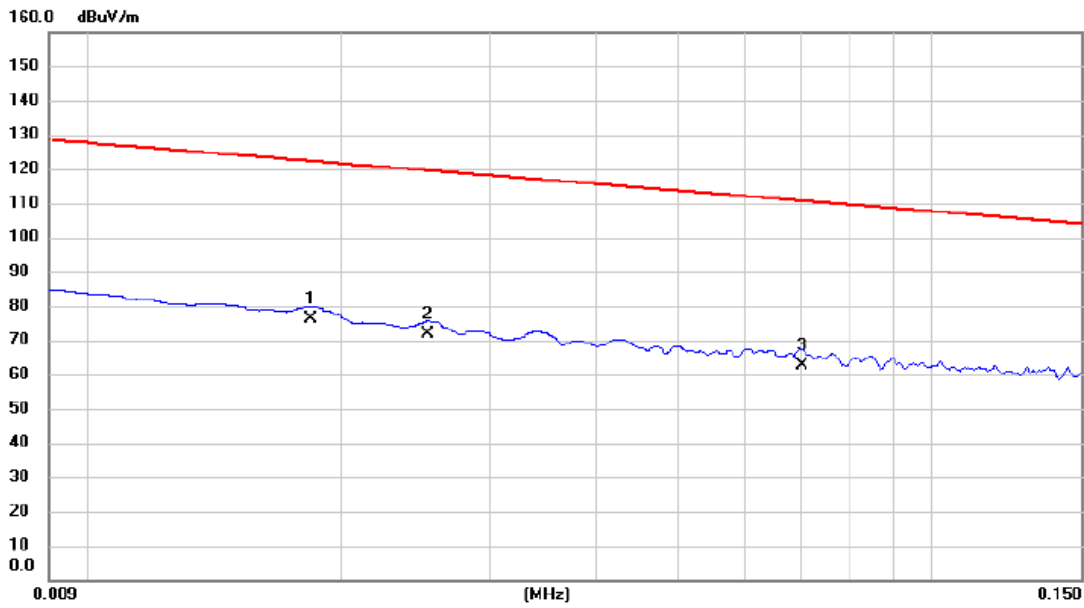

No.	Mk.	Freq. MHz	Reading Level dBuV	Correct Factor dB	Measure- ment dBuV/m	Limit dBuV/m	Margin dB	Detector	Comment
1	*	0.0184	55.81	20.44	76.25	122.31	-46.06	AVG	
2		0.0253	51.63	20.06	71.69	119.54	-47.85	AVG	
3		0.0702	42.61	19.87	62.48	110.68	-48.20	AVG	

REMARKS:

- (1) Measurement Value = Reading Level + Correct Factor.
- (2) Margin Level = Measurement Value - Limit Value.

Test Mode	TX G Mode Channel 06	Polarization	Ant 90°
-----------	----------------------	--------------	---------

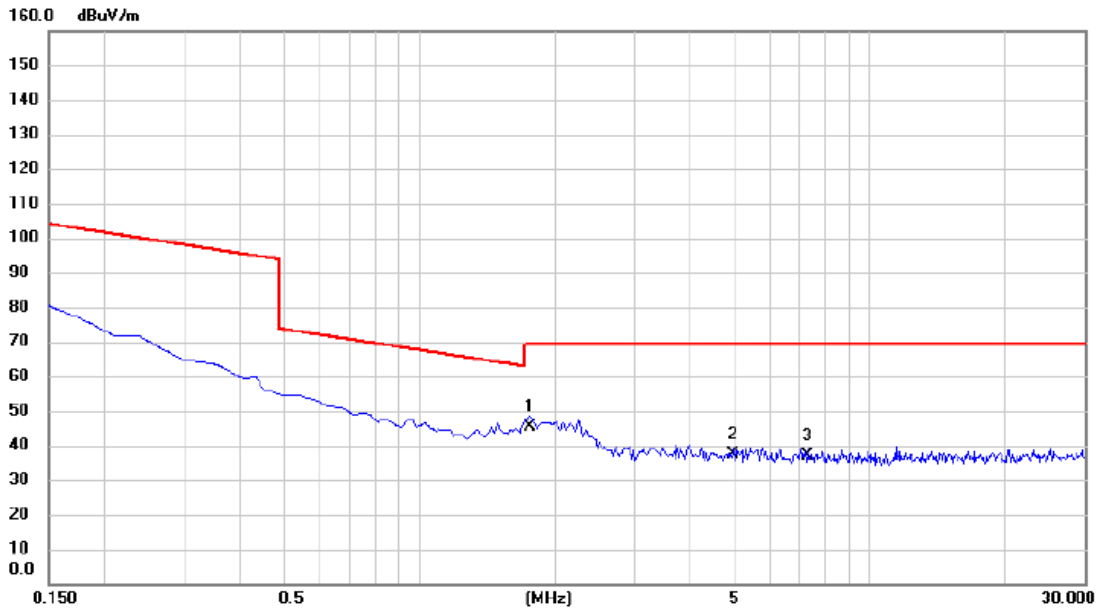

No.	Mk.	Freq. MHz	Reading Level dBuV	Correct Factor dB	Measure- ment dBuV/m	Limit dBuV/m	Margin dB	Detector	Comment
1	*	1.7620	25.63	19.81	45.44	69.54	-24.10	QP	
2		4.9856	17.52	19.95	37.47	69.54	-32.07	QP	
3		7.2991	17.13	20.03	37.16	69.54	-32.38	QP	

REMARKS:

- (1) Measurement Value = Reading Level + Correct Factor.
- (2) Margin Level = Measurement Value - Limit Value.

APPENDIX C - RADIATED EMISSION - 30 MHZ TO 1000 MHZ

Test Mode	TX G Mode Channel 06	Polarization	Vertical
-----------	----------------------	--------------	----------

80 dBuV/m

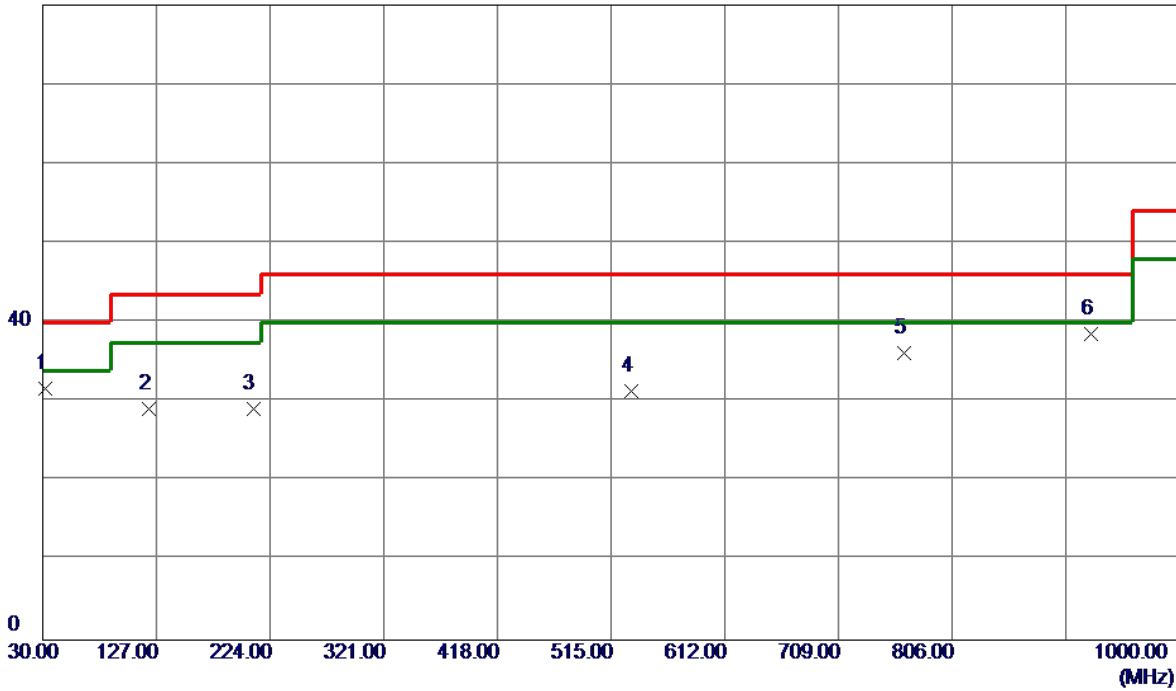

No.	Freq. MHz	Reading Level dBuV/m	Correct Factor dB	Measure ment dBuV/m	Limit dBuV/m	Margin dB	Detector	Comment
1	31.9400	44.46	-12.71	31.75	40.00	-8.25	Peak	
2	120.6950	42.28	-13.15	29.13	43.50	-14.37	Peak	
3	209.4500	43.64	-14.46	29.18	43.50	-14.32	Peak	
4	531.9750	36.74	-5.41	31.33	46.00	-14.67	Peak	
5	764.7750	37.37	-1.24	36.13	46.00	-9.87	Peak	
6 *	924.8250	38.25	0.28	38.53	46.00	-7.47	Peak	

REMARKS:

- (1) Measurement Value = Reading Level + Correct Factor.
- (2) Margin Level = Measurement Value - Limit Value.

Test Mode	TX G Mode Channel 06	Polarization	Horizontal
-----------	----------------------	--------------	------------

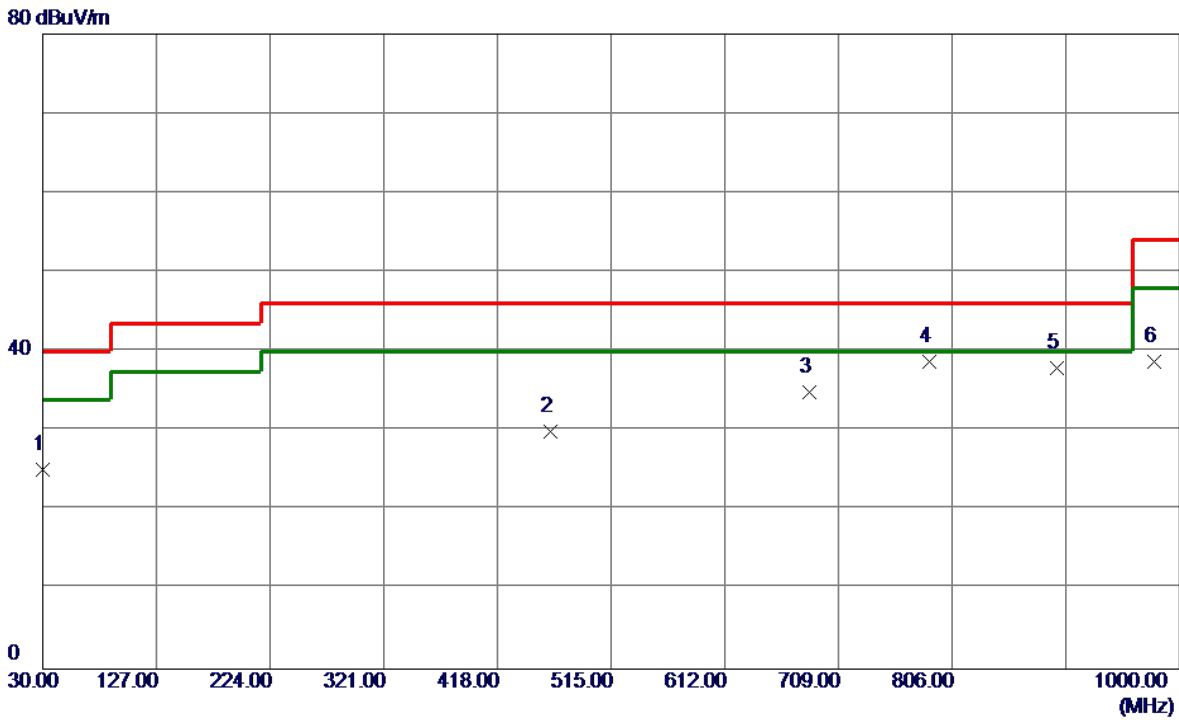

No.	Freq. MHz	Reading Level dBuV/m	Correct Factor dB	Measure ment dBuV/m	Limit dBuV/m	Margin dB	Detector	Comment
1	30.0000	38.24	-13.07	25.17	40.00	-14.83	Peak	
2	463.1050	36.52	-6.60	29.92	46.00	-16.08	Peak	
3	684.2650	37.49	-2.56	34.93	46.00	-11.07	Peak	
4 *	786.6000	40.09	-1.33	38.76	46.00	-7.24	Peak	
5	895.7250	37.75	0.11	37.86	46.00	-8.14	Peak	
6	978.1750	38.06	0.62	38.68	54.00	-15.32	Peak	

REMARKS:

- (1) Measurement Value = Reading Level + Correct Factor.
- (2) Margin Level = Measurement Value - Limit Value.

APPENDIX D - RADIATED EMISSION- ABOVE 1000 MHZ

Test Mode	TX B Mode 2412 MHz	Polarization	Vertical
-----------	--------------------	--------------	----------

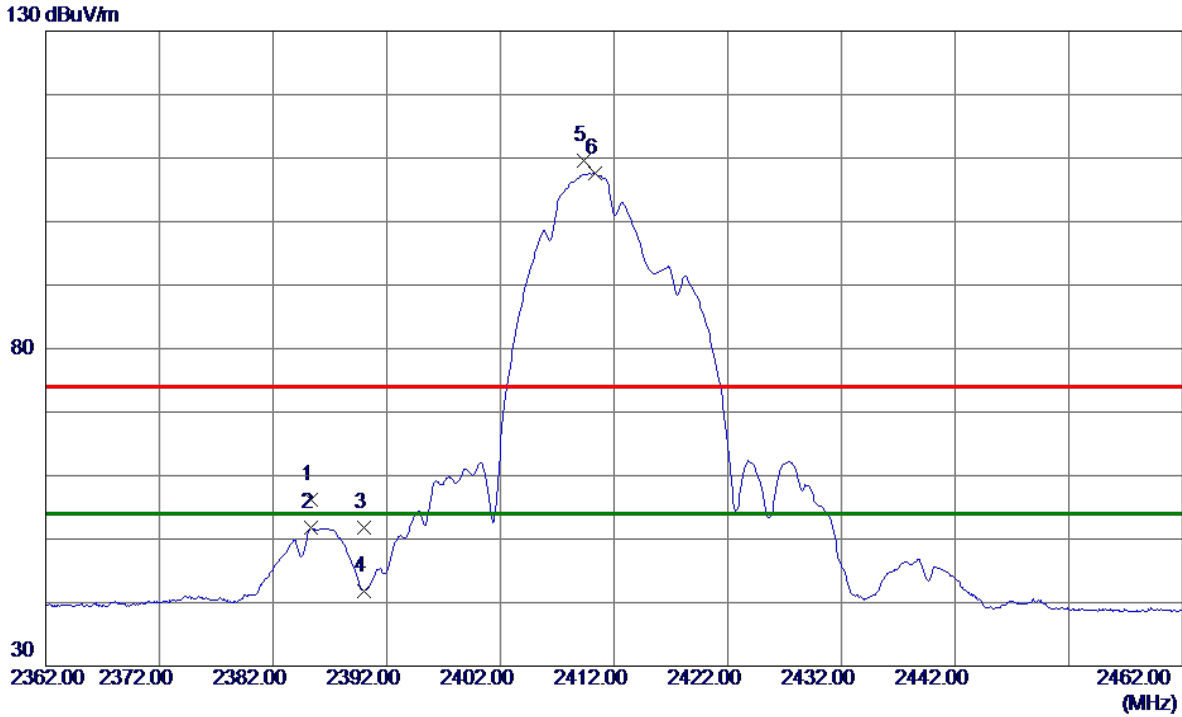

No.	Freq. MHz	Reading Level dBuV/m	Correct Factor dB	Measure ment dBuV/m	Limit dBuV/m	Margin dB	Detector	Comment
1	2385.3000	50.06	6.16	56.22	74.00	-17.78	Peak	
2	2385.3000	45.64	6.16	51.80	54.00	-2.20	AVG	
3	2390.0000	45.71	6.17	51.88	74.00	-22.12	Peak	
4	2390.0000	35.69	6.17	41.86	54.00	-12.14	AVG	
5	2409.3000	103.38	6.18	109.56	74.00	35.56	Peak	No Limit
6 *	2410.3000	101.41	6.18	107.59	54.00	53.59	AVG	No Limit

REMARKS:

- (1) Measurement Value = Reading Level + Correct Factor.
- (2) Margin Level = Measurement Value - Limit Value.

Test Mode	TX B Mode 2412 MHz	Polarization	Horizontal
-----------	--------------------	--------------	------------

80 dBuV/m

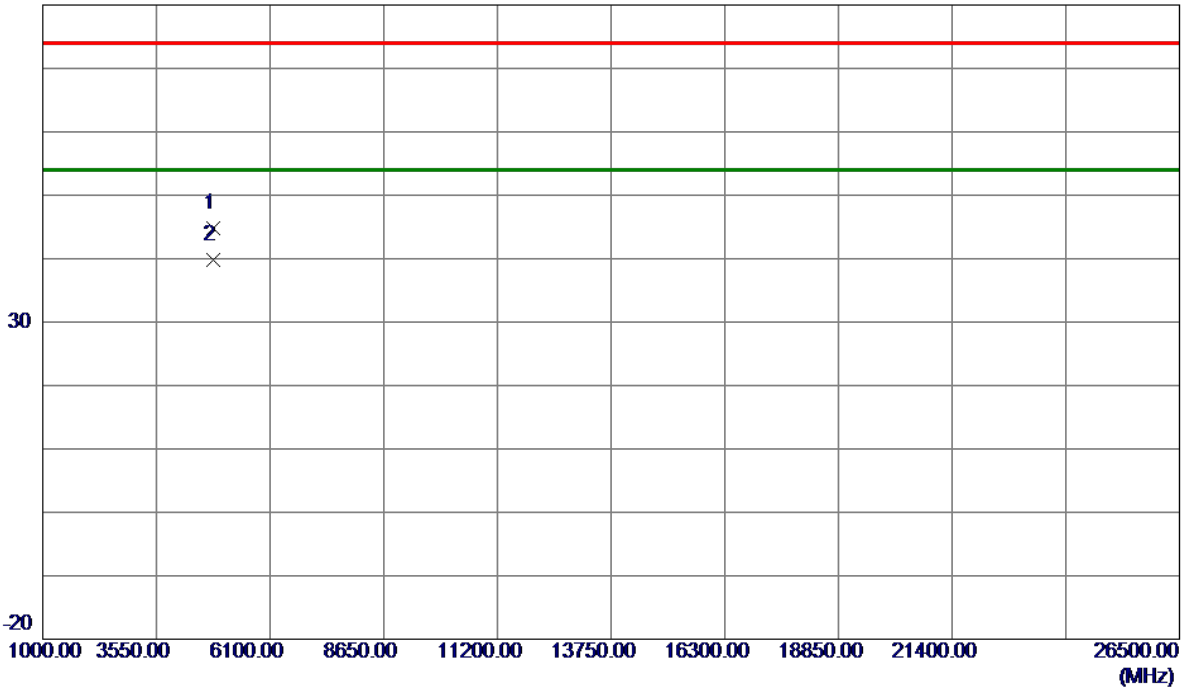

No.	Freq. MHz	Reading Level dBuV/m	Correct Factor dB	Measure ment dBuV/m	Limit dBuV/m	Margin dB	Detector	Comment
1	4823.8400	43.94	0.95	44.89	74.00	-29.11	Peak	
2 *	4824.0299	38.80	0.95	39.75	54.00	-14.25	AVG	

REMARKS:

- (1) Measurement Value = Reading Level + Correct Factor.
- (2) Margin Level = Measurement Value - Limit Value.

Test Mode	TX B Mode 2417 MHz	Polarization	Vertical
-----------	--------------------	--------------	----------

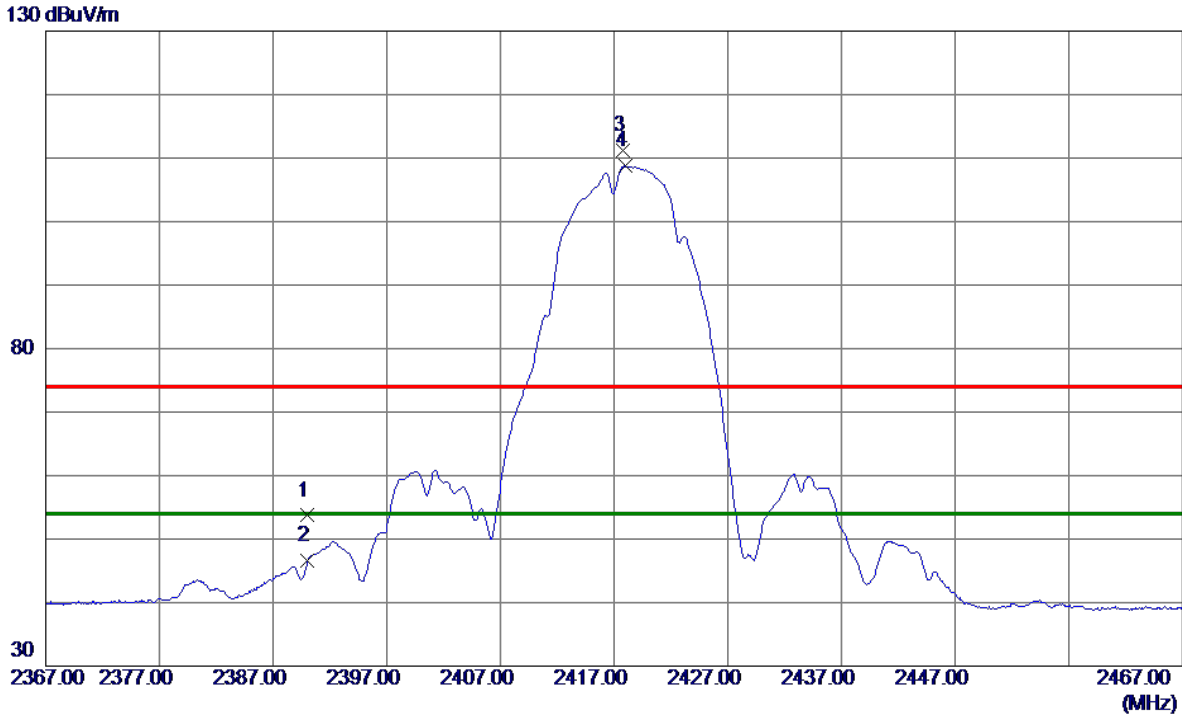

No.	Freq. MHz	Reading Level dBuV/m	Correct Factor dB	Measure ment dBuV/m	Limit dBuV/m	Margin dB	Detector	Comment
1	2390.0000	47.53	6.17	53.70	74.00	-20.30	Peak	
2	2390.0000	40.49	6.17	46.66	54.00	-7.34	AVG	
3	2417.8000	105.02	6.19	111.21	74.00	37.21	Peak	No Limit
4 *	2417.9500	102.62	6.19	108.81	54.00	54.81	AVG	No Limit

REMARKS:

- (1) Measurement Value = Reading Level + Correct Factor.
- (2) Margin Level = Measurement Value - Limit Value.

Test Mode	TX B Mode 2417 MHz	Polarization	Horizontal
-----------	--------------------	--------------	------------

80 dBuV/m

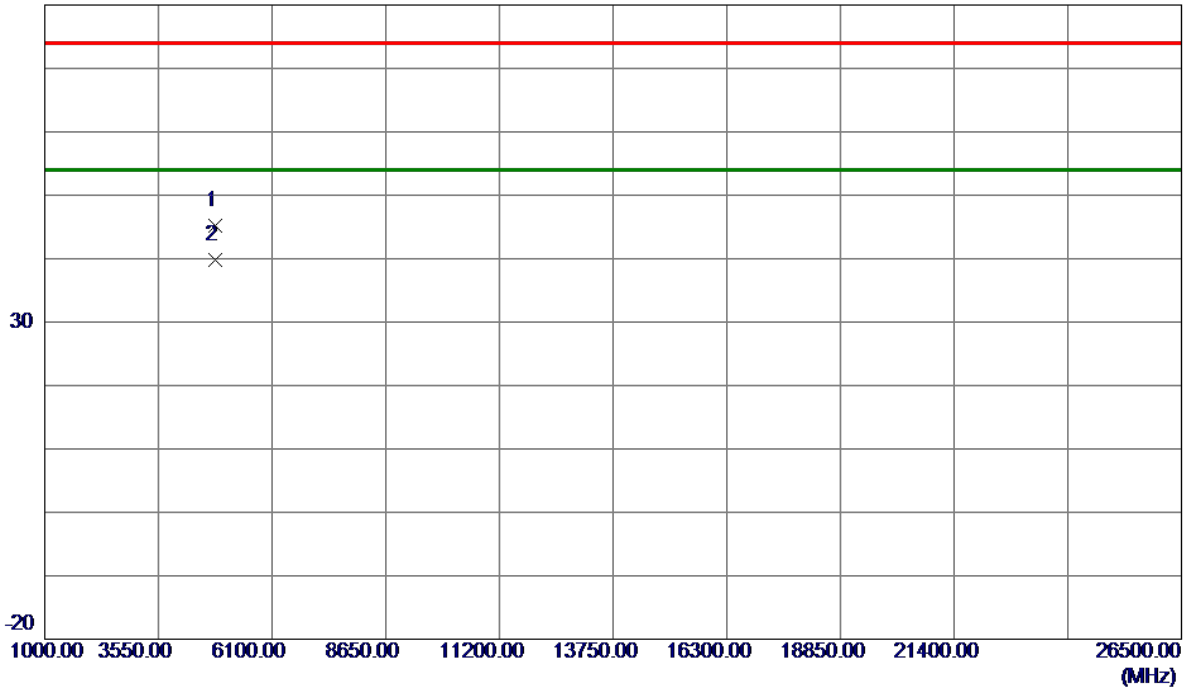

No.	Freq. MHz	Reading Level dBuV/m	Correct Factor dB	Measure ment dBuV/m	Limit dBuV/m	Margin dB	Detector	Comment
1	4833.9430	44.20	0.98	45.18	74.00	-28.82	Peak	
2 *	4834.0350	38.78	0.98	39.76	54.00	-14.24	AVG	

REMARKS:

- (1) Measurement Value = Reading Level + Correct Factor.
- (2) Margin Level = Measurement Value - Limit Value.

Test Mode	TX B Mode 2437 MHz	Polarization	Vertical
-----------	--------------------	--------------	----------

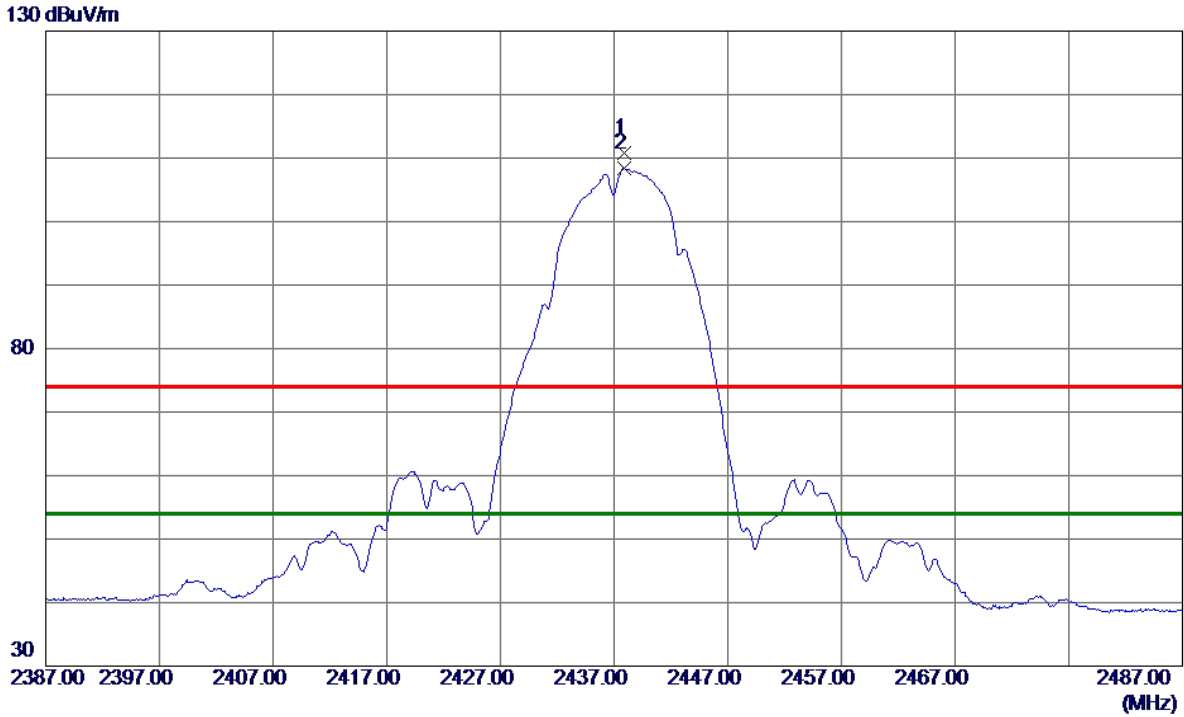

No.	Freq. MHz	Reading Level dBuV/m	Correct Factor dB	Measure ment dBuV/m	Limit dBuV/m	Margin dB	Detector	Comment
1	2437.8500	104.58	6.20	110.78	74.00	36.78	Peak	No Limit
2 *	2437.8500	102.20	6.20	108.40	54.00	54.40	AVG	No Limit

REMARKS:

- (1) Measurement Value = Reading Level + Correct Factor.
- (2) Margin Level = Measurement Value - Limit Value.

Test Mode	TX B Mode 2437 MHz	Polarization	Horizontal
-----------	--------------------	--------------	------------

80 dBuV/m

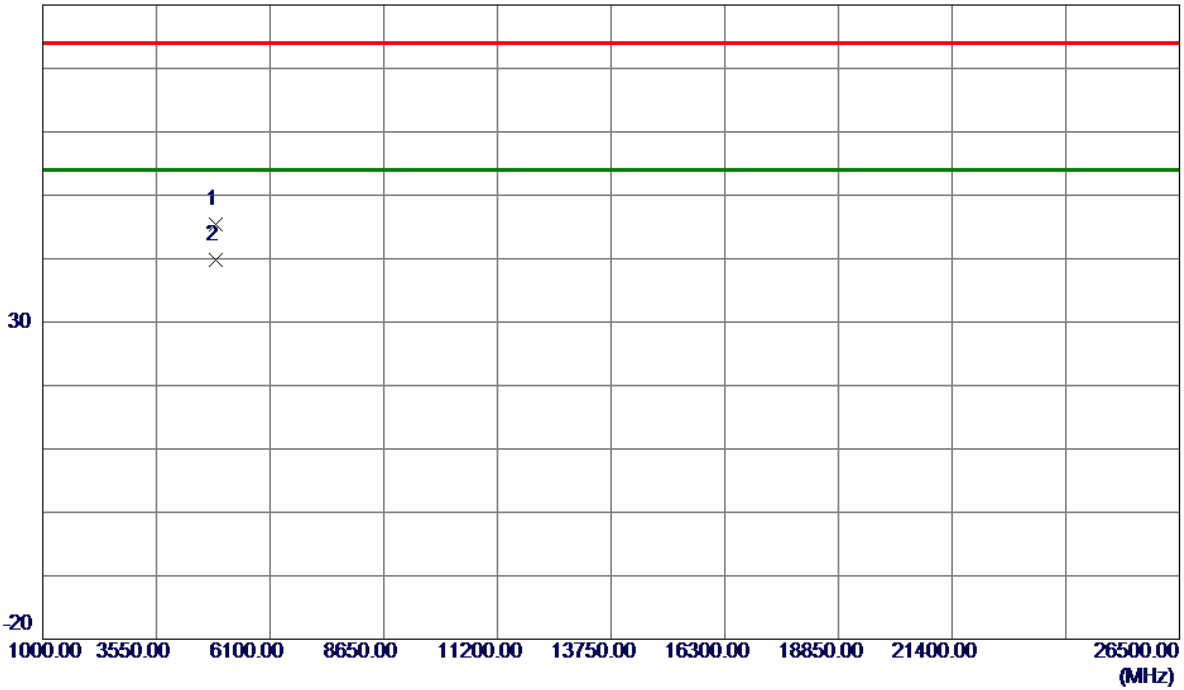

No.	Freq. MHz	Reading Level dBuV/m	Correct Factor dB	Measure ment dBuV/m	Limit dBuV/m	Margin dB	Detector	Comment
1	4873.8550	44.32	1.08	45.40	74.00	-28.60	Peak	
2 *	4874.0200	38.64	1.08	39.72	54.00	-14.28	AVG	

REMARKS:

- (1) Measurement Value = Reading Level + Correct Factor.
- (2) Margin Level = Measurement Value - Limit Value.

Test Mode	TX B Mode 2457 MHz	Polarization	Vertical
-----------	--------------------	--------------	----------

130 dBuV/m

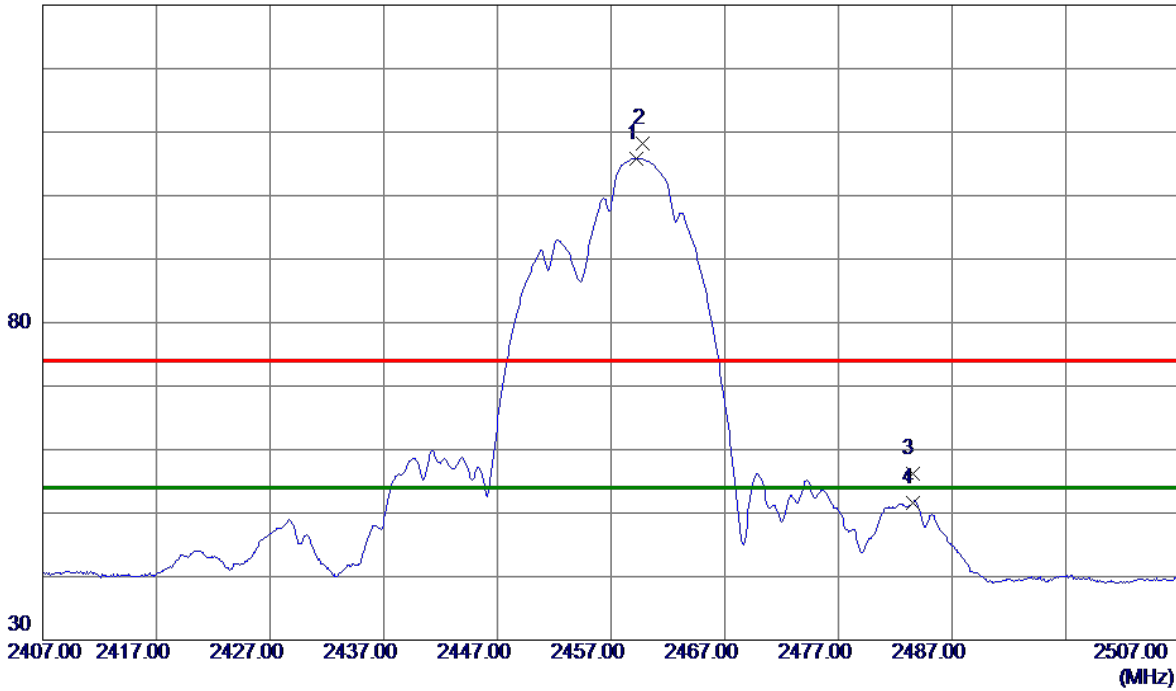

No.	Freq. MHz	Reading Level dBuV/m	Correct Factor dB	Measure ment dBuV/m	Limit dBuV/m	Margin dB	Detector	Comment
1 *	2459.2500	99.59	6.21	105.80	54.00	51.80	AVG	No Limit
2	2459.7500	101.98	6.21	108.19	74.00	34.19	Peak	No Limit
3	2483.5000	49.91	6.23	56.14	74.00	-17.86	Peak	
4	2483.5000	45.43	6.23	51.66	54.00	-2.34	AVG	

REMARKS:

- (1) Measurement Value = Reading Level + Correct Factor.
- (2) Margin Level = Measurement Value - Limit Value.

Test Mode	TX B Mode 2457 MHz	Polarization	Horizontal
-----------	--------------------	--------------	------------

80 dBuV/m

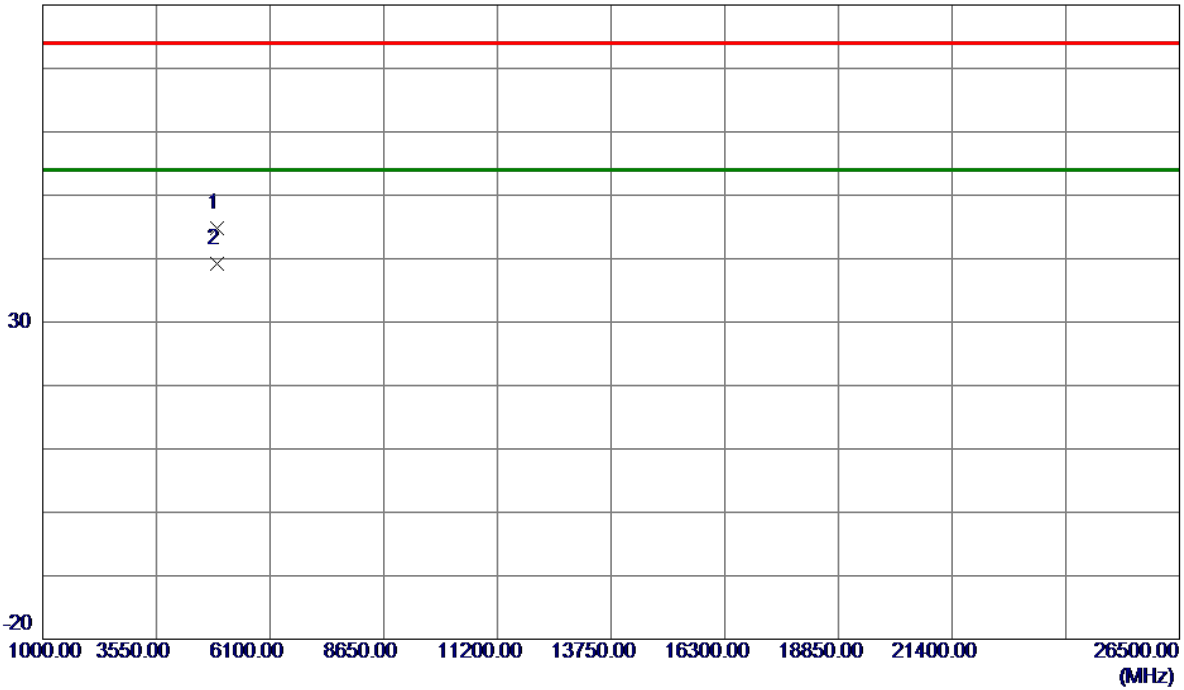

No.	Freq. MHz	Reading Level dBuV/m	Correct Factor dB	Measure ment dBuV/m	Limit dBuV/m	Margin dB	Detector	Comment
1	4913.8680	43.63	1.18	44.81	74.00	-29.19	Peak	
2 *	4914.0400	37.96	1.18	39.14	54.00	-14.86	AVG	

REMARKS:

- (1) Measurement Value = Reading Level + Correct Factor.
- (2) Margin Level = Measurement Value - Limit Value.

Test Mode	TX B Mode 2462 MHz	Polarization	Vertical
-----------	--------------------	--------------	----------

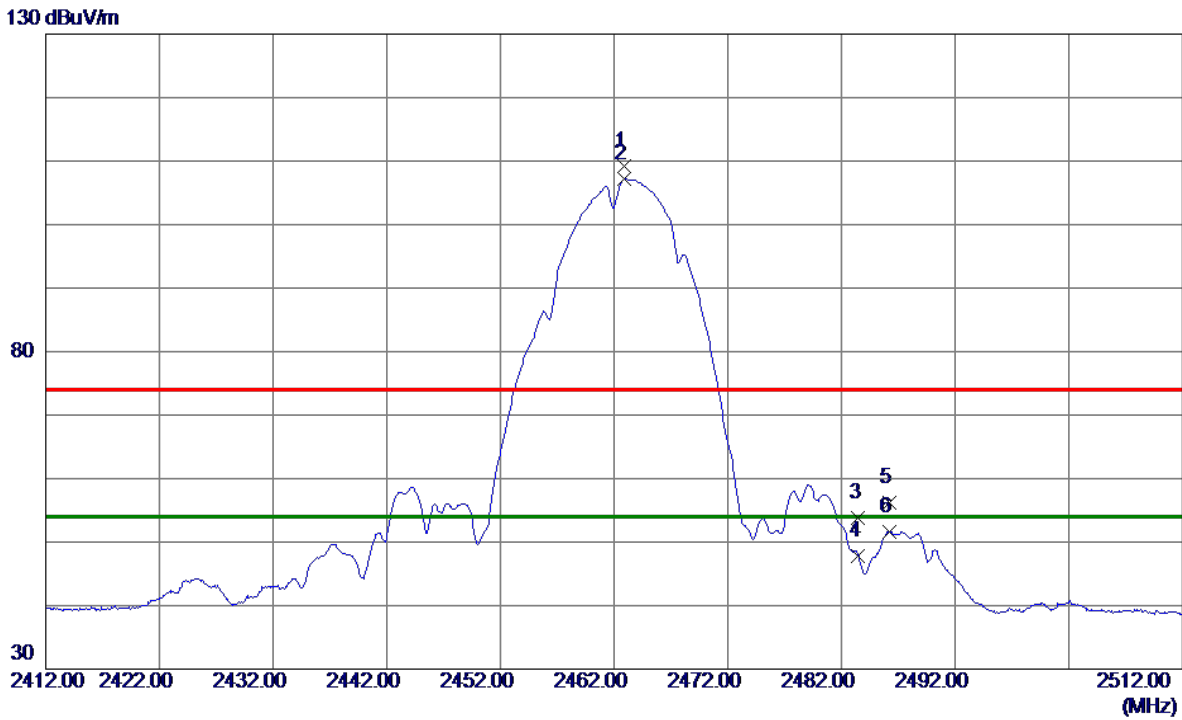

No.	Freq. MHz	Reading Level dBuV/m	Correct Factor dB	Measure ment dBuV/m	Limit dBuV/m	Margin dB	Detector	Comment
1	2462.8500	103.07	6.22	109.29	74.00	35.29	Peak	No Limit
2 *	2462.9000	100.99	6.22	107.21	54.00	53.21	AVG	No Limit
3	2483.5000	47.59	6.23	53.82	74.00	-20.18	Peak	
4	2483.5000	41.59	6.23	47.82	54.00	-6.18	AVG	
5	2486.2000	50.00	6.23	56.23	74.00	-17.77	Peak	
6	2486.2000	45.40	6.23	51.63	54.00	-2.37	AVG	

REMARKS:

- (1) Measurement Value = Reading Level + Correct Factor.
- (2) Margin Level = Measurement Value - Limit Value.

Test Mode	TX B Mode 2462 MHz	Polarization	Horizontal
-----------	--------------------	--------------	------------

80 dBuV/m

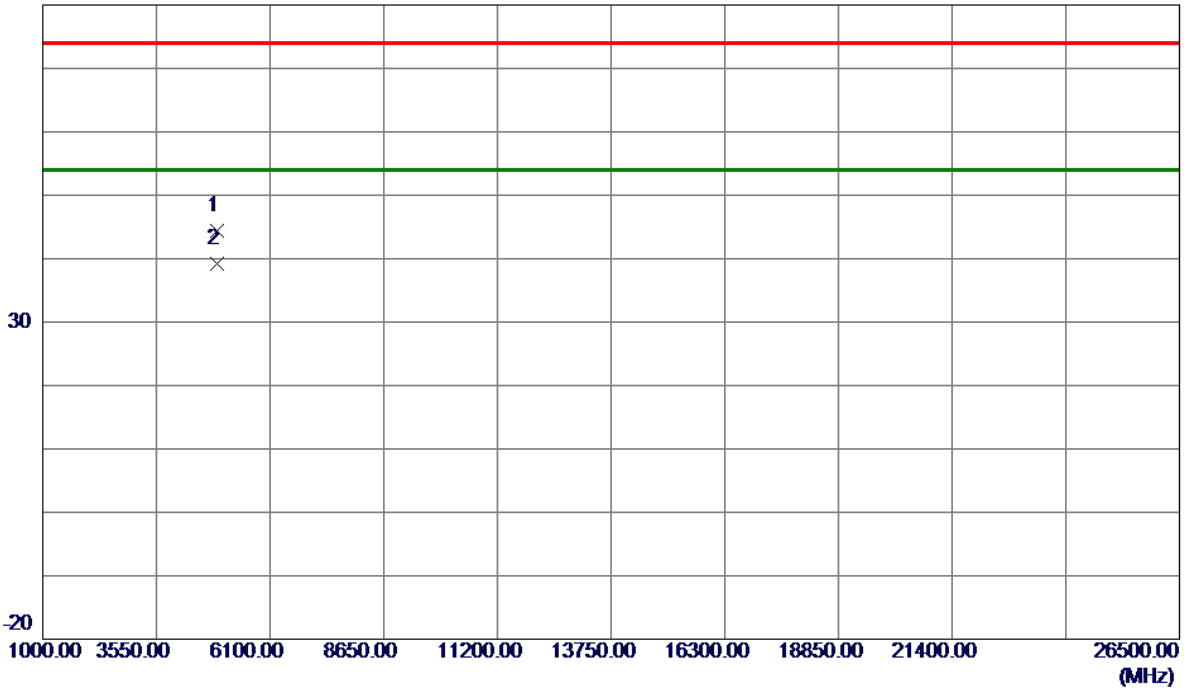

No.	Freq. MHz	Reading Level dBuV/m	Correct Factor dB	Measure ment dBuV/m	Limit dBuV/m	Margin dB	Detector	Comment
1	4923.8920	43.16	1.21	44.37	74.00	-29.63	Peak	
2 *	4923.9700	37.98	1.21	39.19	54.00	-14.81	AVG	

REMARKS:

- (1) Measurement Value = Reading Level + Correct Factor.
- (2) Margin Level = Measurement Value - Limit Value.

Test Mode	TX G Mode 2412 MHz	Polarization	Vertical
-----------	--------------------	--------------	----------

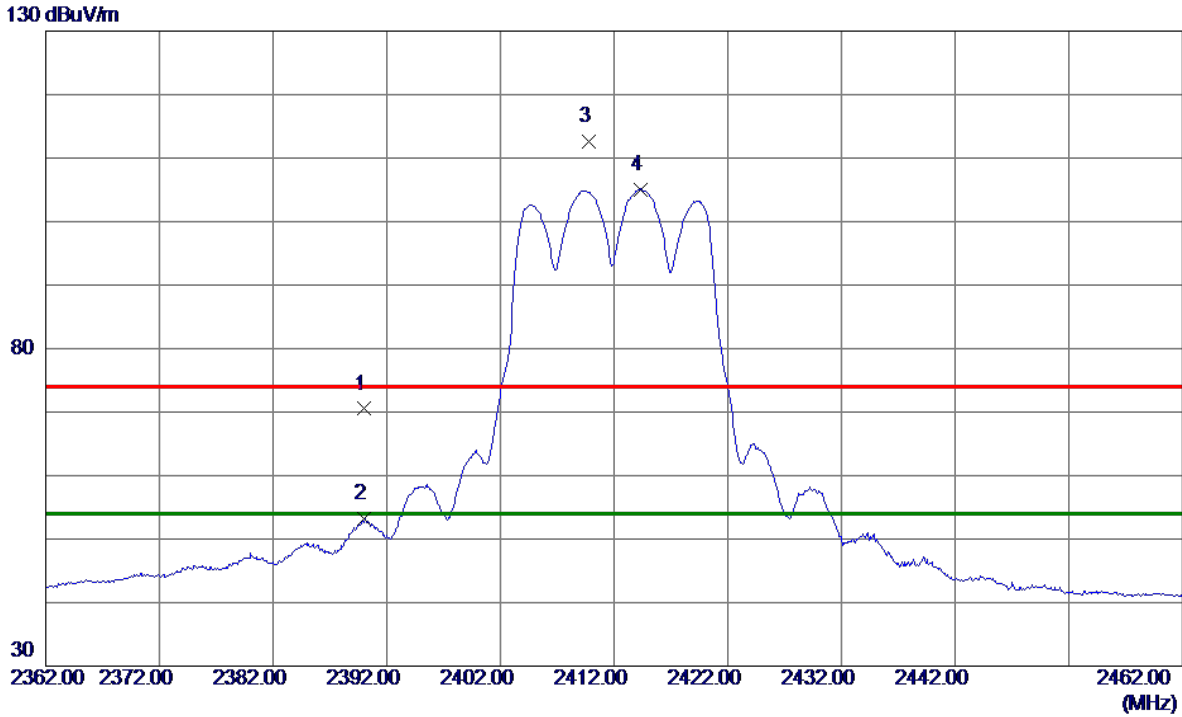

No.	Freq. MHz	Reading Level dBuV/m	Correct Factor dB	Measure ment dBuV/m	Limit dBuV/m	Margin dB	Detector	Comment
1	2390.0000	64.33	6.17	70.50	74.00	-3.50	Peak	
2	2390.0000	46.95	6.17	53.12	54.00	-0.88	AVG	
3	2409.7500	106.49	6.18	112.67	74.00	38.67	Peak	No Limit
4 *	2414.3500	98.92	6.18	105.10	54.00	51.10	AVG	No Limit

REMARKS:

- (1) Measurement Value = Reading Level + Correct Factor.
- (2) Margin Level = Measurement Value - Limit Value.

Test Mode	TX G Mode 2412 MHz	Polarization	Horizontal
-----------	--------------------	--------------	------------

80 dBuV/m

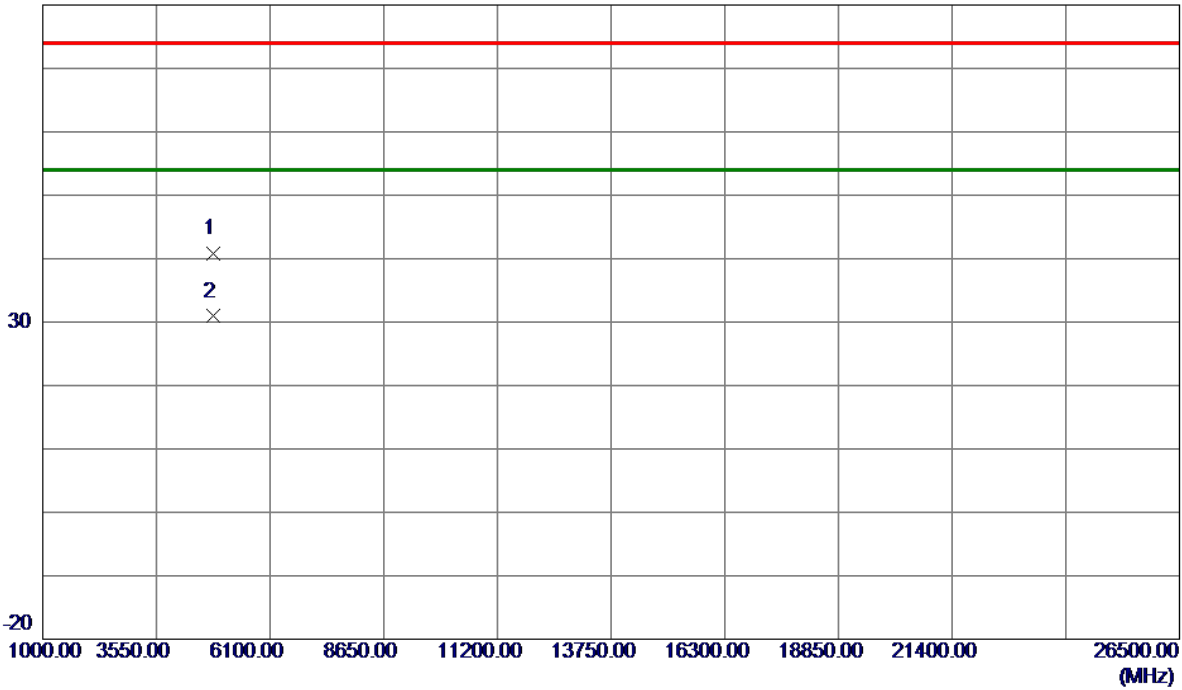

No.	Freq. MHz	Reading Level dBuV/m	Correct Factor dB	Measure ment dBuV/m	Limit dBuV/m	Margin dB	Detector	Comment
1	4825.1720	39.79	0.95	40.74	74.00	-33.26	Peak	
2 *	4826.0950	29.94	0.96	30.90	54.00	-23.10	AVG	

REMARKS:

- (1) Measurement Value = Reading Level + Correct Factor.
- (2) Margin Level = Measurement Value - Limit Value.

Test Mode	TX G Mode 2417 MHz	Polarization	Vertical
-----------	--------------------	--------------	----------

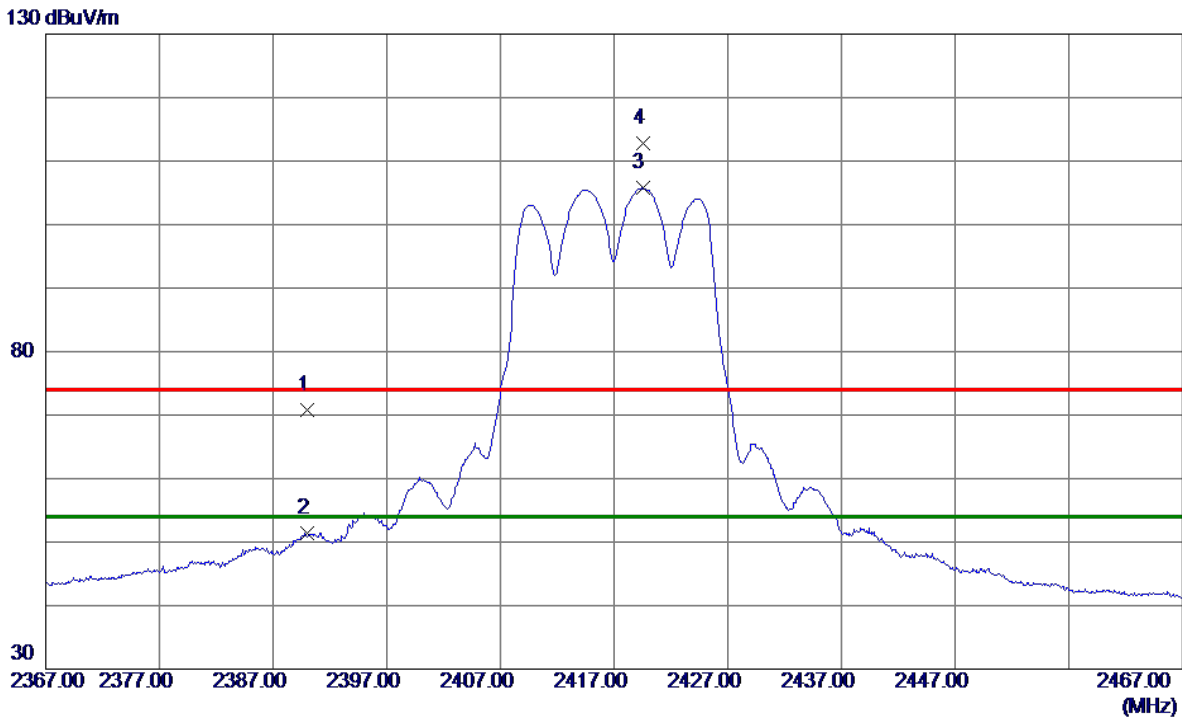

No.	Freq. MHz	Reading Level dBuV/m	Correct Factor dB	Measure ment dBuV/m	Limit dBuV/m	Margin dB	Detector	Comment
1	2390.0000	64.60	6.17	70.77	74.00	-3.23	Peak	
2	2390.0000	45.29	6.17	51.46	54.00	-2.54	AVG	
3 *	2419.5000	99.58	6.19	105.77	54.00	51.77	AVG	No Limit
4	2419.5500	106.66	6.19	112.85	74.00	38.85	Peak	No Limit

REMARKS:

- (1) Measurement Value = Reading Level + Correct Factor.
- (2) Margin Level = Measurement Value - Limit Value.

Test Mode	TX G Mode 2417 MHz	Polarization	Horizontal
-----------	--------------------	--------------	------------

80 dBuV/m

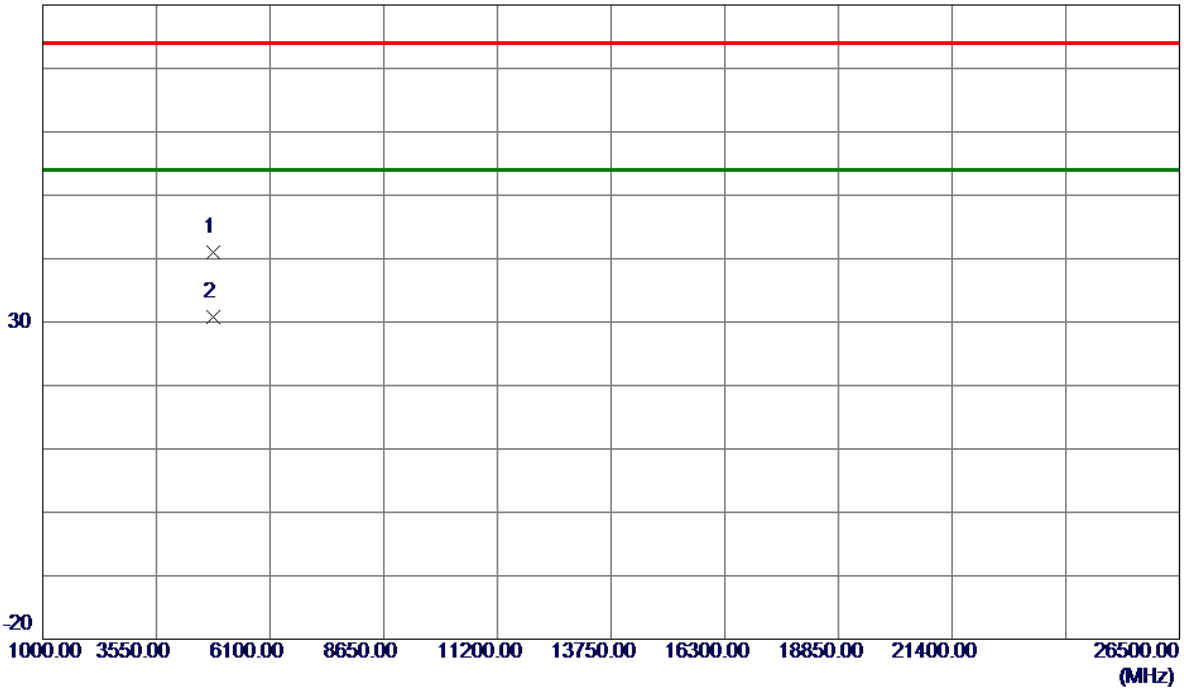

No.	Freq. MHz	Reading Level dBuV/m	Correct Factor dB	Measure ment dBuV/m	Limit dBuV/m	Margin dB	Detector	Comment
1	4833.2400	40.00	0.97	40.97	74.00	-33.03	Peak	
2 *	4834.3150	29.90	0.98	30.88	54.00	-23.12	AVG	

REMARKS:

- (1) Measurement Value = Reading Level + Correct Factor.
- (2) Margin Level = Measurement Value - Limit Value.

Test Mode	TX G Mode 2437 MHz	Polarization	Vertical
-----------	--------------------	--------------	----------

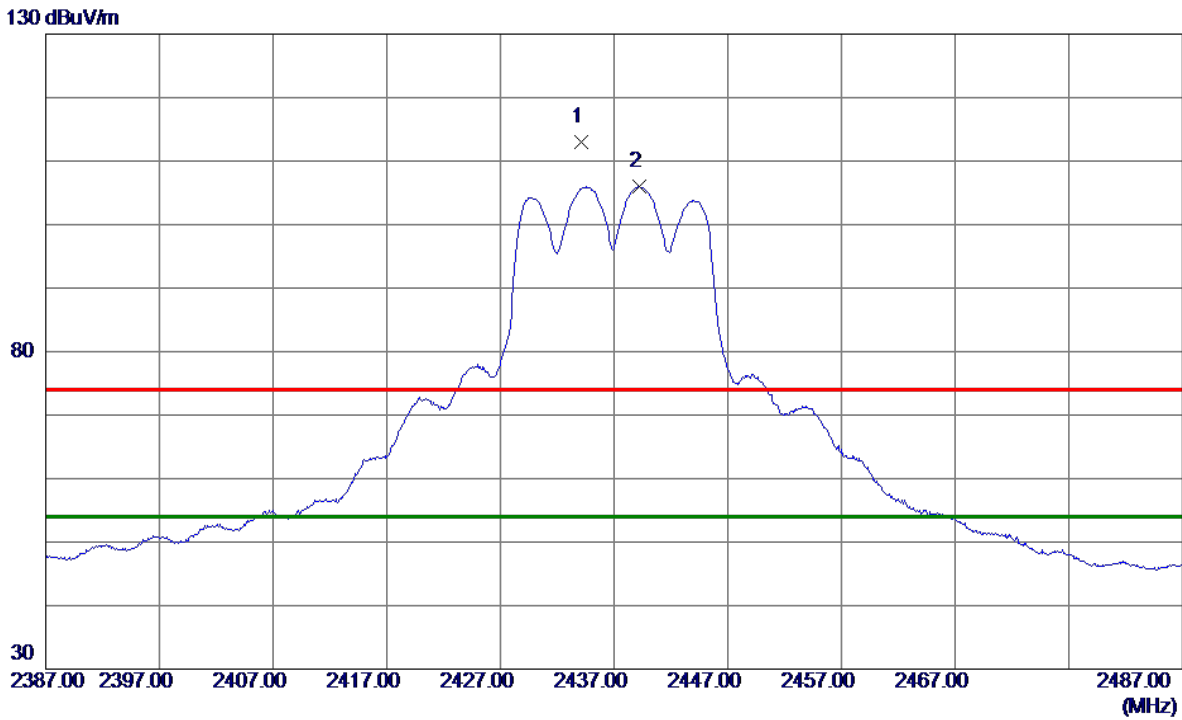

No.	Freq. MHz	Reading Level dBuV/m	Correct Factor dB	Measure ment dBuV/m	Limit dBuV/m	Margin dB	Detector	Comment
1	2434.1000	106.85	6.20	113.05	74.00	39.05	Peak	No Limit
2 *	2439.2500	99.76	6.20	105.96	54.00	51.96	AVG	No Limit

REMARKS:

- (1) Measurement Value = Reading Level + Correct Factor.
- (2) Margin Level = Measurement Value - Limit Value.

Test Mode	TX G Mode 2437 MHz	Polarization	Horizontal
-----------	--------------------	--------------	------------

80 dBuV/m

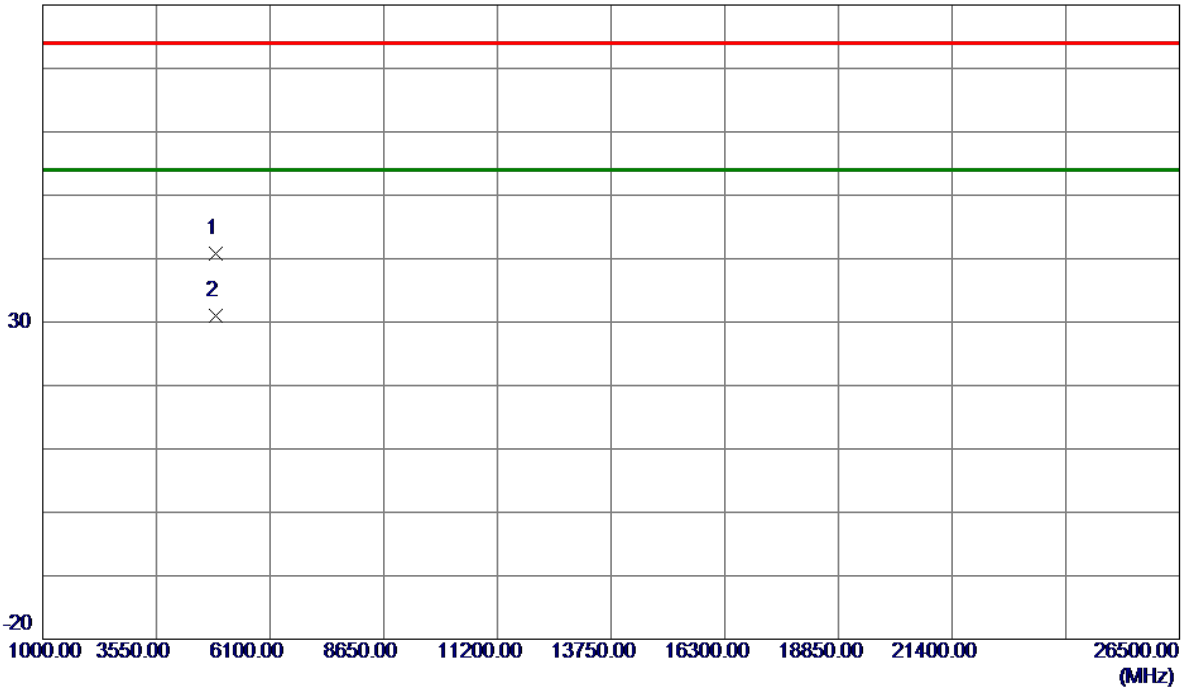

No.	Freq. MHz	Reading Level dBuV/m	Correct Factor dB	Measure ment dBuV/m	Limit dBuV/m	Margin dB	Detector	Comment
1	4872.8920	39.80	1.08	40.88	74.00	-33.12	Peak	
2 *	4874.9900	29.94	1.08	31.02	54.00	-22.98	AVG	

REMARKS:

- (1) Measurement Value = Reading Level + Correct Factor.
- (2) Margin Level = Measurement Value - Limit Value.

Test Mode	TX G Mode 2457 MHz	Polarization	Vertical
-----------	--------------------	--------------	----------

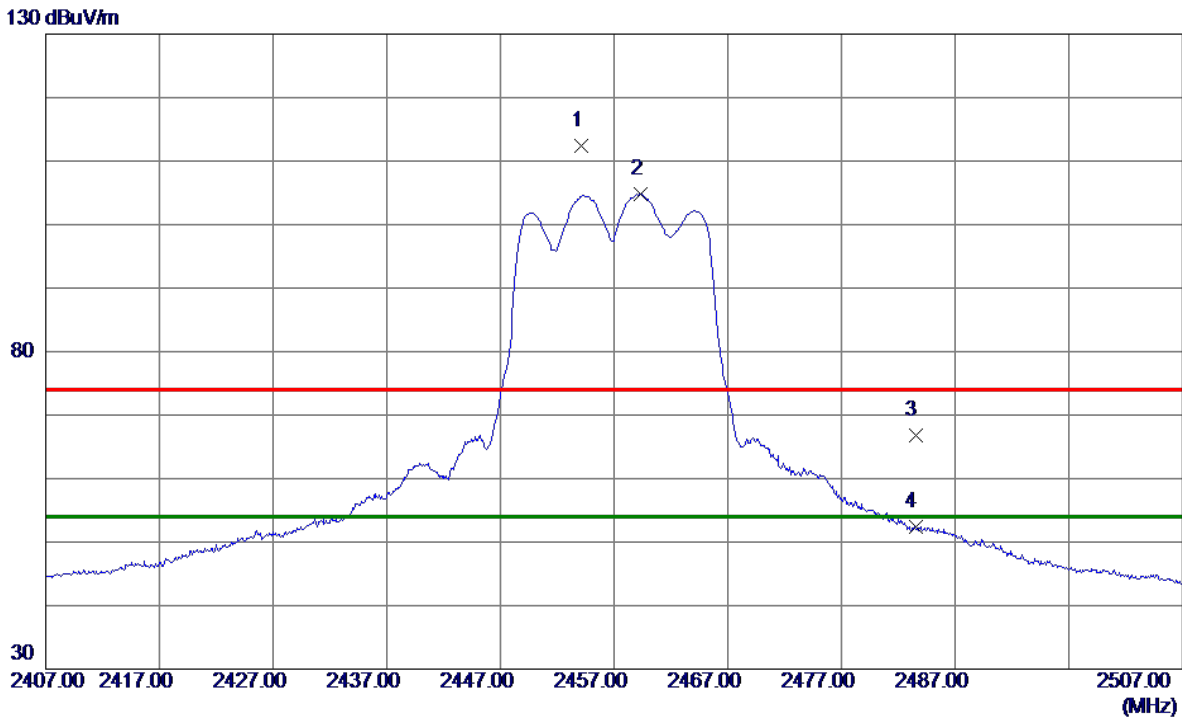

No.	Freq. MHz	Reading Level dBuV/m	Correct Factor dB	Measure ment dBuV/m	Limit dBuV/m	Margin dB	Detector	Comment
1	2454.1500	106.20	6.21	112.41	74.00	38.41	Peak	No Limit
2 *	2459.3500	98.63	6.21	104.84	54.00	50.84	AVG	No Limit
3	2483.5000	60.59	6.23	66.82	74.00	-7.18	Peak	
4	2483.5000	46.20	6.23	52.43	54.00	-1.57	AVG	

REMARKS:

- (1) Measurement Value = Reading Level + Correct Factor.
- (2) Margin Level = Measurement Value - Limit Value.

Test Mode	TX G Mode 2457 MHz	Polarization	Horizontal
-----------	--------------------	--------------	------------

80 dBuV/m

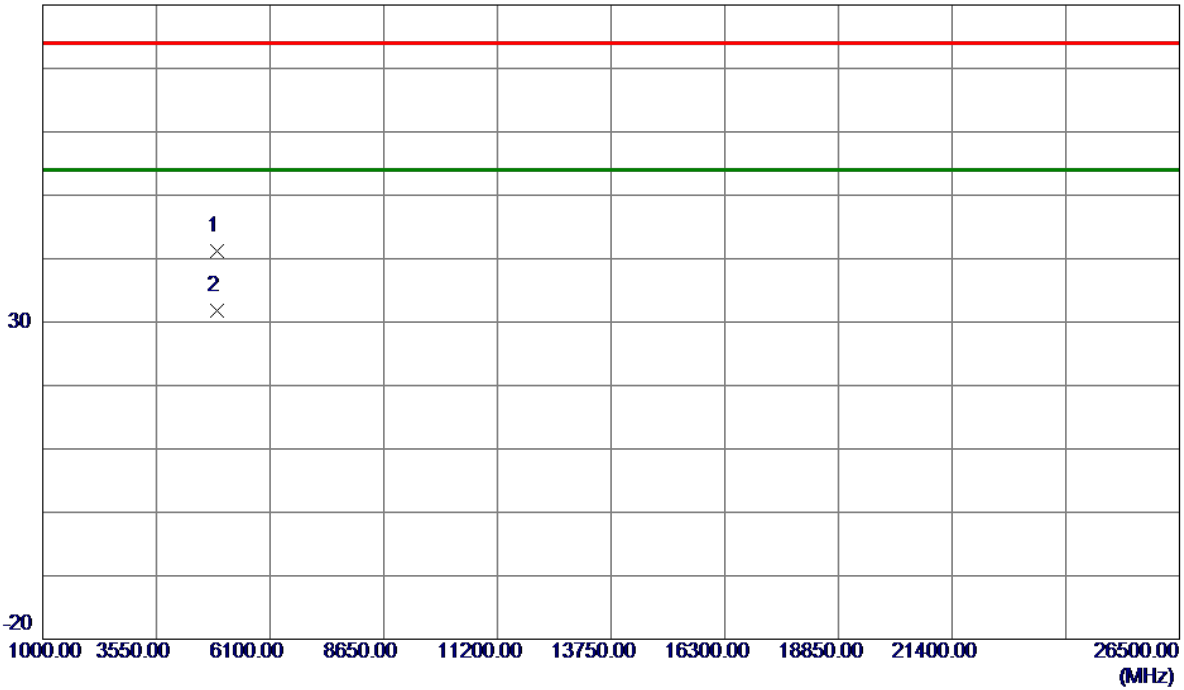

No.	Freq. MHz	Reading Level dBuV/m	Correct Factor dB	Measure ment dBuV/m	Limit dBuV/m	Margin dB	Detector	Comment
1	4913.6770	40.11	1.18	41.29	74.00	-32.71	Peak	
2 *	4914.0780	30.57	1.18	31.75	54.00	-22.25	AVG	

REMARKS:

- (1) Measurement Value = Reading Level + Correct Factor.
- (2) Margin Level = Measurement Value - Limit Value.

Test Mode	TX G Mode 2462 MHz	Polarization	Vertical
-----------	--------------------	--------------	----------

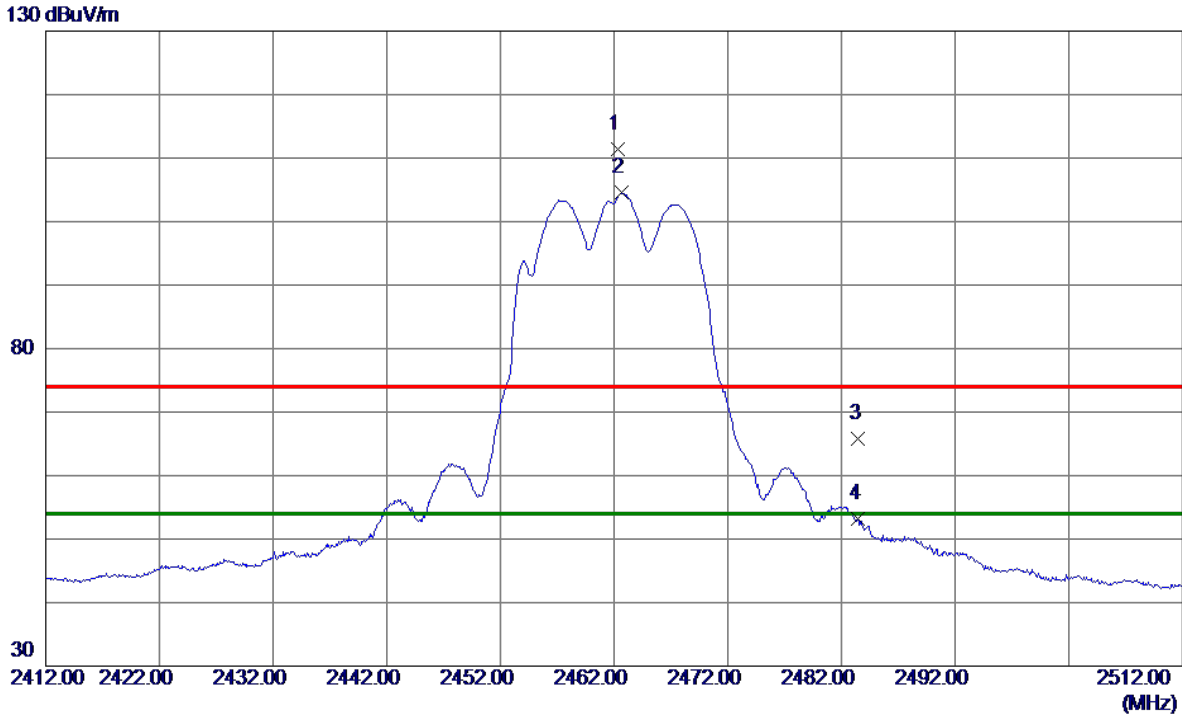

No.	Freq. MHz	Reading Level dBuV/m	Correct Factor dB	Measure ment dBuV/m	Limit dBuV/m	Margin dB	Detector	Comment
1	2462.3500	105.24	6.22	111.46	74.00	37.46	Peak	No Limit
2 *	2462.6500	98.30	6.22	104.52	54.00	50.52	AVG	No Limit
3	2483.5000	59.59	6.23	65.82	74.00	-8.18	Peak	
4	2483.5000	46.96	6.23	53.19	54.00	-0.81	AVG	

REMARKS:

- (1) Measurement Value = Reading Level + Correct Factor.
- (2) Margin Level = Measurement Value - Limit Value.

Test Mode	TX G Mode 2462 MHz	Polarization	Horizontal
-----------	--------------------	--------------	------------

80 dBuV/m

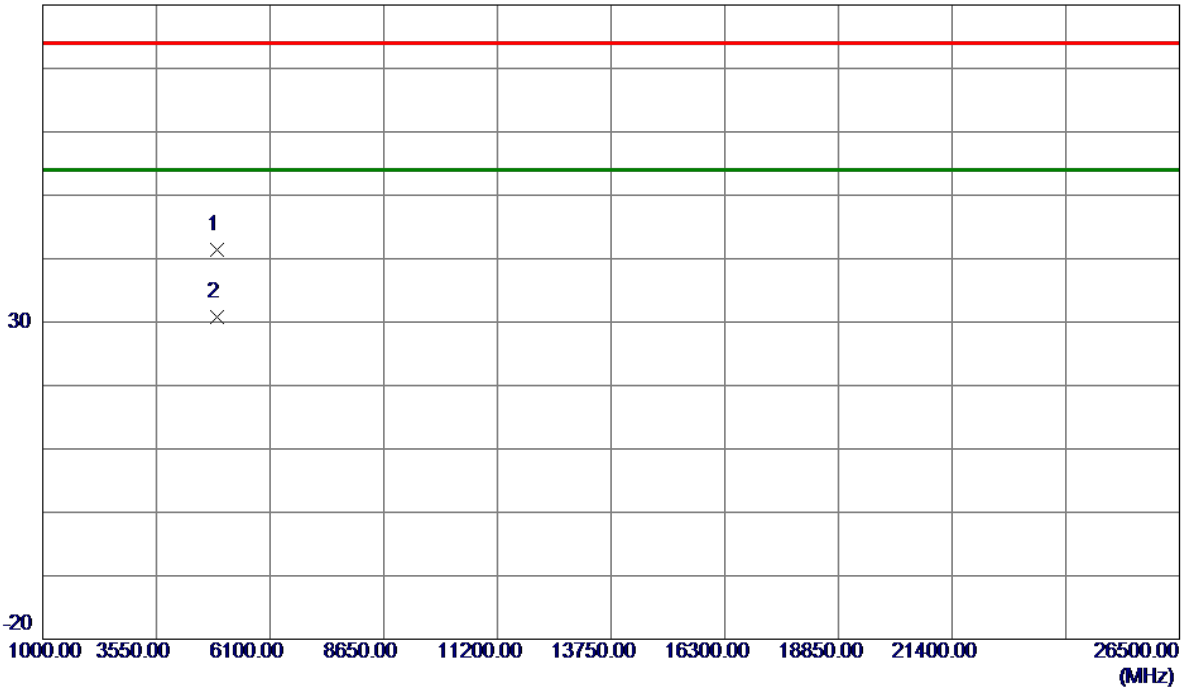

No.	Freq. MHz	Reading Level dBuV/m	Correct Factor dB	Measure ment dBuV/m	Limit dBuV/m	Margin dB	Detector	Comment
1	4919.9900	40.28	1.20	41.48	74.00	-32.52	Peak	
2 *	4923.8500	29.50	1.21	30.71	54.00	-23.29	AVG	

REMARKS:

- (1) Measurement Value = Reading Level + Correct Factor.
- (2) Margin Level = Measurement Value - Limit Value.

Test Mode	TX N(HT20) Mode 2412 MHz	Polarization	Vertical
-----------	--------------------------	--------------	----------

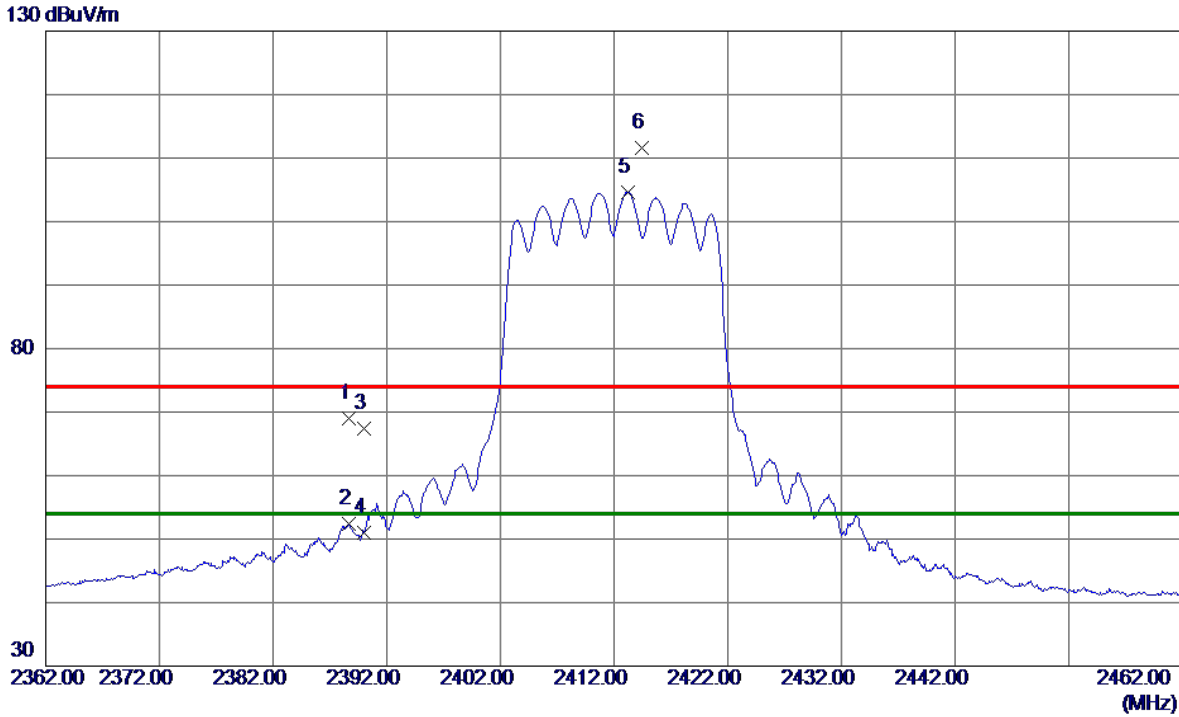

No.	Freq. MHz	Reading Level dBuV/m	Correct Factor dB	Measure ment dBuV/m	Limit dBuV/m	Margin dB	Detector	Comment
1	2388.7000	62.84	6.17	69.01	74.00	-4.99	Peak	
2	2388.7000	46.25	6.17	52.42	54.00	-1.58	AVG	
3	2390.0000	61.32	6.17	67.49	74.00	-6.51	Peak	
4	2390.0000	44.76	6.17	50.93	54.00	-3.07	AVG	
5 *	2413.2000	98.47	6.18	104.65	54.00	50.65	AVG	No Limit
6	2414.4000	105.50	6.18	111.68	74.00	37.68	Peak	No Limit

REMARKS:

- (1) Measurement Value = Reading Level + Correct Factor.
- (2) Margin Level = Measurement Value - Limit Value.

Test Mode	TX N(HT20) Mode 2412 MHz	Polarization	Horizontal
-----------	--------------------------	--------------	------------

80 dBuV/m

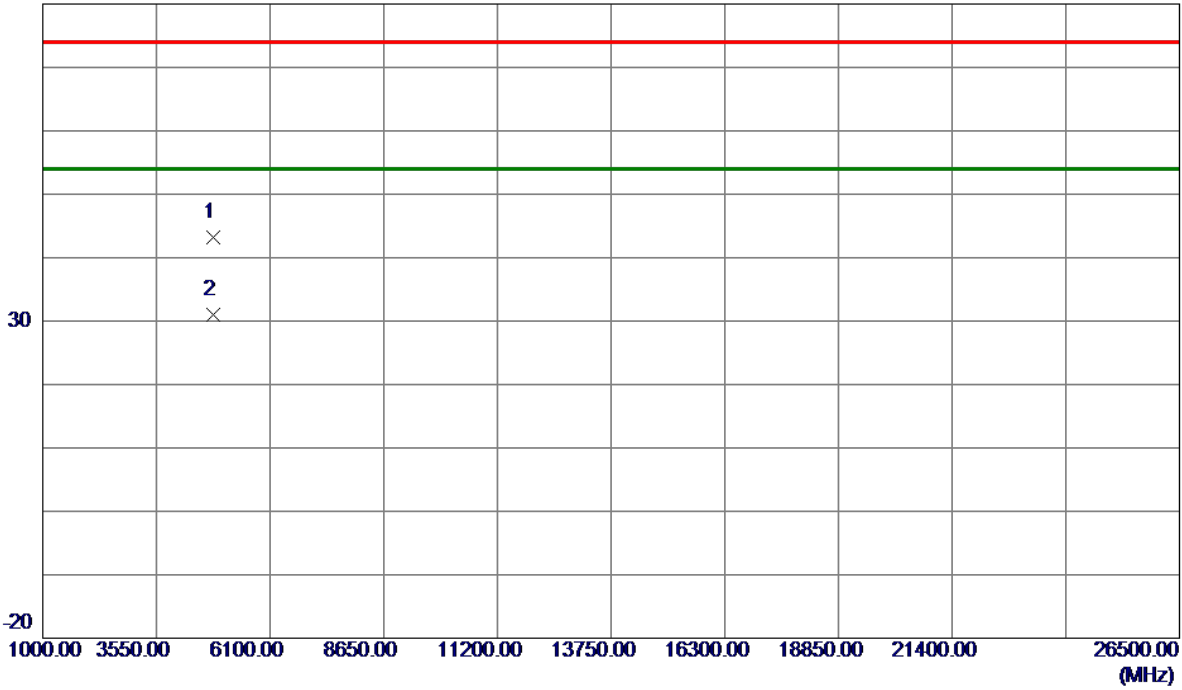

No.	Freq. MHz	Reading Level dBuV/m	Correct Factor dB	Measure ment dBuV/m	Limit dBuV/m	Margin dB	Detector	Comment
1	4823.6930	42.19	0.95	43.14	74.00	-30.86	Peak	
2 *	4824.3580	30.11	0.95	31.06	54.00	-22.94	AVG	

REMARKS:

- (1) Measurement Value = Reading Level + Correct Factor.
- (2) Margin Level = Measurement Value - Limit Value.

Test Mode	TX N(HT20) Mode 2417 MHz	Polarization	Vertical
-----------	--------------------------	--------------	----------

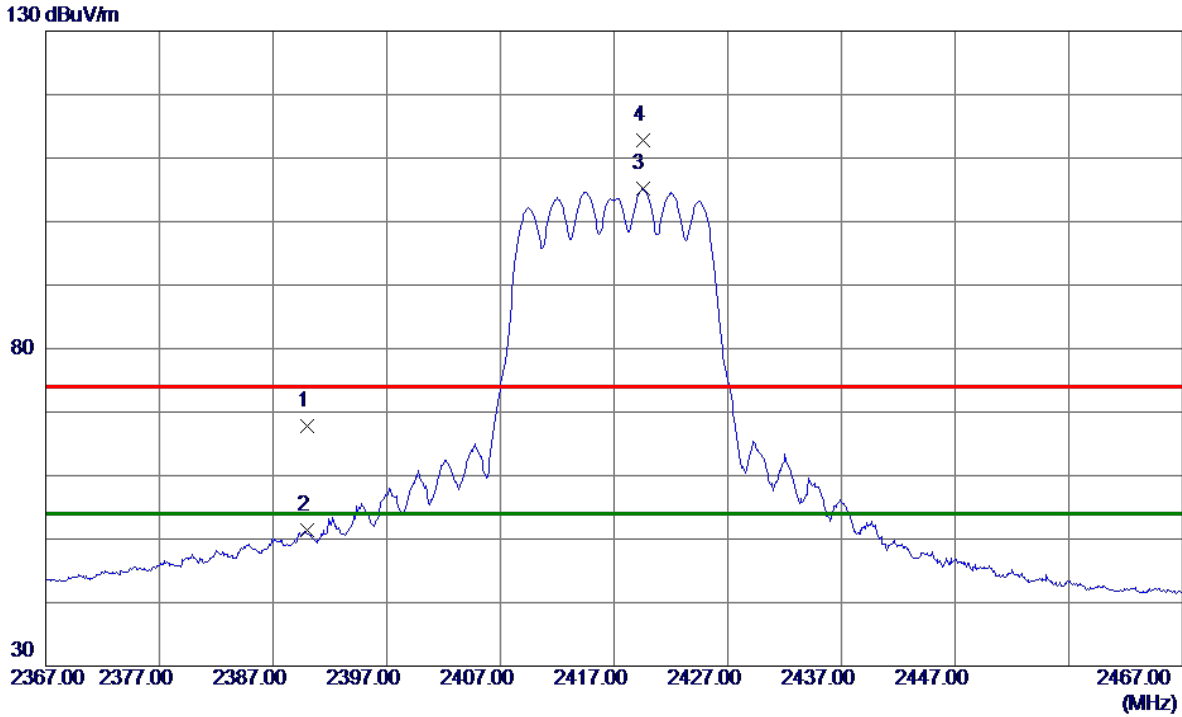

No.	Freq. MHz	Reading Level dBuV/m	Correct Factor dB	Measure ment dBuV/m	Limit dBuV/m	Margin dB	Detector	Comment
1	2390.0000	61.65	6.17	67.82	74.00	-6.18	Peak	
2	2390.0000	45.28	6.17	51.45	54.00	-2.55	AVG	
3 *	2419.5000	98.97	6.19	105.16	54.00	51.16	AVG	No Limit
4	2419.6000	106.52	6.19	112.71	74.00	38.71	Peak	No Limit

REMARKS:

- (1) Measurement Value = Reading Level + Correct Factor.
- (2) Margin Level = Measurement Value - Limit Value.

Test Mode	TX N(HT20) Mode 2417 MHz	Polarization	Horizontal
-----------	--------------------------	--------------	------------

80 dBuV/m

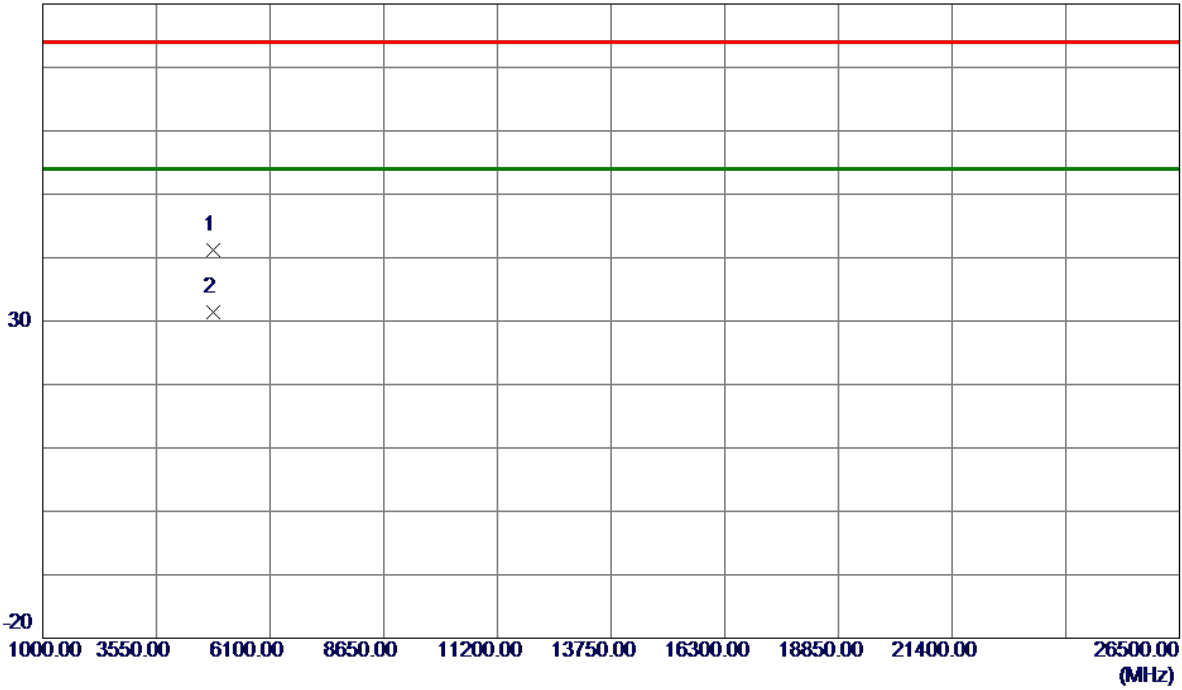

No.	Freq. MHz	Reading Level dBuV/m	Correct Factor dB	Measure ment dBuV/m	Limit dBuV/m	Margin dB	Detector	Comment
1	4832.4800	40.31	0.97	41.28	74.00	-32.72	Peak	
2 *	4834.7919	30.47	0.98	31.45	54.00	-22.55	AVG	

REMARKS:

- (1) Measurement Value = Reading Level + Correct Factor.
- (2) Margin Level = Measurement Value - Limit Value.

Test Mode	TX N(HT20) Mode 2437 MHz	Polarization	Vertical
-----------	--------------------------	--------------	----------

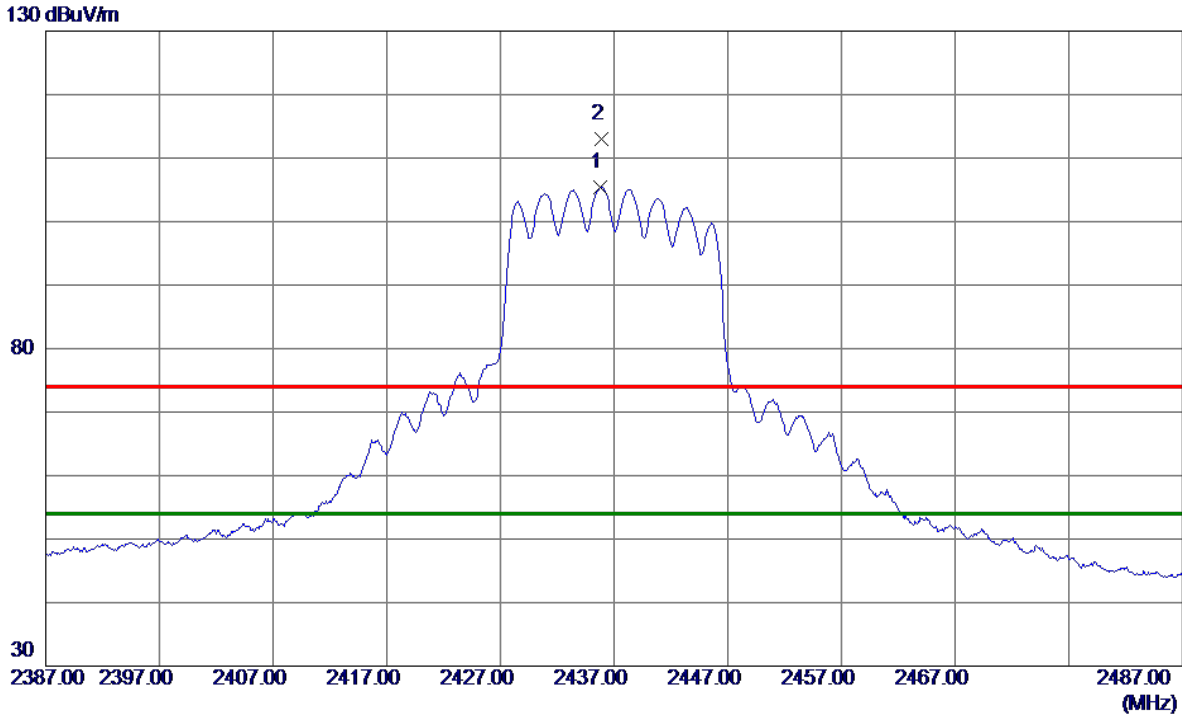

No.	Freq. MHz	Reading Level dBuV/m	Correct Factor dB	Measure ment dBuV/m	Limit dBuV/m	Margin dB	Detector	Comment
1 *	2435.8000	99.28	6.20	105.48	54.00	51.48	AVG	No Limit
2	2435.9000	106.71	6.20	112.91	74.00	38.91	Peak	No Limit

REMARKS:

- (1) Measurement Value = Reading Level + Correct Factor.
- (2) Margin Level = Measurement Value - Limit Value.

Test Mode	TX N(HT20) Mode 2437 MHz	Polarization	Horizontal
-----------	--------------------------	--------------	------------

80 dBuV/m

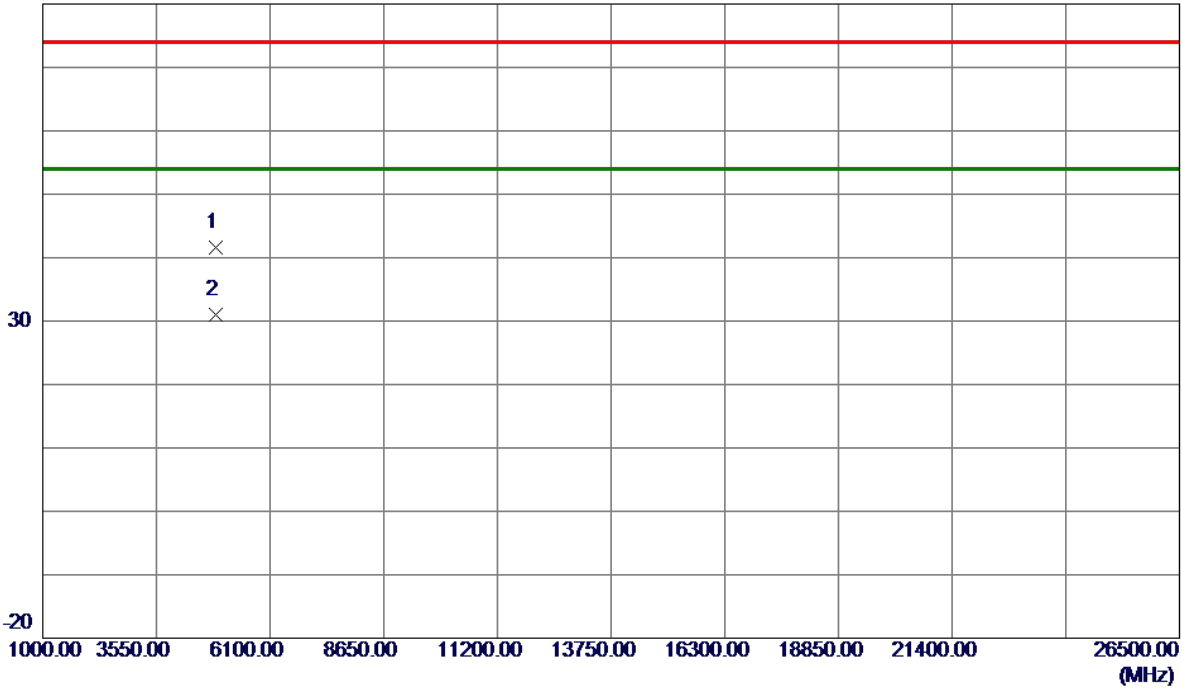

No.	Freq. MHz	Reading Level dBuV/m	Correct Factor dB	Measure ment dBuV/m	Limit dBuV/m	Margin dB	Detector	Comment
1	4873.4950	40.55	1.08	41.63	74.00	-32.37	Peak	
2 *	4875.0470	29.94	1.08	31.02	54.00	-22.98	AVG	

REMARKS:

- (1) Measurement Value = Reading Level + Correct Factor.
- (2) Margin Level = Measurement Value - Limit Value.

Test Mode	TX N(HT20) Mode 2457 MHz	Polarization	Vertical
-----------	--------------------------	--------------	----------

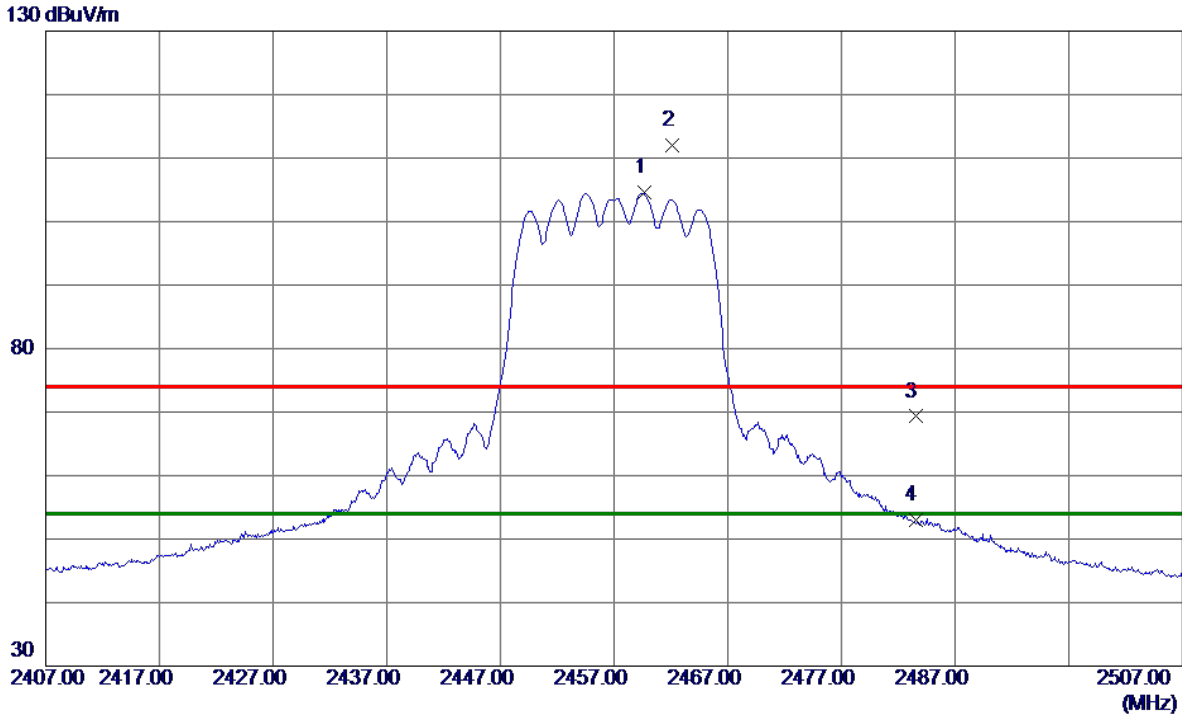

No.	Freq. MHz	Reading Level dBuV/m	Correct Factor dB	Measure ment dBuV/m	Limit dBuV/m	Margin dB	Detector	Comment
1 *	2459.6500	98.30	6.21	104.51	54.00	50.51	AVG	No Limit
2	2462.1500	105.74	6.21	111.95	74.00	37.95	Peak	No Limit
3	2483.5000	63.07	6.23	69.30	74.00	-4.70	Peak	
4	2483.5000	46.68	6.23	52.91	54.00	-1.09	AVG	

REMARKS:

- (1) Measurement Value = Reading Level + Correct Factor.
- (2) Margin Level = Measurement Value - Limit Value.

Test Mode	TX N(HT20) Mode 2457 MHz	Polarization	Horizontal
-----------	--------------------------	--------------	------------

80 dBuV/m

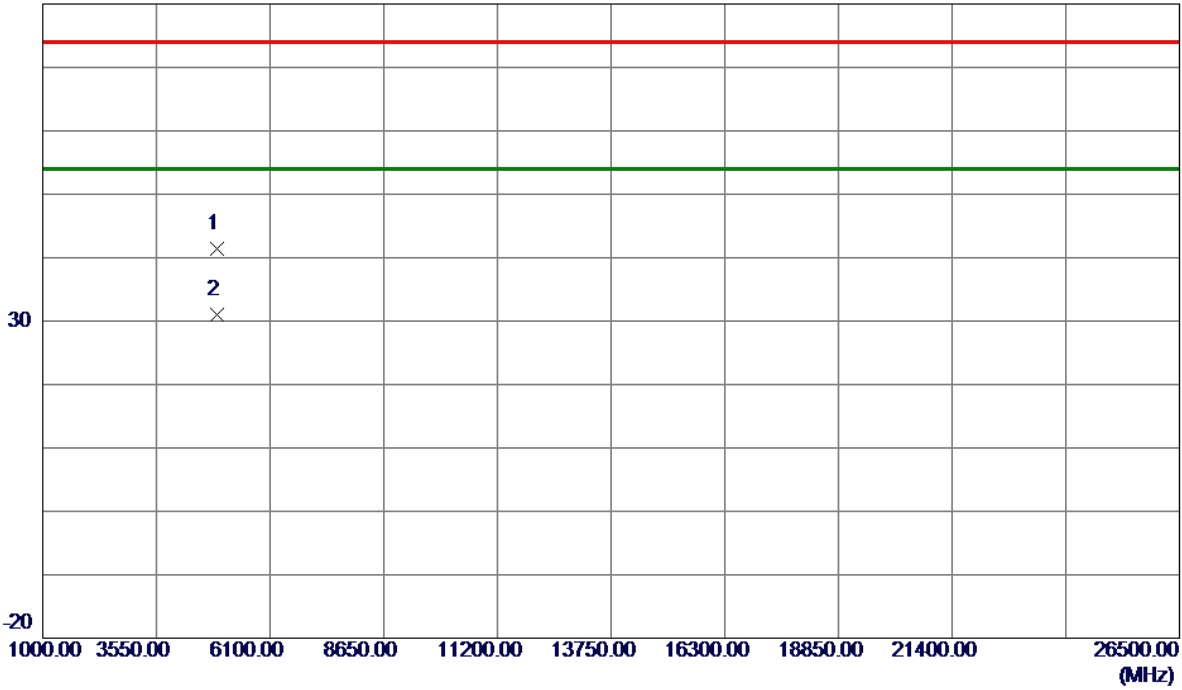

No.	Freq. MHz	Reading Level dBuV/m	Correct Factor dB	Measure ment dBuV/m	Limit dBuV/m	Margin dB	Detector	Comment
1	4912.2730	40.17	1.18	41.35	74.00	-32.65	Peak	
2 *	4916.4169	29.75	1.19	30.94	54.00	-23.06	AVG	

REMARKS:

- (1) Measurement Value = Reading Level + Correct Factor.
- (2) Margin Level = Measurement Value - Limit Value.

Test Mode	TX N(HT20) Mode 2462 MHz	Polarization	Vertical
-----------	--------------------------	--------------	----------

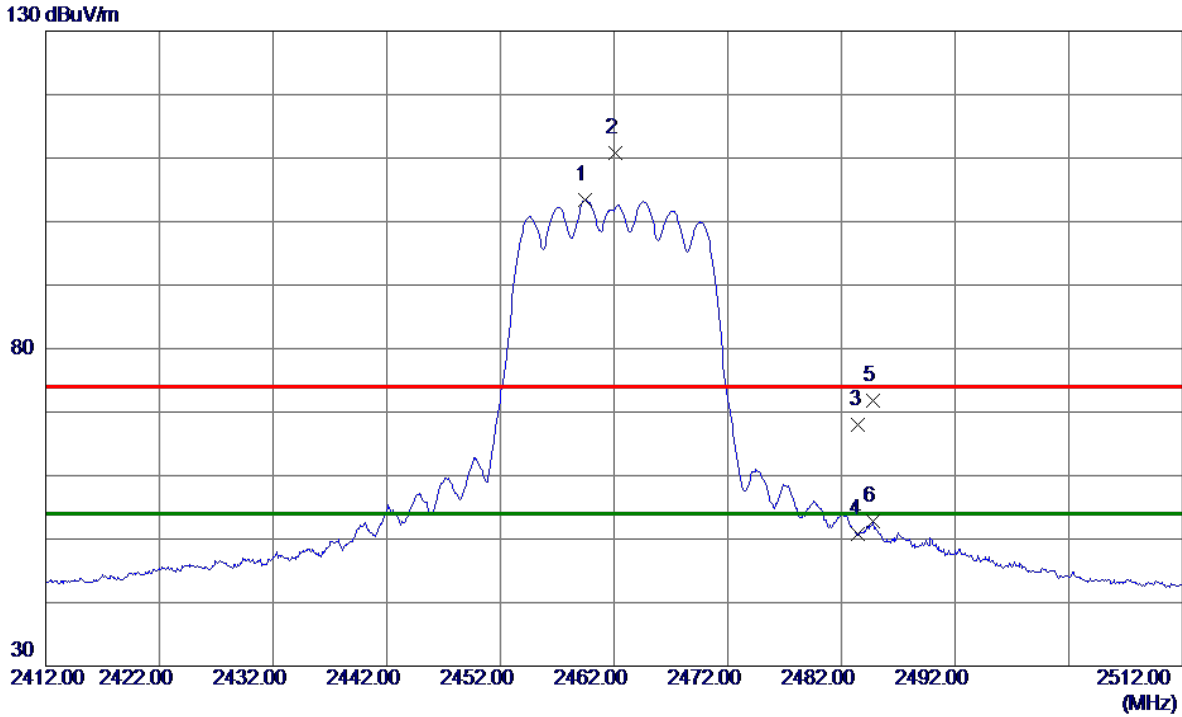

No.	Freq. MHz	Reading Level dBuV/m	Correct Factor dB	Measure ment dBuV/m	Limit dBuV/m	Margin dB	Detector	Comment
1 *	2459.4500	97.13	6.21	103.34	54.00	49.34	AVG	No Limit
2	2462.1000	104.66	6.21	110.87	74.00	36.87	Peak	No Limit
3	2483.5000	61.76	6.23	67.99	74.00	-6.01	Peak	
4	2483.5000	44.60	6.23	50.83	54.00	-3.17	AVG	
5	2484.8000	65.50	6.23	71.73	74.00	-2.27	Peak	
6	2484.8000	46.52	6.23	52.75	54.00	-1.25	AVG	

REMARKS:

- (1) Measurement Value = Reading Level + Correct Factor.
- (2) Margin Level = Measurement Value - Limit Value.

Test Mode	TX N(HT20) Mode 2462 MHz	Polarization	Horizontal
-----------	--------------------------	--------------	------------

80 dBuV/m

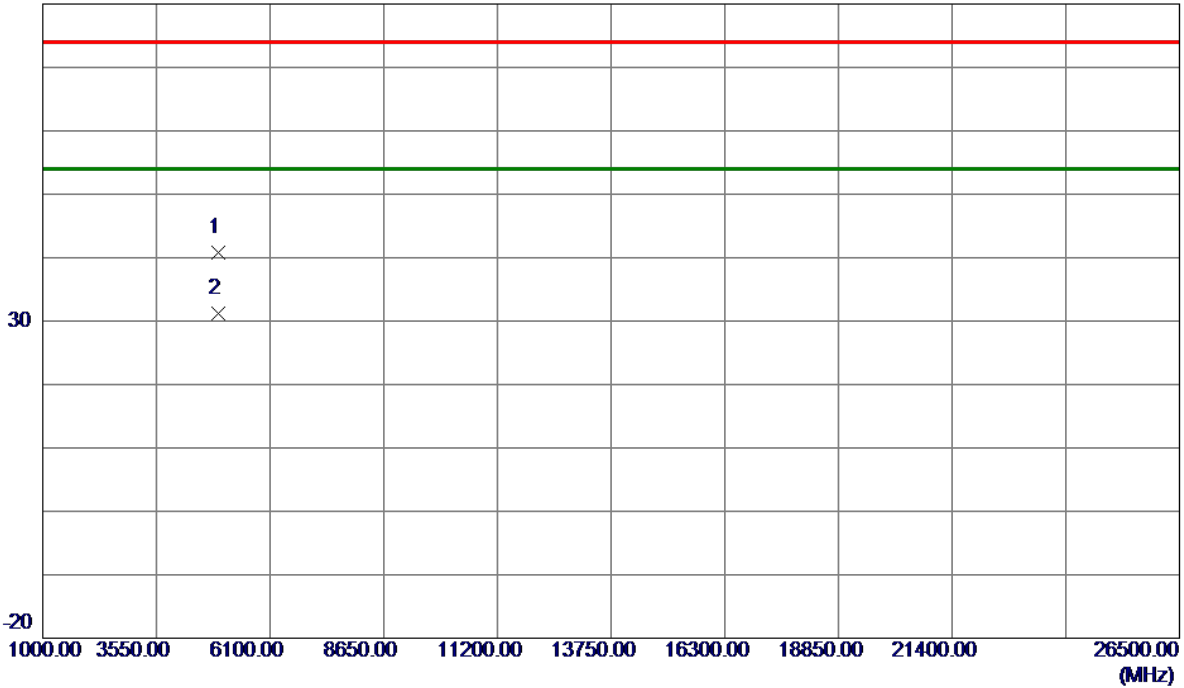

No.	Freq. MHz	Reading Level dBuV/m	Correct Factor dB	Measure ment dBuV/m	Limit dBuV/m	Margin dB	Detector	Comment
1	4924.4720	39.63	1.21	40.84	74.00	-33.16	Peak	
2 *	4926.2330	29.90	1.21	31.11	54.00	-22.89	AVG	

REMARKS:

- (1) Measurement Value = Reading Level + Correct Factor.
- (2) Margin Level = Measurement Value - Limit Value.

Test Mode	TX N(HT40) Mode 2422 MHz	Polarization	Vertical
-----------	--------------------------	--------------	----------

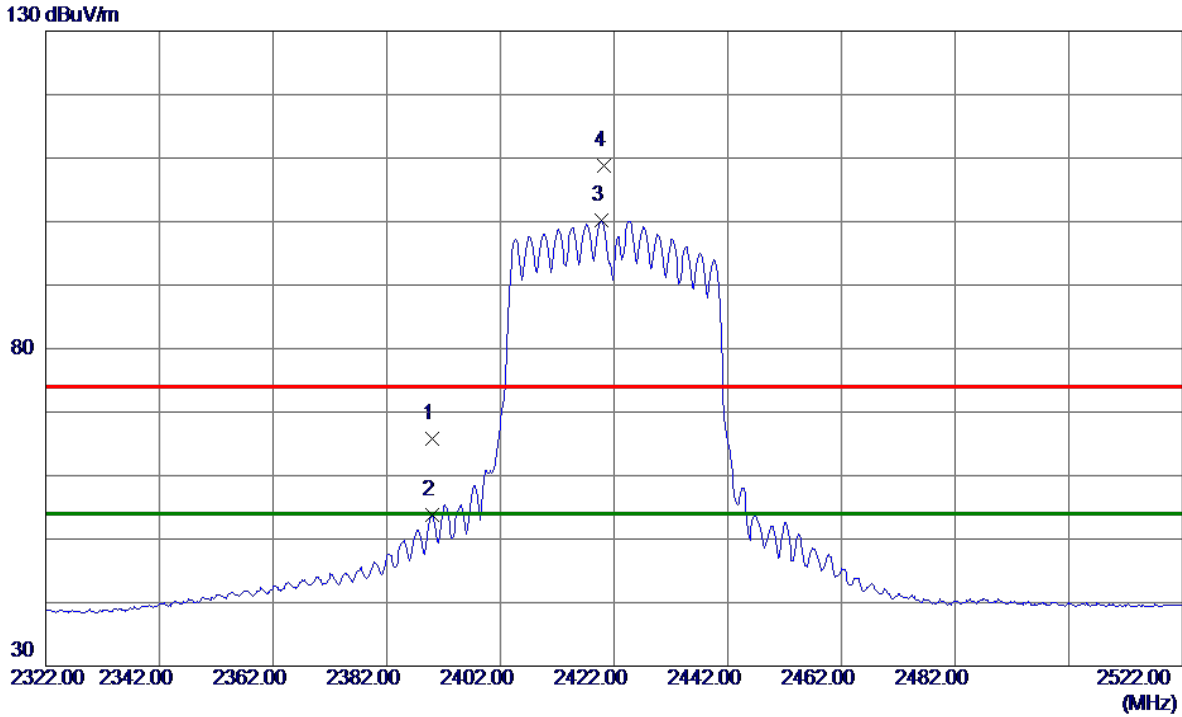

No.	Freq. MHz	Reading Level dBuV/m	Correct Factor dB	Measure ment dBuV/m	Limit dBuV/m	Margin dB	Detector	Comment
1	2390.0000	59.57	6.17	65.74	74.00	-8.26	Peak	
2	2390.0000	47.64	6.17	53.81	54.00	-0.19	AVG	
3 *	2419.7000	94.05	6.19	100.24	54.00	46.24	AVG	No Limit
4	2420.2000	102.52	6.19	108.71	74.00	34.71	Peak	No Limit

REMARKS:

- (1) Measurement Value = Reading Level + Correct Factor.
- (2) Margin Level = Measurement Value - Limit Value.

Test Mode	TX N(HT40) Mode 2422 MHz	Polarization	Horizontal
-----------	--------------------------	--------------	------------

80 dBuV/m

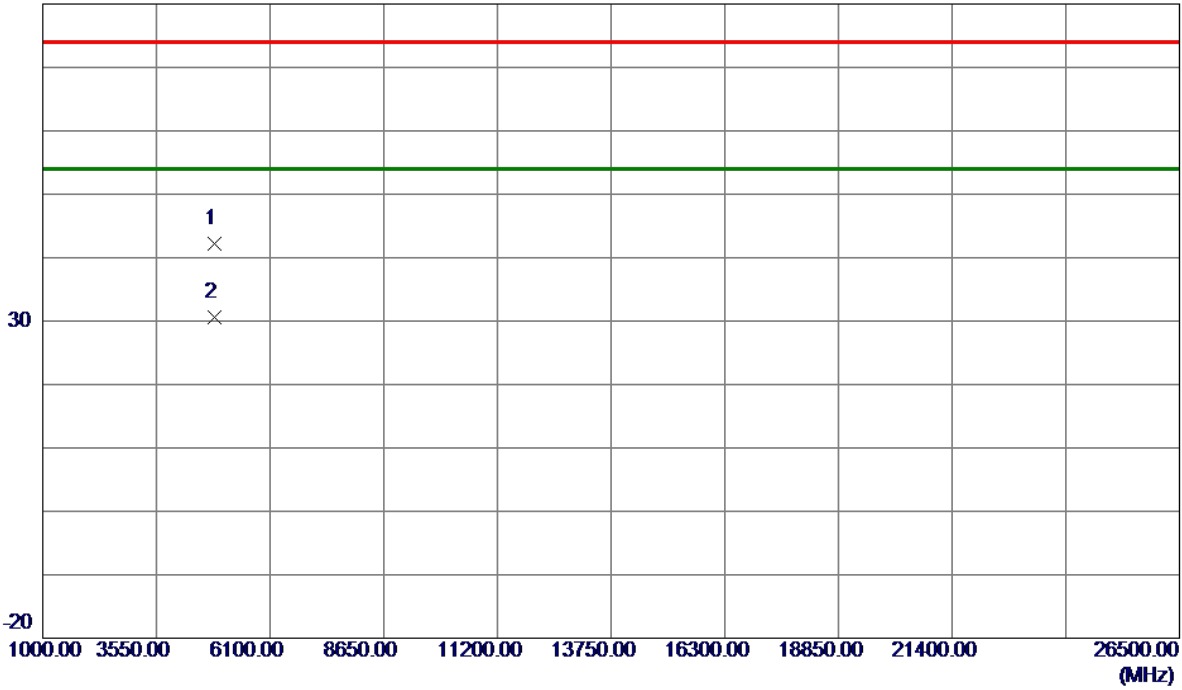

No.	Freq. MHz	Reading Level dBuV/m	Correct Factor dB	Measure ment dBuV/m	Limit dBuV/m	Margin dB	Detector	Comment
1	4844.0250	41.18	1.00	42.18	74.00	-31.82	Peak	
2 *	4846.5000	29.52	1.01	30.53	54.00	-23.47	AVG	

REMARKS:

- (1) Measurement Value = Reading Level + Correct Factor.
- (2) Margin Level = Measurement Value - Limit Value.

Test Mode	TX N(HT40) Mode 2427 MHz	Polarization	Vertical
-----------	--------------------------	--------------	----------

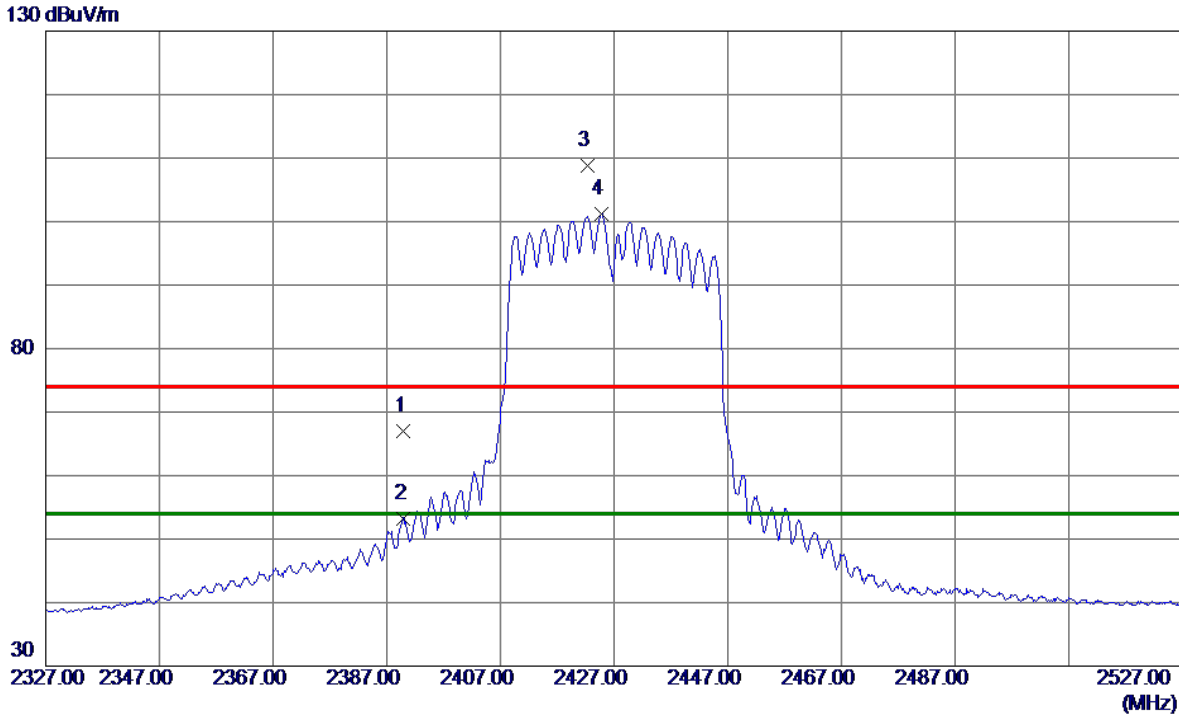

No.	Freq. MHz	Reading Level dBuV/m	Correct Factor dB	Measure ment dBuV/m	Limit dBuV/m	Margin dB	Detector	Comment
1	2390.0000	60.85	6.17	67.02	74.00	-6.98	Peak	
2	2390.0000	47.06	6.17	53.23	54.00	-0.77	AVG	
3	2422.3000	102.56	6.19	108.75	74.00	34.75	Peak	No Limit
4 *	2424.7000	94.98	6.19	101.17	54.00	47.17	AVG	No Limit

REMARKS:

- (1) Measurement Value = Reading Level + Correct Factor.
- (2) Margin Level = Measurement Value - Limit Value.

Test Mode	TX N(HT40) Mode 2427 MHz	Polarization	Horizontal
-----------	--------------------------	--------------	------------

80 dBuV/m

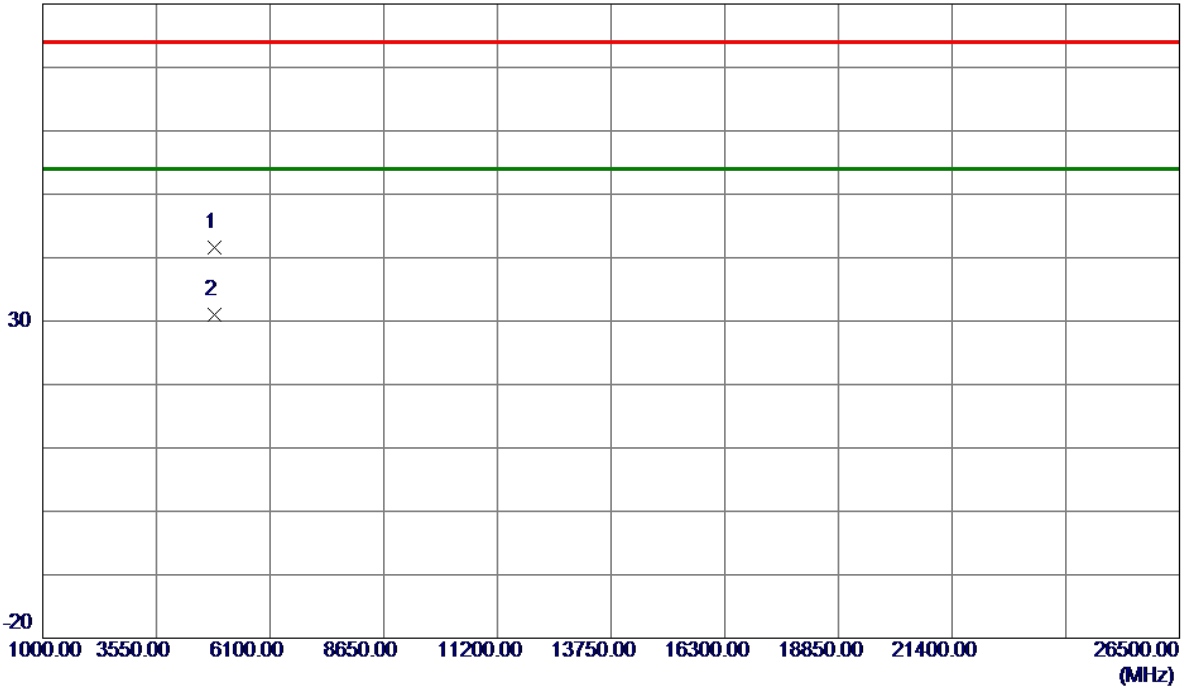

No.	Freq. MHz	Reading Level dBuV/m	Correct Factor dB	Measure ment dBuV/m	Limit dBuV/m	Margin dB	Detector	Comment
1	4853.6930	40.52	1.03	41.55	74.00	-32.45	Peak	
2 *	4854.0650	29.96	1.03	30.99	54.00	-23.01	AVG	

REMARKS:

- (1) Measurement Value = Reading Level + Correct Factor.
- (2) Margin Level = Measurement Value - Limit Value.

Test Mode	TX N(HT40) Mode 2437 MHz	Polarization	Vertical
-----------	--------------------------	--------------	----------

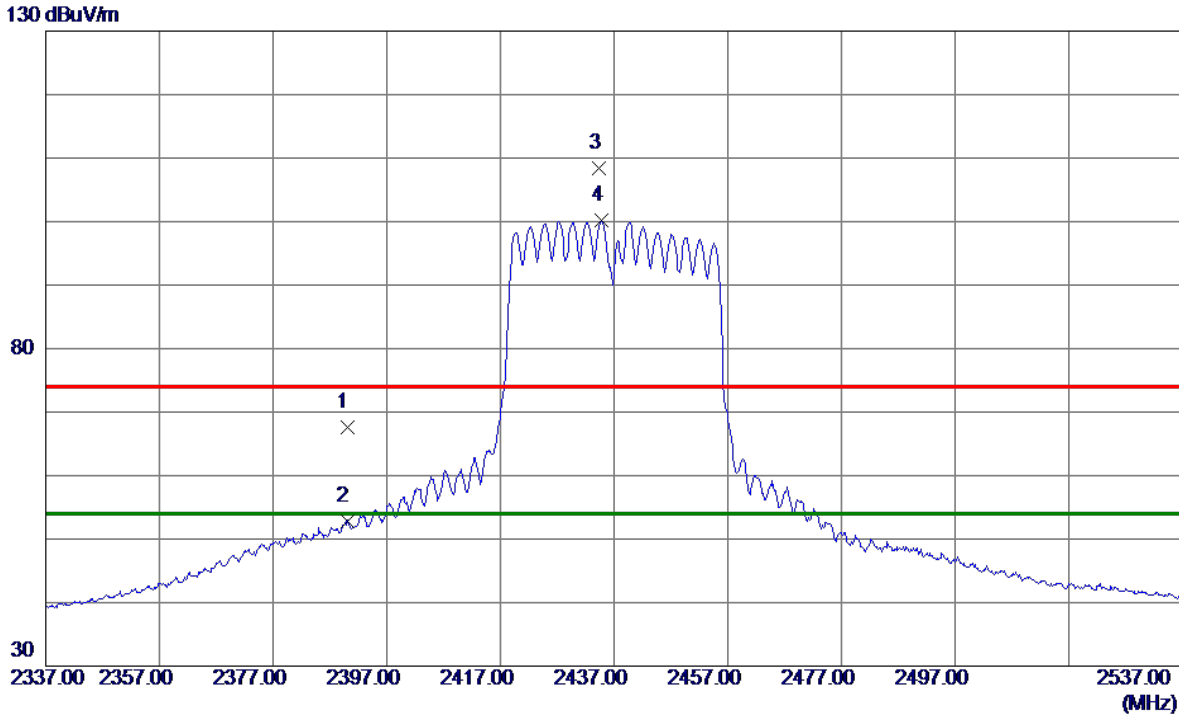

No.	Freq. MHz	Reading Level dBuV/m	Correct Factor dB	Measure ment dBuV/m	Limit dBuV/m	Margin dB	Detector	Comment
1	2390.0000	61.36	6.17	67.53	74.00	-6.47	Peak	
2	2390.0000	46.65	6.17	52.82	54.00	-1.18	AVG	
3	2434.4000	102.26	6.20	108.46	74.00	34.46	Peak	No Limit
4 *	2434.7000	94.05	6.20	100.25	54.00	46.25	AVG	No Limit

REMARKS:

- (1) Measurement Value = Reading Level + Correct Factor.
- (2) Margin Level = Measurement Value - Limit Value.

Test Mode	TX N(HT40) Mode 2437 MHz	Polarization	Horizontal
-----------	--------------------------	--------------	------------

80 dBuV/m

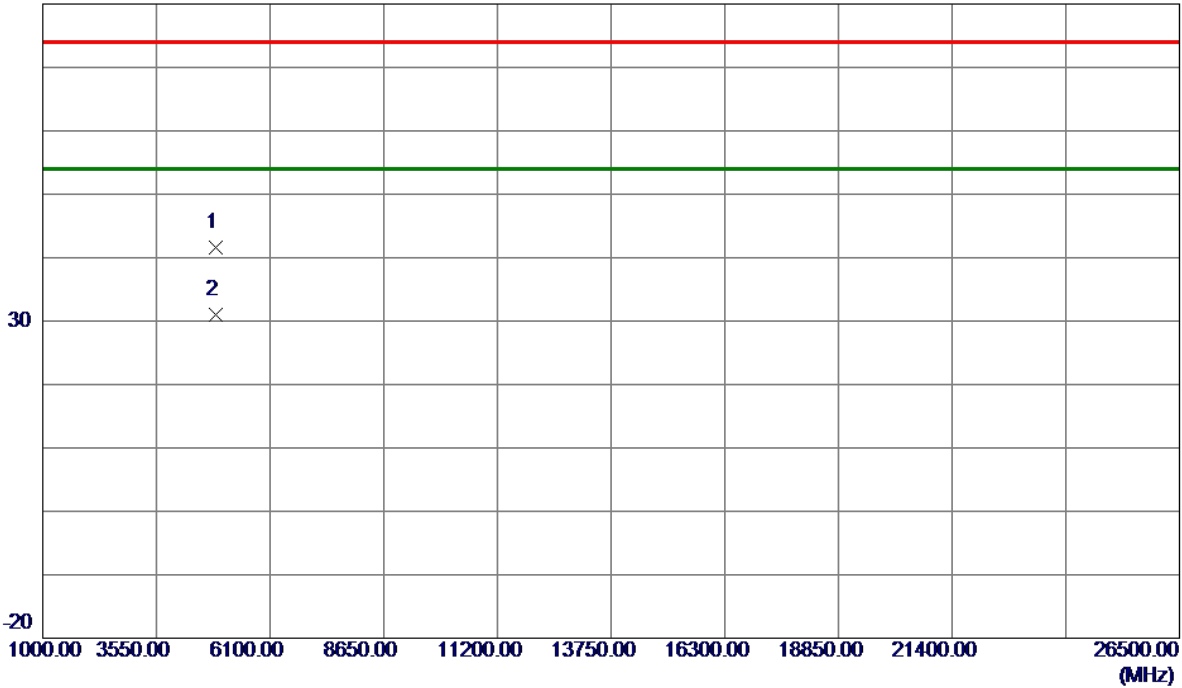

No.	Freq. MHz	Reading Level dBuV/m	Correct Factor dB	Measure ment dBuV/m	Limit dBuV/m	Margin dB	Detector	Comment
1	4873.0230	40.47	1.08	41.55	74.00	-32.45	Peak	
2 *	4875.4380	29.96	1.08	31.04	54.00	-22.96	AVG	

REMARKS:

- (1) Measurement Value = Reading Level + Correct Factor.
- (2) Margin Level = Measurement Value - Limit Value.

Test Mode	TX N(HT40) Mode 2447 MHz	Polarization	Vertical
-----------	--------------------------	--------------	----------

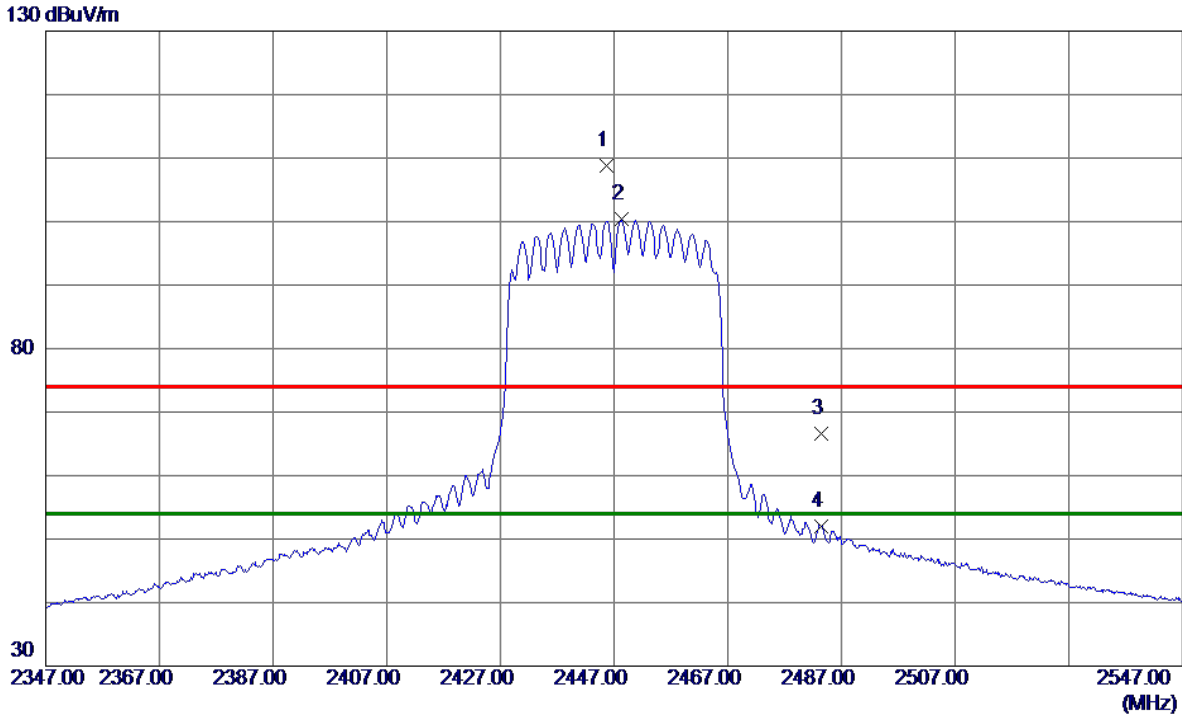

No.	Freq. MHz	Reading Level dBuV/m	Correct Factor dB	Measure ment dBuV/m	Limit dBuV/m	Margin dB	Detector	Comment
1	2445.7000	102.64	6.20	108.84	74.00	34.84	Peak	No Limit
2 *	2448.3000	94.14	6.21	100.35	54.00	46.35	AVG	No Limit
3	2483.5000	60.31	6.23	66.54	74.00	-7.46	Peak	
4	2483.5000	45.69	6.23	51.92	54.00	-2.08	AVG	

REMARKS:

- (1) Measurement Value = Reading Level + Correct Factor.
- (2) Margin Level = Measurement Value - Limit Value.

Test Mode	TX N(HT40) Mode 2447 MHz	Polarization	Horizontal
-----------	--------------------------	--------------	------------

80 dBuV/m

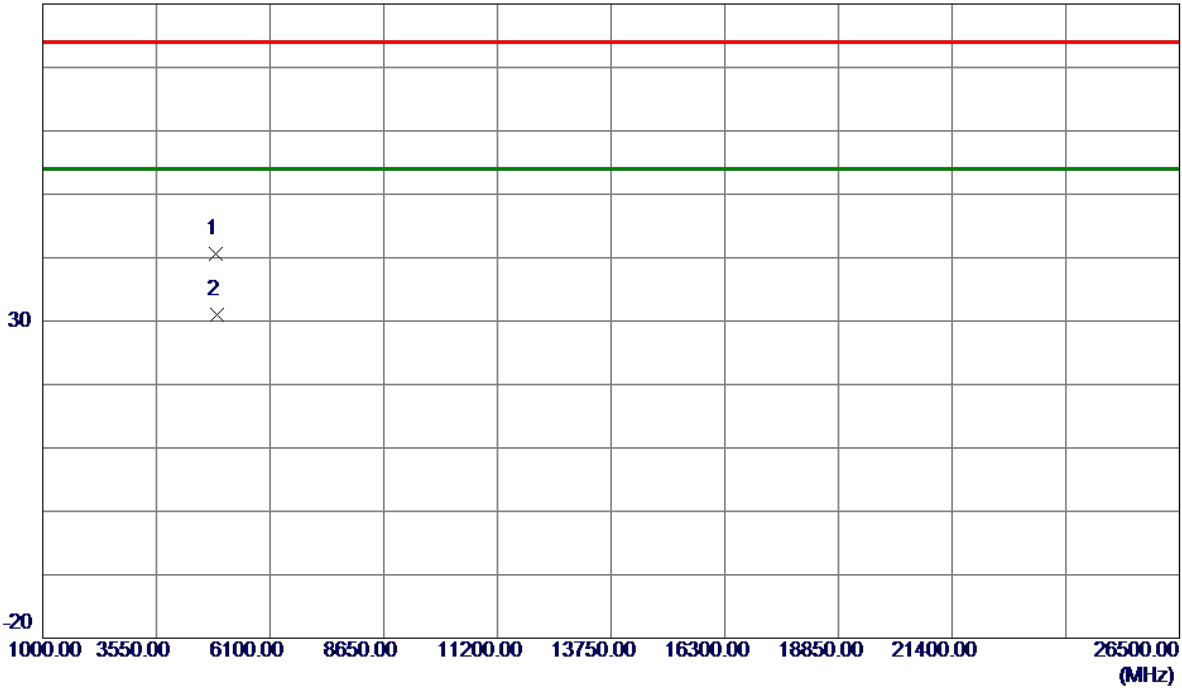

No.	Freq. MHz	Reading Level dBuV/m	Correct Factor dB	Measure ment dBuV/m	Limit dBuV/m	Margin dB	Detector	Comment
1	4895.2799	39.41	1.13	40.54	74.00	-33.46	Peak	
2 *	4896.4250	29.87	1.14	31.01	54.00	-22.99	AVG	

REMARKS:

- (1) Measurement Value = Reading Level + Correct Factor.
- (2) Margin Level = Measurement Value - Limit Value.

Test Mode	TX N(HT40) Mode 2452 MHz	Polarization	Vertical
-----------	--------------------------	--------------	----------

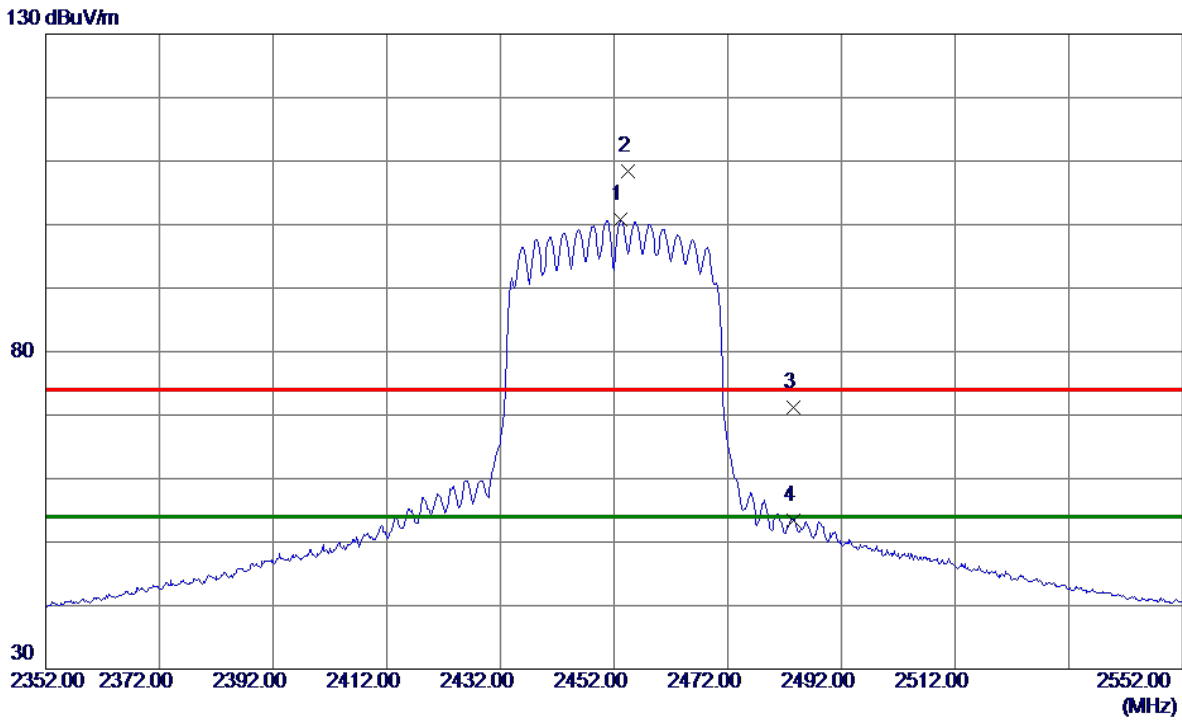

No.	Freq. MHz	Reading Level dBuV/m	Correct Factor dB	Measure ment dBuV/m	Limit dBuV/m	Margin dB	Detector	Comment
1 *	2453.2000	94.53	6.21	100.74	54.00	46.74	AVG	No Limit
2	2454.5000	102.27	6.21	108.48	74.00	34.48	Peak	No Limit
3	2483.5000	64.89	6.23	71.12	74.00	-2.88	Peak	
4	2483.5000	47.17	6.23	53.40	54.00	-0.60	AVG	

REMARKS:

- (1) Measurement Value = Reading Level + Correct Factor.
- (2) Margin Level = Measurement Value - Limit Value.

Test Mode	TX N(HT40) Mode 2452 MHz	Polarization	Horizontal
-----------	--------------------------	--------------	------------

80 dBuV/m

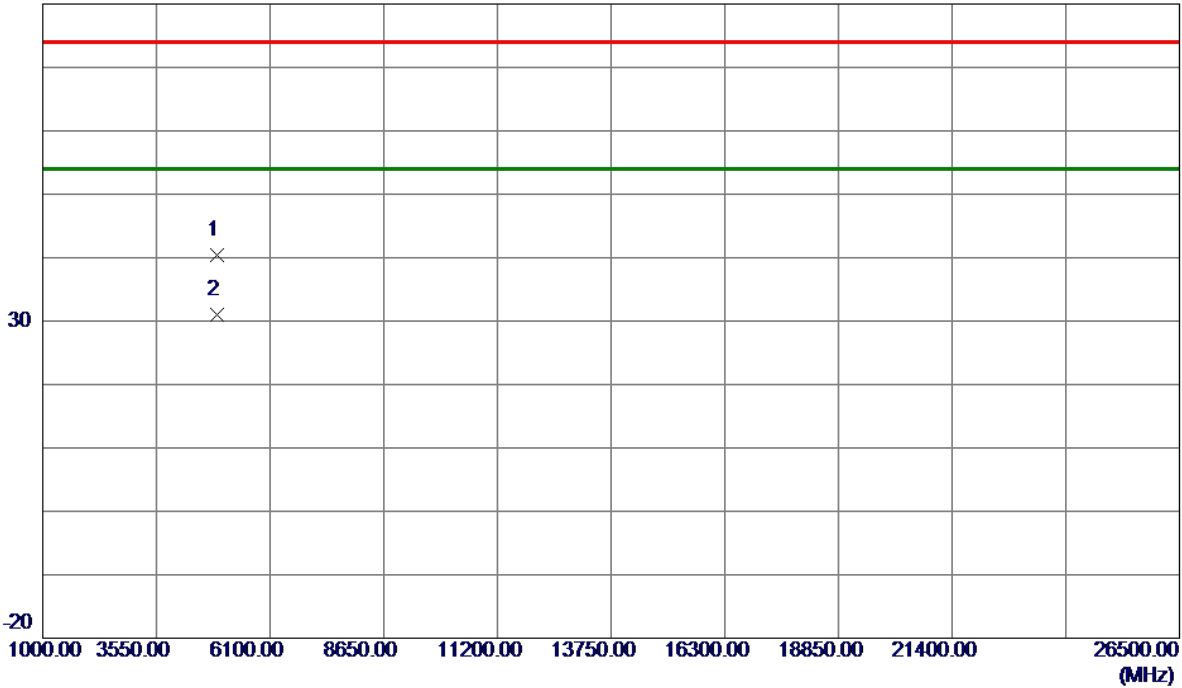

No.	Freq. MHz	Reading Level dBuV/m	Correct Factor dB	Measure ment dBuV/m	Limit dBuV/m	Margin dB	Detector	Comment
1	4904.7550	39.25	1.16	40.41	74.00	-33.59	Peak	
2 *	4906.0870	29.86	1.16	31.02	54.00	-22.98	AVG	

REMARKS:

- (1) Measurement Value = Reading Level + Correct Factor.
- (2) Margin Level = Measurement Value - Limit Value.

Test Mode	TX AX(HE20) Mode 2412 MHz	Polarization	Vertical
-----------	---------------------------	--------------	----------

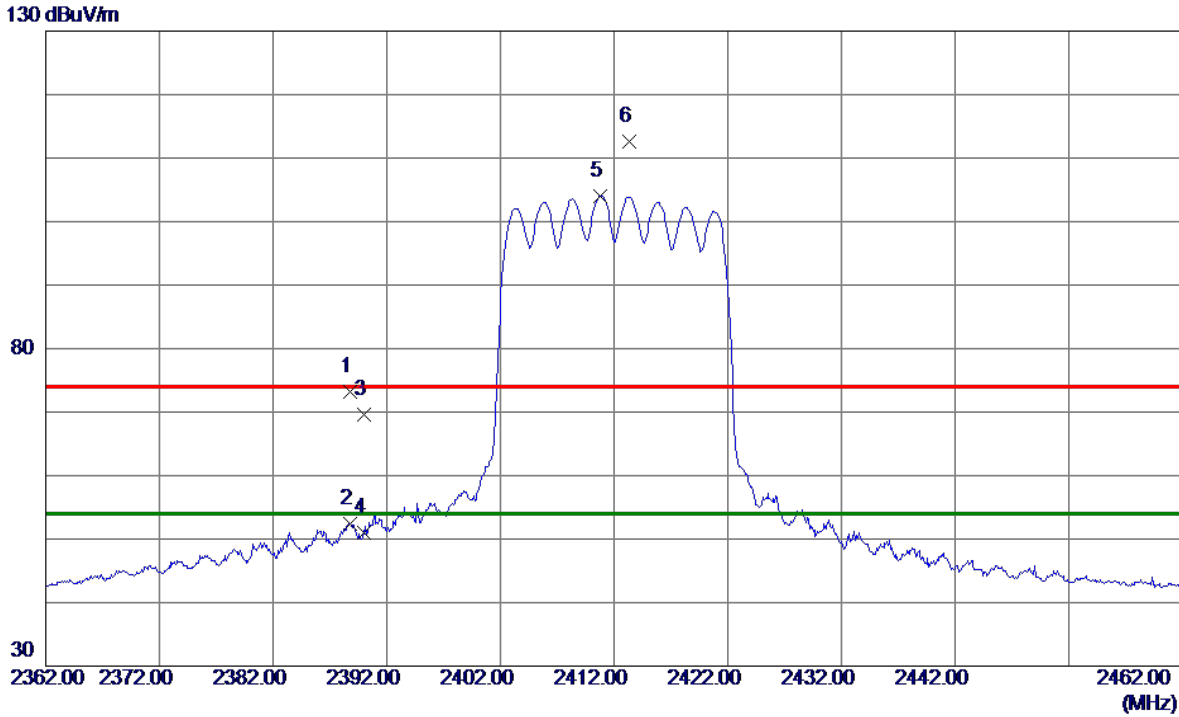

No.	Freq. MHz	Reading Level dBuV/m	Correct Factor dB	Measure ment dBuV/m	Limit dBuV/m	Margin dB	Detector	Comment
1	2388.8000	67.09	6.17	73.26	74.00	-0.74	Peak	
2	2388.8000	46.30	6.17	52.47	54.00	-1.53	AVG	
3	2390.0000	63.44	6.17	69.61	74.00	-4.39	Peak	
4	2390.0000	44.74	6.17	50.91	54.00	-3.09	AVG	
5 *	2410.7500	97.88	6.18	104.06	54.00	50.06	AVG	No Limit
6	2413.3000	106.46	6.18	112.64	74.00	38.64	Peak	No Limit

REMARKS:

- (1) Measurement Value = Reading Level + Correct Factor.
- (2) Margin Level = Measurement Value - Limit Value.

Test Mode	TX AX(HE20) Mode 2412 MHz	Polarization	Horizontal
-----------	---------------------------	--------------	------------

80 dBuV/m

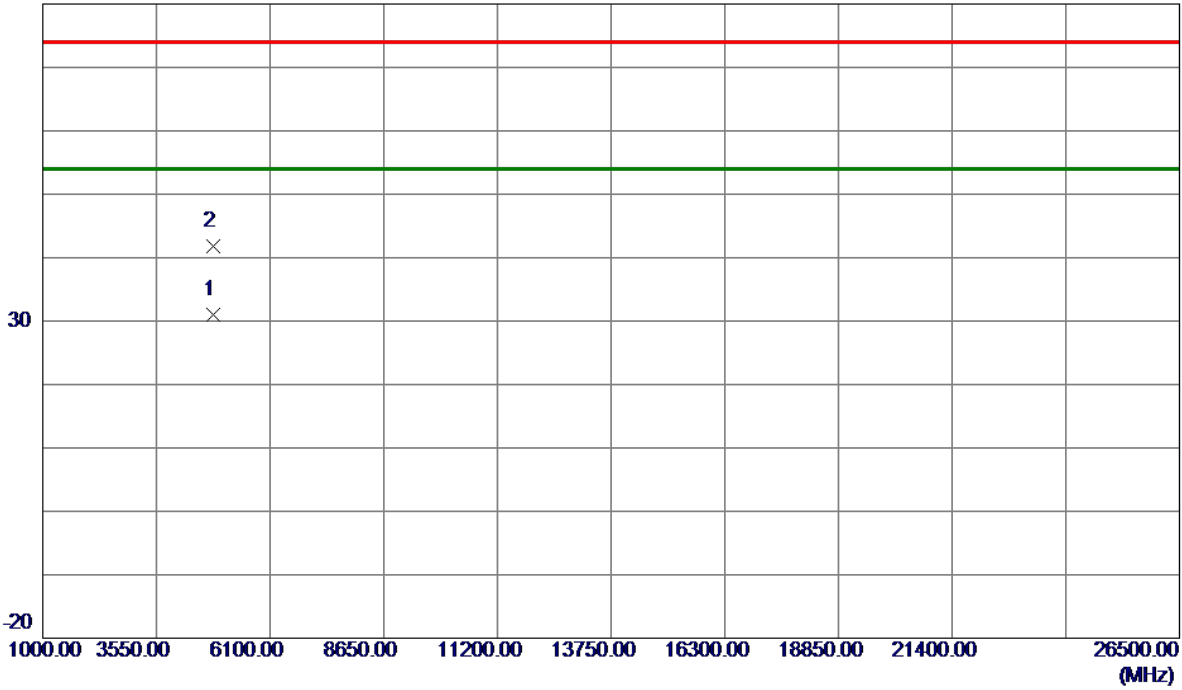

No.	Freq. MHz	Reading Level dBuV/m	Correct Factor dB	Measure ment dBuV/m	Limit dBuV/m	Margin dB	Detector	Comment
1 *	4824.3870	29.98	0.95	30.93	54.00	-23.07	AVG	
2	4824.4600	40.81	0.95	41.76	74.00	-32.24	Peak	

REMARKS:

- (1) Measurement Value = Reading Level + Correct Factor.
- (2) Margin Level = Measurement Value - Limit Value.

Test Mode	TX AX(HE20) Mode 2417 MHz	Polarization	Vertical
-----------	---------------------------	--------------	----------

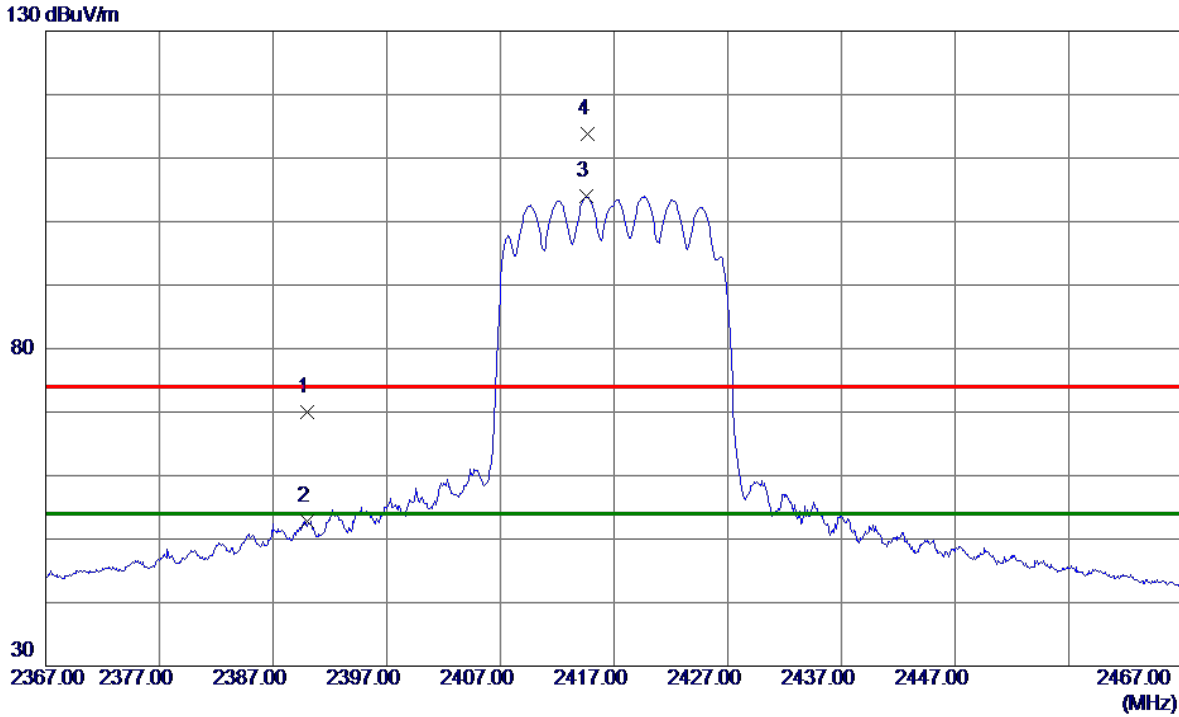

No.	Freq. MHz	Reading Level dBuV/m	Correct Factor dB	Measure ment dBuV/m	Limit dBuV/m	Margin dB	Detector	Comment
1	2390.0000	63.84	6.17	70.01	74.00	-3.99	Peak	
2	2390.0000	46.70	6.17	52.87	54.00	-1.13	AVG	
3 *	2414.6000	97.79	6.18	103.97	54.00	49.97	AVG	No Limit
4	2414.6500	107.57	6.18	113.75	74.00	39.75	Peak	No Limit

REMARKS:

- (1) Measurement Value = Reading Level + Correct Factor.
- (2) Margin Level = Measurement Value - Limit Value.

Test Mode	TX AX(HE20) Mode 2417 MHz	Polarization	Horizontal
-----------	---------------------------	--------------	------------

80 dBuV/m

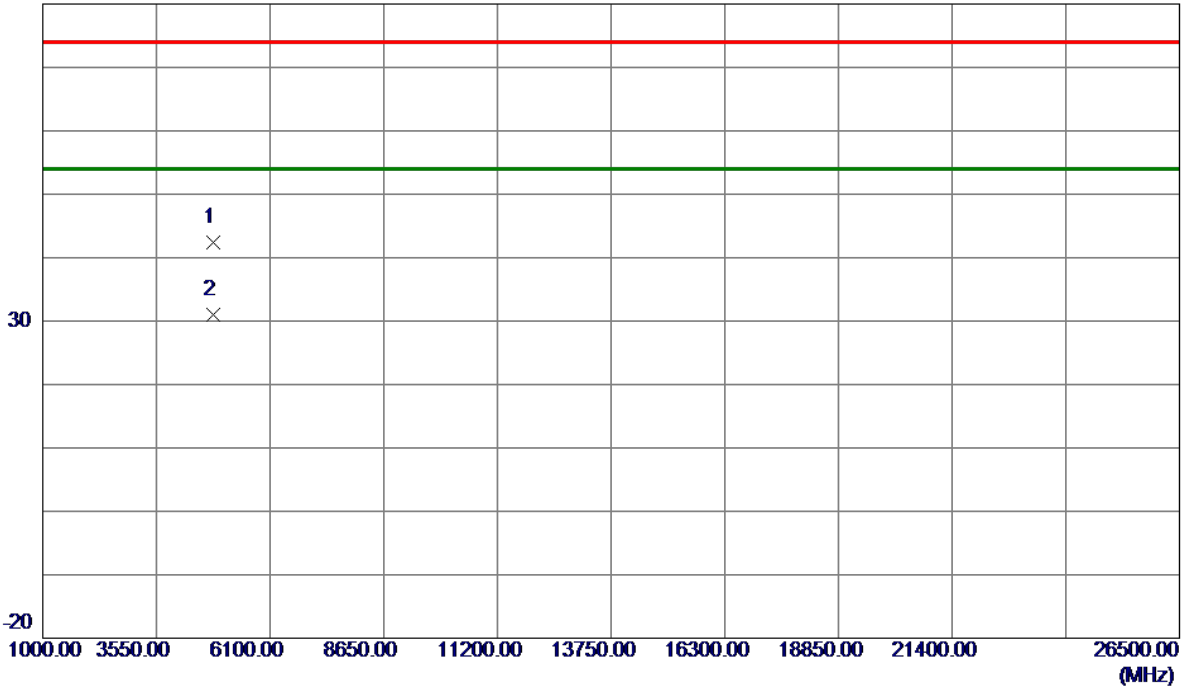

No.	Freq. MHz	Reading Level dBuV/m	Correct Factor dB	Measure ment dBuV/m	Limit dBuV/m	Margin dB	Detector	Comment
1	4833.8400	41.34	0.98	42.32	74.00	-31.68	Peak	
2 *	4834.3300	29.96	0.98	30.94	54.00	-23.06	AVG	

REMARKS:

- (1) Measurement Value = Reading Level + Correct Factor.
- (2) Margin Level = Measurement Value - Limit Value.

Test Mode	TX AX(HE20) Mode 2437 MHz	Polarization	Vertical
-----------	---------------------------	--------------	----------

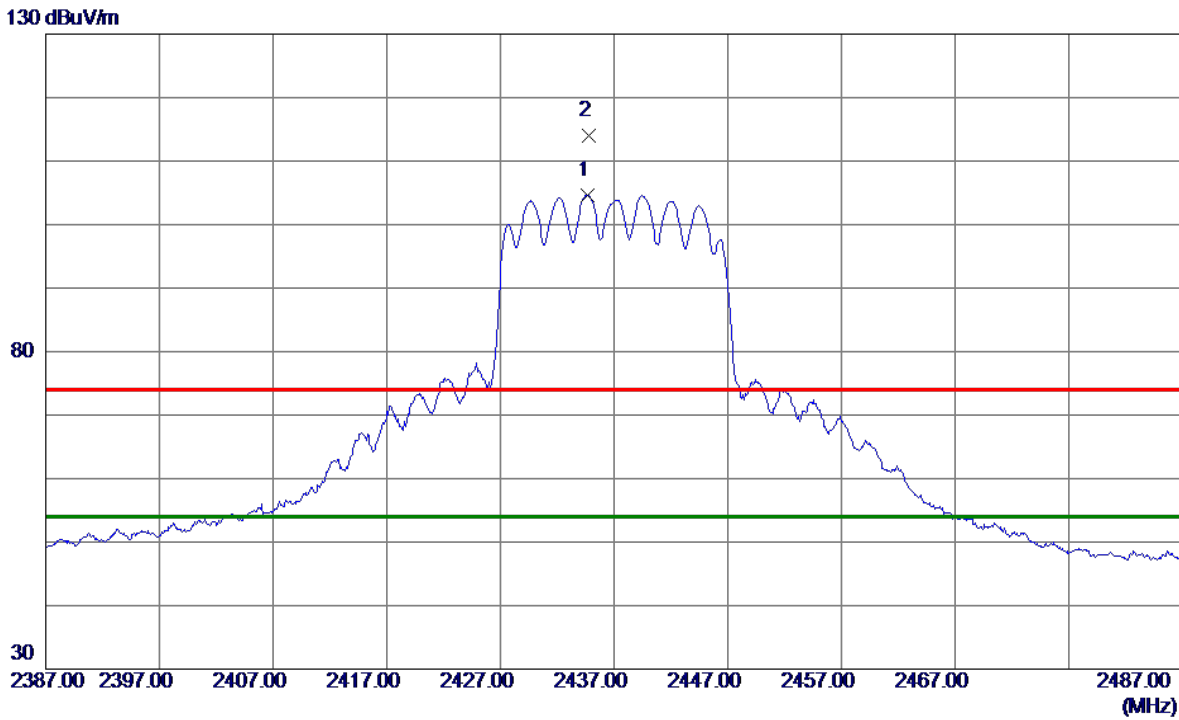

No.	Freq. MHz	Reading Level dBuV/m	Correct Factor dB	Measure ment dBuV/m	Limit dBuV/m	Margin dB	Detector	Comment
1 *	2434.7000	98.47	6.20	104.67	54.00	50.67	AVG	No Limit
2	2434.8000	107.78	6.20	113.98	74.00	39.98	Peak	No Limit

REMARKS:

- (1) Measurement Value = Reading Level + Correct Factor.
- (2) Margin Level = Measurement Value - Limit Value.

Test Mode	TX AX(HE20) Mode 2437 MHz	Polarization	Horizontal
-----------	---------------------------	--------------	------------

80 dBuV/m

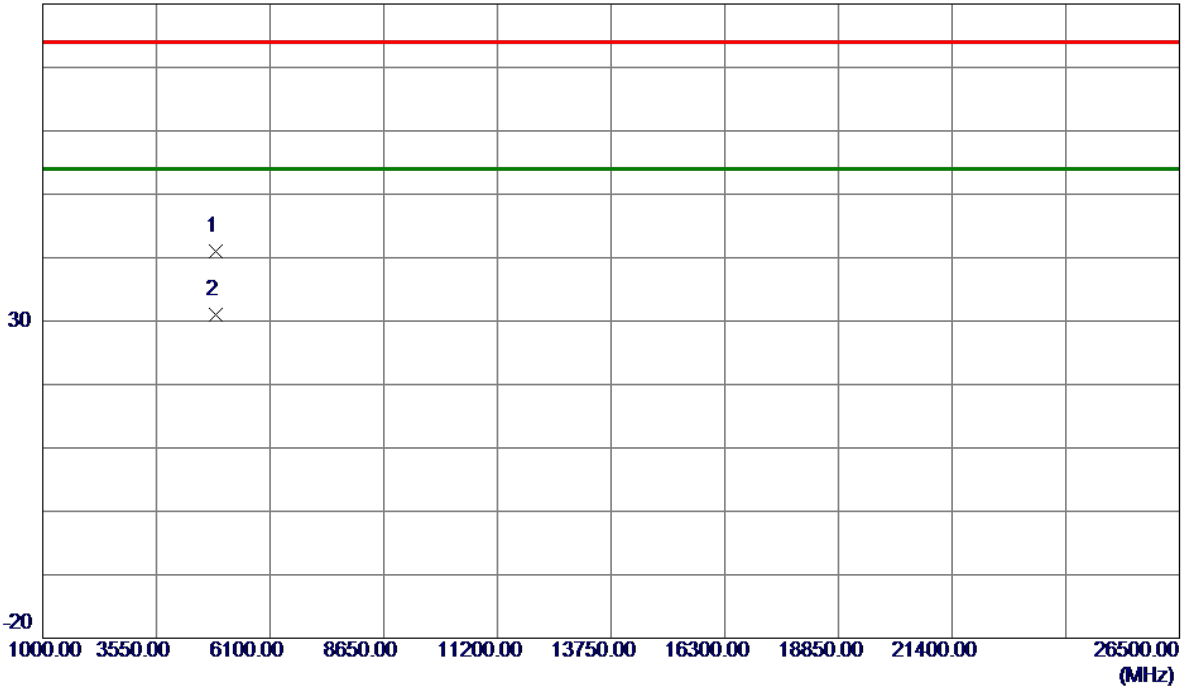

No.	Freq. MHz	Reading Level dBuV/m	Correct Factor dB	Measure ment dBuV/m	Limit dBuV/m	Margin dB	Detector	Comment
1	4872.2570	39.92	1.07	40.99	74.00	-33.01	Peak	
2 *	4874.6150	29.97	1.08	31.05	54.00	-22.95	AVG	

REMARKS:

- (1) Measurement Value = Reading Level + Correct Factor.
- (2) Margin Level = Measurement Value - Limit Value.

Test Mode	TX AX(HE20) Mode 2457 MHz	Polarization	Vertical
-----------	---------------------------	--------------	----------

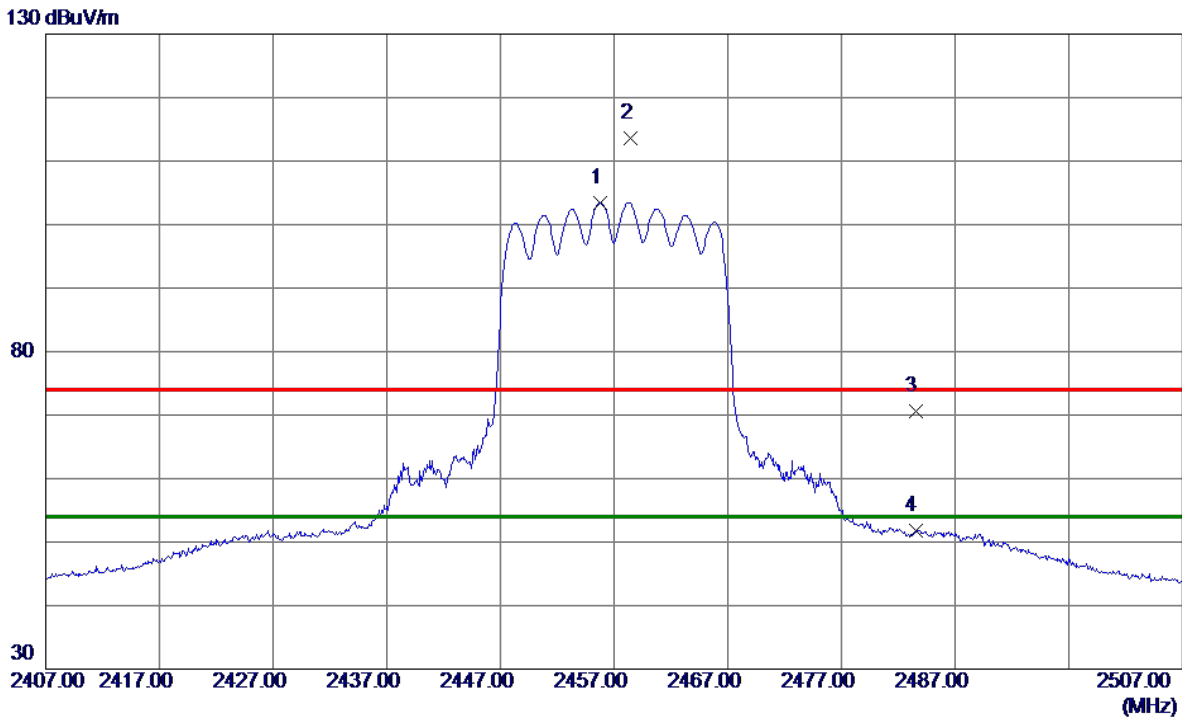

No.	Freq. MHz	Reading Level dBuV/m	Correct Factor dB	Measure ment dBuV/m	Limit dBuV/m	Margin dB	Detector	Comment
1 *	2455.8000	97.22	6.21	103.43	54.00	49.43	AVG	No Limit
2	2458.4000	107.39	6.21	113.60	74.00	39.60	Peak	No Limit
3	2483.5000	64.37	6.23	70.60	74.00	-3.40	Peak	
4	2483.5000	45.64	6.23	51.87	54.00	-2.13	AVG	

REMARKS:

- (1) Measurement Value = Reading Level + Correct Factor.
- (2) Margin Level = Measurement Value - Limit Value.

Test Mode	TX AX(HE20) Mode 2457 MHz	Polarization	Horizontal
-----------	---------------------------	--------------	------------

80 dBuV/m

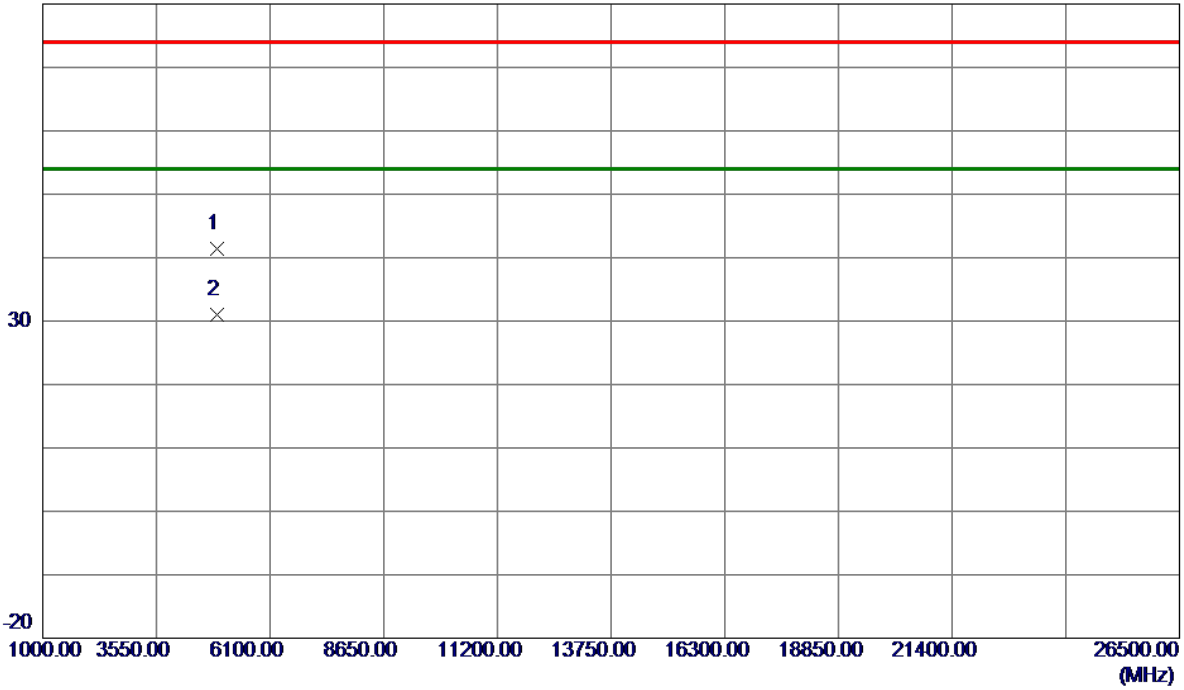

No.	Freq. MHz	Reading Level dBuV/m	Correct Factor dB	Measure ment dBuV/m	Limit dBuV/m	Margin dB	Detector	Comment
1	4915.4270	40.27	1.18	41.45	74.00	-32.55	Peak	
2 *	4915.7220	29.86	1.18	31.04	54.00	-22.96	AVG	

REMARKS:

- (1) Measurement Value = Reading Level + Correct Factor.
- (2) Margin Level = Measurement Value - Limit Value.

Test Mode	TX AX(HE20) Mode 2462 MHz	Polarization	Vertical
-----------	---------------------------	--------------	----------

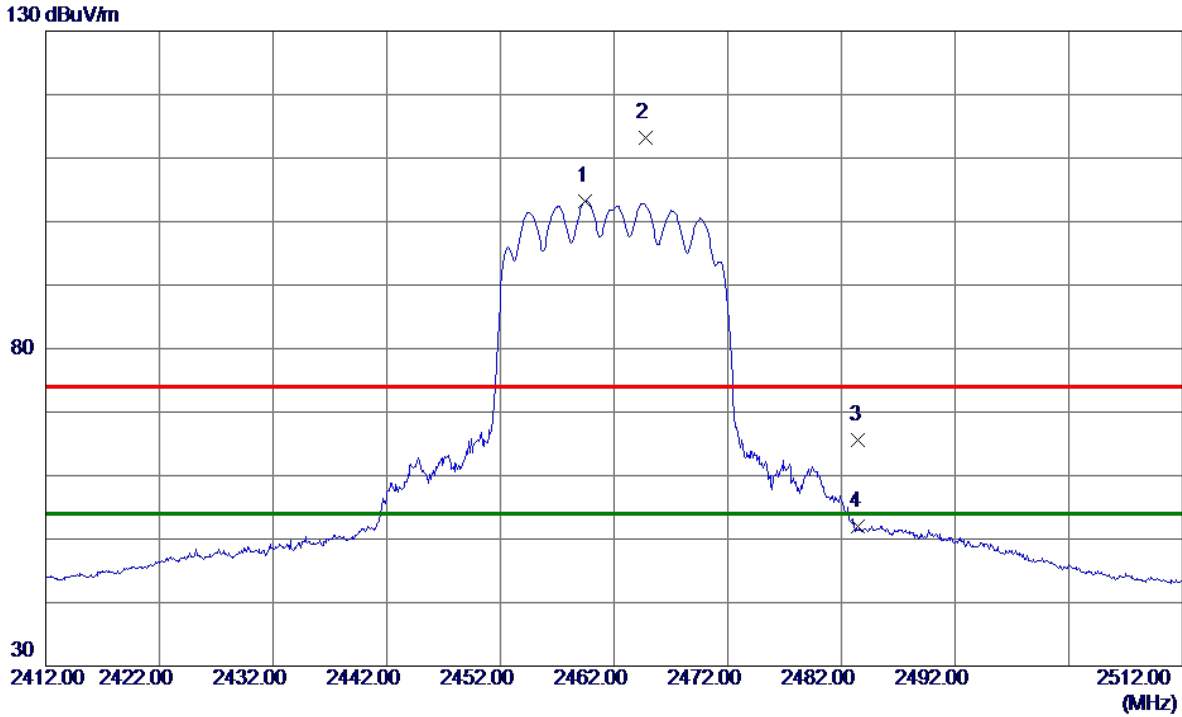

No.	Freq. MHz	Reading Level dBuV/m	Correct Factor dB	Measure ment dBuV/m	Limit dBuV/m	Margin dB	Detector	Comment
1 *	2459.5000	96.99	6.21	103.20	54.00	49.20	AVG	No Limit
2	2464.7500	106.98	6.22	113.20	74.00	39.20	Peak	No Limit
3	2483.5000	59.32	6.23	65.55	74.00	-8.45	Peak	
4	2483.5000	45.84	6.23	52.07	54.00	-1.93	AVG	

REMARKS:

- (1) Measurement Value = Reading Level + Correct Factor.
- (2) Margin Level = Measurement Value - Limit Value.

Test Mode	TX AX(HE20) Mode 2462 MHz	Polarization	Horizontal
-----------	---------------------------	--------------	------------

80 dBuV/m

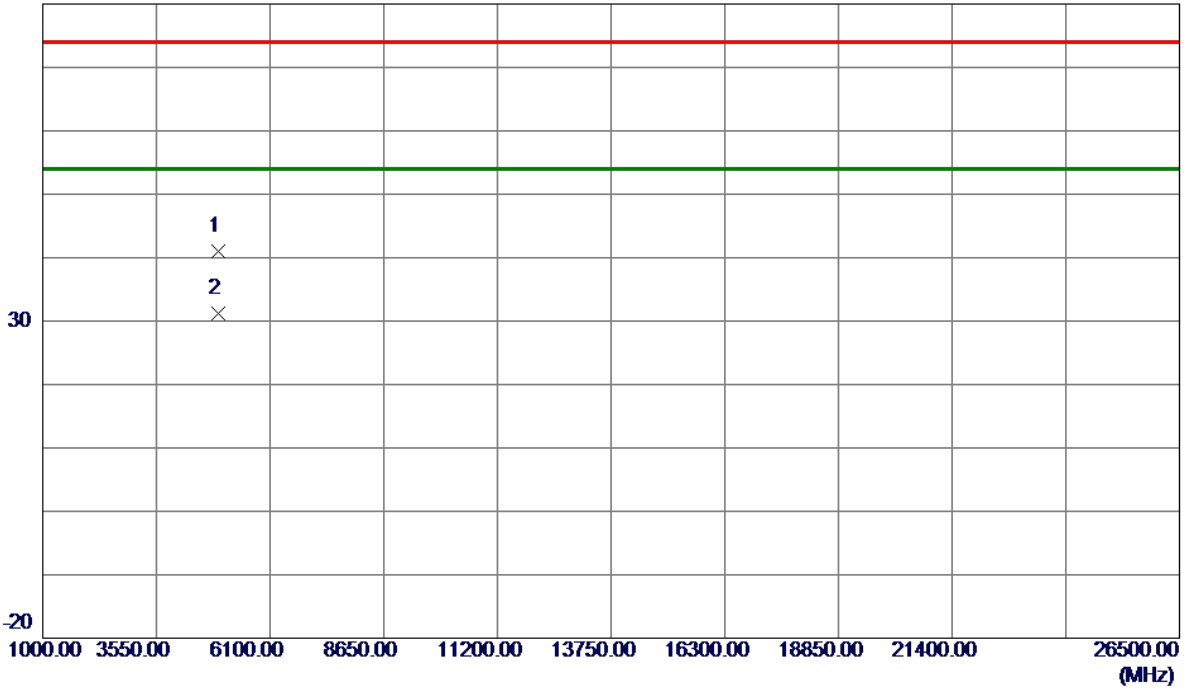

No.	Freq. MHz	Reading Level dBuV/m	Correct Factor dB	Measure ment dBuV/m	Limit dBuV/m	Margin dB	Detector	Comment
1	4924.3070	39.70	1.21	40.91	74.00	-33.09	Peak	
2 *	4925.9030	29.97	1.21	31.18	54.00	-22.82	AVG	

REMARKS:

- (1) Measurement Value = Reading Level + Correct Factor.
- (2) Margin Level = Measurement Value - Limit Value.

Test Mode	TX AX(HE40) Mode 2422 MHz	Polarization	Vertical
-----------	---------------------------	--------------	----------

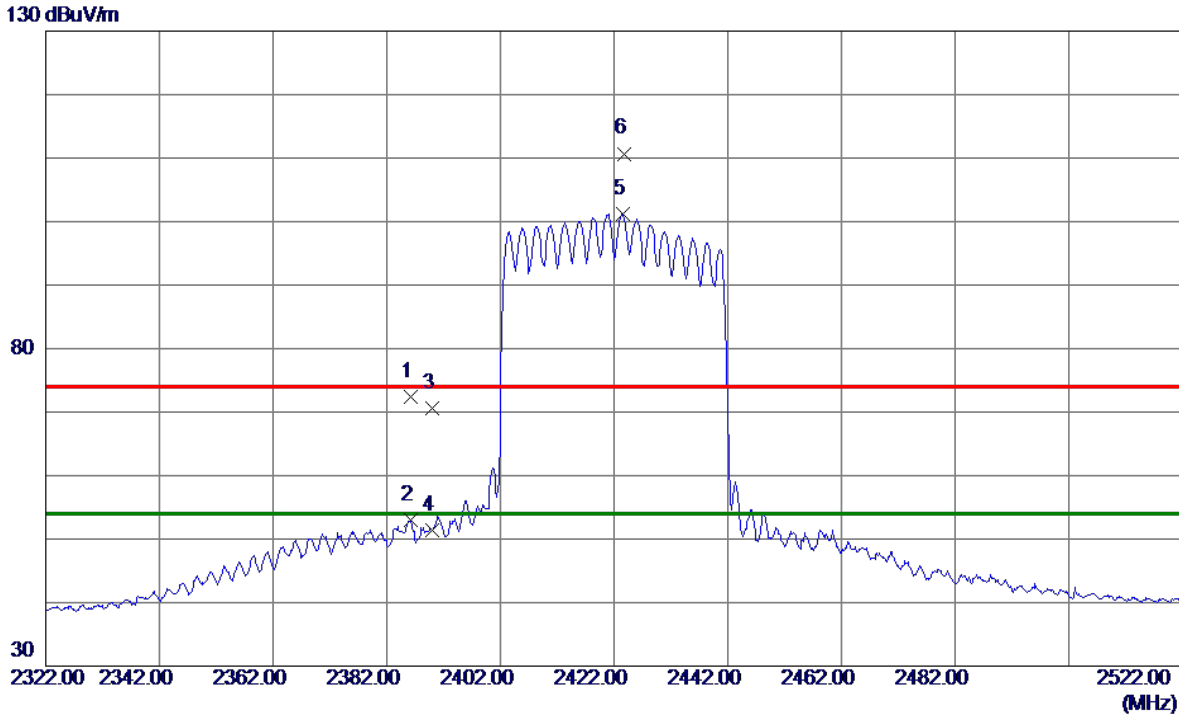

No.	Freq. MHz	Reading Level dBuV/m	Correct Factor dB	Measurement dBuV/m	Limit dBuV/m	Margin dB	Detector	Comment
1	2386.3000	66.25	6.16	72.41	74.00	-1.59	Peak	
2	2386.3000	46.77	6.16	52.93	54.00	-1.07	AVG	
3	2390.0000	64.46	6.17	70.63	74.00	-3.37	Peak	
4	2390.0000	45.22	6.17	51.39	54.00	-2.61	AVG	
5 *	2423.5000	94.96	6.19	101.15	54.00	47.15	AVG	No Limit
6	2423.7000	104.51	6.19	110.70	74.00	36.70	Peak	No Limit

REMARKS:

- (1) Measurement Value = Reading Level + Correct Factor.
- (2) Margin Level = Measurement Value - Limit Value.

Test Mode	TX AX(HE40) Mode 2422 MHz	Polarization	Horizontal
-----------	---------------------------	--------------	------------

80 dBuV/m

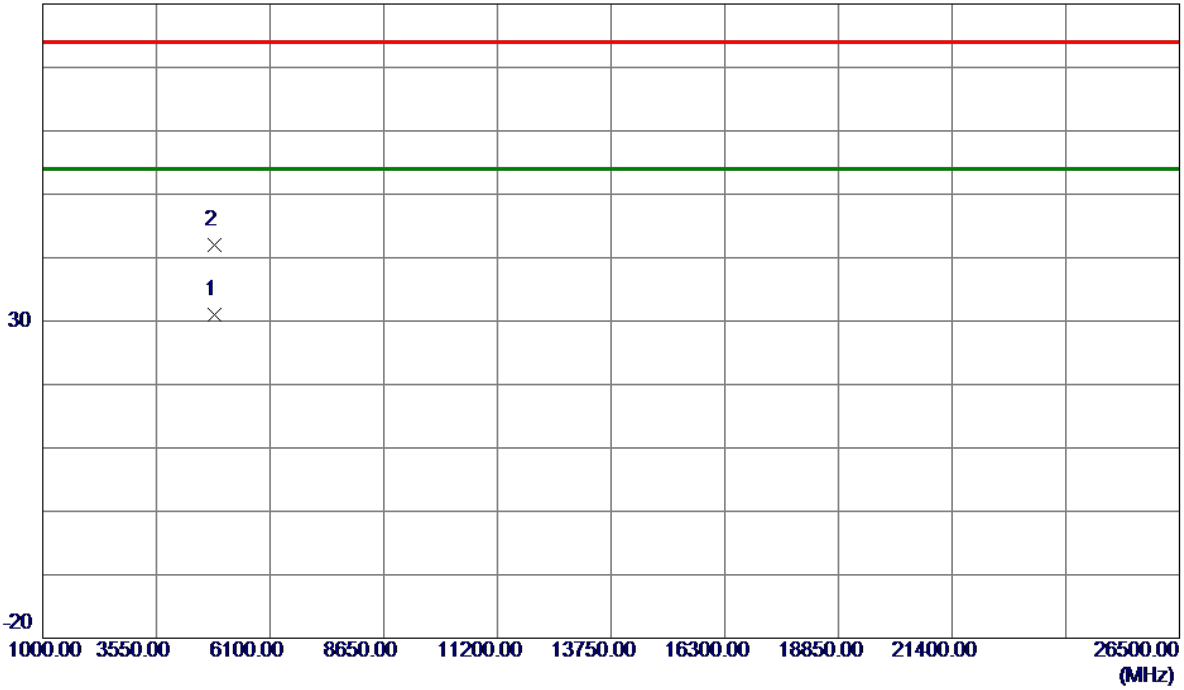

No.	Freq. MHz	Reading Level dBuV/m	Correct Factor dB	Measure ment dBuV/m	Limit dBuV/m	Margin dB	Detector	Comment
1 *	4843.8630	29.97	1.00	30.97	54.00	-23.03	AVG	
2	4844.1230	41.03	1.00	42.03	74.00	-31.97	Peak	

REMARKS:

- (1) Measurement Value = Reading Level + Correct Factor.
- (2) Margin Level = Measurement Value - Limit Value.

Test Mode	TX AX(HE40) Mode 2427 MHz	Polarization	Vertical
-----------	---------------------------	--------------	----------

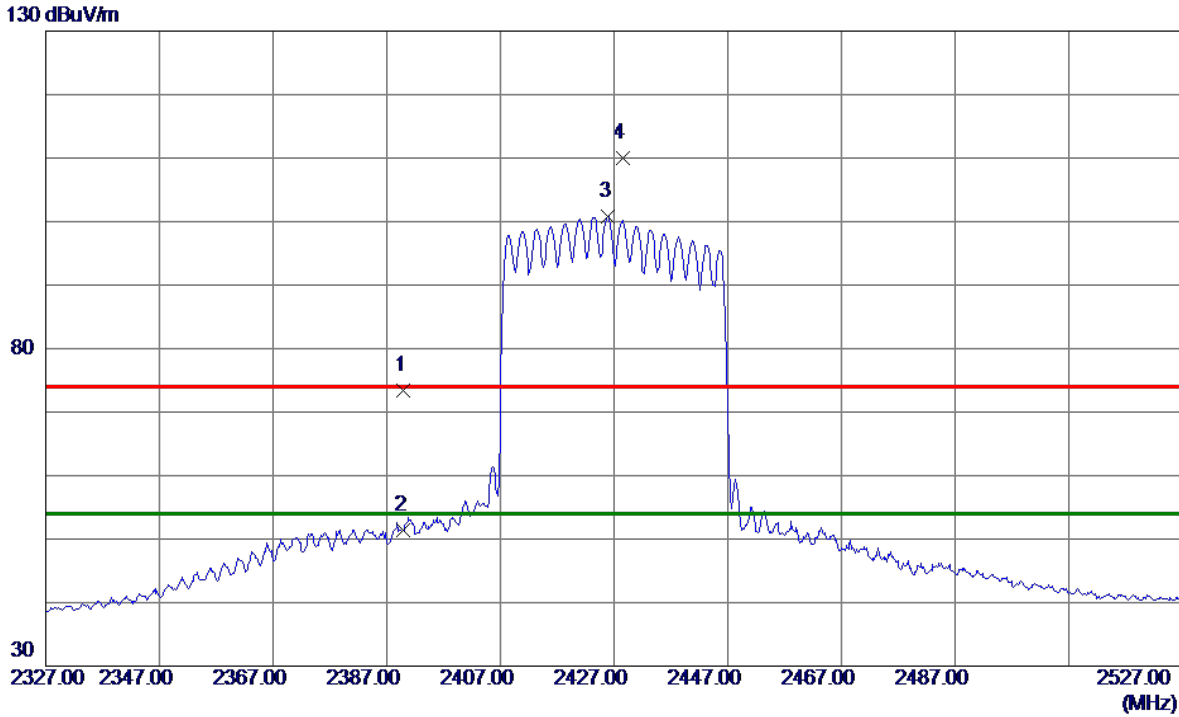

No.	Freq. MHz	Reading Level dBuV/m	Correct Factor dB	Measure ment dBuV/m	Limit dBuV/m	Margin dB	Detector	Comment
1	2390.0000	67.19	6.17	73.36	74.00	-0.64	Peak	
2	2390.0000	45.22	6.17	51.39	54.00	-2.61	AVG	
3 *	2426.0000	94.59	6.19	100.78	54.00	46.78	AVG	No Limit
4	2428.5000	103.79	6.19	109.98	74.00	35.98	Peak	No Limit

REMARKS:

- (1) Measurement Value = Reading Level + Correct Factor.
- (2) Margin Level = Measurement Value - Limit Value.

Test Mode	TX AX(HE40) Mode 2427 MHz	Polarization	Horizontal
-----------	---------------------------	--------------	------------

80 dBuV/m

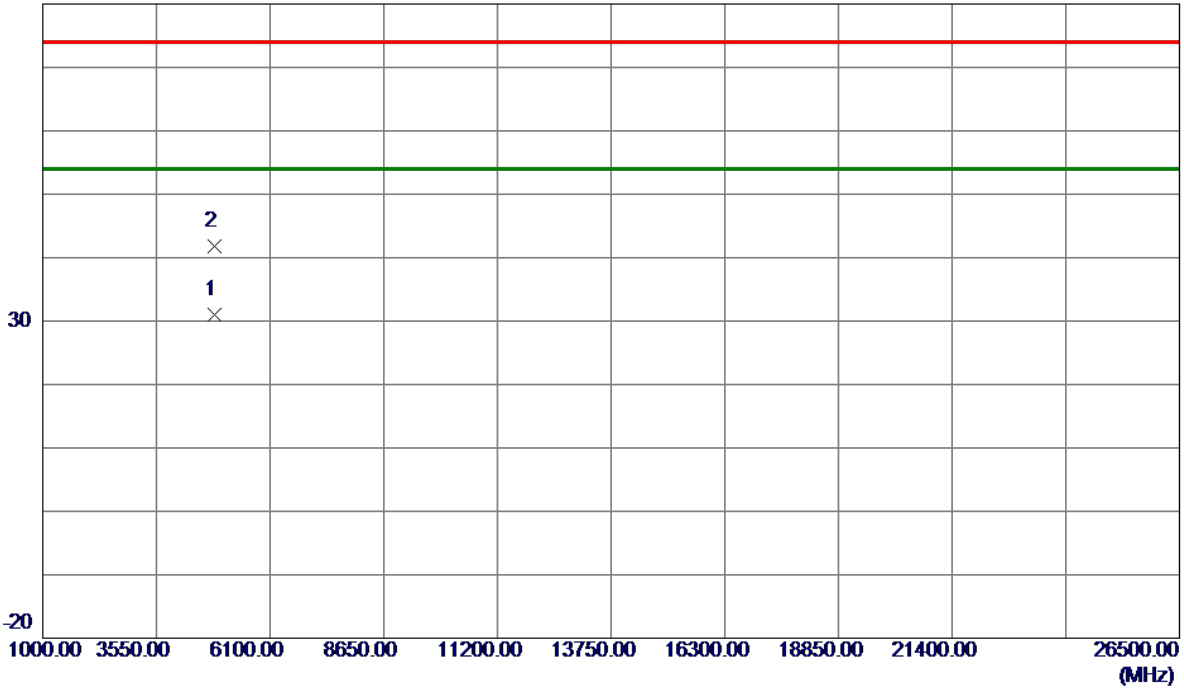

No.	Freq. MHz	Reading Level dBuV/m	Correct Factor dB	Measure ment dBuV/m	Limit dBuV/m	Margin dB	Detector	Comment
1 *	4854.7780	29.96	1.03	30.99	54.00	-23.01	AVG	
2	4856.1549	40.83	1.03	41.86	74.00	-32.14	Peak	

REMARKS:

- (1) Measurement Value = Reading Level + Correct Factor.
- (2) Margin Level = Measurement Value - Limit Value.

Test Mode	TX AX(HE40) Mode 2437 MHz	Polarization	Vertical
-----------	---------------------------	--------------	----------

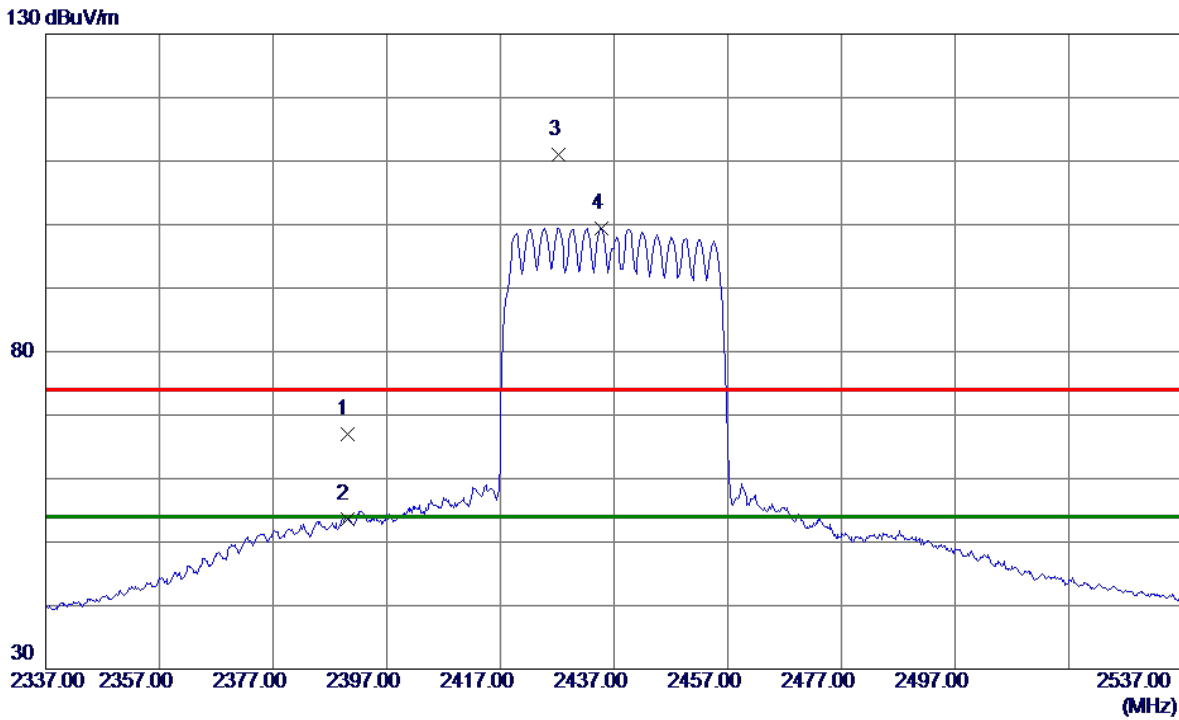

No.	Freq. MHz	Reading Level dBuV/m	Correct Factor dB	Measure ment dBuV/m	Limit dBuV/m	Margin dB	Detector	Comment
1	2390.0000	60.85	6.17	67.02	74.00	-6.98	Peak	
2	2390.0000	47.37	6.17	53.54	54.00	-0.46	AVG	
3	2427.2000	104.79	6.19	110.98	74.00	36.98	Peak	No Limit
4 *	2434.7000	93.26	6.20	99.46	54.00	45.46	AVG	No Limit

REMARKS:

- (1) Measurement Value = Reading Level + Correct Factor.
- (2) Margin Level = Measurement Value - Limit Value.

Test Mode	TX AX(HE40) Mode 2437 MHz	Polarization	Horizontal
-----------	---------------------------	--------------	------------

80 dBuV/m

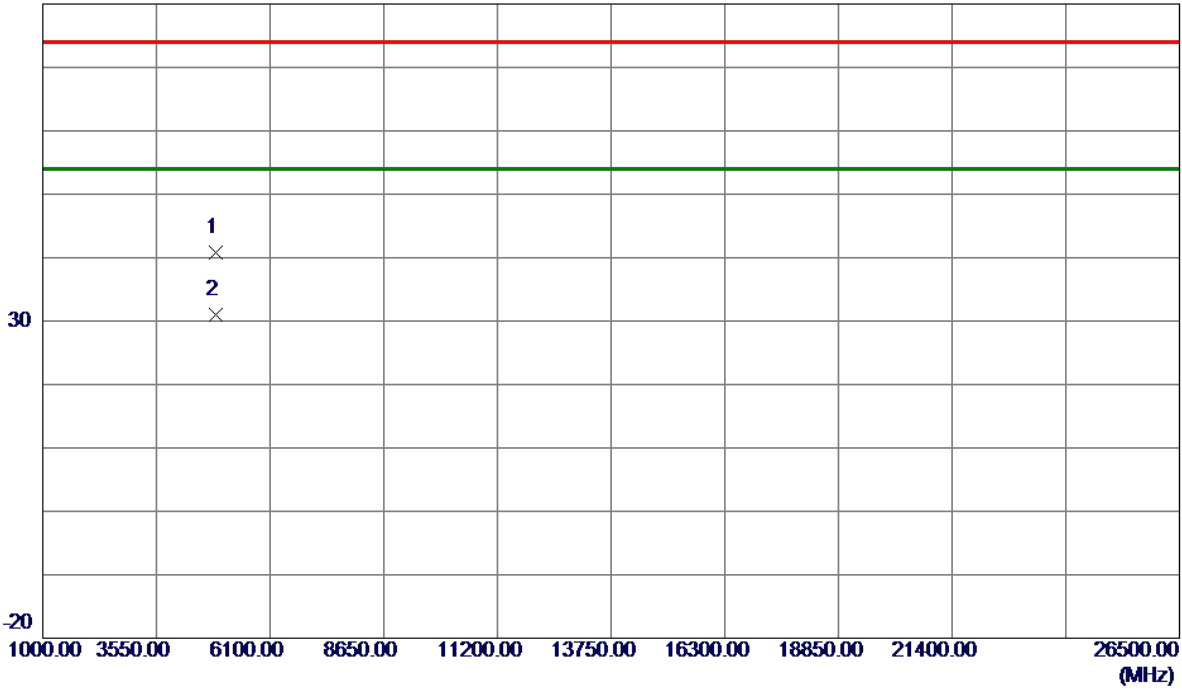

No.	Freq. MHz	Reading Level dBuV/m	Correct Factor dB	Measure ment dBuV/m	Limit dBuV/m	Margin dB	Detector	Comment
1	4874.9880	39.69	1.08	40.77	74.00	-33.23	Peak	
2 *	4876.4169	29.93	1.08	31.01	54.00	-22.99	AVG	

REMARKS:

- (1) Measurement Value = Reading Level + Correct Factor.
- (2) Margin Level = Measurement Value - Limit Value.

Test Mode	TX AX(HE40) Mode 2447 MHz	Polarization	Vertical
-----------	---------------------------	--------------	----------

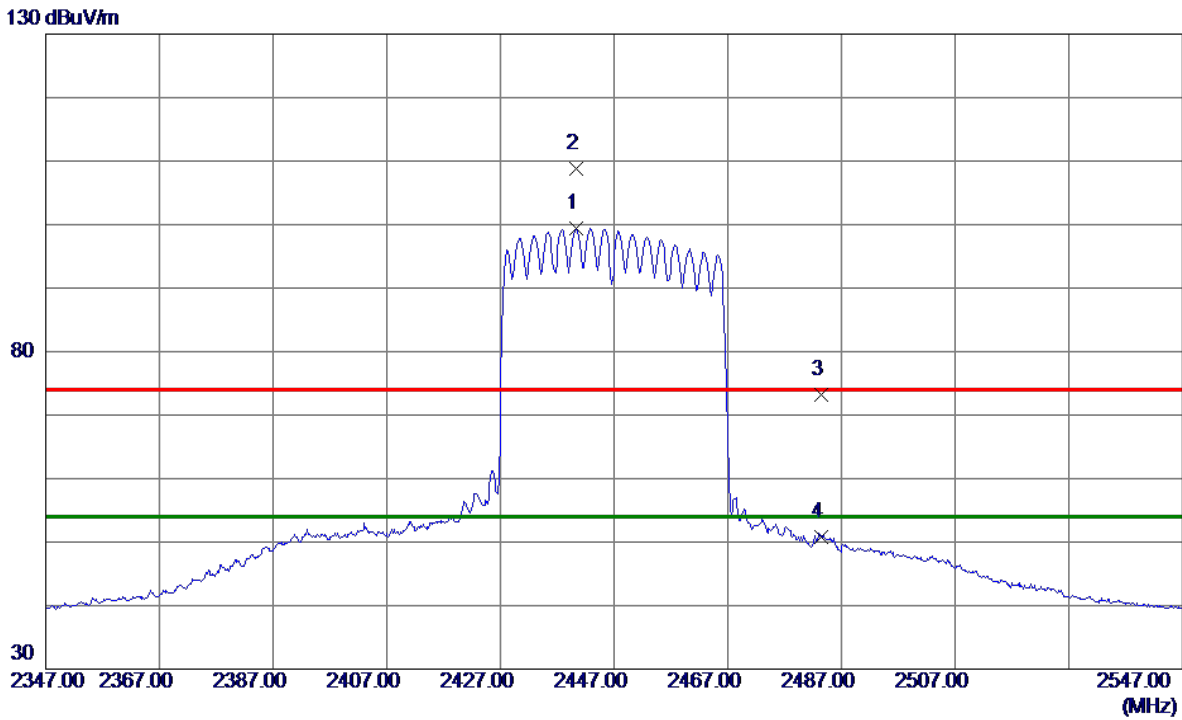

No.	Freq. MHz	Reading Level dBuV/m	Correct Factor dB	Measure ment dBuV/m	Limit dBuV/m	Margin dB	Detector	Comment
1 *	2440.3000	93.15	6.20	99.35	54.00	45.35	AVG	No Limit
2	2440.4000	102.69	6.20	108.89	74.00	34.89	Peak	No Limit
3	2483.5000	67.01	6.23	73.24	74.00	-0.76	Peak	
4	2483.5000	44.60	6.23	50.83	54.00	-3.17	AVG	

REMARKS:

- (1) Measurement Value = Reading Level + Correct Factor.
- (2) Margin Level = Measurement Value - Limit Value.

Test Mode	TX AX(HE40) Mode 2447 MHz	Polarization	Horizontal
-----------	---------------------------	--------------	------------

80 dBuV/m

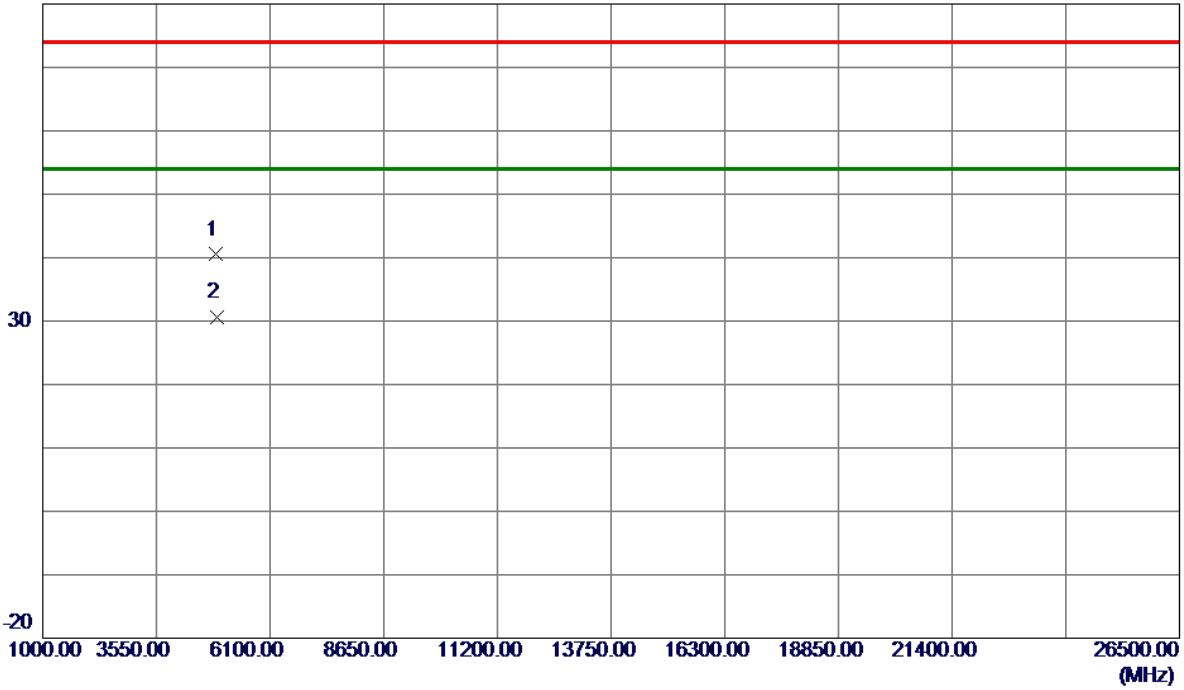

No.	Freq. MHz	Reading Level dBuV/m	Correct Factor dB	Measure ment dBuV/m	Limit dBuV/m	Margin dB	Detector	Comment
1	4893.6950	39.37	1.13	40.50	74.00	-33.50	Peak	
2 *	4896.5000	29.45	1.14	30.59	54.00	-23.41	AVG	

REMARKS:

- (1) Measurement Value = Reading Level + Correct Factor.
- (2) Margin Level = Measurement Value - Limit Value.

Test Mode	TX AX(HE40) Mode 2452 MHz	Polarization	Vertical
-----------	---------------------------	--------------	----------

130 dBuV/m

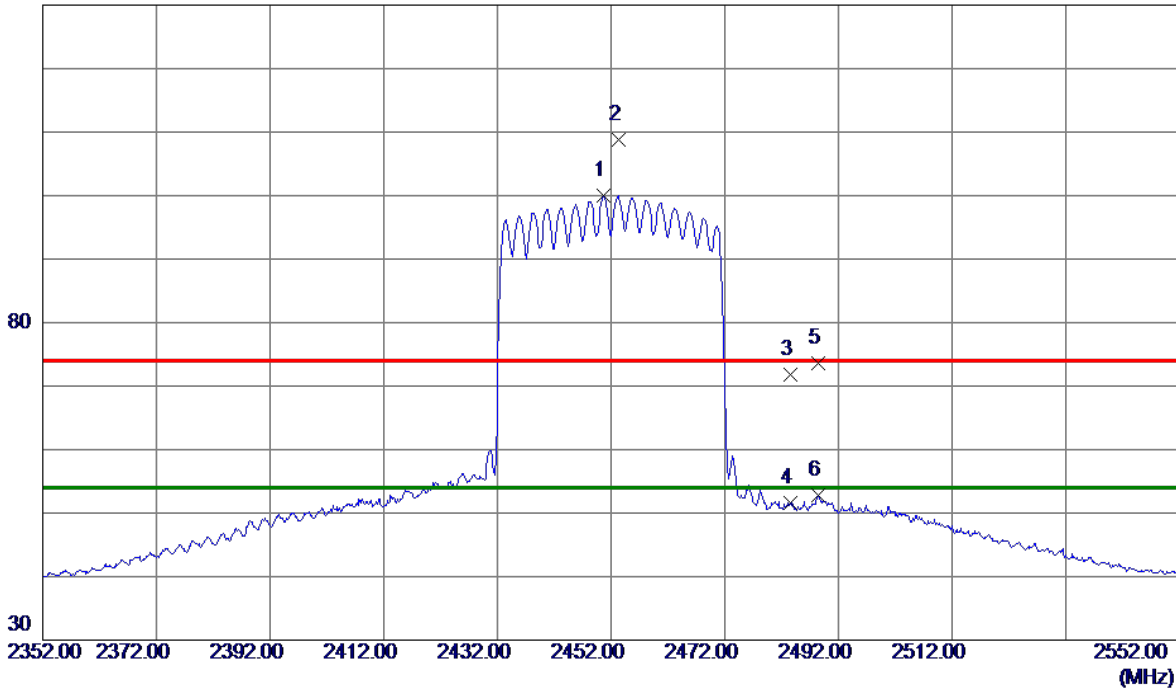

No.	Freq. MHz	Reading Level dBuV/m	Correct Factor dB	Measure ment dBuV/m	Limit dBuV/m	Margin dB	Detector	Comment
1 *	2450.7000	93.69	6.21	99.90	54.00	45.90	AVG	No Limit
2	2453.3000	102.54	6.21	108.75	74.00	34.75	Peak	No Limit
3	2483.5000	65.53	6.23	71.76	74.00	-2.24	Peak	
4	2483.5000	45.29	6.23	51.52	54.00	-2.48	AVG	
5	2488.4000	67.39	6.23	73.62	74.00	-0.38	Peak	
6	2488.4000	46.54	6.23	52.77	54.00	-1.23	AVG	

REMARKS:

- (1) Measurement Value = Reading Level + Correct Factor.
- (2) Margin Level = Measurement Value - Limit Value.

Test Mode	TX AX(HE40) Mode 2452 MHz	Polarization	Horizontal
-----------	---------------------------	--------------	------------

80 dBuV/m

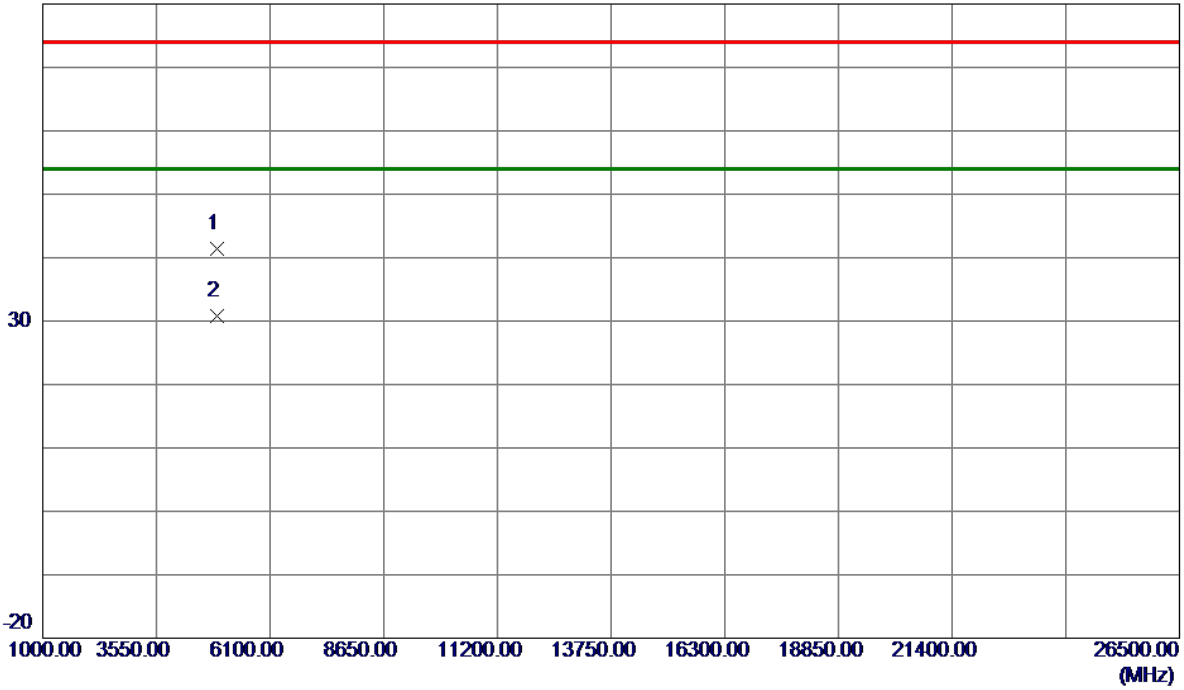

No.	Freq. MHz	Reading Level dBuV/m	Correct Factor dB	Measure ment dBuV/m	Limit dBuV/m	Margin dB	Detector	Comment
1	4904.0520	40.32	1.16	41.48	74.00	-32.52	Peak	
2 *	4905.9129	29.69	1.16	30.85	54.00	-23.15	AVG	

REMARKS:

- (1) Measurement Value = Reading Level + Correct Factor.
- (2) Margin Level = Measurement Value - Limit Value.

APPENDIX E - BANDWIDTH

Test Mode TX B Mode

Channel	Frequency (MHz)	6 dB Bandwidth (MHz)	99 % Occupied Bandwidth (MHz)	6 dB Bandwidth Min. Limit (MHz)	Result
01	2412	8.100	12.880	0.5	Complies
06	2437	8.070	12.880	0.5	Complies
11	2462	8.580	12.800	0.5	Complies

CH01

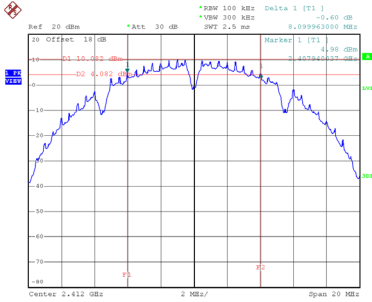

Date: 30.DEC.2023 18:55:01

CH06
6 dB Bandwidth

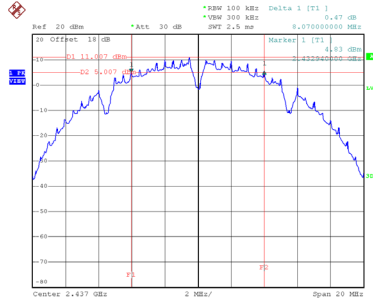

Date: 30.DEC.2023 18:56:18

CH11

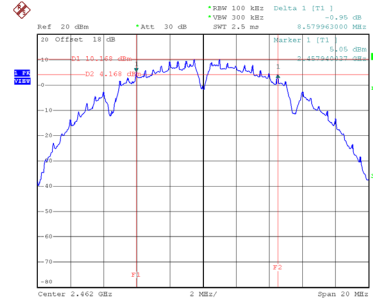

Date: 30.DEC.2023 18:59:05

99 % Occupied Bandwidth

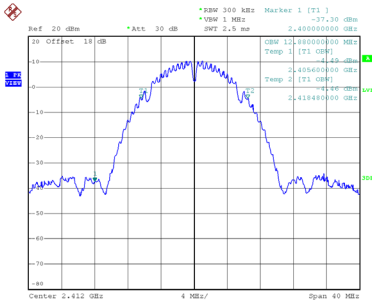

Date: 7.JAN.2024 04:20:58

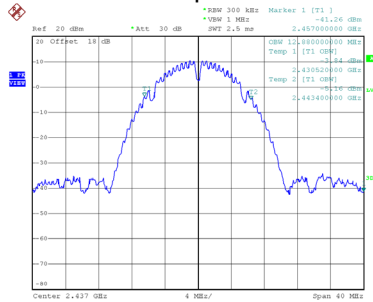

Date: 7.JAN.2024 04:30:24

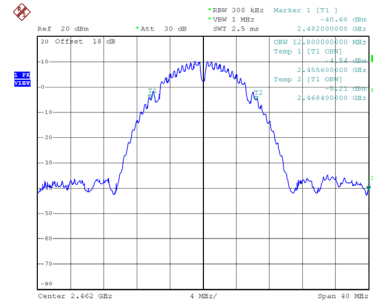

Date: 7.JAN.2024 04:37:31

Test Mode	TX G Mode
-----------	-----------

Channel	Frequency (MHz)	6 dB Bandwidth (MHz)	99 % Occupied Bandwidth (MHz)	6 dB Bandwidth Min. Limit (MHz)	Result
01	2412	15.100	16.880	0.5	Complies
06	2437	15.140	17.040	0.5	Complies
11	2462	15.080	16.880	0.5	Complies

CH01

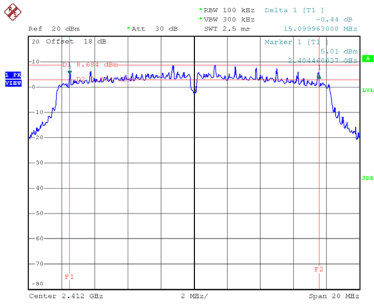

Date: 30.DEC.2023 19:02:09

CH06

6 dB Bandwidth

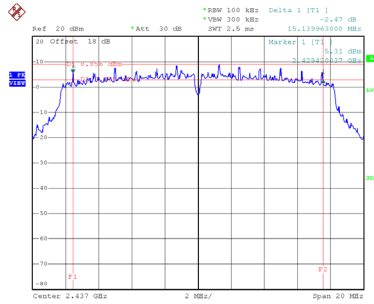

Date: 30.DEC.2023 19:02:58

CH11

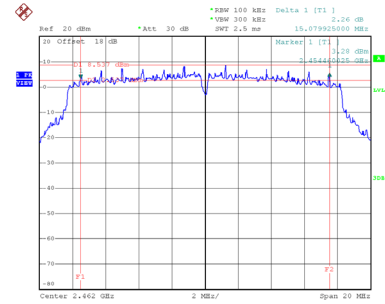

Date: 30.DEC.2023 19:03:46

99 % Occupied Bandwidth

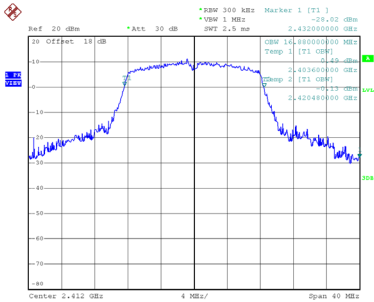

Date: 7.JAN.2024 04:43:39

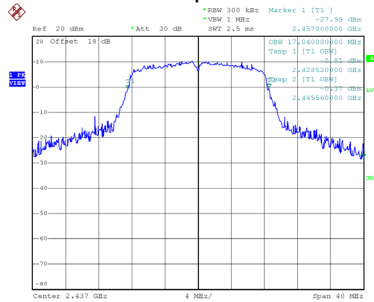

Date: 7.JAN.2024 04:48:30

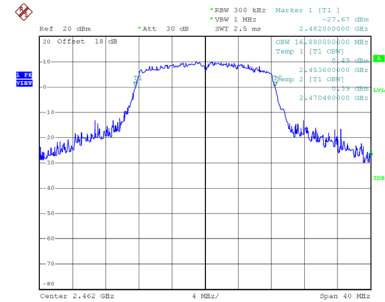

Date: 7.JAN.2024 04:52:44

Test Mode	TX N(HT20) Mode
-----------	-----------------

Channel	Frequency (MHz)	6 dB Bandwidth (MHz)	99 % Occupied Bandwidth (MHz)	6 dB Bandwidth Min. Limit (MHz)	Result
01	2412	15.160	17.840	0.5	Complies
06	2437	15.119	17.840	0.5	Complies
11	2462	16.000	17.840	0.5	Complies

CH01

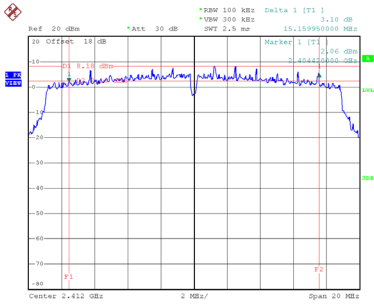

Date: 30.DEC.2023 19:05:17

CH06

6 dB Bandwidth

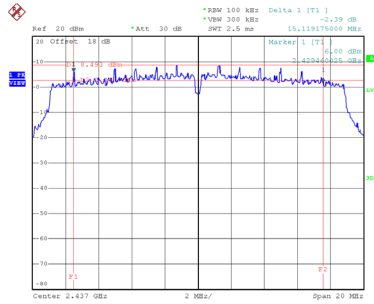

Date: 30.DEC.2023 19:05:56

CH11

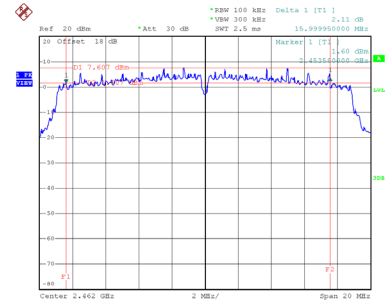

Date: 30.DEC.2023 19:06:35

99 % Occupied Bandwidth

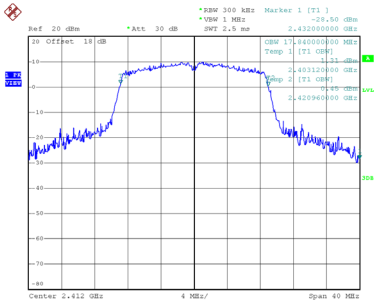

Date: 7.JAN.2024 04:57:39

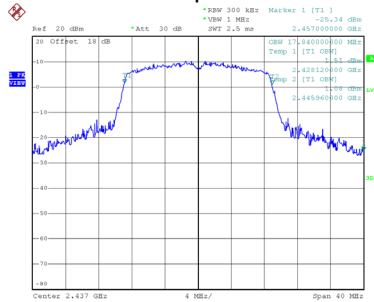

Date: 7.JAN.2024 05:01:21

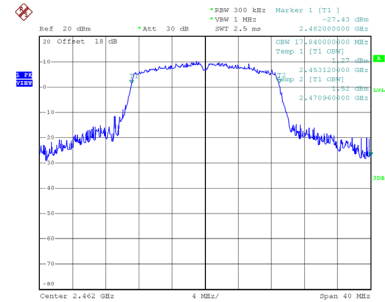

Date: 7.JAN.2024 05:05:25

Test Mode TX N(HT40) Mode

Channel	Frequency (MHz)	6 dB Bandwidth (MHz)	99 % Occupied Bandwidth (MHz)	6 dB Bandwidth Min. Limit (MHz)	Result
03	2422	35.240	36.320	0.5	Complies
06	2437	33.960	36.480	0.5	Complies
09	2452	35.160	36.640	0.5	Complies

CH03

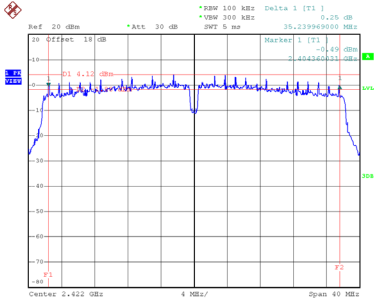

Date: 30.DEC.2023 19:10:18

CH06
6 dB Bandwidth

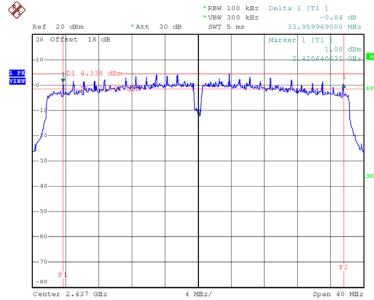

Date: 30.DEC.2023 19:10:48

CH09

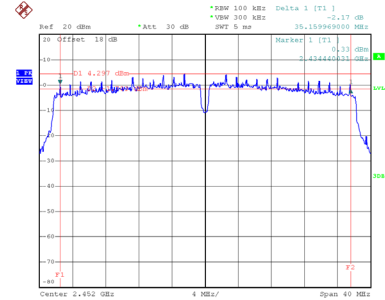

Date: 30.DEC.2023 19:11:15

99 % Occupied Bandwidth

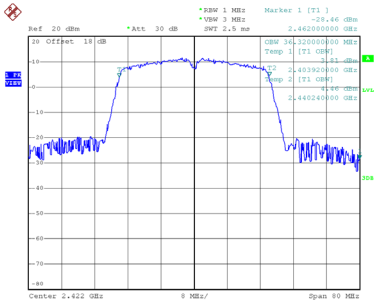

Date: 7.JAN.2024 05:23:12

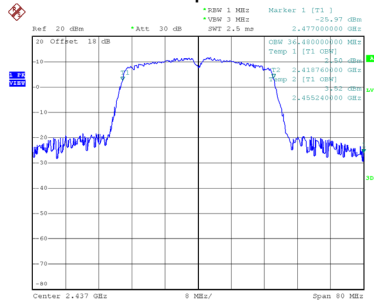

Date: 7.JAN.2024 05:27:36

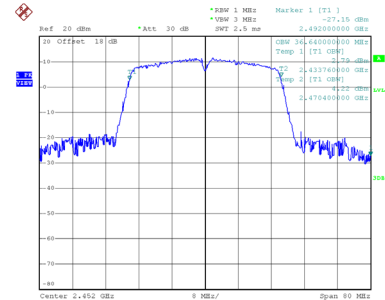

Date: 7.JAN.2024 05:35:21

Test Mode TX AX(HE20) Mode

Channel	Frequency (MHz)	6 dB Bandwidth (MHz)	99 % Occupied Bandwidth (MHz)	6 dB Bandwidth Min. Limit (MHz)	Result
01	2412	18.620	18.960	0.5	Complies
06	2437	17.419	19.200	0.5	Complies
11	2462	17.840	19.200	0.5	Complies

CH01

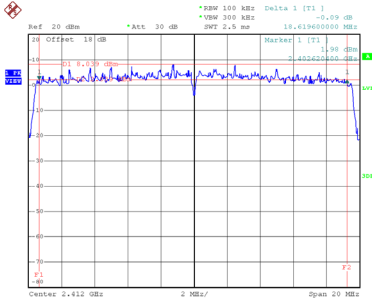

Date: 30.DEC.2023 19:12:00

CH06
6 dB Bandwidth

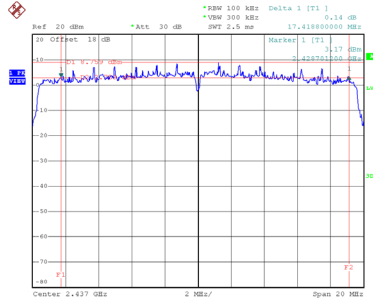

Date: 30.DEC.2023 19:12:32

CH11

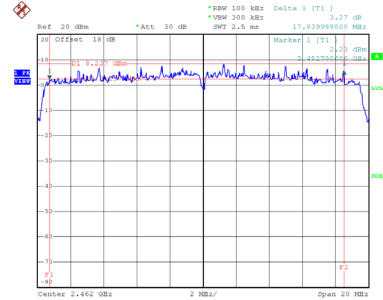

Date: 30.DEC.2023 19:13:09

99 % Occupied Bandwidth

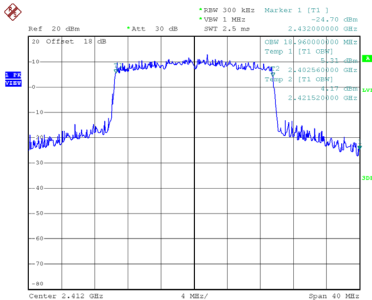

Date: 7.JAN.2024 05:08:32

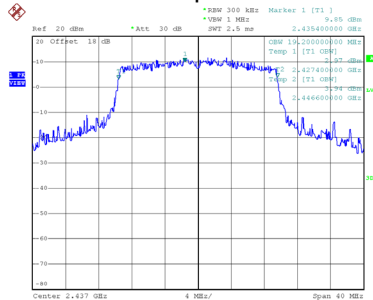

Date: 7.JAN.2024 05:13:28

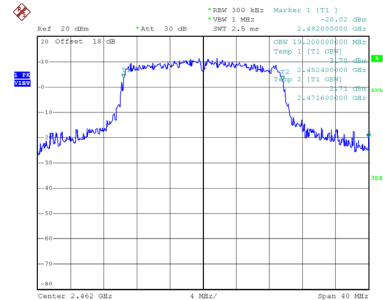

Date: 7.JAN.2024 05:17:58

Test Mode	TX AX(HE40) Mode
-----------	------------------

Channel	Frequency (MHz)	6 dB Bandwidth (MHz)	99 % Occupied Bandwidth (MHz)	6 dB Bandwidth Min. Limit (MHz)	Result
03	2422	36.639	37.920	0.5	Complies
06	2437	36.718	38.080	0.5	Complies
09	2452	37.640	37.920	0.5	Complies

CH03

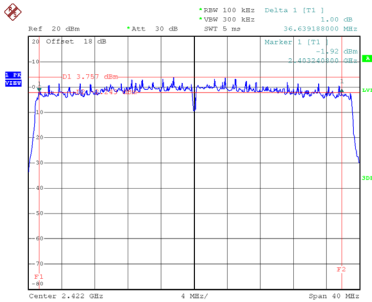

Date: 30.DEC.2023 19:14:00

CH06

6 dB Bandwidth

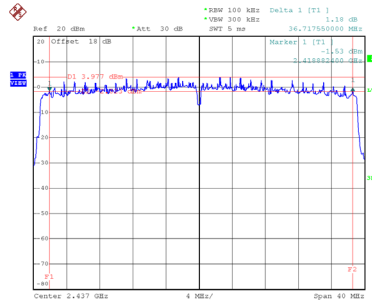

Date: 30.DEC.2023 19:14:25

CH09

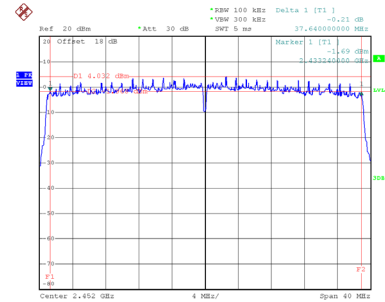

Date: 30.DEC.2023 19:14:47

99 % Occupied Bandwidth

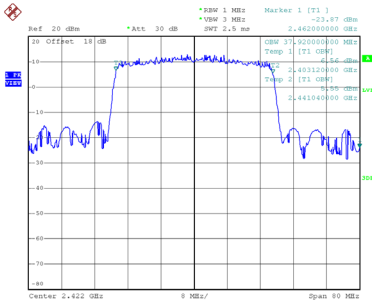

Date: 7.JAN.2024 05:13:16

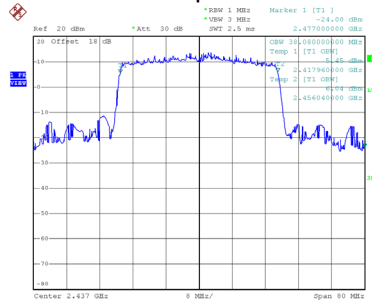

Date: 7.JAN.2024 05:13:50

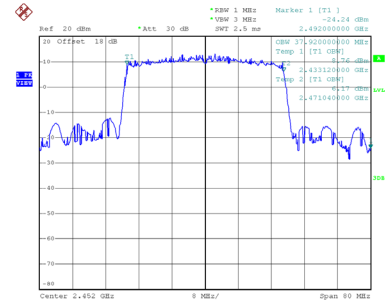

Date: 7.JAN.2024 05:17:13

APPENDIX F - MAXIMUM OUTPUT POWER

Non Beamforming

Test Mode	TX B Mode_Ant. 1
-----------	------------------

Channel	Frequency (MHz)	Output Power (dBm)	Duty Factor	Output Power + Duty Factor (dBm)	Max. Limit (dBm)	Max. Limit (W)	Result
01	2412	19.65	0.00	19.65	30.00	1.0000	Complies
06	2437	19.92	0.00	19.92	30.00	1.0000	Complies
11	2462	19.65	0.00	19.65	30.00	1.0000	Complies

Test Mode	TX B Mode_Ant. 2
-----------	------------------

Channel	Frequency (MHz)	Output Power (dBm)	Duty Factor	Output Power + Duty Factor (dBm)	Max. Limit (dBm)	Max. Limit (W)	Result
01	2412	19.90	0.00	19.90	30.00	1.0000	Complies
06	2437	19.78	0.00	19.78	30.00	1.0000	Complies
11	2462	19.89	0.00	19.89	30.00	1.0000	Complies

Test Mode	TX B Mode_Total
-----------	-----------------

Channel	Frequency (MHz)	Output Power (dBm)	Max. Limit (dBm)	Max. Limit (W)	Result
01	2412	22.79	30.00	1.0000	Complies
06	2437	22.86	30.00	1.0000	Complies
11	2462	22.78	30.00	1.0000	Complies

Test Mode	TX G Mode_Ant. 1
-----------	------------------

Channel	Frequency (MHz)	Output Power (dBm)	Duty Factor	Output Power + Duty Factor (dBm)	Max. Limit (dBm)	Max. Limit (W)	Result
01	2412	17.54	0.19	17.73	30.00	1.0000	Complies
06	2437	19.82	0.19	20.01	30.00	1.0000	Complies
11	2462	17.26	0.19	17.45	30.00	1.0000	Complies

Test Mode	TX G Mode_Ant. 2
-----------	------------------

Channel	Frequency (MHz)	Output Power (dBm)	Duty Factor	Output Power + Duty Factor (dBm)	Max. Limit (dBm)	Max. Limit (W)	Result
01	2412	17.46	0.19	17.65	30.00	1.0000	Complies
06	2437	19.81	0.19	20.00	30.00	1.0000	Complies
11	2462	17.34	0.19	17.53	30.00	1.0000	Complies

Test Mode	TX G Mode_Total
-----------	-----------------

Channel	Frequency (MHz)	Output Power (dBm)	Max. Limit (dBm)	Max. Limit (W)	Result
01	2412	20.70	30.00	1.0000	Complies
06	2437	23.02	30.00	1.0000	Complies
11	2462	20.50	30.00	1.0000	Complies

Test Mode	TX N(HT20) Mode_Ant. 1
-----------	------------------------

Channel	Frequency (MHz)	Output Power (dBm)	Duty Factor	Output Power + Duty Factor (dBm)	Max. Limit (dBm)	Max. Limit (W)	Result
01	2412	17.38	0.19	17.57	30.00	1.0000	Complies
06	2437	19.58	0.19	19.77	30.00	1.0000	Complies
11	2462	16.78	0.19	16.97	30.00	1.0000	Complies

Test Mode	TX N(HT20) Mode_Ant. 2
-----------	------------------------

Channel	Frequency (MHz)	Output Power (dBm)	Duty Factor	Output Power + Duty Factor (dBm)	Max. Limit (dBm)	Max. Limit (W)	Result
01	2412	17.35	0.19	17.54	30.00	1.0000	Complies
06	2437	19.72	0.19	19.91	30.00	1.0000	Complies
11	2462	16.71	0.19	16.90	30.00	1.0000	Complies

Test Mode	TX N(HT20) Mode_Total
-----------	-----------------------

Channel	Frequency (MHz)	Output Power (dBm)	Max. Limit (dBm)	Max. Limit (W)	Result
01	2412	20.57	30.00	1.0000	Complies
06	2437	22.85	30.00	1.0000	Complies
11	2462	19.95	30.00	1.0000	Complies

Test Mode	TX N(HT40) Mode_Ant. 1
-----------	------------------------

Channel	Frequency (MHz)	Output Power (dBm)	Duty Factor	Output Power + Duty Factor (dBm)	Max. Limit (dBm)	Max. Limit (W)	Result
03	2422	15.57	0.19	15.76	30.00	1.0000	Complies
06	2437	17.01	0.19	17.20	30.00	1.0000	Complies
09	2452	16.41	0.19	16.60	30.00	1.0000	Complies

Test Mode	TX N(HT40) Mode_Ant. 2
-----------	------------------------

Channel	Frequency (MHz)	Output Power (dBm)	Duty Factor	Output Power + Duty Factor (dBm)	Max. Limit (dBm)	Max. Limit (W)	Result
03	2422	15.48	0.19	15.67	30.00	1.0000	Complies
06	2437	16.99	0.19	17.18	30.00	1.0000	Complies
09	2452	16.49	0.19	16.68	30.00	1.0000	Complies

Test Mode	TX N(HT40) Mode_Total
-----------	-----------------------

Channel	Frequency (MHz)	Output Power (dBm)	Max. Limit (dBm)	Max. Limit (W)	Result
03	2422	18.73	30.00	1.0000	Complies
06	2437	20.20	30.00	1.0000	Complies
09	2452	19.65	30.00	1.0000	Complies

Test Mode	TX AX(HE20) Mode_Ant. 1
-----------	-------------------------

Channel	Frequency (MHz)	Output Power (dBm)	Duty Factor	Output Power + Duty Factor (dBm)	Max. Limit (dBm)	Max. Limit (W)	Result
01	2412	17.02	0.25	17.27	30.00	1.0000	Complies
06	2437	19.75	0.25	20.00	30.00	1.0000	Complies
11	2462	17.01	0.25	17.26	30.00	1.0000	Complies

Test Mode	TX AX(HE20) Mode_Ant. 2
-----------	-------------------------

Channel	Frequency (MHz)	Output Power (dBm)	Duty Factor	Output Power + Duty Factor (dBm)	Max. Limit (dBm)	Max. Limit (W)	Result
01	2412	16.98	0.25	17.23	30.00	1.0000	Complies
06	2437	19.70	0.25	19.95	30.00	1.0000	Complies
11	2462	16.93	0.25	17.18	30.00	1.0000	Complies

Test Mode	TX AX(HE20) Mode_Total
-----------	------------------------

Channel	Frequency (MHz)	Output Power (dBm)	Max. Limit (dBm)	Max. Limit (W)	Result
01	2412	20.26	30.00	1.0000	Complies
06	2437	22.98	30.00	1.0000	Complies
11	2462	20.23	30.00	1.0000	Complies

Test Mode	TX AX(HE40) Mode_Ant. 1
-----------	-------------------------

Channel	Frequency (MHz)	Output Power (dBm)	Duty Factor	Output Power + Duty Factor (dBm)	Max. Limit (dBm)	Max. Limit (W)	Result
03	2422	16.14	0.25	16.39	30.00	1.0000	Complies
06	2437	16.59	0.25	16.84	30.00	1.0000	Complies
09	2452	15.49	0.25	15.74	30.00	1.0000	Complies

Test Mode	TX AX(HE40) Mode_Ant. 2
-----------	-------------------------

Channel	Frequency (MHz)	Output Power (dBm)	Duty Factor	Output Power + Duty Factor (dBm)	Max. Limit (dBm)	Max. Limit (W)	Result
03	2422	16.18	0.25	16.43	30.00	1.0000	Complies
06	2437	16.58	0.25	16.83	30.00	1.0000	Complies
09	2452	15.54	0.25	15.79	30.00	1.0000	Complies

Test Mode	TX AX(HE40) Mode_Total
-----------	------------------------

Channel	Frequency (MHz)	Output Power (dBm)	Max. Limit (dBm)	Max. Limit (W)	Result
03	2422	19.42	30.00	1.0000	Complies
06	2437	19.84	30.00	1.0000	Complies
09	2452	18.77	30.00	1.0000	Complies

Beamforming

Test Mode	TX N(HT20) Mode_Ant. 1
-----------	------------------------

Channel	Frequency (MHz)	Output Power (dBm)	Duty Factor	Output Power + Duty Factor (dBm)	Max. Limit (dBm)	Max. Limit (W)	Result
01	2412	17.27	0.19	17.46	30.00	1.0000	Complies
06	2437	19.23	0.19	19.42	30.00	1.0000	Complies
11	2462	16.44	0.19	16.63	30.00	1.0000	Complies

Test Mode	TX N(HT20) Mode_Ant. 2
-----------	------------------------

Channel	Frequency (MHz)	Output Power (dBm)	Duty Factor	Output Power + Duty Factor (dBm)	Max. Limit (dBm)	Max. Limit (W)	Result
01	2412	16.96	0.19	17.15	30.00	1.0000	Complies
06	2437	19.01	0.19	19.20	30.00	1.0000	Complies
11	2462	16.32	0.19	16.51	30.00	1.0000	Complies

Test Mode	TX N(HT20) Mode_Total
-----------	-----------------------

Channel	Frequency (MHz)	Output Power (dBm)	Max. Limit (dBm)	Max. Limit (W)	Result
01	2412	20.32	30.00	1.0000	Complies
06	2437	22.33	30.00	1.0000	Complies
11	2462	19.58	30.00	1.0000	Complies

Test Mode	TX N(HT40) Mode_Ant. 1
-----------	------------------------

Channel	Frequency (MHz)	Output Power (dBm)	Duty Factor	Output Power + Duty Factor (dBm)	Max. Limit (dBm)	Max. Limit (W)	Result
03	2422	15.31	0.19	15.50	30.00	1.0000	Complies
06	2437	16.64	0.19	16.83	30.00	1.0000	Complies
09	2452	16.19	0.19	16.38	30.00	1.0000	Complies

Test Mode	TX N(HT40) Mode_Ant. 2
-----------	------------------------

Channel	Frequency (MHz)	Output Power (dBm)	Duty Factor	Output Power + Duty Factor (dBm)	Max. Limit (dBm)	Max. Limit (W)	Result
03	2422	15.19	0.19	15.38	30.00	1.0000	Complies
06	2437	16.89	0.19	17.08	30.00	1.0000	Complies
09	2452	16.36	0.19	16.55	30.00	1.0000	Complies

Test Mode	TX N(HT40) Mode_Total
-----------	-----------------------

Channel	Frequency (MHz)	Output Power (dBm)	Max. Limit (dBm)	Max. Limit (W)	Result
03	2422	18.46	30.00	1.0000	Complies
06	2437	19.97	30.00	1.0000	Complies
09	2452	19.48	30.00	1.0000	Complies

Test Mode	TX AX(HE20) Mode_Ant. 1
-----------	-------------------------

Channel	Frequency (MHz)	Output Power (dBm)	Duty Factor	Output Power + Duty Factor (dBm)	Max. Limit (dBm)	Max. Limit (W)	Result
01	2412	16.79	0.25	17.04	30.00	1.0000	Complies
06	2437	19.12	0.25	19.37	30.00	1.0000	Complies
11	2462	16.71	0.25	16.96	30.00	1.0000	Complies

Test Mode	TX AX(HE20) Mode_Ant. 2
-----------	-------------------------

Channel	Frequency (MHz)	Output Power (dBm)	Duty Factor	Output Power + Duty Factor (dBm)	Max. Limit (dBm)	Max. Limit (W)	Result
01	2412	16.77	0.25	17.02	30.00	1.0000	Complies
06	2437	18.87	0.25	19.12	30.00	1.0000	Complies
11	2462	16.66	0.25	16.91	30.00	1.0000	Complies

Test Mode	TX AX(HE20) Mode_Total
-----------	------------------------

Channel	Frequency (MHz)	Output Power (dBm)	Max. Limit (dBm)	Max. Limit (W)	Result
01	2412	20.04	30.00	1.0000	Complies
06	2437	22.25	30.00	1.0000	Complies
11	2462	19.94	30.00	1.0000	Complies

Test Mode	TX AX(HE40) Mode_Ant. 1
-----------	-------------------------

Channel	Frequency (MHz)	Output Power (dBm)	Duty Factor	Output Power + Duty Factor (dBm)	Max. Limit (dBm)	Max. Limit (W)	Result
03	2422	15.82	0.25	16.07	30.00	1.0000	Complies
06	2437	16.11	0.25	16.36	30.00	1.0000	Complies
09	2452	15.36	0.25	15.61	30.00	1.0000	Complies

Test Mode	TX AX(HE40) Mode_Ant. 2
-----------	-------------------------

Channel	Frequency (MHz)	Output Power (dBm)	Duty Factor	Output Power + Duty Factor (dBm)	Max. Limit (dBm)	Max. Limit (W)	Result
03	2422	15.95	0.25	16.20	30.00	1.0000	Complies
06	2437	16.35	0.25	16.60	30.00	1.0000	Complies
09	2452	15.28	0.25	15.53	30.00	1.0000	Complies

Test Mode	TX AX(HE40) Mode_Total
-----------	------------------------

Channel	Frequency (MHz)	Output Power (dBm)	Max. Limit (dBm)	Max. Limit (W)	Result
03	2422	19.14	30.00	1.0000	Complies
06	2437	19.49	30.00	1.0000	Complies
09	2452	18.58	30.00	1.0000	Complies

APPENDIX G - CONDUCTED SPURIOUS EMISSIONS

Test Mode TX B Mode_Ant. 1

Bandedge-CH01

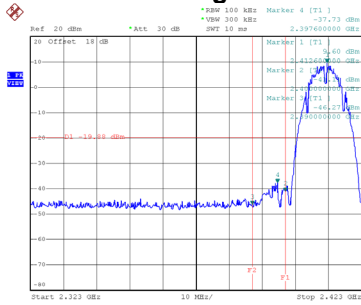

Date: 7.JAN.2024 04:23:07

Bandedge-CH11

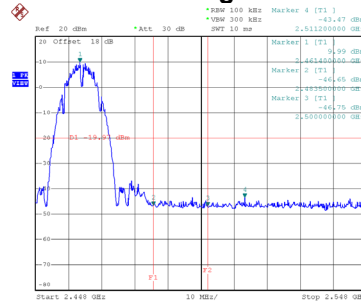

Date: 7.JAN.2024 04:38:20

CH01 – 10th Harmonic of the fundamental frequency

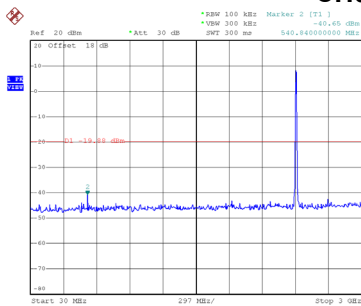

Date: 7.JAN.2024 04:26:03

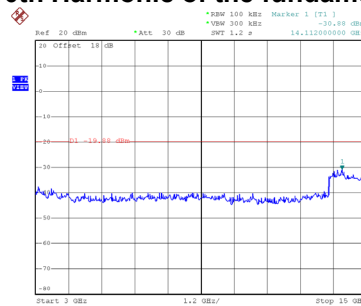

Date: 7.JAN.2024 04:27:11

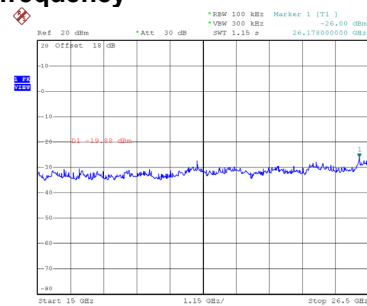

Date: 7.JAN.2024 04:28:38

CH06 – 10th Harmonic of the fundamental frequency

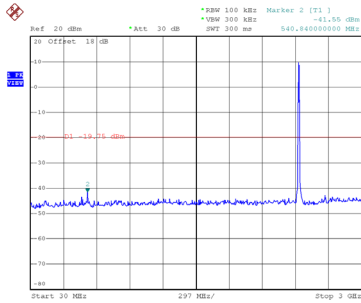

Date: 7.JAN.2024 04:32:33

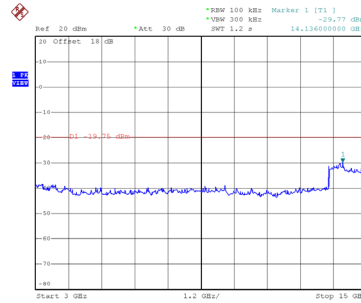

Date: 7.JAN.2024 04:34:48

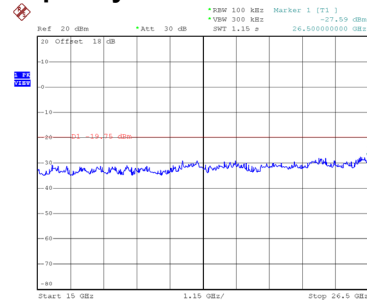

Date: 7.JAN.2024 04:36:08

CH11 – 10th Harmonic of the fundamental frequency

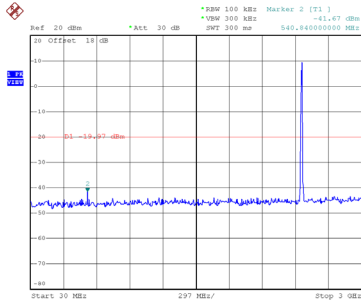

Date: 7.JAN.2024 04:39:03

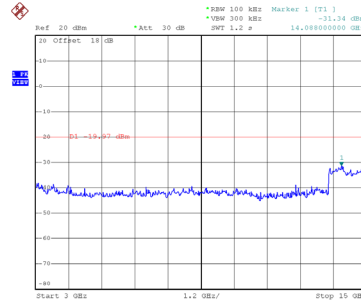

Date: 7.JAN.2024 04:39:30

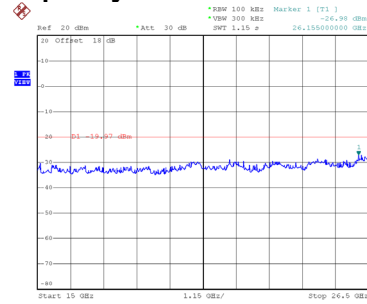

Date: 7.JAN.2024 04:39:56