

# FCC Radio Test Report

## FCC ID: 2BCGWC410

**Report No.** : eLab-FCCP-1-2312G166  
**Equipment** : Smart Wire-Free Indoor/Outdoor Security Camera  
**Brand Name** : tp-link  
**Test Model** : Tapo C410  
**Series Model** : TC82, Tapo C402  
**Applicant** : TP-LINK CORPORATION PTE. LTD.  
**Address** : 7 Temasek Boulevard #29-03 Suntec Tower One, Singapore 038987

**Radio Function** : WLAN 2.4 GHz

**FCC Rule Part(s)** : FCC CFR Title 47, Part 15, Subpart C (15.247)  
**Measurement Procedure(s)** : ANSI C63.10-2013

**Date of Receipt** : 2024/1/9  
**Date of Test** : 2024/1/22-2024/2/29  
**Issued Date** : 2024/3/22

The above equipment has been tested and found in compliance with the requirement of the above standards by eLab Inc.

**Prepared by** :   
Hunter Chiang

**Approved by** :   
Sam Chuang

**eLab Inc.**

10F., No. 167, Sec. 2, Datong Rd., Xizhi Dist., New Taipei City 221, Taiwan  
Tel: +886-2-8692-6160 Fax: +886-2-8692-6170

### Declaration

**eLab** represents to the client that testing is done in accordance with standard procedures as applicable and that test instruments used has been calibrated with standards traceable to international standard(s) and/or national standard(s).

**eLab's** reports apply only to the specific samples tested under conditions. It is manufacture's responsibility to ensure that additional production units of this model are manufactured with the identical electrical and mechanical components. **eLab** shall have no liability for any declarations, inferences or generalizations drawn by the client or others from **eLab** issued reports.

This report is the confidential property of the client. As a mutual protection to the clients, the public and ourselves, the test report shall not be reproduced, except in full, without our written approval.

**eLab's** laboratory quality assurance procedures are in compliance with the **ISO/IEC 17025** requirements, and accredited by the conformity assessment authorities listed in this test report.

**eLab** is not responsible for the sampling stage, so the results only apply to the sample as received.

The information, data and test plan are provided by manufacturer which may affect the validity of results, so it is manufacturer's responsibility to ensure that the apparatus meets the essential requirements of applied standards and in all the possible configurations as representative of its intended use.

### Limitation

For the use of the authority's logo is limited unless the Test Standard(s)/Scope(s)/Item(s) mentioned in this test report is (are) included in the conformity assessment authorities acceptance respective.

Please note that the measurement uncertainty is provided for informational purpose only and are not use in determining the Pass/Fail results.

**CONTENTS**

REVISION HISTORY	5
1 SUMMARY OF TEST RESULTS	6
1.1 TEST FACILITY	7
1.2 MEASUREMENT UNCERTAINTY	7
1.3 TEST ENVIRONMENT CONDITIONS	7
1.4 TABLE OF PARAMETERS OF TEXT SOFTWARE SETTING	8
1.5 DUTY CYCLE	8
2 GENERAL INFORMATION	9
2.1 DESCRIPTION OF EUT	9
2.2 TEST MODES	11
2.3 BLOCK DIAGRAM SHOWING THE CONFIGURATION OF SYSTEM TESTED	12
2.4 SUPPORT UNITS	13
3 AC POWER LINE CONDUCTED EMISSIONS TEST	14
3.1 LIMIT	14
3.2 TEST PROCEDURE	14
3.3 TEST SETUP	15
3.4 TEST RESULT	15
4 RADIATED EMISSIONS TEST	16
4.1 LIMIT	16
4.2 TEST PROCEDURE	17
4.3 TEST SETUP	17
4.4 EUT OPERATING CONDITIONS	18
4.5 TEST RESULT – BELOW 30 MHZ	19
4.6 TEST RESULT – 30 MHZ TO 1 GHZ	19
4.7 TEST RESULT – ABOVE 1 GHZ	19
5 BANDWIDTH TEST	20
5.1 LIMIT	20
5.2 TEST PROCEDURE	20
5.3 TEST SETUP	20
5.4 EUT OPERATING CONDITIONS	20
5.5 TEST RESULT	20
6 MAXIMUM OUTPUT POWER TEST	21
6.1 LIMIT	21
6.2 TEST PROCEDURE	21
6.3 TEST SETUP	21
6.4 EUT OPERATING CONDITIONS	21
6.5 TEST RESULT	21
7 POWER SPECTRAL DENSITY	22
7.1 LIMIT	22
7.2 TEST PROCEDURE	22
7.3 TEST SETUP	22
7.4 EUT OPERATING CONDITIONS	22
7.5 TEST RESULT	22
8 ANTENNA CONDUCTED SPURIOUS EMISSIONS TEST	23
8.1 LIMIT	23
8.2 TEST PROCEDURE	23
8.3 TEST SETUP	23

8.4	EUT OPERATING CONDITIONS	23
8.5	TEST RESULT	23
9	LIST OF MEASURING EQUIPMENTS	24
10	EUT TEST PHOTO	25
11	EUT PHOTOS	25
APPENDIX A	AC POWER LINE CONDUCTED EMISSIONS	26
APPENDIX B	RADIATED EMISSIONS - 30 MHZ TO 1 GHZ	29
APPENDIX C	RADIATED EMISSIONS - ABOVE 1 GHZ	32
APPENDIX D	BANDWIDTH	75
APPENDIX E	MAXIMUM OUTPUT POWER	79
APPENDIX F	POWER SPECTRAL DENSITY	82
APPENDIX G	ANTENNA CONDUCTED SPURIOUS EMISSIONS	85

## REVISION HISTORY

Report No.	Version	Description	Issued Date	Note
eLab-FCCP-1-2312G166	R00	Original Report.	2024/3/22	Valid

# 1 SUMMARY OF TEST RESULTS

Test procedures according to the technical standards.

FCC CFR Title 47, Part 15, Subpart C				
Standard(s) Section	Test Item	Test Result	Judgment	Remark
15.207	AC Power Line Conducted Emissions	APPENDIX A	PASS	-----
15.247(d) 15.205(a) 15.209(a)	Radiated Emissions	APPENDIX B APPENDIX C	PASS	-----
15.247(a)(2)	Bandwidth	APPENDIX D	PASS	-----
15.247(b)(3)	Maximum Output Power	APPENDIX E	PASS	-----
15.247(d)	Power Spectral Density	APPENDIX F	PASS	-----
15.247(e)	Antenna conducted Spurious Emission	APPENDIX G	PASS	-----
15.203	Antenna Requirement	-----	PASS	<b>Note(2)</b>

**NOTE:**

- (1) "N/A" denotes test is not applicable in this Test Report.
- (2) The device what use a permanently attached antenna were considered sufficient to comply with the provisions of 15.203.
- (3) The report format version is FR15CWL2.4\_V1.0

## 1.1 TEST FACILITY

The test facilities used to collect the test data in this report:

No.64, Ln. 169, Sec. 2, Datong Rd., Xizhi Dist., New Taipei City 221, Taiwan

The test sites and facilities are covered under FCC RN: 681248 and DN: TW4045.

C01       CB01       TR01

## 1.2 MEASUREMENT UNCERTAINTY

The reported uncertainty of measurement  $y \pm U$ , where expanded uncertainty  $U$  is based on a standard uncertainty multiplied by a coverage factor of  $k = 2$ , providing a level of confidence of approximately **95 %**.

The measurement instrumentation uncertainty considerations contained in CISPR 16-4-2. The eLab measurement uncertainty is less than the CISPR 16-4-2  $U_{\text{cispr}}$  requirement.

### A. AC power line conducted emissions test:

Test Site	Method	Measurement Frequency Range	$U$ (dB)
C01	CISPR	150 kHz ~ 30MHz	2.4498

### B. Radiated emissions test:

Test Site	Measurement Frequency Range	$U$ ,(dB)
CB01	0.03 GHz ~ 0.2 GHz	4.17
	0.2 GHz ~ 1 GHz	4.72
	1 GHz ~ 6 GHz	5.21
	6 GHz ~ 18 GHz	5.51
	18 GHz ~ 26 GHz	3.69
	26 GHz ~ 40 GHz	4.23

### C. Conducted test:

Test Item	$U$ ,(dB)
Occupied Bandwidth	1.0502
Output power	1.0406
Conducted Spurious emissions	1.20
Conducted Band edges	1.0518
Power Spectral Density	1.20

### NOTE:

Unless specifically mentioned, the uncertainty of measurement has not been taken into account to declare the compliance or non-compliance to the specification.

## 1.3 TEST ENVIRONMENT CONDITIONS

Test Item	Environment Condition	Test Voltage	Tested by
AC Power Line Conducted Emissions	25°C, 45%	AC 120V	Hunter Chiang
Radiated emissions below 1 GHz	25°C, 60%	AC 120V	Hunter Chiang
Radiated emissions above 1 GHz	24°C, 60%	AC 120V	Hunter Chiang
Bandwidth	24°C, 60%	AC 120V	Cheng Tsai
Maximum Output Power	24°C, 60%	AC 120V	Cheng Tsai
Power Spectral Density	24°C, 60%	AC 120V	Cheng Tsai
Antenna conducted Spurious Emission	25°C, 45%	AC 120V	Cheng Tsai

## 1.4 TABLE OF PARAMETERS OF TEXT SOFTWARE SETTING

Test Software	IPOP V4.0			
Mode	2412 MHz	2437 MHz	2462 MHz	Data Rate
IEEE 802.11b	70	127	67	1 Mbps
IEEE 802.11g	50	127	40	6 Mbps
IEEE 802.11n(HT20)	40	127	35	MCS 0

## 1.5 DUTY CYCLE

If duty cycle is  $\geq 98\%$ , duty factor is not required.  
 If duty cycle is  $< 98\%$ , duty factor shall be considered.  
 The output power = measured power + duty factor.

**IEEE 802.11b**



Duty cycle = 0.000 ms / 0.000 ms = 0.00%  
 Duty Factor =  $10 \log(1/\text{Duty cycle}) = 0.00$

**IEEE 802.11g**

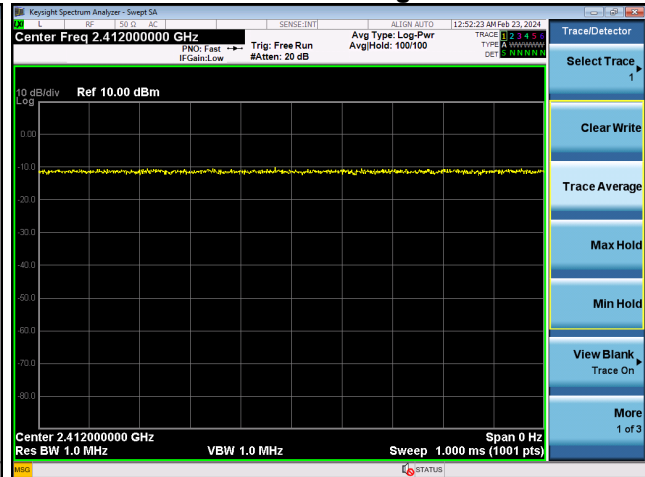

Duty cycle = 0.000 ms / 0.000 ms = 0.00%  
 Duty Factor =  $10 \log(1/\text{Duty cycle}) = 0.00$

**IEEE 802.11n(HT20)**

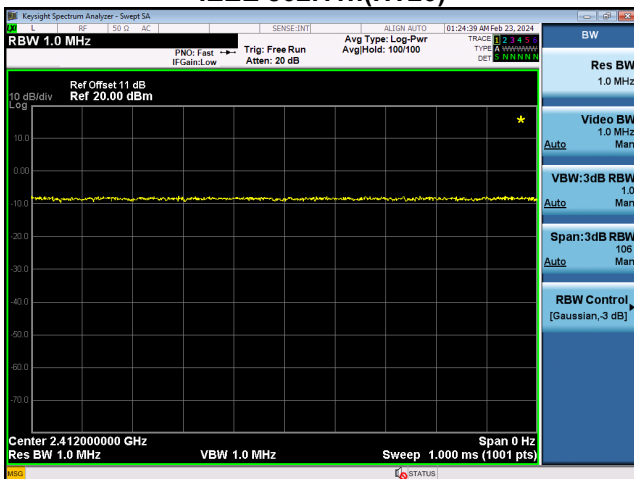

Duty cycle = 0.000 ms / 0.000 ms = 0.00%  
 Duty Factor =  $10 \log(1/\text{Duty cycle}) = 0.00$



## 2 GENERAL INFORMATION

### 2.1 DESCRIPTION OF EUT

Equipment	Smart Wire-Free Indoor/Outdoor Security Camera
Brand Name	tp-link
Test Model	Tapo C410
Series Model	TC82, Tapo C402
Model Difference(s)	Only differ in model name.
Software Version	1.X
Hardware Version	1.0
Power Source	1# DC Voltage supplied from AC adapter. Model: A8-501000 2# Supplied from battery. Model: INR18650/33V 3# Supplied from solar panel. Model: Tapo A201
Power Rating	1# I/P: 100-240V~ 50/60Hz 0.2A Max. O/P: 5V --- 1A 2# DC 3.3V*2 3# DC 5V
Operation Band	2400 MHz ~ 2483.5 MHz
Operation Frequency	2412 MHz ~ 2462 MHz
Modulation Technology	IEEE 802.11b: DSSS IEEE 802.11g: OFDM IEEE 802.11n: OFDM
Transfer Rate	IEEE 802.11b: 11/5.5/2/1 Mbps IEEE 802.11g: 54/48/36/24/18/12/9/6 Mbps IEEE 802.11n: up to 72.2 Mbps
Maximum Output Power	Ant.1: IEEE 802.11g: 25.82 dBm (0.3819 W) Ant.2: IEEE 802.11g: 25.87 dBm (0.3864 W)

**NOTE:**

- (1) The above EUT information is declared by manufacturer and for more detailed features description, please refers to the manufacturer's specifications or user's manual.

(2) Channel List:

CH01 - CH11 for IEEE 802.11b, IEEE 802.11g, IEEE 802.11n (HT20)					
Channel	Frequency (MHz)	Channel	Frequency (MHz)	Channel	Frequency (MHz)
01	2412	05	2432	09	2452
02	2417	06	2437	10	2457
03	2422	07	2442	11	2462
04	2427	08	2447		

(3) Table for Filed Antenna:

Ant.	Manufacturer	P/N	Antenna Type	Connector	Gain (dBi)
1	BIG FIELD GLOBAL PTE. LTD	3101506732	Dipole	N/A	0
2	BIG FIELD GLOBAL PTE. LTD	3101506733	Dipole	N/A	0

Note:

- 1) The antenna gain is provided by the manufacturer.
- 2) The Ant.2 is the main antenna, Ant.1 is the reserve antenna. Ant.1 and Ant.2 do not work at the same time.

## 2.2 TEST MODES

Test Items	Test mode	Channel	Note
AC power line conducted emissions	TX Mode_ IEEE 802.11b	06	-
Transmitter Radiated Emissions (below 1GHz)	TX Mode_ IEEE 802.11b	06	-
Transmitter Radiated Emissions (above 1GHz)	TX Mode_ IEEE 802.11b	01/02/10/11	Bandedge
	TX Mode_ IEEE 802.11g		
	TX Mode_ IEEE 802.11n (HT20)		
Transmitter Radiated Emissions (above 1GHz)	TX Mode_ IEEE 802.11b	01/02/06/10/11	Harmonic
	TX Mode_ IEEE 802.11g		
	TX Mode_ IEEE 802.11n (HT20)		
Bandwidth & Output Power & Power Spectral Density & Antenna conducted Spurious Emission	TX Mode_ IEEE 802.11b	01/06/11	-
	TX Mode_ IEEE 802.11g		
	TX Mode_ IEEE 802.11n (HT20)		

**NOTE:**

- (1) For radiated emission band edge test, both Vertical and Horizontal are evaluated, but only the worst case (Vertical) is recorded.
- (2) The Output Power for Ant.1 and Ant.2 are tested are recorded in the report. The worst case is Ant.2 and only the worst case is documented for other test items.

### 2.3 BLOCK DIAGRAM SHOWING THE CONFIGURATION OF SYSTEM TESTED

Equipment letters and Cable numbers refer to item numbers described in the tables of clause 2.4.

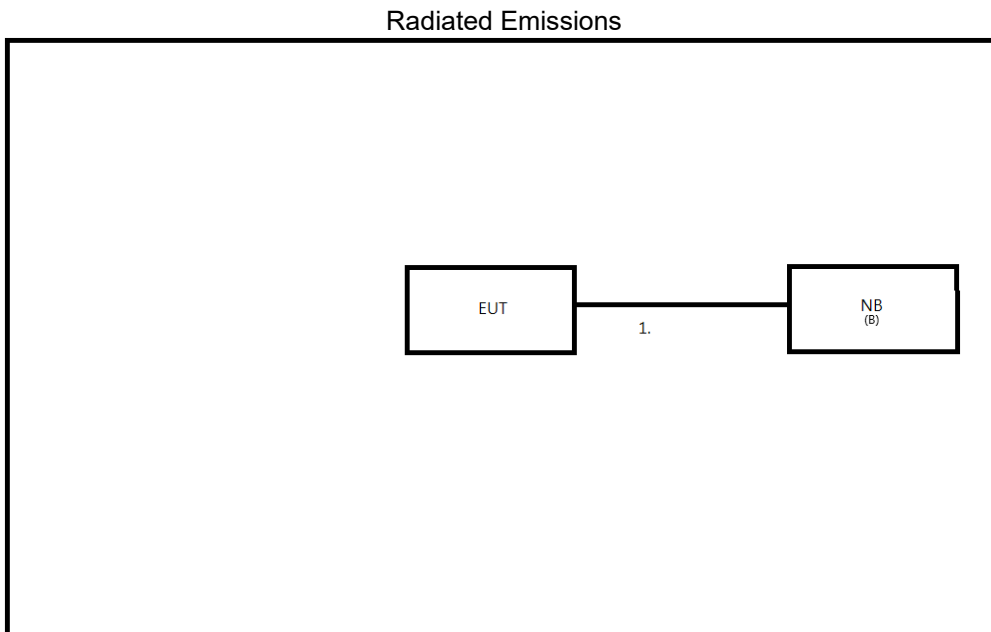
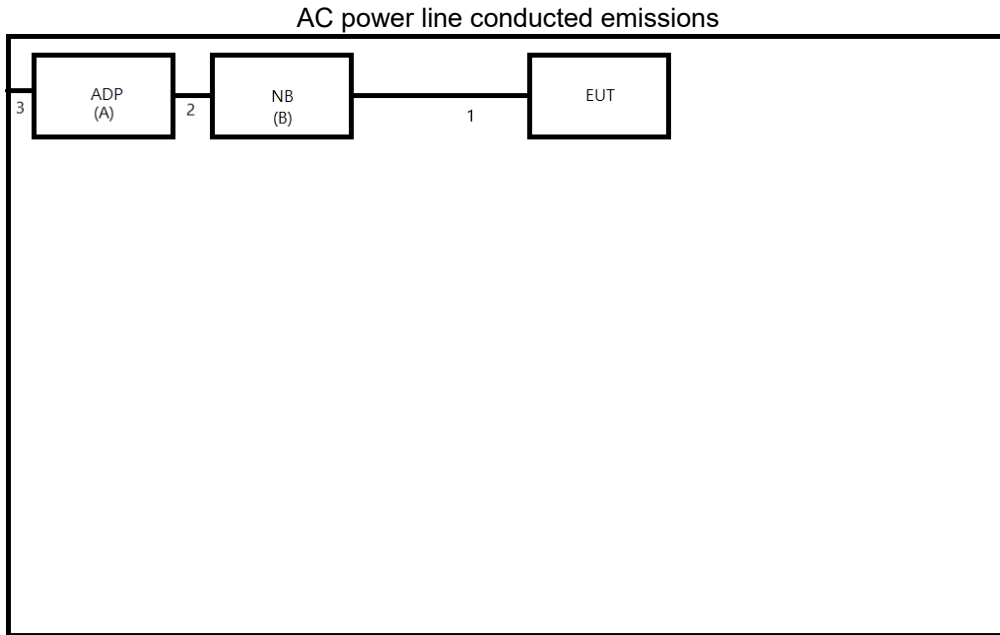

## 2.4 SUPPORT UNITS

Item	Equipment	Brand	Model No.	Remarks
A	ADP	TOSHIBA	PA5279E-1AC3	Supplied by test lab.
B	NB	Dynabook	TECRA A40-J	Supplied by test lab.

Item	Cable Type	Ferrite Core	Length	Shielded	Remarks
1	USB Cable	NO	0.5m	NO	Supplied by test requester.
2	DC Cable	YES	1.5m	NO	Supplied by test lab.
3	AC Cable	NO	1m	NO	Supplied by test lab.

### 3 AC POWER LINE CONDUCTED EMISSIONS TEST

#### 3.1 LIMIT

Frequency (MHz)	Limit (dBμV)	
	Quasi-peak	Average
0.15 - 0.5	66 - 56 *	56 - 46 *
0.5 - 5.0	56	46
5.0 - 30.0	60	50

**NOTE:**

- (1) The tighter limit applies at the band edges.
- (2) The limit of " \* " marked band means the limitation decreases linearly with the logarithm of the frequency in the range.
- (3) The test result calculated as following:

Measurement Value = Reading Level + Correct Factor  
 Correct Factor = Insertion Loss + Cable Loss + Attenuator Factor (if use)  
 Margin Level = Measurement Value – Limit Value

Calculation example:

Reading Level (dBuV)		Correct Factor (dB)		Measurement Value (dBuV)
38.22	+	3.45	=	41.67

Measurement Value (dBuV)		Limit Value (dBuV)		Margin Level (dB)
41.67	-	60	=	-18.33

The following table is the setting of the receiver.

Receiver Parameter	Setting
Attenuation	10 dB
Start Frequency	0.15 MHz
Stop Frequency	30 MHz
IF Bandwidth	9 KHz

#### 3.2 TEST PROCEDURE

- a. The EUT was placed 0.8 m above the horizontal ground plane with the EUT being connected to the power mains through a line impedance stabilization network (LISN).  
 All other support equipment were powered from an additional LISN(s).  
 The LISN provides 50 Ohm/50uH of impedance for the measuring instrument.
- b. Interconnecting cables that hang closer than 40 cm to the ground plane shall be folded back and forth in the center forming a bundle to keep the cable above 40 cm.
- c. Excess I/O cables that are not connected to a peripheral shall be bundled in the center.  
 The end of the cable will be terminated, using the correct terminating impedance.  
 The overall length shall not exceed 1 m.
- d. The LISN is spaced at least 80 cm from the nearest part of the EUT chassis.
- e. For the actual test configuration, please refer to the related Item - EUT TEST PHOTO.

**NOTE:**

- (1) In the results, each reading is marked as Peak, QP or AVG per the detector used.  
 BW=9 kHz (6 dB Bandwidth)
- (2) All readings are Peak unless otherwise stated QP or AVG in column of Note. Both the QP and the AVG readings must be less than the limit for compliance.

### 3.3 TEST SETUP

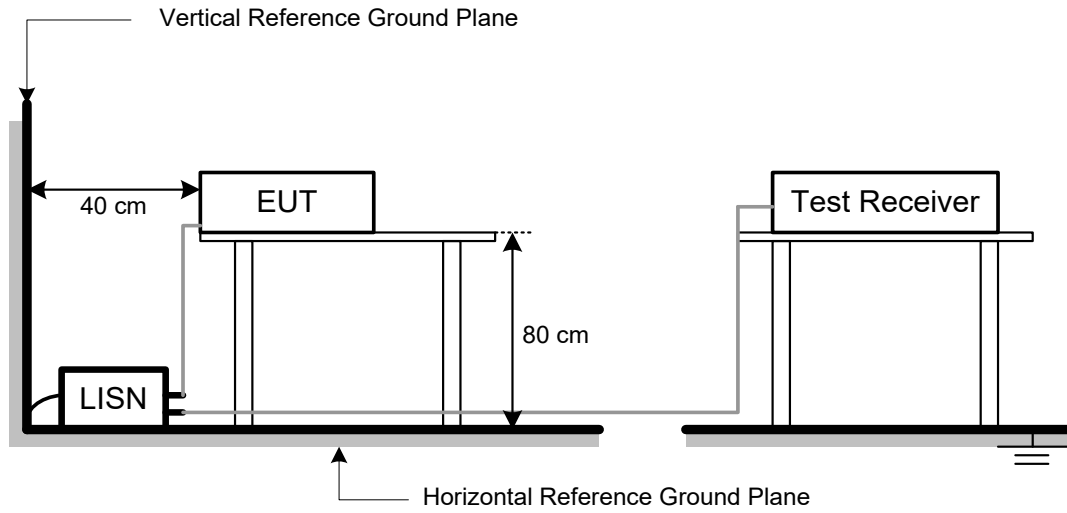

### 3.4 TEST RESULT

Please refer to the **APPENDIX A**.

## 4 RADIATED EMISSIONS TEST

### 4.1 LIMIT

In case the emission fall within the restricted band specified on 15.205, then the 15.209 limit in the table below has to be followed.

LIMITS OF RADIATED EMISSIONS MEASUREMENT (9 kHz to 1000 MHz)

Frequency (MHz)	Field Strength (microvolts/meter)	Measurement Distance (meters)
0.009~0.490	2400/F(KHz)	300
0.490~1.705	24000/F(KHz)	30
1.705~30.0	30	30
30~88	100	3
88~216	150	3
216~960	200	3
960~1000	500	3

LIMITS OF RADIATED EMISSIONS MEASUREMENT (Above 1000 MHz)

Frequency (MHz)	Radiated Emissions (dBuV/m)		Measurement Distance (meters)
	Peak	Average	
Above 1000	74	54	3

**NOTE:**

- (1) The limit for radiated test was performed according to FCC CFR Title 47, Part 15, Subpart C.
- (2) The tighter limit applies at the band edges.
- (3) Emission level (dBuV/m)=20log Emission level (uV/m).
- (4) The test result calculated as following:

Measurement Value = Reading Level + Correct Factor

Correct Factor = Antenna Factor + Cable Loss - Amplifier Gain(if use)

Margin Level = Measurement Value - Limit Value

Calculation example:

Reading Level (dBuV)		Correct Factor (dB)		Measurement Value (dBuV/m)
19.11	+	2.11	=	21.22

Measurement Value (dBuV/m)		Limit Value (dBuV/m)		Margin Level (dB)
21.22	-	54	=	-32.78

Spectrum Parameter	Setting
Attenuation	Auto
Start Frequency	1000 MHz
Stop Frequency	10th carrier harmonic
RBW / VBW (Emission in restricted band)	1MHz / 3MHz for Peak, 1MHz / 1/T for Average

Spectrum Parameter	Setting
Attenuation	Auto
Start ~ Stop Frequency	9KHz~90KHz for PK/AVG detector
Start ~ Stop Frequency	90KHz~110KHz for QP detector
Start ~ Stop Frequency	110KHz~490KHz for PK/AVG detector
Start ~ Stop Frequency	490KHz~30MHz for QP detector
Start ~ Stop Frequency	30MHz~1000MHz for QP detector



## 4.2 TEST PROCEDURE

- a. The measuring distance of 3 m shall be used for measurements. The EUT was placed on the top of a rotating table 0.8 meter above the ground at a 3 meter semi-anechoic chamber. The table was rotated 360 degrees to determine the position of the highest radiation.(below 1GHz)
- b. The measuring distance of 3 m shall be used for measurements. The EUT was placed on the top of a rotating table 1.5 meter above the ground at a 3 meter semi-anechoic chamber. The table was rotated 360 degrees to determine the position of the highest radiation.(above 1GHz)
- c. The height of the equipment or of the substitution antenna shall be 0.8 m or 1.5 m, the height of the test antenna shall vary between 1 m to 4 m. Both horizontal and vertical polarizations of the antenna are set to make the measurement.
- d. For each suspected emission, the EUT was arranged to its worst case and then the antenna was tuned to heights find the maximum reading (used Bore sight function).
- e. The receiver system was set to peak and average detect function and specified bandwidth with maximum hold mode when the test frequency is above 1GHz.
- f. The initial step in collecting radiated emission data is a receiver peak detector mode pre-scanning the measurement frequency range. Significant peaks are then marked and then Quasi Peak detector mode re-measured.
- g. All readings are Peak unless otherwise stated QP in column of Note. Peak denotes that the Peak reading compliance with the QP Limits and then QP Mode measurement didn't perform. (below 1GHz)
- h. All readings are Peak Mode value unless otherwise stated AVG in column of Note. If the Peak Mode Measured value compliance with the Peak Limits and lower than AVG Limits, the EUT shall be deemed to meet both Peak & AVG Limits and then only Peak Mode was measured, but AVG Mode didn't perform. (above 1GHz)
- i. For the actual test configuration, please refer to the related Item – EUT TEST PHOTO.

## 4.3 TEST SETUP

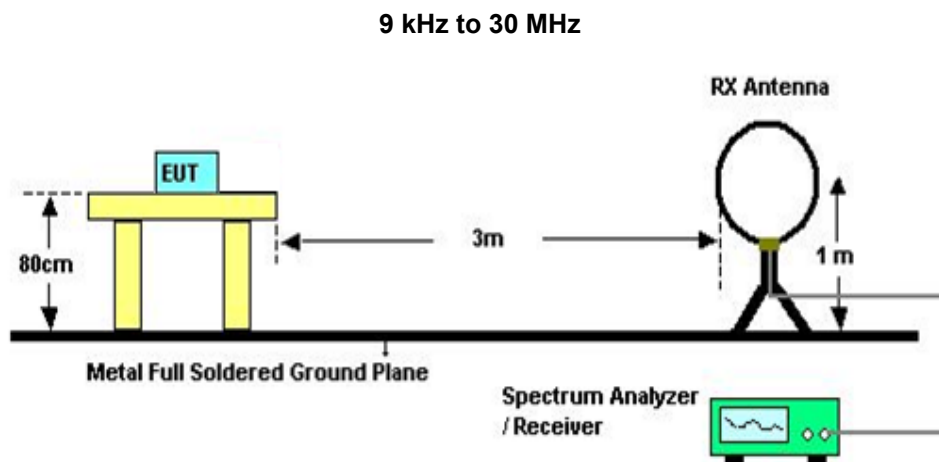

### 30 MHz to 1 GHz

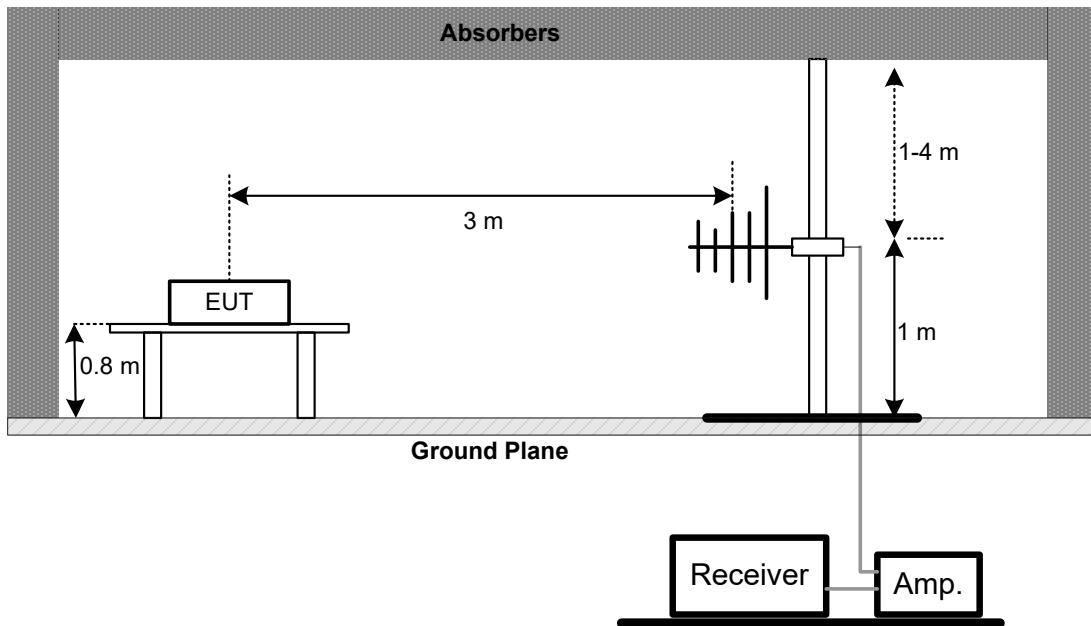

### Above 1 GHz

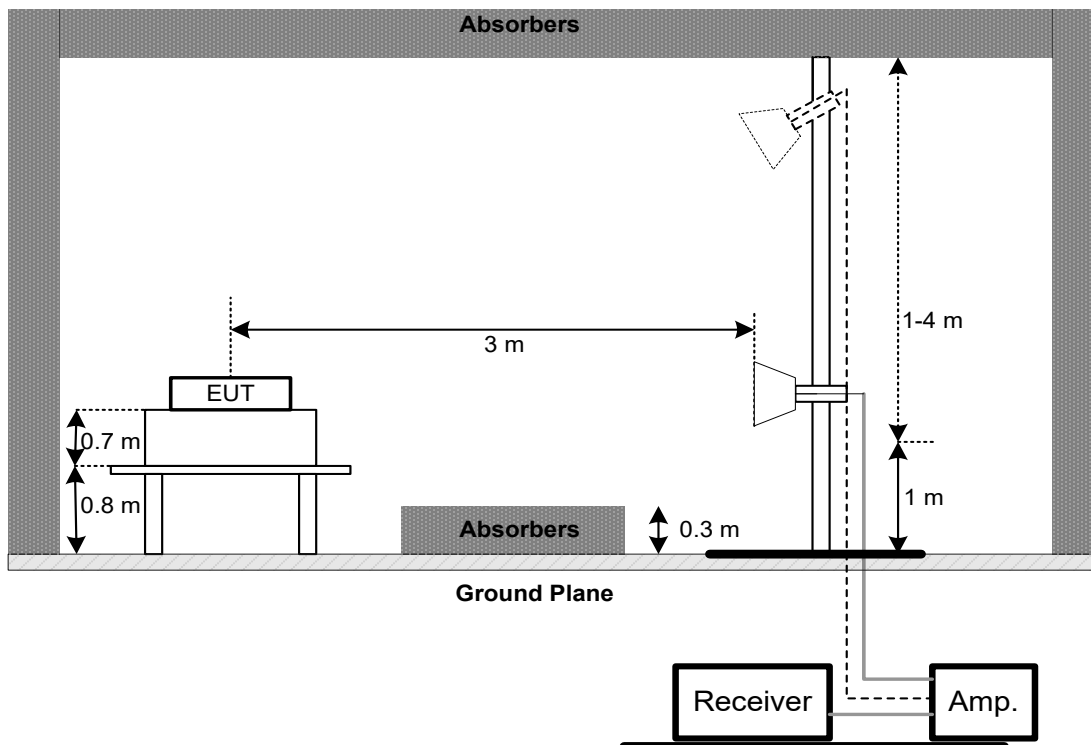

#### 4.4 EUT OPERATING CONDITIONS

The EUT was programmed to be in continuously transmitting mode.

#### **4.5 TEST RESULT – BELOW 30 MHZ**

There were no emissions found below 30 MHz within 20 dB of the limit.

#### **4.6 TEST RESULT – 30 MHZ TO 1 GHZ**

Please refer to the APPENDIX B.

#### **4.7 TEST RESULT – ABOVE 1 GHZ**

Please refer to the APPENDIX C.

#### **NOTE:**

- (1) No limit: This is fundamental signal, the judgment is not applicable.  
For fundamental signal judgment was referred to Peak output test.

## 5 BANDWIDTH TEST

### 5.1 LIMIT

FCC Part15, Subpart C (15.247)		
Section	Test Item	Limit
15.247(a)	6 dB Bandwidth	500 kHz

### 5.2 TEST PROCEDURE

- a. The EUT was directly connected to the spectrum analyzer and antenna output port as show in the block diagram below.
- b. Spectrum Setting: RBW= 300KHz, VBW=1MHz, Sweep time = 1 ms.

### 5.3 TEST SETUP

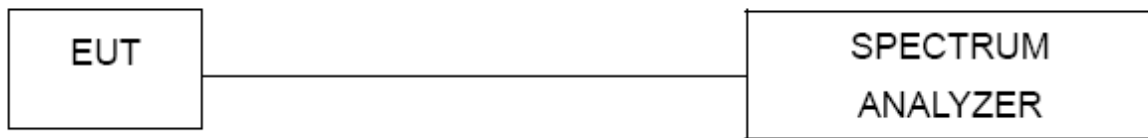

### 5.4 EUT OPERATING CONDITIONS

The EUT was programmed to be in continuously transmitting mode.

### 5.5 TEST RESULT

Please refer to the APPENDIX D.

## 6 MAXIMUM OUTPUT POWER TEST

### 6.1 LIMIT

FCC Part15, Subpart C (15.247)		
Section	Test Item	Limit
15.247(b)	Maximum Output Power	1 Watt or 30dBm

### 6.2 TEST PROCEDURE

- The EUT was directly connected to the power meter and antenna output port as show in the block diagram below.
- The maximum peak conducted output power was performed in accordance with FCC KDB 558074 D01 15.247 Meas Guidance.
- Subclause 11.9.1.1 of ANSI C63.10 is applied. The maximum peak conducted output power may be measured using a broadband peak RF power meter. The power meter shall have a video bandwidth that is greater than or equal to the DTS bandwidth and shall use a fast-responding diode detector.

### 6.3 TEST SETUP

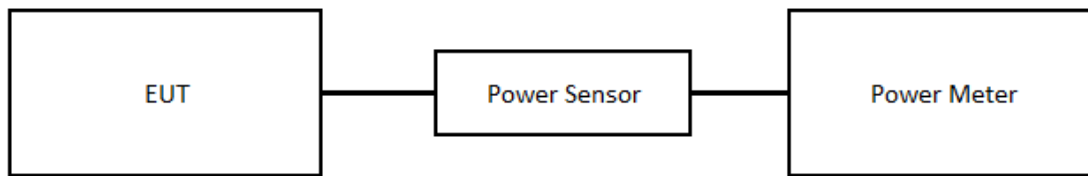

### 6.4 EUT OPERATING CONDITIONS

The EUT was programmed to be in continuously transmitting mode.

### 6.5 TEST RESULT

Please refer to the APPENDIX E.

## 7 POWER SPECTRAL DENSITY

### 7.1 LIMIT

FCC Part15, Subpart C (15.247)		
Section	Test Item	Limit
15.247(e)	Power Spectral Density	8 dBm (in any 3 kHz)

### 7.2 TEST PROCEDURE

- The EUT was directly connected to the spectrum analyzer and antenna output port as show in the block diagram below.
- Spectrum Setting: RBW = 3 kHz, VBW = 10 kHz, Sweep time = Auto.

### 7.3 TEST SETUP

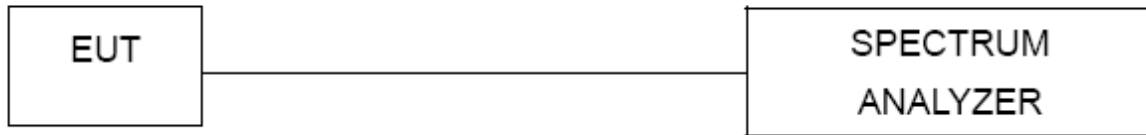

### 7.4 EUT OPERATING CONDITIONS

The EUT was programmed to be in continuously transmitting mode.

### 7.5 TEST RESULT

Please refer to the APPENDIX F.

## 8 ANTENNA CONDUCTED SPURIOUS EMISSIONS TEST

### 8.1 LIMIT

In any 100 kHz bandwidth outside the frequency band in which the spread spectrum or digitally modulated device is operating, the RF power that is produced shall be at least 20 dB below that in the 100 kHz bandwidth within the band that contains the highest level of the desired power, based on either an RF conducted or a radiated measurement, provided that the transmitter demonstrates compliance with the peak conducted power limits.

### 8.2 TEST PROCEDURE

- The EUT was directly connected to the spectrum analyzer and antenna output port as show in the block diagram below.
- Spectrum Setting: RBW = 100 kHz, VBW=300 kHz, Sweep time = Auto.
- Offset = antenna gain + cable loss.

### 8.3 TEST SETUP



### 8.4 EUT OPERATING CONDITIONS

The EUT was programmed to be in continuously transmitting mode.

### 8.5 TEST RESULT

Please refer to the APPENDIX G.

## 9 LIST OF MEASURING EQUIPMENTS

AC Power Line Conducted Emissions						
Item	Kind of Equipment	Manufacturer	Type No.	Serial No.	Calibrated Date	Calibrated Until
1	Two-Line V-Network	R&S	ENV216	101051	2023/7/21	2024/7/20
2	EMI Test Receiver	Keysight	N9038A	MY54130009	2023/6/26	2024/6/25

Radiated Emissions						
Item	Kind of Equipment	Manufacturer	Type No.	Serial No.	Calibrated Date	Calibrated Until
1	Pre-Amplifier	EMCI	EMC001330-20201222	980807	2023/12/11	2024/12/10
2	Pre-Amplifier	EMCI	EMC184045SE	980512	2023/12/11	2024/12/10
3	Pre-Amplifier	EMCI	EMC051845SE	980779	2023/12/11	2024/12/10
4	Test Cable	EMCI	EMC105-SM-SM-3000	210118	2023/12/11	2024/12/10
5	Test Cable	EMCI	EMC105-SM-SM-1000	210119	2023/12/11	2024/12/10
6	EMI Test Receiver	Keysight	N9038A	MY54130009	2023/6/26	2024/6/25
7	EXA Spectrum Analyzer	keysight	N9010A	MY56480554	2023/9/12	2024/9/11
8	Broad-Band Horn Antenna	RFSPIN	DRH18-E	210109A18E	2023/2/10	2024/2/9
9	Broad-Band Horn Antenna	Schwarzbeck	BBHA 9170	340	2023/6/29	2024/6/28
10	Trilog-Broadband Antenna	Schwarzbeck	VULB 9168	01207	2023/1/13	2024/1/12
11	Loop Ant.	Electro-Metrics	EMCI-LPA600	274	2023/6/28	2024/6/27
12	6dB Attenuator	EMCI	EMCI-N-6-05	N/A	2023/1/13	2024/1/12
13	Measurement Software	EZ	EZ EMC (Version NB-03A1-01)	N/A	N/A	N/A

Bandwidth & Maximum Output Power & Power Spectral Density & Antenna conducted Spurious Emission						
Item	Kind of Equipment	Manufacturer	Type No.	Serial No.	Calibrated Date	Calibrated Until
1	EXA Signal Analyzer	KEYSIGHT	N9010A	MY54430168	2023/6/8	2024/6/7

Remark: "N/A" denotes no model name, no serial no. or no calibration specified.  
All calibration period of equipment list is one year.



## 10 EUT TEST PHOTO

Please refer to APPENDIX-TEST PHOTOS.

## 11 EUT PHOTOS

Please refer to APPENDIX-EUT PHOTOS.

## APPENDIX A AC POWER LINE CONDUCTED EMISSIONS

Test Mode	TX B Mode Channel 06	Tested Date	2024/2/29
Test Frequency	2437MHz	Phase	Line

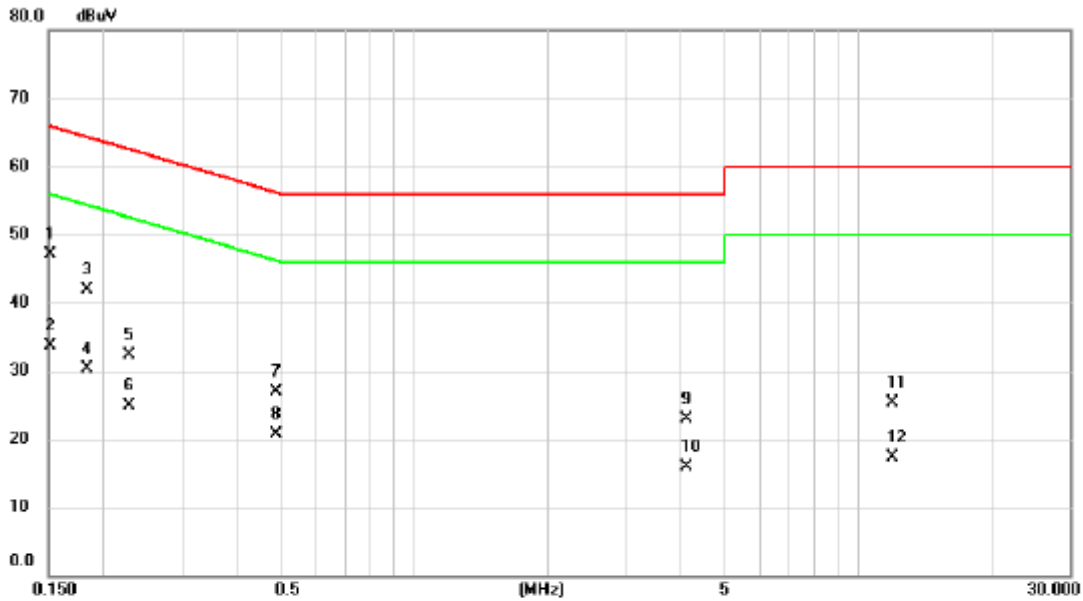

No.	Mk.	Freq. MHz	Reading Level dBuV	Correct Factor dB	Measurement dBuV	Limit dBuV	Margin dB	Detector	Comment
1	*	0.1517	37.42	9.67	47.09	65.91	-18.82	QP	
2		0.1517	24.11	9.67	33.78	55.91	-22.13	AVG	
3		0.1836	32.27	9.67	41.94	64.32	-22.38	QP	
4		0.1836	20.54	9.67	30.21	54.32	-24.11	AVG	
5		0.2287	22.68	9.67	32.35	62.50	-30.15	QP	
6		0.2287	15.24	9.67	24.91	52.50	-27.59	AVG	
7		0.4910	17.19	9.69	26.88	56.15	-29.27	QP	
8		0.4910	11.09	9.69	20.78	46.15	-25.37	AVG	
9		4.0954	13.02	9.88	22.90	56.00	-33.10	QP	
10		4.0954	6.05	9.88	15.93	46.00	-30.07	AVG	
11		11.9000	15.21	10.09	25.30	60.00	-34.70	QP	
12		11.9000	7.18	10.09	17.27	50.00	-32.73	AVG	

**REMARKS:**

- (1) Measurement Value = Reading Level + Correct Factor.
- (2) Margin Level = Measurement Value - Limit Value.

Test Mode	TX B Mode Channel 06	Tested Date	2024/2/29
Test Frequency	2437MHz	Phase	Neutral

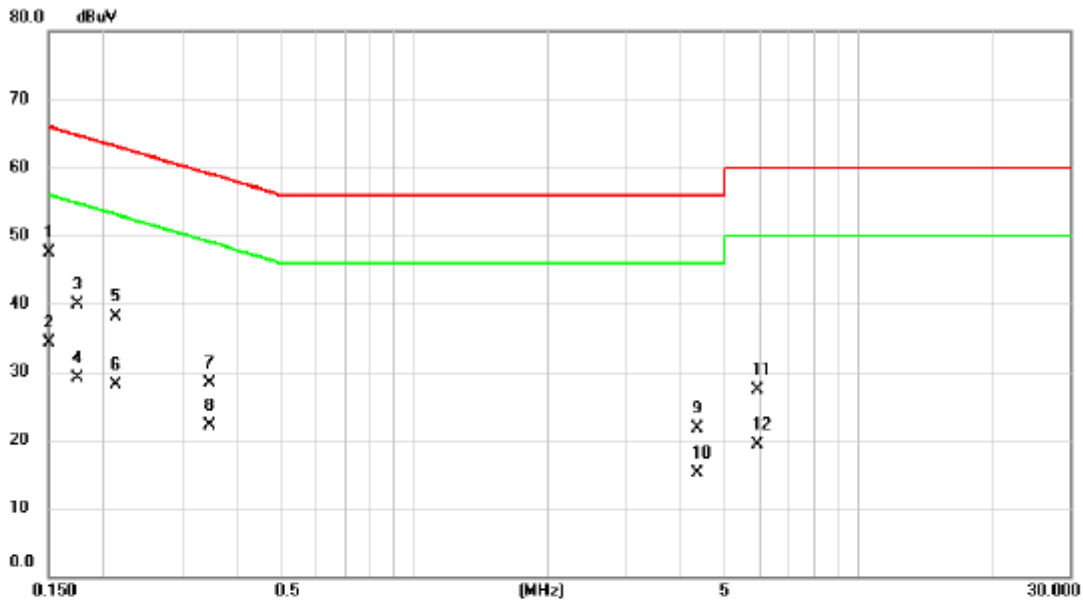

No.	Mk.	Freq. MHz	Reading Level dBuV	Correct Factor dB	Measure- ment dBuV	Limit dBuV	Margin dB	Detector	Comment
1	*	0.1503	37.78	9.67	47.45	65.98	-18.53	QP	
2		0.1503	24.57	9.67	34.24	55.98	-21.74	AVG	
3		0.1748	30.18	9.67	39.85	64.73	-24.88	QP	
4		0.1748	19.36	9.67	29.03	54.73	-25.70	AVG	
5		0.2133	28.39	9.66	38.05	63.08	-25.03	QP	
6		0.2133	18.44	9.66	28.10	53.08	-24.98	AVG	
7		0.3453	18.67	9.66	28.33	59.07	-30.74	QP	
8		0.3453	12.53	9.66	22.19	49.07	-26.88	AVG	
9		4.3340	11.73	9.88	21.61	56.00	-34.39	QP	
10		4.3340	5.31	9.88	15.19	46.00	-30.81	AVG	
11		5.9500	17.38	9.94	27.32	60.00	-32.68	QP	
12		5.9500	9.41	9.94	19.35	50.00	-30.65	AVG	

**REMARKS:**

- (1) Measurement Value = Reading Level + Correct Factor.
- (2) Margin Level = Measurement Value - Limit Value.

## APPENDIX B RADIATED EMISSIONS - 30 MHZ TO 1 GHZ

Test Mode	IEEE 802.11b	Test Date	2024/2/6
Test Frequency	2437MHz	Polarization	Vertical

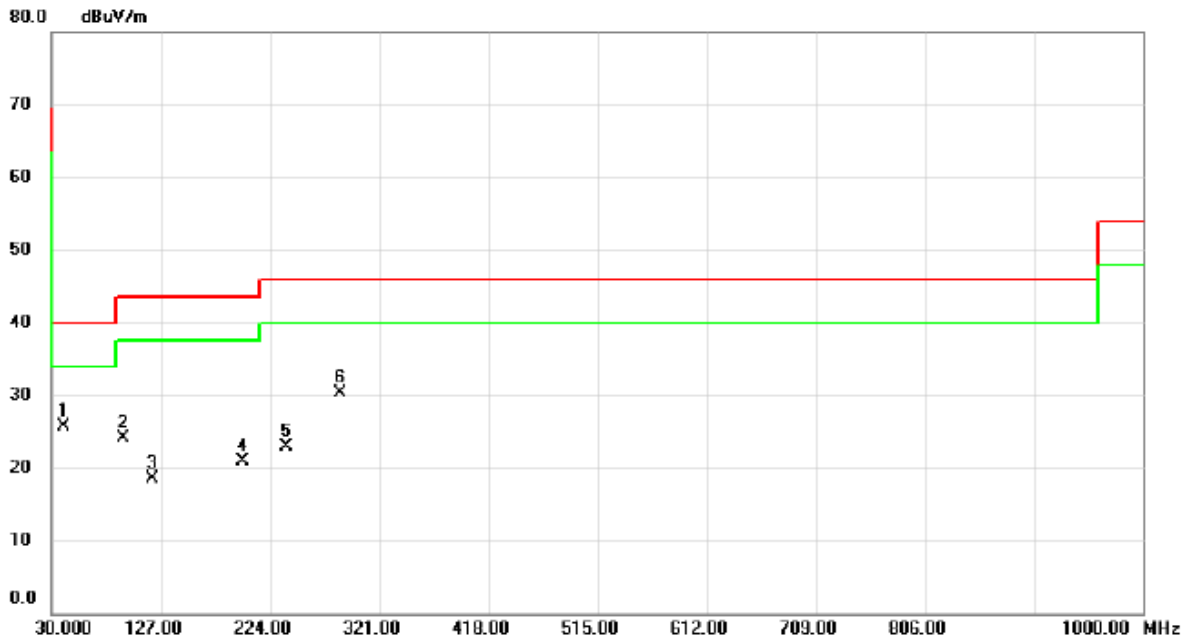

No.	Mk.	Freq.	Reading Level	Correct Factor	Measurement	Limit	Margin	Antenna Height	Table Degree	Comment
		MHz	dBuV	dB	dBuV/m	dBuV/m	dB	cm	degree	
1	*	40.6700	38.16	-12.52	25.64	40.00	-14.36	peak	100	336
2		94.0200	40.99	-16.85	24.14	43.50	-19.36	peak	100	261
3		119.2400	32.53	-14.00	18.53	43.50	-24.97	peak	200	234
4		199.7500	35.16	-14.22	20.94	43.50	-22.56	peak	200	318
5		238.5500	35.31	-12.48	22.83	46.00	-23.17	peak	200	345
6		287.0500	40.80	-10.46	30.34	46.00	-15.66	peak	200	354

**REMARKS:**

- (1) Measurement Value = Reading Level + Correct Factor.
- (2) Margin Level = Measurement Value - Limit Value.

Test Mode	IEEE 802.11b	Test Date	2024/2/6
Test Frequency	2437MHz	Polarization	Horizontal

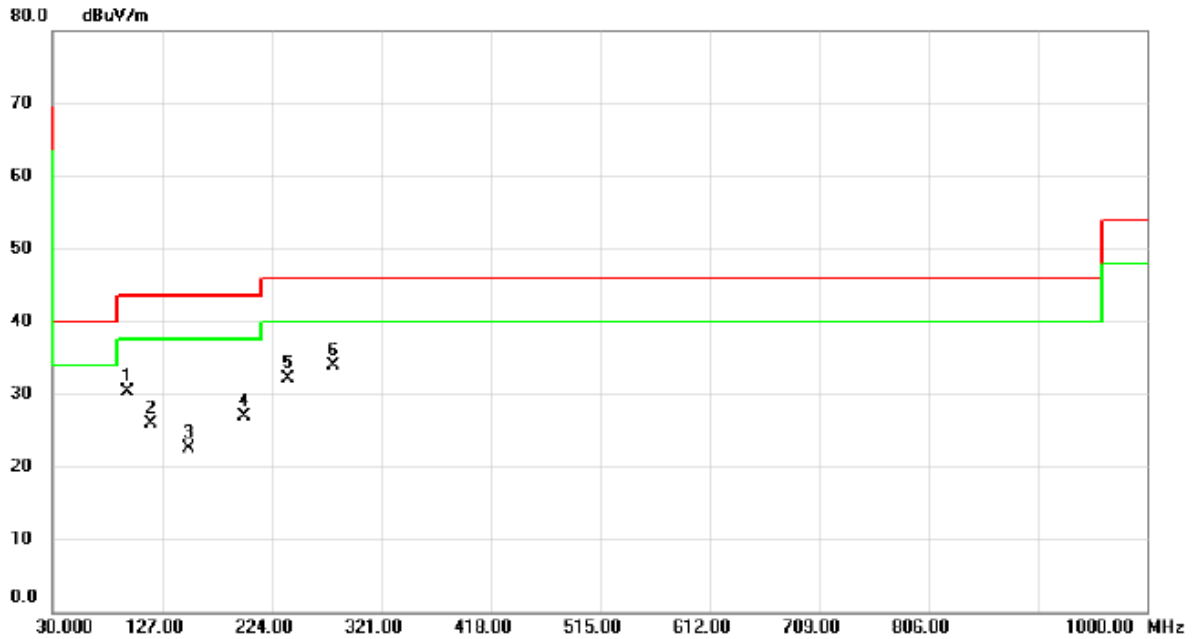

No.	Mk.	Freq.	Reading Level	Correct Factor	Measurement	Limit	Margin	Antenna Height	Table Degree	
		MHz	dBuV	dB	dBuV/m	dBuV/m	dB	cm	degree	Comment
1		95.9600	46.98	-16.64	30.34	43.50	-13.16	peak	200	139
2		117.3000	40.04	-14.18	25.86	43.50	-17.64	peak	200	314
3		150.2800	33.63	-11.12	22.51	43.50	-20.99	peak	177	360
4		199.7500	41.09	-14.22	26.87	43.50	-16.63	peak	100	360
5		238.5500	44.57	-12.48	32.09	46.00	-13.91	peak	100	165
6	*	279.2900	44.62	-10.80	33.82	46.00	-12.18	peak	100	232

**REMARKS:**

- (1) Measurement Value = Reading Level + Correct Factor.
- (2) Margin Level = Measurement Value - Limit Value.

## APPENDIX C RADIATED EMISSIONS - ABOVE 1 GHZ



Test Mode	IEEE 802.11b	Test Date	2024/2/4
Test Frequency	2412MHz	Polarization	Vertical

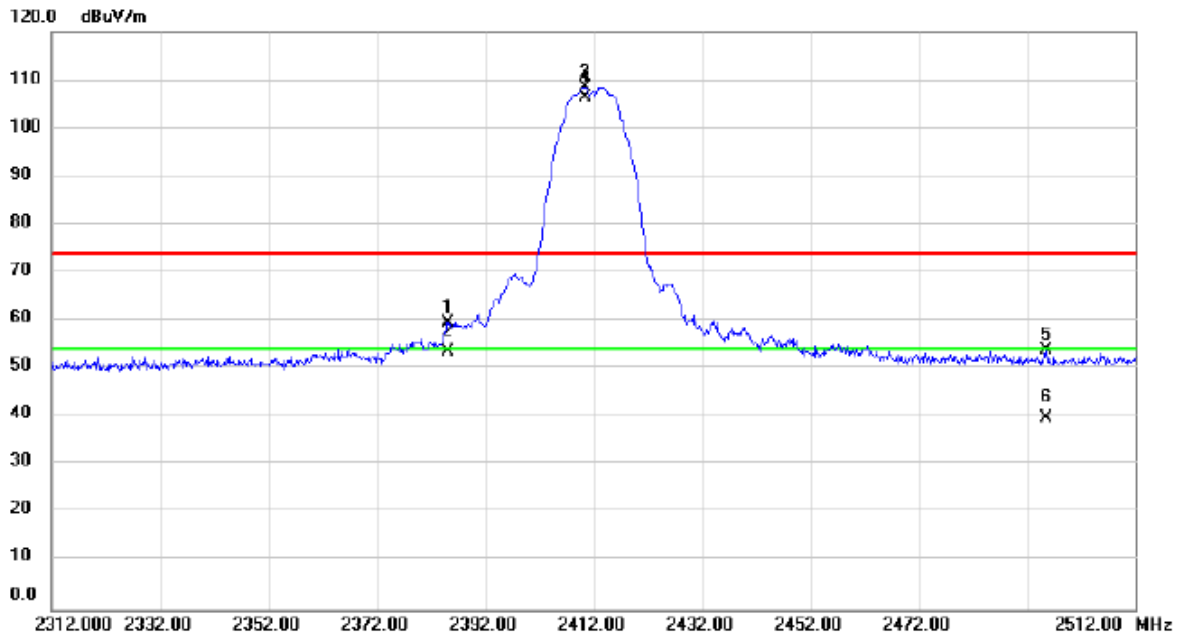

No.	Mk.	Freq. MHz	Reading Level dBuV	Correct Factor dB	Measure- ment dBuV/m	Limit dBuV/m	Margin dB	Detector	Antenna Height cm	Table Degree degree	Comment
1		2385.200	56.58	3.05	59.63	74.00	-14.37	peak			
2		2385.200	50.45	3.05	53.50	54.00	-0.50	AVG			
3	X	2410.600	105.47	3.09	108.56	74.00	34.56	peak			No Limit
4	*	2410.600	103.14	3.09	106.23	54.00	52.23	AVG			No Limit
5		2495.600	50.55	3.23	53.78	74.00	-20.22	peak			
6		2495.600	36.56	3.23	39.79	54.00	-14.21	AVG			

**REMARKS:**

- (1) Measurement Value = Reading Level + Correct Factor.
- (2) Margin Level = Measurement Value - Limit Value.

Test Mode	IEEE 802.11b	Test Date	2024/2/4
Test Frequency	2417MHz	Polarization	Vertical

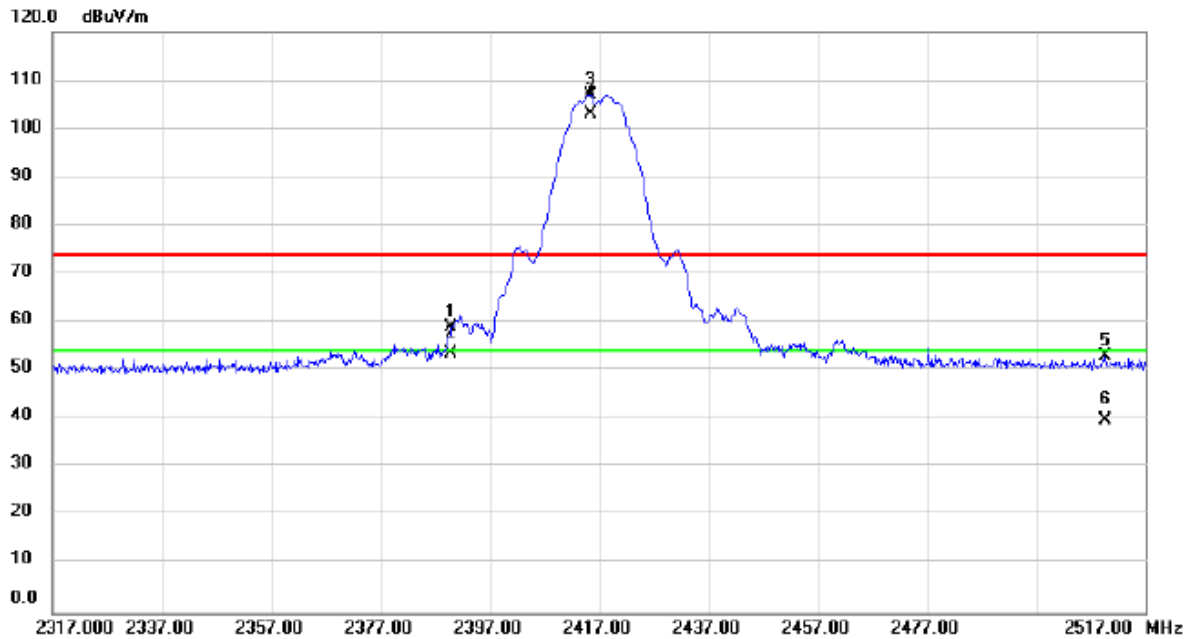

No.	Mk.	Freq. MHz	Reading Level dBuV	Correct Factor dB	Measure- ment dBuV/m	Limit dBuV/m	Margin dB	Detector	Antenna Height cm	Table Degree	Comment
1		2390.000	55.87	3.04	58.91	74.00	-15.09	peak			
2		2390.000	50.43	3.04	53.47	54.00	-0.53	AVG			
3	X	2415.600	103.91	3.09	107.00	74.00	33.00	peak			No Limit
4	*	2415.600	99.92	3.09	103.01	54.00	49.01	AVG			No Limit
5		2509.600	49.72	3.28	53.00	74.00	-21.00	peak			
6		2509.600	36.62	3.28	39.90	54.00	-14.10	AVG			

**REMARKS:**

- (1) Measurement Value = Reading Level + Correct Factor.
- (2) Margin Level = Measurement Value - Limit Value.

Test Mode	IEEE 802.11b	Test Date	2024/2/4
Test Frequency	2457MHz	Polarization	Vertical

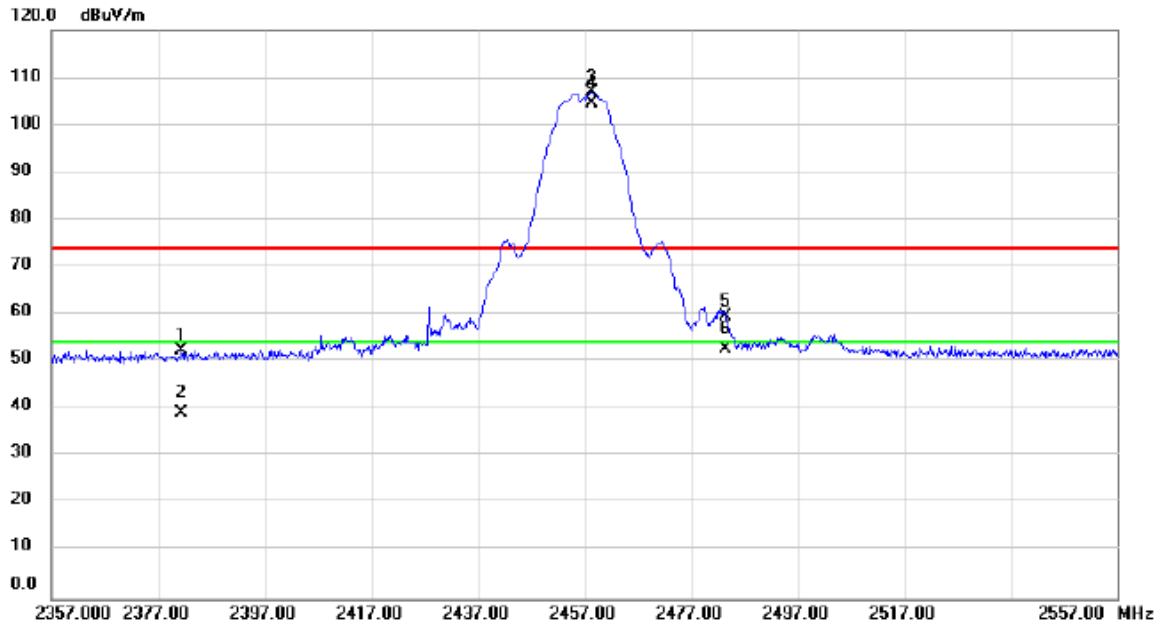

No.	Mk.	Freq. MHz	Reading Level dBuV	Correct Factor dB	Measure- ment dBuV/m	Limit dBuV/m	Margin dB	Detector	Antenna Height cm	Table Degree degree	Comment
1		2381.400	49.30	3.04	52.34	74.00	-21.66	peak			
2		2381.400	36.14	3.04	39.18	54.00	-14.82	AVG			
3	X	2458.400	103.75	3.16	106.91	74.00	32.91	peak			No Limit
4	*	2458.400	101.28	3.16	104.44	54.00	50.44	AVG			No Limit
5		2483.500	56.23	3.20	59.43	74.00	-14.57	peak			
6		2483.500	49.41	3.20	52.61	54.00	-1.39	AVG			

**REMARKS:**

- (1) Measurement Value = Reading Level + Correct Factor.
- (2) Margin Level = Measurement Value - Limit Value.

Test Mode	IEEE 802.11b	Test Date	2024/2/4
Test Frequency	2462MHz	Polarization	Vertical

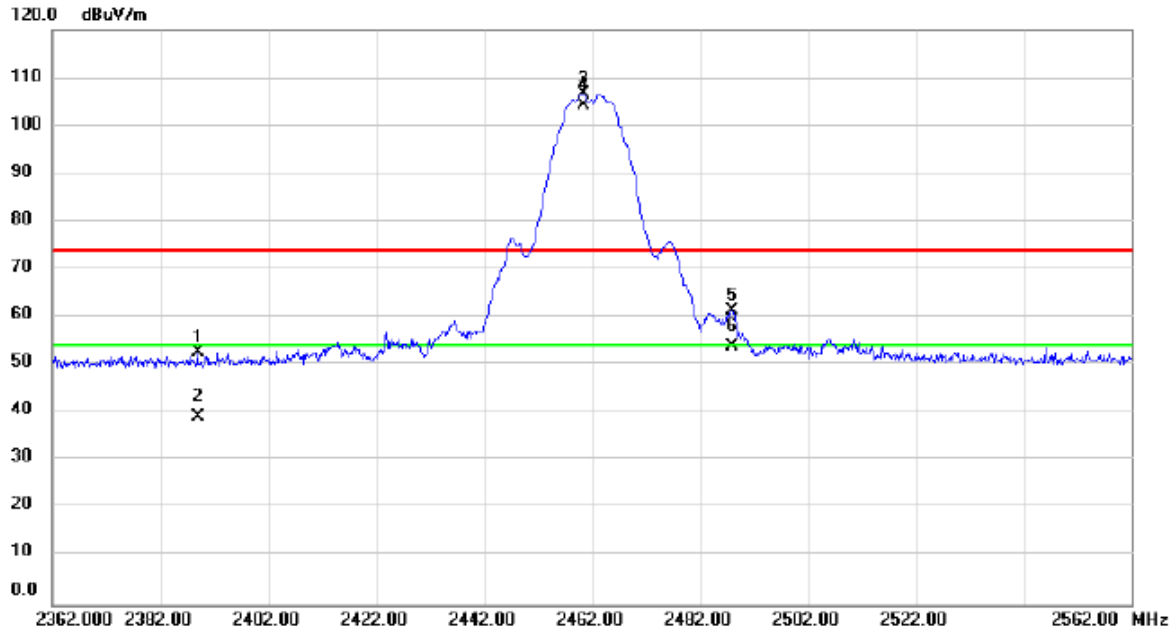

No.	Mk.	Freq. MHz	Reading Level dBuV	Correct Factor dB	Measure- ment dBuV/m	Limit dBuV/m	Margin dB	Detector	Antenna Height cm	Table Degree degree	Comment
1		2389.000	49.65	3.04	52.69	74.00	-21.31	peak			
2		2389.000	36.09	3.04	39.13	54.00	-14.87	AVG			
3	X	2460.400	103.48	3.17	106.65	74.00	32.65	peak			No Limit
4	*	2460.400	101.10	3.17	104.27	54.00	50.27	AVG			No Limit
5		2488.000	57.98	3.22	61.20	74.00	-12.80	peak			
6		2488.000	50.48	3.22	53.70	54.00	-0.30	AVG			

**REMARKS:**

- (1) Measurement Value = Reading Level + Correct Factor.
- (2) Margin Level = Measurement Value - Limit Value.

Test Mode	IEEE 802.11g	Test Date	2024/2/4
Test Frequency	2412MHz	Polarization	Vertical

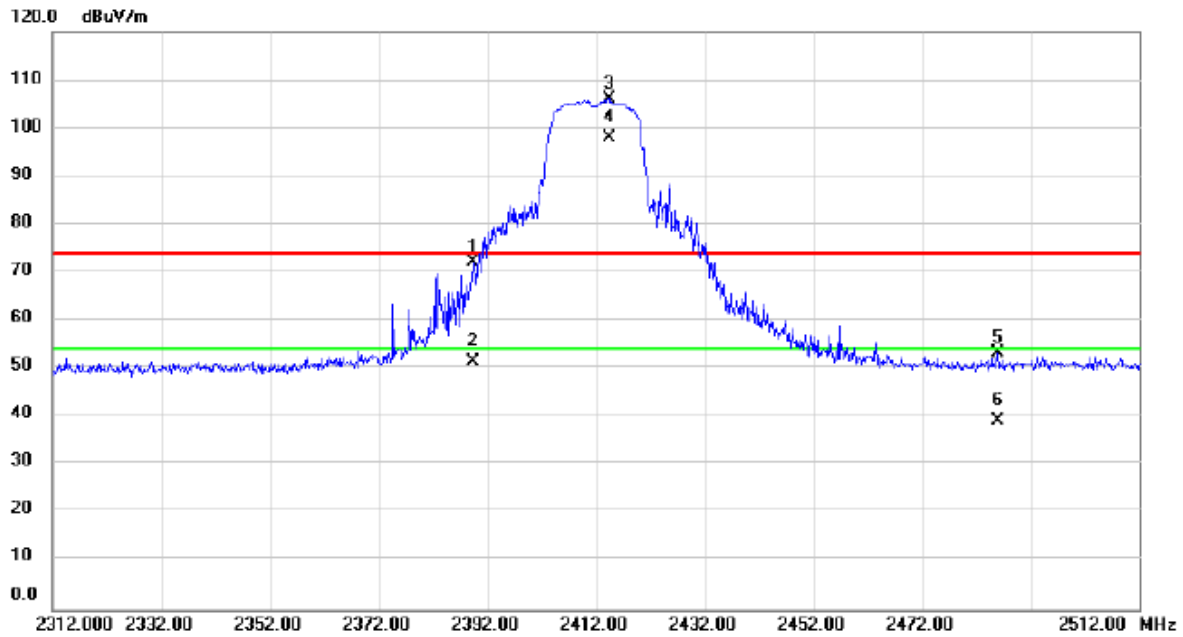

No.	Mk.	Freq. MHz	Reading Level dBuV	Correct Factor dB	Measure- ment dBuV/m	Limit dBuV/m	Margin dB	Antenna Height cm	Table Degree degree	Detector	Comment
1		2389.400	69.06	3.04	72.10	74.00	-1.90			peak	
2		2389.400	48.28	3.04	51.32	54.00	-2.68			AVG	
3	X	2414.400	103.04	3.09	106.13	74.00	32.13			peak	No Limit
4	*	2414.400	94.93	3.09	98.02	54.00	44.02			AVG	No Limit
5		2486.000	50.11	3.22	53.33	74.00	-20.67			peak	
6		2486.000	35.92	3.22	39.14	54.00	-14.86			AVG	

**REMARKS:**

- (1) Measurement Value = Reading Level + Correct Factor.
- (2) Margin Level = Measurement Value - Limit Value.

Test Mode	IEEE 802.11g	Test Date	2024/2/4
Test Frequency	2417MHz	Polarization	Vertical

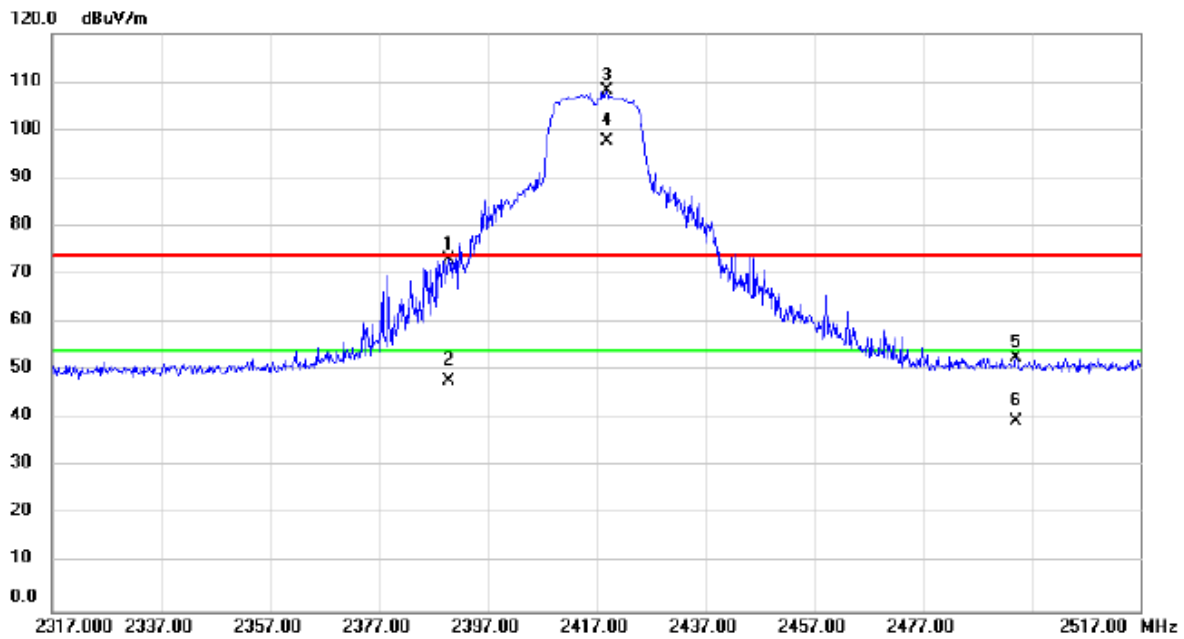

No.	Mk.	Freq. MHz	Reading Level dBuV	Correct Factor dB	Measure- ment dBuV/m	Limit dBuV/m	Margin dB	Detector	Antenna Height cm	Table Degree	Comment
1		2390.000	69.88	3.04	72.92	74.00	-1.08	peak			
2		2390.000	44.67	3.04	47.71	54.00	-6.29	AVG			
3	X	2419.000	105.00	3.10	108.10	74.00	34.10	peak			No Limit
4	*	2419.000	94.45	3.10	97.55	54.00	43.55	AVG			No Limit
5		2494.200	49.55	3.22	52.77	74.00	-21.23	peak			
6		2494.200	36.16	3.22	39.38	54.00	-14.62	AVG			

**REMARKS:**

- (1) Measurement Value = Reading Level + Correct Factor.
- (2) Margin Level = Measurement Value - Limit Value.

Test Mode	IEEE 802.11g	Test Date	2024/2/4
Test Frequency	2457MHz	Polarization	Vertical

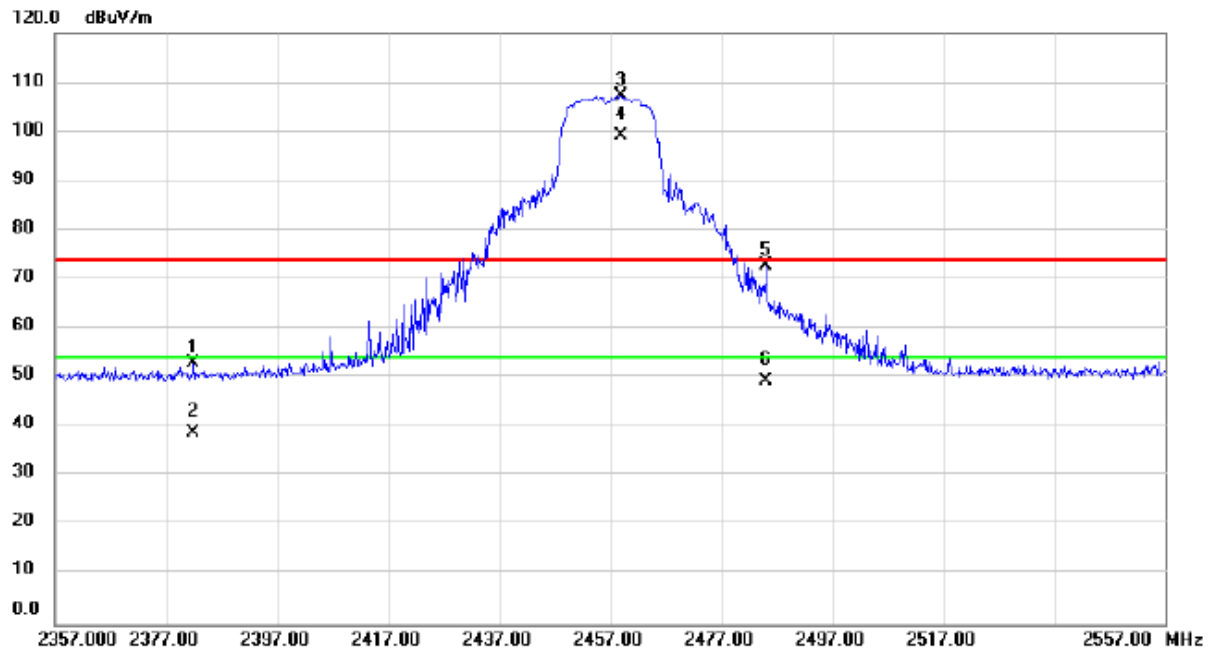

No.	Mk.	Freq.	Reading Level	Correct Factor	Measurement	Limit	Margin	Antenna Height	Table Degree	
		MHz	dBuV	dB	dBuV/m	dBuV/m	dB	cm	degree	Comment
1		2382.000	49.84	3.04	52.88	74.00	-21.12			peak
2		2382.000	35.87	3.04	38.91	54.00	-15.09			AVG
3	X	2459.000	104.15	3.16	107.31	74.00	33.31			peak
4	*	2459.000	96.04	3.16	99.20	54.00	45.20			AVG
5		2485.200	69.43	3.22	72.65	74.00	-1.35			peak
6		2485.200	46.09	3.22	49.31	54.00	-4.69			AVG

**REMARKS:**

- (1) Measurement Value = Reading Level + Correct Factor.
- (2) Margin Level = Measurement Value - Limit Value.

Test Mode	IEEE 802.11g	Test Date	2024/2/4
Test Frequency	2462MHz	Polarization	Vertical

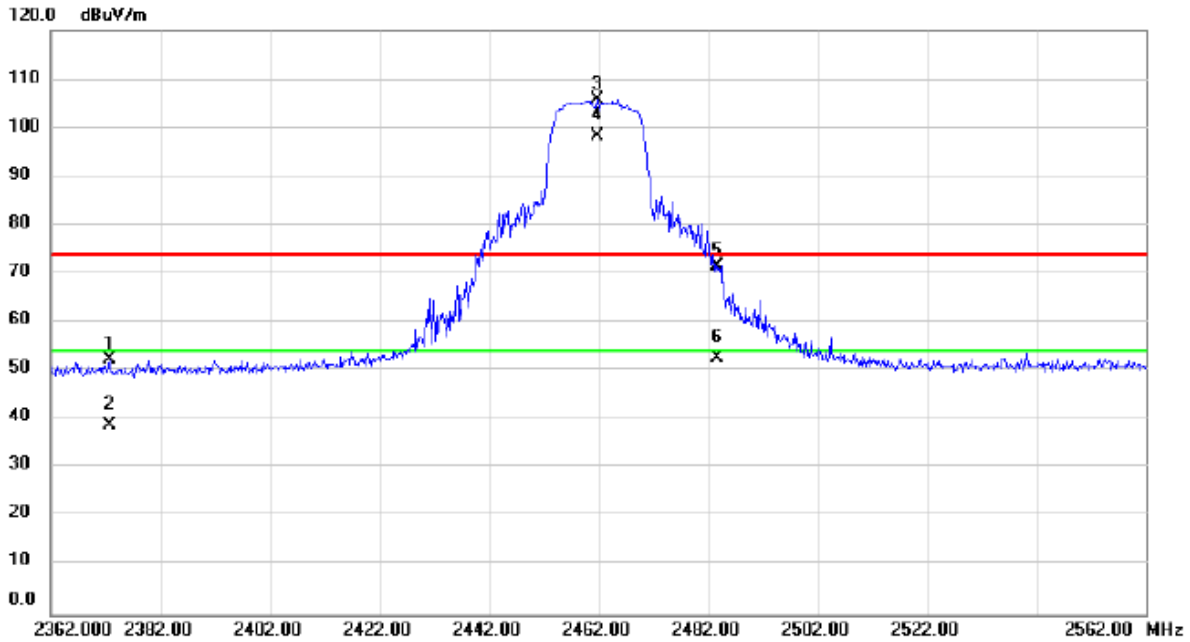

No.	Mk.	Freq. MHz	Reading Level dBuV	Correct Factor dB	Measure- ment dBuV/m	Limit dBuV/m	Margin dB	Antenna Height cm	Table Degree	Comment
1		2372.800	49.46	3.03	52.49	74.00	-21.51			peak
2		2372.800	35.74	3.03	38.77	54.00	-15.23			AVG
3	X	2461.800	102.66	3.17	105.83	74.00	31.83			peak No Limit
4	*	2461.800	94.95	3.17	98.12	54.00	44.12			AVG No Limit
5		2483.800	68.42	3.20	71.62	74.00	-2.38			peak
6		2483.800	49.50	3.20	52.70	54.00	-1.30			AVG

**REMARKS:**

- (1) Measurement Value = Reading Level + Correct Factor.
- (2) Margin Level = Measurement Value - Limit Value.



Test Mode	IEEE 802.11n(HT20)	Test Date	2024/2/4
Test Frequency	2412MHz	Polarization	Vertical

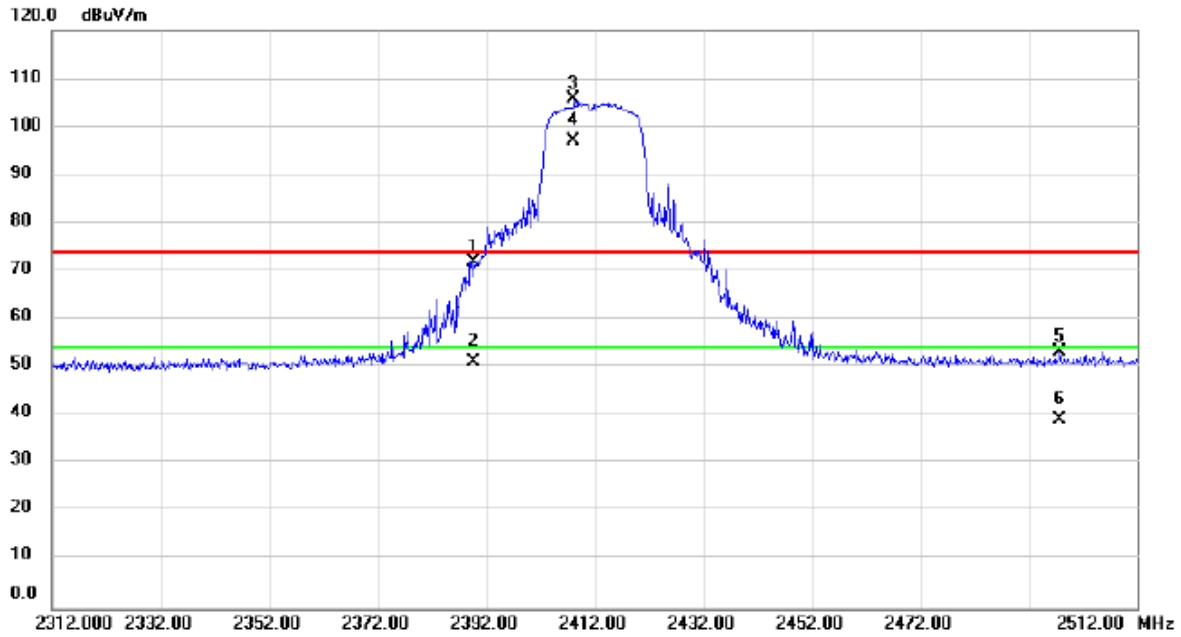

No.	Mk.	Freq. MHz	Reading Level dBuV	Correct Factor dB	Measure- ment dBuV/m	Limit dBuV/m	Margin dB	Detector	Antenna Height cm	Table Degree degree	Comment
1		2389.800	68.91	3.04	71.95	74.00	-2.05	peak			
2		2389.800	47.98	3.04	51.02	54.00	-2.98	AVG			
3	X	2408.200	102.81	3.08	105.89	74.00	31.89	peak			No Limit
4	*	2408.200	93.93	3.08	97.01	54.00	43.01	AVG			No Limit
5		2497.800	50.06	3.24	53.30	74.00	-20.70	peak			
6		2497.800	35.93	3.24	39.17	54.00	-14.83	AVG			

**REMARKS:**

- (1) Measurement Value = Reading Level + Correct Factor.
- (2) Margin Level = Measurement Value - Limit Value.

Test Mode	IEEE 802.11n(HT20)	Test Date	2024/2/4
Test Frequency	2417MHz	Polarization	Vertical

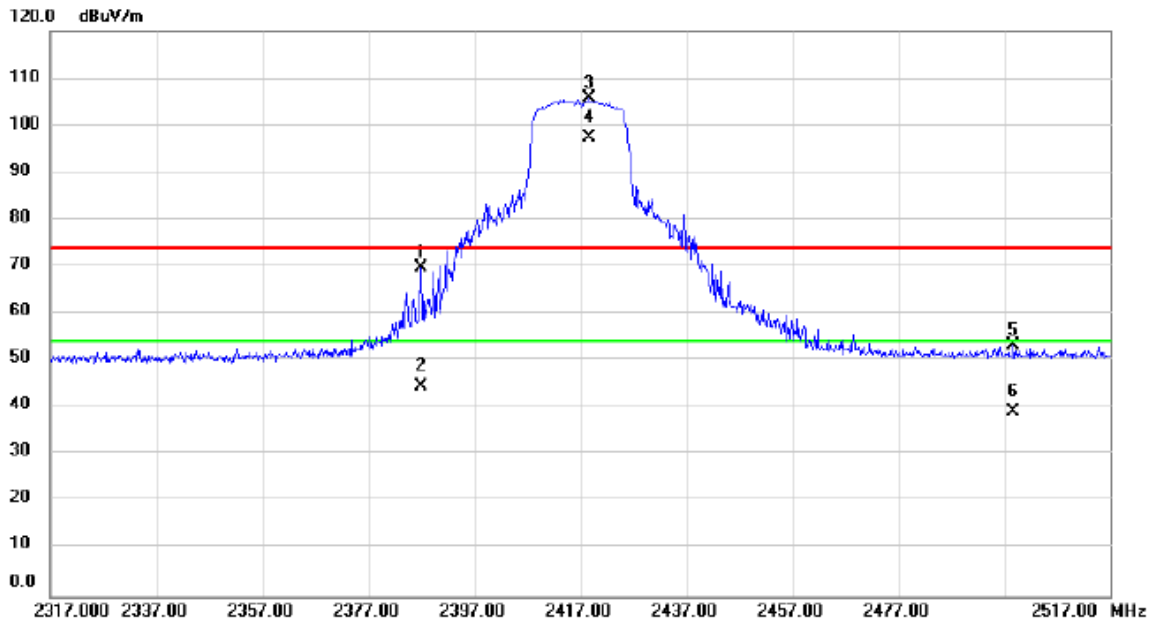

No.	Mk.	Freq. MHz	Reading Level dBuV	Correct Factor dB	Measure- ment dBuV/m	Limit dBuV/m	Margin dB	Detector	Antenna Height cm	Table Degree	Comment
1		2387.000	66.80	3.04	69.84	74.00	-4.16	peak			
2		2387.000	41.40	3.04	44.44	54.00	-9.56	AVG			
3	X	2418.800	102.60	3.10	105.70	74.00	31.70	peak			No Limit
4	*	2418.800	94.37	3.10	97.47	54.00	43.47	AVG			No Limit
5		2498.800	49.88	3.24	53.12	74.00	-20.88	peak			
6		2498.800	35.97	3.24	39.21	54.00	-14.79	AVG			

**REMARKS:**

- (1) Measurement Value = Reading Level + Correct Factor.
- (2) Margin Level = Measurement Value - Limit Value.

Test Mode	IEEE 802.11n(HT20)	Test Date	2024/2/4
Test Frequency	2457MHz	Polarization	Vertical

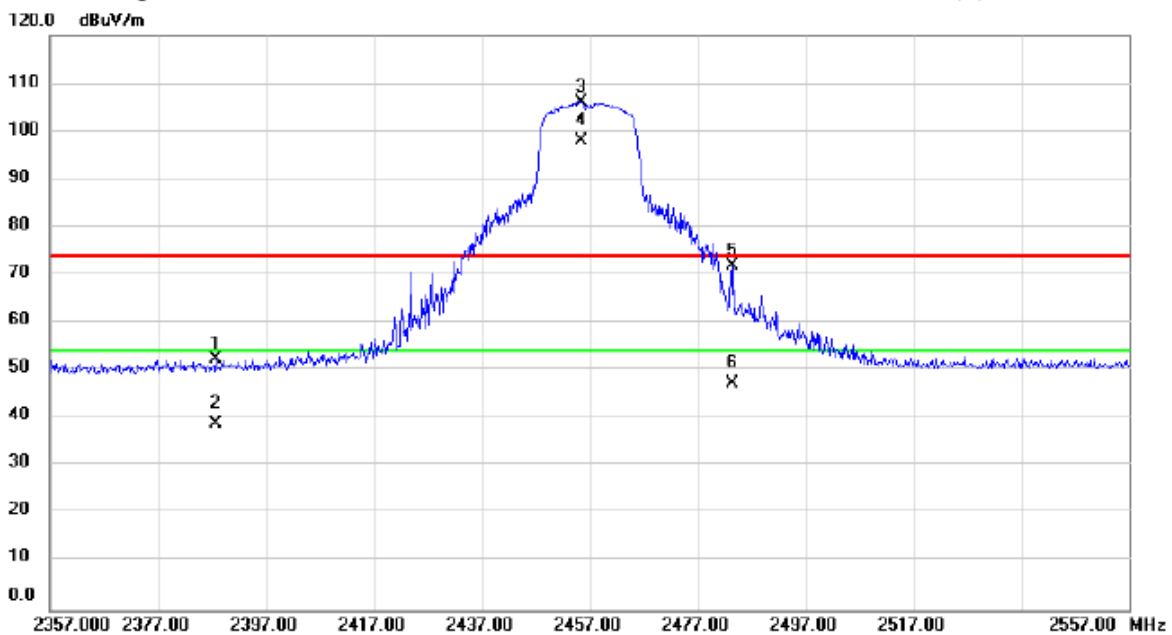

No.	Mk.	Freq. MHz	Reading Level dBuV	Correct Factor dB	Measure- ment dBuV/m	Limit dBuV/m	Margin dB	Detector	Antenna Height cm	Table Degree degree	Comment
1		2387.800	49.46	3.04	52.50	74.00	-21.50	peak			
2		2387.800	35.74	3.04	38.78	54.00	-15.22	AVG			
3	X	2455.400	102.92	3.17	106.09	74.00	32.09	peak			No Limit
4	*	2455.400	94.87	3.17	98.04	54.00	44.04	AVG			No Limit
5		2483.600	68.60	3.20	71.80	74.00	-2.20	peak			
6		2483.600	43.95	3.20	47.15	54.00	-6.85	AVG			

**REMARKS:**

- (1) Measurement Value = Reading Level + Correct Factor.
- (2) Margin Level = Measurement Value - Limit Value.

Test Mode	IEEE 802.11n(HT20)	Test Date	2024/2/4
Test Frequency	2462MHz	Polarization	Vertical

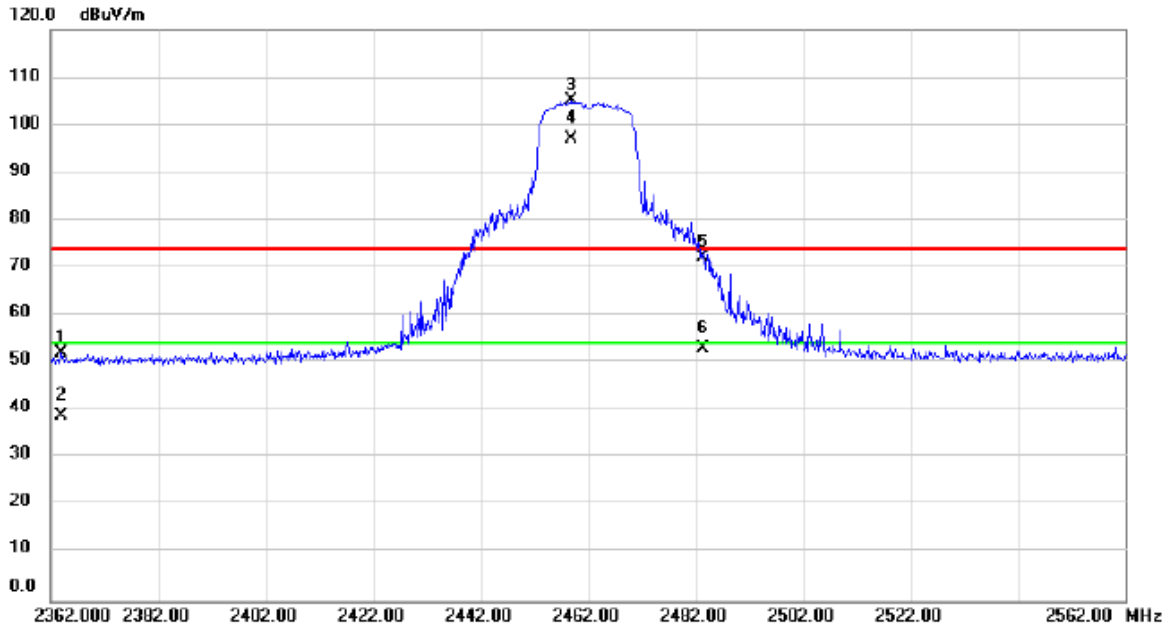

No.	Mk.	Freq. MHz	Reading Level dBuV	Correct Factor dB	Measure- ment dBuV/m	Limit dBuV/m	Margin dB	Antenna Height cm	Table Degree	Comment
1		2364.000	48.92	3.00	51.92	74.00	-22.08			peak
2		2364.000	35.73	3.00	38.73	54.00	-15.27			AVG
3	X	2459.000	101.89	3.16	105.05	74.00	31.05			peak
4	*	2459.000	93.75	3.16	96.91	54.00	42.91			AVG
5		2483.500	68.86	3.20	72.06	74.00	-1.94			peak
6		2483.500	49.62	3.20	52.82	54.00	-1.18			AVG

**REMARKS:**

- (1) Measurement Value = Reading Level + Correct Factor.
- (2) Margin Level = Measurement Value - Limit Value.

Test Mode	IEEE 802.11b	Test Date	2024/2/5
Test Frequency	2412MHz	Polarization	Vertical

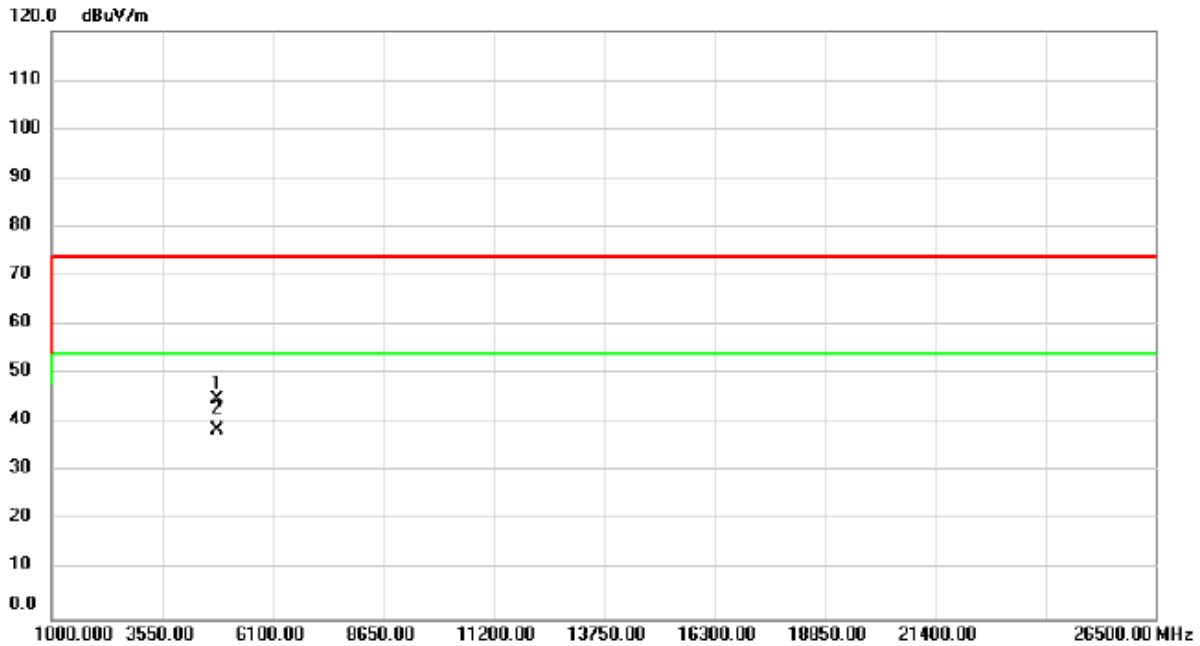

No.	Mk.	Freq. MHz	Reading Level dBuV	Correct Factor dB	Measure- ment dBuV/m	Limit dBuV/m	Margin dB	Detector	Antenna Height cm	Table Degree degree	Comment
1		4825.000	45.36	-0.63	44.73	74.00	-29.27	peak			
2	*	4825.000	39.29	-0.63	38.66	54.00	-15.34	AVG			

REMARKS:

- (1) Measurement Value = Reading Level + Correct Factor.
- (2) Margin Level = Measurement Value - Limit Value.

Test Mode	IEEE 802.11b	Test Date	2024/2/5
Test Frequency	2412MHz	Polarization	Horizontal

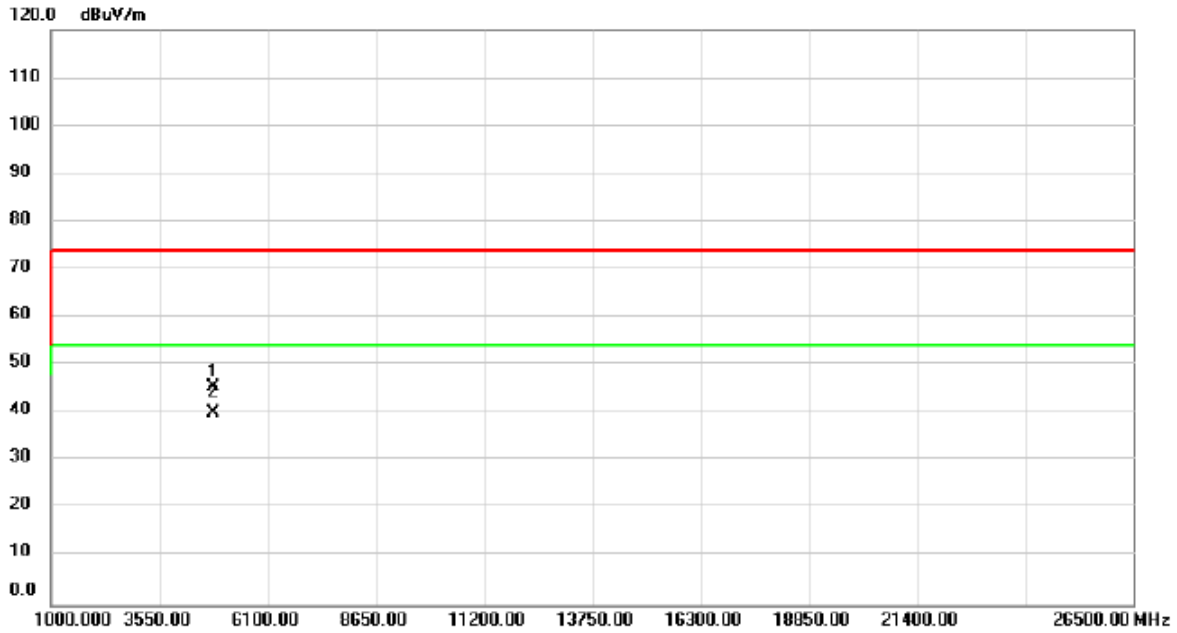

No.	Mk.	Freq.	Reading Level	Correct Factor	Measurement	Limit	Margin	Antenna Height	Table Degree	
		MHz	dBuV	dB	dBuV/m	dBuV/m	dB	cm	degree	Comment
1		4825.000	46.01	-0.63	45.38	74.00	-28.62			peak
2	*	4825.000	40.80	-0.63	40.17	54.00	-13.83			AVG

REMARKS:

- (1) Measurement Value = Reading Level + Correct Factor.
- (2) Margin Level = Measurement Value - Limit Value.

Test Mode	IEEE 802.11b	Test Date	2024/2/5
Test Frequency	2417MHz	Polarization	Vertical

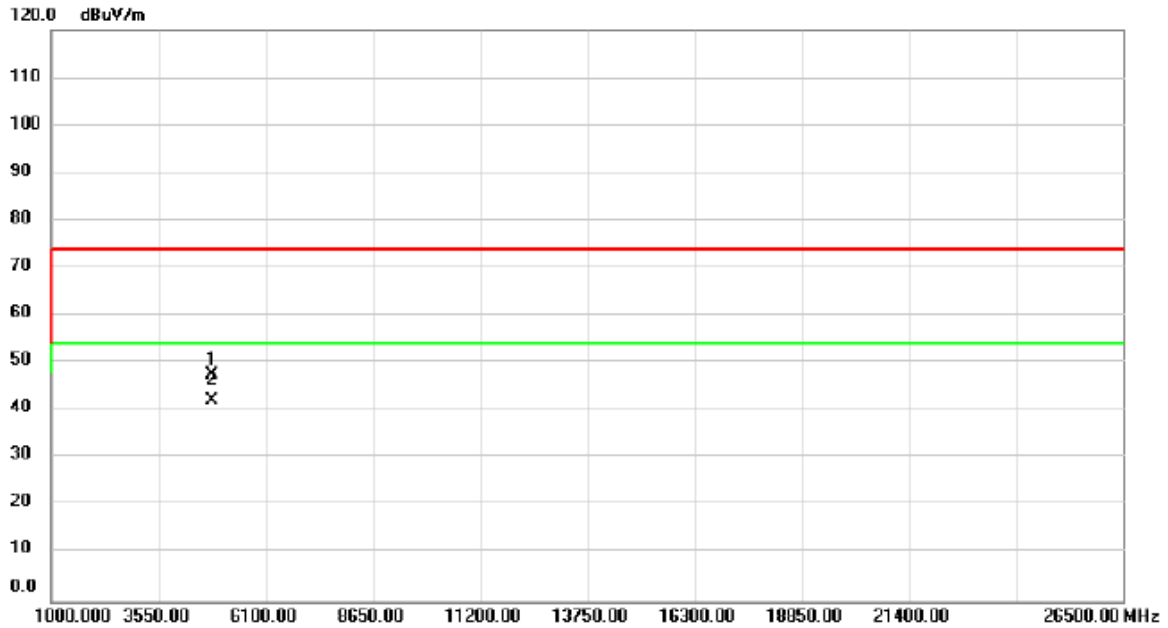

No.	Mk.	Freq.	Reading Level	Correct Factor	Measurement	Limit	Margin	Antenna Height	Table Degree	Detector	Comment
		MHz	dBuV	dB	dBuV/m	dBuV/m	dB	cm	degree		
1		4825.000	48.28	-0.63	47.65	74.00	-26.35			peak	
2	*	4825.000	42.71	-0.63	42.08	54.00	-11.92			AVG	

REMARKS:

- (1) Measurement Value = Reading Level + Correct Factor.
- (2) Margin Level = Measurement Value - Limit Value.

Test Mode	IEEE 802.11b	Test Date	2024/2/5
Test Frequency	2417MHz	Polarization	Horizontal

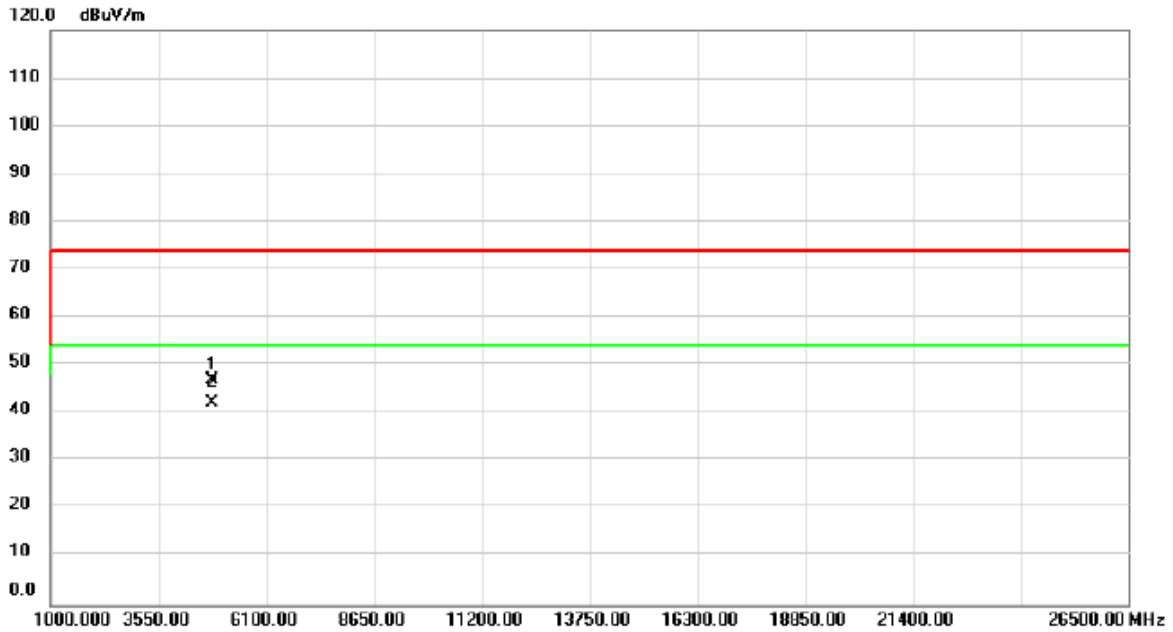

No.	Mk.	Freq. MHz	Reading Level dBuV	Correct Factor dB	Measure- ment dBuV/m	Limit dBuV/m	Margin dB	Detector	Antenna Height cm	Table Degree	Comment
1		4825.000	47.60	-0.63	46.97	74.00	-27.03	peak			
2	*	4825.000	42.80	-0.63	42.17	54.00	-11.83	AVG			

**REMARKS:**

- (1) Measurement Value = Reading Level + Correct Factor.
- (2) Margin Level = Measurement Value - Limit Value.



Test Mode	IEEE 802.11b	Test Date	2024/2/5
Test Frequency	2437MHz	Polarization	Vertical

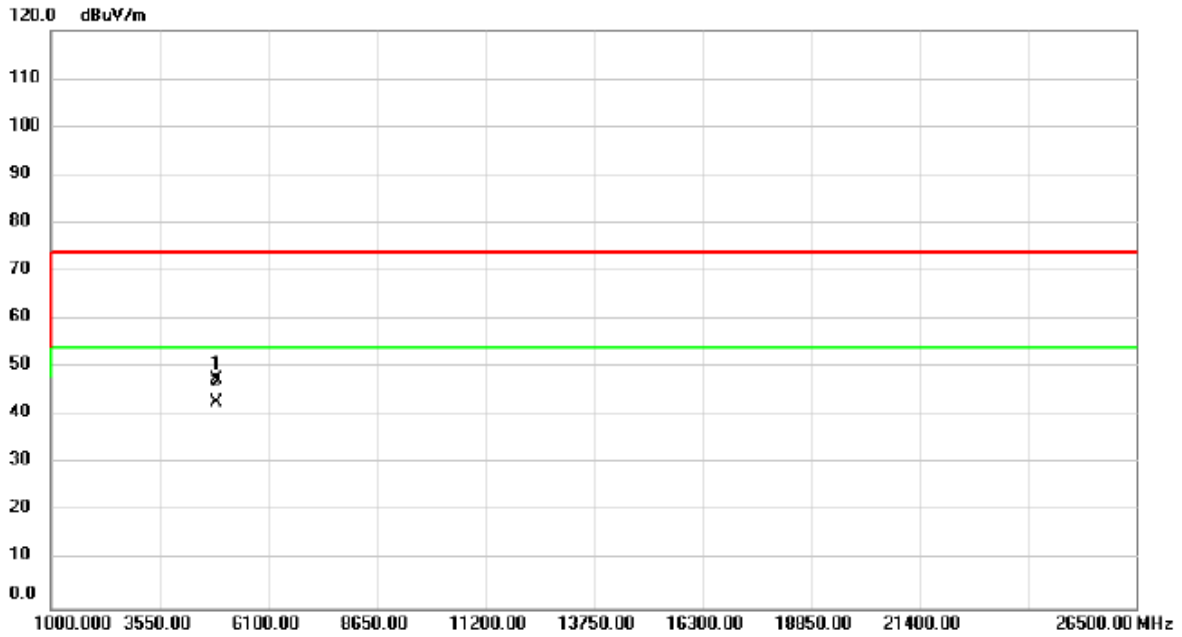

No.	Mk.	Freq.	Reading Level	Correct Factor	Measurement	Limit	Margin	Antenna Height	Table Degree	
		MHz	dBuV	dB	dBuV/m	dBuV/m	dB	cm	degree	Comment
1		4876.000	47.90	-0.48	47.42	74.00	-26.58			peak
2	*	4876.000	43.26	-0.48	42.78	54.00	-11.22			AVG

REMARKS:

- (1) Measurement Value = Reading Level + Correct Factor.
- (2) Margin Level = Measurement Value - Limit Value.

Test Mode	IEEE 802.11b	Test Date	2024/2/5
Test Frequency	2437MHz	Polarization	Horizontal

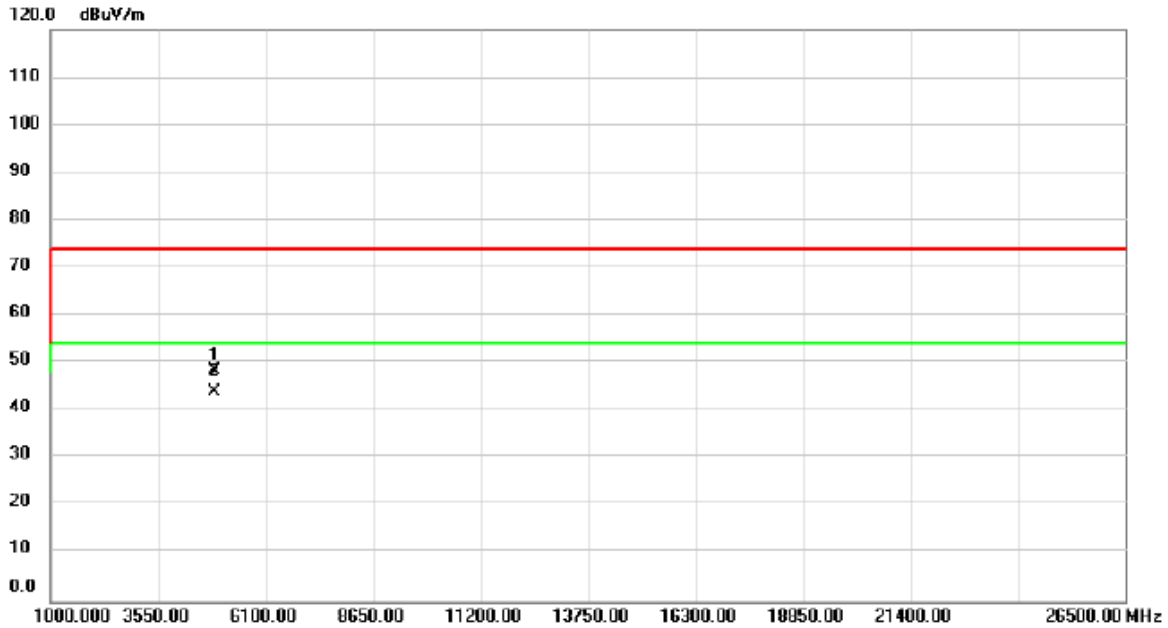

No.	Mk.	Freq. MHz	Reading Level dBuV	Correct Factor dB	Measure- ment dBuV/m	Limit dBuV/m	Margin dB	Detector	Antenna Height cm	Table Degree	Comment
1		4876.000	48.87	-0.48	48.39	74.00	-25.61	peak			
2	*	4876.000	44.46	-0.48	43.98	54.00	-10.02	AVG			

**REMARKS:**

- (1) Measurement Value = Reading Level + Correct Factor.
- (2) Margin Level = Measurement Value - Limit Value.

Test Mode	IEEE 802.11b	Test Date	2024/2/5
Test Frequency	2457MHz	Polarization	Vertical

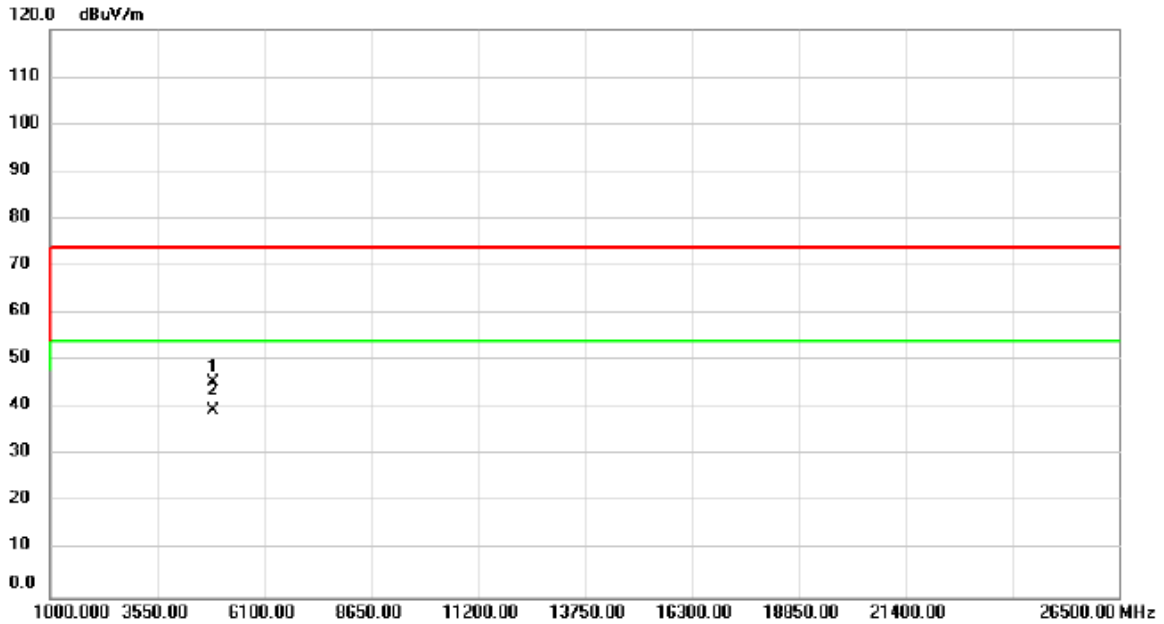

No.	Mk.	Freq.	Reading Level	Correct Factor	Measurement	Limit	Margin	Antenna Height	Table Degree	Comment
		MHz	dBuV	dB	dBuV/m	dBuV/m	dB	cm	degree	
1		4901.500	46.01	-0.41	45.60	74.00	-28.40			peak
2	*	4901.500	39.83	-0.41	39.42	54.00	-14.58			AVG

**REMARKS:**

- (1) Measurement Value = Reading Level + Correct Factor.
- (2) Margin Level = Measurement Value - Limit Value.

Test Mode	IEEE 802.11b	Test Date	2024/2/5
Test Frequency	2457MHz	Polarization	Horizontal

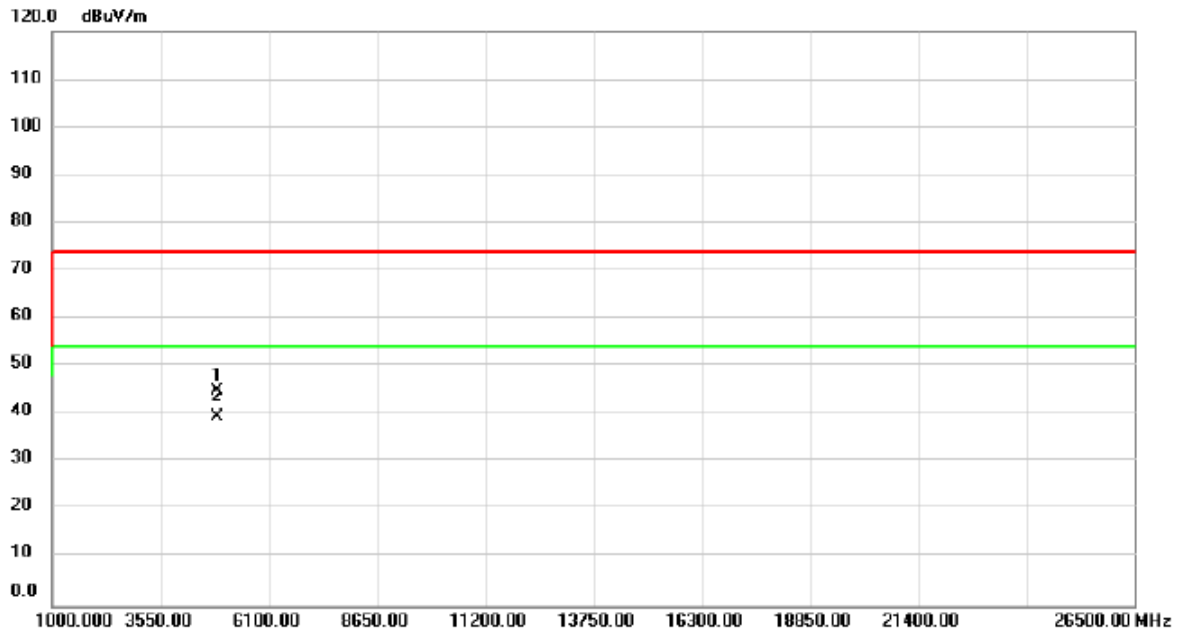

No.	Mk.	Freq. MHz	Reading Level dBuV	Correct Factor dB	Measure- ment dBuV/m	Limit dBuV/m	Margin dB	Antenna Height cm	Table Degree degree	Comment
1		4901.500	45.27	-0.41	44.86	74.00	-29.14	peak		
2	*	4901.500	39.74	-0.41	39.33	54.00	-14.67	AVG		

REMARKS:

- (1) Measurement Value = Reading Level + Correct Factor.
- (2) Margin Level = Measurement Value - Limit Value.

Test Mode	IEEE 802.11b	Test Date	2024/2/5
Test Frequency	2462MHz	Polarization	Vertical

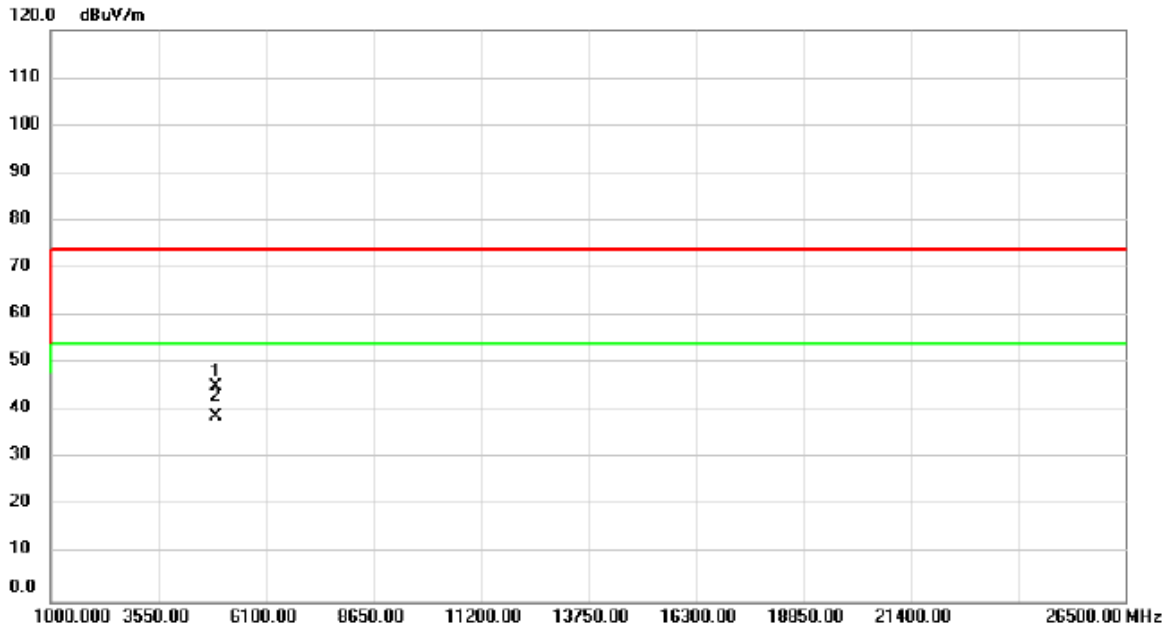

No.	Mk.	Freq. MHz	Reading Level dBuV	Correct Factor dB	Measure- ment dBuV/m	Limit dBuV/m	Margin dB	Detector	Antenna Height cm	Table Degree	Comment
1		4927.000	45.62	-0.34	45.28	74.00	-28.72	peak			
2	*	4927.000	39.12	-0.34	38.78	54.00	-15.22	AVG			

**REMARKS:**

- (1) Measurement Value = Reading Level + Correct Factor.
- (2) Margin Level = Measurement Value - Limit Value.

Test Mode	IEEE 802.11b	Test Date	2024/2/5
Test Frequency	2462MHz	Polarization	Horizontal

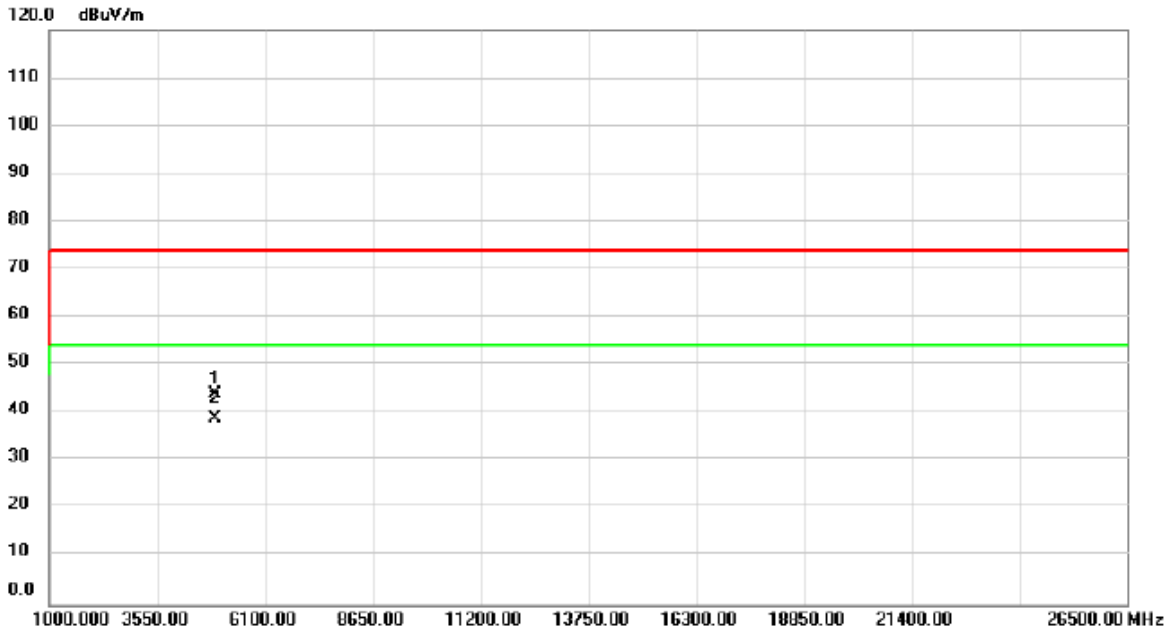

No.	Mk.	Freq.	Reading Level	Correct Factor	Measurement	Limit	Margin	Antenna Height	Table Degree	Comment
		MHz	dBuV	dB	dBuV/m	dBuV/m	dB	cm	degree	
1		4927.000	44.36	-0.34	44.02	74.00	-29.98	peak		
2	*	4927.000	39.27	-0.34	38.93	54.00	-15.07	AVG		

REMARKS:

- (1) Measurement Value = Reading Level + Correct Factor.
- (2) Margin Level = Measurement Value - Limit Value.

Test Mode	IEEE 802.11g	Test Date	2024/2/5
Test Frequency	2412MHz	Polarization	Vertical

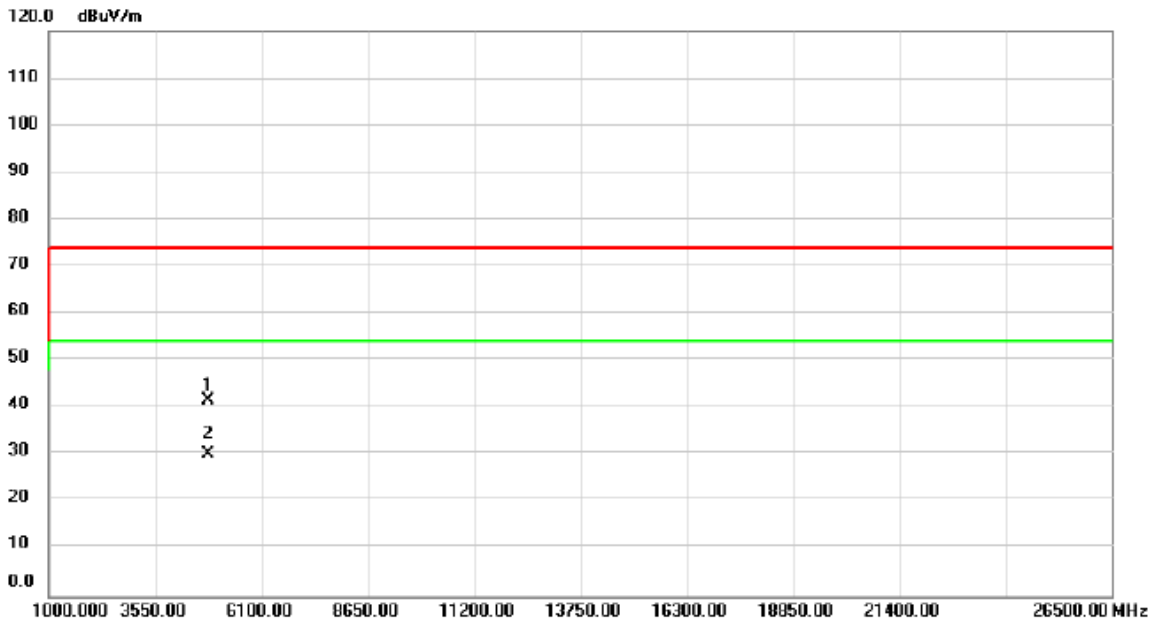

No.	Mk.	Freq. MHz	Reading Level dBuV	Correct Factor dB	Measure- ment dBuV/m	Limit dBuV/m	Margin dB	Detector	Antenna Height cm	Table Degree	Comment
1		4824.000	42.29	-0.64	41.65	74.00	-32.35	peak			
2	*	4824.000	30.87	-0.64	30.23	54.00	-23.77	AVG			

**REMARKS:**

- (1) Measurement Value = Reading Level + Correct Factor.
- (2) Margin Level = Measurement Value - Limit Value.

Test Mode	IEEE 802.11g	Test Date	2024/2/5
Test Frequency	2412MHz	Polarization	Horizontal

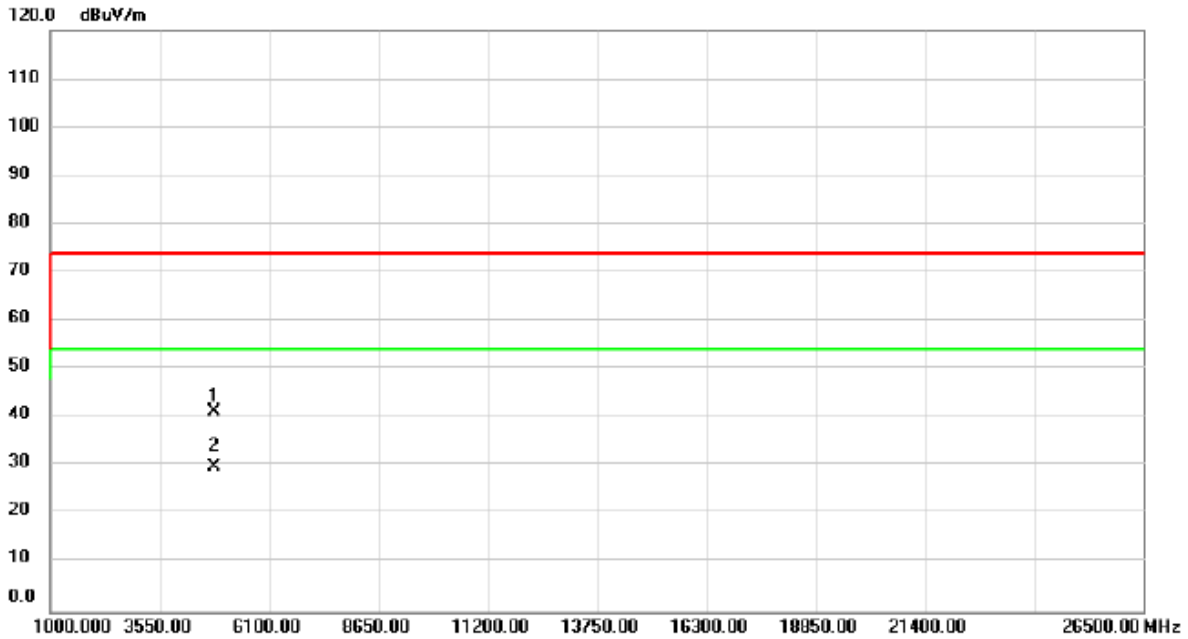

No.	Mk.	Freq. MHz	Reading Level dBuV	Correct Factor dB	Measure- ment dBuV/m	Limit dBuV/m	Margin dB	Detector	Antenna Height cm	Table Degree	Comment
1		4824.000	41.87	-0.64	41.23	74.00	-32.77	peak			
2	*	4824.000	30.43	-0.64	29.79	54.00	-24.21	AVG			

REMARKS:

- (1) Measurement Value = Reading Level + Correct Factor.
- (2) Margin Level = Measurement Value - Limit Value.



Test Mode	IEEE 802.11g	Test Date	2024/2/5
Test Frequency	2417MHz	Polarization	Vertical

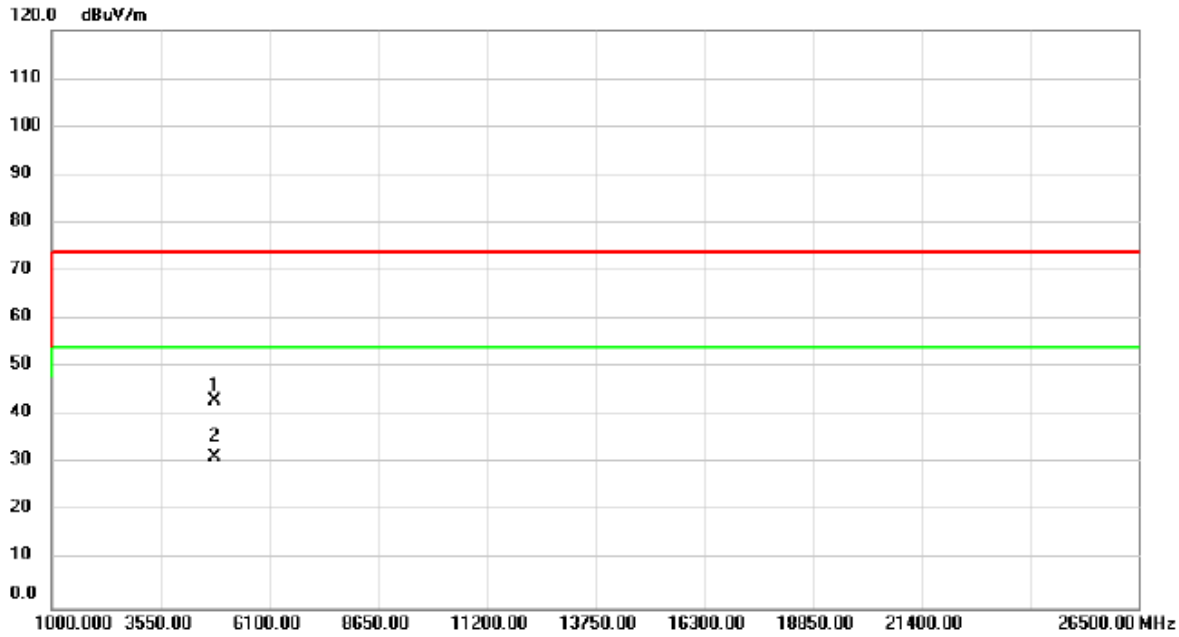

No.	Mk.	Freq. MHz	Reading Level dBuV	Correct Factor dB	Measure- ment dBuV/m	Limit dBuV/m	Margin dB	Detector	Antenna Height cm	Table Degree	Comment
1		4825.000	43.73	-0.63	43.10	74.00	-30.90	peak			
2	*	4825.000	31.88	-0.63	31.25	54.00	-22.75	AVG			

REMARKS:

- (1) Measurement Value = Reading Level + Correct Factor.
- (2) Margin Level = Measurement Value - Limit Value.

Test Mode	IEEE 802.11g	Test Date	2024/2/5
Test Frequency	2417MHz	Polarization	Horizontal

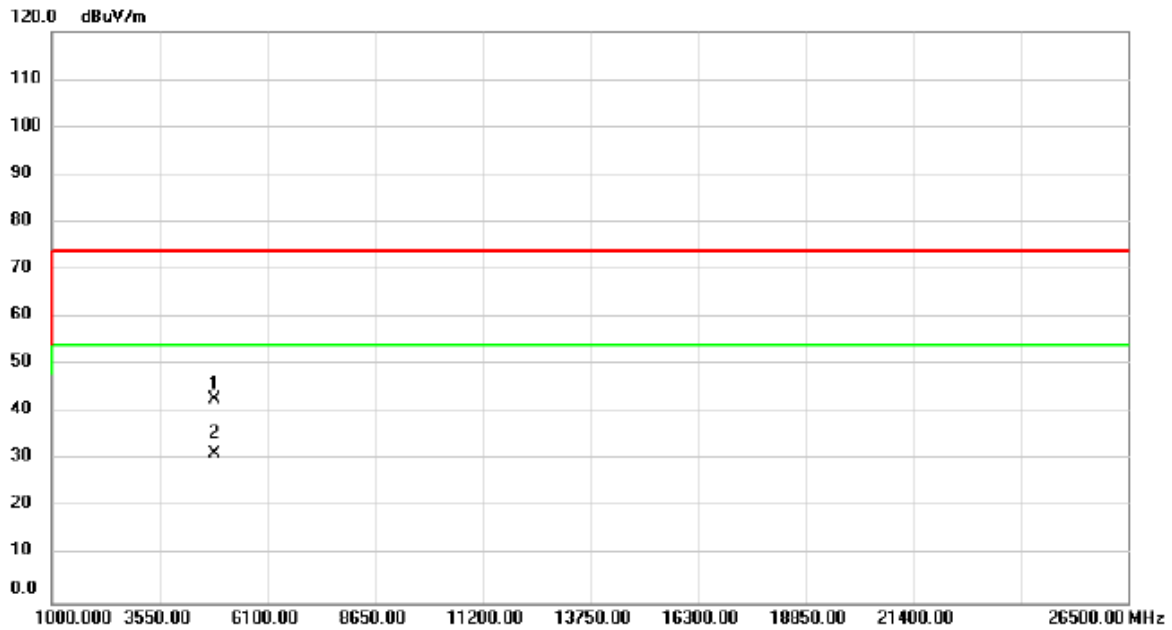

No.	Mk.	Freq. MHz	Reading Level dBuV	Correct Factor dB	Measure- ment dBuV/m	Limit dBuV/m	Margin dB	Detector	Antenna Height cm	Table Degree	Comment
1		4850.500	43.44	-0.56	42.88	74.00	-31.12	peak			
2	*	4850.500	31.80	-0.56	31.24	54.00	-22.76	AVG			

REMARKS:

- (1) Measurement Value = Reading Level + Correct Factor.
- (2) Margin Level = Measurement Value - Limit Value.

Test Mode	IEEE 802.11g	Test Date	2024/2/5
Test Frequency	2437MHz	Polarization	Vertical

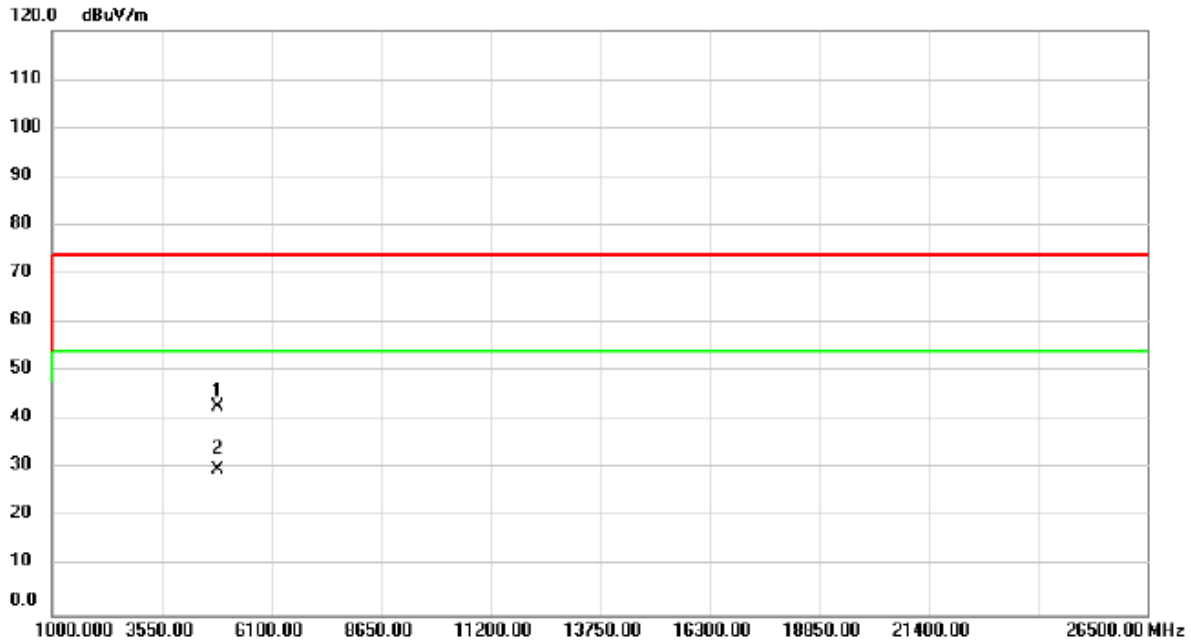

No.	Mk.	Freq.	Reading Level	Correct Factor	Measurement	Limit	Margin	Antenna Height	Table Degree	Comment
		MHz	dBuV	dB	dBuV/m	dBuV/m	dB	cm	degree	
1		4874.000	43.34	-0.49	42.85	74.00	-31.15			peak
2	*	4874.000	30.28	-0.49	29.79	54.00	-24.21			AVG

REMARKS:

- (1) Measurement Value = Reading Level + Correct Factor.
- (2) Margin Level = Measurement Value - Limit Value.

Test Mode	IEEE 802.11g	Test Date	2024/2/5
Test Frequency	2437MHz	Polarization	Horizontal

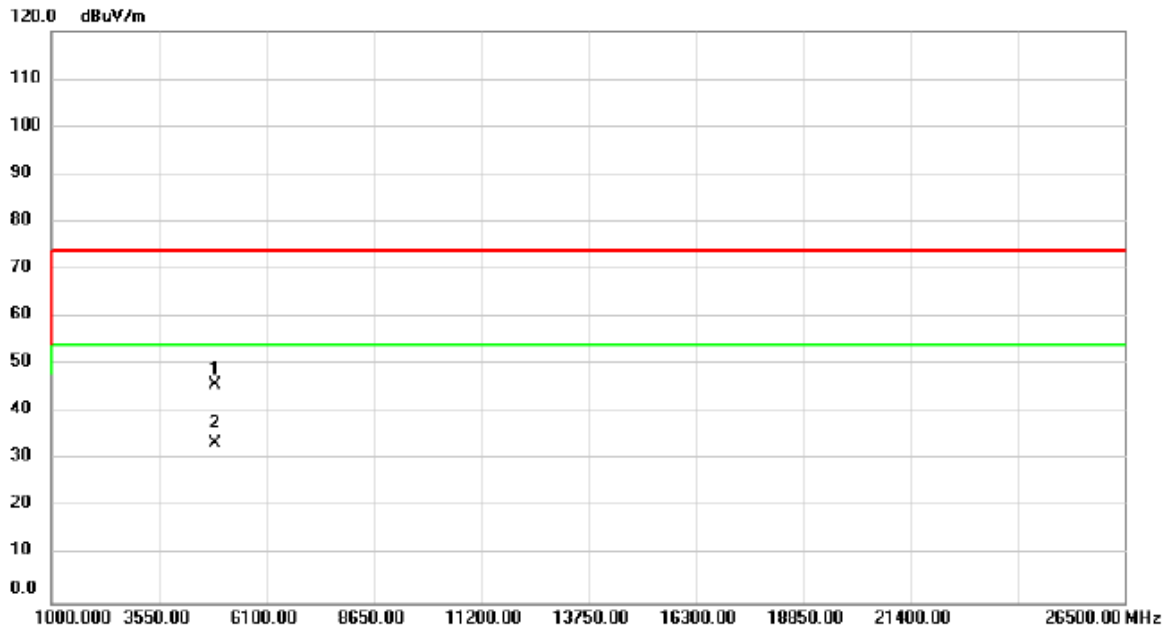

No.	Mk.	Freq.	Reading Level	Correct Factor	Measurement	Limit	Margin	Antenna Height	Table Degree	Comment
		MHz	dBuV	dB	dBuV/m	dBuV/m	dB	cm	degree	
1		4876.000	46.24	-0.48	45.76	74.00	-28.24	peak		
2	*	4876.000	33.83	-0.48	33.35	54.00	-20.65	AVG		

REMARKS:

- (1) Measurement Value = Reading Level + Correct Factor.
- (2) Margin Level = Measurement Value - Limit Value.

Test Mode	IEEE 802.11g	Test Date	2024/2/5
Test Frequency	2457MHz	Polarization	Vertical

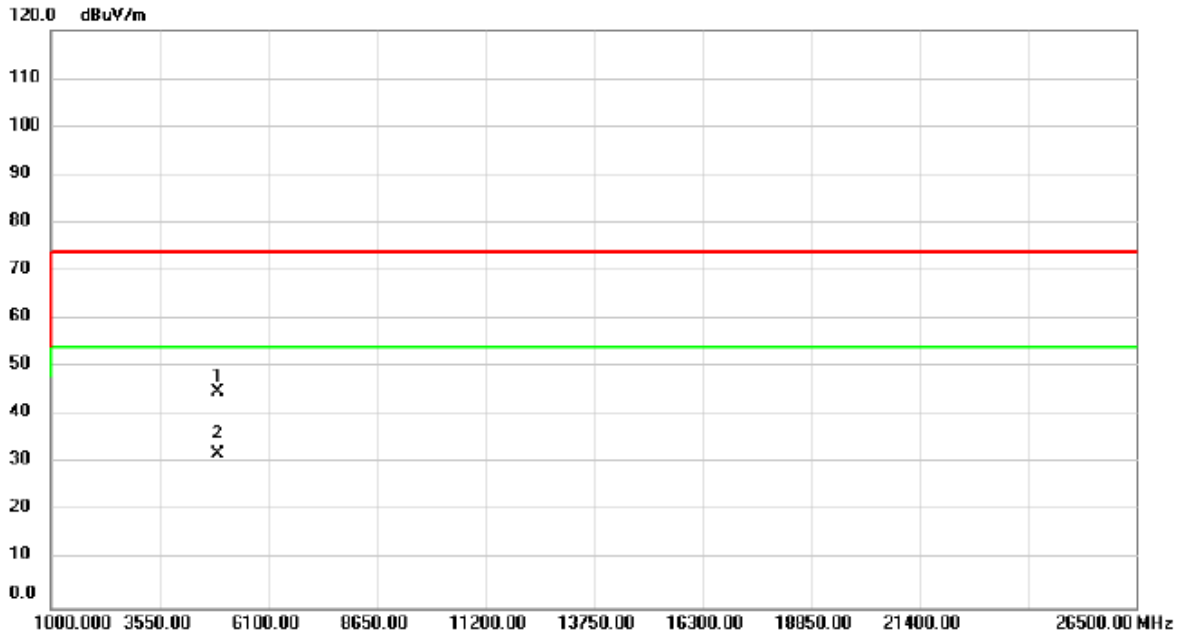

No.	Mk.	Freq.	Reading Level	Correct Factor	Measurement	Limit	Margin	Antenna Height	Table Degree	
		MHz	dBuV	dB	dBuV/m	dBuV/m	dB	cm	degree	Comment
1		4914.000	45.12	-0.37	44.75	74.00	-29.25			peak
2	*	4914.000	32.22	-0.37	31.85	54.00	-22.15			AVG

REMARKS:

- (1) Measurement Value = Reading Level + Correct Factor.
- (2) Margin Level = Measurement Value - Limit Value.

Test Mode	IEEE 802.11g	Test Date	2024/2/5
Test Frequency	2457MHz	Polarization	Horizontal

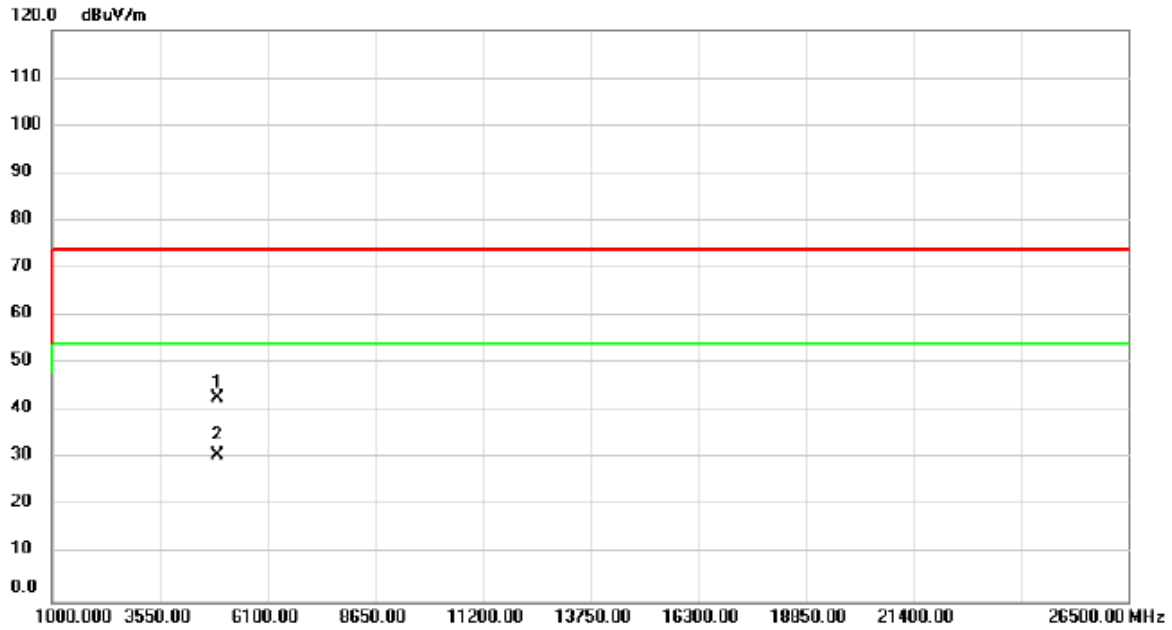

No.	Mk.	Freq. MHz	Reading Level dBuV	Correct Factor dB	Measure- ment dBuV/m	Limit dBuV/m	Margin dB	Detector	Antenna Height cm	Table Degree	Comment
1		4914.000	43.23	-0.37	42.86	74.00	-31.14	peak			
2	*	4914.000	31.25	-0.37	30.88	54.00	-23.12	AVG			

**REMARKS:**

- (1) Measurement Value = Reading Level + Correct Factor.
- (2) Margin Level = Measurement Value - Limit Value.

Test Mode	IEEE 802.11g	Test Date	2024/2/5
Test Frequency	2462MHz	Polarization	Vertical

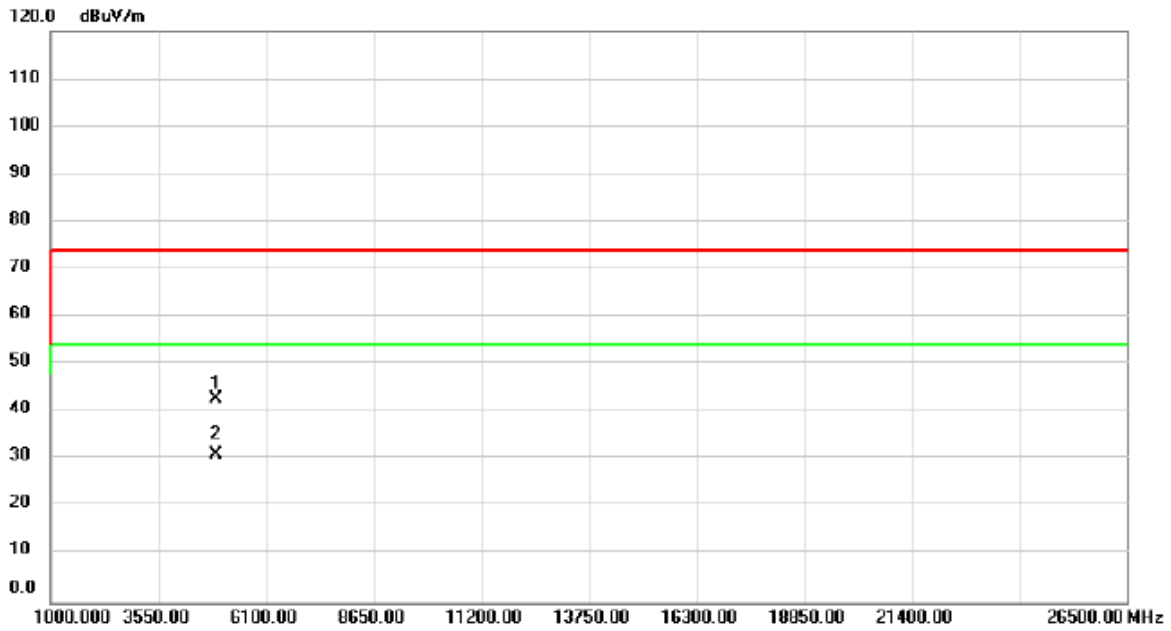

No.	Mk.	Freq. MHz	Reading Level dBuV	Correct Factor dB	Measure- ment dBuV/m	Limit dBuV/m	Margin dB	Detector	Antenna Height cm	Table Degree degree	Comment
1		4924.000	43.12	-0.36	42.76	74.00	-31.24	peak			
2	*	4924.000	31.41	-0.36	31.05	54.00	-22.95	AVG			

REMARKS:

- (1) Measurement Value = Reading Level + Correct Factor.
- (2) Margin Level = Measurement Value - Limit Value.

Test Mode	IEEE 802.11g	Test Date	2024/2/5
Test Frequency	2462MHz	Polarization	Horizontal

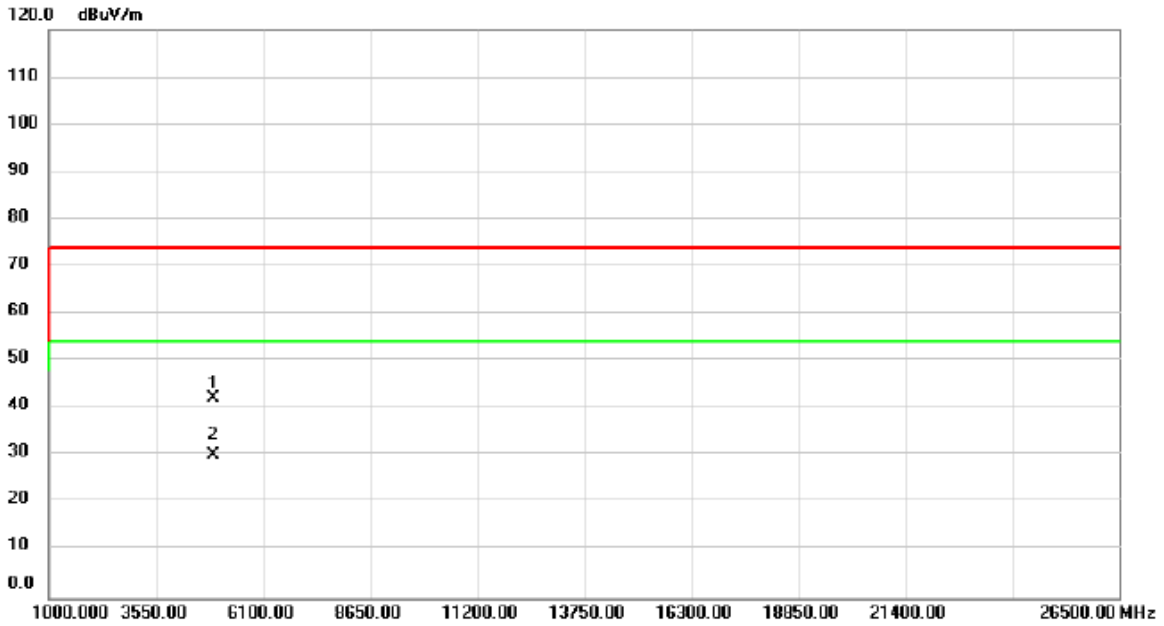

No.	Mk.	Freq. MHz	Reading Level dBuV	Correct Factor dB	Measure- ment dBuV/m	Limit dBuV/m	Margin dB	Detector	Antenna Height cm	Table Degree degree	Comment
1		4924.000	42.58	-0.36	42.22	74.00	-31.78	peak			
2	*	4924.000	30.58	-0.36	30.22	54.00	-23.78	AVG			

REMARKS:

- (1) Measurement Value = Reading Level + Correct Factor.
- (2) Margin Level = Measurement Value - Limit Value.



Test Mode	IEEE 802.11n(HT20)	Test Date	2024/2/4
Test Frequency	2412MHz	Polarization	Vertical

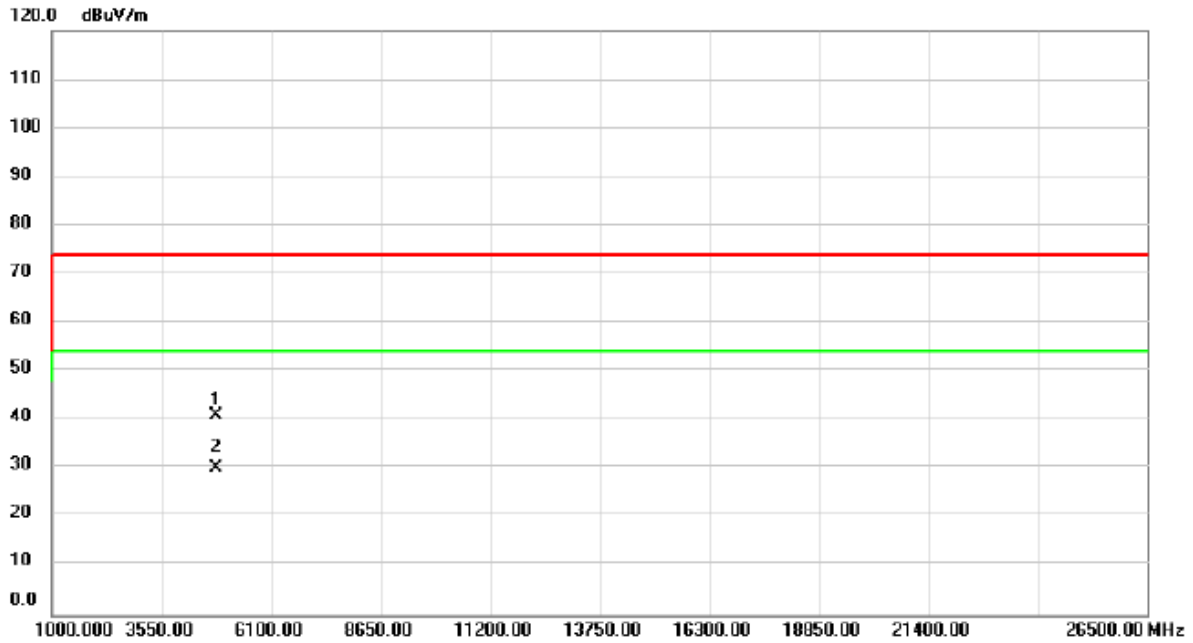

No.	Mk.	Freq. MHz	Reading Level dBuV	Correct Factor dB	Measure- ment dBuV/m	Limit dBuV/m	Margin dB	Detector	Antenna Height cm	Table Degree	Comment
1		4824.000	41.71	-0.64	41.07	74.00	-32.93	peak			
2	*	4824.000	30.75	-0.64	30.11	54.00	-23.89	AVG			

**REMARKS:**

- (1) Measurement Value = Reading Level + Correct Factor.
- (2) Margin Level = Measurement Value - Limit Value.

Test Mode	IEEE 802.11n(HT20)	Test Date	2024/2/4
Test Frequency	2412MHz	Polarization	Horizontal

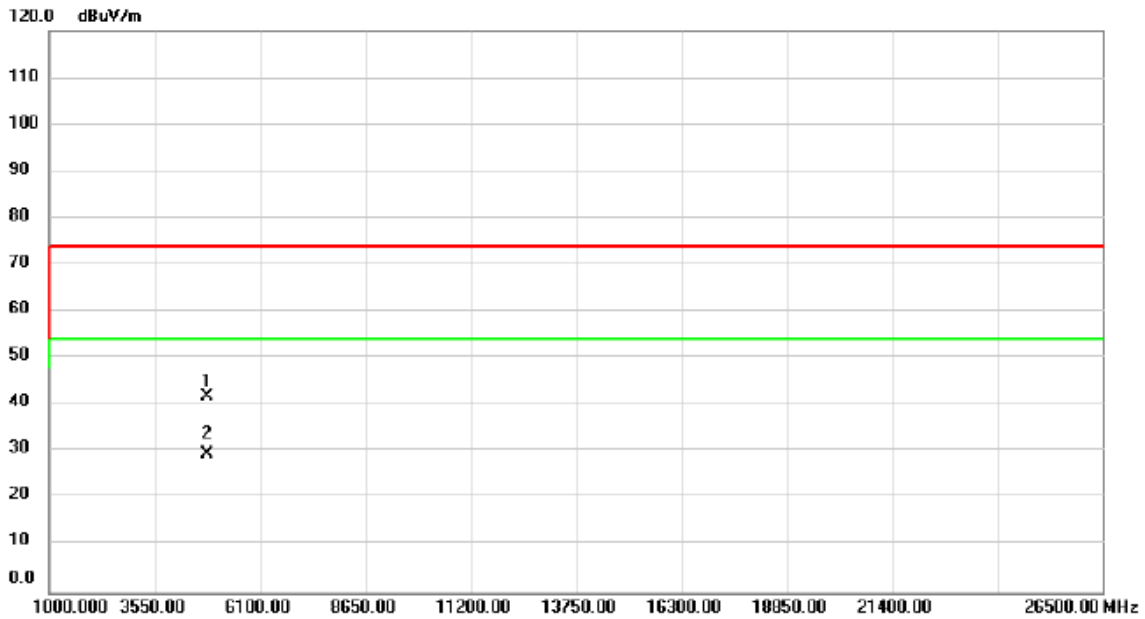

No.	Mk.	Freq. MHz	Reading Level dBuV	Correct Factor dB	Measure- ment dBuV/m	Limit dBuV/m	Margin dB	Detector	Antenna Height cm	Table Degree degree	Comment
1		4824.000	42.60	-0.64	41.96	74.00	-32.04	peak			
2	*	4824.000	30.14	-0.64	29.50	54.00	-24.50	AVG			

REMARKS:

- (1) Measurement Value = Reading Level + Correct Factor.
- (2) Margin Level = Measurement Value - Limit Value.

Test Mode	IEEE 802.11n(HT20)	Test Date	2024/2/4
Test Frequency	2417MHz	Polarization	Vertical

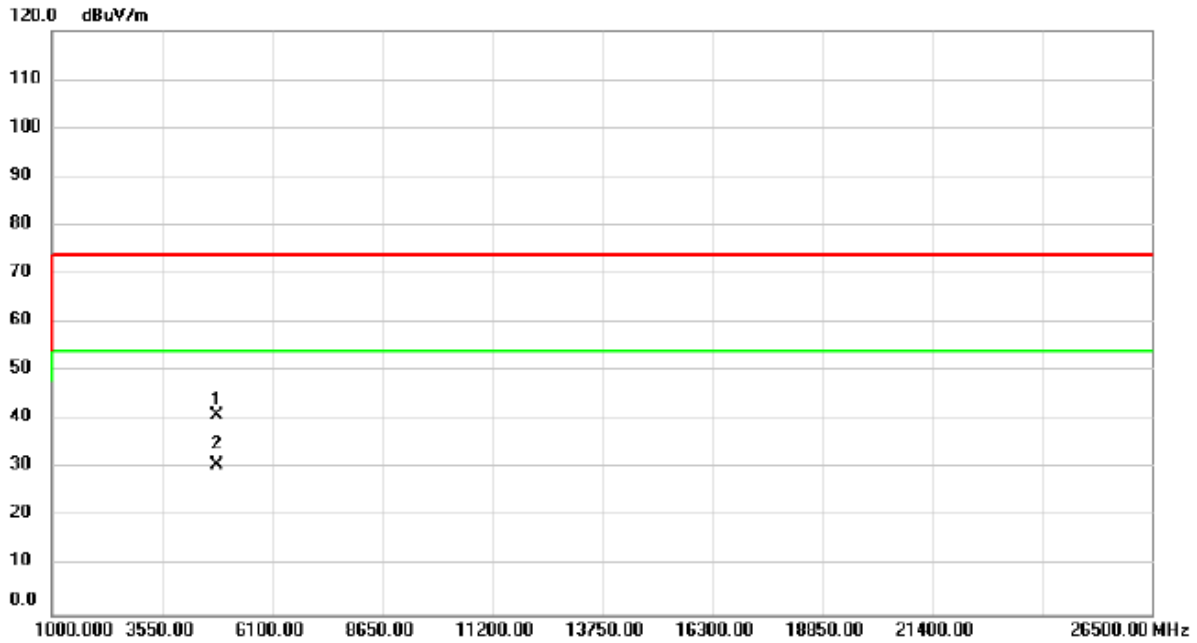

No.	Mk.	Freq. MHz	Reading Level dBuV	Correct Factor dB	Measure- ment dBuV/m	Limit dBuV/m	Margin dB	Detector	Antenna Height cm	Table Degree	Comment
1		4834.000	41.50	-0.60	40.90	74.00	-33.10	peak			
2	*	4834.000	31.28	-0.60	30.68	54.00	-23.32	AVG			

REMARKS:

- (1) Measurement Value = Reading Level + Correct Factor.
- (2) Margin Level = Measurement Value - Limit Value.

Test Mode	IEEE 802.11n(HT20)	Test Date	2024/2/4
Test Frequency	2417MHz	Polarization	Horizontal

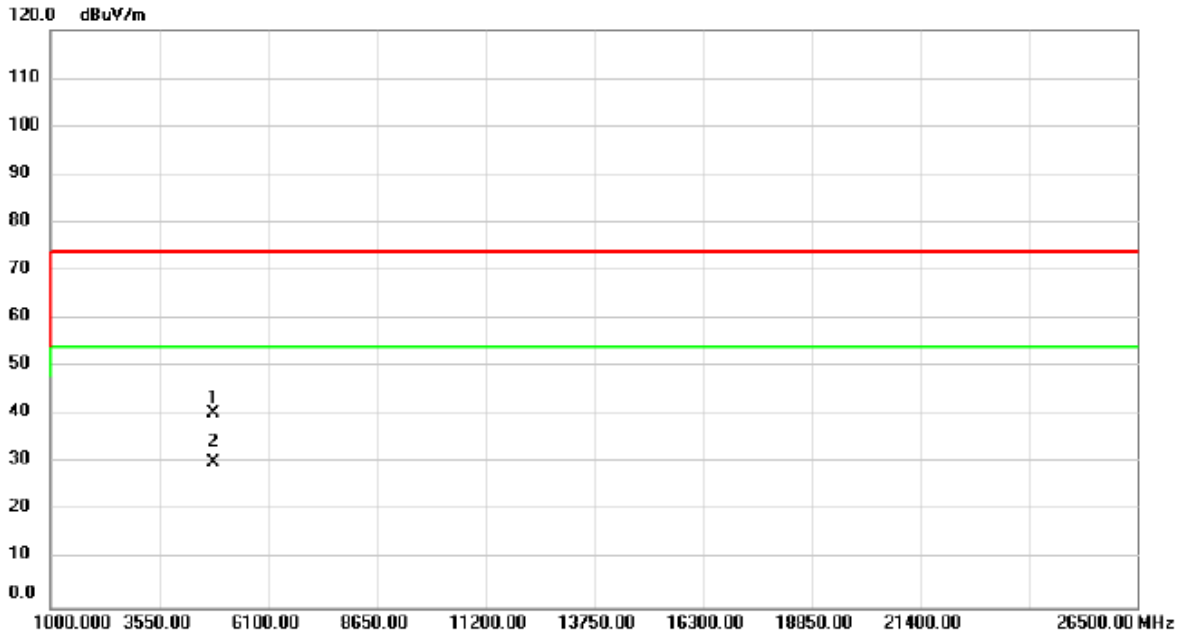

No.	Mk.	Freq. MHz	Reading Level dBuV	Correct Factor dB	Measure- ment dBuV/m	Limit dBuV/m	Margin dB	Antenna Height cm	Table Degree degree	Comment
1		4834.000	41.00	-0.60	40.40	74.00	-33.60			peak
2	*	4834.000	30.76	-0.60	30.16	54.00	-23.84			AVG

**REMARKS:**

- (1) Measurement Value = Reading Level + Correct Factor.
- (2) Margin Level = Measurement Value - Limit Value.

Test Mode	IEEE 802.11n(HT20)	Test Date	2024/2/4
Test Frequency	2437MHz	Polarization	Vertical

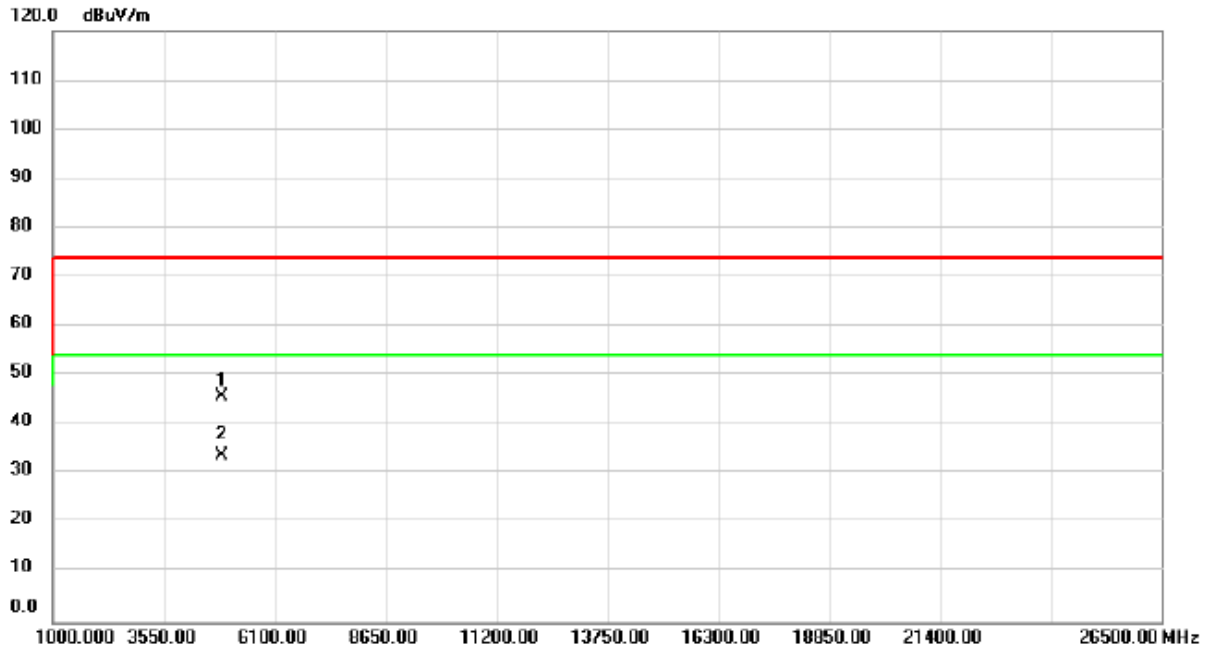

No.	Mk.	Freq.	Reading Level	Correct Factor	Measurement	Limit	Margin	Antenna Height	Table Degree	
		MHz	dBuV	dB	dBuV/m	dBuV/m	dB	cm	degree	Comment
1		4876.000	46.31	-0.48	45.83	74.00	-28.17			peak
2	*	4876.000	34.17	-0.48	33.69	54.00	-20.31			AVG

REMARKS:

- (1) Measurement Value = Reading Level + Correct Factor.
- (2) Margin Level = Measurement Value - Limit Value.

Test Mode	IEEE 802.11n(HT20)	Test Date	2024/2/4
Test Frequency	2437MHz	Polarization	Horizontal

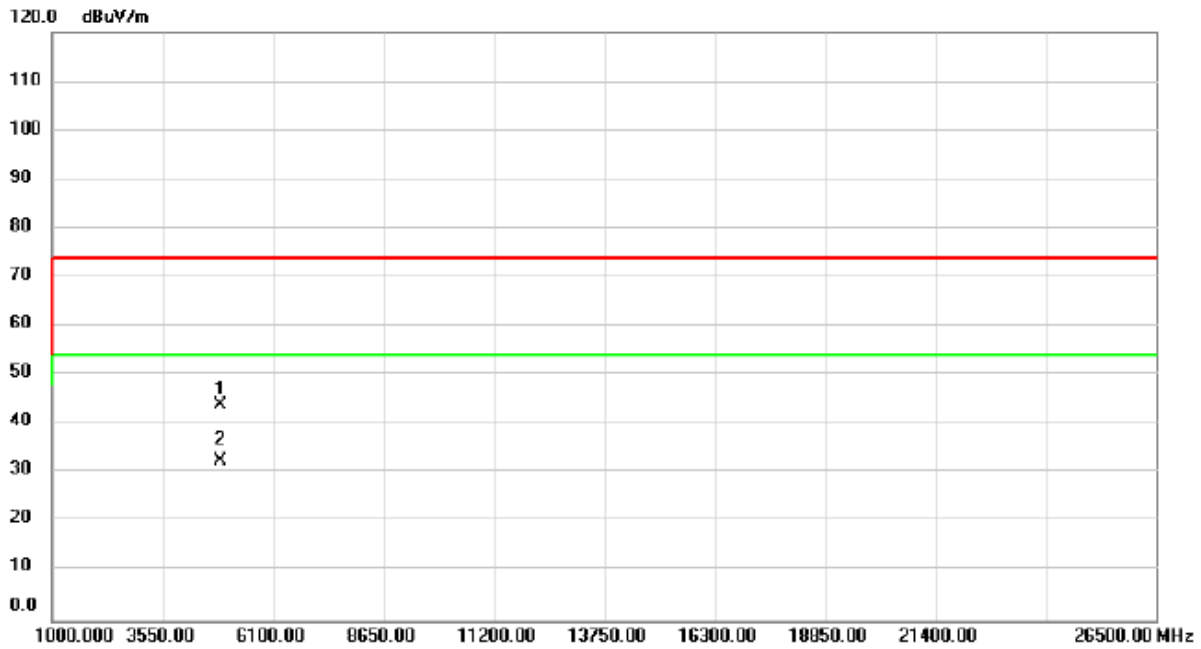

No.	Mk.	Freq.	Reading Level	Correct Factor	Measurement	Limit	Margin	Antenna Height	Table Degree	
		MHz	dBuV	dB	dBuV/m	dBuV/m	dB	cm	degree	Comment
1		4876.000	44.48	-0.48	44.00	74.00	-30.00			peak
2	*	4876.000	32.95	-0.48	32.47	54.00	-21.53			AVG

**REMARKS:**

- (1) Measurement Value = Reading Level + Correct Factor.
- (2) Margin Level = Measurement Value - Limit Value.

Test Mode	IEEE 802.11n(HT20)	Test Date	2024/2/4
Test Frequency	2457MHz	Polarization	Vertical

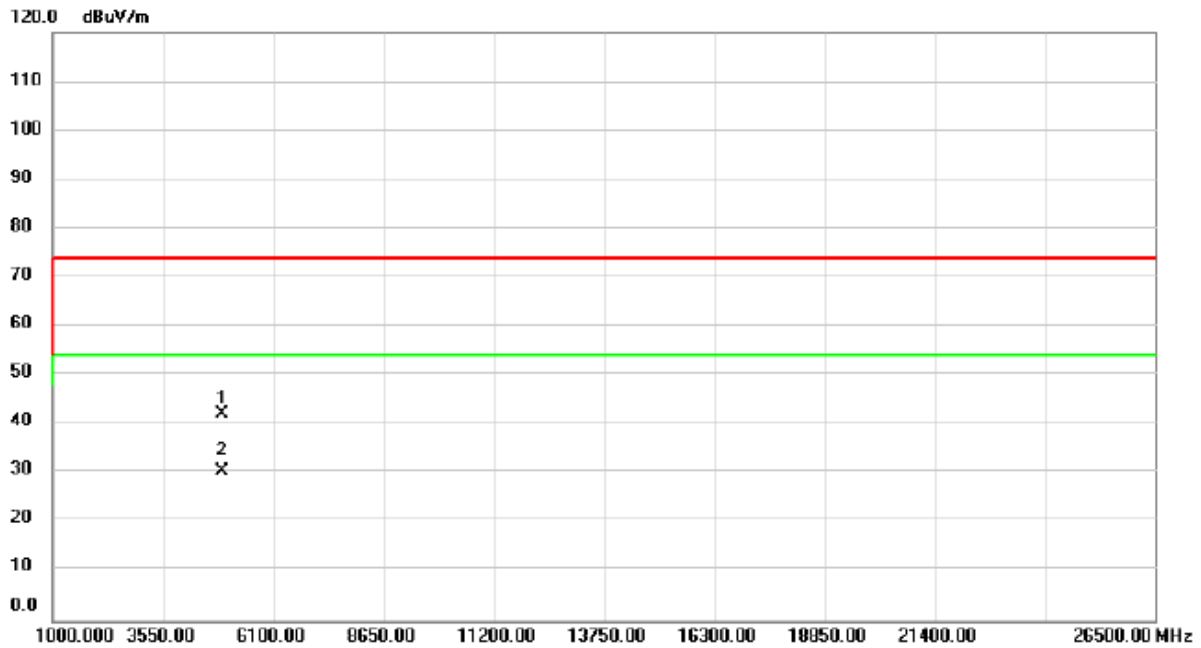

No. Mk.	Freq. MHz	Reading Level dBuV	Correct Factor dB	Measurement dBuV/m	Limit dBuV/m	Margin dB	Detector	Antenna Height cm	Table Degree	Comment
1	4914.000	42.55	-0.37	42.18	74.00	-31.82	peak			
2 *	4914.000	30.79	-0.37	30.42	54.00	-23.58	AVG			

REMARKS:

- (1) Measurement Value = Reading Level + Correct Factor.
- (2) Margin Level = Measurement Value - Limit Value.

Test Mode	IEEE 802.11n(HT20)	Test Date	2024/2/4
Test Frequency	2457MHz	Polarization	Horizontal

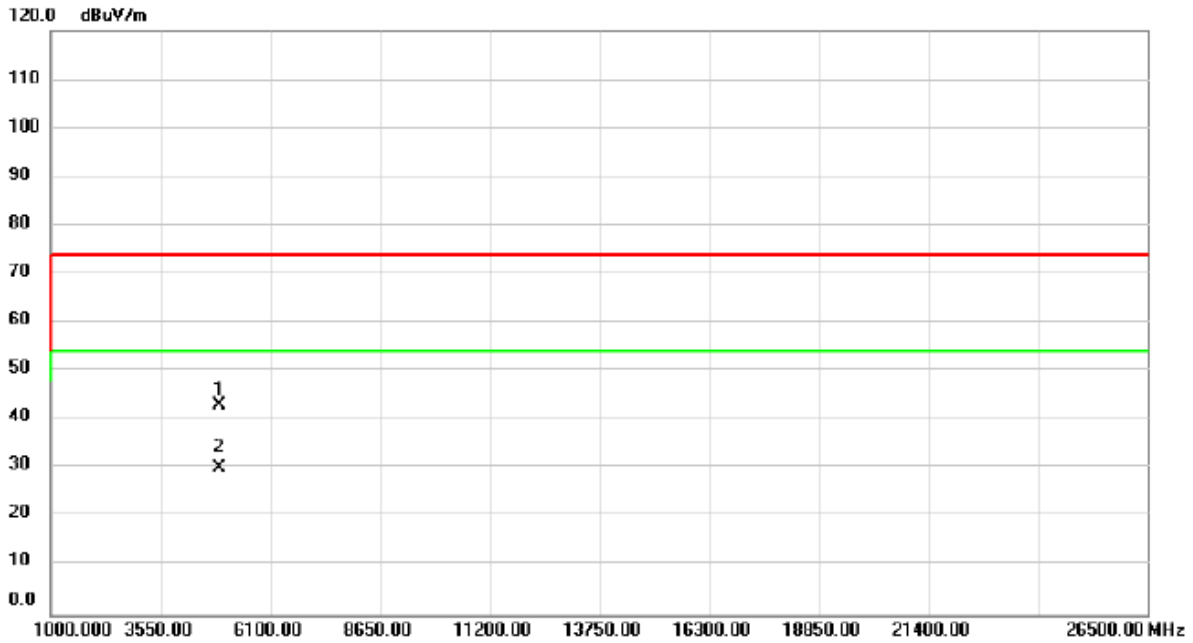

No.	Mk.	Freq.	Reading Level	Correct Factor	Measurement	Limit	Margin	Antenna Height	Table Degree	Comment
		MHz	dBuV	dB	dBuV/m	dBuV/m	dB	cm	degree	
1		4914.000	43.45	-0.37	43.08	74.00	-30.92			peak
2	*	4914.000	30.62	-0.37	30.25	54.00	-23.75			AVG

REMARKS:

- (1) Measurement Value = Reading Level + Correct Factor.
- (2) Margin Level = Measurement Value - Limit Value.



Test Mode	IEEE 802.11n(HT20)	Test Date	2024/2/4
Test Frequency	2462MHz	Polarization	Vertical

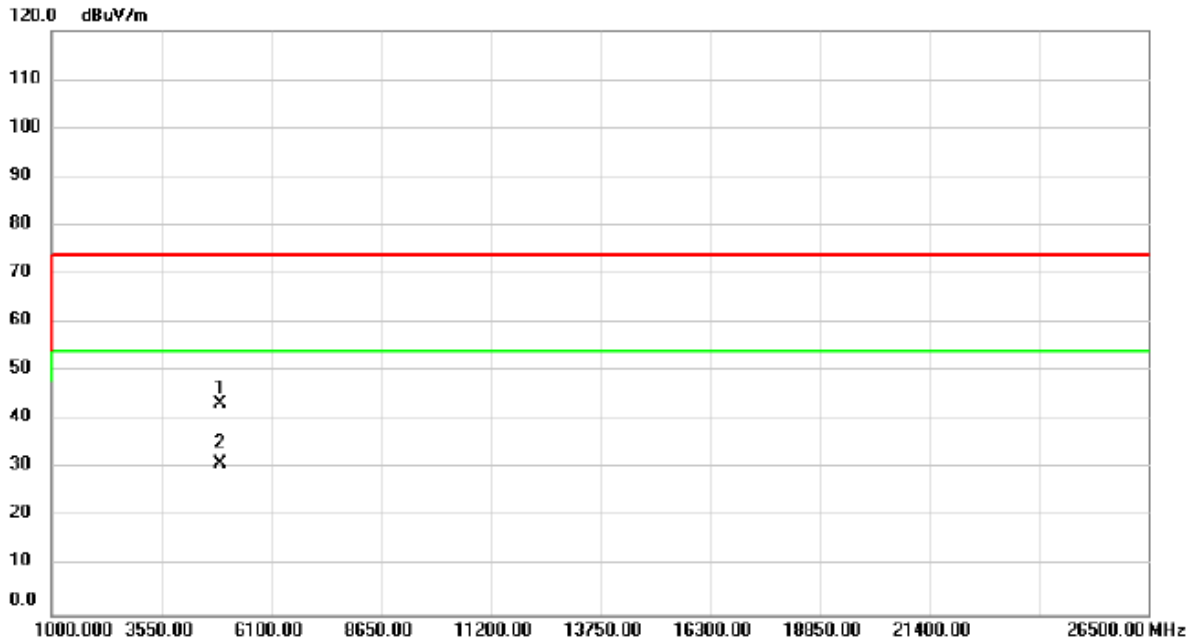

No.	Mk.	Freq.	Reading Level	Correct Factor	Measurement	Limit	Margin	Antenna Height	Table Degree	
		MHz	dBuV	dB	dBuV/m	dBuV/m	dB	cm	degree	Comment
1		4927.000	43.56	-0.34	43.22	74.00	-30.78			peak
2	*	4927.000	31.41	-0.34	31.07	54.00	-22.93			AVG

REMARKS:

- (1) Measurement Value = Reading Level + Correct Factor.
- (2) Margin Level = Measurement Value - Limit Value.

Test Mode	IEEE 802.11n(HT20)	Test Date	2024/2/4
Test Frequency	2462MHz	Polarization	Horizontal

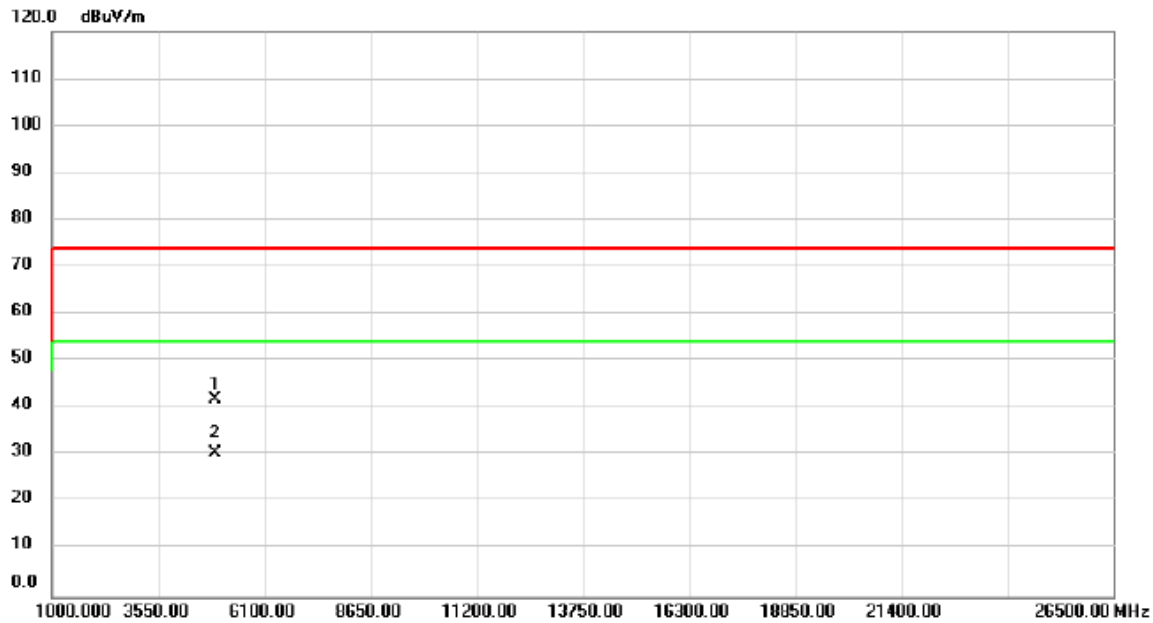

No.	Mk.	Freq. MHz	Reading Level dBuV	Correct Factor dB	Measure- ment dBuV/m	Limit dBuV/m	Margin dB	Detector	Antenna Height cm	Table Degree degree	Comment
1		4924.000	42.19	-0.36	41.83	74.00	-32.17	peak			
2	*	4924.000	30.86	-0.36	30.50	54.00	-23.50	AVG			

**REMARKS:**

- (1) Measurement Value = Reading Level + Correct Factor.
- (2) Margin Level = Measurement Value - Limit Value.

## APPENDIX D BANDWIDTH

Test Mode	IEEE 802.11b
-----------	--------------

Channel	Frequency (MHz)	6 dB Bandwidth (MHz)	99 % Occupied Bandwidth (MHz)	Minimum 6 dB Bandwidth Limit (kHz)	Result
01	2412	9.843	13.743	0.5	Complies
06	2437	9.885	16.990	0.5	Complies
11	2462	9.867	14.723	0.5	Complies

**CH01**

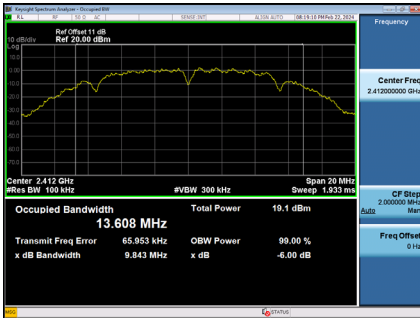

**CH06**  
6 dB Bandwidth

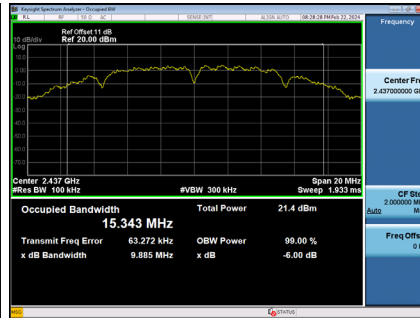

**CH11**

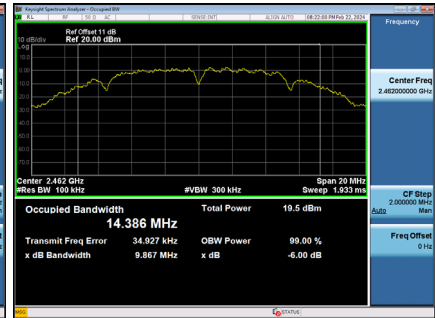

**99 % Occupied Bandwidth**

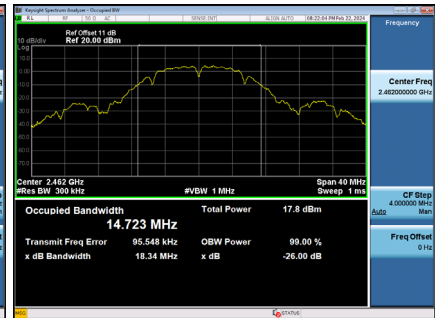
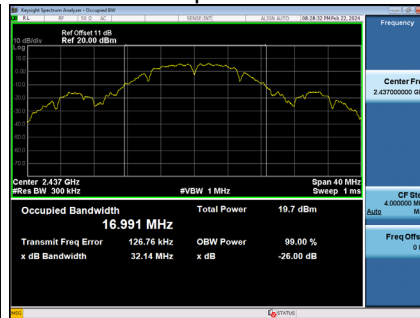
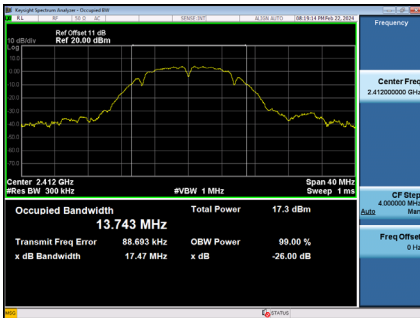

Test Mode	IEEE 802.11g
-----------	--------------

Channel	Frequency (MHz)	6 dB Bandwidth (MHz)	99 % Occupied Bandwidth (MHz)	Minimum 6 dB Bandwidth Limit (kHz)	Result
01	2412	16.381	16.747	0.5	Complies
06	2437	16.365	27.706	0.5	Complies
11	2462	16.561	37.686	0.5	Complies

**CH01**

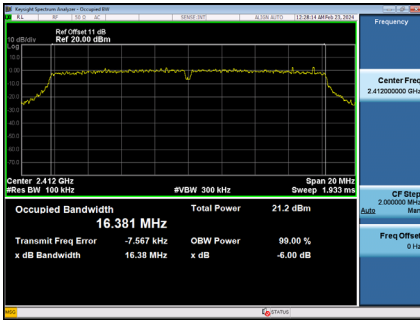

**CH06**  
6 dB Bandwidth

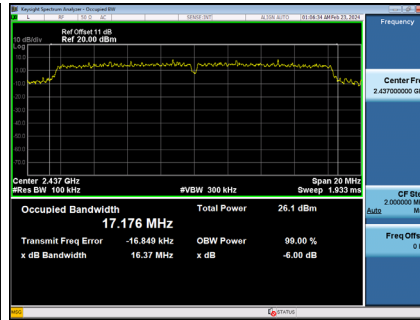

**CH11**

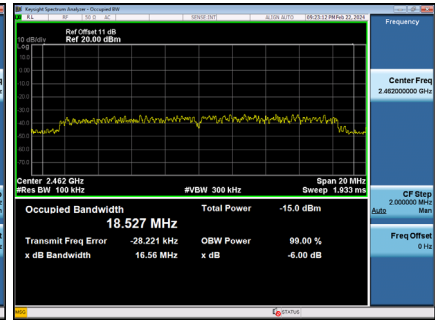

**99 % Occupied Bandwidth**

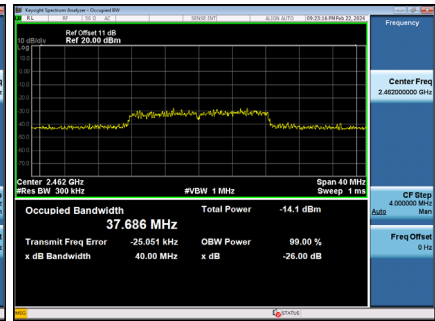
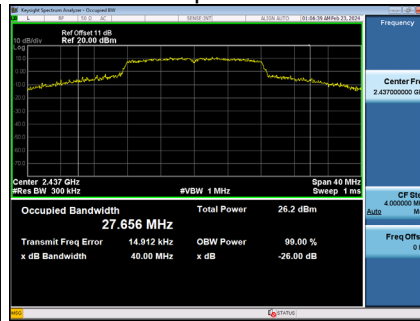
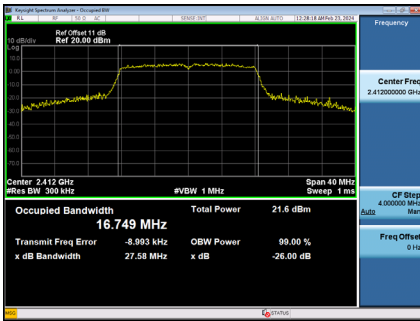

Test Mode	IEEE 802.11n (HT20)
-----------	---------------------

Channel	Frequency (MHz)	6 dB Bandwidth (MHz)	99 % Occupied Bandwidth (MHz)	Minimum 6 dB Bandwidth Limit (kHz)	Result
01	2412	16.475	17.539	0.5	Complies
06	2437	16.965	26.390	0.5	Complies
11	2462	16.675	17.555	0.5	Complies

**CH01**

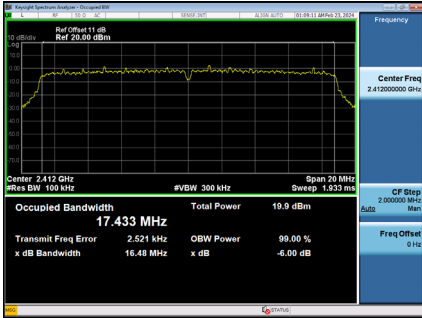

**CH06**  
6 dB Bandwidth

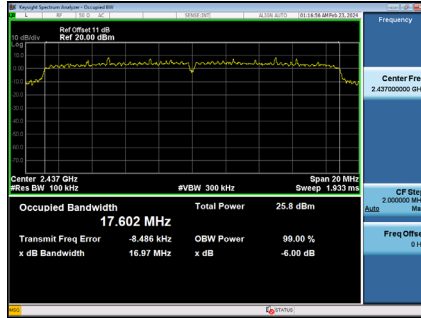

**CH11**

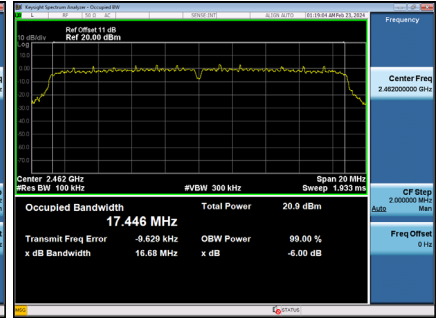

**99 % Occupied Bandwidth**

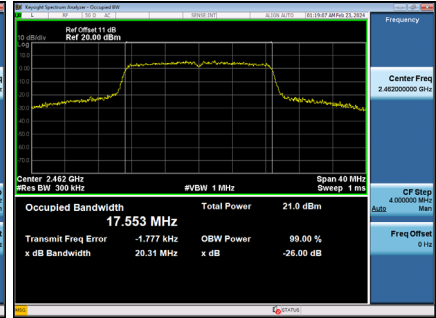
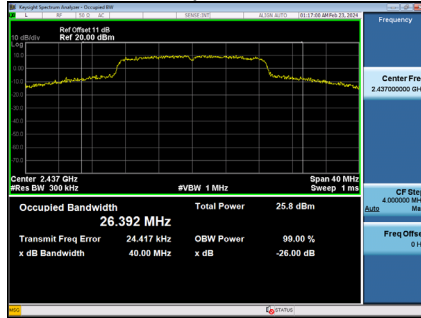
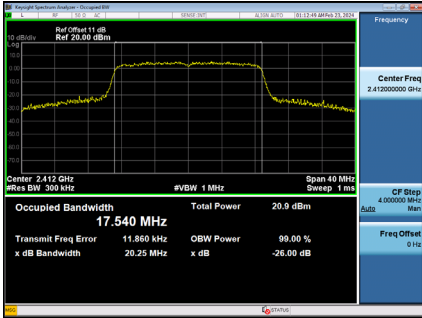

## APPENDIX E    MAXIMUM OUTPUT POWER

Test Mode	IEEE 802.11b_ Ant. 1	Tested Date	2024/2/22
-----------	----------------------	-------------	-----------

Channel	Frequency (MHz)	Output Power (dBm)	Duty Factor	Output Power + Duty Factor (dBm)	Max. Limit (dBm)	Max. Limit (W)	Result
01	2412	21.07	0.00	21.07	30.00	1.0000	Complies
06	2437	22.58	0.00	22.58	30.00	1.0000	Complies
11	2462	21.58	0.00	21.58	30.00	1.0000	Complies

Test Mode	IEEE 802.11b_ Ant. 2	Tested Date	2024/2/22
-----------	----------------------	-------------	-----------

Channel	Frequency (MHz)	Output Power (dBm)	Duty Factor	Output Power + Duty Factor (dBm)	Max. Limit (dBm)	Max. Limit (W)	Result
01	2412	20.63	0.00	20.63	30.00	1.0000	Complies
06	2437	22.46	0.00	22.46	30.00	1.0000	Complies
11	2462	20.93	0.00	20.93	30.00	1.0000	Complies

Test Mode	IEEE 802.11g_ Ant. 1	Tested Date	2024/2/22
-----------	----------------------	-------------	-----------

Channel	Frequency (MHz)	Output Power (dBm)	Duty Factor	Output Power + Duty Factor (dBm)	Max. Limit (dBm)	Max. Limit (W)	Result
01	2412	21.84	0.00	21.84	30.00	1.0000	Complies
06	2437	25.82	0.00	25.82	30.00	1.0000	Complies
11	2462	20.59	0.00	20.59	30.00	1.0000	Complies

Test Mode	IEEE 802.11g_ Ant. 2	Tested Date	2024/2/22
-----------	----------------------	-------------	-----------

Channel	Frequency (MHz)	Output Power (dBm)	Duty Factor	Output Power + Duty Factor (dBm)	Max. Limit (dBm)	Max. Limit (W)	Result
01	2412	21.57	0.00	21.57	30.00	1.0000	Complies
06	2437	25.87	0.00	25.87	30.00	1.0000	Complies
11	2462	21.19	0.00	21.19	30.00	1.0000	Complies



Test Mode	IEEE 802.11n (HT20) _ Ant. 1	Tested Date	2024/2/22
-----------	------------------------------	-------------	-----------

Channel	Frequency (MHz)	Output Power (dBm)	Duty Factor	Output Power + Duty Factor (dBm)	Max. Limit (dBm)	Max. Limit (W)	Result
01	2412	20.77	0.00	20.77	30.00	1.0000	Complies
06	2437	25.11	0.00	25.11	30.00	1.0000	Complies
11	2462	20.74	0.00	20.74	30.00	1.0000	Complies

Test Mode	IEEE 802.11n (HT20) _ Ant. 2	Tested Date	2024/2/22
-----------	------------------------------	-------------	-----------

Channel	Frequency (MHz)	Output Power (dBm)	Duty Factor	Output Power + Duty Factor (dBm)	Max. Limit (dBm)	Max. Limit (W)	Result
01	2412	21.15	0.00	21.15	30.00	1.0000	Complies
06	2437	24.26	0.00	24.26	30.00	1.0000	Complies
11	2462	20.84	0.00	20.84	30.00	1.0000	Complies

## APPENDIX F POWER SPECTRAL DENSITY

Test Mode	IEEE 802.11b_Ant. 2
-----------	---------------------

Test Frequency (MHz)	Power Spectral Density (dBm/3kHz)	Maximum Limit (dBm/3kHz)	Result
2412	-10.25	8.00	Pass
2437	-8.19	8.00	Pass
2462	-10.05	8.00	Pass

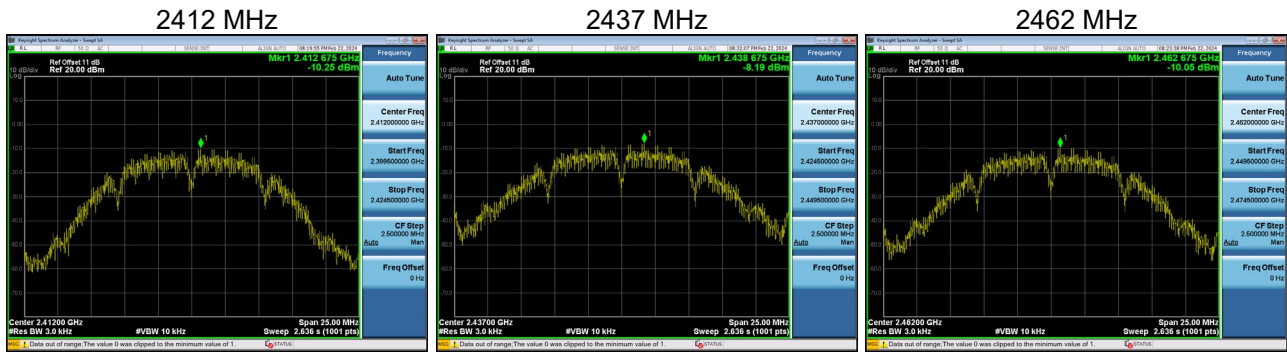

Test Mode	IEEE 802.11g_Ant. 2
-----------	---------------------

Test Frequency (MHz)	Power Spectral Density (dBm/3kHz)	Maximum Limit (dBm/3kHz)	Result
2412	-11.42	8.00	Pass
2437	-6.68	8.00	Pass
2462	-16.22	8.00	Pass

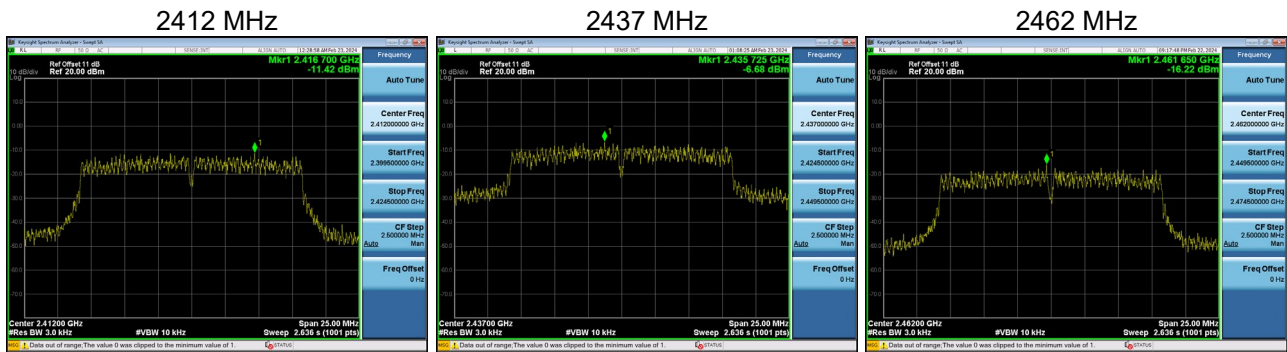

Test Mode	IEEE 802.11n (HT20)_ Ant. 2
-----------	-----------------------------

Test Frequency (MHz)	Power Spectral Density (dBm/3kHz)	Maximum Limit (dBm/3kHz)	Result
2412	-12.21	8.00	Pass
2437	-7.12	8.00	Pass
2462	-11.73	8.00	Pass

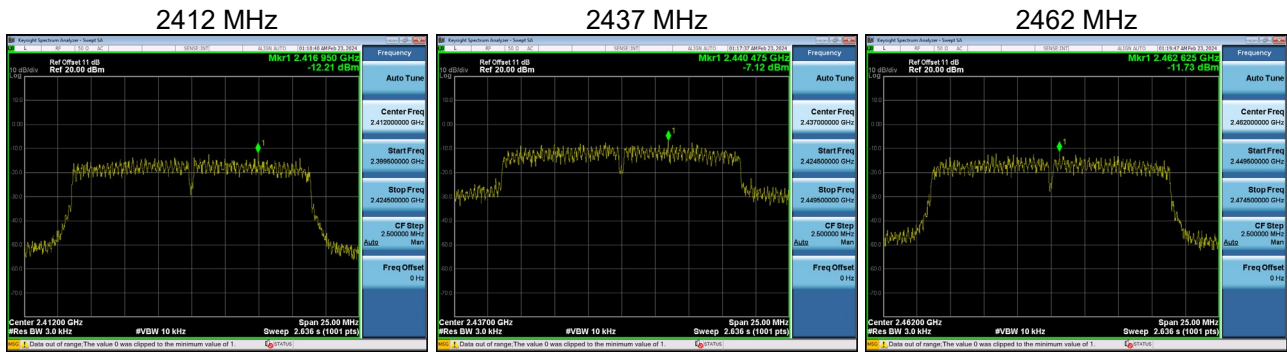

## APPENDIX G ANTENNA CONDUCTED SPURIOUS EMISSIONS