

RF MEASUREMENT REPORT

FCC ID : 2BCGWC220
Applicant : BIG FIELD GLOBAL PTE. LTD.
Application Type : Certification
Product : Pan/Tilt AI Home Security Wi-Fi Camera
Model No. : Tapo C220
Brand Name : tp-link
FCC Classification : Digital Transmission System (DTS)
FCC Rule Part(s) : Part15 Subpart C (Section 15.247)
Received Date : May 05, 2023
Test Date : May 09~September 28, 2023

Tested By : Owen Tsai
(Owen Tsai)
Reviewed By : Paddy Chen
(Paddy Chen)
Approved By : Chenz Ker
(Chenz Ker)



The test results relate only to the samples tested.

This equipment has been shown to be capable of compliance with the applicable technical standards as indicated in the measurement report and was tested in accordance with the measurement procedures specified in ANSI C63.10-2013. Test results reported herein relate only to the item(s) tested.

The test report shall not be reproduced except in full without the written approval of MRT Technology (Taiwan) Co., Ltd.

Revision History

Report No.	Version	Description	Issue Date	Note
2309TW0121-U1	1.0	Original Report	2023-10-16	Valid

CONTENTS

Description	Page
1. INTRODUCTION	6
1.1. Scope	6
1.2. MRT Test Location	6
2. PRODUCT INFORMATION	7
2.1. Feature of Equipment under Test	7
2.2. Product Specification Subjective to this Report.....	7
2.3. Working Frequencies for this report	8
2.4. Test Mode.....	8
2.5. Configuration of Test System.....	9
2.6. Test System Details	9
2.7. Description of Test Software	9
2.8. Applied Standards	10
2.9. Duty Cycle	10
2.10. Test Configuration	11
2.11. EMI Suppression Device(s)/Modifications.....	11
2.12. Labeling Requirements.....	11
3. DESCRIPTION of TEST.....	12
3.1. Evaluation Procedure	12
3.2. AC Line Conducted Emissions.....	12
3.3. Radiated Emissions	13
4. ANTENNA REQUIREMENTS.....	14
5. TEST EQUIPMENT CALIBRATION DATE.....	15
6. MEASUREMENT UNCERTAINTY	16
7. TEST RESULT	17
7.1. Summary	17
7.2. 6dB Bandwidth Measurement.....	18
7.2.1. Test Limit.....	18
7.2.2. Test Procedure used.....	18
7.2.3. Test Setting	18
7.2.4. Test Setup	18
7.2.5. Test Result	19
7.3. Output Power Measurement	23
7.3.1. Test Limit.....	23

7.3.2. Test Procedure Used	23
7.3.3. Test Setting	23
7.3.4. Test Setup	23
7.3.5. Test Result	24
7.4. Power Spectral Density Measurement	25
7.4.1. Test Limit	25
7.4.2. Test Procedure Used	25
7.4.3. Test Setting	25
7.4.4. Test Setup	26
7.4.5. Test Result	27
7.5. Conducted Band Edge and Out-of-Band Emissions.....	31
7.5.1. Test Limit	31
7.5.2. Test Procedure Used	31
7.5.3. Test Setting	31
7.5.4. Test Setup	32
7.5.5. Test Result	33
7.6. Radiated Spurious Emission Measurement	37
7.6.1. Test Limit	37
7.6.2. Test Procedure Used	37
7.6.3. Test Setting	37
7.6.4. Test Setup	39
7.6.5. Test Result	40
7.7. Radiated Restricted Band Edge Measurement	60
7.7.1. Test Limit	60
7.7.2. Test Procedure Used	61
7.7.3. Test Setting	61
7.7.4. Test Setup	62
7.7.5. Test Result	63
7.8. AC Conducted Emissions Measurement.....	99
7.8.1. Test Limit	99
7.8.2. Test Setup	99
7.8.3. Test Result	100
8. CONCLUSION	104
Appendix A : Test Setup Photograph	105
Appendix B : External Photograph.....	105
Appendix C : Internal Photograph.....	105

General Information

Applicant	BIG FIELD GLOBAL PTE. LTD.
Applicant Address	7 Temasek Boulevard #29-03 Suntec Tower One, Singapore 038987
Manufacturer	BIG FIELD GLOBAL PTE. LTD.
Manufacturer Address	7 Temasek Boulevard #29-03 Suntec Tower One, Singapore 038987
Test Site	MRT Technology (Taiwan) Co., Ltd
Test Site Address	No. 38, Fuxing Second Rd., Guishan Dist., Taoyuan City 333, Taiwan (R.O.C)
MRT FCC Registration No.	291082
FCC Rule Part(s)	Part 15.247

Test Facility / Accreditations

1. MRT facility is a FCC registered (Reg. No. 291082) test facility with the site description report on file and is designated by the FCC as an Accredited Test Firm.
2. MRT facility is an IC registered (MRT Reg. No. 21723) test laboratory with the site description on file at Industry Canada.
3. MRT Lab is accredited to ISO 17025 by the Taiwan Accreditation Foundation (TAF Cert. No. 3261) in EMC, Telecommunications and Radio testing for FCC (Designation Number: TW3261), Industry Canada, EU and TELEC Rules.

1. INTRODUCTION

1.1. Scope

Measurement and determination of electromagnetic emissions (EMC) of radio frequency devices including intentional and/or unintentional radiators for compliance with the technical rules and regulations of the Federal Communications Commission and the Innovation, Science and Economic Development Canada and Certification and Engineering Bureau.

1.2. MRT Test Location

The map below shows the location of the MRT LABORATORY, its proximity to the Taoyuan City. These measurement tests were conducted at the MRT Technology (Taiwan) Co., Ltd. Facility located at No.38, Fuxing 2nd Rd., Guishan Dist., Taoyuan City 33377, Taiwan (R.O.C).

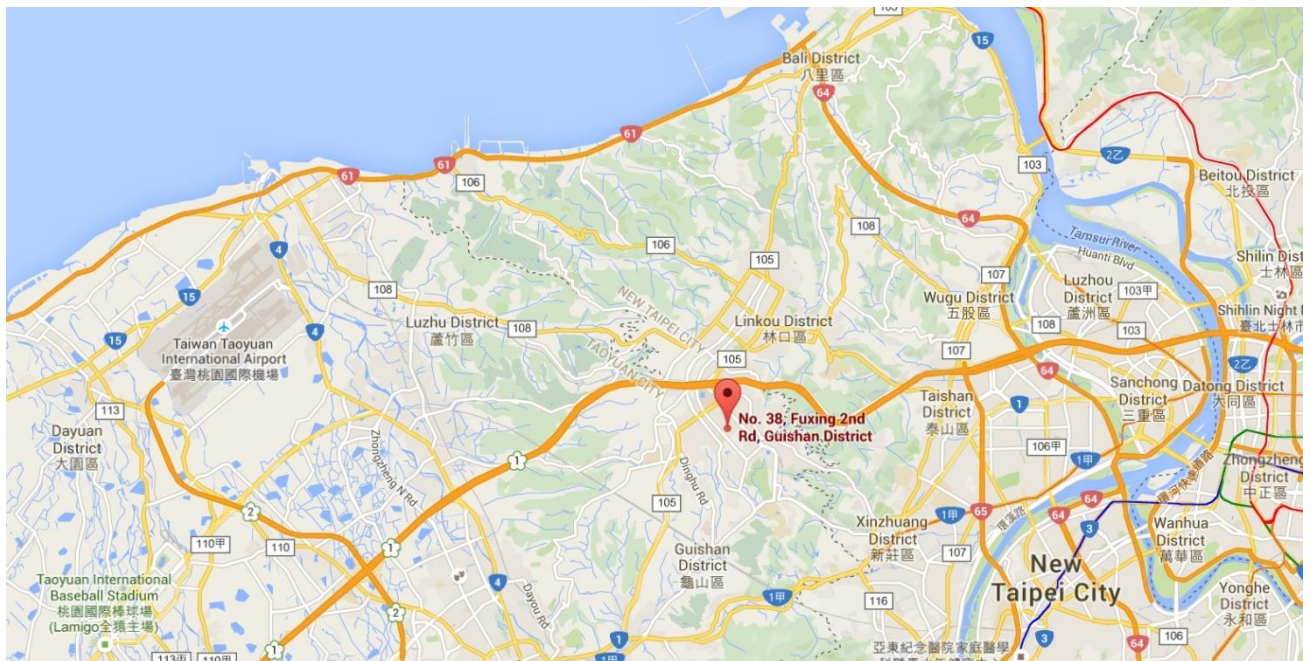

2. PRODUCT INFORMATION

2.1. Feature of Equipment under Test

Product Name:	Pan/Tilt AI Home Security Wi-Fi Camera
Model No.:	Tapo C220
Brand Name:	tp-link
Wi-Fi Specification:	802.11b/g/n
EUT Identification No.:	#1-1 (Conducted) #1-2 (Radiated)
Accessory	
Adapter	BRAND: tp-link MODEL: T090060-2B1 INPUT: 100 - 240V ~ 50/60Hz 0.3A. OUTPUT: DC 9V/ 0.6A Cable Out: Non-shielding, 1.5m

2.2. Product Specification Subjective to this Report

Frequency Range:	802.11b/g/n-HT20: 2412 ~ 2462MHz
Channel Number:	802.11b/g/n-HT20: 11
Type of Modulation:	802.11b: DSSS 802.11g/n: OFDM
Data Rate:	802.11b: 1/2/5.5/11Mbps 802.11g: 6/9/12/18/24/36/48/54Mbps 802.11n: up to 72.2Mbps
Antenna Type:	PIFA
Antenna Gain:	2.0dBi

2.3. Working Frequencies for this report

802.11b/g/n-HT20

Channel	Frequency	Channel	Frequency	Channel	Frequency
01	2412 MHz	02	2417 MHz	03	2422 MHz
04	2427 MHz	05	2432 MHz	06	2437 MHz
07	2442 MHz	08	2447 MHz	09	2452 MHz
10	2457 MHz	11	2462 MHz	--	--

2.4. Test Mode

Mode 1: Transmit by 802.11b_(1Mbps)
Mode 2: Transmit by 802.11g_(6Mbps)
Mode 3: Transmit by 802.11n-HT20_(MCS0)
Remark: For Radiated emission, the modulation and the data rate picked for testing are determined by the Max. RF conducted power.

2.5. Configuration of Test System

The device was tested per the guidance ANSI C63.10: 2013 was used to reference the appropriate EUT setup for radiated emissions testing and AC line conducted testing.

Connection Diagram – Mode 1~3

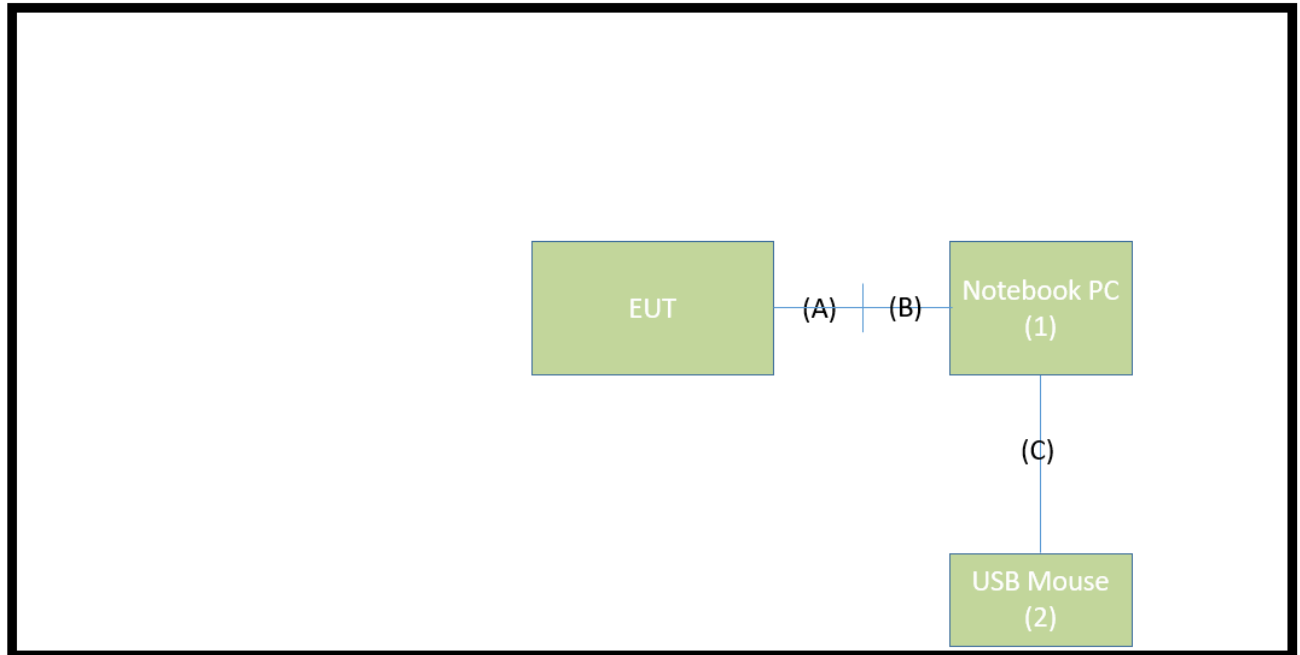

	Cable Type	Cable Description
A	USB Cable	shielded, 0.4m
B	USB Cable	shielded, 1.0m
C	USB Mouse Cable	shielded, 1.8m

2.6. Test System Details

The types for all equipments, plus descriptions of all cables used in the tested system (including inserted cards) are:

Mode1~3:

	Product	Manufacturer	Model No.	Serial No.	Power Cord
1	Notebook PC	Lenovo	T450	N/A	Non-shielded, 0.8m
2	USB Mouse	Logitech	M90	N/A	N/A

2.7. Description of Test Software

The test utility software used during testing was “RTL11n_8188FTV_USB_v1.25”.

Note: Final power setting please refer to operational description.

2.8. Applied Standards

According to the specifications of the manufacturer, the EUT must comply with the requirements of the following standards:

- FCC Part 15.247
- KDB 558074 D01v05r02
- ANSI C63.10-2013

2.9. Duty Cycle

2.4GHz WLAN (DTS) operation is possible in 20MHz channel bandwidths. The maximum achievable duty cycles for all modes were determined based on measurements performed on a spectrum analyzer in zero-span mode with RBW = 8MHz, VBW = 50MHz. The RBW and VBW were both greater than 50/T, where T is the minimum transmission duration, and the number of sweep points across T was greater than 100. The duty cycles are as follows:

Test Mode	Duty Cycle
802.11b	99.27%
802.11g	90.62%
802.11n-HT20	89.54%

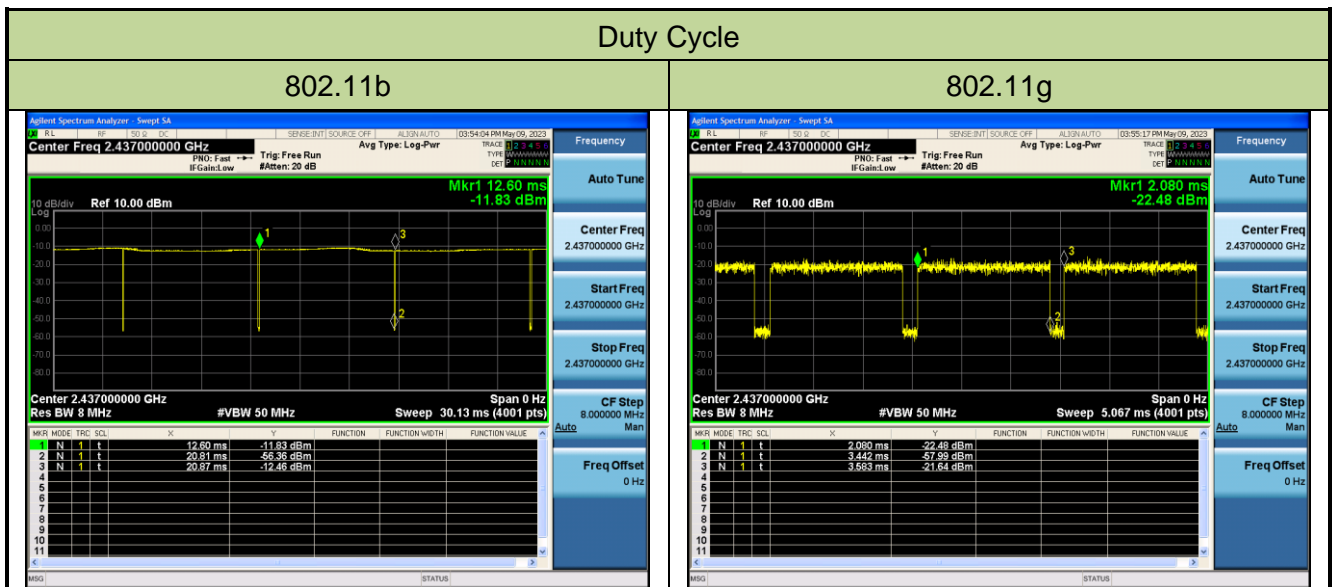

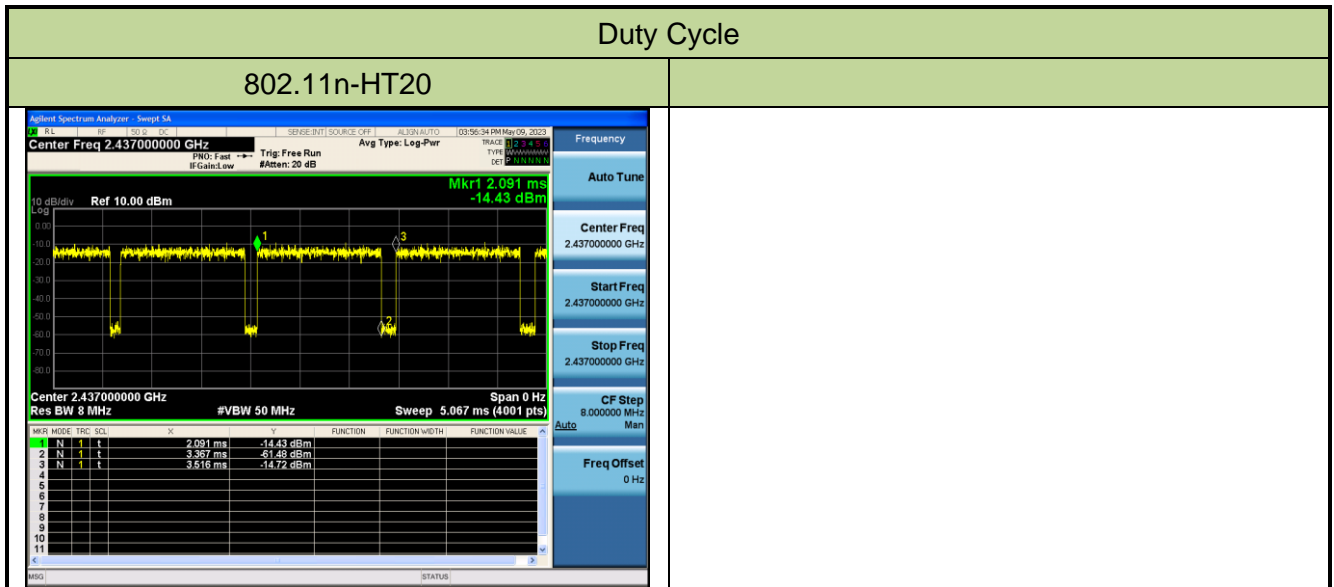

2.10. Test Configuration

The device was tested per the guidance of ANSI C63.10-2013. ANSI C63.10-2013 was used to reference the appropriate EUT setup for radiated spurious emissions testing and AC line conducted testing.

2.11. EMI Suppression Device(s)/Modifications

No EMI suppression device(s) were added and/or no modifications were made during testing.

2.12. Labeling Requirements

Per 2.1074 & 15.19; Docket 95-19

The label shall be permanently affixed at a conspicuous location on the device; instruction manual or pamphlet supplied to the user and be readily visible to the purchaser at the time of purchase. However, when the device is so small wherein placement of the label with specified statement is not practical, only the FCC ID must be displayed on the device per Section 15.19(a)(5). Please see attachment for FCC ID label and label location.

3. DESCRIPTION of TEST

3.1. Evaluation Procedure

The measurement procedures described in the American National Standard of Procedures for Compliance Testing of Unlicensed Wireless Devices (ANSI C63.10-2013), and the guidance was used in the measurement.

3.2. AC Line Conducted Emissions

The line-conducted facility is located inside an 8'x4'x4' shielded enclosure. A 1m x 2m wooden table 80cm high is placed 40cm away from the vertical wall and 80cm away from the sidewall of the shielded room. Two 10kHz-30MHz, 50Ω/50uH Line-Impedance Stabilization Networks (LISNs) are bonded to the shielded room floor. Power to the LISNs is filtered by external high-current high-insertion loss power line filters. These filters attenuate ambient signal noise from entering the measurement lines. These filters are also bonded to the shielded enclosure.

The EUT is powered from one LISN and the support equipment is powered from the second LISN. All interconnecting cables more than 1 meter were shortened to a 1 meter length by non-inductive bundling (serpentine fashion) and draped over the back edge of the test table. All cables were at least 40cm above the horizontal reference ground-plane. Power cables for support equipment were routed down to the second LISN while ensuring that that cables were not draped over the second LISN.

Sufficient time for the EUT, support equipment, and test equipment was allowed in order for them to warm up to their normal operating condition. The RF output of the LISN was connected to the receiver and exploratory measurements were made to determine the frequencies producing the maximum emission from the EUT. The receiver was scanned from 150kHz to 30MHz. The detector function was set to peak mode for exploratory measurements while the bandwidth of the analyzer was set to 9kHz. The EUT, support equipment, and interconnecting cables were arranged and manipulated to maximize each emission. Each emission was also maximized by varying power lines, the mode of operation or data exchange speed, or support equipment whichever determined the worst-case emission. Once the worst-case emissions have been identified, the one EUT cable configuration/arrangement and mode of operation that produced these emissions are used for final measurements on the same test site. The analyzer is set to CISPR quasi-peak and average detectors with a 9kHz resolution bandwidth for final measurements.

An extension cord was used to connect to a single LISN which powered by EUT. The extension cord was calibrated with LISN, the impedance and insertion loss are compliance with the requirements as stated in ANSI C63.10-2013.

3.3. Radiated Emissions

The radiated test facilities consisted of an indoor 3 meter semi-anechoic chamber used for final measurements and exploratory measurements, when necessary. The measurement area is contained within the semi-anechoic chamber which is shielded from any ambient interference. For measurements above 1GHz absorbers are arranged on the floor between the turn table and the antenna mast in such a way so as to maximize the reduction of reflections. For measurements below 1GHz, the absorbers are removed. A MF Model 210SS turntable is used for radiated measurement. It is a continuously rotatable, remote controlled, metallic turntable and 2 meters (6.56 ft.) in diameter. The turn table is flush with the raised floor of the chamber in order to maintain its function as a ground plane. An 80cm high PVC support structure is placed on top of the turntable.

For all measurements, the spectrum was scanned through all EUT azimuths and from 1 to 4 meter receive antenna height using a broadband antenna from 30MHz up to the upper frequency shown in 15.33(b)(1) depending on the highest frequency generated or used in the device or on which the device operates or tunes. For frequencies above 1GHz, linearly polarized double ridge horn antennas were used. For frequencies below 30MHz, a calibrated loop antenna was used. When exploratory measurements were necessary, they were performed at 1 meter test distance inside the semi-anechoic chamber using broadband antennas, broadband amplifiers, and spectrum analyzers to determine the frequencies and modes producing the maximum emissions. Sufficient time for the EUT, support equipment, and test equipment was allowed in order for them to warm up to their normal operating condition. The test set-up for frequencies below 1GHz was placed on top of the 0.8 meter high, 1 x 1.5 meter table; and test set-up for frequencies 1-40GHz was placed on top of the 1.5 meter high, 1 x 1.5 meter table. The EUT, support equipment, and interconnecting cables were arranged and manipulated to maximize each emission. Appropriate precaution was taken to ensure that all emissions from the EUT were maximized and investigated. The system configuration, clock speed, mode of operation or video resolution, if applicable, turntable azimuth, and receive antenna height was noted for each frequency found.

Final measurements were made in the semi-anechoic chamber using calibrated, linearly polarized broadband and horn antennas. The test setup was configured to the setup that produced the worst case emissions. The spectrum analyzer was set to investigate all frequencies required for testing to compare the highest radiated disturbances with respect to the specified limits. The turntable containing the EUT was rotated through 360 degrees and the height of the receive antenna was varied 1 to 4 meters and stopped at the azimuth and height producing the maximum emission. Each emission was maximized by changing the orientation of the EUT through three orthogonal planes and changing the polarity of the receive antenna, whichever produced the worst-case emissions. According to 3dB Beam-Width of horn antenna, the horn antenna should be always directed to the EUT when rising height.

4. ANTENNA REQUIREMENTS

Excerpt from §15.203 of the FCC Rules/Regulations:

“An intentional radiator antenna shall be designed to ensure that no antenna other than that furnished by the responsible party can be used with the device. The use of a permanently attached antenna or of an antenna that uses a unique coupling to the intentional radiator shall be considered sufficient to comply with the provisions of this section.”

- The antenna of the device is **permanently attached**.
- There are no provisions for connection to an external antenna.

Conclusion:

The unit complies with the requirement of §15.203.

5. TEST EQUIPMENT CALIBRATION DATE

Conducted Emissions

Instrument	Manufacturer	Type No.	Asset No.	Cali. Interval	Cali. Due Date
Two-Line V-Network	R&S	ENV216	MRTTWA00019	1 year	2024/3/7
Two-Line V-Network	R&S	ENV216	MRTTWA00020	1 year	2024/4/17
EMI Test Receiver	R&S	ESR3	MRTTWA00045	1 year	2024/5/9

Radiated Emissions

Instrument	Manufacturer	Type No.	Asset No.	Cali. Interval	Cali. Due Date
Active Loop Antenna	SCHWARZBECK	FMZB 1519B	MRTTWA00002	1 year	2024/5/23
Broadband TRILOG Antenna	SCHWARZBECK	VULB 9162	MRTTWA00001	1 year	2023/12/21
Broadband Hornantenna	SCHWARZBECK	BBHA 9120D	MRTTWA00003	1 year	2024/3/24
Broadband Preamplifier	SCHWARZBECK	BBV 9718	MRTTWA00005	1 year	2024/3/24
Breitband Hornantenna	SCHWARZBECK	BBHA 9170	MRTTWA00004	1 year	2024/3/20
Broadband Amplifier	SCHWARZBECK	BBV 9721	MRTTWA00006	1 year	2024/3/27
EMI Test Receiver	R&S	ESR3	MRTTWA00009	1 year	2024/3/8
Signal Analyzer	R&S	FSV40	MRTTWA00007	1 year	2024/3/14
Antenna Cable	HUBERSUHNER	SF106	MRTTWE00010	1 year	2024/6/13
Cable	Rosnol	K1K50-UP02 64-K1K50-4M	MRTTWE00012	1 year	2024/6/18
Temperature/Humidity Meter	TFA	35.1078.10.IT	MRTTWA00032	1 year	2024/6/4

Conducted Test Equipment

Instrument	Manufacturer	Type No.	Asset No.	Cali. Interval	Cali. Due Date
X-Series USB Peak and Average Power Sensor	KEYSIGHT	U2021XA	MRTTWA00014	1 year	2024/4/19
EXA Signal Analyzer	KEYSIGHT	N9010A	MRTTWA00012	1 year	2023/10/5
EXA Signal Analyzer	KEYSIGHT	N9010B	MRTTWA00074	1 year	2024/7/19
Attenuator	WTI	218FS-20	MRTTWE00026	1 year	2023/11/2
Attenuator	WTI	218FS-10	MRTTWE00027	1 year	2024/6/14
Attenuator	WTI	218FS-06	MRTTWE00028	1 year	2024/6/14
Temperature & Humidity Chamber	TEN BILLION	TTH-B3UP	MRTTWA00036	1 year	2024/6/11
DIVA PLUS Funk-Wetterstation	TFA	35.1083	MRTTWA00050	1 year	2024/6/15

Software	Version	Function
e3	9.160520a	EMI Test Software

6. MEASUREMENT UNCERTAINTY

Where relevant, the following test uncertainty levels have been estimated for tests performed on the EUT as specified in CISPR 16-4-2. This uncertainty represents an expanded uncertainty expressed at approximately the 95% confidence level using a coverage factor of $k = 2$.

AC Conducted Emission Measurement
Measuring Uncertainty for a Level of Confidence of 95% ($U=2Uc(y)$): 150kHz~30MHz: $\pm 2.53\text{dB}$
Radiated Emission Measurement
Measuring Uncertainty for a Level of Confidence of 95% ($U=2Uc(y)$): 9kHz ~ 1GHz: $\pm 4.25\text{dB}$ 1GHz ~ 40GHz: $\pm 4.45\text{dB}$
Conducted Power (Carrier Power / Power Density)
Measuring Uncertainty for a Level of Confidence of 95% ($U=2Uc(y)$): $\pm 0.84\text{dB}$
Conducted Spurious Emission
Measuring Uncertainty for a Level of Confidence of 95% ($U=2Uc(y)$): $\pm 2.65\text{ dB}$
Occupied Bandwidth
Measuring Uncertainty for a Level of Confidence of 95% ($U=2Uc(y)$): $\pm 3.3\%$
Temp. / Humidity
Measuring Uncertainty for a Level of Confidence of 95% ($U=2Uc(y)$): $\pm 0.82^\circ\text{C} / \pm 3\%$

7. TEST RESULT

7.1. Summary

FCC Section(s)	Test Description	Test Limit	Test Condition	Test Result	Reference
15.247(a)(2)	6dB Bandwidth	$\geq 500\text{kHz}$	Conducted	Pass	Section 7.2
15.247(b)(3)	Output Power	$\leq 30\text{dBm}$		Pass	Section 7.3
15.247(e)	Power Spectral Density	$\leq 8\text{dBm}/3\text{kHz}$		Pass	Section 7.4
15.247(d)	Band Edge / Out-of-Band Emissions	$\geq 30\text{dBc}$ (Average)		Pass	Section 7.5
15.205 15.209	General Field Strength Limits (Restricted Bands and Radiated Emission Limits)	Emissions in restricted bands must meet the radiated limits detailed in 15.209	Radiated	Pass	Section 7.6 & 7.7
15.207	AC Conducted Emissions 150kHz - 30MHz	< FCC 15.207 limits	Line Conducted	Pass	Section 7.8

Notes:

- 1) Determining compliance is based on the test results met the regulation limits or requirements declared by clients, and the test results don't take into account the value of measurement uncertainty.
- 2) The analyzer plots shown in this section were all taken with a correction table loaded into the analyzer. The correction table was used to account for the losses of the cables and attenuators used as part of the system to connect the EUT to the analyzer at all frequencies of interest.
- 3) For radiated emission test, every axis (X, Y, Z) was also verified. The test results shown in the following sections represent the worst-case emissions.

7.2. 6dB Bandwidth Measurement

7.2.1. Test Limit

The minimum 6dB bandwidth shall be at least 500 kHz.

7.2.2. Test Procedure used

ANSI C63.10 - 2013 Section 11.8

7.2.3. Test Setting

1. The Spectrum's automatic bandwidth measurement capability was used to perform the 6dB bandwidth measurement. The "X" dB bandwidth parameter was set to $X = 6$. The bandwidth measurement was not influenced by any intermediate power nulls in the fundamental emission.
2. Set RBW = 100 kHz
3. VBW $\geq 3 \times$ RBW
4. Detector = Peak
5. Trace mode = max hold
6. Sweep = auto couple
7. Allow the trace was allowed to stabilize

7.2.4. Test Setup

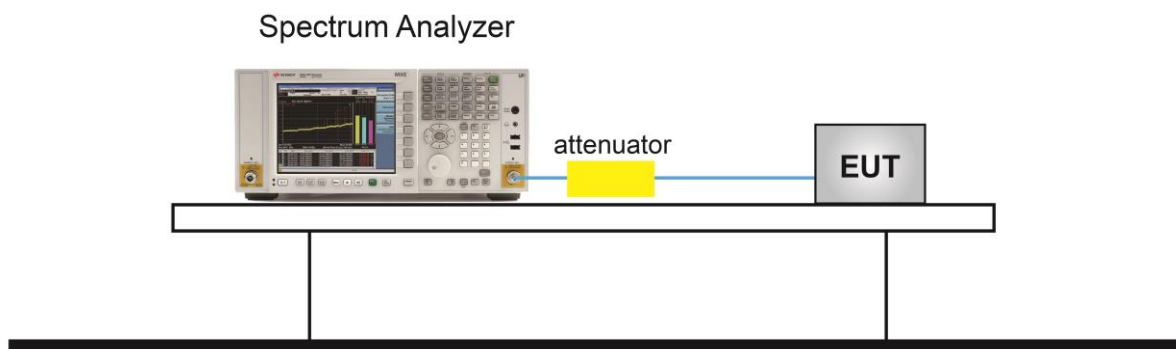

7.2.5. Test Result

Product	Pan/Tilt AI Home Security Wi-Fi Camera	Temperature	25°C
Test Engineer	Wen	Relative Humidity	54%
Test Site	SR6	Test Date	2023/5/16

Test Mode	Data Rate / MCS	Channel No.	Frequency (MHz)	6dB Bandwidth (MHz)	Limit (MHz)	Result
802.11b	1Mbps	01	2412	8.584	≥ 0.5	Pass
802.11b	1Mbps	06	2437	9.028	≥ 0.5	Pass
802.11b	1Mbps	11	2462	8.562	≥ 0.5	Pass
802.11g	6Mbps	01	2412	16.370	≥ 0.5	Pass
802.11g	6Mbps	06	2437	16.350	≥ 0.5	Pass
802.11g	6Mbps	11	2462	16.360	≥ 0.5	Pass
802.11n-HT20	MCS0	01	2412	17.550	≥ 0.5	Pass
802.11n-HT20	MCS0	06	2437	17.310	≥ 0.5	Pass
802.11n-HT20	MCS0	11	2462	17.290	≥ 0.5	Pass

802.11b 6dB Bandwidth

Channel 01 (2412MHz)

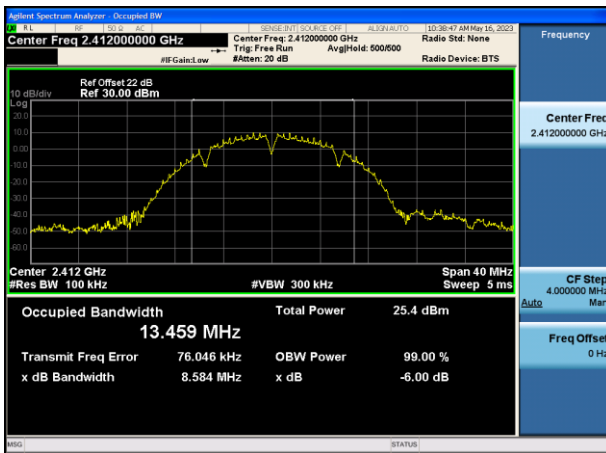

Channel 06 (2437MHz)

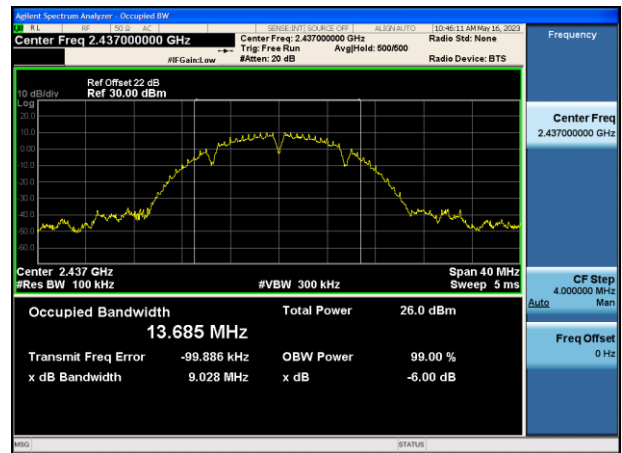

Channel 11 (2462MHz)

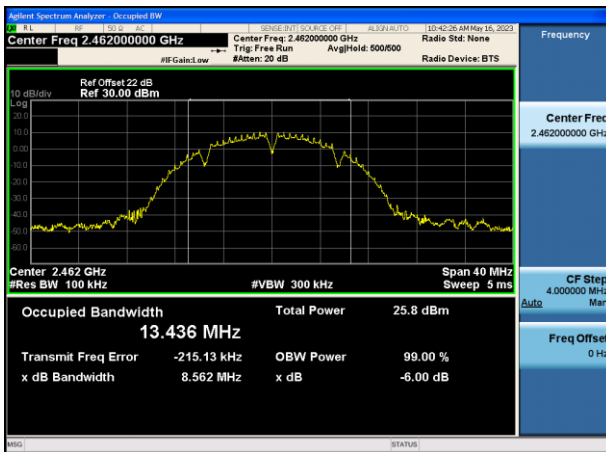

802.11g 6dB Bandwidth

Channel 01 (2412MHz)

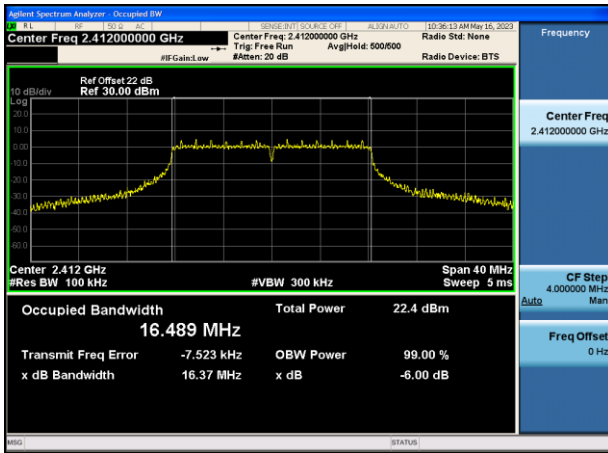

Channel 06 (2437MHz)

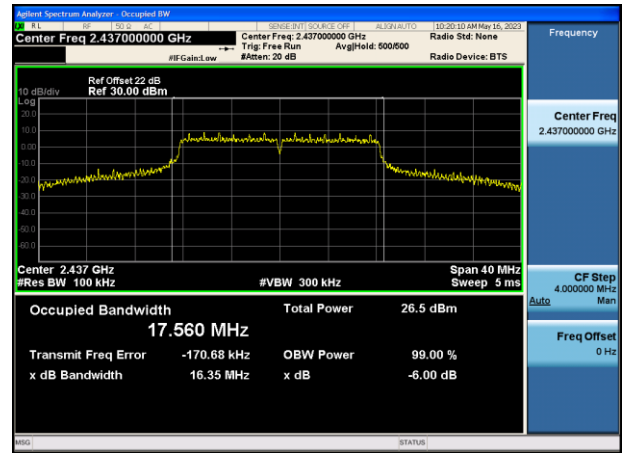

Channel 11 (2462MHz)

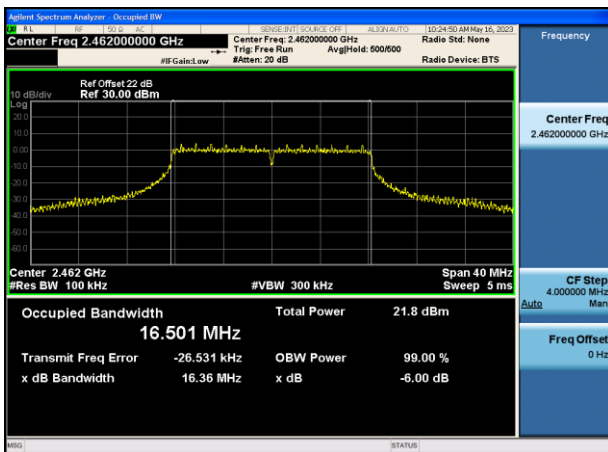

802.11n-HT20 6dB Bandwidth

Channel 01 (2412MHz)

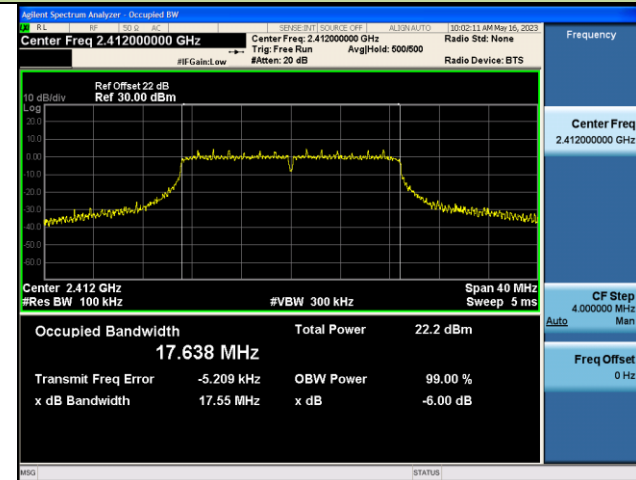

Channel 06 (2437MHz)

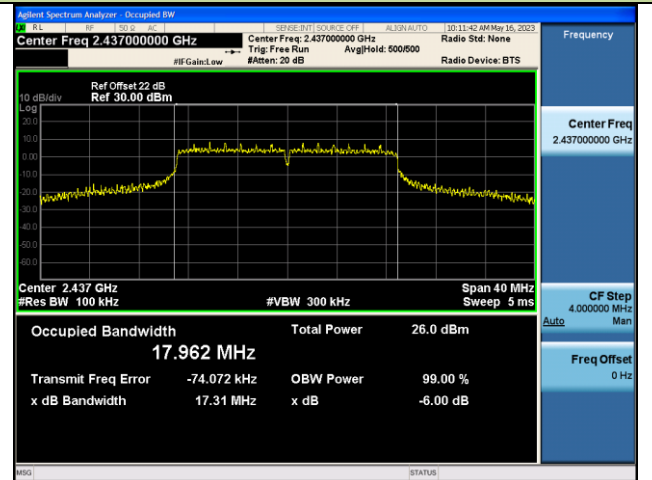

Channel 11 (2462MHz)

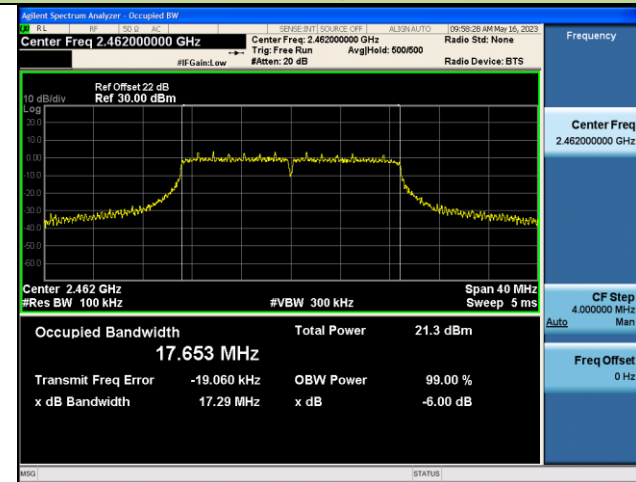

7.3. Output Power Measurement

7.3.1. Test Limit

The maximum output power shall be less 1 Watt (30dBm).

The conducted output power limit specified in paragraph FCC Part 15.247(b) of this section is based on the use of antennas with directional gains that do not exceed 6 dBi. If transmitting antennas of directional gain greater than 6 dBi are used, the conducted output power from the intentional radiator shall be reduced below the stated values in paragraphs FCC Part 15.247(b)(3) of this section, as appropriate, by the amount in dB that the directional gain of the antenna exceeds 6 dBi.

7.3.2. Test Procedure Used

ANSI C63.10 - 2013 Section 11.9.2.3.2

7.3.3. Test Setting

Average Power Measurement

Average power measurements were performed only when the EUT was transmitting at its maximum power control level using a broadband power meter with a pulse sensor. The power meter implemented triggering and gating capabilities which were set up such that power measurements were recorded only during the ON time of the transmitter.

7.3.4. Test Setup

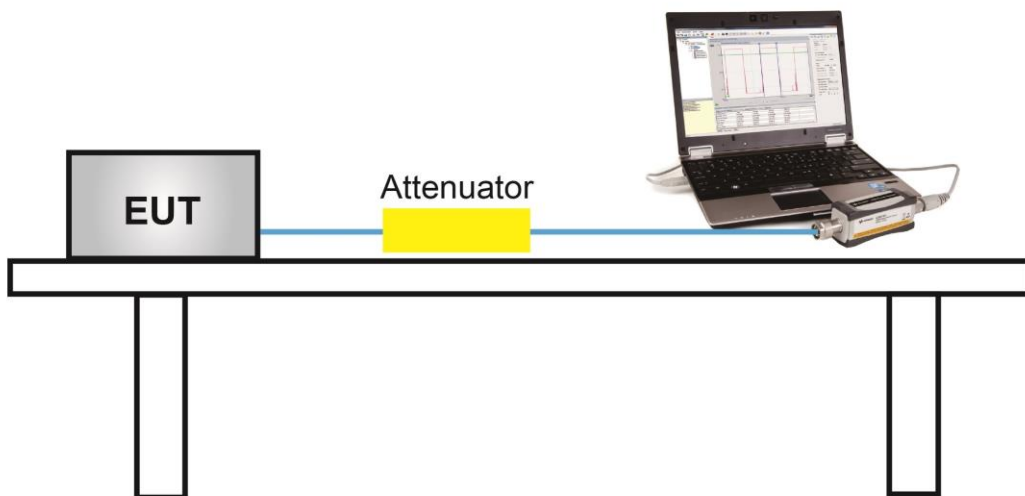

7.3.5. Test Result

Product	Pan/Tilt AI Home Security Wi-Fi Camera	Temperature	25°C
Test Engineer	Wen	Relative Humidity	54%
Test Site	SR6	Test Date	2023/5/9

Test Mode	Data Rate/ MCS	Channel No.	Freq. (MHz)	Average Power (dBm)	Limit (dBm)	Result
802.11b	1Mbps	01	2412	19.29	≤ 30.00	Pass
802.11b	1Mbps	06	2437	20.12	≤ 30.00	Pass
802.11b	1Mbps	11	2462	20.08	≤ 30.00	Pass
802.11g	6Mbps	01	2412	16.72	≤ 30.00	Pass
802.11g	6Mbps	06	2437	18.93	≤ 30.00	Pass
802.11g	6Mbps	11	2462	15.97	≤ 30.00	Pass
802.11n-HT20	MCS0	01	2412	16.64	≤ 30.00	Pass
802.11n-HT20	MCS0	06	2437	18.67	≤ 30.00	Pass
802.11n-HT20	MCS0	11	2462	15.77	≤ 30.00	Pass

7.4. Power Spectral Density Measurement

7.4.1. Test Limit

The maximum permissible power spectral density is 8dBm in any 3 kHz band.

The same method of determining the conducted output power shall be used to determine the power spectral density.

7.4.2. Test Procedure Used

ANSI C63.10 - 2013 Section 11.10.5

7.4.3. Test Setting

1. Measure the duty cycle (x) of the transmitter output signal.
2. Set instrument center frequency to DTS channel center frequency.
3. Set span to at least 1.5 times the OBW.
4. RBW = 10 kHz.
5. VBW = 30 kHz.
6. Detector = RMS.
7. Ensure that the number of measurement points in the sweep $\geq 2 \times \text{span}/\text{RBW}$.
8. Sweep time = auto couple.
9. Don't use sweep triggering. Allow sweep to "free run".
10. Employ trace averaging (RMS) mode over a minimum of 100 traces.
11. Use the peak marker function to determine the maximum amplitude level.
12. Add $10 \log (1/x)$, where x is the duty cycle measured in step (a), to the measured PSD to compute the average PSD during the actual transmission time.

7.4.4. Test Setup

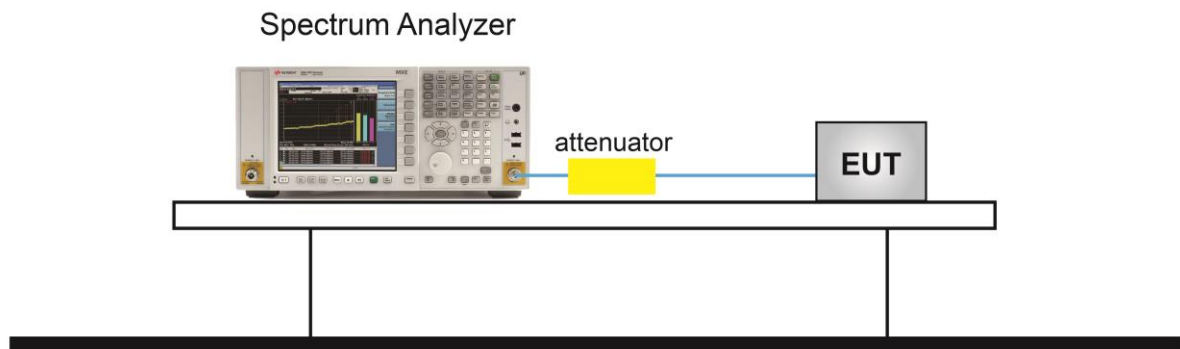

7.4.5. Test Result

Product	Pan/Tilt AI Home Security Wi-Fi Camera	Temperature	25°C
Test Engineer	Wen	Relative Humidity	54%
Test Site	SR6	Test Date	2023/5/16

Test Mode	Data Rate/ MCS	Channel No.	Freq. (MHz)	Ant 0 PSD (dBm/ 10kHz)	Duty Cycle (%)	Total PSD (dBm/ 10kHz)	Limit (dBm/ 3kHz)	Result
802.11b	1Mbps	01	2412	-6.751	99.27%	-6.719	≤ 8.00	Pass
802.11b	1Mbps	06	2437	-6.323	99.27%	-6.291	≤ 8.00	Pass
802.11b	1Mbps	11	2462	-6.147	99.27%	-6.115	≤ 8.00	Pass
802.11g	6Mbps	01	2412	-11.962	90.62%	-11.534	≤ 8.00	Pass
802.11g	6Mbps	06	2437	-8.013	90.62%	-7.585	≤ 8.00	Pass
802.11g	6Mbps	11	2462	-12.298	90.62%	-11.870	≤ 8.00	Pass
802.11n-HT20	MCS0	01	2412	-12.287	89.54%	-11.807	≤ 8.00	Pass
802.11n-HT20	MCS0	06	2437	-8.875	89.54%	-8.395	≤ 8.00	Pass
802.11n-HT20	MCS0	11	2462	-13.286	89.54%	-12.806	≤ 8.00	Pass

Note: Total AVGPSSD = PSD + 10*log (1/Duty Cycle).

802.11b AVGPSD

Channel 01 (2412MHz)

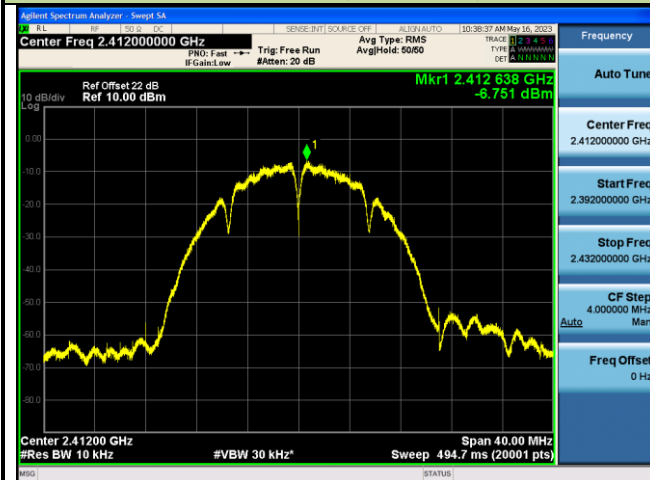

Channel 06 (2437MHz)

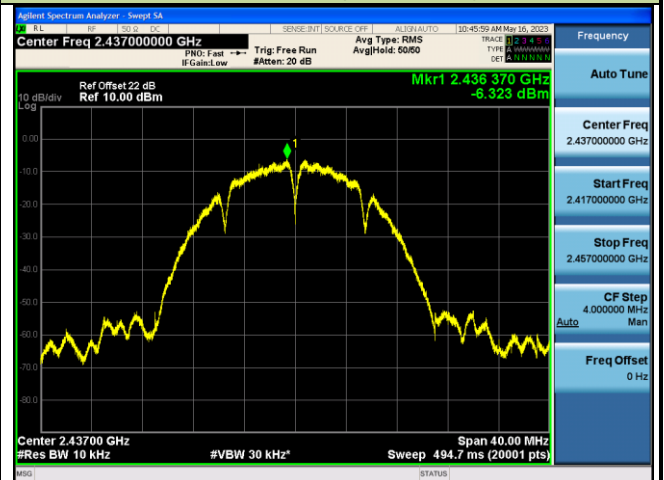

Channel 11 (2462MHz)

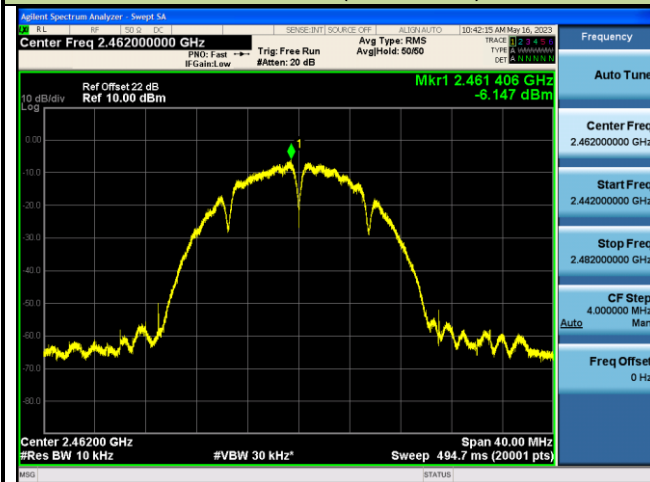

802.11g AVGPSD

Channel 01 (2412MHz)

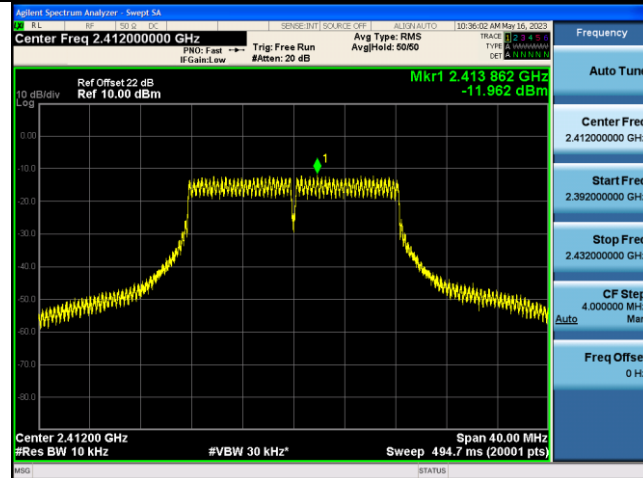

Channel 06 (2437MHz)

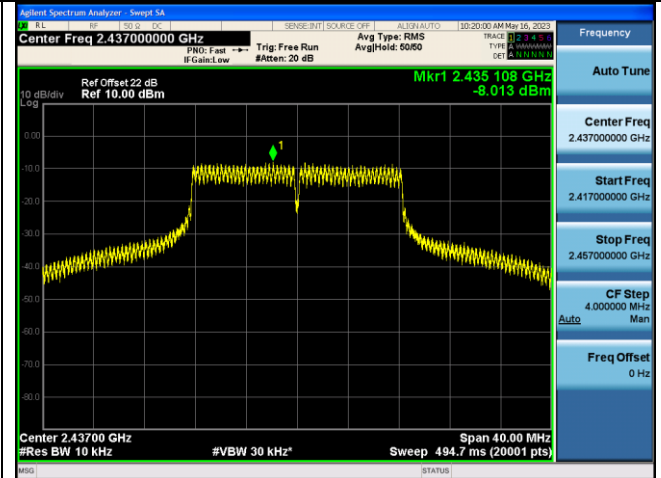

Channel 11 (2462MHz)

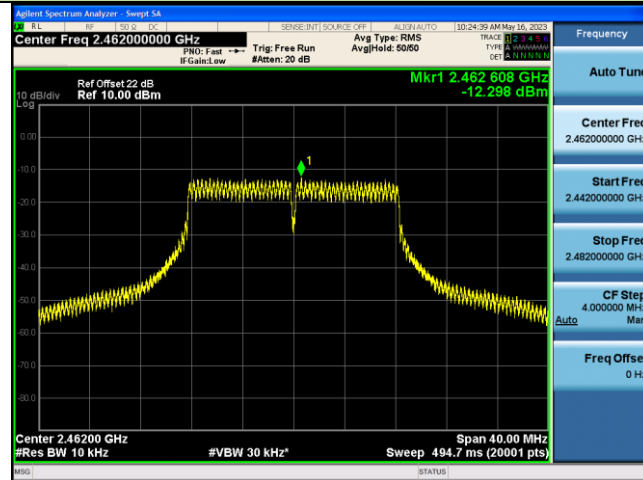

802.11n-HT20 AVGPSPD

Channel 01 (2412MHz)

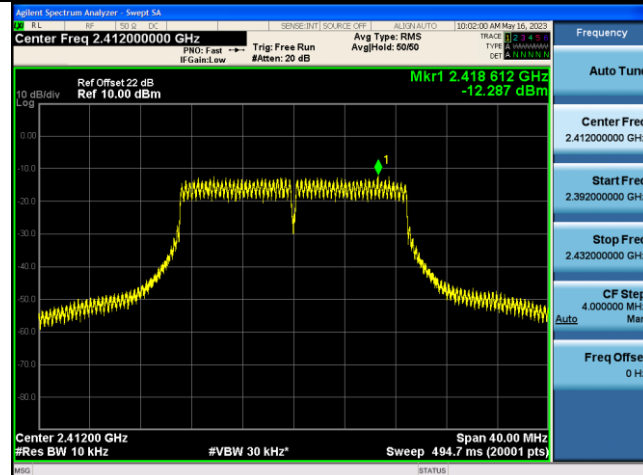

Channel 06 (2437MHz)

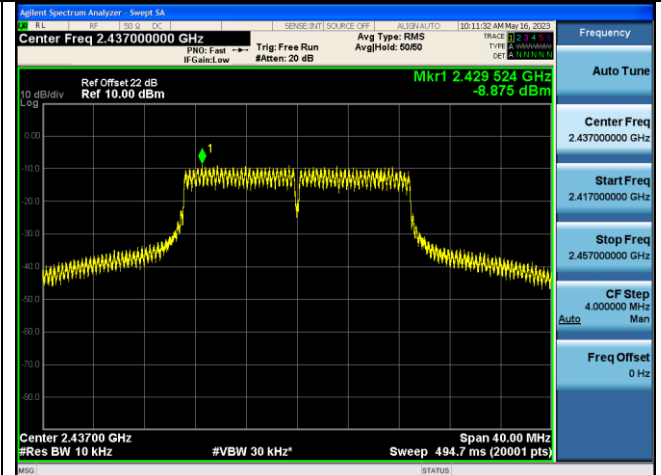

Channel 11 (2462MHz)

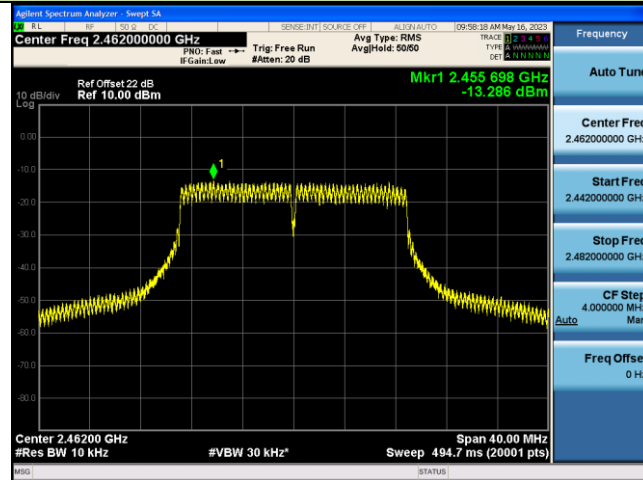

7.5. Conducted Band Edge and Out-of-Band Emissions

7.5.1. Test Limit

The limit for out-of-band spurious emissions at the band edge is 30dB below the fundamental emission level, as determined from the in-band power measurement of the DTS channel performed in a 100 kHz bandwidth per the PSD procedure.

7.5.2. Test Procedure Used

ANSI C63.10 - 2013 Section 11.11

7.5.3. Test Setting

Reference level measurement

1. Set instrument center frequency to DTS channel center frequency
2. Set the span to ≥ 1.5 times the DTS bandwidth
3. Set the RBW = 100 kHz
4. Set the VBW $\geq 3 \times$ RBW
5. Detector = peak
6. Sweep time = auto couple
7. Trace mode = max hold
8. Allow trace to fully stabilize

Emission level measurement

1. Set the center frequency and span to encompass frequency range to be measured
2. RBW = 100kHz
3. VBW = 300kHz
4. Detector = Peak
5. Trace mode = max hold
6. Sweep time = auto couple
7. The trace was allowed to stabilize

7.5.4. Test Setup

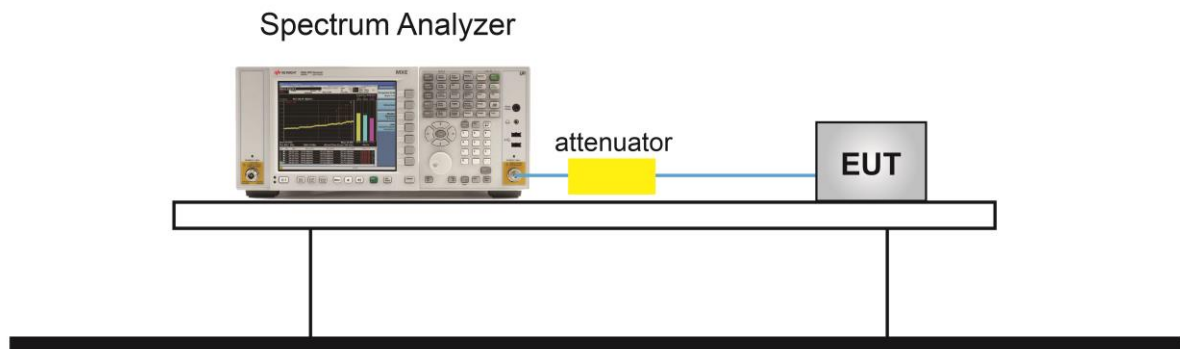

7.5.5. Test Result

Product	Pan/Tilt AI Home Security Wi-Fi Camera	Temperature	25°C
Test Engineer	Wen	Relative Humidity	54%
Test Site	SR6	Test Date	2023/5/16

Test Mode	Data Rate / MCS	Channel No.	Frequency (MHz)	Limit (dBc)	Result
802.11b	1Mbps	01	2412	30	Pass
802.11b	1Mbps	06	2437	30	Pass
802.11b	1Mbps	11	2462	30	Pass
802.11g	6Mbps	01	2412	30	Pass
802.11g	6Mbps	06	2437	30	Pass
802.11g	6Mbps	11	2462	30	Pass
802.11n-HT20	MCS0	01	2412	30	Pass
802.11n-HT20	MCS0	06	2437	30	Pass
802.11n-HT20	MCS0	11	2462	30	Pass

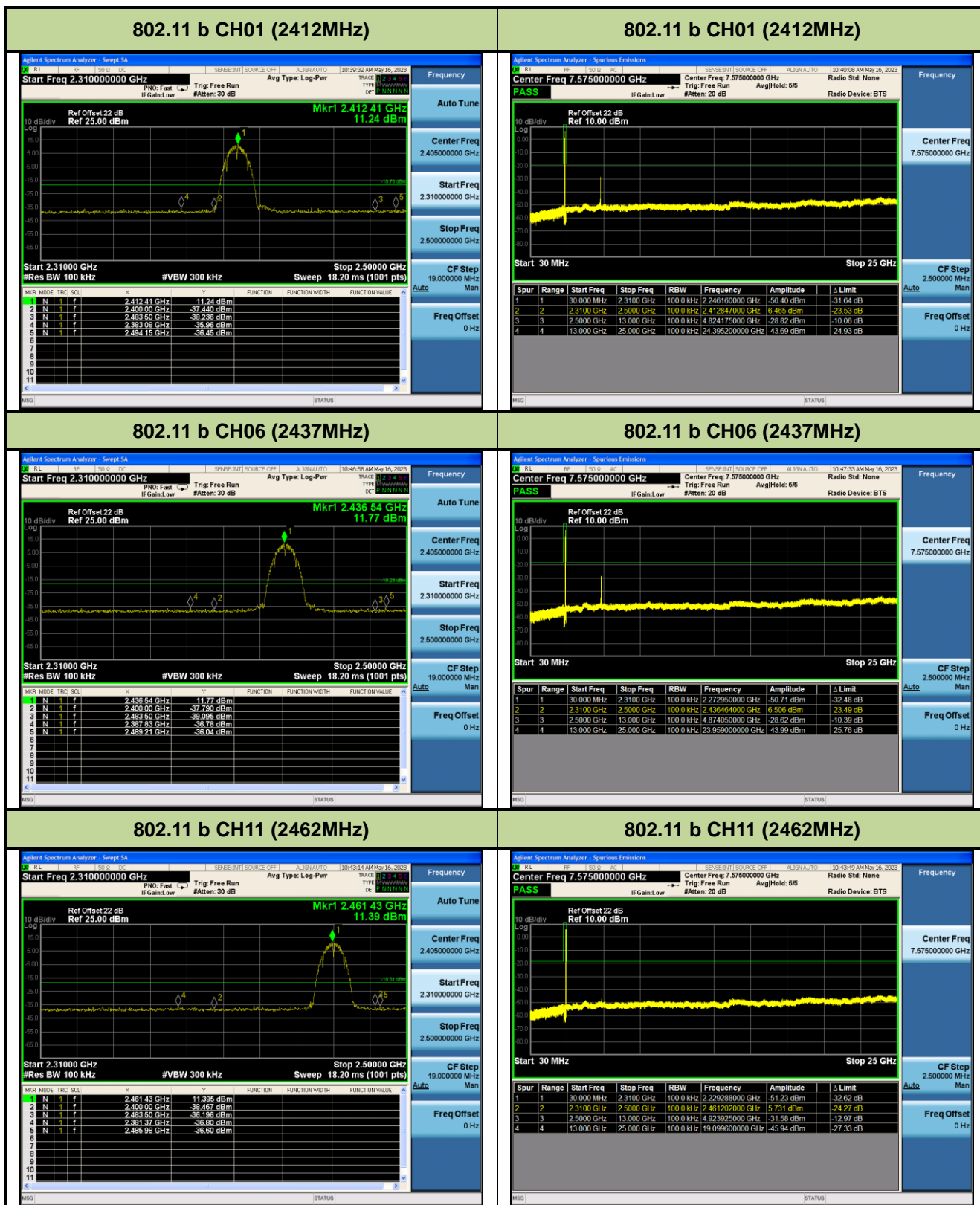

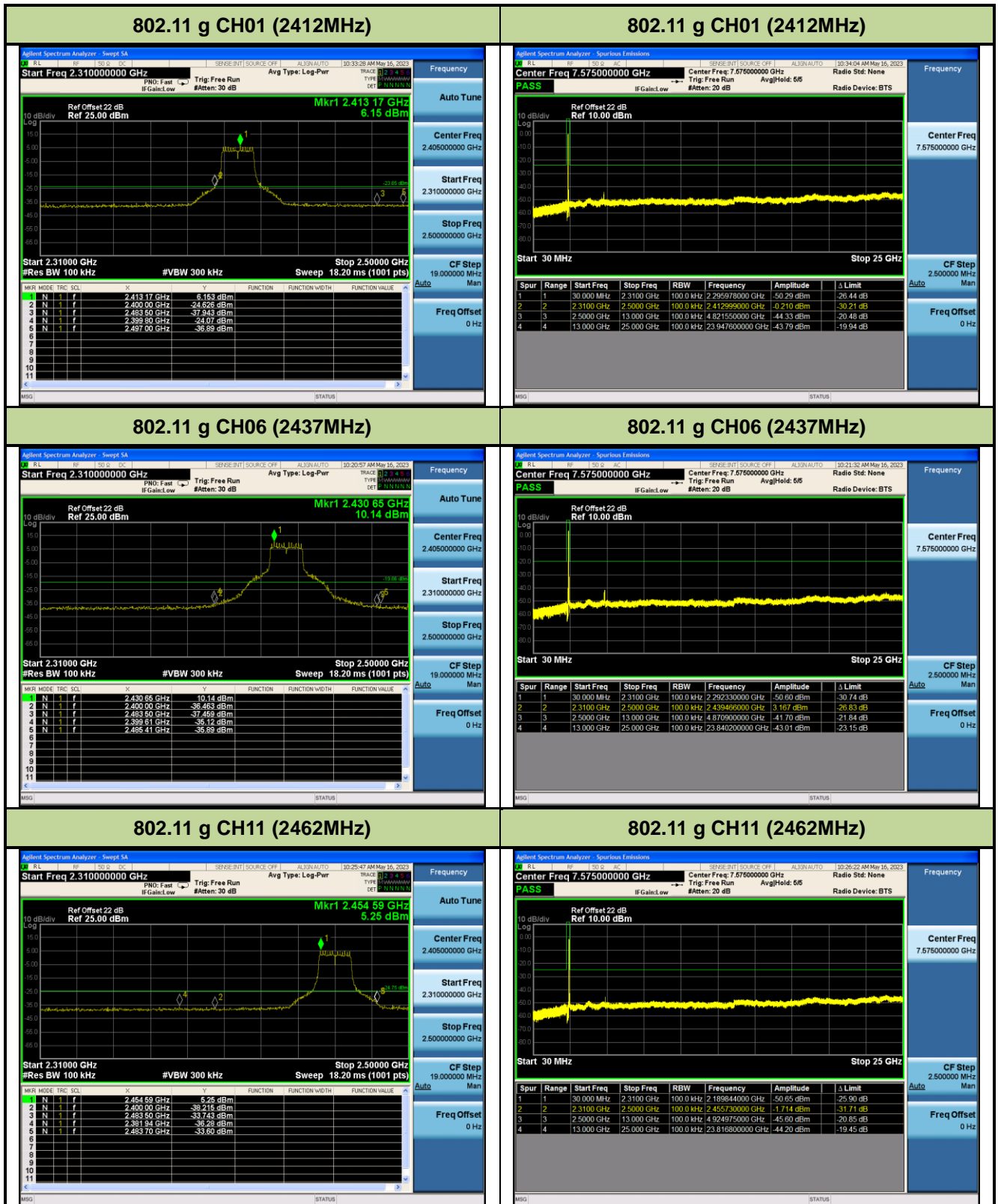

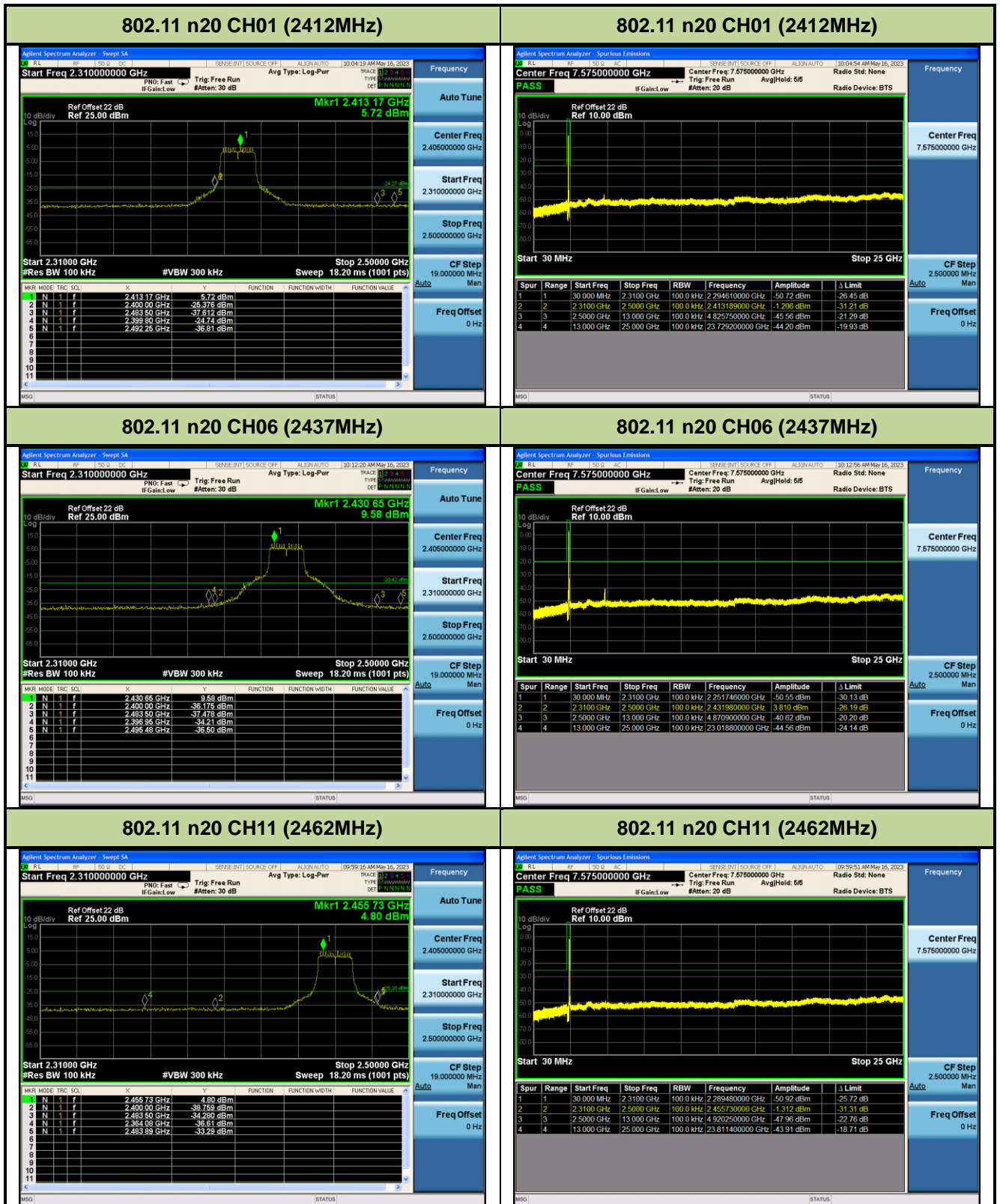

7.6. Radiated Spurious Emission Measurement

7.6.1. Test Limit

All out of band emissions appearing in a restricted band as specified in Section 15.205 of the Title 47CFR must not exceed the limits shown in Table per Section 15.209.

FCC Part 15 Subpart C Paragraph 15.209		
Frequency [MHz]	Field Strength [Uv/m]	Measured Distance [Meters]
0.009 - 0.490	2400/F (kHz)	300
0.490 - 1.705	24000/F (kHz)	30
1.705 - 30	30	30
30 - 88	100	3
88 - 216	150	3
216 - 960	200	3
Above 960	500	3

7.6.2. Test Procedure Used

ANSI C63.10 - 2013 Section 6.3 (General Requirements)

ANSI C63.10 - 2013 Section 6.4 (Standard test method below 30MHz)

ANSI C63.10 - 2013 Section 6.5 (Standard test method above 30MHz to 1GHz)

ANSI C63.10 - 2013 Section 6.6 (Standard test method above 1GHz)

7.6.3. Test Setting

Table 1 - RBW as a function of frequency

Frequency	RBW
9 ~ 150 kHz	200 ~ 300 Hz
0.15 ~ 30 MHz	9 ~ 10 kHz
30 ~ 1000 MHz	100 ~ 120 kHz
> 1000MHz	1MHz

Quasi-Peak Measurements below 1GHz

1. Analyzer center frequency was set to the frequency of the radiated spurious emission of interest
2. Span was set greater than 1MHz
3. RBW = as specified in Table 1
4. Detector = CISPR quasi-peak
5. Sweep time = auto couple
6. Trace was allowed to stabilize

Peak Measurements above 1GHz

1. Analyzer center frequency was set to the frequency of the radiated spurious emission of interest
2. RBW = 1MHz
3. VBW = 3MHz
4. Detector = peak
5. Sweep time = auto couple
6. Trace mode = max hold
7. Trace was allowed to stabilize

Average Measurements above 1GHz (Method VB)

1. Analyzer center frequency was set to the frequency of the radiated spurious emission of interest
2. RBW = 1MHz
3. VBW; If the EUT is configured to transmit with duty cycle $\geq 98\%$, set VBW = 10 Hz.
If the EUT duty cycle is $< 98\%$, set VBW $\geq 1/T$. T is the minimum transmission duration.
4. Detector = Peak
5. Sweep time = auto
6. Trace mode = max hold
7. Trace was allowed to stabilize

7.6.4. Test Setup

Below 1GHz Test Setup:

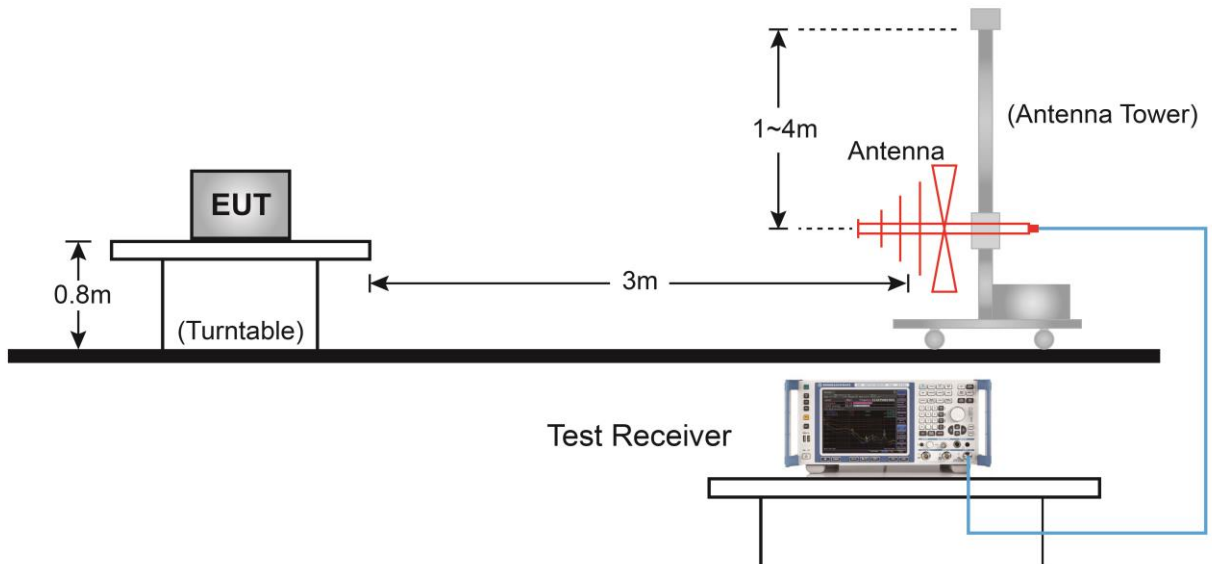

Above 1GHz Test Setup:

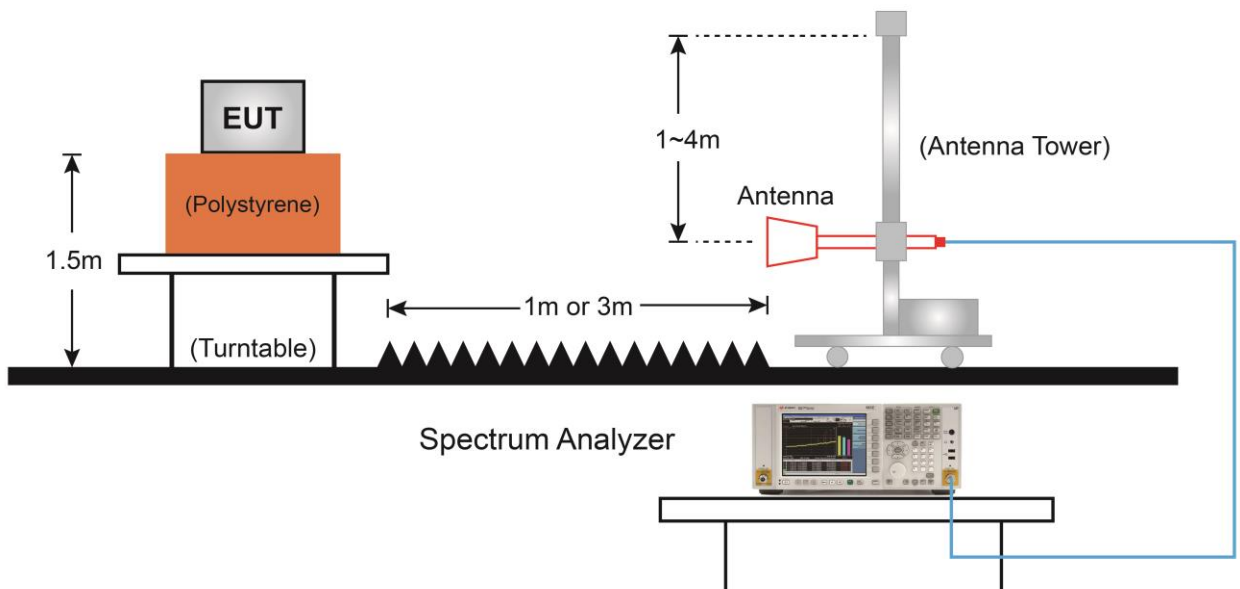

7.6.5. Test Result

EUT	Pan/Tilt AI Home Security Wi-Fi Camera	Date of Test	2023-05-11
Factor	VULB 9162	Temp. / Humidity	24°C /59%
Polarity	Horizontal	Site / Test Engineer	AC1 / Todd
Test Mode	802.11n-20MHz_TX_CH 6_ANT 0	Test Voltage	AC 120V/60Hz

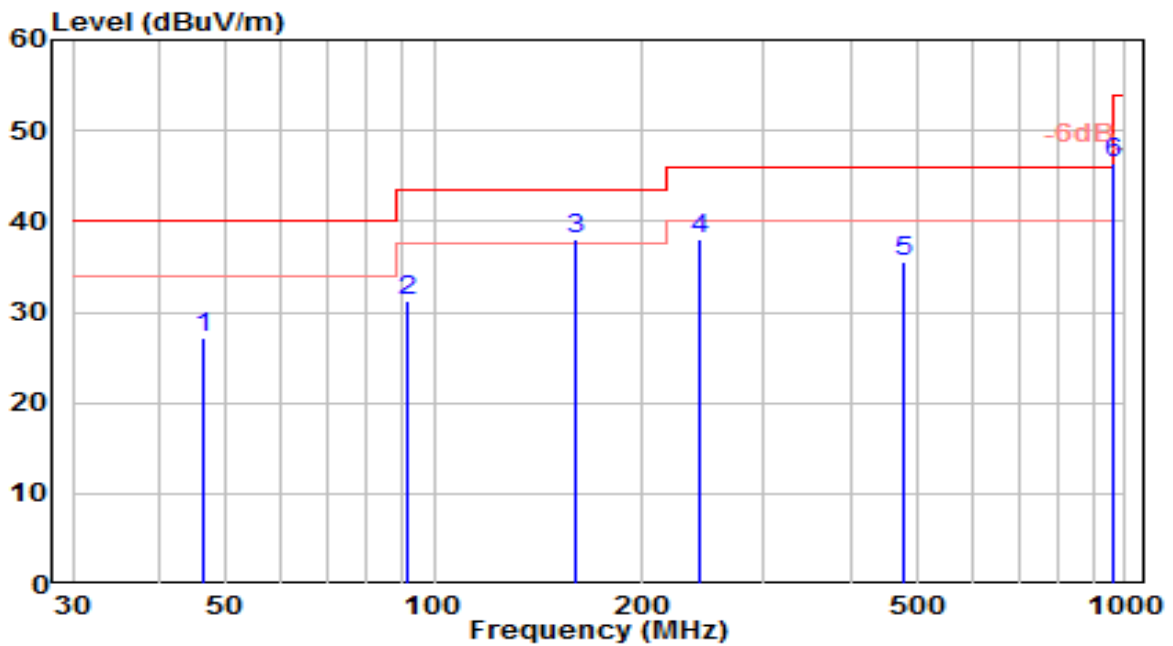

No	Frequency (MHz)	Reading (dBuV)	C.F (dB/m)	Measurement (dBuV/m)	Margin (dB)	Limit (dBuV/m)	Height (cm)	Angle (deg)	Remark (QP/PK/AV)
1	46.490	6.35	20.71	27.06	-12.94	40.00	100	290	QP
2	91.110	14.08	17.19	31.27	-12.23	43.50	100	260	QP
3	* 159.980	22.31	15.82	38.12	-5.38	43.50	100	70	QP
4	241.460	18.10	19.97	38.07	-7.93	46.00	100	260	QP
5	480.080	10.46	24.99	35.45	-10.55	46.00	100	100	QP
6	960.230	14.32	32.06	46.38	-7.62	54.00	100	175	QP

Note:

1. " *", means this data is the worst emission level.
2. C.F (Correction Factor) = Antenna Factor (dB/m)+ Cable Loss (dB).
3. Measurement (dBuV/m) = Reading(dBuV) + C.F (Correction Factor).
4. The emission levels of other frequencies are very lower than the limit and not show in test report.

EUT	Pan/Tilt AI Home Security Wi-Fi Camera	Date of Test	2023-05-11
Factor	VULB 9162	Temp. / Humidity	24°C /59%
Polarity	Vertical	Site / Test Engineer	AC1 / Todd
Test Mode	802.11n-20MHz_TX_CH 6_ANT 0	Test Voltage	AC 120V/60Hz

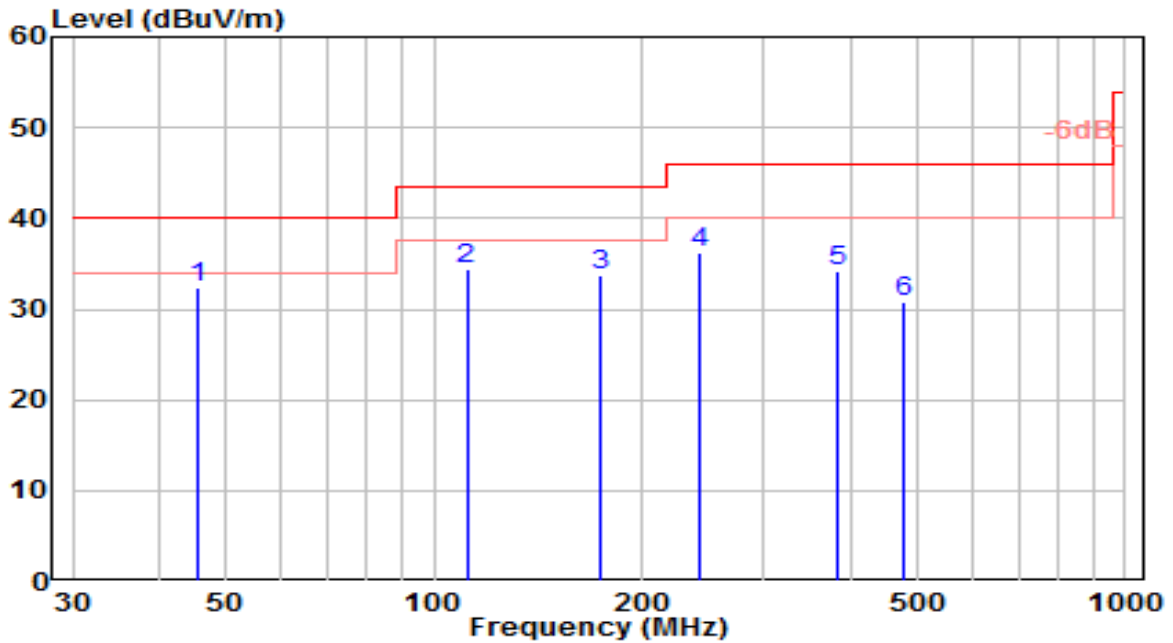

No	Frequency (MHz)	Reading (dBUV)	C.F (dB/m)	Measurement (dBUV/m)	Margin (dB)	Limit (dBUV/m)	Height (cm)	Angle (deg)	Remark (QP/PK/AV)
1	* 45.520	11.72	20.64	32.36	-7.64	40.00	100	245	QP
2	111.480	16.32	18.19	34.52	-8.98	43.50	100	285	QP
3	173.560	17.41	16.24	33.64	-9.86	43.50	100	65	QP
4	241.460	16.25	19.97	36.21	-9.79	46.00	100	120	QP
5	382.110	10.80	23.46	34.26	-11.74	46.00	100	190	QP
6	480.080	5.78	24.99	30.77	-15.23	46.00	100	320	QP

Note:

1. " *", means this data is the worst emission level.
2. C.F (Correction Factor) = Antenna Factor (dB/m)+ Cable Loss (dB).
3. Measurement (dBUV/m) = Reading(dBUV) + C.F (Correction Factor).
4. The emission levels of other frequencies are very lower than the limit and not show in test report.

EUT	Pan/Tilt AI Home Security Wi-Fi Camera	Date of Test	2023-05-16
Factor	BBHA 9120D	Temp. / Humidity	24°C /59%
Polarity	Horizontal	Site / Test Engineer	AC1 / Todd
Test Mode	802.11b_TX_CH 1_ANT 0	Test Voltage	AC 120V/60Hz

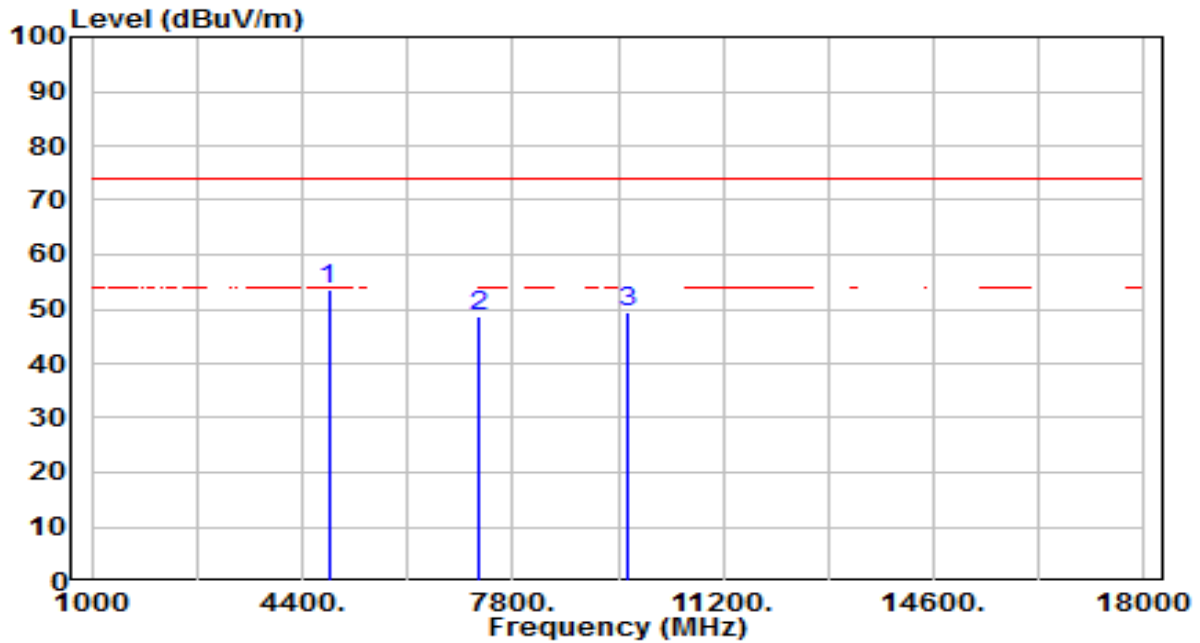

No	Frequency (MHz)	Reading (dBuV)	C.F (dB/m)	Measurement (dBuV/m)	Margin (dB)	Limit (dBuV/m)	Height (cm)	Angle (deg)	Remark (QP/PK/AV)
1	*	49.48	3.91	53.40	-20.60	74.00	150	360	Peak
2		36.92	11.94	48.86	-25.14	74.00	150	360	Peak
3		33.48	15.79	49.27	-24.73	74.00	150	360	Peak

Note:

1. " *", means this data is the worst emission level.
2. C.F (Correction Factor) = Antenna Factor (dB/m)+ Cable Loss (dB) – Pre-amplifier(dB).
3. Measurement (dBuV/m) = Reading(dBuV) + C.F (Correction Factor).
4. The emission levels of other frequencies are very lower than the limit and not show in test report.

EUT	Pan/Tilt AI Home Security Wi-Fi Camera	Date of Test	2023-05-16
Factor	BBHA 9120D	Temp. / Humidity	24°C /59%
Polarity	Vertical	Site / Test Engineer	AC1 / Todd
Test Mode	802.11b_TX_CH 1_ANT 0	Test Voltage	AC 120V/60Hz

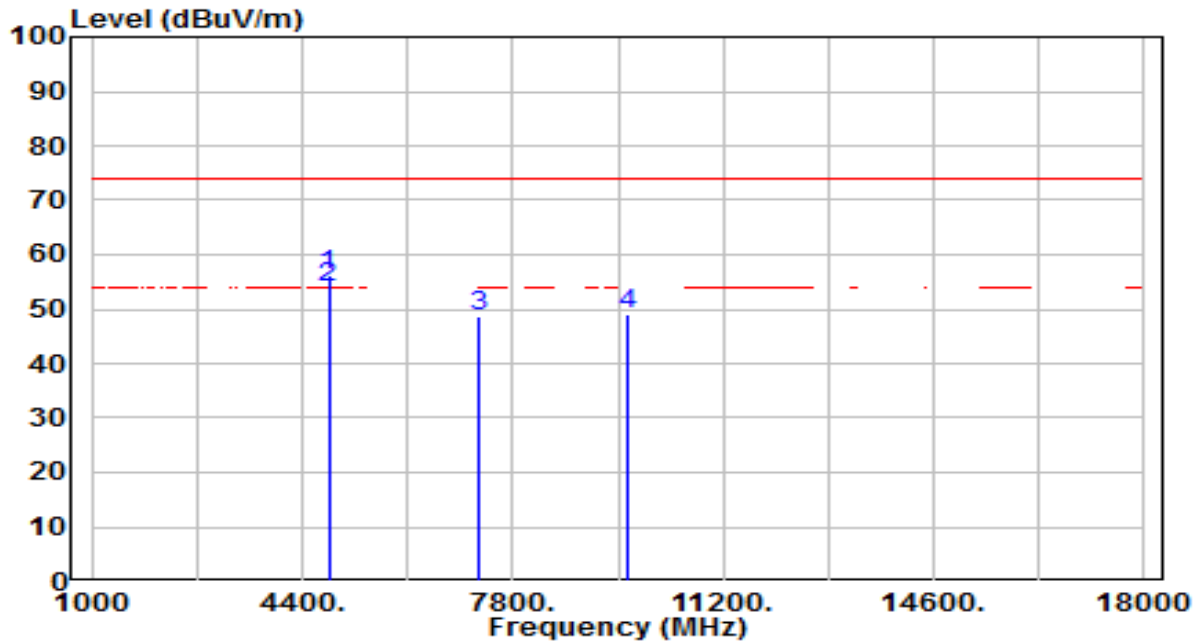

No	Frequency (MHz)	Reading (dBuV)	C.F (dB/m)	Measurement (dBuV/m)	Margin (dB)	Limit (dBuV/m)	Height (cm)	Angle (deg)	Remark (QP/PK/AV)	
1	*	4824.000	52.40	3.91	56.31	-17.69	74.00	122	122	Peak
2	*	4824.000	50.00	3.91	53.91	-0.09	54.00	122	122	Average
3		7236.000	36.71	11.94	48.65	-25.35	74.00	150	360	Peak
4		9648.000	33.34	15.79	49.13	-24.87	74.00	150	360	Peak

Note:

- "*" means this data is the worst emission level.
- C.F (Correction Factor) = Antenna Factor (dB/m)+ Cable Loss (dB) – Pre-amplifier(dB).
- Measurement (dBuV/m) = Reading(dBuV) + C.F (Correction Factor).
- The emission levels of other frequencies are very lower than the limit and not show in test report.

EUT	Pan/Tilt AI Home Security Wi-Fi Camera	Date of Test	2023-06-09
Factor	BBHA 9120D	Temp. / Humidity	24°C /51%
Polarity	Horizontal	Site / Test Engineer	AC1 / Kaunaz
Test Mode	802.11b_TX_CH 6_ANT 0	Test Voltage	AC 120V/60Hz

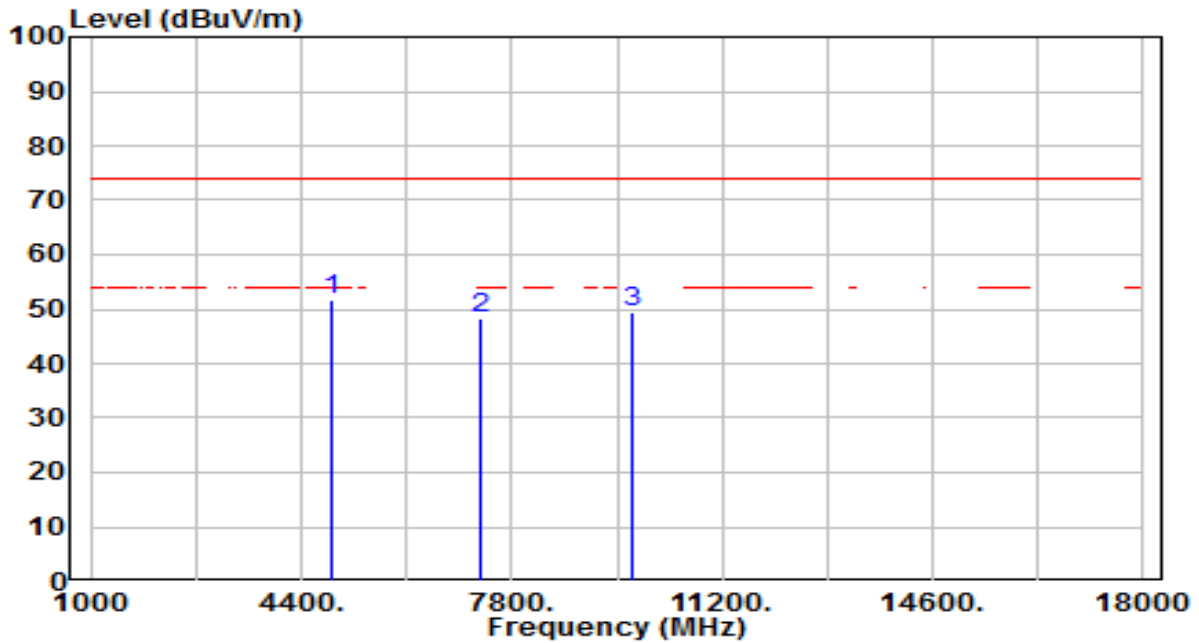

No	Frequency (MHz)	Reading (dBuV)	C.F (dB/m)	Measurement (dBuV/m)	Margin (dB)	Limit (dBuV/m)	Height (cm)	Angle (deg)	Remark (QP/PK/AV)
1	*	47.73	4.02	51.75	-22.25	74.00	150	360	Peak
2		36.26	12.20	48.46	-25.54	74.00	150	360	Peak
3		33.57	16.01	49.58	-24.42	74.00	150	360	Peak

Note:

1. "*" , means this data is the worst emission level.
2. C.F (Correction Factor) = Antenna Factor (dB/m)+ Cable Loss (dB) – Pre-amplifier(dB).
3. Measurement (dBuV/m) = Reading(dBuV) + C.F (Correction Factor).
4. The emission levels of other frequencies are very lower than the limit and not show in test report.

EUT	Pan/Tilt AI Home Security Wi-Fi Camera	Date of Test	2023-06-09
Factor	BBHA 9120D	Temp. / Humidity	24°C /51%
Polarity	Vertical	Site / Test Engineer	AC1 / Kaunaz
Test Mode	802.11b_TX_CH 6_ANT 0	Test Voltage	AC 120V/60Hz

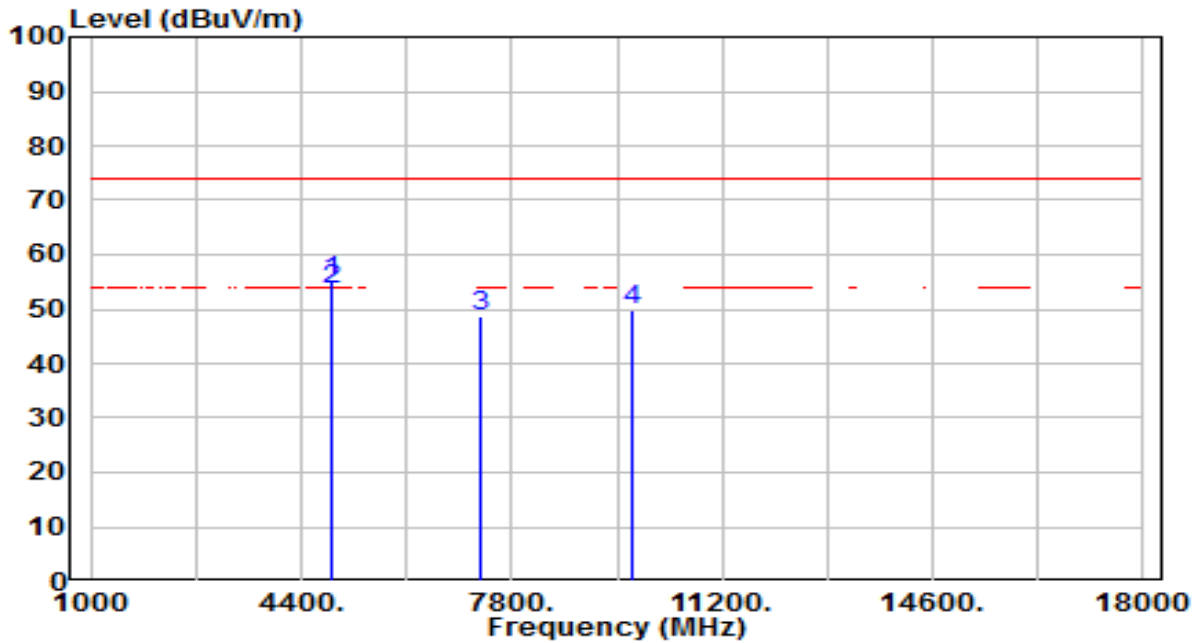

No	Frequency (MHz)	Reading (dBuV)	C.F (dB/m)	Measurement (dBuV/m)	Margin (dB)	Limit (dBuV/m)	Height (cm)	Angle (deg)	Remark (QP/PK/AV)	
1	*	4874.000	50.95	4.02	54.97	-19.03	74.00	172	78	Peak
2	*	4874.000	49.63	4.02	53.65	-0.35	54.00	172	78	Average
3		7311.000	36.48	12.20	48.68	-25.32	74.00	150	360	Peak
4		9748.000	33.80	16.01	49.81	-24.19	74.00	150	360	Peak

Note:

1. " *", means this data is the worst emission level.
2. C.F (Correction Factor) = Antenna Factor (dB/m)+ Cable Loss (dB) – Pre-amplifier(dB).
3. Measurement (dBuV/m) = Reading(dBuV) + C.F (Correction Factor).
4. The emission levels of other frequencies are very lower than the limit and not show in test report.

EUT	Pan/Tilt AI Home Security Wi-Fi Camera	Date of Test	2023-05-16
Factor	BBHA 9120D	Temp. / Humidity	24°C /59%
Polarity	Horizontal	Site / Test Engineer	AC1 / Todd
Test Mode	802.11b_TX_CH 11_ANT 0	Test Voltage	AC 120V/60Hz

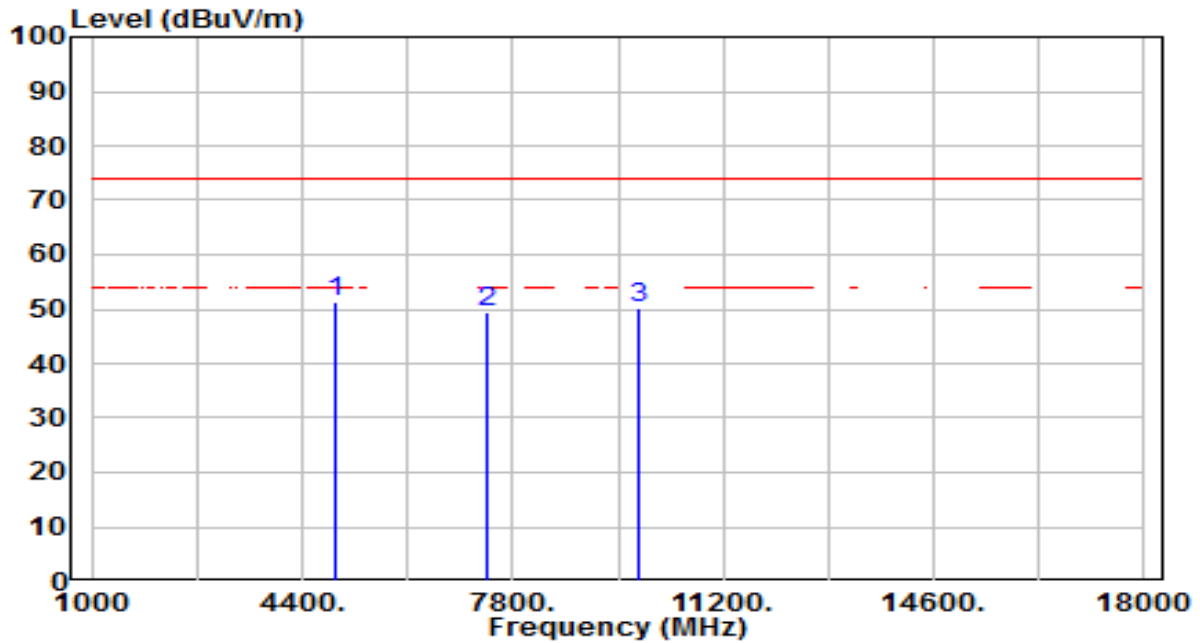

No	Frequency (MHz)	Reading (dBuV)	C.F (dB/m)	Measurement (dBuV/m)	Margin (dB)	Limit (dBuV/m)	Height (cm)	Angle (deg)	Remark (QP/PK/AV)
1	*	47.36	4.13	51.48	-22.52	74.00	150	360	Peak
2		36.93	12.46	49.39	-24.61	74.00	150	360	Peak
3		33.91	16.23	50.14	-23.86	74.00	150	360	Peak

Note:

1. " *", means this data is the worst emission level.
2. C.F (Correction Factor) = Antenna Factor (dB/m)+ Cable Loss (dB) – Pre-amplifier(dB).
3. Measurement (dBuV/m) = Reading(dBuV) + C.F (Correction Factor).
4. The emission levels of other frequencies are very lower than the limit and not show in test report.

EUT	Pan/Tilt AI Home Security Wi-Fi Camera	Date of Test	2023-05-16
Factor	BBHA 9120D	Temp. / Humidity	24°C /59%
Polarity	Vertical	Site / Test Engineer	AC1 / Todd
Test Mode	802.11b_TX_CH 11_ANT 0	Test Voltage	AC 120V/60Hz

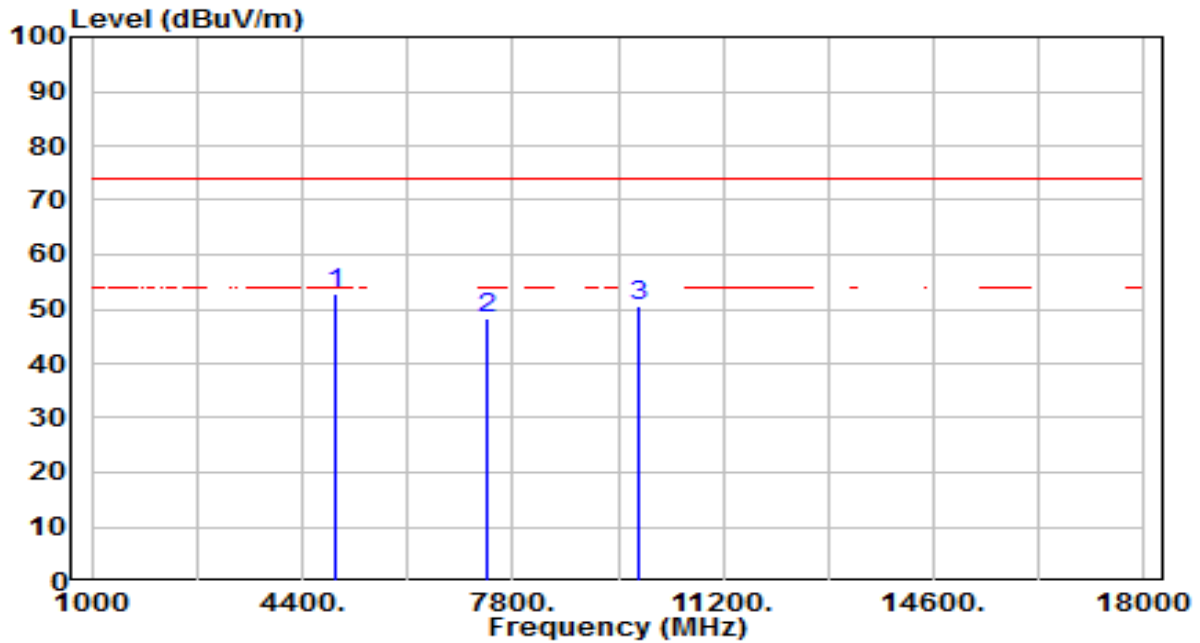

No	Frequency (MHz)	Reading (dBuV)	C.F (dB/m)	Measurement (dBuV/m)	Margin (dB)	Limit (dBuV/m)	Height (cm)	Angle (deg)	Remark (QP/PK/AV)	
1	*	4924.000	48.59	4.13	52.72	-21.28	74.00	150	360	Peak
2		7386.000	36.03	12.46	48.49	-25.51	74.00	150	360	Peak
3		9848.000	34.45	16.23	50.67	-23.33	74.00	150	360	Peak

Note:

1. " *", means this data is the worst emission level.
2. C.F (Correction Factor) = Antenna Factor (dB/m)+ Cable Loss (dB) – Preamplifier(dB).
3. Measurement (dBuV/m) = Reading(dBuV) + C.F (Correction Factor).
4. The emission levels of other frequencies are very lower than the limit and not show in test report.

EUT	Pan/Tilt AI Home Security Wi-Fi Camera	Date of Test	2023-05-16
Factor	BBHA 9120D	Temp. / Humidity	24°C /59%
Polarity	Horizontal	Site / Test Engineer	AC1 / Todd
Test Mode	802.11g_TX_CH 1_ANT 0	Test Voltage	AC 120V/60Hz

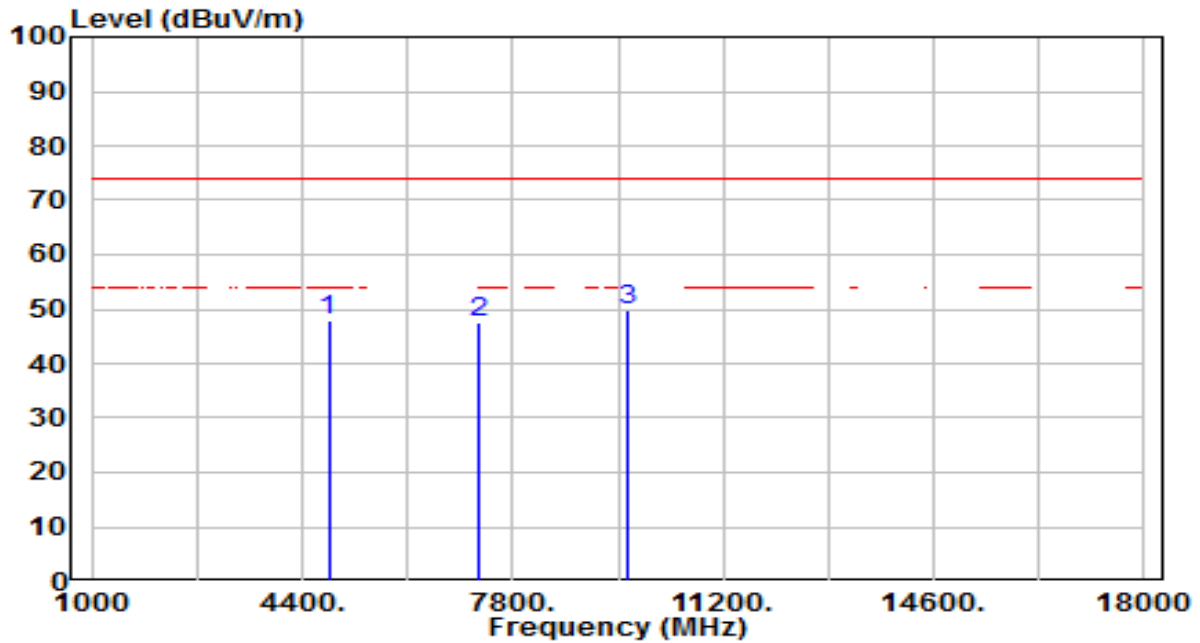

No	Frequency (MHz)	Reading (dBuV)	C.F (dB/m)	Measurement (dBuV/m)	Margin (dB)	Limit (dBuV/m)	Height (cm)	Angle (deg)	Remark (QP/PK/AV)
1	4824.000	44.11	3.91	48.03	-25.97	74.00	150	360	Peak
2	7236.000	35.56	11.94	47.50	-26.50	74.00	150	360	Peak
3	* 9648.000	33.83	15.79	49.63	-24.37	74.00	150	360	Peak

Note:

1. " *", means this data is the worst emission level.
2. C.F (Correction Factor) = Antenna Factor (dB/m)+ Cable Loss (dB) – Pre-amplifier(dB).
3. Measurement (dBuV/m) = Reading(dBuV) + C.F (Correction Factor).
4. The emission levels of other frequencies are very lower than the limit and not show in test report.

EUT	Pan/Tilt AI Home Security Wi-Fi Camera	Date of Test	2023-05-16
Factor	BBHA 9120D	Temp. / Humidity	24°C /59%
Polarity	Vertical	Site / Test Engineer	AC1 / Todd
Test Mode	802.11g_TX_CH 1_ANT 0	Test Voltage	AC 120V/60Hz

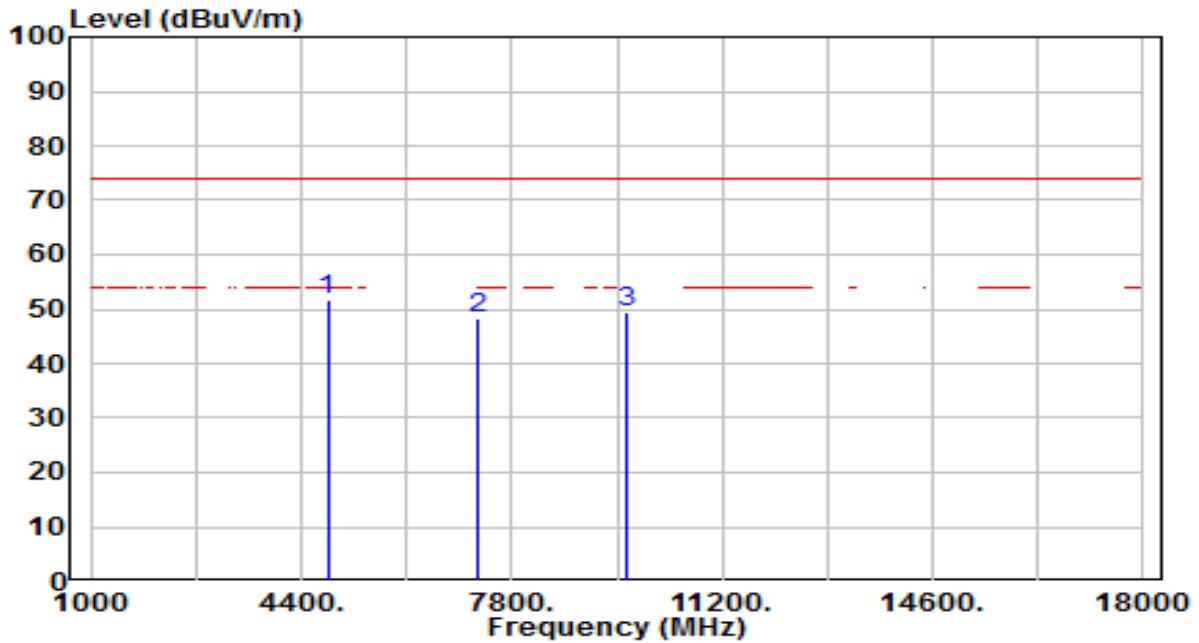

No	Frequency (MHz)	Reading (dBuV)	C.F (dB/m)	Measurement (dBuV/m)	Margin (dB)	Limit (dBuV/m)	Height (cm)	Angle (deg)	Remark (QP/PK/AV)
1	*	47.76	3.91	51.68	-22.32	74.00	150	360	Peak
2		36.33	11.94	48.27	-25.73	74.00	150	360	Peak
3		33.78	15.79	49.57	-24.43	74.00	150	360	Peak

Note:

1. " *", means this data is the worst emission level.
2. C.F (Correction Factor) = Antenna Factor (dB/m)+ Cable Loss (dB) – Pre-amplifier(dB).
3. Measurement (dBuV/m) = Reading(dBuV) + C.F (Correction Factor).
4. The emission levels of other frequencies are very lower than the limit and not show in test report.

EUT	Pan/Tilt AI Home Security Wi-Fi Camera	Date of Test	2023-05-16
Factor	BBHA 9120D	Temp. / Humidity	24°C /59%
Polarity	Horizontal	Site / Test Engineer	AC1 / Todd
Test Mode	802.11g_TX_CH 6_ANT 0	Test Voltage	AC 120V/60Hz

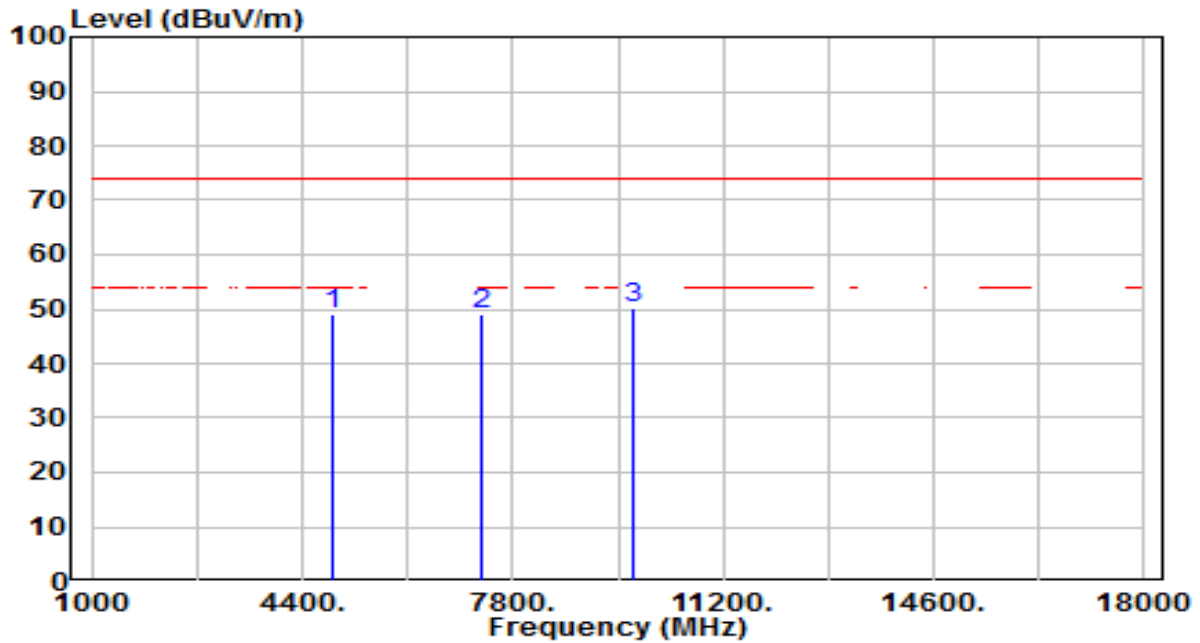

No	Frequency (MHz)	Reading (dBuV)	C.F (dB/m)	Measurement (dBuV/m)	Margin (dB)	Limit (dBuV/m)	Height (cm)	Angle (deg)	Remark (QP/PK/AV)
1	4874.000	44.95	4.02	48.97	-25.03	74.00	150	360	Peak
2	7311.000	36.99	12.20	49.20	-24.80	74.00	150	360	Peak
3	* 9748.000	34.08	16.01	50.09	-23.91	74.00	150	360	Peak

Note:

1. " *", means this data is the worst emission level.
2. C.F (Correction Factor) = Antenna Factor (dB/m)+ Cable Loss (dB) – Pre-amplifier(dB).
3. Measurement (dBuV/m) = Reading(dBuV) + C.F (Correction Factor).
4. The emission levels of other frequencies are very lower than the limit and not show in test report.

EUT	Pan/Tilt AI Home Security Wi-Fi Camera	Date of Test	2023-05-16
Factor	BBHA 9120D	Temp. / Humidity	24°C /59%
Polarity	Vertical	Site / Test Engineer	AC1 / Todd
Test Mode	802.11g_TX_CH 6_ANT 0	Test Voltage	AC 120V/60Hz

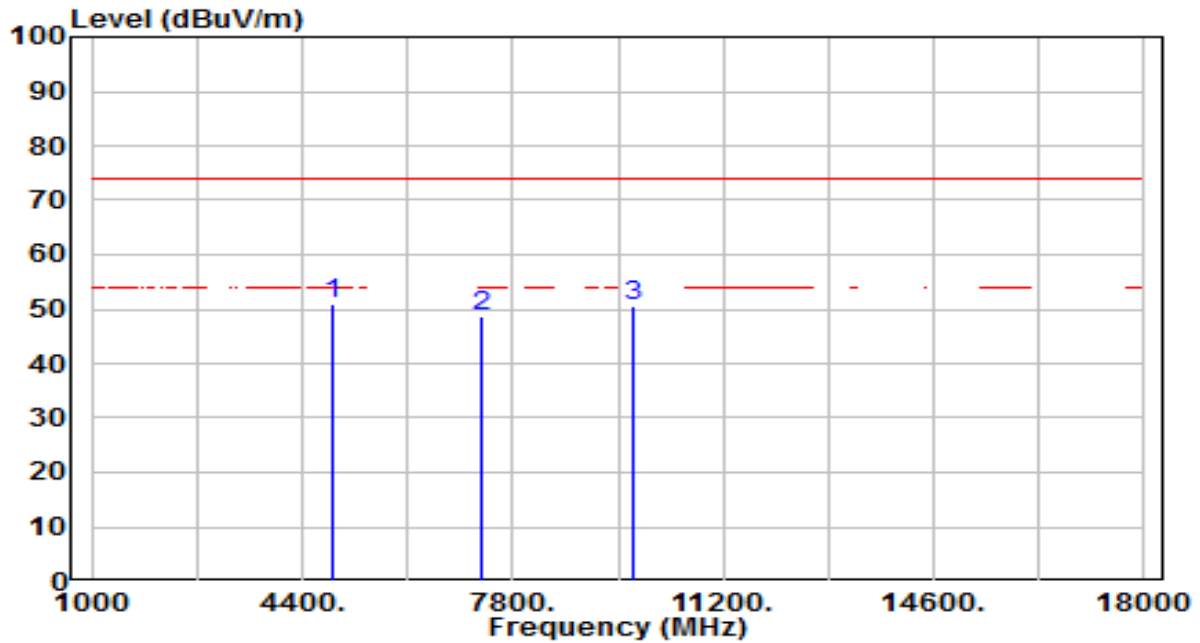

No	Frequency (MHz)	Reading (dBuV)	C.F (dB/m)	Measurement (dBuV/m)	Margin (dB)	Limit (dBuV/m)	Height (cm)	Angle (deg)	Remark (QP/PK/AV)
1	*	46.77	4.02	50.79	-23.21	74.00	150	360	Peak
2		36.47	12.20	48.68	-25.32	74.00	150	360	Peak
3		34.56	16.01	50.57	-23.43	74.00	150	360	Peak

Note:

1. " *", means this data is the worst emission level.
2. C.F (Correction Factor) = Antenna Factor (dB/m)+ Cable Loss (dB) – Pre-amplifier(dB).
3. Measurement (dBuV/m) = Reading(dBuV) + C.F (Correction Factor).
4. The emission levels of other frequencies are very lower than the limit and not show in test report.

EUT	Pan/Tilt AI Home Security Wi-Fi Camera	Date of Test	2023-05-16
Factor	BBHA 9120D	Temp. / Humidity	24°C /59%
Polarity	Horizontal	Site / Test Engineer	AC1 / Todd
Test Mode	802.11g_TX_CH 11_ANT 0	Test Voltage	AC 120V/60Hz

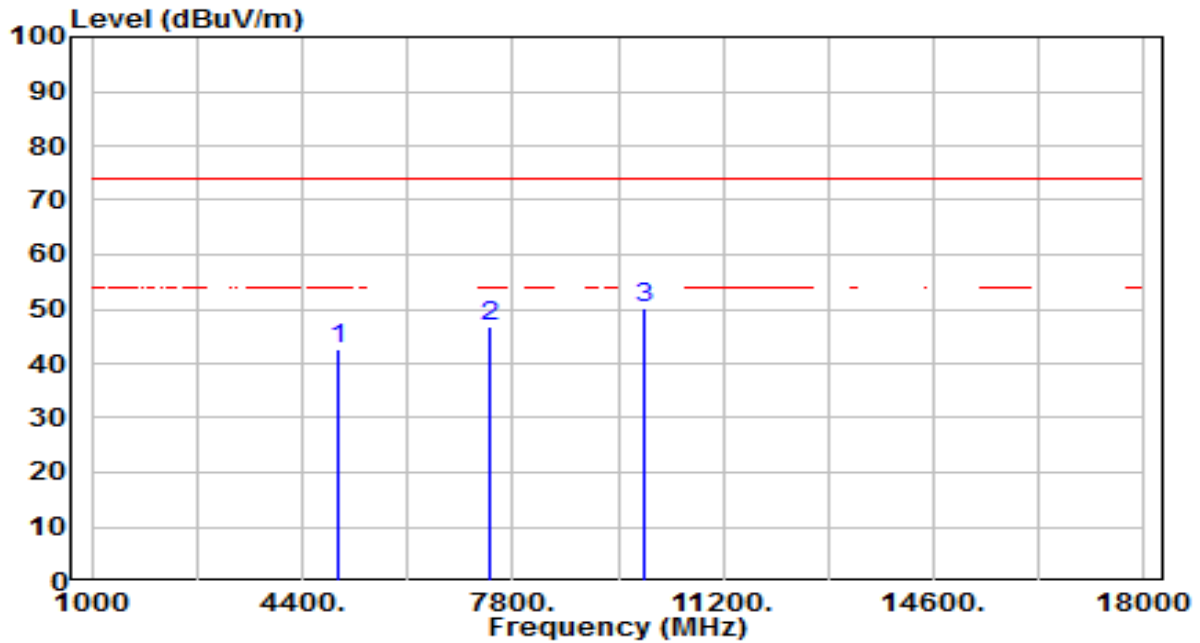

No	Frequency (MHz)	Reading (dBuV)	C.F (dB/m)	Measurement (dBuV/m)	Margin (dB)	Limit (dBuV/m)	Height (cm)	Angle (deg)	Remark (QP/PK/AV)
1	4960.000	38.28	4.20	42.49	-31.51	74.00	150	360	Peak
2	7440.000	33.96	12.65	46.61	-27.39	74.00	150	360	Peak
3	* 9920.000	33.62	16.39	50.00	-24.00	74.00	150	360	Peak

Note:

1. " *", means this data is the worst emission level.
2. C.F (Correction Factor) = Antenna Factor (dB/m)+ Cable Loss (dB) – Preamplifier(dB).
3. Measurement (dBuV/m) = Reading(dBuV) + C.F (Correction Factor).
4. The emission levels of other frequencies are very lower than the limit and not show in test report.

EUT	Pan/Tilt AI Home Security Wi-Fi Camera	Date of Test	2023-05-16
Factor	BBHA 9120D	Temp. / Humidity	24°C /59%
Polarity	Vertical	Site / Test Engineer	AC1 / Todd
Test Mode	802.11g_TX_CH 11_ANT 0	Test Voltage	AC 120V/60Hz

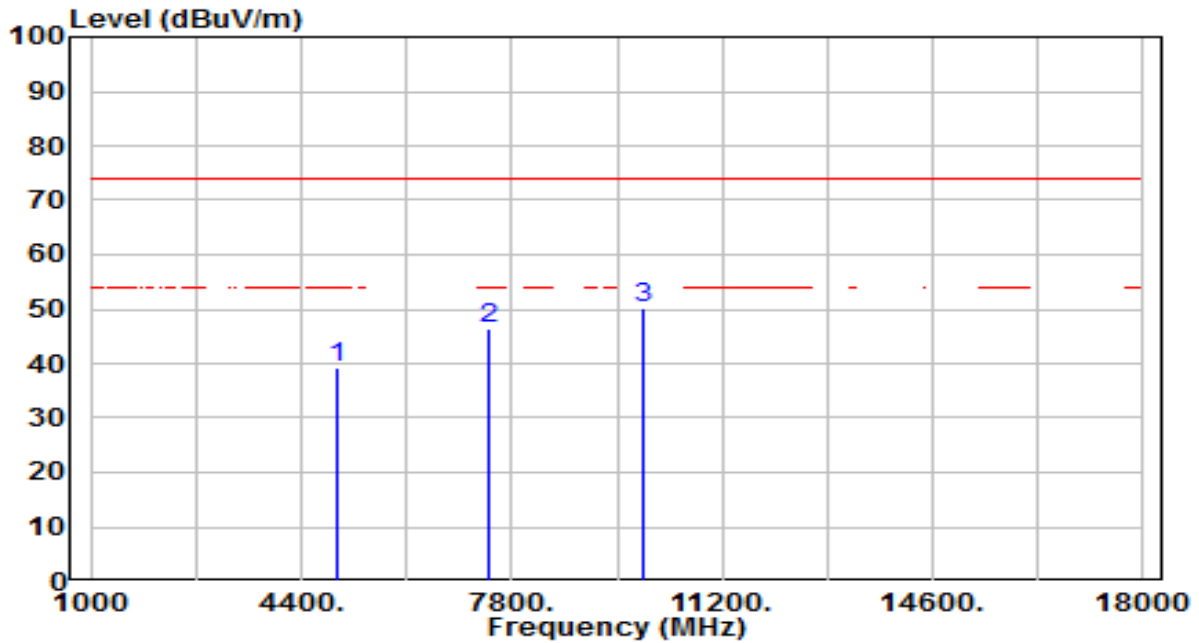

No	Frequency (MHz)	Reading (dBuV)	C.F (dB/m)	Measurement (dBuV/m)	Margin (dB)	Limit (dBuV/m)	Height (cm)	Angle (deg)	Remark (QP/PK/AV)
1	4960.000	35.23	4.20	39.43	-34.57	74.00	150	360	Peak
2	7440.000	33.74	12.65	46.40	-27.60	74.00	150	360	Peak
3	* 9920.000	33.93	16.39	50.32	-23.68	74.00	150	360	Peak

Note:

1. " *", means this data is the worst emission level.
2. C.F (Correction Factor) = Antenna Factor (dB/m)+ Cable Loss (dB) – Preamplifier(dB).
3. Measurement (dBuV/m) = Reading(dBuV) + C.F (Correction Factor).
4. The emission levels of other frequencies are very lower than the limit and not show in test report.

EUT	Pan/Tilt AI Home Security Wi-Fi Camera	Date of Test	2023-05-16
Factor	BBHA 9120D	Temp. / Humidity	24°C /59%
Polarity	Horizontal	Site / Test Engineer	AC1 / Todd
Test Mode	802.11n-20MHz_TX_CH 1_ANT 0	Test Voltage	AC 120V/60Hz

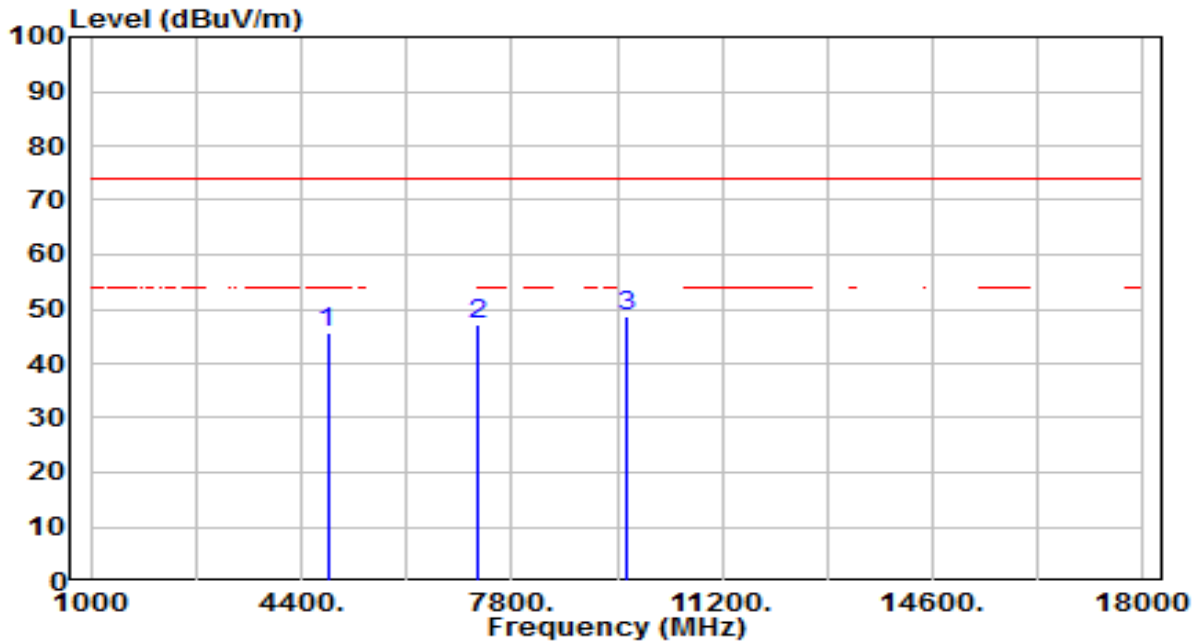

No	Frequency (MHz)	Reading (dBuV)	C.F (dB/m)	Measurement (dBuV/m)	Margin (dB)	Limit (dBuV/m)	Height (cm)	Angle (deg)	Remark (QP/PK/AV)
1	4824.000	41.81	3.91	45.73	-28.27	74.00	150	360	Peak
2	7236.000	35.34	11.94	47.28	-26.72	74.00	150	360	Peak
3	* 9648.000	32.97	15.79	48.76	-25.24	74.00	150	360	Peak

Note:

1. " *", means this data is the worst emission level.
2. C.F (Correction Factor) = Antenna Factor (dB/m)+ Cable Loss (dB) – Pre-amplifier(dB).
3. Measurement (dBuV/m) = Reading(dBuV) + C.F (Correction Factor).
4. The emission levels of other frequencies are very lower than the limit and not show in test report.

EUT	Pan/Tilt AI Home Security Wi-Fi Camera	Date of Test	2023-05-16
Factor	BBHA 9120D	Temp. / Humidity	24°C /59%
Polarity	Vertical	Site / Test Engineer	AC1 / Todd
Test Mode	802.11n-20MHz_TX_CH 1_ANT 0	Test Voltage	AC 120V/60Hz

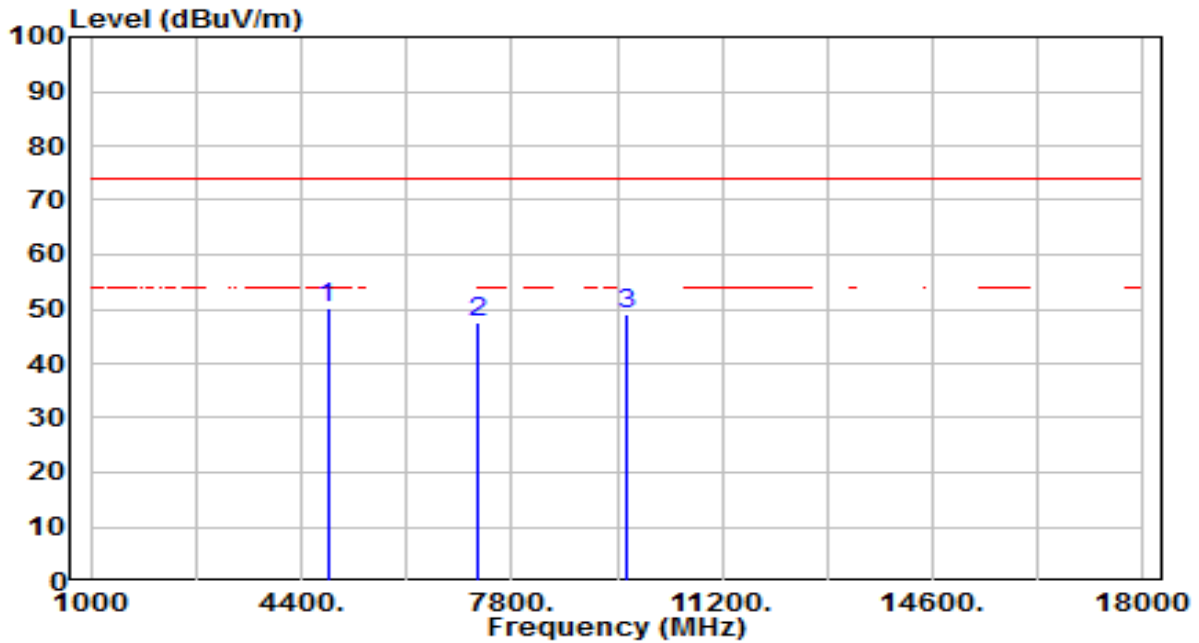

No	Frequency (MHz)	Reading (dBuV)	C.F (dB/m)	Measurement (dBuV/m)	Margin (dB)	Limit (dBuV/m)	Height (cm)	Angle (deg)	Remark (QP/PK/AV)
1	*	46.37	3.91	50.28	-23.72	74.00	150	360	Peak
2		35.61	11.94	47.55	-26.45	74.00	150	360	Peak
3		33.36	15.79	49.15	-24.85	74.00	150	360	Peak

Note:

1. " *", means this data is the worst emission level.
2. C.F (Correction Factor) = Antenna Factor (dB/m)+ Cable Loss (dB) – Pre-amplifier(dB).
3. Measurement (dBuV/m) = Reading(dBuV) + C.F (Correction Factor).
4. The emission levels of other frequencies are very lower than the limit and not show in test report.

EUT	Pan/Tilt AI Home Security Wi-Fi Camera	Date of Test	2023-05-16
Factor	BBHA 9120D	Temp. / Humidity	24°C /59%
Polarity	Horizontal	Site / Test Engineer	AC1 / Todd
Test Mode	802.11n-20MHz_TX_CH 6_ANT 0	Test Voltage	AC 120V/60Hz

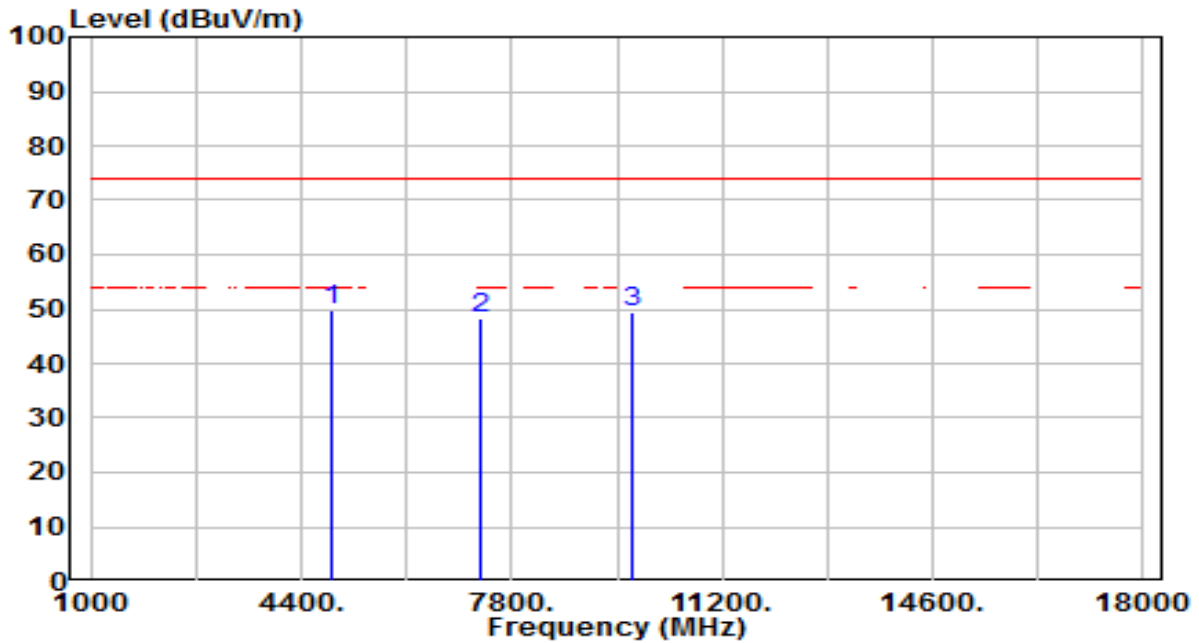

No	Frequency (MHz)	Reading (dBuV)	C.F (dB/m)	Measurement (dBuV/m)	Margin (dB)	Limit (dBuV/m)	Height (cm)	Angle (deg)	Remark (QP/PK/AV)
1	*	45.72	4.02	49.74	-24.26	74.00	150	360	Peak
2		36.27	12.20	48.48	-25.52	74.00	150	360	Peak
3		33.48	16.01	49.49	-24.51	74.00	150	360	Peak

Note:

1. " *", means this data is the worst emission level.
2. C.F (Correction Factor) = Antenna Factor (dB/m)+ Cable Loss (dB) – Pre-amplifier(dB).
3. Measurement (dBuV/m) = Reading(dBuV) + C.F (Correction Factor).
4. The emission levels of other frequencies are very lower than the limit and not show in test report.

EUT	Pan/Tilt AI Home Security Wi-Fi Camera	Date of Test	2023-05-16
Factor	BBHA 9120D	Temp. / Humidity	24°C /59%
Polarity	Vertical	Site / Test Engineer	AC1 / Todd
Test Mode	802.11n-20MHz_TX_CH 6_ANT 0	Test Voltage	AC 120V/60Hz

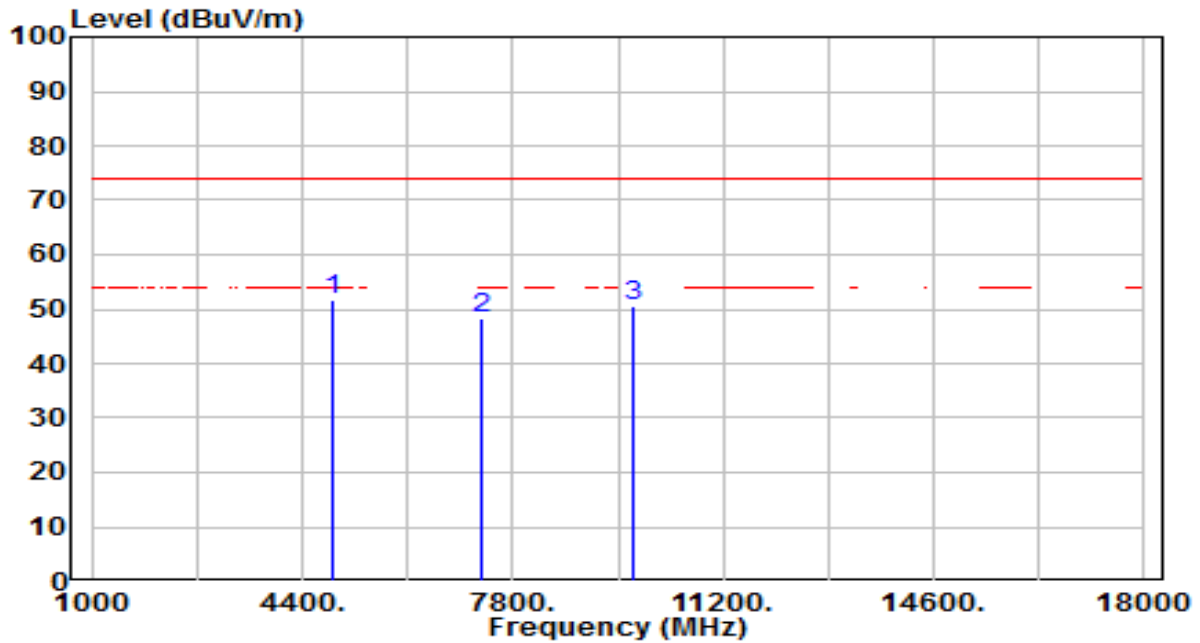

No	Frequency (MHz)	Reading (dBuV)	C.F (dB/m)	Measurement (dBuV/m)	Margin (dB)	Limit (dBuV/m)	Height (cm)	Angle (deg)	Remark (QP/PK/AV)
1	*	47.70	4.02	51.72	-22.28	74.00	150	360	Peak
2		35.97	12.20	48.17	-25.83	74.00	150	360	Peak
3		34.47	16.01	50.48	-23.52	74.00	150	360	Peak

Note:

1. " *", means this data is the worst emission level.
2. C.F (Correction Factor) = Antenna Factor (dB/m)+ Cable Loss (dB) – Preamplifier(dB).
3. Measurement (dBuV/m) = Reading(dBuV) + C.F (Correction Factor).
4. The emission levels of other frequencies are very lower than the limit and not show in test report.

EUT	Pan/Tilt AI Home Security Wi-Fi Camera	Date of Test	2023-05-16
Factor	BBHA 9120D	Temp. / Humidity	24°C /59%
Polarity	Horizontal	Site / Test Engineer	AC1 / Todd
Test Mode	802.11n-20MHz_TX_CH 11_ANT 0	Test Voltage	AC 120V/60Hz

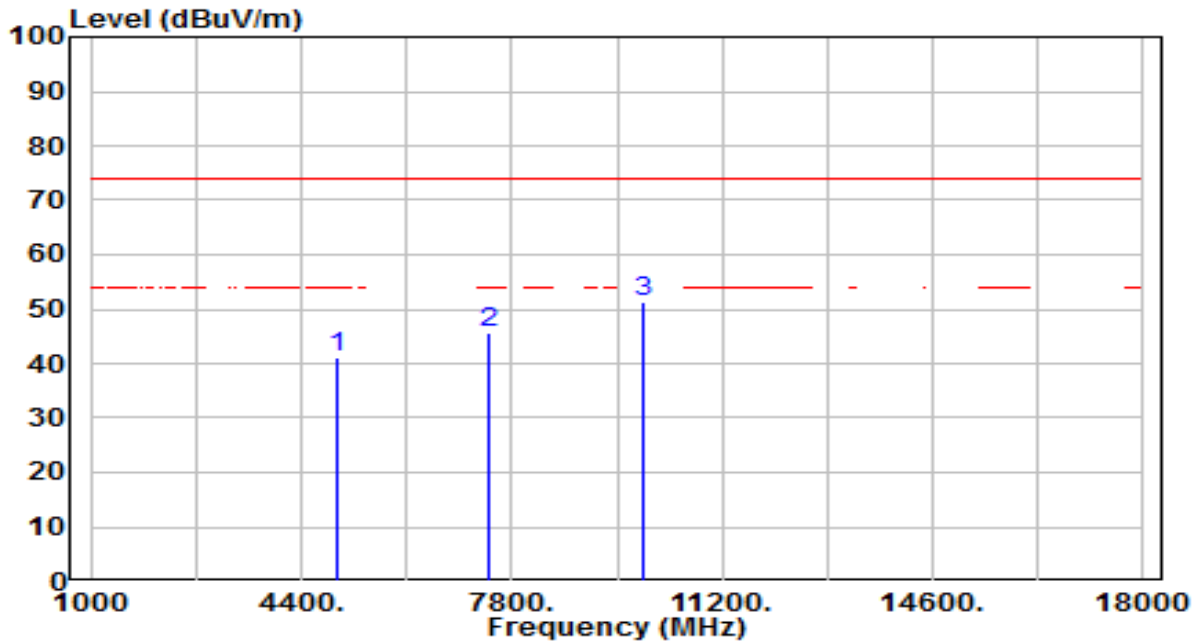

No	Frequency (MHz)	Reading (dBuV)	C.F (dB/m)	Measurement (dBuV/m)	Margin (dB)	Limit (dBuV/m)	Height (cm)	Angle (deg)	Remark (QP/PK/AV)
1	4960.000	36.96	4.20	41.17	-32.83	74.00	150	360	Peak
2	7440.000	33.15	12.65	45.81	-28.19	74.00	150	360	Peak
3	* 9920.000	34.81	16.39	51.20	-22.80	74.00	150	360	Peak

Note:

1. " *", means this data is the worst emission level.
2. C.F (Correction Factor) = Antenna Factor (dB/m)+ Cable Loss (dB) – Preamplifier(dB).
3. Measurement (dBuV/m) = Reading(dBuV) + C.F (Correction Factor).
4. The emission levels of other frequencies are very lower than the limit and not show in test report.

EUT	Pan/Tilt AI Home Security Wi-Fi Camera	Date of Test	2023-05-16
Factor	BBHA 9120D	Temp. / Humidity	24°C /59%
Polarity	Vertical	Site / Test Engineer	AC1 / Todd
Test Mode	802.11n-20MHz_TX_CH 11_ANT 0	Test Voltage	AC 120V/60Hz

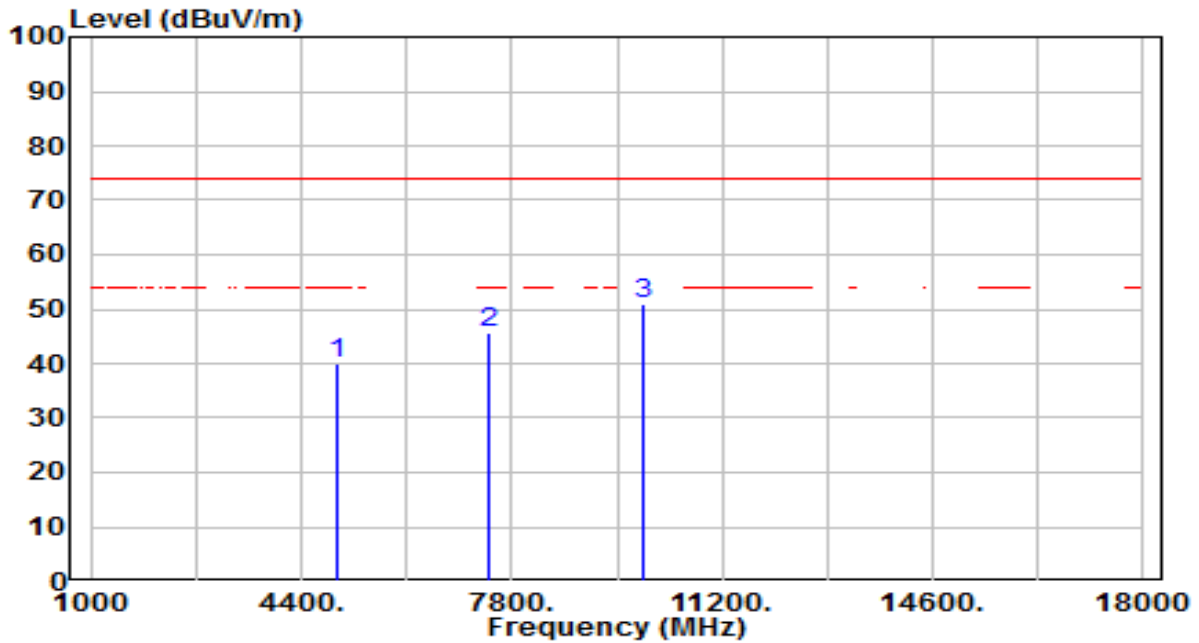

No	Frequency (MHz)	Reading (dBuV)	C.F (dB/m)	Measurement (dBuV/m)	Margin (dB)	Limit (dBuV/m)	Height (cm)	Angle (deg)	Remark (QP/PK/AV)
1	4960.000	35.96	4.20	40.16	-33.84	74.00	150	360	Peak
2	7440.000	33.03	12.65	45.69	-28.31	74.00	150	360	Peak
3	* 9920.000	34.60	16.39	50.98	-23.02	74.00	150	360	Peak

Note:

1. " *", means this data is the worst emission level.
2. C.F (Correction Factor) = Antenna Factor (dB/m)+ Cable Loss (dB) – Pre-amplifier(dB).
3. Measurement (dBuV/m) = Reading(dBuV) + C.F (Correction Factor).
4. The emission levels of other frequencies are very lower than the limit and not show in test report.

7.7. Radiated Restricted Band Edge Measurement

7.7.1. Test Limit

For 15.205 requirement:

Radiated emissions which fall in the restricted bands, as defined in Section 15.205(a) of FCC part 15, must also comply with the radiated emission limits specified in Section 15.209(a).

Frequency (MHz)	Frequency (MHz)	Frequency (MHz)	Frequency (GHz)
0.090 - 0.110	16.42 - 16.423	399.9 - 410	4.5 - 5.15
¹ 0.495 - 0.505	16.69475 - 16.69525	608 - 614	5.35 - 5.46
2.1735 - 2.1905	16.80425 - 16.80475	960 - 1240	7.25 - 7.75
4.125 - 4.128	25.5 - 25.67	1300 - 1427	8.025 - 8.5
4.17725 - 4.17775	37.5 - 38.25	1435 - 1626.5	9.0 - 9.2
4.20725 - 4.20775	73 - 74.6	1645.5 - 1646.5	9.3 - 9.5
6.215 - 6.218	74.8 - 75.2	1660 - 1710	10.6 - 12.7
6.26775 - 6.26825	108 - 121.94	1718.8 - 1722.2	13.25 - 13.4
6.31175 - 6.31225	123 - 138	2200 - 2300	14.47 - 14.5
8.291 - 8.294	149.9 - 150.05	2310 - 2390	15.35 - 16.2
8.362 - 8.366	156.52475 - 156.52525	2483.5 - 2500	17.7 - 21.4
8.37625 - 8.38675	156.7 - 156.9	2690 - 2900	22.01 - 23.12
8.41425 - 8.41475	162.0125 - 167.17	3260 - 3267	23.6 - 24.0
12.29 - 12.293	167.72 - 173.2	3332 - 3339	31.2 - 31.8
12.51975 - 12.52025	240 - 285	3345.8 - 3358	36.43 - 36.5
12.57675 - 12.57725	322 - 335.4	3600 - 4400	(²)
13.36 - 13.41	--	--	--

All out of band emissions appearing in a restricted band as specified in Section 15.205 of the Title 47CFR must not exceed the limits shown in Table per Section 15.209.

FCC Part 15 Subpart C Paragraph 15.209 Limits		
Frequency [MHz]	Field Strength [uV/m]	Measured Distance [Meters]
0.009 - 0.490	2400/F (kHz)	300
0.490 - 1.705	24000/F (kHz)	30
1.705 - 30	30	30
30 - 88	100	3
88 - 216	150	3
216 - 960	200	3
Above 960	500	3

7.7.2. Test Procedure Used

ANSI C63.10 - 2013 Section 6.3 (General Requirements)

ANSI C63.10 - 2013 Section 6.6 (Standard test method above 1GHz)

7.7.3. Test Setting

Peak Field Strength Measurements

1. Analyzer center frequency was set to the frequency of the radiated spurious emission of interest
2. RBW = 1MHz
3. VBW = 3MHz
4. Detector = peak
5. Sweep time = auto couple
6. Trace mode = max hold
7. Trace was allowed to stabilize

Average Measurements above 1GHz (Method VB)

1. Analyzer center frequency was set to the frequency of the radiated spurious emission of interest
2. RBW = 1MHz
3. VBW; If the EUT is configured to transmit with duty cycle $\geq 98\%$, set VBW = 10 Hz.
If the EUT duty cycle is $< 98\%$, set VBW $\geq 1/T$. T is the minimum transmission duration.

4. Detector = Peak
5. Sweep time = auto
6. Trace mode = max hold
7. Trace was allowed to stabilize

7.7.4. Test Setup

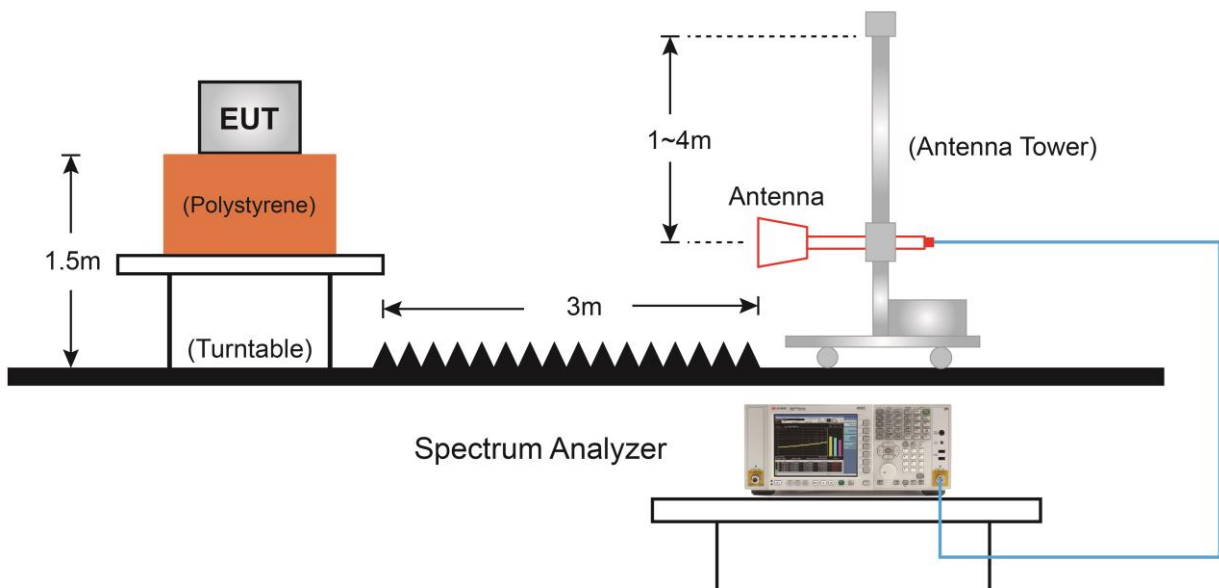

7.7.5. Test Result

EUT	Pan/Tilt AI Home Security Wi-Fi Camera	Date of Test	2023-05-16
Factor	BBHA 9120D	Temp. / Humidity	24°C /59%
Polarity	Horizontal	Site / Test Engineer	AC1 / Todd
Test Mode	802.11b_TX_CH 1_ANT 0	Test Voltage	AC 120V/60Hz

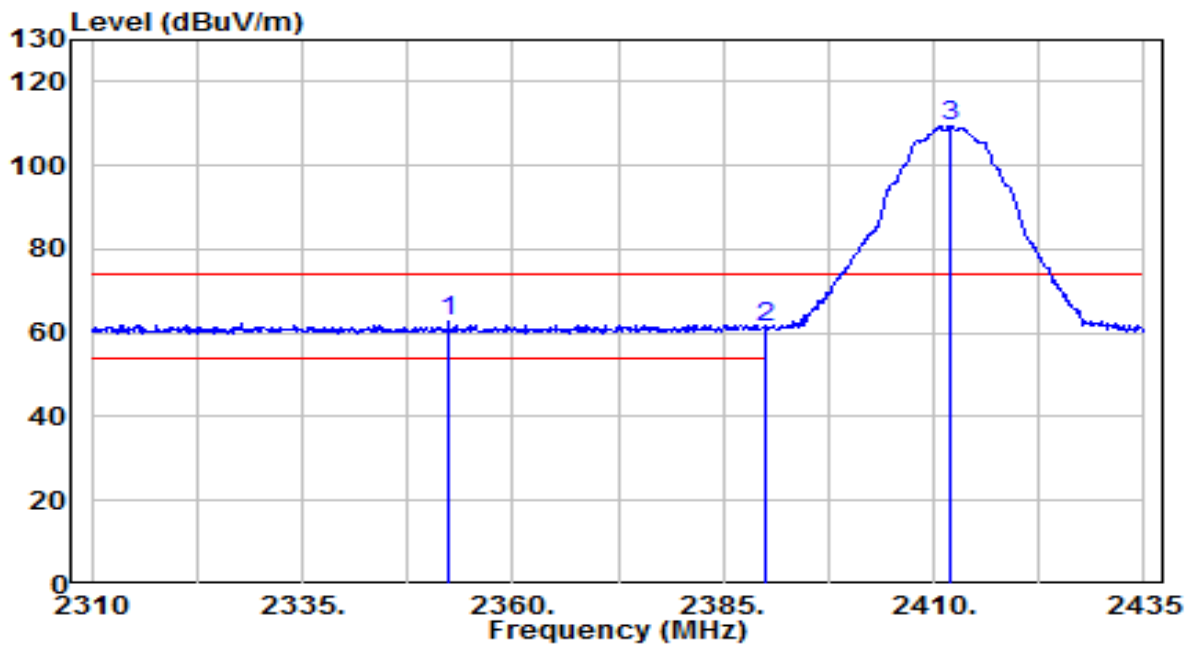

No	Frequency (MHz)	Reading (dBuV)	C.F (dB/m)	Measurement (dBuV/m)	Margin (dB)	Limit (dBuV/m)	Height (cm)	Angle (deg)	Remark (QP/PK/AV)
1	* 2352.375	30.51	32.05	62.55	-11.45	74.00	100	235	Peak
2	2390.000	29.21	32.18	61.39	-12.61	74.00	100	235	Peak
3	2412.000	77.27	32.26	109.54	N/A	N/A	100	235	Peak

Note:

1. " *", means this data is the worst emission level.
2. C.F (Correction Factor) = Antenna Factor (dB/m)+ Cable Loss (dB).
3. Measurement (dBuV/m) = Reading(dBuV) + C.F (Correction Factor).
4. The emission levels of other frequencies are very lower than the limit and not show in test report.

EUT	Pan/Tilt AI Home Security Wi-Fi Camera	Date of Test	2023-05-16
Factor	BBHA 9120D	Temp. / Humidity	24°C /59%
Polarity	Horizontal	Site / Test Engineer	AC1 / Todd
Test Mode	802.11b_TX_CH 1_ANT 0	Test Voltage	AC 120V/60Hz

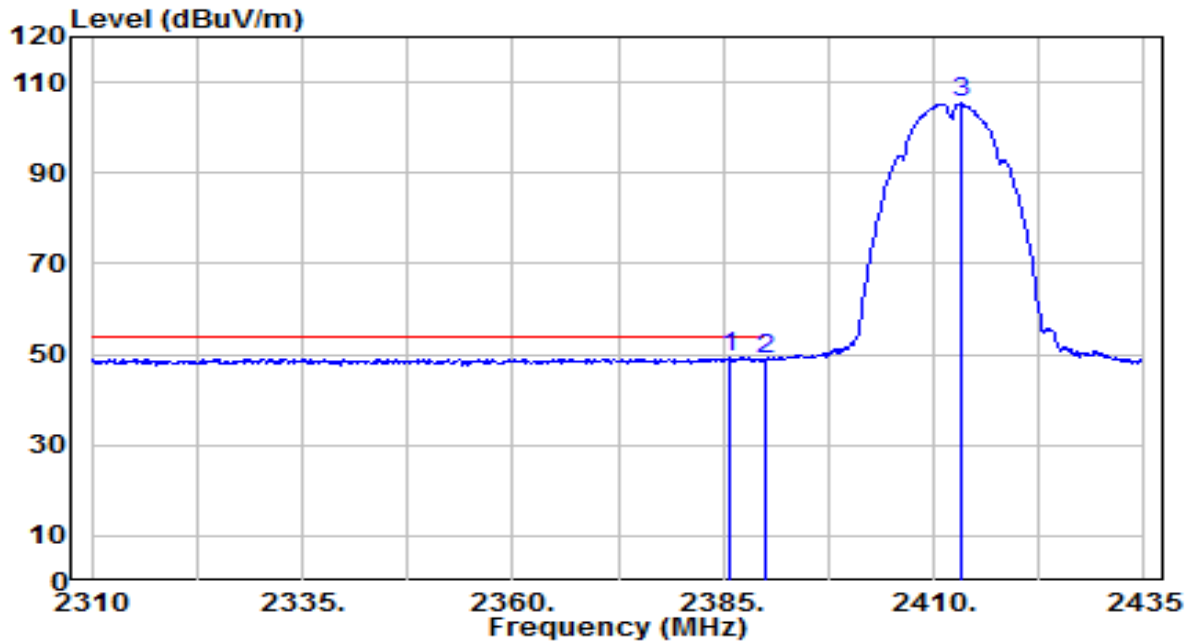

No	Frequency (MHz)	Reading (dBuV)	C.F (dB/m)	Measurement (dBuV/m)	Margin (dB)	Limit (dBuV/m)	Height (cm)	Angle (deg)	Remark (QP/PK/AV)	
1	*	2385.750	17.19	32.17	49.36	-4.64	54.00	100	235	Average
2		2390.000	16.87	32.18	49.06	-4.94	54.00	100	235	Average
3		2413.125	73.02	32.27	105.29	N/A	N/A	100	235	Average

Note:

1. " *", means this data is the worst emission level.
2. C.F (Correction Factor) = Antenna Factor (dB/m)+ Cable Loss (dB).
3. Measurement (dBuV/m) = Reading(dBuV) + C.F (Correction Factor).
4. The emission levels of other frequencies are very lower than the limit and not show in test report.

EUT	Pan/Tilt AI Home Security Wi-Fi Camera	Date of Test	2023-05-16
Factor	BBHA 9120D	Temp. / Humidity	24°C /59%
Polarity	Vertical	Site / Test Engineer	AC1 / Todd
Test Mode	802.11b_TX_CH 1_ANT 0	Test Voltage	AC 120V/60Hz

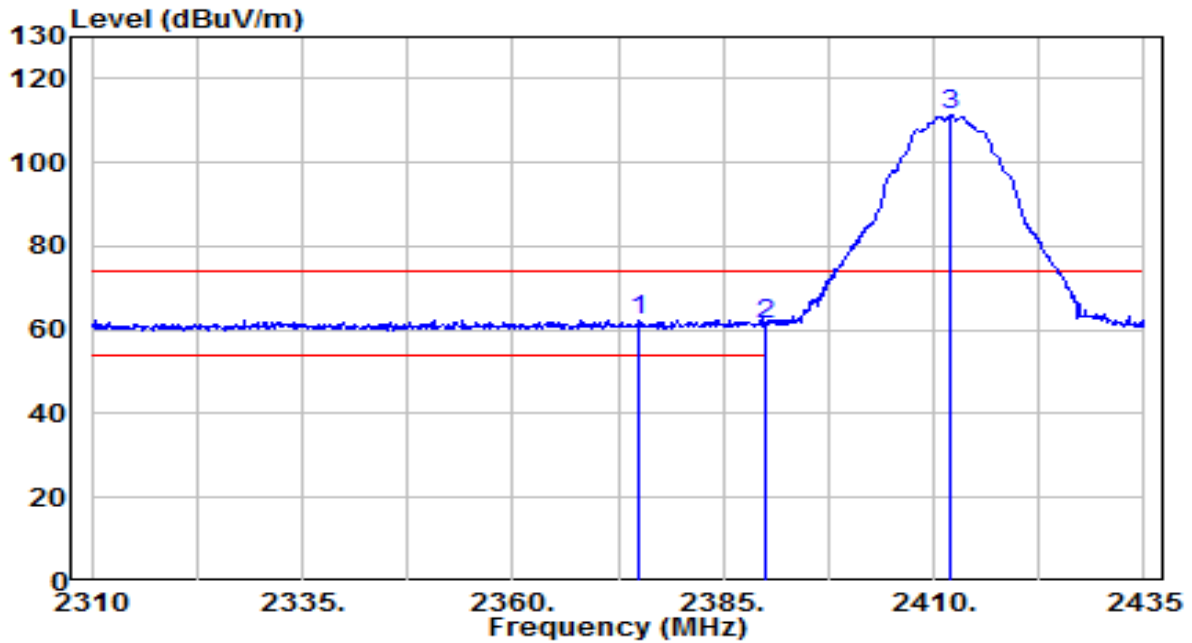

No	Frequency (MHz)	Reading (dBuV)	C.F (dB/m)	Measurement (dBuV/m)	Margin (dB)	Limit (dBuV/m)	Height (cm)	Angle (deg)	Remark (QP/PK/AV)	
1	*	2375.000	30.39	32.13	62.52	-11.48	74.00	130	260	Peak
2		2390.000	29.15	32.18	61.34	-12.66	74.00	130	260	Peak
3		2412.000	78.94	32.26	111.20	N/A	N/A	130	260	Peak

Note:

1. " *", means this data is the worst emission level.
2. C.F (Correction Factor) = Antenna Factor (dB/m)+ Cable Loss (dB).
3. Measurement (dBuV/m) = Reading(dBuV) + C.F (Correction Factor).
4. The emission levels of other frequencies are very lower than the limit and not show in test report.

EUT	Pan/Tilt AI Home Security Wi-Fi Camera	Date of Test	2023-05-16
Factor	BBHA 9120D	Temp. / Humidity	24°C /59%
Polarity	Vertical	Site / Test Engineer	AC1 / Todd
Test Mode	802.11b_TX_CH 1_ANT 0	Test Voltage	AC 120V/60Hz

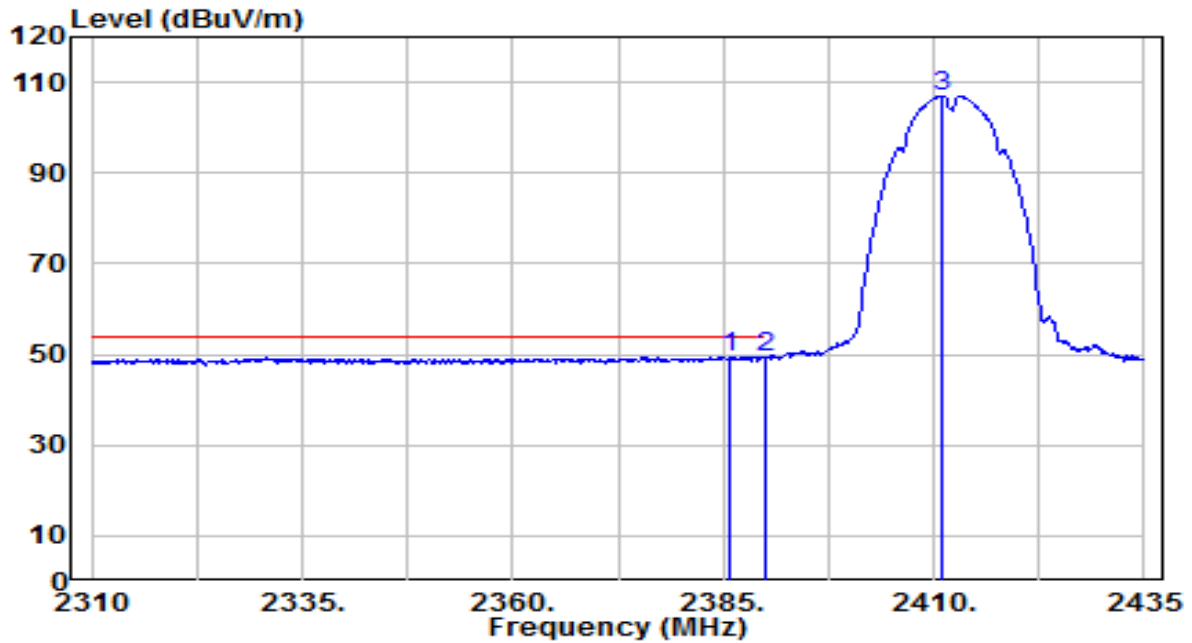

No	Frequency (MHz)	Reading (dBuV)	C.F (dB/m)	Measurement (dBuV/m)	Margin (dB)	Limit (dBuV/m)	Height (cm)	Angle (deg)	Remark (QP/PK/AV)	
1	*	2385.750	17.28	32.17	49.45	-4.55	54.00	130	260	Average
2		2390.000	17.23	32.18	49.41	-4.59	54.00	130	260	Average
3		2411.000	74.83	32.26	107.09	N/A	N/A	130	260	Average

Note:

1. " *", means this data is the worst emission level.
2. C.F (Correction Factor) = Antenna Factor (dB/m)+ Cable Loss (dB).
3. Measurement (dBuV/m) = Reading(dBuV) + C.F (Correction Factor).
4. The emission levels of other frequencies are very lower than the limit and not show in test report.

EUT	Pan/Tilt AI Home Security Wi-Fi Camera	Date of Test	2023-05-16
Factor	BBHA 9120D	Temp. / Humidity	24°C /59%
Polarity	Horizontal	Site / Test Engineer	AC1 / Todd
Test Mode	802.11b_TX_CH 6_ANT 0	Test Voltage	AC 120V/60Hz

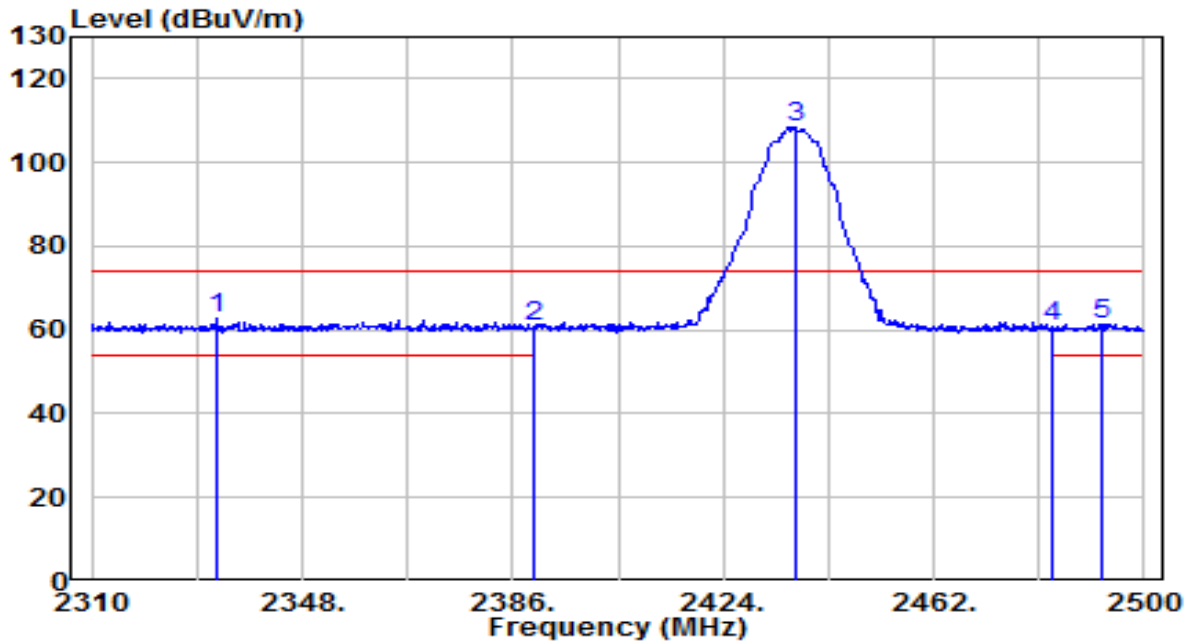

No	Frequency (MHz)	Reading (dBuV)	C.F (dB/m)	Measurement (dBuV/m)	Margin (dB)	Limit (dBuV/m)	Height (cm)	Angle (deg)	Remark (QP/PK/AV)
1	* 2332.610	30.70	31.98	62.68	-11.32	74.00	105	235	Peak
2	2390.000	28.45	32.18	60.63	-13.37	74.00	105	235	Peak
3	2437.110	76.19	32.35	108.54	N/A	N/A	105	235	Peak
4	2483.500	28.42	32.52	60.94	-13.06	74.00	105	235	Peak
5	2492.400	28.96	32.55	61.52	-12.48	74.00	105	235	Peak

Note:

1. " *", means this data is the worst emission level.
2. C.F (Correction Factor) = Antenna Factor (dB/m)+ Cable Loss (dB).
3. Measurement (dBuV/m) = Reading(dBuV) + C.F (Correction Factor).
4. The emission levels of other frequencies are very lower than the limit and not show in test report.

EUT	Pan/Tilt AI Home Security Wi-Fi Camera	Date of Test	2023-05-16
Factor	BBHA 9120D	Temp. / Humidity	24°C /59%
Polarity	Horizontal	Site / Test Engineer	AC1 / Todd
Test Mode	802.11b_TX_CH 6_ANT 0	Test Voltage	AC 120V/60Hz

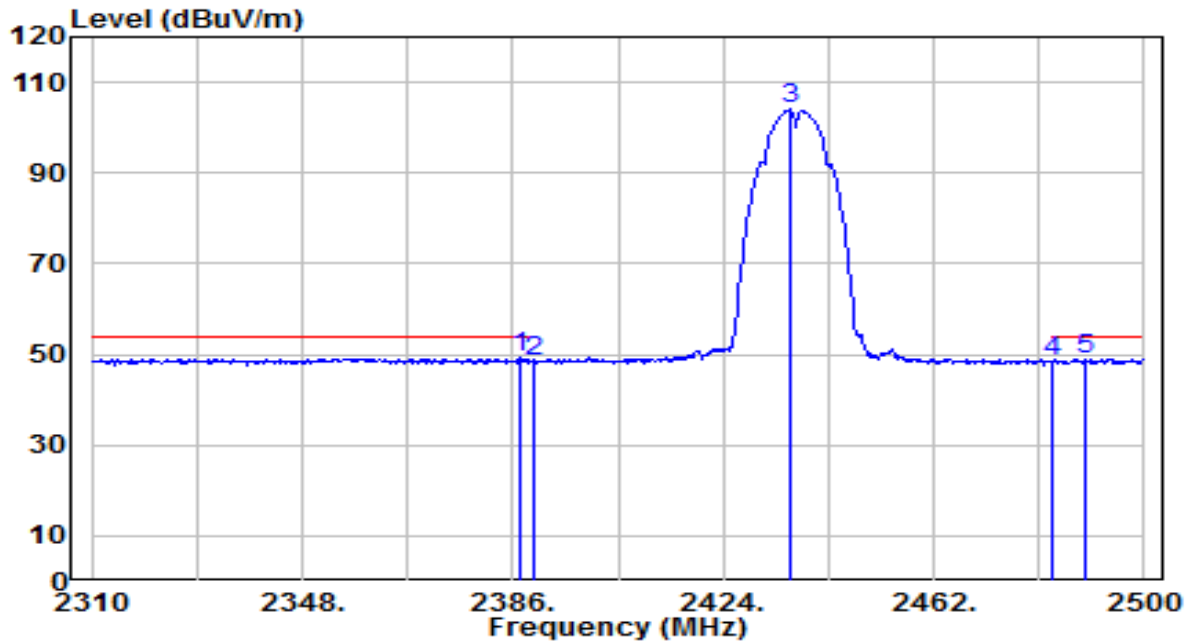

No	Frequency (MHz)	Reading (dBuV)	C.F (dB/m)	Measurement (dBuV/m)	Margin (dB)	Limit (dBuV/m)	Height (cm)	Angle (deg)	Remark (QP/PK/AV)	
1	*	2387.520	16.96	32.18	49.14	-4.86	54.00	105	235	Average
2		2390.000	16.40	32.18	48.58	-5.42	54.00	105	235	Average
3		2435.970	71.62	32.35	103.97	N/A	N/A	105	235	Average
4		2483.500	16.01	32.52	48.53	-5.47	54.00	105	235	Average
5		2489.550	16.46	32.54	49.01	-4.99	54.00	105	235	Average

Note:

1. " *", means this data is the worst emission level.
2. C.F (Correction Factor) = Antenna Factor (dB/m)+ Cable Loss (dB).
3. Measurement (dBuV/m) = Reading(dBuV) + C.F (Correction Factor).
4. The emission levels of other frequencies are very lower than the limit and not show in test report.

EUT	Pan/Tilt AI Home Security Wi-Fi Camera	Date of Test	2023-05-16
Factor	BBHA 9120D	Temp. / Humidity	24°C /59%
Polarity	Vertical	Site / Test Engineer	AC1 / Todd
Test Mode	802.11b_TX_CH 6_ANT 0	Test Voltage	AC 120V/60Hz

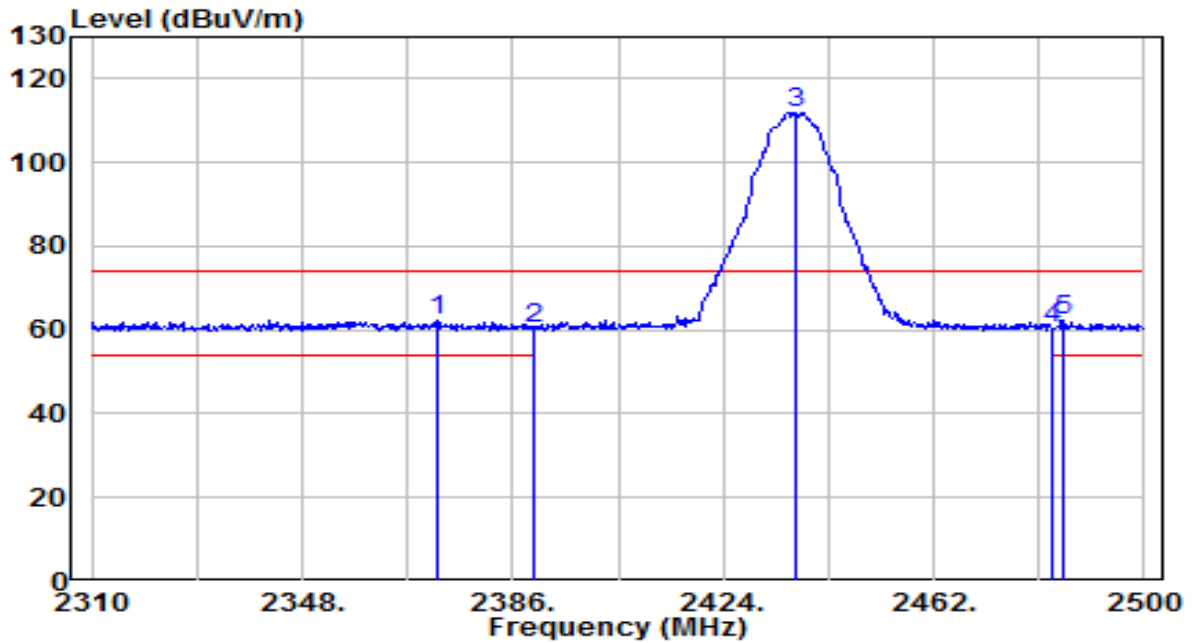

No	Frequency (MHz)	Reading (dBUV)	C.F (dB/m)	Measurement (dBUV/m)	Margin (dB)	Limit (dBUV/m)	Height (cm)	Angle (deg)	Remark (QP/PK/AV)
1	* 2372.320	30.31	32.12	62.43	-11.57	74.00	165	260	Peak
2	2390.000	28.07	32.18	60.25	-13.75	74.00	165	260	Peak
3	2436.920	79.69	32.35	112.04	N/A	N/A	165	260	Peak
4	2483.500	27.71	32.52	60.23	-13.77	74.00	165	260	Peak
5	2485.560	29.58	32.53	62.11	-11.89	74.00	165	260	Peak

Note:

- " *", means this data is the worst emission level.
- C.F (Correction Factor) = Antenna Factor (dB/m)+ Cable Loss (dB).
- Measurement (dBUV/m) = Reading(dBUV) + C.F (Correction Factor).
- The emission levels of other frequencies are very lower than the limit and not show in test report.

EUT	Pan/Tilt AI Home Security Wi-Fi Camera	Date of Test	2023-05-16
Factor	BBHA 9120D	Temp. / Humidity	24°C /59%
Polarity	Vertical	Site / Test Engineer	AC1 / Todd
Test Mode	802.11b_TX_CH 6_ANT 0	Test Voltage	AC 120V/60Hz

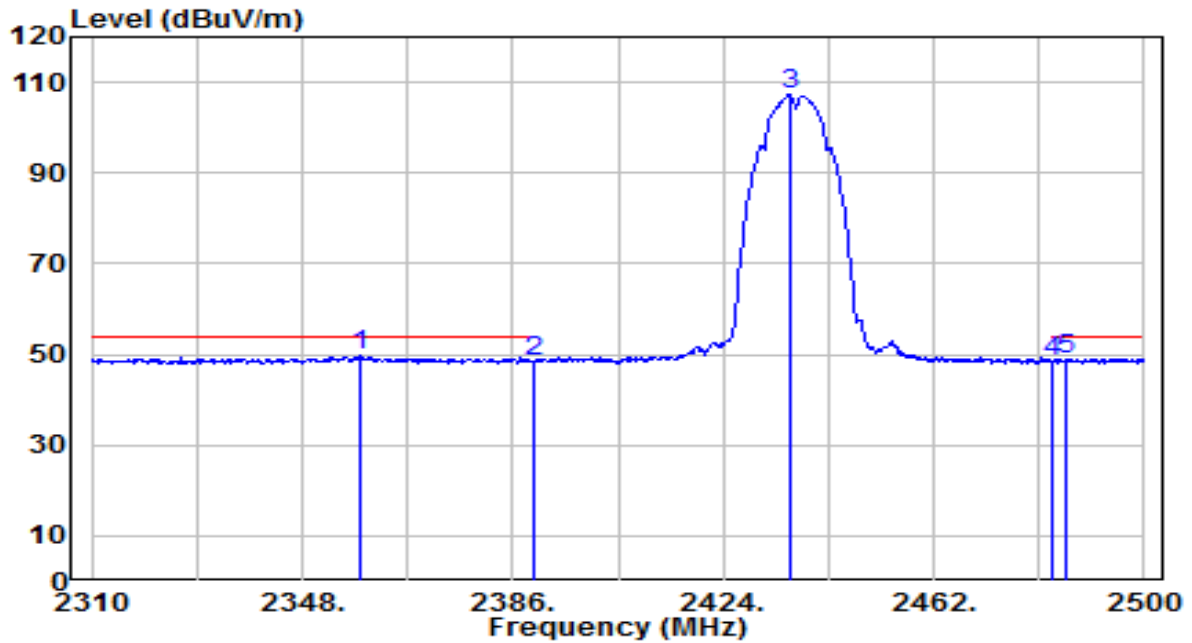

No	Frequency (MHz)	Reading (dBuV)	C.F (dB/m)	Measurement (dBuV/m)	Margin (dB)	Limit (dBuV/m)	Height (cm)	Angle (deg)	Remark (QP/PK/AV)
1	* 2358.260	17.65	32.07	49.72	-4.28	54.00	165	260	Average
2	2390.000	16.47	32.18	48.66	-5.34	54.00	165	260	Average
3	2435.970	74.93	32.35	107.28	N/A	N/A	165	260	Average
4	2483.500	16.10	32.52	48.62	-5.38	54.00	165	260	Average
5	2485.940	16.47	32.53	49.00	-5.00	54.00	165	260	Average

Note:

1. " *", means this data is the worst emission level.
2. C.F (Correction Factor) = Antenna Factor (dB/m)+ Cable Loss (dB).
3. Measurement (dBuV/m) = Reading(dBuV) + C.F (Correction Factor).
4. The emission levels of other frequencies are very lower than the limit and not show in test report.

EUT	Pan/Tilt AI Home Security Wi-Fi Camera	Date of Test	2023-05-16
Factor	BBHA 9120D	Temp. / Humidity	24°C /59%
Polarity	Horizontal	Site / Test Engineer	AC1 / Todd
Test Mode	802.11b_TX_CH 11_ANT 0	Test Voltage	AC 120V/60Hz

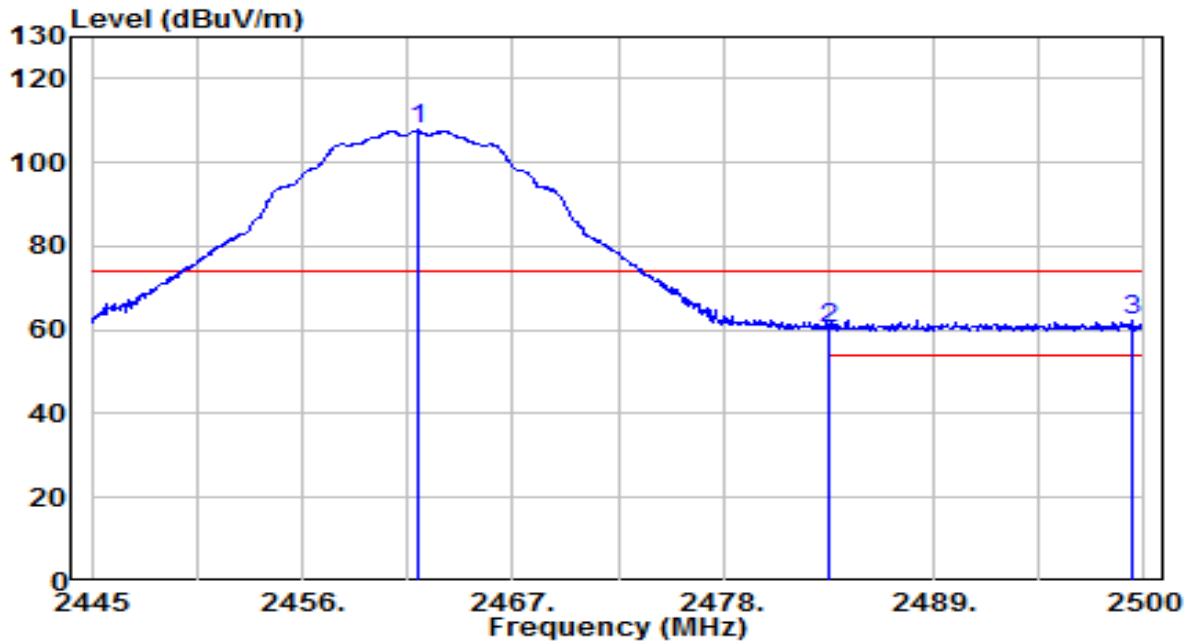

No	Frequency (MHz)	Reading (dBuV)	C.F (dB/m)	Measurement (dBuV/m)	Margin (dB)	Limit (dBuV/m)	Height (cm)	Angle (deg)	Remark (QP/PK/AV)
1	2461.995	75.27	32.44	107.72	N/A	N/A	125	240	Peak
2	2483.500	27.84	32.52	60.36	-13.64	74.00	125	240	Peak
3	* 2499.395	29.97	32.58	62.54	-11.46	74.00	125	240	Peak

Note:

1. " *", means this data is the worst emission level.
2. C.F (Correction Factor) = Antenna Factor (dB/m)+ Cable Loss (dB).
3. Measurement (dBuV/m) = Reading(dBuV) + C.F (Correction Factor).
4. The emission levels of other frequencies are very lower than the limit and not show in test report.

EUT	Pan/Tilt AI Home Security Wi-Fi Camera	Date of Test	2023-05-16
Factor	BBHA 9120D	Temp. / Humidity	24°C /59%
Polarity	Horizontal	Site / Test Engineer	AC1 / Todd
Test Mode	802.11b_TX_CH 11_ANT 0	Test Voltage	AC 120V/60Hz

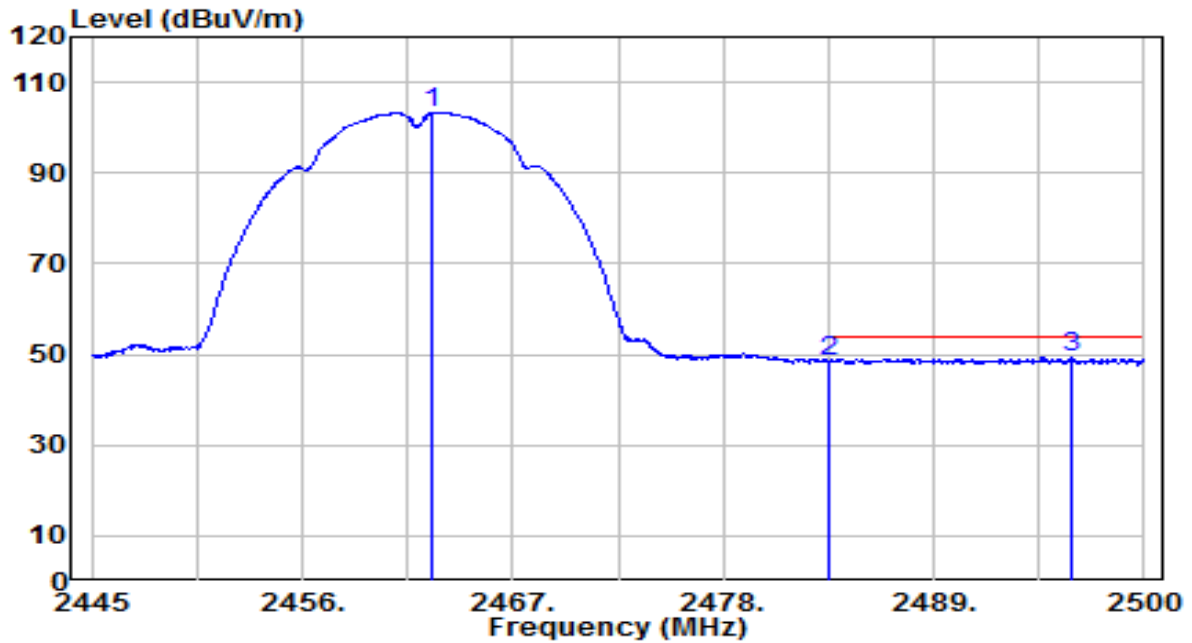

No	Frequency (MHz)	Reading (dBUV)	C.F (dB/m)	Measurement (dBUV/m)	Margin (dB)	Limit (dBUV/m)	Height (cm)	Angle (deg)	Remark (QP/PK/AV)
1	2462.820	70.93	32.45	103.38	N/A	N/A	125	240	Average
2	2483.500	15.78	32.52	48.30	-5.70	54.00	125	240	Average
3	* 2496.205	16.66	32.57	49.22	-4.78	54.00	125	240	Average

Note:

1. " *", means this data is the worst emission level.
2. C.F (Correction Factor) = Antenna Factor (dB/m)+ Cable Loss (dB).
3. Measurement (dBUV/m) = Reading(dBUV) + C.F (Correction Factor).
4. The emission levels of other frequencies are very lower than the limit and not show in test report.

EUT	Pan/Tilt AI Home Security Wi-Fi Camera	Date of Test	2023-05-16
Factor	BBHA 9120D	Temp. / Humidity	24°C /59%
Polarity	Vertical	Site / Test Engineer	AC1 / Todd
Test Mode	802.11b_TX_CH 11_ANT 0	Test Voltage	AC 120V/60Hz

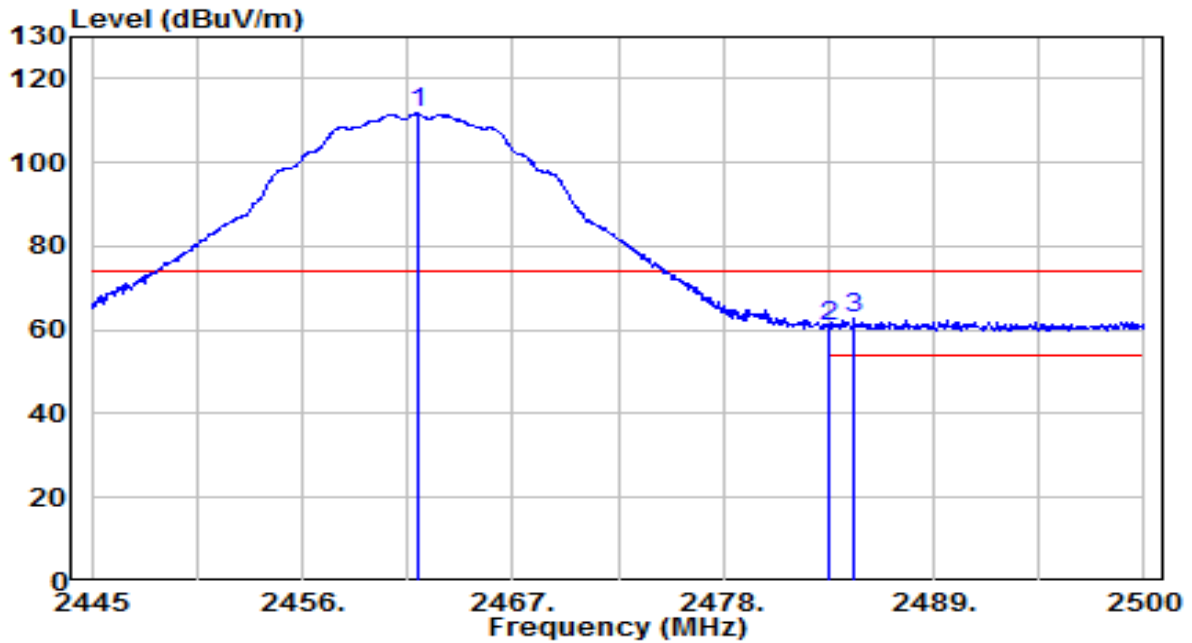

No	Frequency (MHz)	Reading (dBuV)	C.F (dB/m)	Measurement (dBuV/m)	Margin (dB)	Limit (dBuV/m)	Height (cm)	Angle (deg)	Remark (QP/PK/AV)
1	2462.050	79.26	32.44	111.71	N/A	N/A	125	270	Peak
2	2483.500	28.48	32.52	61.00	-13.00	74.00	125	270	Peak
3	* 2484.875	30.25	32.53	62.78	-11.22	74.00	125	270	Peak

Note:

1. " *", means this data is the worst emission level.
2. C.F (Correction Factor) = Antenna Factor (dB/m)+ Cable Loss (dB).
3. Measurement (dBuV/m) = Reading(dBuV) + C.F (Correction Factor).
4. The emission levels of other frequencies are very lower than the limit and not show in test report.

EUT	Pan/Tilt AI Home Security Wi-Fi Camera	Date of Test	2023-05-16
Factor	BBHA 9120D	Temp. / Humidity	24°C /59%
Polarity	Vertical	Site / Test Engineer	AC1 / Todd
Test Mode	802.11b_TX_CH 11_ANT 0	Test Voltage	AC 120V/60Hz

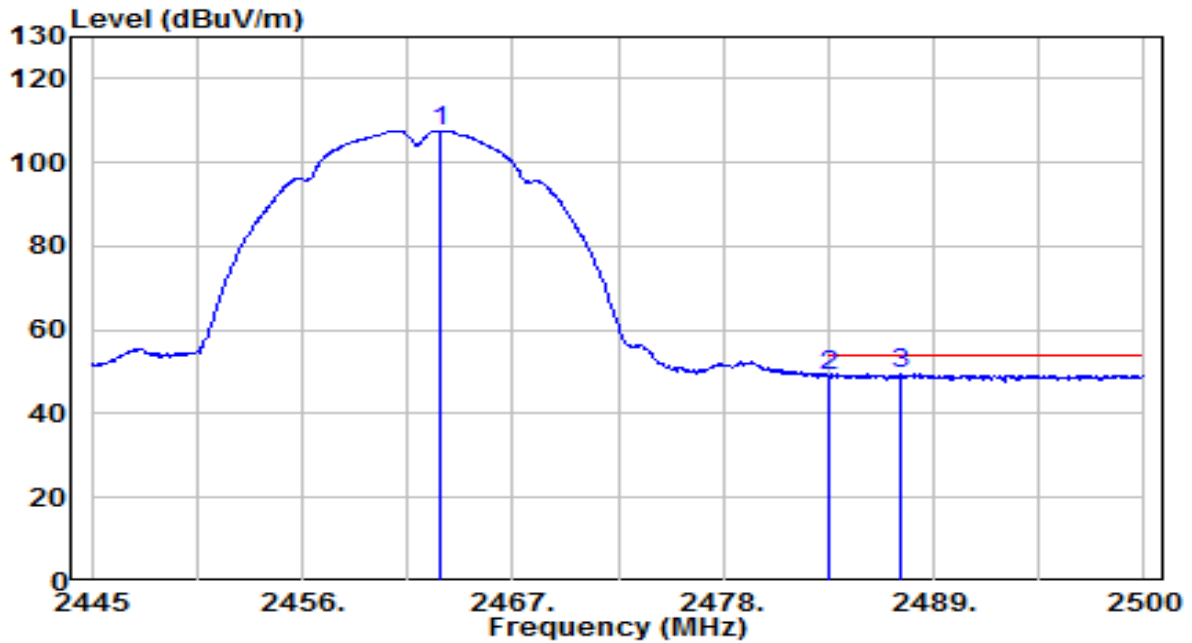

No	Frequency (MHz)	Reading (dBuV)	C.F (dB/m)	Measurement (dBuV/m)	Margin (dB)	Limit (dBuV/m)	Height (cm)	Angle (deg)	Remark (QP/PK/AV)
1	2463.205	75.16	32.45	107.61	N/A	N/A	125	270	Average
2	2483.500	16.31	32.52	48.83	-5.17	54.00	125	270	Average
3	* 2487.240	16.98	32.53	49.51	-4.49	54.00	125	270	Average

Note:

1. " *", means this data is the worst emission level.
2. C.F (Correction Factor) = Antenna Factor (dB/m)+ Cable Loss (dB).
3. Measurement (dBuV/m) = Reading(dBuV) + C.F (Correction Factor).
4. The emission levels of other frequencies are very lower than the limit and not show in test report.

EUT	Pan/Tilt AI Home Security Wi-Fi Camera	Date of Test	2023-05-16
Factor	BBHA 9120D	Temp. / Humidity	24°C /59%
Polarity	Horizontal	Site / Test Engineer	AC1 / Todd
Test Mode	802.11g_TX_CH 1_ANT 0	Test Voltage	AC 120V/60Hz

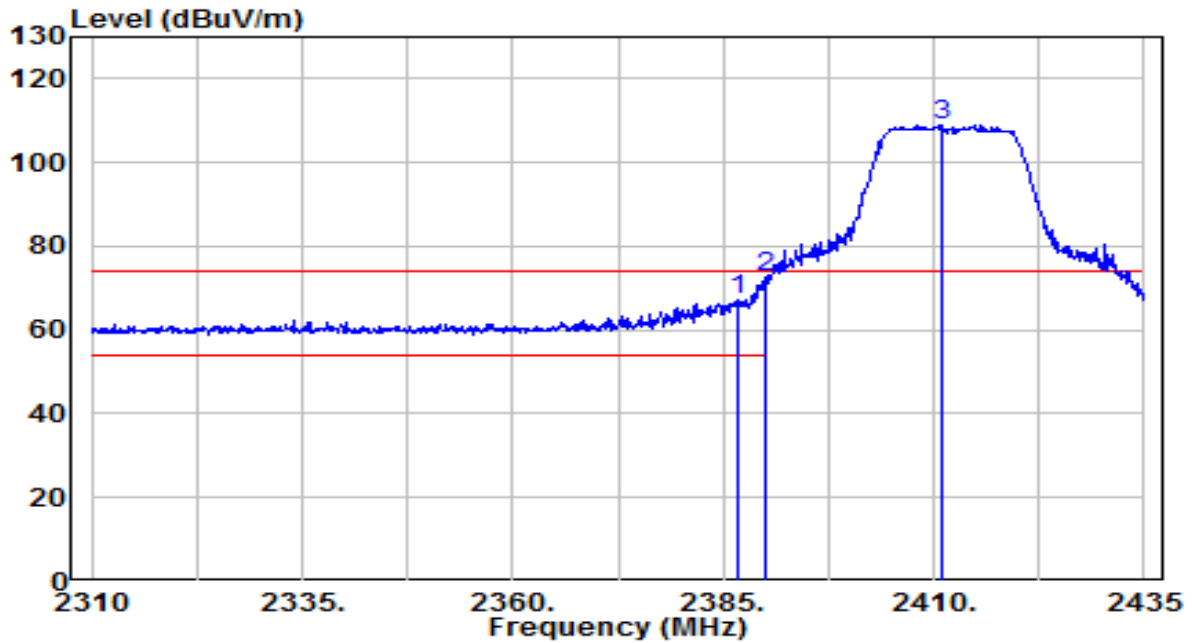

No	Frequency (MHz)	Reading (dBuV)	C.F (dB/m)	Measurement (dBuV/m)	Margin (dB)	Limit (dBuV/m)	Height (cm)	Angle (deg)	Remark (QP/PK/AV)
1	2386.625	35.27	32.17	67.44	-6.56	74.00	100	235	Peak
2	* 2390.000	40.28	32.18	72.47	-1.53	74.00	100	235	Peak
3	2411.000	76.84	32.26	109.09	N/A	N/A	100	235	Peak

Note:

1. " *", means this data is the worst emission level.
2. C.F (Correction Factor) = Antenna Factor (dB/m)+ Cable Loss (dB).
3. Measurement (dBuV/m) = Reading(dBuV) + C.F (Correction Factor).
4. The emission levels of other frequencies are very lower than the limit and not show in test report.

EUT	Pan/Tilt AI Home Security Wi-Fi Camera	Date of Test	2023-05-16
Factor	BBHA 9120D	Temp. / Humidity	24°C /59%
Polarity	Horizontal	Site / Test Engineer	AC1 / Todd
Test Mode	802.11g_TX_CH 1_ANT 0	Test Voltage	AC 120V/60Hz

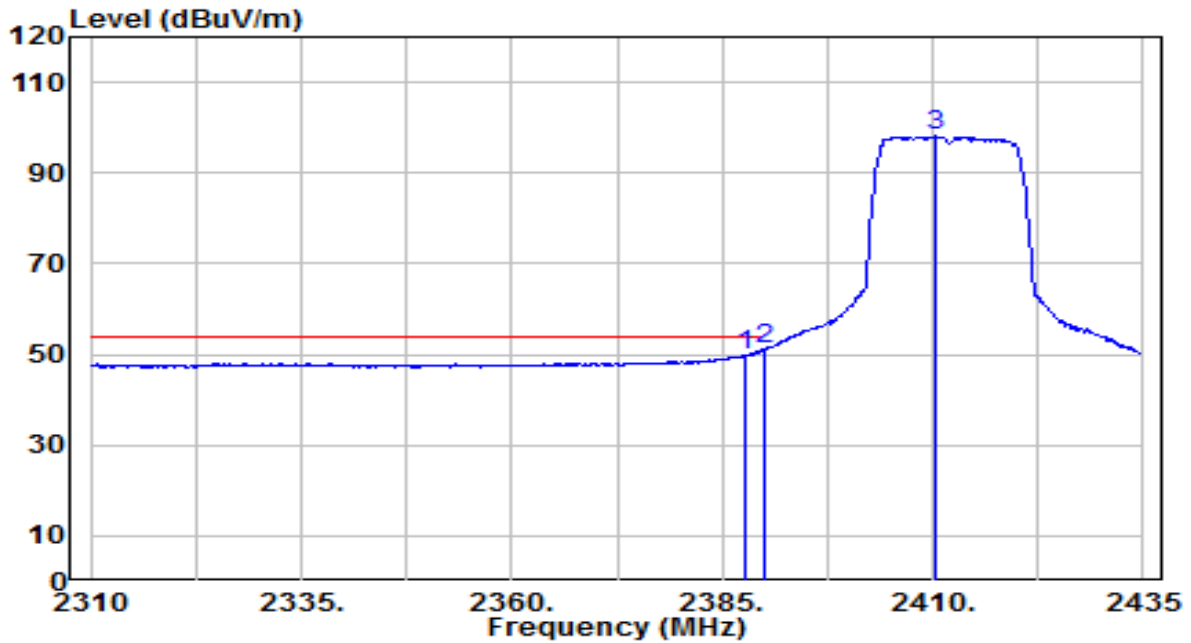

No	Frequency (MHz)	Reading (dBUV)	C.F (dB/m)	Measurement (dBUV/m)	Margin (dB)	Limit (dBUV/m)	Height (cm)	Angle (deg)	Remark (QP/PK/AV)
1	2387.750	17.61	32.18	49.78	-4.22	54.00	100	235	Average
2	* 2390.000	18.81	32.18	50.99	-3.01	54.00	100	235	Average
3	2410.250	65.84	32.26	98.10	N/A	N/A	100	235	Average

Note:

1. " *", means this data is the worst emission level.
2. C.F (Correction Factor) = Antenna Factor (dB/m)+ Cable Loss (dB).
3. Measurement (dBUV/m) = Reading(dBUV) + C.F (Correction Factor).
4. The emission levels of other frequencies are very lower than the limit and not show in test report.

EUT	Pan/Tilt AI Home Security Wi-Fi Camera	Date of Test	2023-05-16
Factor	BBHA 9120D	Temp. / Humidity	24°C /59%
Polarity	Vertical	Site / Test Engineer	AC1 / Todd
Test Mode	802.11g_TX_CH 1_ANT 0	Test Voltage	AC 120V/60Hz

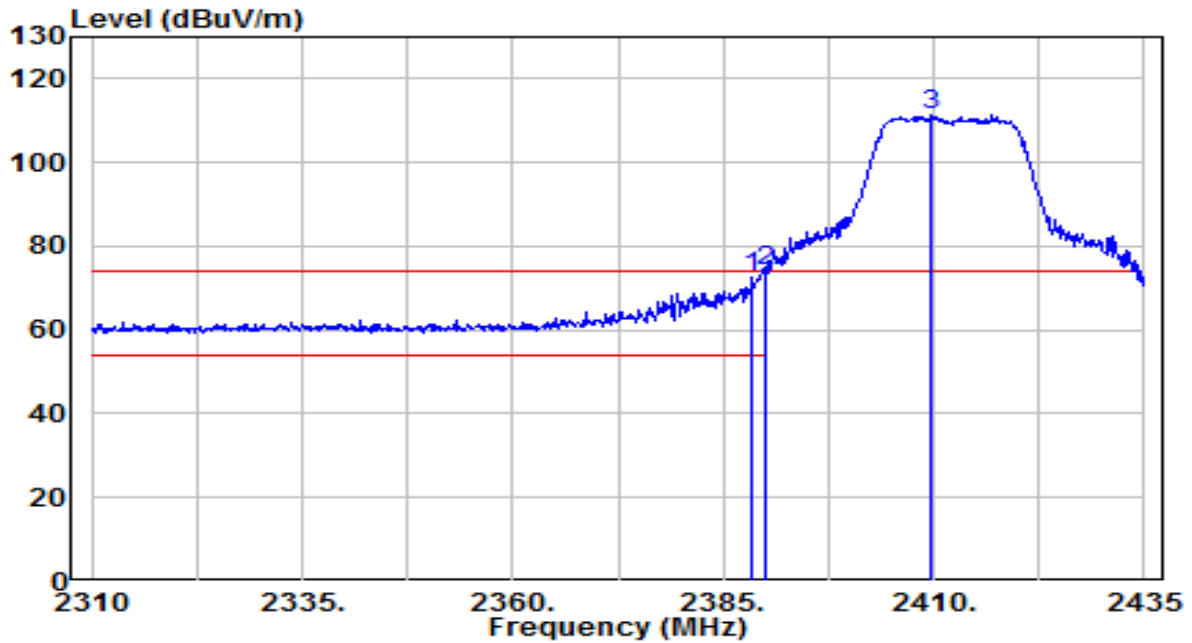

No	Frequency (MHz)	Reading (dBuV)	C.F (dB/m)	Measurement (dBuV/m)	Margin (dB)	Limit (dBuV/m)	Height (cm)	Angle (deg)	Remark (QP/PK/AV)
1	2388.500	40.65	32.18	72.83	-1.17	74.00	130	260	Peak
2	* 2390.000	41.66	32.18	73.84	-0.16	74.00	130	260	Peak
3	2409.625	79.16	32.25	111.42	N/A	N/A	130	260	Peak

Note:

1. " *", means this data is the worst emission level.
2. C.F (Correction Factor) = Antenna Factor (dB/m)+ Cable Loss (dB).
3. Measurement (dBuV/m) = Reading(dBuV) + C.F (Correction Factor).
4. The emission levels of other frequencies are very lower than the limit and not show in test report.

EUT	Pan/Tilt AI Home Security Wi-Fi Camera	Date of Test	2023-05-16
Factor	BBHA 9120D	Temp. / Humidity	24°C /59%
Polarity	Vertical	Site / Test Engineer	AC1 / Todd
Test Mode	802.11g_TX_CH 1_ANT 0	Test Voltage	AC 120V/60Hz

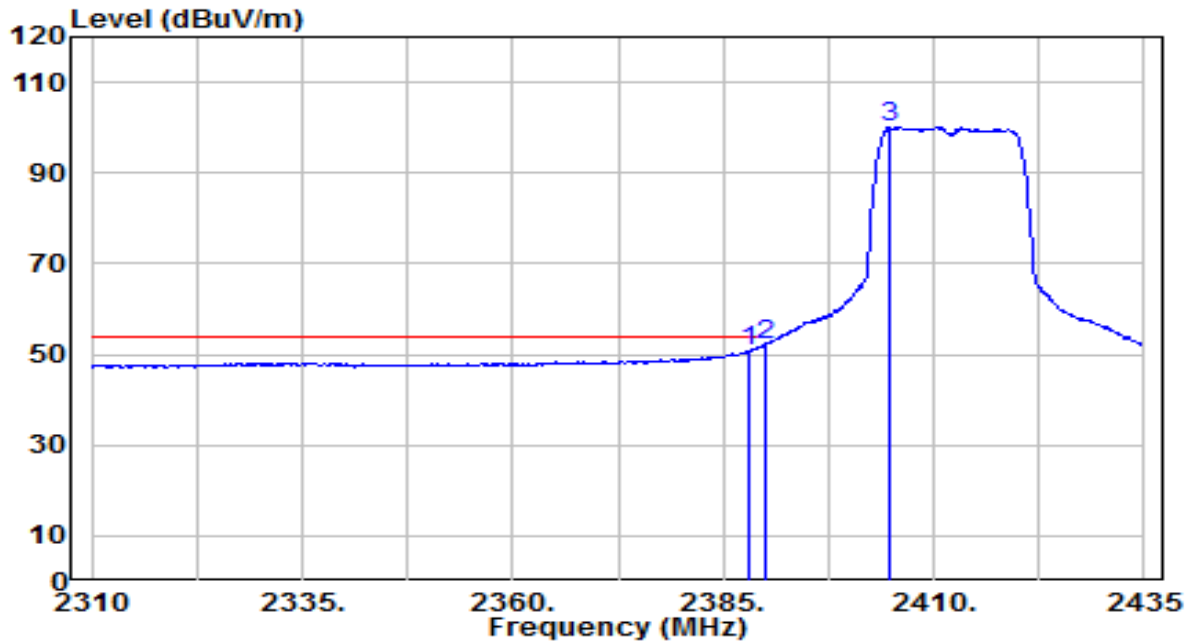

No	Frequency (MHz)	Reading (dBuV)	C.F (dB/m)	Measurement (dBuV/m)	Margin (dB)	Limit (dBuV/m)	Height (cm)	Angle (deg)	Remark (QP/PK/AV)
1	2388.000	18.46	32.18	50.64	-3.36	54.00	130	260	Average
2	* 2390.000	19.88	32.18	52.06	-1.94	54.00	130	260	Average
3	2404.625	67.89	32.24	100.13	N/A	N/A	130	260	Average

Note:

1. " *", means this data is the worst emission level.
2. C.F (Correction Factor) = Antenna Factor (dB/m)+ Cable Loss (dB).
3. Measurement (dBuV/m) = Reading(dBuV) + C.F (Correction Factor).
4. The emission levels of other frequencies are very lower than the limit and not show in test report.

EUT	Pan/Tilt AI Home Security Wi-Fi Camera	Date of Test	2023-05-16
Factor	BBHA 9120D	Temp. / Humidity	24°C /59%
Polarity	Horizontal	Site / Test Engineer	AC1 / Todd
Test Mode	802.11g_TX_CH 6_ANT 0	Test Voltage	AC 120V/60Hz

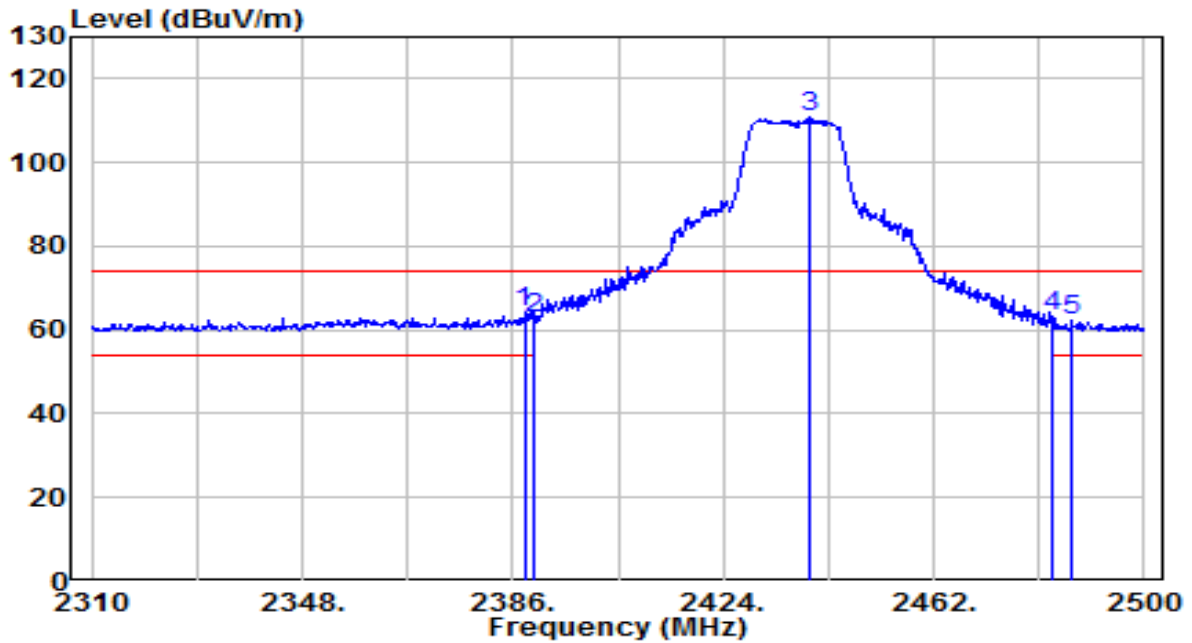

No	Frequency (MHz)	Reading (dBuV)	C.F (dB/m)	Measurement (dBuV/m)	Margin (dB)	Limit (dBuV/m)	Height (cm)	Angle (deg)	Remark (QP/PK/AV)
1	* 2388.090	32.25	32.18	64.43	-9.57	74.00	105	235	Peak
2	2390.000	30.42	32.18	62.61	-11.39	74.00	105	235	Peak
3	2439.390	78.34	32.36	110.70	N/A	N/A	105	235	Peak
4	2483.500	30.79	32.52	63.31	-10.69	74.00	105	235	Peak
5	2486.890	29.86	32.53	62.39	-11.61	74.00	105	235	Peak

Note:

1. " *", means this data is the worst emission level.
2. C.F (Correction Factor) = Antenna Factor (dB/m)+ Cable Loss (dB).
3. Measurement (dBuV/m) = Reading(dBuV) + C.F (Correction Factor).
4. The emission levels of other frequencies are very lower than the limit and not show in test report.

EUT	Pan/Tilt AI Home Security Wi-Fi Camera	Date of Test	2023-05-16
Factor	BBHA 9120D	Temp. / Humidity	24°C /59%
Polarity	Horizontal	Site / Test Engineer	AC1 / Todd
Test Mode	802.11g_TX_CH 6_ANT 0	Test Voltage	AC 120V/60Hz

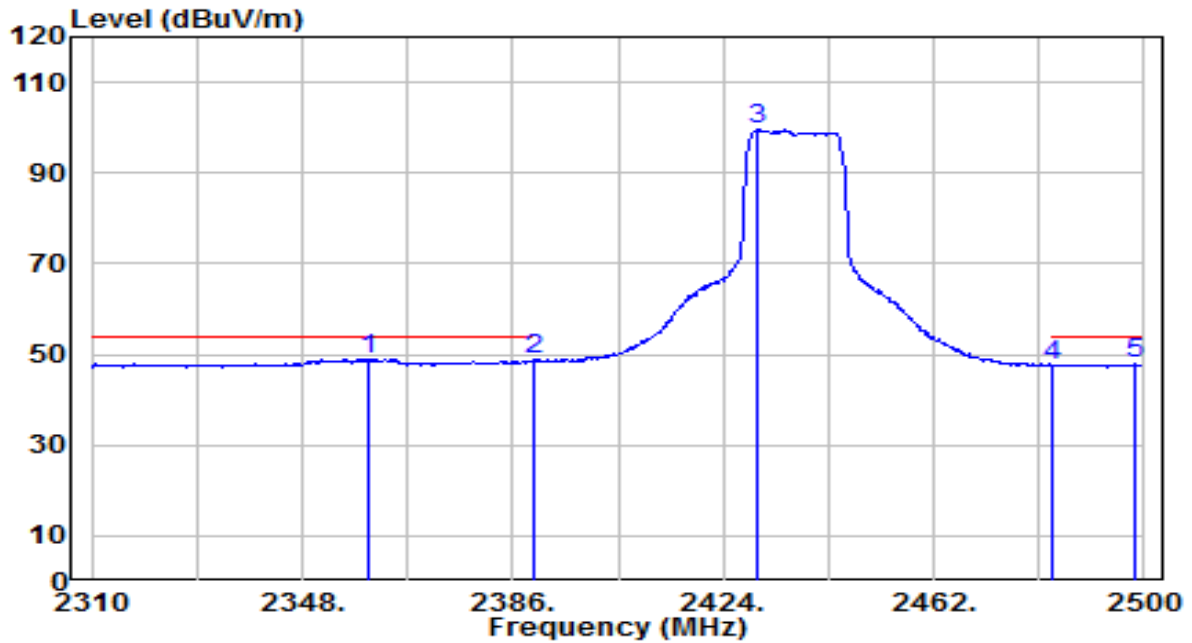

No	Frequency (MHz)	Reading (dBuV)	C.F (dB/m)	Measurement (dBuV/m)	Margin (dB)	Limit (dBuV/m)	Height (cm)	Angle (deg)	Remark (QP/PK/AV)
1	* 2359.970	16.86	32.08	48.93	-5.07	54.00	105	235	Average
2	2390.000	16.53	32.18	48.72	-5.28	54.00	105	235	Average
3	2430.080	67.12	32.33	99.45	N/A	N/A	105	235	Average
4	2483.500	14.92	32.52	47.44	-6.56	54.00	105	235	Average
5	2498.480	15.32	32.57	47.90	-6.10	54.00	105	235	Average

Note:

1. " *", means this data is the worst emission level.
2. C.F (Correction Factor) = Antenna Factor (dB/m)+ Cable Loss (dB).
3. Measurement (dBuV/m) = Reading(dBuV) + C.F (Correction Factor).
4. The emission levels of other frequencies are very lower than the limit and not show in test report.

EUT	Pan/Tilt AI Home Security Wi-Fi Camera	Date of Test	2023-05-16
Factor	BBHA 9120D	Temp. / Humidity	24°C /59%
Polarity	Vertical	Site / Test Engineer	AC1 / Todd
Test Mode	802.11g_TX_CH 6_ANT 0	Test Voltage	AC 120V/60Hz

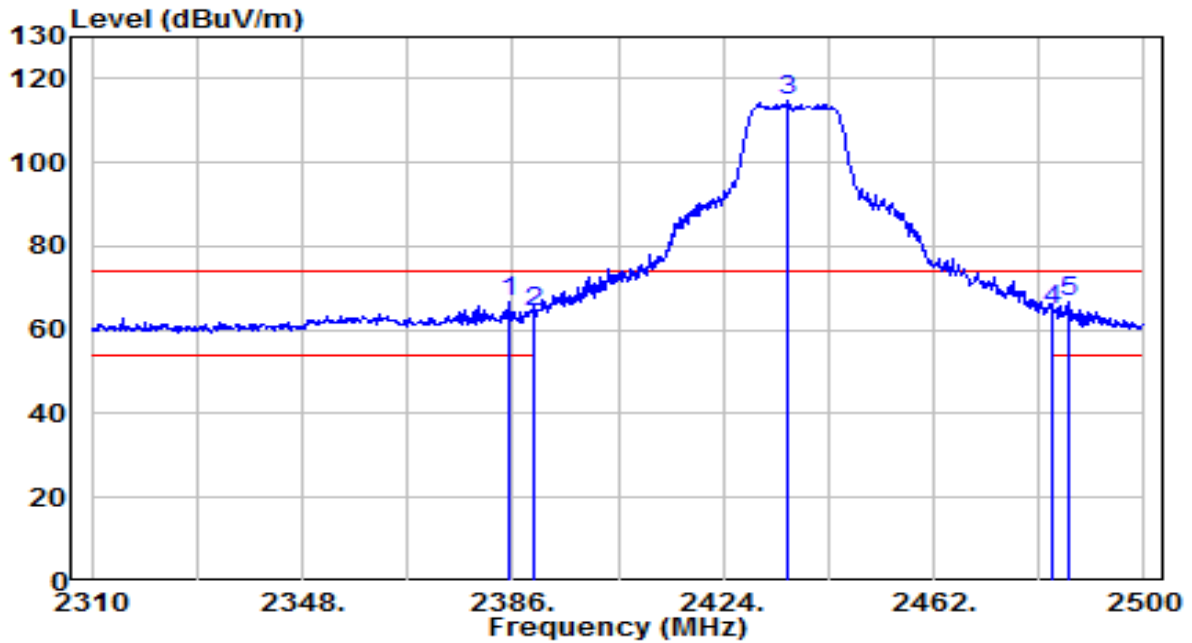

No	Frequency (MHz)	Reading (dBuV)	C.F (dB/m)	Measurement (dBuV/m)	Margin (dB)	Limit (dBuV/m)	Height (cm)	Angle (deg)	Remark (QP/PK/AV)
1	2385.240	34.32	32.17	66.49	-7.51	74.00	165	260	Peak
2	2390.000	32.09	32.18	64.27	-9.73	74.00	165	260	Peak
3	2435.400	82.28	32.35	114.63	N/A	N/A	165	260	Peak
4	2483.500	32.44	32.52	64.96	-9.04	74.00	165	260	Peak
5	* 2486.320	34.22	32.53	66.75	-7.25	74.00	165	260	Peak

Note:

1. " *", means this data is the worst emission level.
2. C.F (Correction Factor) = Antenna Factor (dB/m)+ Cable Loss (dB).
3. Measurement (dBuV/m) = Reading(dBuV) + C.F (Correction Factor).
4. The emission levels of other frequencies are very lower than the limit and not show in test report.

EUT	Pan/Tilt AI Home Security Wi-Fi Camera	Date of Test	2023-05-16
Factor	BBHA 9120D	Temp. / Humidity	24°C /59%
Polarity	Vertical	Site / Test Engineer	AC1 / Todd
Test Mode	802.11g_TX_CH 6_ANT 0	Test Voltage	AC 120V/60Hz

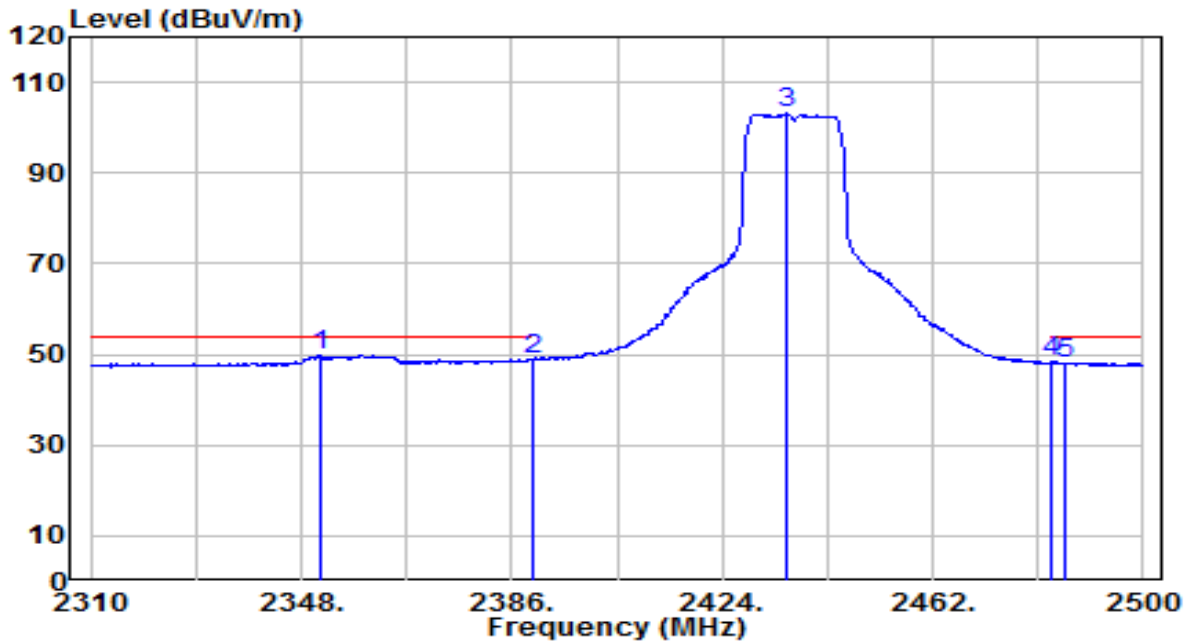

No	Frequency (MHz)	Reading (dBuV)	C.F (dB/m)	Measurement (dBuV/m)	Margin (dB)	Limit (dBuV/m)	Height (cm)	Angle (deg)	Remark (QP/PK/AV)
1	* 2351.420	17.72	32.05	49.76	-4.24	54.00	165	260	Average
2	2390.000	16.93	32.18	49.11	-4.89	54.00	165	260	Average
3	2435.780	70.68	32.35	103.03	N/A	N/A	165	260	Average
4	2483.500	15.79	32.52	48.32	-5.68	54.00	165	260	Average
5	2485.940	15.59	32.53	48.12	-5.88	54.00	165	260	Average

Note:

1. " *", means this data is the worst emission level.
2. C.F (Correction Factor) = Antenna Factor (dB/m)+ Cable Loss (dB).
3. Measurement (dBuV/m) = Reading(dBuV) + C.F (Correction Factor).
4. The emission levels of other frequencies are very lower than the limit and not show in test report.

EUT	Pan/Tilt AI Home Security Wi-Fi Camera	Date of Test	2023-05-16
Factor	BBHA 9120D	Temp. / Humidity	24°C /59%
Polarity	Horizontal	Site / Test Engineer	AC1 / Todd
Test Mode	802.11g_TX_CH 11_ANT 0	Test Voltage	AC 120V/60Hz

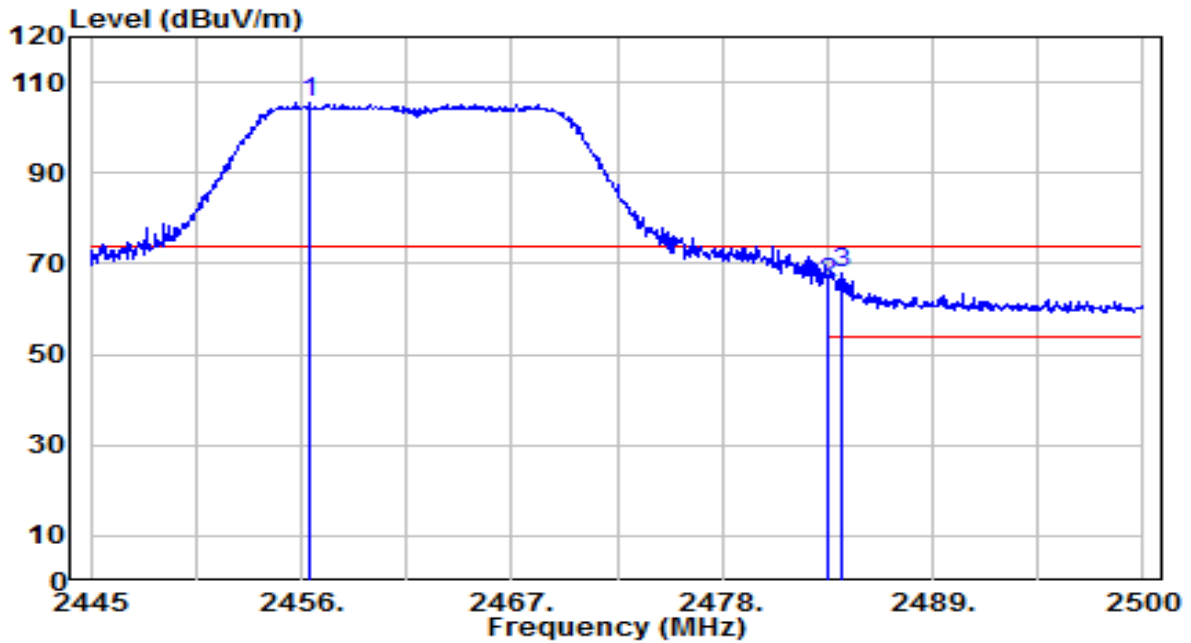

No	Frequency (MHz)	Reading (dBuV)	C.F (dB/m)	Measurement (dBuV/m)	Margin (dB)	Limit (dBuV/m)	Height (cm)	Angle (deg)	Remark (QP/PK/AV)
1	2456.385	73.17	32.42	105.59	N/A	N/A	125	240	Peak
2	2483.500	33.03	32.52	65.55	-8.45	74.00	125	240	Peak
3	* 2484.215	35.24	32.52	67.77	-6.23	74.00	125	240	Peak

Note:

1. " *", means this data is the worst emission level.
2. C.F (Correction Factor) = Antenna Factor (dB/m)+ Cable Loss (dB).
3. Measurement (dBuV/m) = Reading(dBuV) + C.F (Correction Factor).
4. The emission levels of other frequencies are very lower than the limit and not show in test report.

EUT	Pan/Tilt AI Home Security Wi-Fi Camera	Date of Test	2023-05-16
Factor	BBHA 9120D	Temp. / Humidity	24°C /59%
Polarity	Horizontal	Site / Test Engineer	AC1 / Todd
Test Mode	802.11g_TX_CH 11_ANT 0	Test Voltage	AC 120V/60Hz

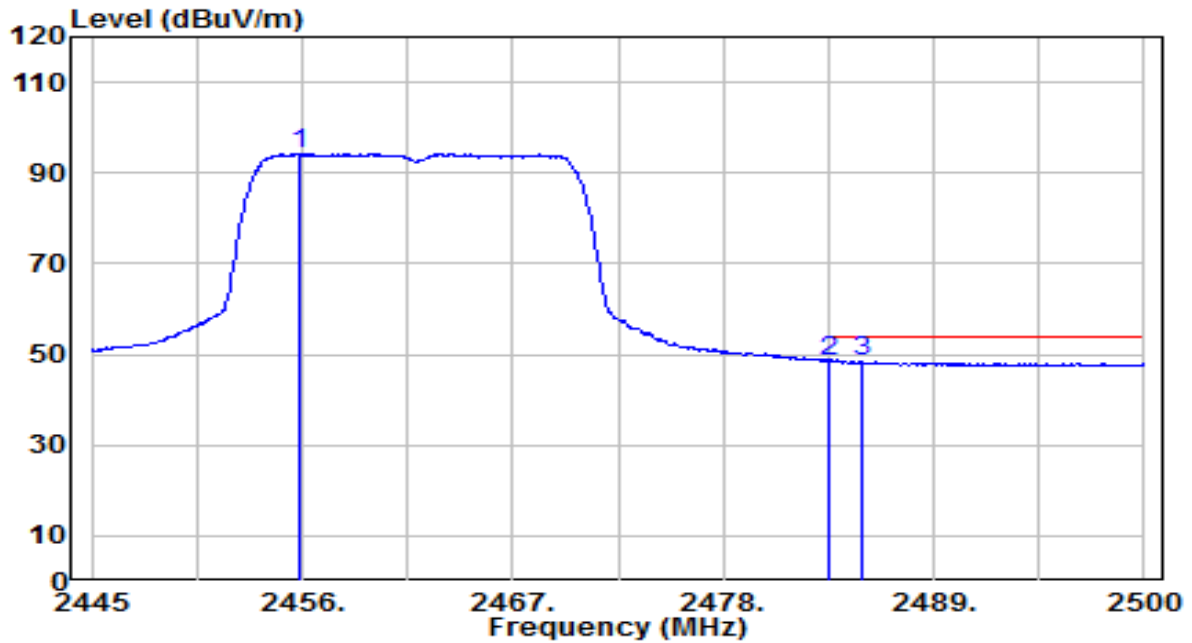

No	Frequency (MHz)	Reading (dBuV)	C.F (dB/m)	Measurement (dBuV/m)	Margin (dB)	Limit (dBuV/m)	Height (cm)	Angle (deg)	Remark (QP/PK/AV)
1	2455.890	61.73	32.42	94.15	N/A	N/A	125	240	Average
2	* 2483.500	16.16	32.52	48.68	-5.32	54.00	125	240	Average
3	2485.205	15.95	32.53	48.48	-5.52	54.00	125	240	Average

Note:

1. " *", means this data is the worst emission level.
2. C.F (Correction Factor) = Antenna Factor (dB/m)+ Cable Loss (dB).
3. Measurement (dBuV/m) = Reading(dBuV) + C.F (Correction Factor).
4. The emission levels of other frequencies are very lower than the limit and not show in test report.

EUT	Pan/Tilt AI Home Security Wi-Fi Camera	Date of Test	2023-05-16
Factor	BBHA 9120D	Temp. / Humidity	24°C /59%
Polarity	Vertical	Site / Test Engineer	AC1 / Todd
Test Mode	802.11g_TX_CH 11_ANT 0	Test Voltage	AC 120V/60Hz

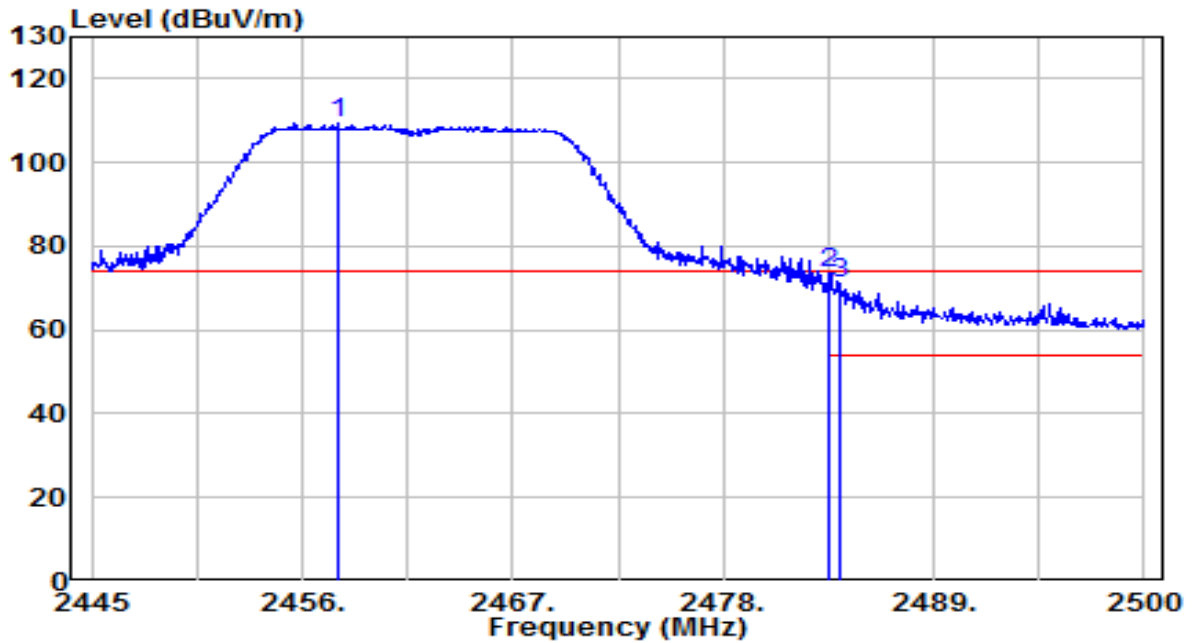

No	Frequency (MHz)	Reading (dBuV)	C.F (dB/m)	Measurement (dBuV/m)	Margin (dB)	Limit (dBuV/m)	Height (cm)	Angle (deg)	Remark (QP/PK/AV)
1	2457.815	77.05	32.43	109.48	N/A	N/A	125	270	Peak
2	* 2483.500	41.22	32.52	73.74	-0.26	74.00	125	270	Peak
3	2484.050	38.51	32.52	71.03	-2.97	74.00	125	270	Peak

Note:

1. " *", means this data is the worst emission level.
2. C.F (Correction Factor) = Antenna Factor (dB/m)+ Cable Loss (dB).
3. Measurement (dBuV/m) = Reading(dBuV) + C.F (Correction Factor).
4. The emission levels of other frequencies are very lower than the limit and not show in test report.

EUT	Pan/Tilt AI Home Security Wi-Fi Camera	Date of Test	2023-05-16
Factor	BBHA 9120D	Temp. / Humidity	24°C /59%
Polarity	Vertical	Site / Test Engineer	AC1 / Todd
Test Mode	802.11g_TX_CH 11_ANT 0	Test Voltage	AC 120V/60Hz

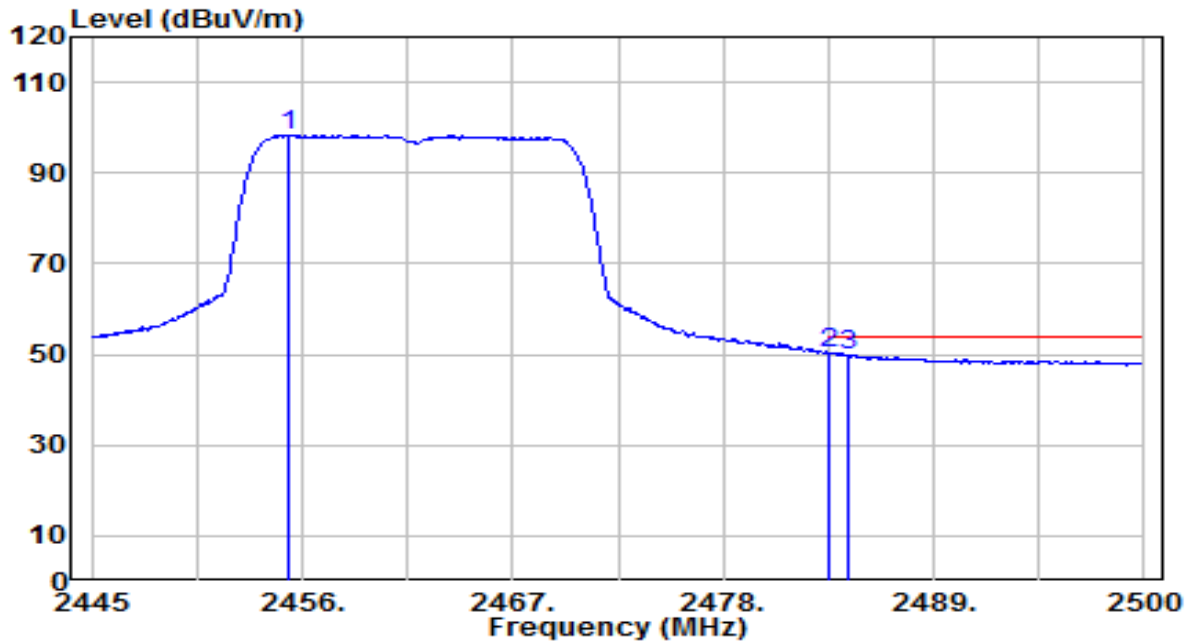

No	Frequency (MHz)	Reading (dBuV)	C.F (dB/m)	Measurement (dBuV/m)	Margin (dB)	Limit (dBuV/m)	Height (cm)	Angle (deg)	Remark (QP/PK/AV)
1	2455.230	65.92	32.42	98.34	N/A	N/A	125	270	Average
2	* 2483.500	17.81	32.52	50.33	-3.67	54.00	125	270	Average
3	2484.600	17.25	32.52	49.77	-4.23	54.00	125	270	Average

Note:

1. " *", means this data is the worst emission level.
2. C.F (Correction Factor) = Antenna Factor (dB/m)+ Cable Loss (dB).
3. Measurement (dBuV/m) = Reading(dBuV) + C.F (Correction Factor).
4. The emission levels of other frequencies are very lower than the limit and not show in test report.

EUT	Pan/Tilt AI Home Security Wi-Fi Camera	Date of Test	2023-05-16
Factor	BBHA 9120D	Temp. / Humidity	24°C /59%
Polarity	Horizontal	Site / Test Engineer	AC1 / Todd
Test Mode	802.11n-20MHz_TX_CH 1_ANT 0	Test Voltage	AC 120V/60Hz

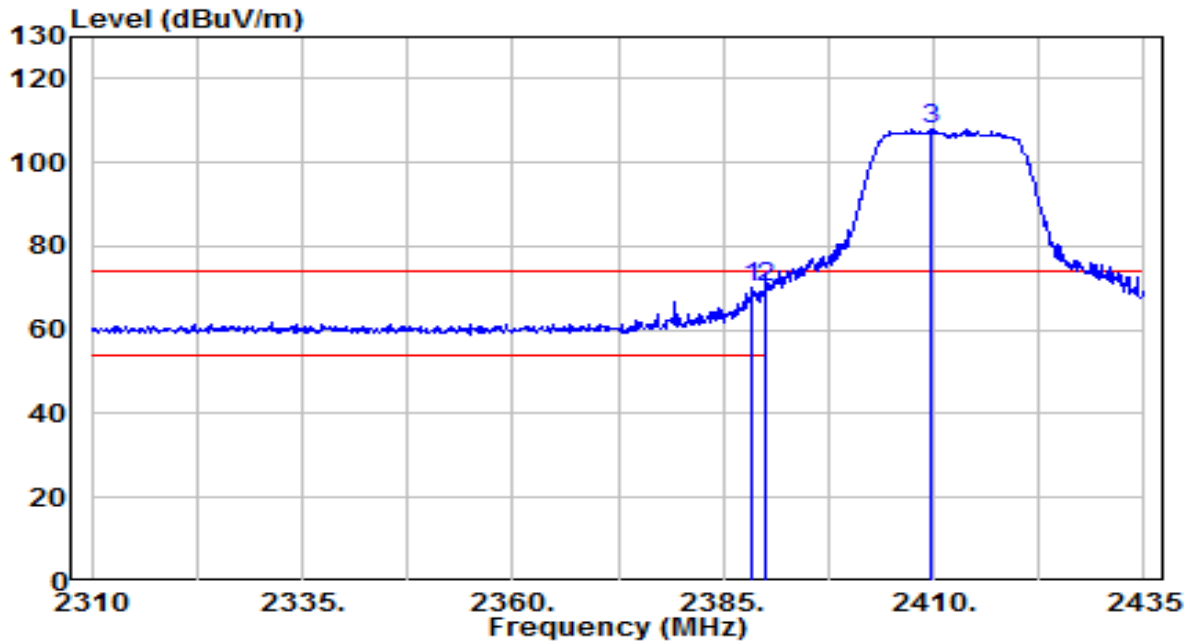

No	Frequency (MHz)	Reading (dBuV)	C.F (dB/m)	Measurement (dBuV/m)	Margin (dB)	Limit (dBuV/m)	Height (cm)	Angle (deg)	Remark (QP/PK/AV)	
1	*	2388.500	38.08	32.18	70.26	-3.74	74.00	100	235	Peak
2		2390.000	37.91	32.18	70.10	-3.90	74.00	100	235	Peak
3		2409.625	75.58	32.25	107.83	N/A	N/A	100	235	Peak

Note:

1. " *", means this data is the worst emission level.
2. C.F (Correction Factor) = Antenna Factor (dB/m)+ Cable Loss (dB).
3. Measurement (dBuV/m) = Reading(dBuV) + C.F (Correction Factor).
4. The emission levels of other frequencies are very lower than the limit and not show in test report.

EUT	Pan/Tilt AI Home Security Wi-Fi Camera	Date of Test	2023-05-16
Factor	BBHA 9120D	Temp. / Humidity	24°C /59%
Polarity	Horizontal	Site / Test Engineer	AC1 / Todd
Test Mode	802.11n-20MHz_TX_CH 1_ANT 0	Test Voltage	AC 120V/60Hz

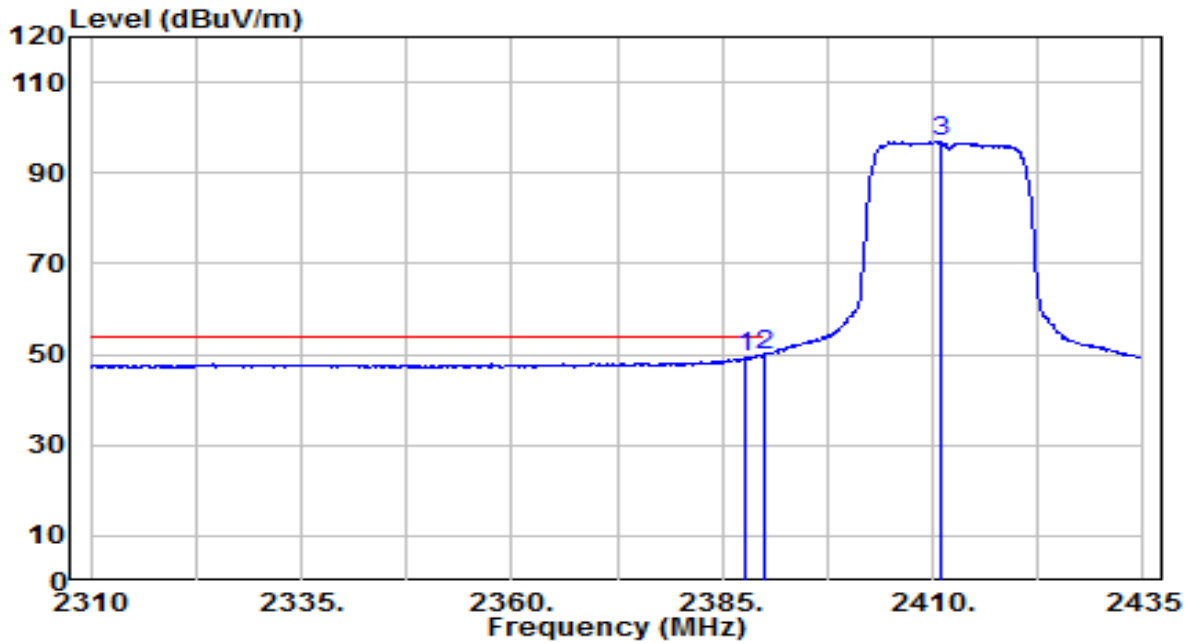

No	Frequency (MHz)	Reading (dBuV)	C.F (dB/m)	Measurement (dBuV/m)	Margin (dB)	Limit (dBuV/m)	Height (cm)	Angle (deg)	Remark (QP/PK/AV)
1	2387.750	17.01	32.18	49.18	-4.82	54.00	100	235	Average
2	* 2390.000	17.81	32.18	49.99	-4.01	54.00	100	235	Average
3	2411.000	64.54	32.26	96.80	N/A	N/A	100	235	Average

Note:

1. " *", means this data is the worst emission level.
2. C.F (Correction Factor) = Antenna Factor (dB/m)+ Cable Loss (dB).
3. Measurement (dBuV/m) = Reading(dBuV) + C.F (Correction Factor).
4. The emission levels of other frequencies are very lower than the limit and not show in test report.

EUT	Pan/Tilt AI Home Security Wi-Fi Camera	Date of Test	2023-05-16
Factor	BBHA 9120D	Temp. / Humidity	24°C /59%
Polarity	Vertical	Site / Test Engineer	AC1 / Todd
Test Mode	802.11n-20MHz_TX_CH 1_ANT 0	Test Voltage	AC 120V/60Hz

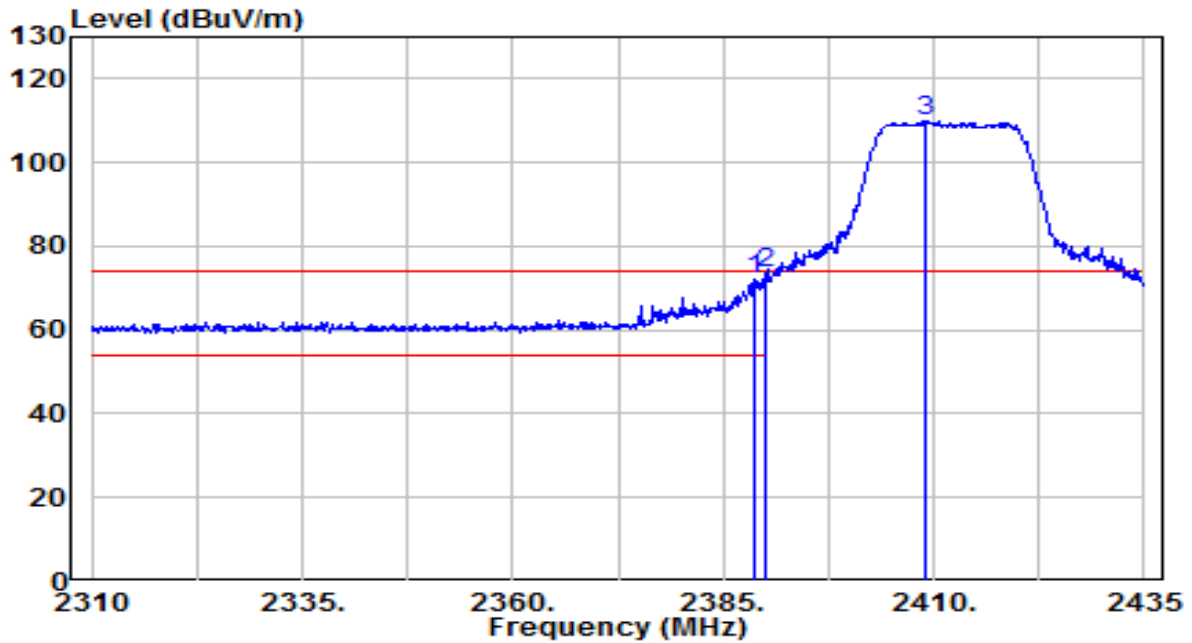

No	Frequency (MHz)	Reading (dBuV)	C.F (dB/m)	Measurement (dBuV/m)	Margin (dB)	Limit (dBuV/m)	Height (cm)	Angle (deg)	Remark (QP/PK/AV)
1	2388.625	39.75	32.18	71.93	-2.07	74.00	130	260	Peak
2	* 2390.000	41.64	32.18	73.82	-0.18	74.00	130	260	Peak
3	2409.125	77.59	32.25	109.84	N/A	N/A	130	260	Peak

Note:

1. " *", means this data is the worst emission level.
2. C.F (Correction Factor) = Antenna Factor (dB/m)+ Cable Loss (dB).
3. Measurement (dBuV/m) = Reading(dBuV) + C.F (Correction Factor).
4. The emission levels of other frequencies are very lower than the limit and not show in test report.

EUT	Pan/Tilt AI Home Security Wi-Fi Camera	Date of Test	2023-05-16
Factor	BBHA 9120D	Temp. / Humidity	24°C /59%
Polarity	Vertical	Site / Test Engineer	AC1 / Todd
Test Mode	802.11n-20MHz_TX_CH 1_ANT 0	Test Voltage	AC 120V/60Hz

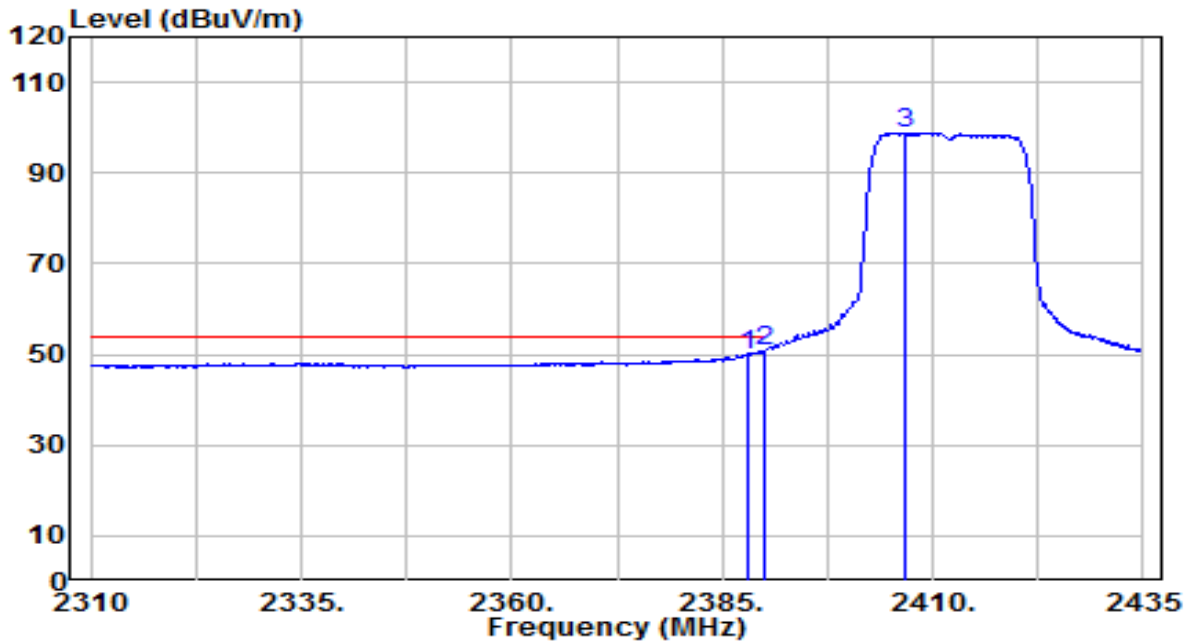

No	Frequency (MHz)	Reading (dBuV)	C.F (dB/m)	Measurement (dBuV/m)	Margin (dB)	Limit (dBuV/m)	Height (cm)	Angle (deg)	Remark (QP/PK/AV)
1	2388.000	17.75	32.18	49.93	-4.07	54.00	130	260	Average
2	* 2390.000	18.61	32.18	50.79	-3.21	54.00	130	260	Average
3	2406.875	66.60	32.24	98.85	N/A	N/A	130	260	Average

Note:

1. " *", means this data is the worst emission level.
2. C.F (Correction Factor) = Antenna Factor (dB/m)+ Cable Loss (dB).
3. Measurement (dBuV/m) = Reading(dBuV) + C.F (Correction Factor).
4. The emission levels of other frequencies are very lower than the limit and not show in test report.

EUT	Pan/Tilt AI Home Security Wi-Fi Camera	Date of Test	2023-05-16
Factor	BBHA 9120D	Temp. / Humidity	24°C /59%
Polarity	Horizontal	Site / Test Engineer	AC1 / Todd
Test Mode	802.11n-20MHz_TX_CH 6_ANT 0	Test Voltage	AC 120V/60Hz

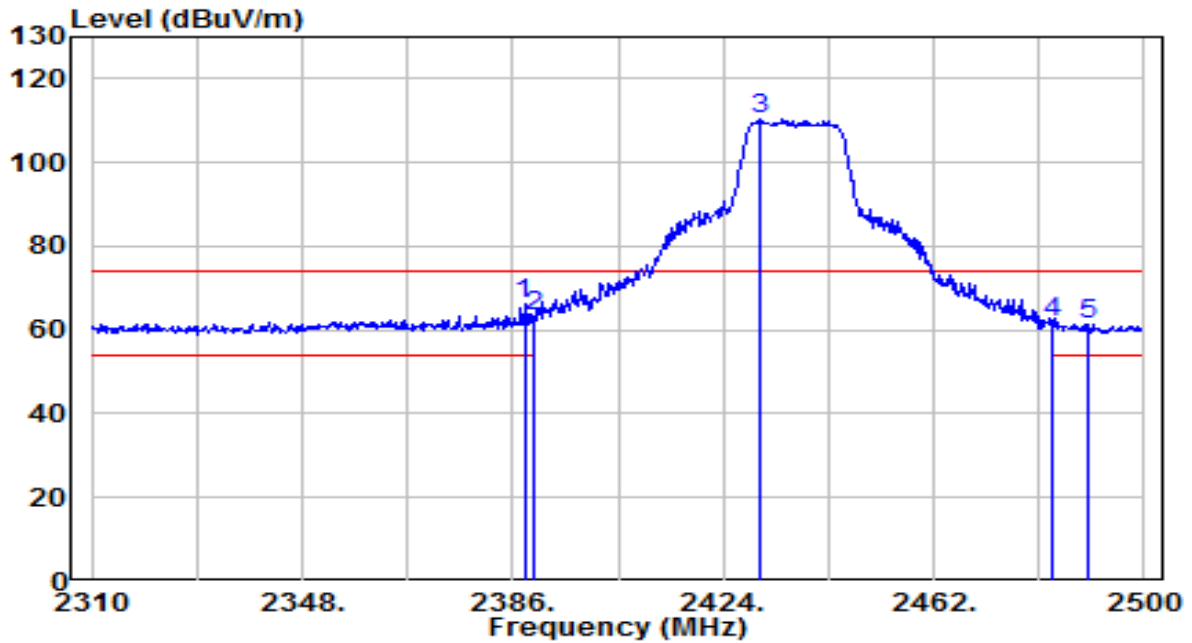

No	Frequency (MHz)	Reading (dBuV)	C.F (dB/m)	Measurement (dBuV/m)	Margin (dB)	Limit (dBuV/m)	Height (cm)	Angle (deg)	Remark (QP/PK/AV)	
1	*	2388.090	34.26	32.18	66.44	-7.56	74.00	105	235	Peak
2		2390.000	31.13	32.18	63.32	-10.68	74.00	105	235	Peak
3		2430.650	77.97	32.33	110.30	N/A	N/A	105	235	Peak
4		2483.500	29.35	32.52	61.87	-12.13	74.00	105	235	Peak
5		2489.740	28.92	32.54	61.46	-12.54	74.00	105	235	Peak

Note:

1. " *", means this data is the worst emission level.
2. C.F (Correction Factor) = Antenna Factor (dB/m)+ Cable Loss (dB).
3. Measurement (dBuV/m) = Reading(dBuV) + C.F (Correction Factor).
4. The emission levels of other frequencies are very lower than the limit and not show in test report.

EUT	Pan/Tilt AI Home Security Wi-Fi Camera	Date of Test	2023-05-16
Factor	BBHA 9120D	Temp. / Humidity	24°C /59%
Polarity	Horizontal	Site / Test Engineer	AC1 / Todd
Test Mode	802.11n-20MHz_TX_CH 6_ANT 0	Test Voltage	AC 120V/60Hz

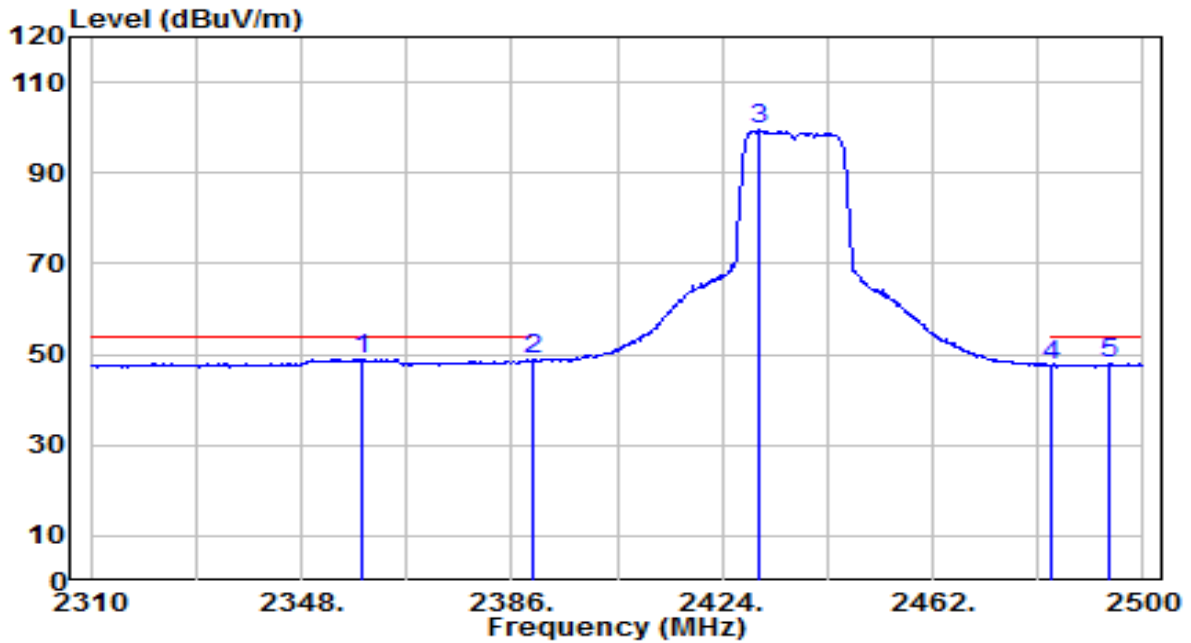

No	Frequency (MHz)	Reading (dBuV)	C.F (dB/m)	Measurement (dBuV/m)	Margin (dB)	Limit (dBuV/m)	Height (cm)	Angle (deg)	Remark (QP/PK/AV)
1	* 2359.020	16.91	32.07	48.99	-5.01	54.00	105	235	Average
2	2390.000	16.60	32.18	48.78	-5.22	54.00	105	235	Average
3	2430.460	67.08	32.33	99.41	N/A	N/A	105	235	Average
4	2483.500	15.16	32.52	47.68	-6.32	54.00	105	235	Average
5	2493.920	15.34	32.56	47.89	-6.11	54.00	105	235	Average

Note:

1. " *", means this data is the worst emission level.
2. C.F (Correction Factor) = Antenna Factor (dB/m)+ Cable Loss (dB).
3. Measurement (dBuV/m) = Reading(dBuV) + C.F (Correction Factor).
4. The emission levels of other frequencies are very lower than the limit and not show in test report.

EUT	Pan/Tilt AI Home Security Wi-Fi Camera	Date of Test	2023-05-16
Factor	BBHA 9120D	Temp. / Humidity	24°C /59%
Polarity	Vertical	Site / Test Engineer	AC1 / Todd
Test Mode	802.11n-20MHz_TX_CH 6_ANT 0	Test Voltage	AC 120V/60Hz

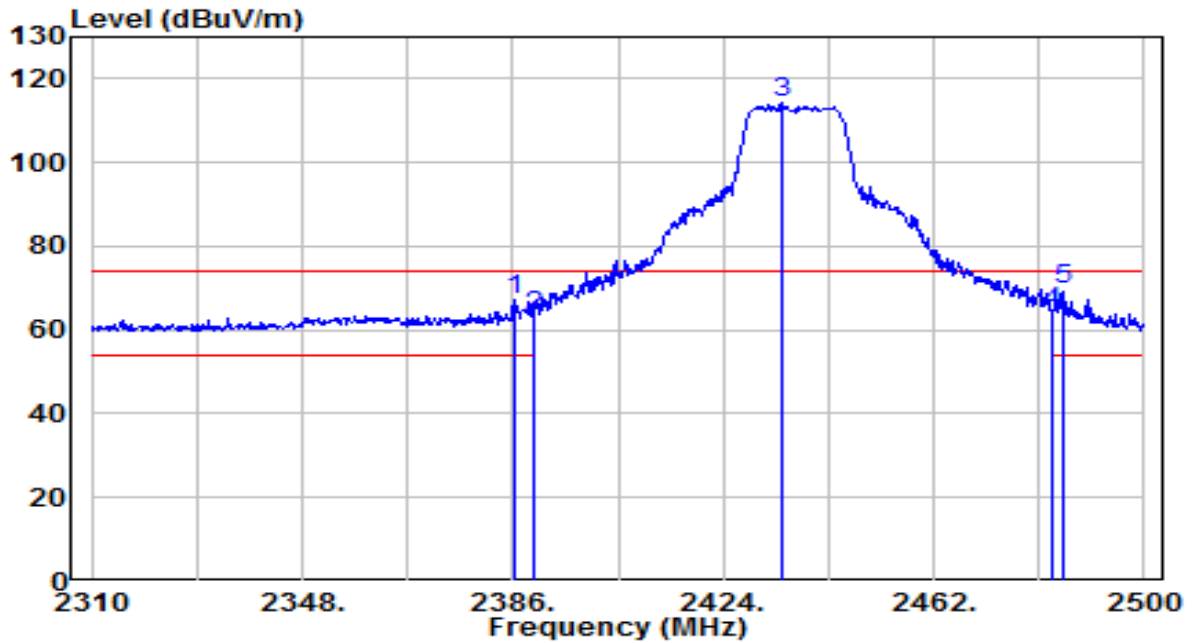

No	Frequency (MHz)	Reading (dBuV)	C.F (dB/m)	Measurement (dBuV/m)	Margin (dB)	Limit (dBuV/m)	Height (cm)	Angle (deg)	Remark (QP/PK/AV)
1	2386.190	35.04	32.17	67.21	-6.79	74.00	165	260	Peak
2	2390.000	31.30	32.18	63.48	-10.52	74.00	165	260	Peak
3	2434.830	81.83	32.35	114.17	N/A	N/A	165	260	Peak
4	2483.500	31.80	32.52	64.32	-9.68	74.00	165	260	Peak
5	* 2485.560	36.92	32.53	69.45	-4.55	74.00	165	260	Peak

Note:

1. " *", means this data is the worst emission level.
2. C.F (Correction Factor) = Antenna Factor (dB/m)+ Cable Loss (dB).
3. Measurement (dBuV/m) = Reading(dBuV) + C.F (Correction Factor).
4. The emission levels of other frequencies are very lower than the limit and not show in test report.

EUT	Pan/Tilt AI Home Security Wi-Fi Camera	Date of Test	2023-05-16
Factor	BBHA 9120D	Temp. / Humidity	24°C /59%
Polarity	Vertical	Site / Test Engineer	AC1 / Todd
Test Mode	802.11n-20MHz_TX_CH 6_ANT 0	Test Voltage	AC 120V/60Hz

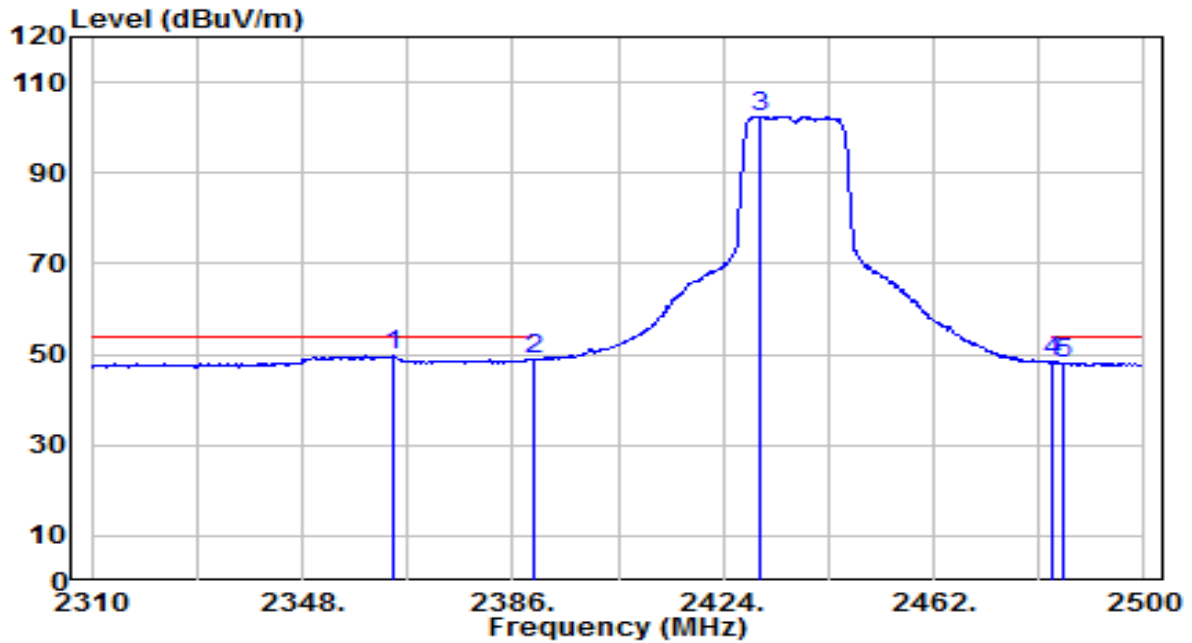

No	Frequency (MHz)	Reading (dBuV)	C.F (dB/m)	Measurement (dBuV/m)	Margin (dB)	Limit (dBuV/m)	Height (cm)	Angle (deg)	Remark (QP/PK/AV)
1	* 2364.340	17.50	32.09	49.59	-4.41	54.00	165	260	Average
2	2390.000	16.85	32.18	49.04	-4.96	54.00	165	260	Average
3	2430.460	70.18	32.33	102.51	N/A	N/A	165	260	Average
4	2483.500	15.77	32.52	48.30	-5.70	54.00	165	260	Average
5	2485.370	15.67	32.53	48.20	-5.80	54.00	165	260	Average

Note:

1. " *", means this data is the worst emission level.
2. C.F (Correction Factor) = Antenna Factor (dB/m)+ Cable Loss (dB).
3. Measurement (dBuV/m) = Reading(dBuV) + C.F (Correction Factor).
4. The emission levels of other frequencies are very lower than the limit and not show in test report.

EUT	Pan/Tilt AI Home Security Wi-Fi Camera	Date of Test	2023-05-16
Factor	BBHA 9120D	Temp. / Humidity	24°C /59%
Polarity	Horizontal	Site / Test Engineer	AC1 / Todd
Test Mode	802.11n-20MHz_TX_CH 11_ANT 0	Test Voltage	AC 120V/60Hz

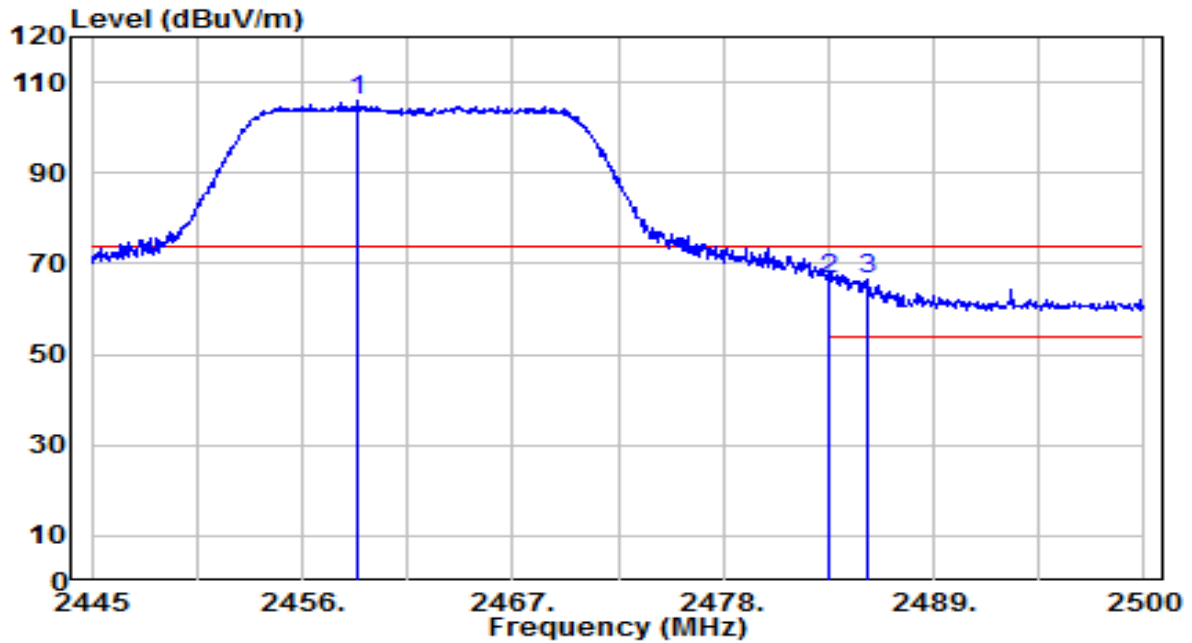

No	Frequency (MHz)	Reading (dBuV)	C.F (dB/m)	Measurement (dBuV/m)	Margin (dB)	Limit (dBuV/m)	Height (cm)	Angle (deg)	Remark (QP/PK/AV)
1	2458.860	73.34	32.43	105.77	N/A	N/A	125	240	Peak
2	2483.500	34.06	32.52	66.59	-7.41	74.00	125	240	Peak
3	* 2485.480	34.22	32.53	66.75	-7.25	74.00	125	240	Peak

Note:

1. " *", means this data is the worst emission level.
2. C.F (Correction Factor) = Antenna Factor (dB/m)+ Cable Loss (dB).
3. Measurement (dBuV/m) = Reading(dBuV) + C.F (Correction Factor).
4. The emission levels of other frequencies are very lower than the limit and not show in test report.

EUT	Pan/Tilt AI Home Security Wi-Fi Camera	Date of Test	2023-05-16
Factor	BBHA 9120D	Temp. / Humidity	24°C /59%
Polarity	Horizontal	Site / Test Engineer	AC1 / Todd
Test Mode	802.11n-20MHz_TX_CH 11_ANT 0	Test Voltage	AC 120V/60Hz

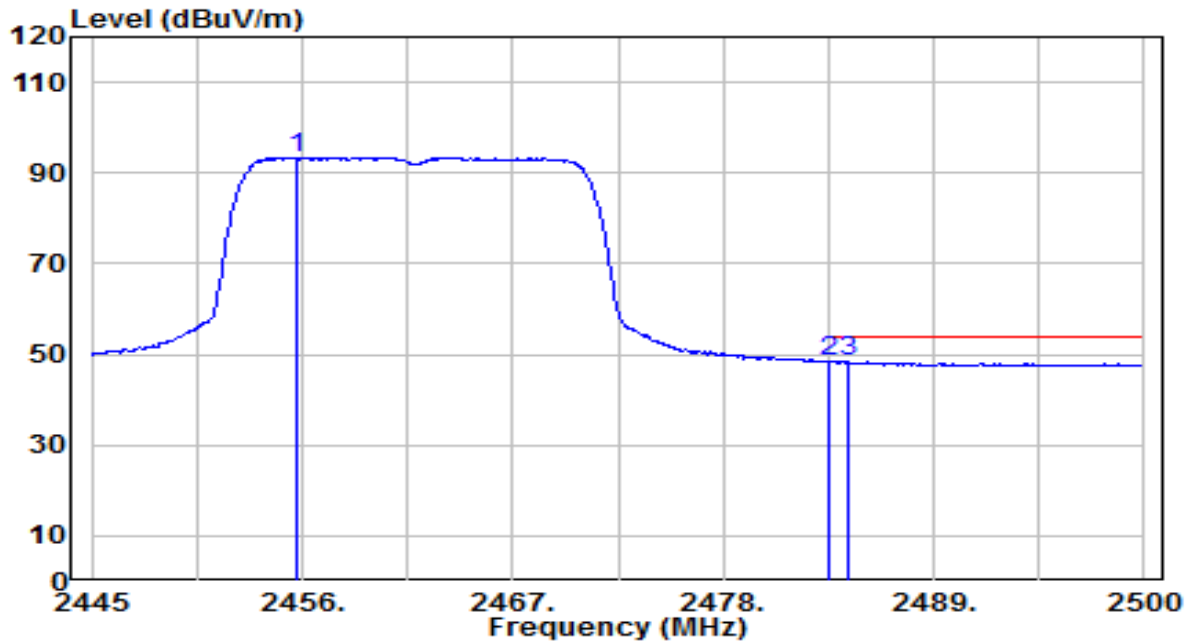

No	Frequency (MHz)	Reading (dBuV)	C.F (dB/m)	Measurement (dBuV/m)	Margin (dB)	Limit (dBuV/m)	Height (cm)	Angle (deg)	Remark (QP/PK/AV)
1	2455.780	61.06	32.42	93.48	N/A	N/A	125	240	Average
2	* 2483.500	16.09	32.52	48.61	-5.39	54.00	125	240	Average
3	2484.545	15.74	32.52	48.27	-5.73	54.00	125	240	Average

Note:

1. " *", means this data is the worst emission level.
2. C.F (Correction Factor) = Antenna Factor (dB/m)+ Cable Loss (dB).
3. Measurement (dBuV/m) = Reading(dBuV) + C.F (Correction Factor).
4. The emission levels of other frequencies are very lower than the limit and not show in test report.

EUT	Pan/Tilt AI Home Security Wi-Fi Camera	Date of Test	2023-05-16
Factor	BBHA 9120D	Temp. / Humidity	24°C /59%
Polarity	Vertical	Site / Test Engineer	AC1 / Todd
Test Mode	802.11n-20MHz_TX_CH 11_ANT 0	Test Voltage	AC 120V/60Hz

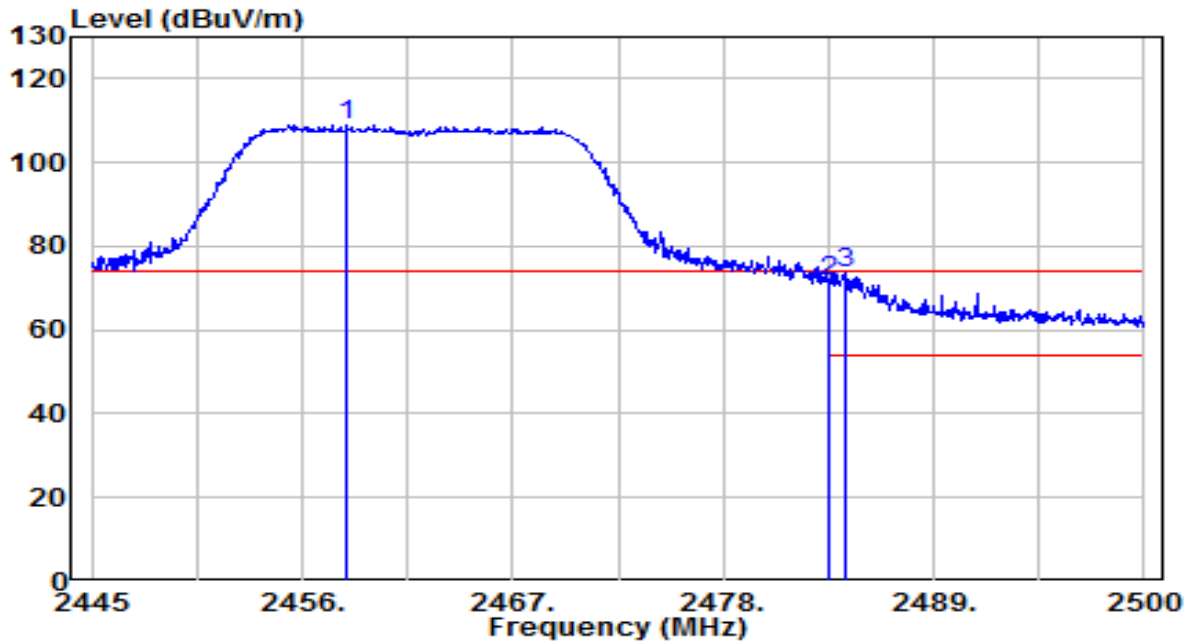

No	Frequency (MHz)	Reading (dBuV)	C.F (dB/m)	Measurement (dBuV/m)	Margin (dB)	Limit (dBuV/m)	Height (cm)	Angle (deg)	Remark (QP/PK/AV)
1	2458.310	76.57	32.43	109.00	N/A	N/A	125	270	Peak
2	2483.500	38.90	32.52	71.42	-2.58	74.00	125	270	Peak
3	* 2484.380	41.24	32.52	73.77	-0.23	74.00	125	270	Peak

Note:

1. " *", means this data is the worst emission level.
2. C.F (Correction Factor) = Antenna Factor (dB/m)+ Cable Loss (dB).
3. Measurement (dBuV/m) = Reading(dBuV) + C.F (Correction Factor).
4. The emission levels of other frequencies are very lower than the limit and not show in test report.

EUT	Pan/Tilt AI Home Security Wi-Fi Camera	Date of Test	2023-05-16
Factor	BBHA 9120D	Temp. / Humidity	24°C /59%
Polarity	Vertical	Site / Test Engineer	AC1 / Todd
Test Mode	802.11n-20MHz_TX_CH 11_ANT 0	Test Voltage	AC 120V/60Hz

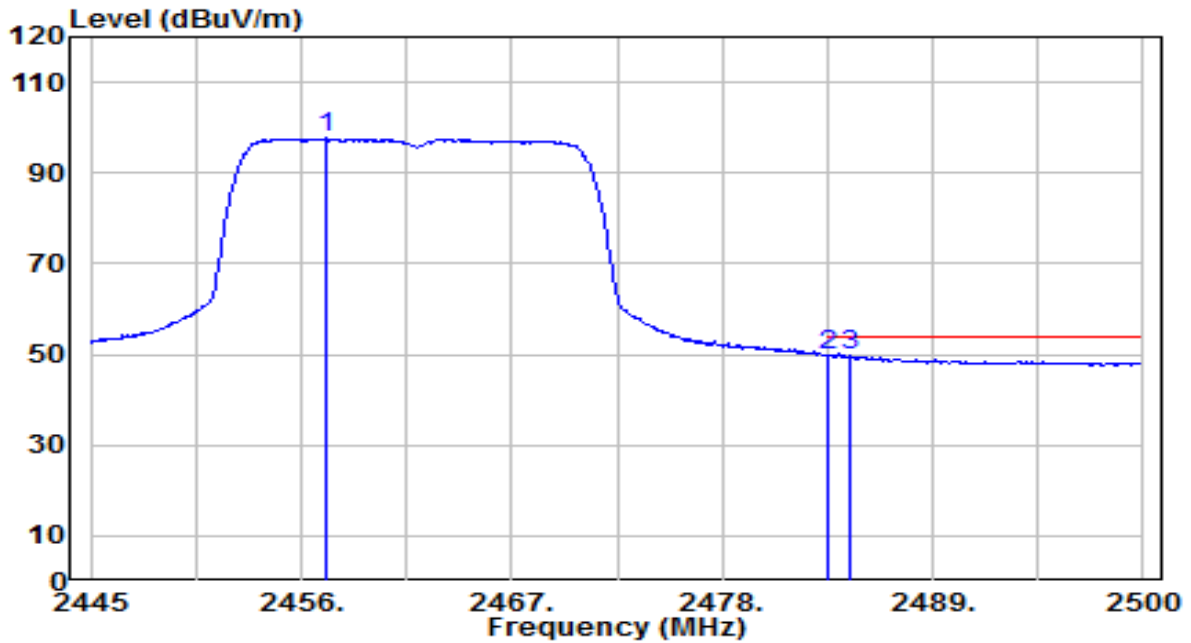

No	Frequency (MHz)	Reading (dBuV)	C.F (dB/m)	Measurement (dBuV/m)	Margin (dB)	Limit (dBuV/m)	Height (cm)	Angle (deg)	Remark (QP/PK/AV)
1	2457.320	65.19	32.43	97.61	N/A	N/A	125	270	Average
2	* 2483.500	17.29	32.52	49.81	-4.19	54.00	125	270	Average
3	2484.710	17.14	32.52	49.66	-4.34	54.00	125	270	Average

Note:

1. " *", means this data is the worst emission level.
2. C.F (Correction Factor) = Antenna Factor (dB/m)+ Cable Loss (dB).
3. Measurement (dBuV/m) = Reading(dBuV) + C.F (Correction Factor).
4. The emission levels of other frequencies are very lower than the limit and not show in test report.

7.8. AC Conducted Emissions Measurement

7.8.1. Test Limit

FCC Part 15 Subpart C Paragraph 15.207 Limits		
Frequency (MHz)	QP (dBuV)	AV (dBuV)
0.15 - 0.50	66 - 56	56 - 46
0.50 - 5.0	56	46
5.0 - 30	60	50

Note 1: The lower limit shall apply at the transition frequencies.

Note 2: The limit decreases linearly with the logarithm of the frequency in the range 0.15MHz to 0.5MHz.

7.8.2. Test Setup

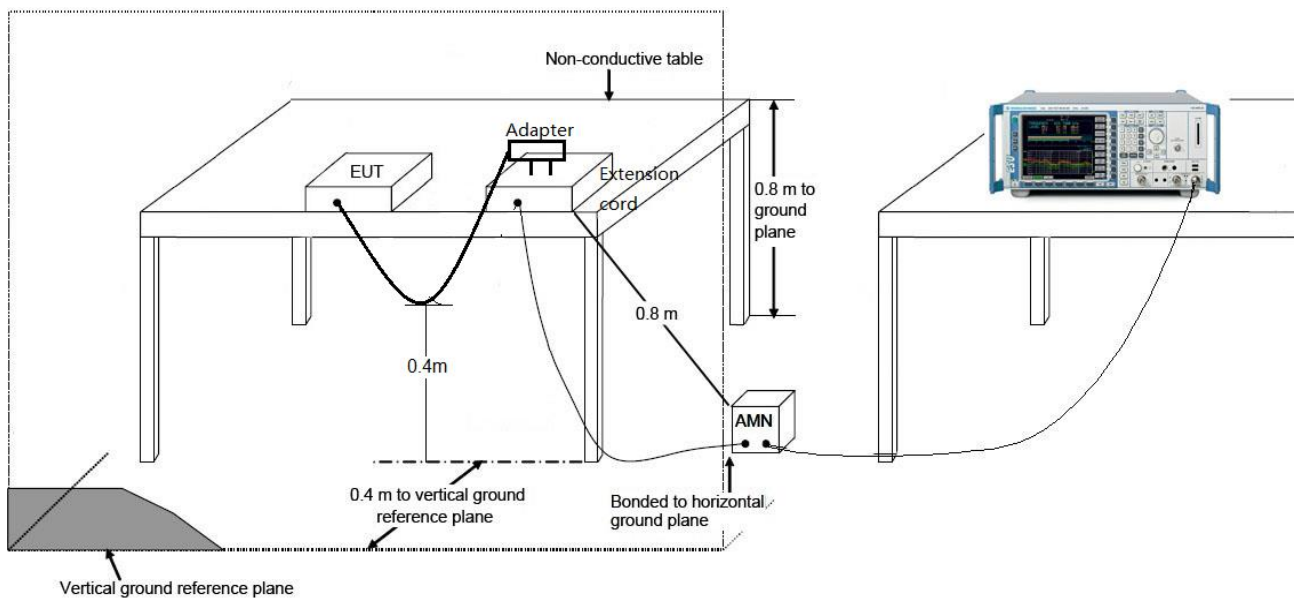

7.8.3. Test Result

EUT	Pan/Tilt AI Home Security Wi-Fi Camera	Date of Test	2023-09-28
Factor	CE_ENV216-L1 (Filter ON)	Temp. / Humidity	25.8°C /47%
Polarity	Line1	Site / Test Engineer	SR2 / Bob
Test Mode	802.11n-20MHz_TX_CH 6_ANT 0	Test Voltage	AC 120V/60Hz

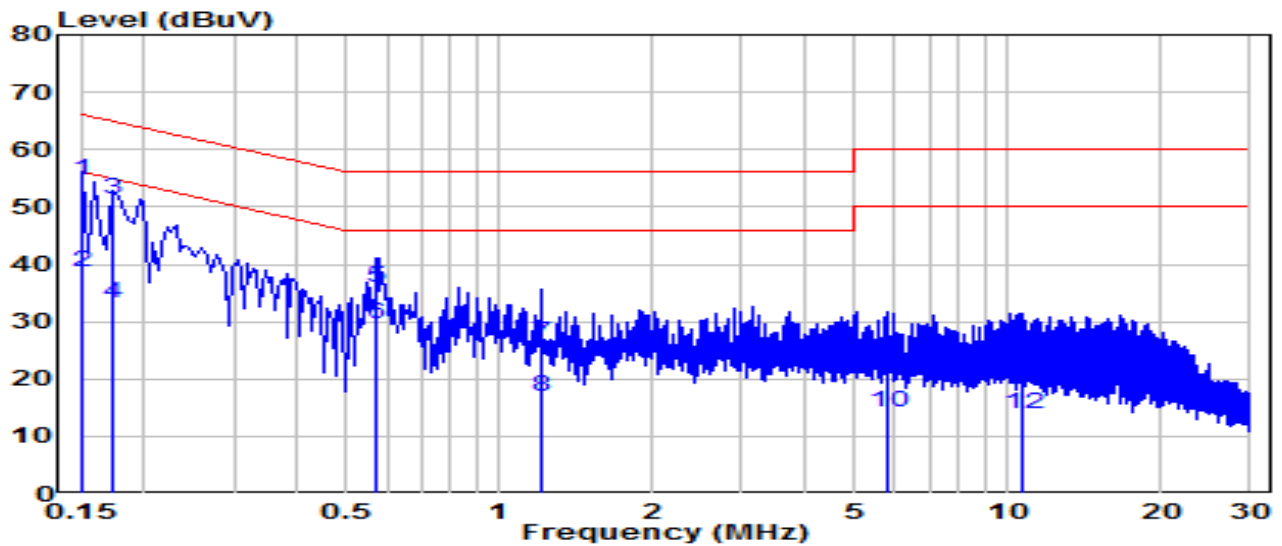

No	Frequency (MHz)	Reading (dBUV)	C.F (dB)	Measurement (dBUV)	Margin (dB)	Limit (dBUV)	Remark (QP/PK/AV)
1	*	44.90	9.62	54.52	-11.48	66.00	QP
2	*	28.97	9.62	38.59	-17.41	56.00	Average
3		41.56	9.62	51.18	-13.66	64.84	QP
4		23.63	9.62	33.25	-21.59	54.84	Average
5		26.27	9.65	35.91	-20.09	56.00	QP
6		19.87	9.65	29.51	-16.49	46.00	Average
7		16.59	9.67	26.26	-29.74	56.00	QP
8		7.36	9.67	17.03	-28.97	46.00	Average
9		11.31	9.76	21.07	-38.93	60.00	QP
10		4.52	9.76	14.29	-35.71	50.00	Average
11		11.41	9.86	21.28	-38.72	60.00	QP
12		3.87	9.86	13.74	-36.26	50.00	Average

Note:

1. " *", means this data is the worst emission level.
2. C.F (Correction Factor) = LISN Factor (dB)+ Cable Loss (dB).
3. Measurement (dBUV) = Reading(dBUV) + C.F (Correction Factor).

EUT	Pan/Tilt AI Home Security Wi-Fi Camera	Date of Test	2023-09-28
Factor	CE_ENV216-N (Filter ON)	Temp. / Humidity	25.8°C /47%
Polarity	Neutral	Site / Test Engineer	SR2 / Bob
Test Mode	802.11n-20MHz_TX_CH 6_ANT 0	Test Voltage	AC 120V/60Hz

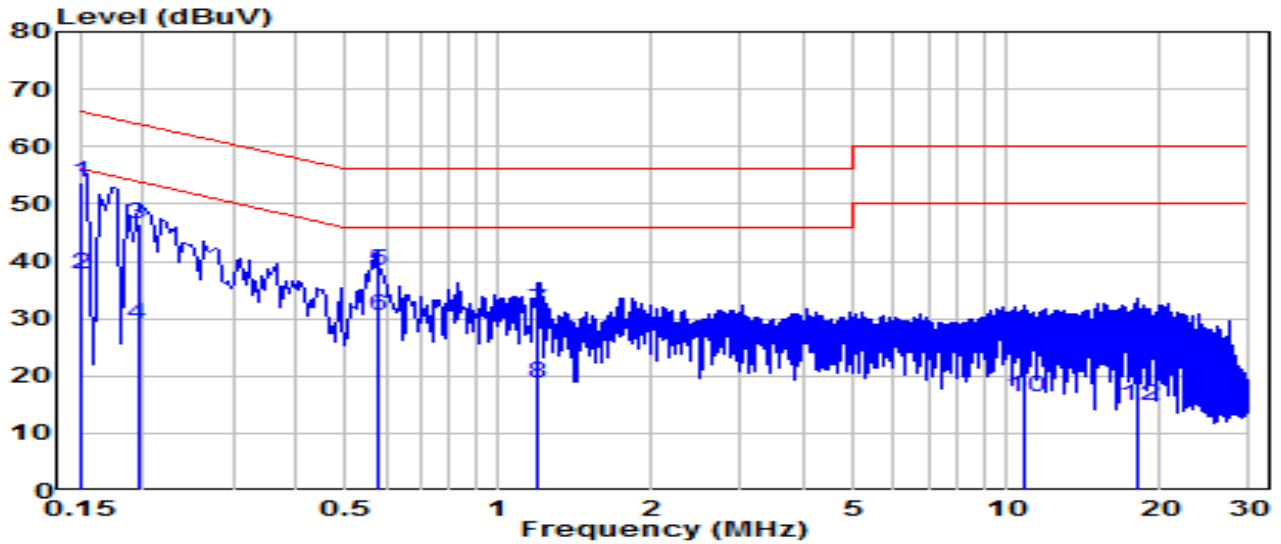

No	Frequency (MHz)	Reading (dBuV)	C.F (dB)	Measurement (dBuV)	Margin (dB)	Limit (dBuV)	Remark (QP/PK/AV)
1	*	44.16	9.62	53.78	-12.22	66.00	QP
2	*	28.03	9.62	37.65	-18.35	56.00	Average
3		36.94	9.62	46.56	-17.26	63.82	QP
4		19.32	9.62	28.95	-24.87	53.82	Average
5	0.577	28.80	9.65	38.45	-17.55	56.00	QP
6	0.577	20.92	9.65	30.57	-15.43	46.00	Average
7	1.198	21.69	9.67	31.37	-24.63	56.00	QP
8	1.198	9.05	9.67	18.72	-27.28	46.00	Average
9	10.859	16.73	9.88	26.61	-33.39	60.00	QP
10	10.859	6.35	9.88	16.24	-33.76	50.00	Average
11	18.022	16.52	9.97	26.49	-33.51	60.00	QP
12	18.022	4.95	9.97	14.92	-35.08	50.00	Average

Note:

1. " *", means this data is the worst emission level.
2. C.F (Correction Factor) = LISN Factor (dB)+ Cable Loss (dB).
3. Measurement (dBuV) = Reading(dBuV) + C.F (Correction Factor).

EUT	Pan/Tilt AI Home Security Wi-Fi Camera	Date of Test	2023-09-28
Factor	CE_ENV216-L1 (Filter ON)	Temp. / Humidity	25.8°C /47%
Polarity	Line1	Site / Test Engineer	SR2 / Bob
Test Mode	802.11n-20MHz_TX_CH 6_ANT 0	Test Voltage	AC 240V/60Hz

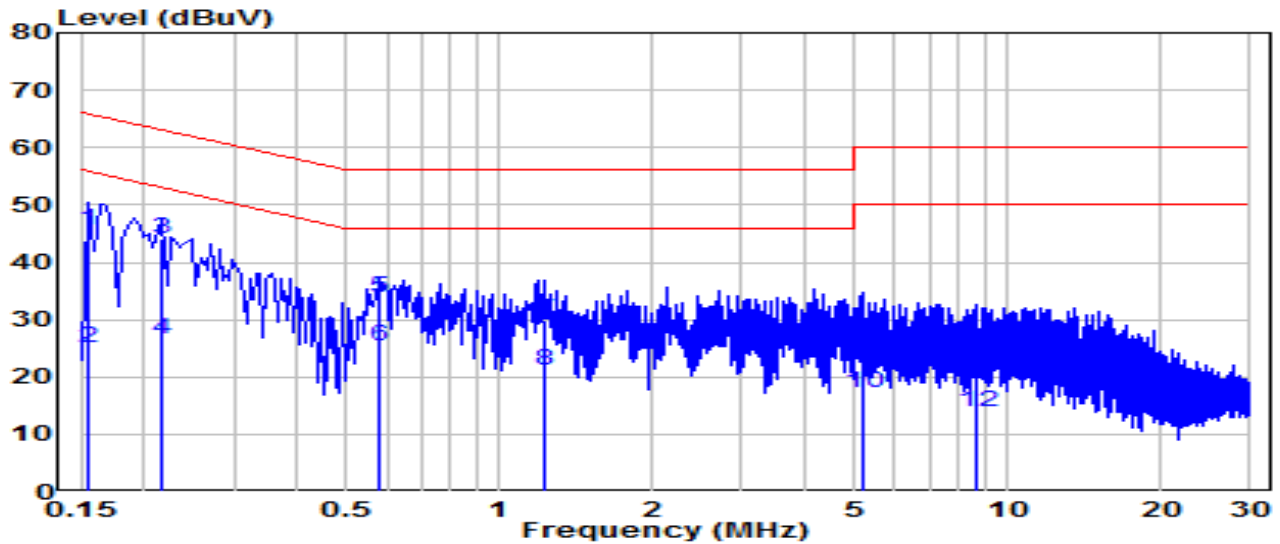

No	Frequency (MHz)	Reading (dBuV)	C.F (dB)	Measurement (dBuV)	Margin (dB)	Limit (dBuV)	Remark (QP/PK/AV)
1	0.154	36.08	9.62	45.70	-20.05	65.75	QP
2	0.154	15.44	9.62	25.06	-30.69	55.75	Average
3	* 0.217	34.35	9.62	43.97	-18.94	62.91	QP
4	* 0.217	17.02	9.62	26.64	-26.27	52.91	Average
5	0.582	24.04	9.65	33.68	-22.32	56.00	QP
6	0.582	15.79	9.65	25.43	-20.57	46.00	Average
7	1.230	20.12	9.67	29.79	-26.21	56.00	QP
8	1.230	11.32	9.67	21.00	-25.00	46.00	Average
9	5.185	16.22	9.75	25.97	-34.03	60.00	QP
10	5.185	7.53	9.75	17.28	-32.72	50.00	Average
11	8.654	12.82	9.83	22.65	-37.35	60.00	QP
12	8.654	4.19	9.83	14.02	-35.98	50.00	Average

Note:

- "*" means this data is the worst emission level.
- C.F (Correction Factor) = LISN Factor (dB)+ Cable Loss (dB).
- Measurement (dBuV) = Reading(dBuV) + C.F (Correction Factor).

EUT	Pan/Tilt AI Home Security Wi-Fi Camera	Date of Test	2023-09-28
Factor	CE_ENV216-N (Filter ON)	Temp. / Humidity	25.8°C /47%
Polarity	Neutral	Site / Test Engineer	SR2 / Bob
Test Mode	802.11n-20MHz_TX_CH 6_ANT 0	Test Voltage	AC 240V/60Hz

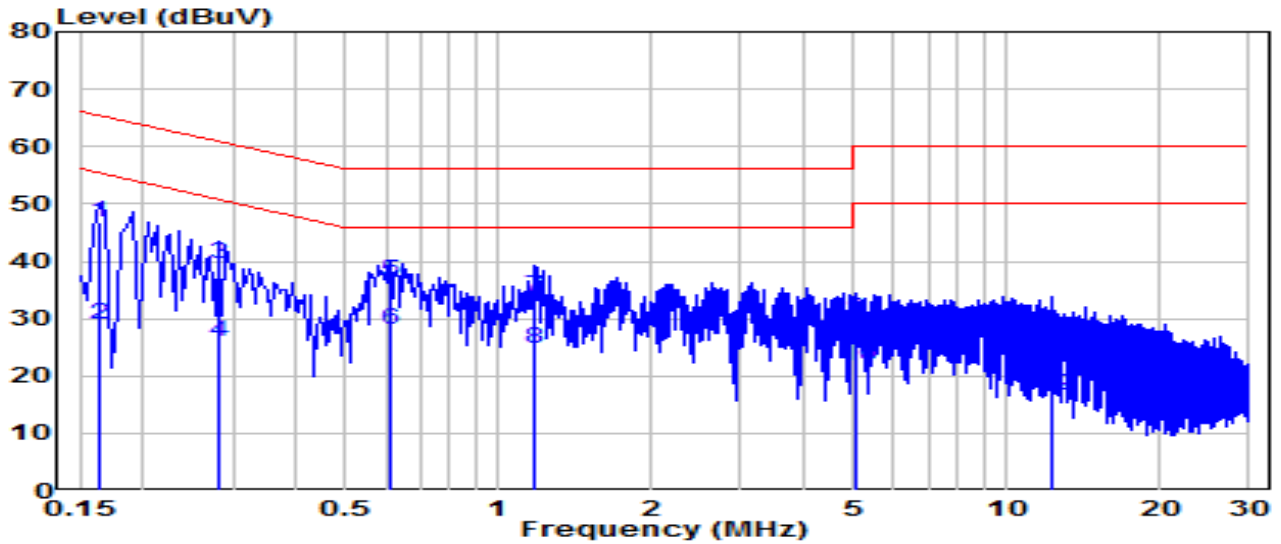

No	Frequency (MHz)	Reading (dBuV)	C.F (dB)	Measurement (dBuV)	Margin (dB)	Limit (dBuV)	Remark (QP/PK/AV)
1	0.163	37.23	9.62	46.85	-18.43	65.28	QP
2	0.163	19.42	9.62	29.04	-26.24	55.28	Average
3	0.280	29.81	9.63	39.43	-21.37	60.80	QP
4	0.280	16.39	9.63	26.02	-24.78	50.80	Average
5	* 0.609	27.01	9.65	36.66	-19.34	56.00	QP
6	* 0.609	18.36	9.65	28.00	-18.00	46.00	Average
7	1.176	24.26	9.67	33.93	-22.07	56.00	QP
8	1.176	15.12	9.67	24.79	-21.21	46.00	Average
9	5.028	20.25	9.75	30.00	-30.00	60.00	QP
10	5.028	12.13	9.75	21.88	-28.12	50.00	Average
11	12.209	16.78	9.90	26.68	-33.32	60.00	QP
12	12.209	6.85	9.90	16.75	-33.25	50.00	Average

Note:

1. " *", means this data is the worst emission level.
2. C.F (Correction Factor) = LISN Factor (dB)+ Cable Loss (dB).
3. Measurement (dBuV) = Reading(dBuV) + C.F (Correction Factor).

8. CONCLUSION

The data collected relate only the item(s) tested and show that the device is compliance with Part 15C of the FCC Rules.

Appendix A : Test Setup Photograph

Refer to “2309TW0121-UT” file.

Appendix B : External Photograph

Refer to “2309TW0121-UE” file.

Appendix C : Internal Photograph

Refer to “2309TW0121-UI” file.

————— The End —————