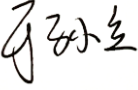

AUT Report

Product Model: Archer BE900

Manufacturer: TP-LINK CORPORATION PTE. LTD.

Test Date: 2023.12.21

Tested By: Yu Sunli 

TP-LINK CORPORATION PTE. LTD.
7 Temasek Boulevard #29-03 Suntec Tower One, Singapore 038987,

Index

| | |
|--|----------|
| 1. Antenna Distribution..... | 3 |
| 2. Electrical Characteristics | 3 |
| 3. Gain and Radiation Pattern | 5 |
| 3.1 Measurement Procedure | 5 |
| 3.2 Test Setup | 7 |
| 3.3 S Parameter Test Data | 7 |
| 3.4 Antenna Peak Gain | 9 |
| 3.5 Antenna Radiation Pattern..... | 11 |

1. Antenna Distribution

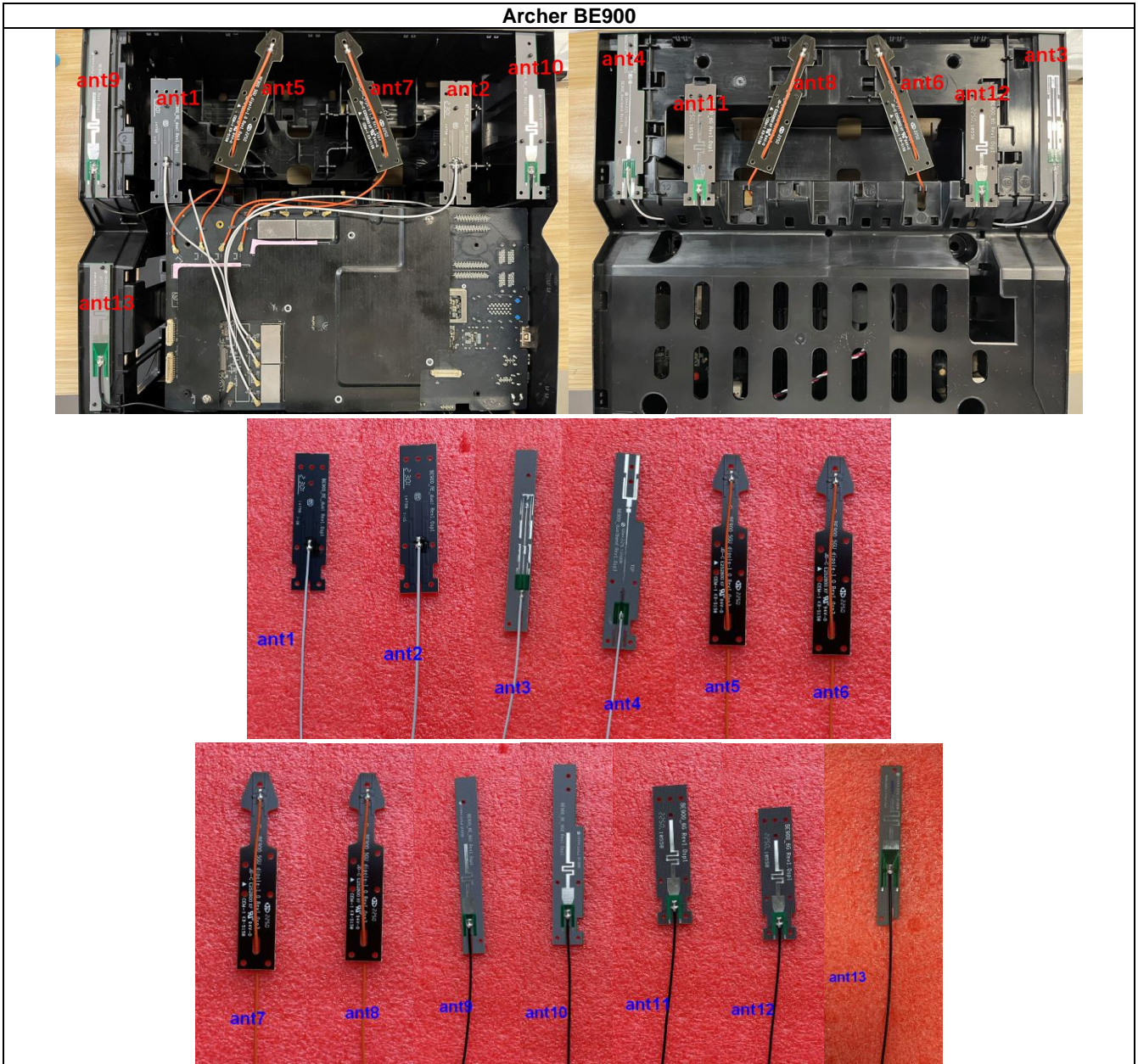

2. Electrical Characteristics

| Ant1 | |
|--------------------------|--|
| Frequency | 2400~2500 & 5150~5450MHz |
| Impedance | 50Ohm |
| Antenna Type | Dipole |
| Antenna Gain | 2.91dBi@2400~2500MHz 3.08dBi@5150~5450MHz |
| Radiation pattern | Omni-Directional |

| Ant2 | |
|---------------------|--|
| Frequency | 2400~2500 & 5150~5450MHz |
| Impedance | 50Ohm |
| Antenna Type | Dipole |
| Antenna Gain | 2.91dBi@2400~2500MHz 3.08dBi@5150~5450MHz |

| | |
|--------------------------|------------------|
| Radiation pattern | Omni-Directional |
|--------------------------|------------------|

| Ant3 | |
|--------------------------|--|
| Frequency | 2400~2500 & 5150~5450MHz |
| Impedance | 50Ohm |
| Antenna Type | Dipole |
| Antenna Gain | 2.91dBi@2400~2500MHz 3.08dBi@5150~5450MHz |
| Radiation pattern | Omni-Directional |

| Ant4 | |
|--------------------------|--|
| Frequency | 2400~2500 & 5150~5450MHz |
| Impedance | 50Ohm |
| Antenna Type | Dipole |
| Antenna Gain | 2.91dBi@2400~2500MHz 3.08dBi@5150~5450MHz |
| Radiation pattern | Omni-Directional |

| Ant5 | |
|--------------------------|----------------------|
| Frequency | 5450~5850MHz |
| Impedance | 50Ohm |
| Antenna Type | Dipole |
| Antenna Gain | 3.13dBi@5450~5850MHz |
| Radiation pattern | Omni-Directional |

| Ant6 | |
|--------------------------|----------------------|
| Frequency | 5450~5850MHz |
| Impedance | 50Ohm |
| Antenna Type | Dipole |
| Antenna Gain | 3.13dBi@5450~5850MHz |
| Radiation pattern | Omni-Directional |

| Ant7 | |
|--------------------------|----------------------|
| Frequency | 5450~5850MHz |
| Impedance | 50Ohm |
| Antenna Type | Dipole |
| Antenna Gain | 3.13dBi@5450~5850MHz |
| Radiation pattern | Omni-Directional |

| Ant8 | |
|--------------------------|----------------------|
| Frequency | 5450~5850MHz |
| Impedance | 50Ohm |
| Antenna Type | Dipole |
| Antenna Gain | 3.13dBi@5450~5850MHz |
| Radiation pattern | Omni-Directional |

| Ant9 | |
|------------------|--------------|
| Frequency | 5925~7125MHz |
| Impedance | 50Ohm |

| | |
|--------------------------|----------------------|
| Antenna Type | Dipole |
| Antenna Gain | 3.44dBi@5925~7125MHz |
| Radiation pattern | Omni-Directional |

| Ant10 | |
|--------------------------|----------------------|
| Frequency | 5925~7125MHz |
| Impedance | 50Ohm |
| Antenna Type | Dipole |
| Antenna Gain | 3.44dBi@5925~7125MHz |
| Radiation pattern | Omni-Directional |

| Ant11 | |
|--------------------------|----------------------|
| Frequency | 5925~7125MHz |
| Impedance | 50Ohm |
| Antenna Type | Dipole |
| Antenna Gain | 3.44dBi@5925~7125MHz |
| Radiation pattern | Omni-Directional |

| Ant12 | |
|--------------------------|----------------------|
| Frequency | 5925~7125MHz |
| Impedance | 50Ohm |
| Antenna Type | Dipole |
| Antenna Gain | 3.44dBi@5925~7125MHz |
| Radiation pattern | Omni-Directional |

| Ant13 | |
|--------------------------|----------------------|
| Frequency | 5150~5850MHz |
| Impedance | 50Ohm |
| Antenna Type | Dipole |
| Antenna Gain | 3.00dBi@5150~5850MHz |
| Radiation pattern | Omni-Directional |

3. Gain and Radiation Pattern

3.1 Measurement Procedure

This measurement experiment adopted an antenna near-field measurement system, and the diagram of the measurement system was shown in Figure 3-1. The excitation signal was generated by the Keysight E5071C (300kHz-20GHz). Under the control of the central computer, the probe rotated in the θ direction, and the EUT rotated in the ϕ direction with the turntable. The probe sampling frame received and collected signals in the near-field range of the EUT. The software system which was controlled by the central computer completed the processing, output and display of the test data.

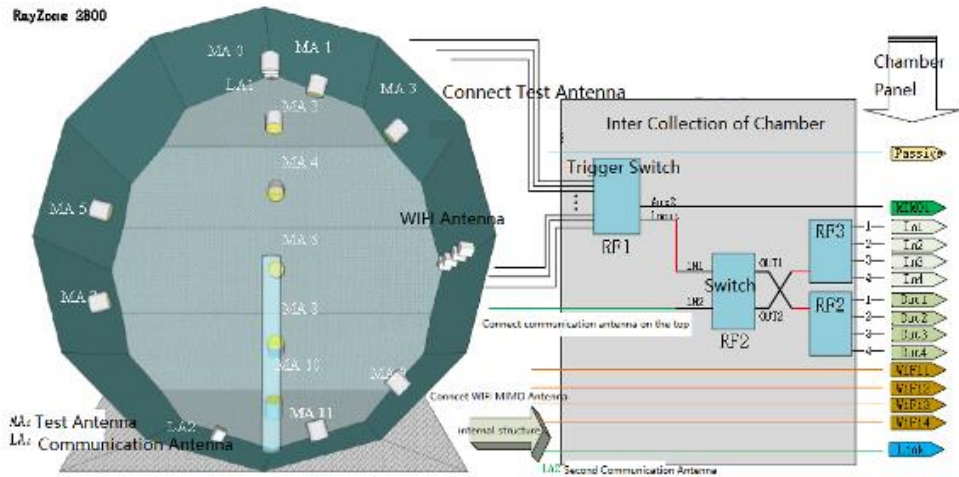

Figure 3-1

The test site was a full anechoic chamber with a size of 3.0m×3.1m×2.97m, which was built by GTS Rayzone2800. All six surfaces of the anechoic chamber were pasted with absorbing materials. And the chamber was calibrated by the authoritative third-party lab every year. The antenna anechoic chamber measurement system adopted a 13-probe multi-probe system. The probe antennas were evenly distributed on the spherical surface surrounding the EUT, and their operating frequency was 600MHz~8.5GHz.

During the measurement, the probe antennas were rotated in the θ direction under the control of the probe holder to sample the near-field data at the θ angle. At the same time, the EUT rotated with the turntable in the φ direction to sample the near field data at the φ angle. The sampling accuracy was 15°. The system diagram was shown in Figure 3-2. From the sampling results, the EUT's near-field test data of θ component, φ component and total component could be obtained.

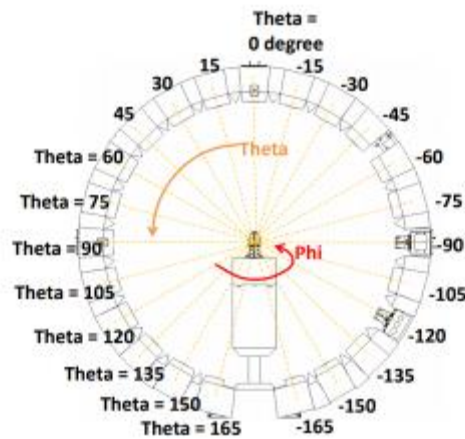

Figure 3-2

Before the measurement, calibrated the vector network analyzer, and then connected the input end of each antenna to the output end of the vector network analyzer, and evenly the antennas to be measured.

Test Equipment listed below:

| Equipments | Model | Manufacturer | S/N | Cali. Interval | Cali. Due Date |
|-------------------------|-------------|--------------------------|----------------|----------------|----------------|
| Chamber | Rayzone2800 | GTS(General Test System) | MY5347043 5 | 12months | 2024/01/15 |
| Vector Network Analyzer | E5071C | Keysight | MY46315238 | 24months | 2024/03/13 |
| GTS MaxSign100 Software | V2.1 | GTS(General Test System) | / | / | / |

3.2 Test Setup

The test setup was shown in Figure 3-3, 3-4:



Figure 3-3

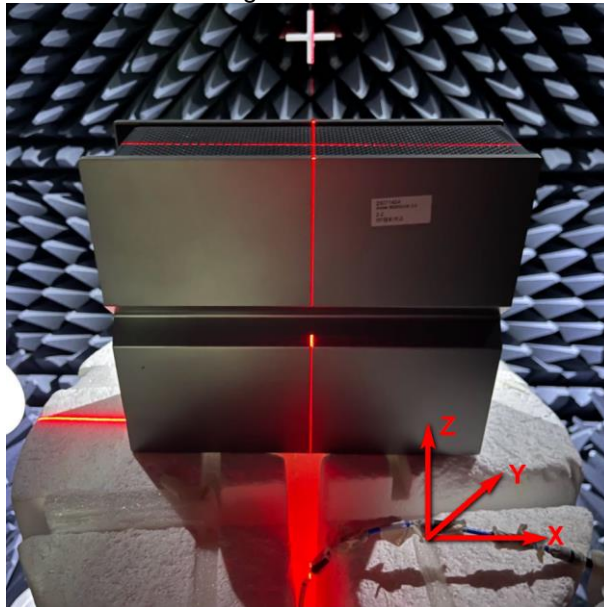
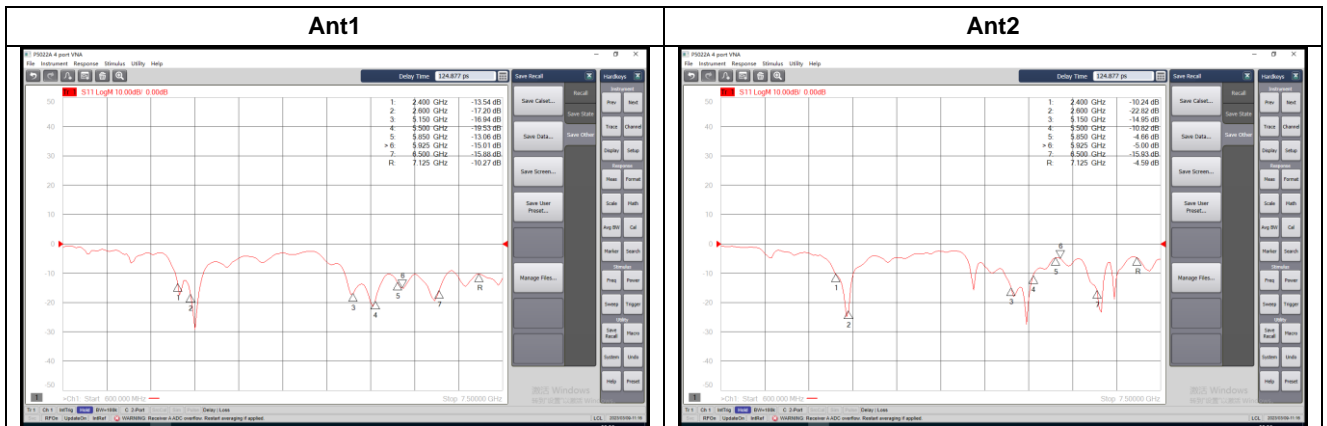
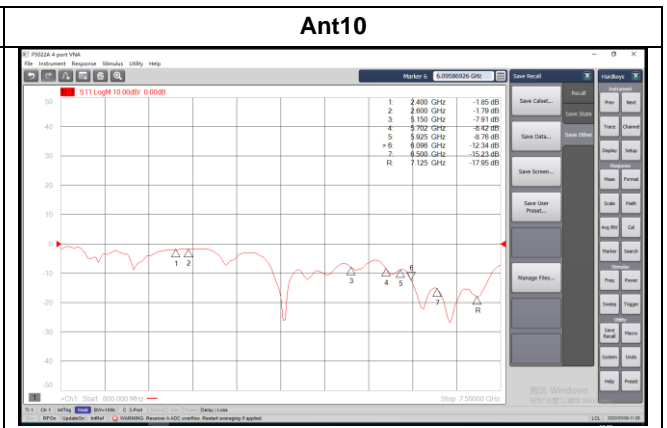
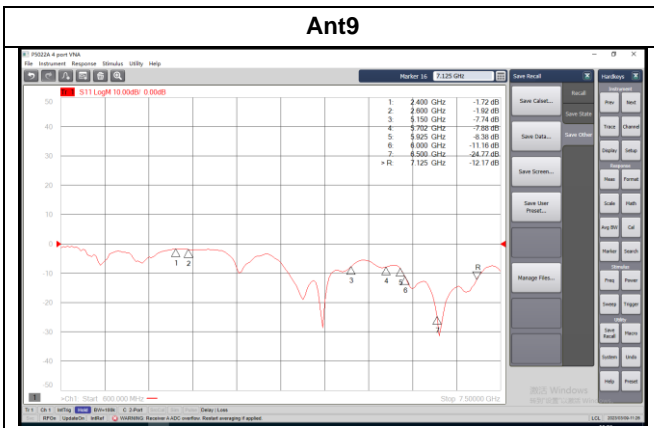
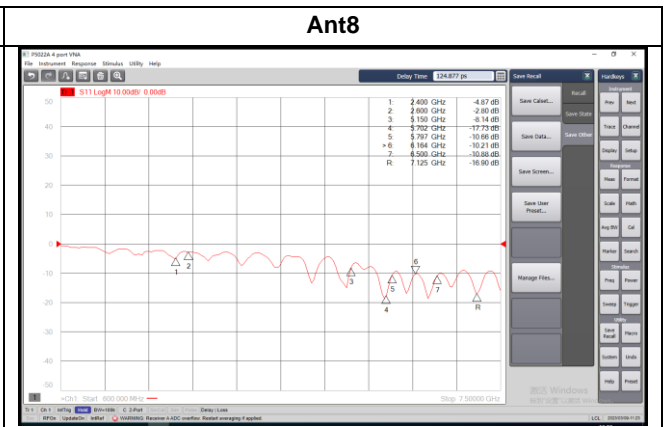
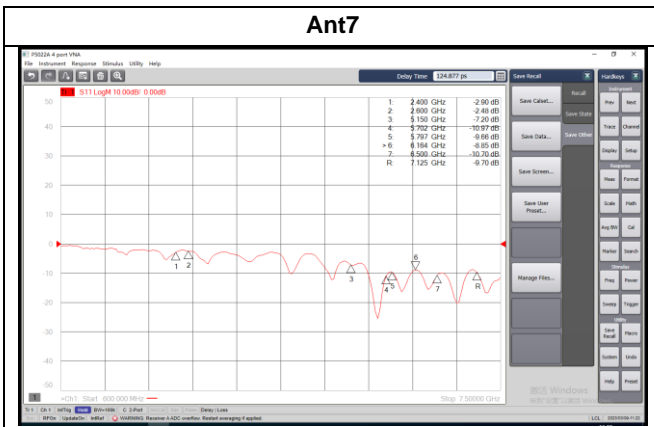
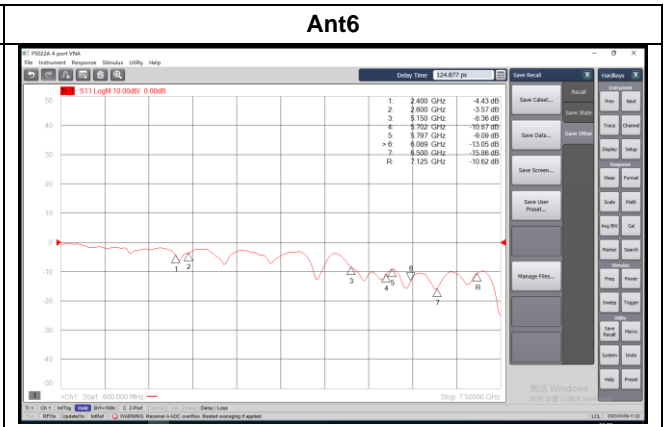
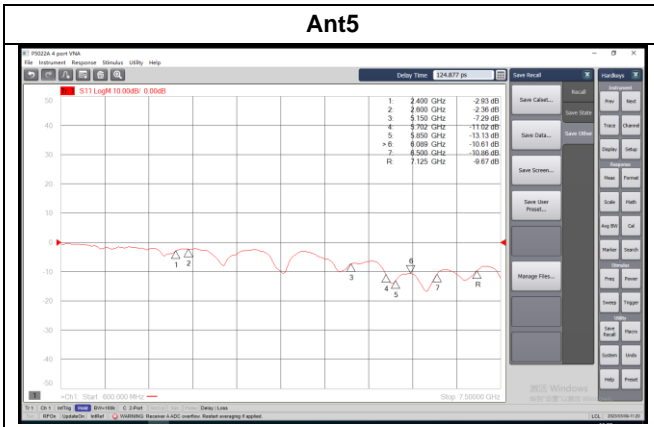
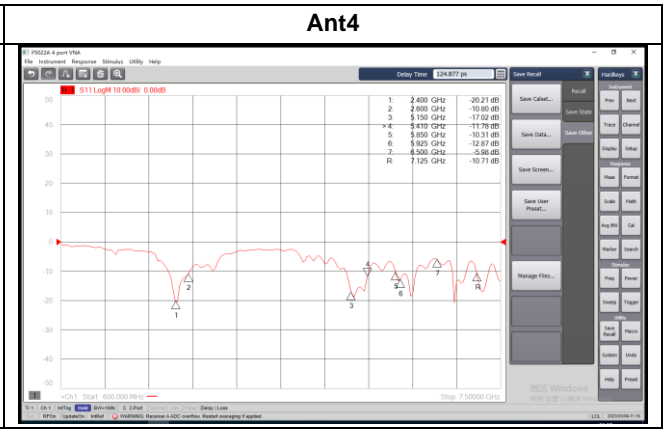
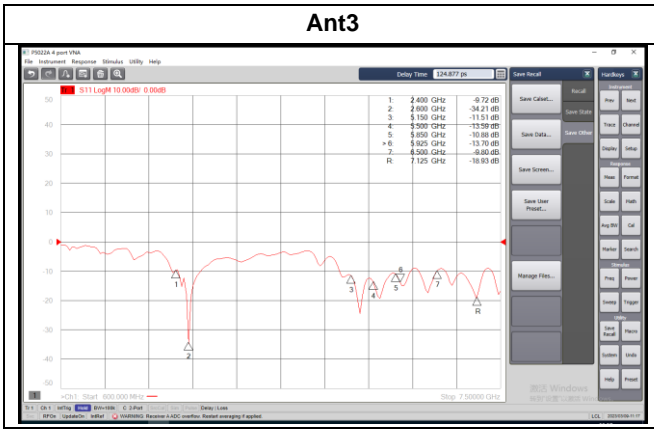
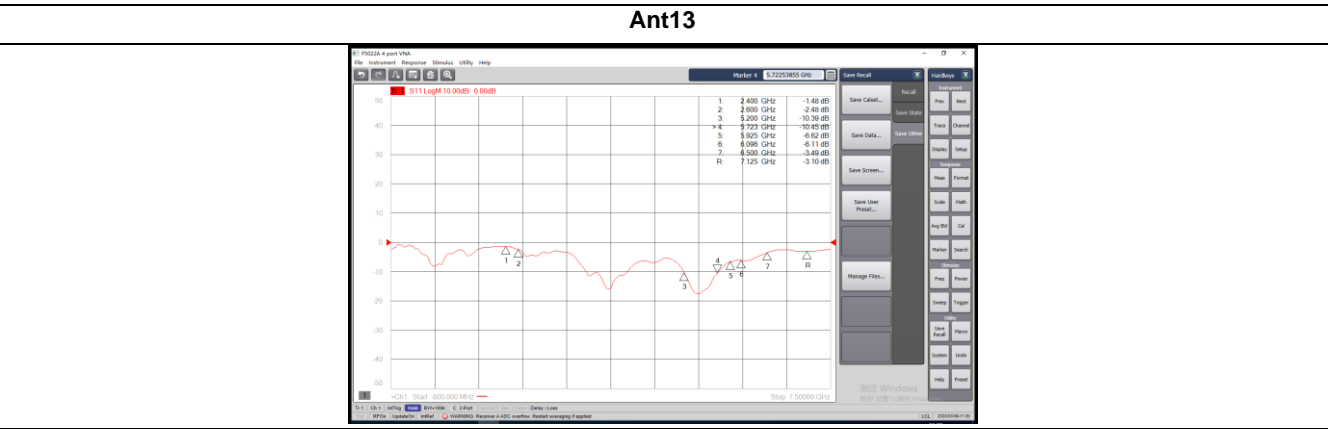
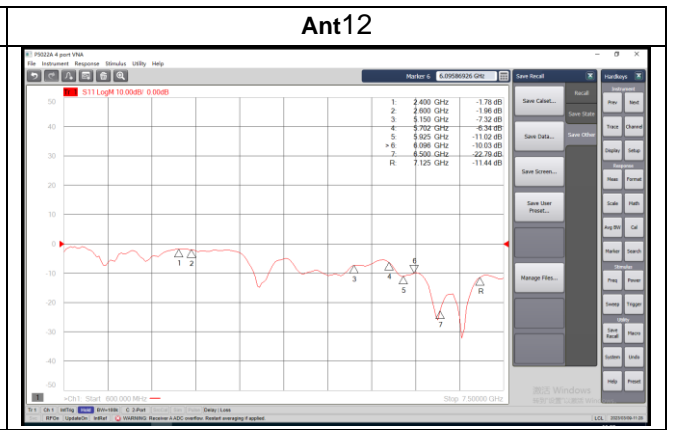
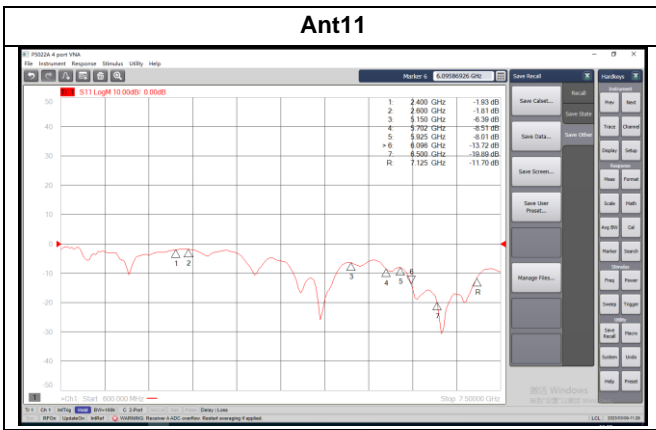

Figure 3-4

3.3 S Parameter Test Data







3.4 Antenna Peak Gain

| | | |
|--------------------------------------|---------------|---------------|
| Frequency(GHz) | 2.45 | 5.25 |
| Ant1 MaxGain(dBi) | 2.50 | 3.06 |
| Ant2 MaxGain(dBi) | 2.64 | 2.97 |
| Ant3 MaxGain(dBi) | 2.91 | 3.08 |
| Ant4 MaxGain(dBi) | 2.51 | 3.03 |
| Ant1 Polarization/Φ (°)/θ (°) | Theta/270/75 | Theta/180/90 |
| Ant2 Polarization/Φ (°)/θ (°) | Theta/225/75 | Theta/225/90 |
| Ant3 Polarization/Φ (°)/θ (°) | Theta/255/105 | Theta/210/105 |
| Ant4 Polarization/Φ (°)/θ (°) | Theta/60/90 | Theta/150/90 |
| Max Gain(dBi) | 2.91 | 3.08 |

| | | |
|--|---------------|--------------|
| Frequency(GHz) | 5.50 | 5.75 |
| Ant5 MaxGain(dBi) | 3.12 | 2.97 |
| Ant6 MaxGain(dBi) | 3.13 | 2.97 |
| Ant7 MaxGain(dBi) | 3.06 | 2.97 |
| Ant8 MaxGain(dBi) | 3.08 | 2.97 |
| Ant5 Polarization/Φ (°)/θ (°) | Theta/180/60 | Theta/165/45 |
| Ant6 Polarization/Φ (°)/θ (°) | Theta/0/90 | Theta/270/75 |
| Ant7 Polarization/Φ (°)/θ (°) | Theta/240/120 | Theta/180/90 |
| Ant8 Polarization/Φ (°)/θ (°) | Theta/270/75 | Theta/195/90 |
| Max Gain(dBi) | 3.13 | 2.97 |

| | | | | |
|---|--------------|--------------|--------------|--------------|
| Frequency(GHz) | 6.175 | 6.475 | 6.725 | 7.025 |
| Ant9 MaxGain(dBi) | 1.44 | 1.20 | 1.09 | 1.79 |
| Ant10 MaxGain(dBi) | 3.10 | 3.04 | 3.29 | 3.02 |
| Ant11 MaxGain(dBi) | 2.44 | 2.82 | 1.91 | 1.80 |
| Ant12 MaxGain(dBi) | 1.95 | 2.2 | 2.89 | 3.44 |
| Ant9 Polarization/Φ (°)/θ (°) | Theta/15/75 | Theta/15/75 | Theta/0/75 | Theta/0/75 |
| Ant10 Polarization/Φ (°)/θ (°) | Theta/75/90 | Theta/75/90 | Theta/60/75 | Theta/60/75 |
| Ant11 Polarization/Φ (°)/θ (°) | Theta/240/90 | Theta/240/90 | Theta/180/75 | Theta/180/75 |
| Ant12 Polarization/Φ (°)/θ (°) | Theta/105/90 | Theta/60/75 | Theta/60/75 | Theta/120/75 |
| Max Gain(dBi) | 3.10 | 3.04 | 3.29 | 3.44 |

| | | | |
|---|--------------|--------------|--------------|
| Frequency(GHz) | 5.25 | 5.50 | 5.75 |
| Ant13 MaxGain(dBi) | 2.77 | 2.68 | 2.97 |
| Ant13 Polarization/Φ (°)/θ (°) | Theta/180/90 | Theta/180/60 | Theta/165/45 |
| Max Gain(dBi) | 3.00 | 2.98 | 2.97 |

3.5 Antenna Radiation Pattern

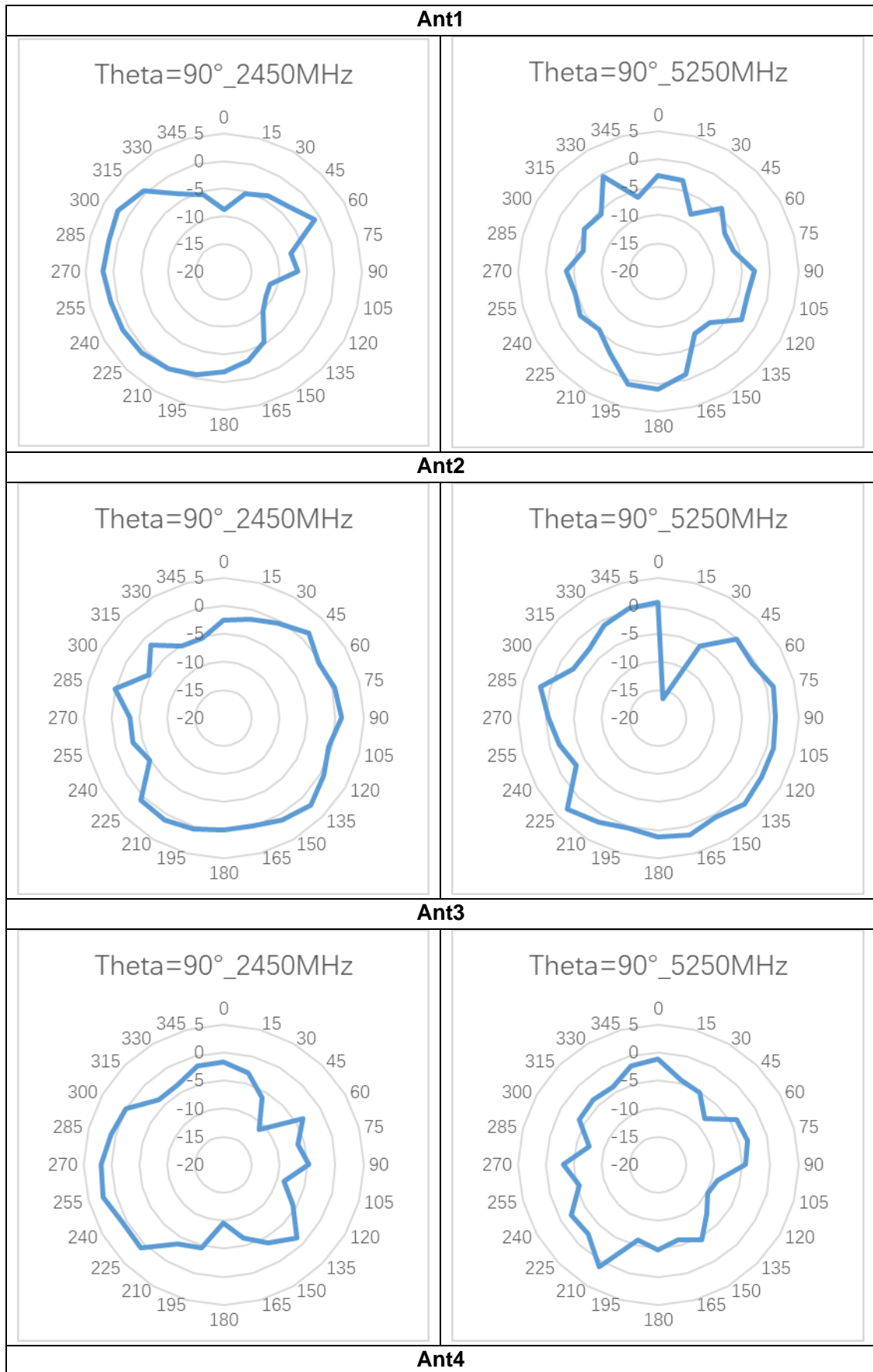

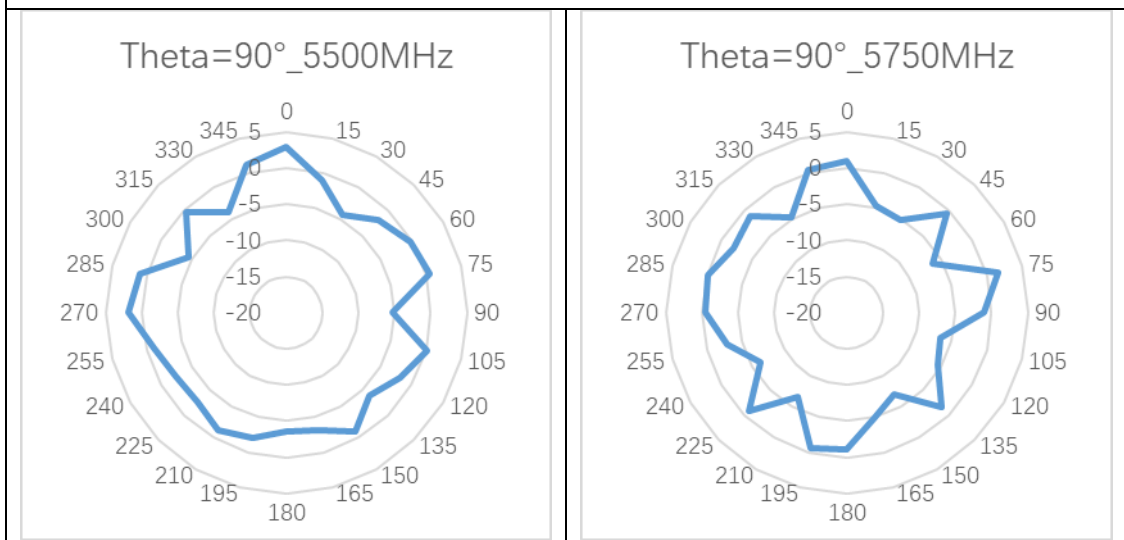
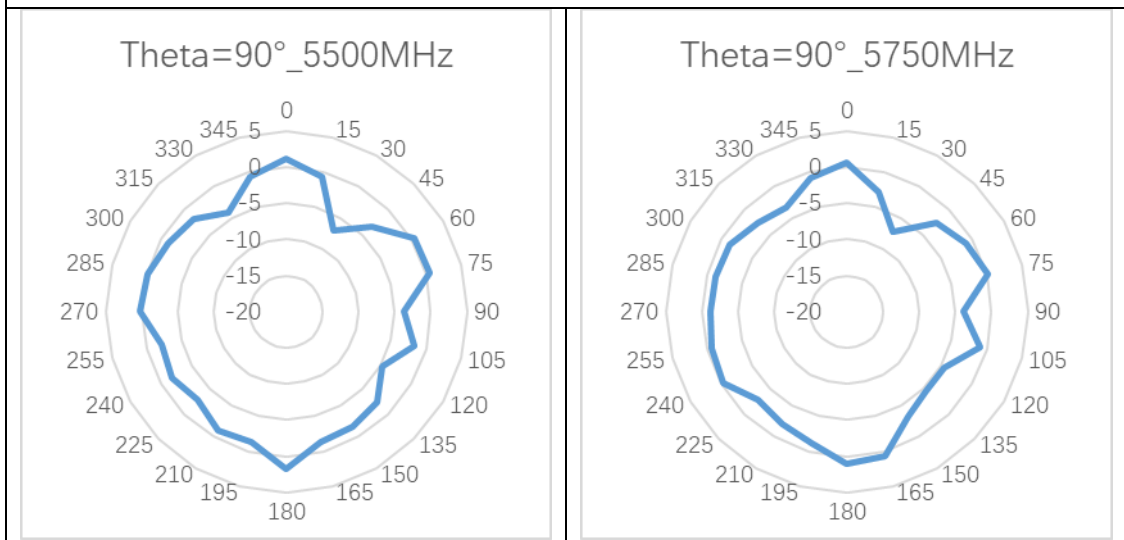
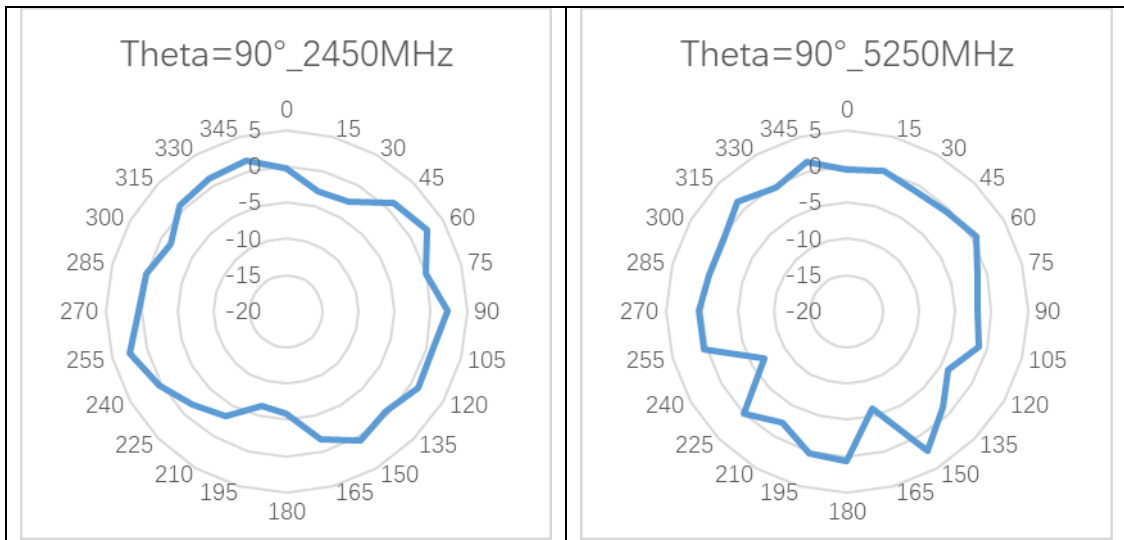

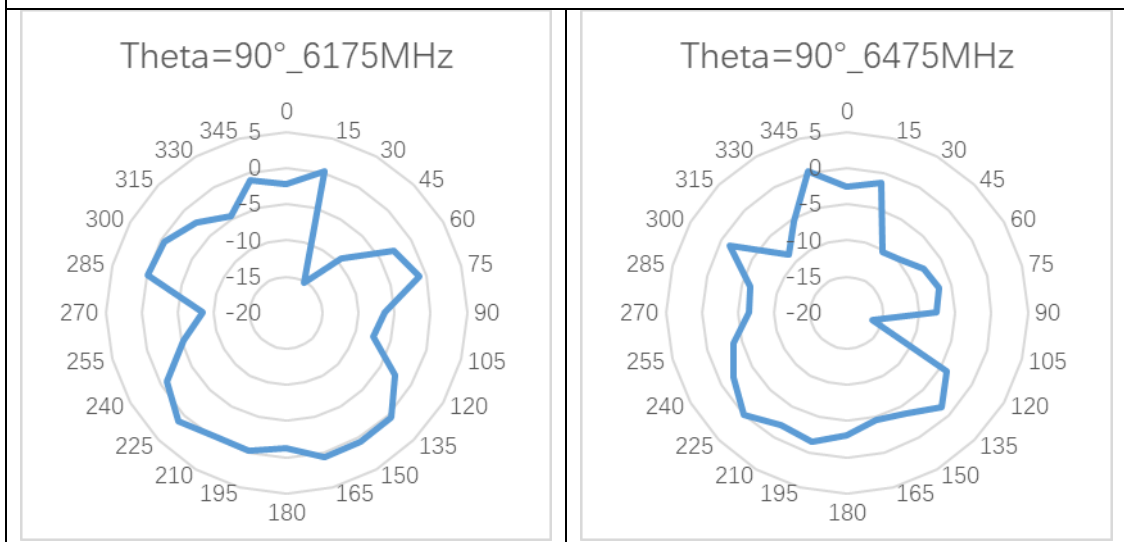
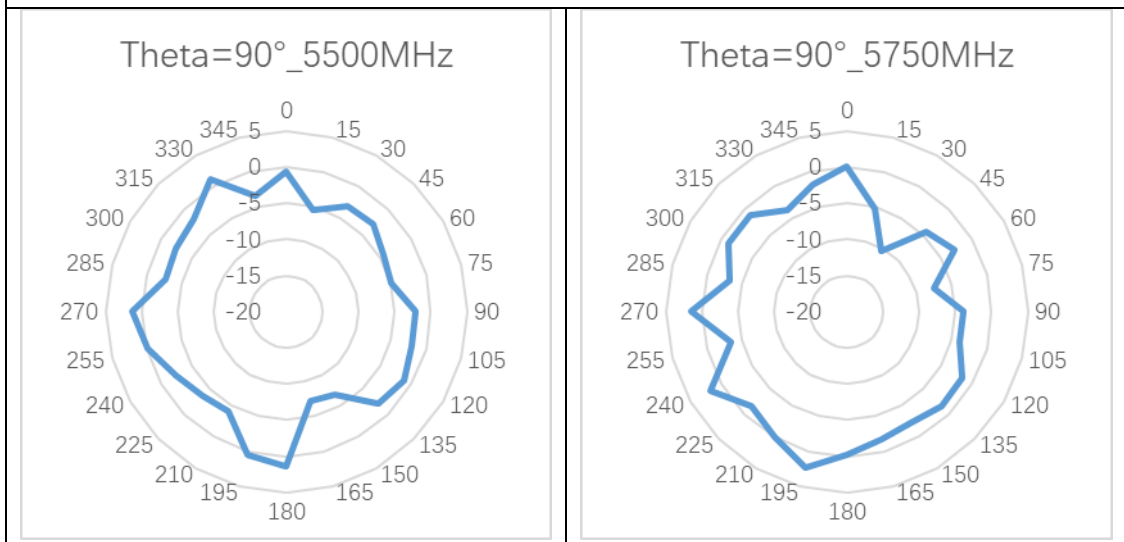
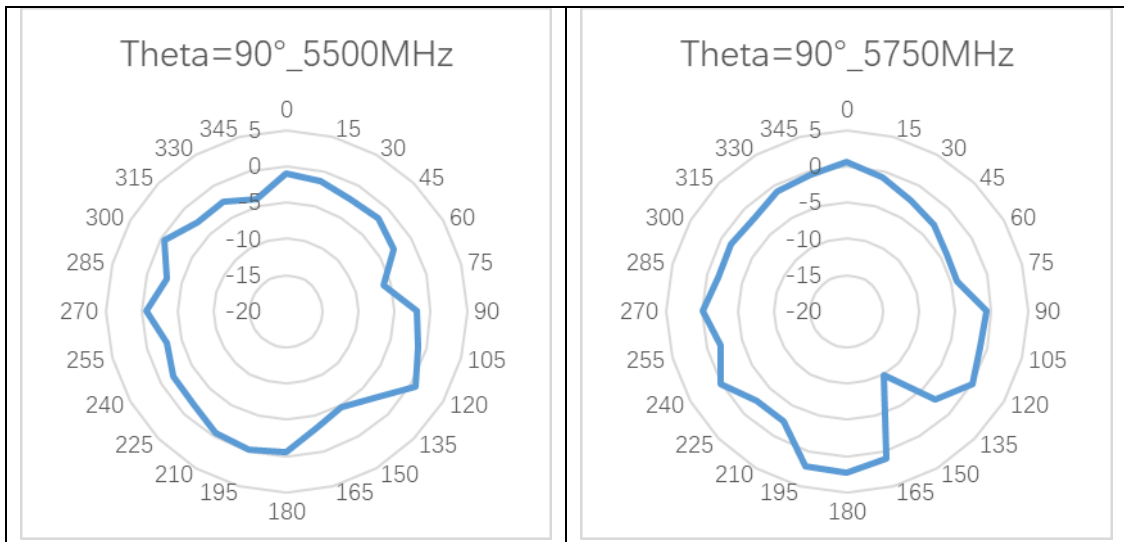

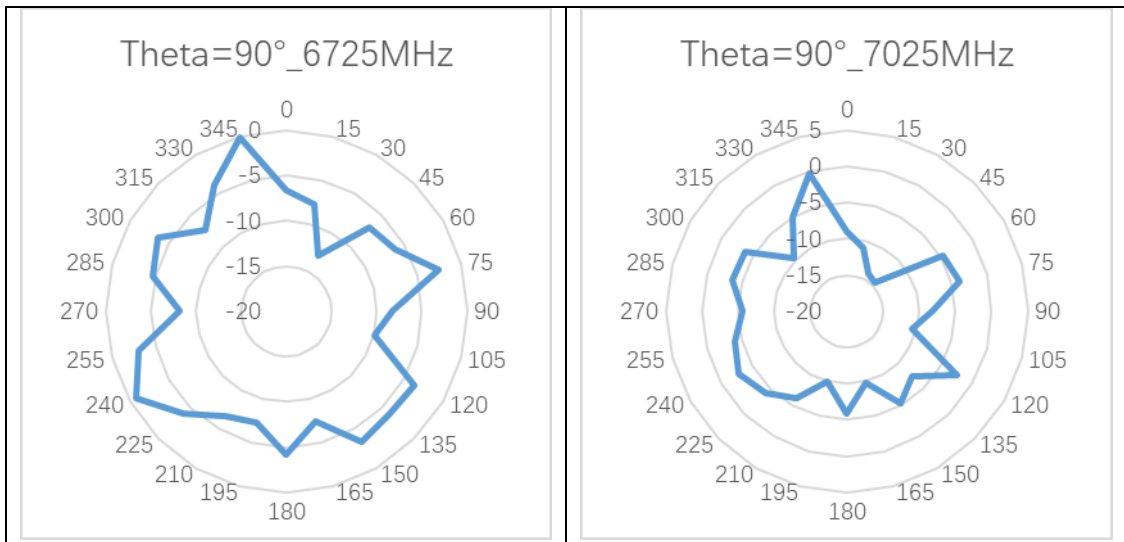

Ant10

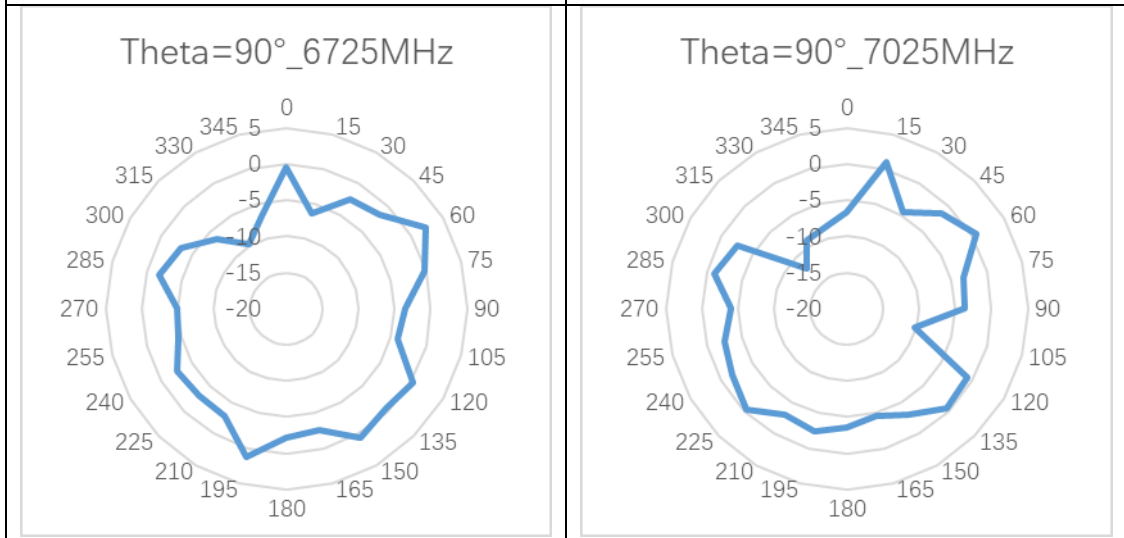
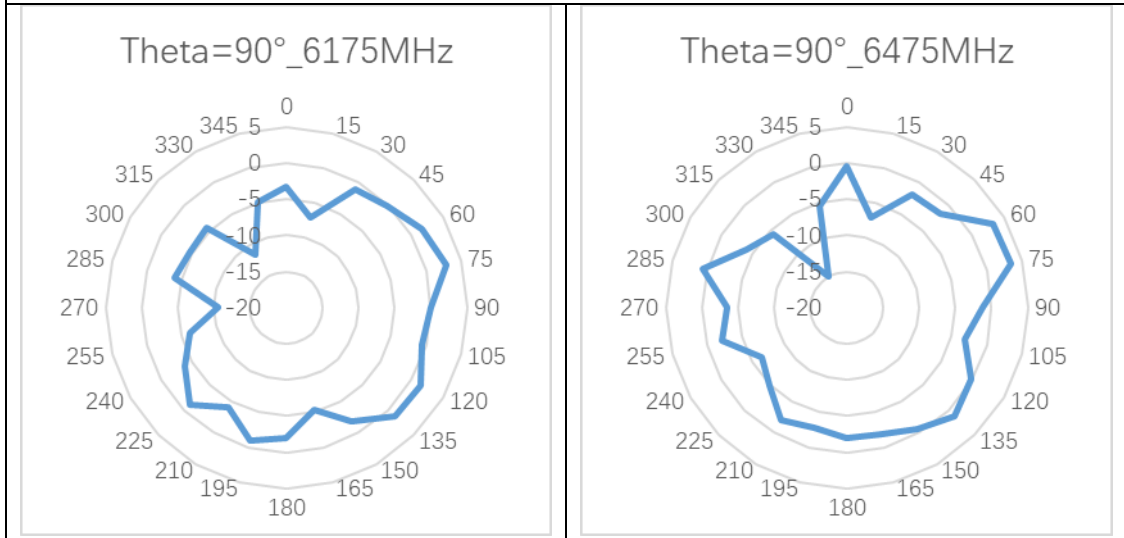

Ant11

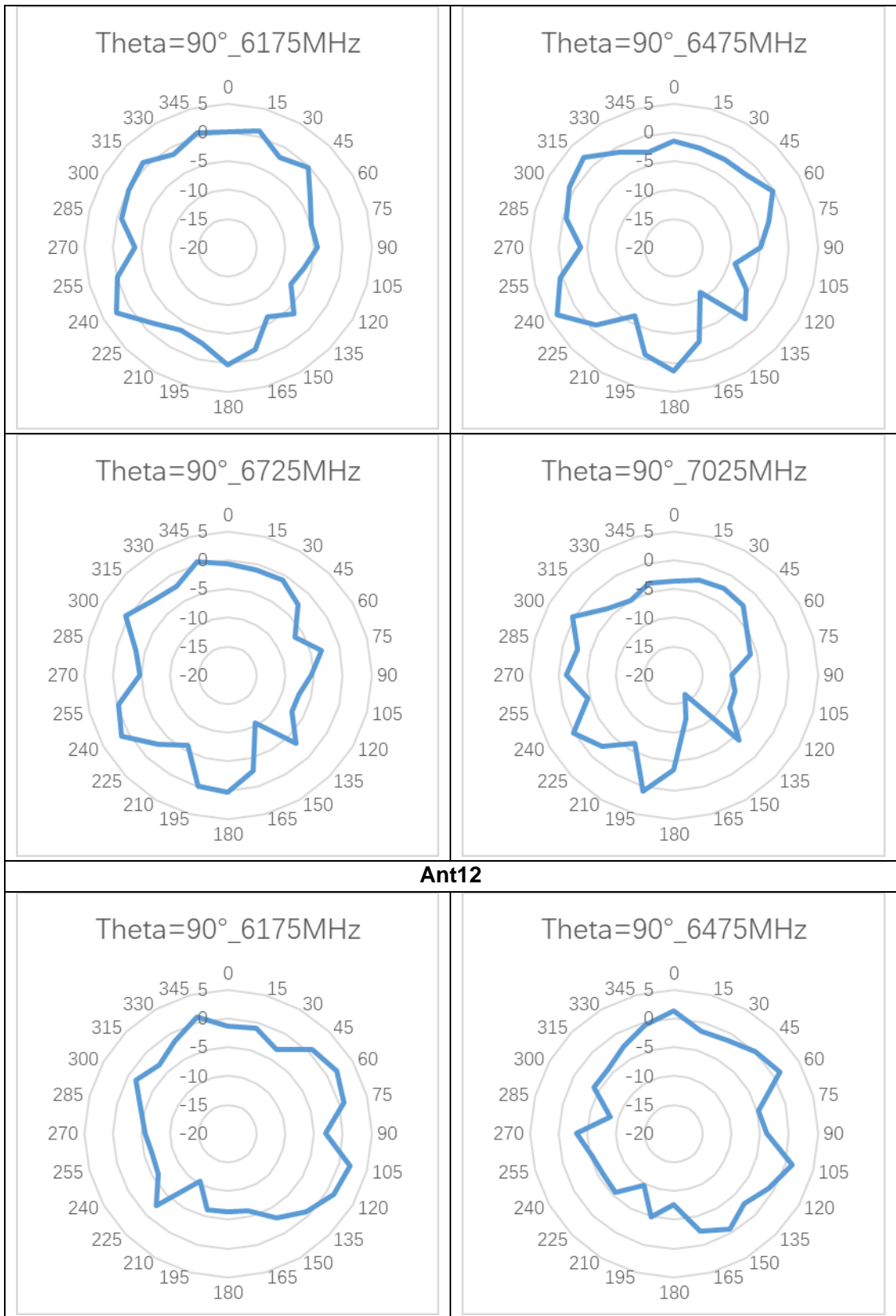

Ant12

