

### 802.11 n20 CH01 (2412MHz)

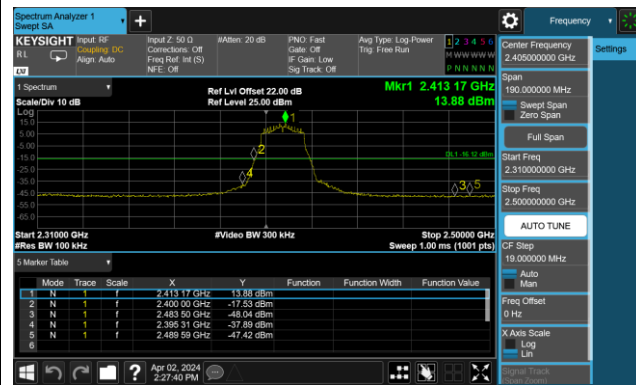

### 802.11 n20 CH01 (2412MHz)

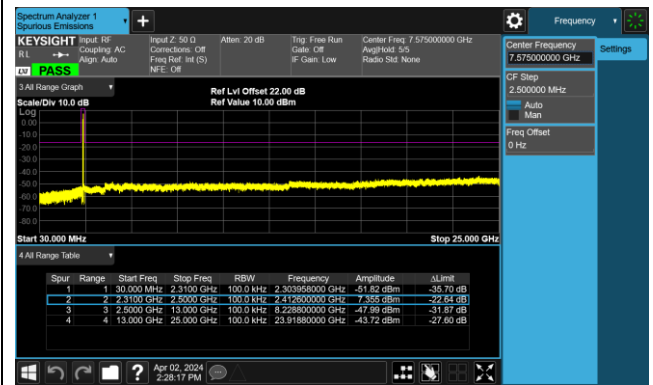

### 802.11 n20 CH06 (2437MHz)

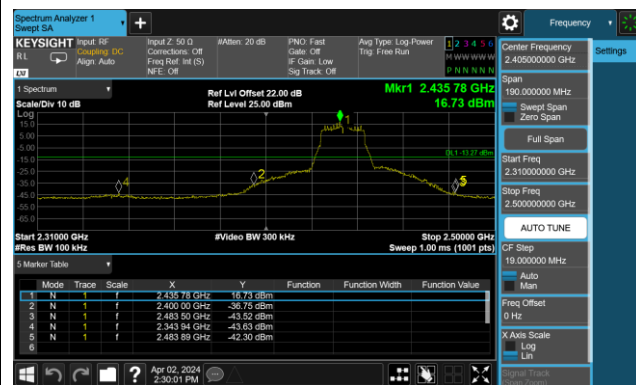

### 802.11 n20 CH06 (2437MHz)

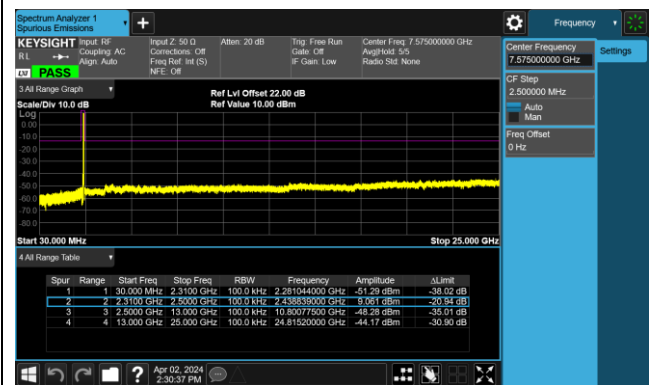

### 802.11 n20 CH11 (2462MHz)

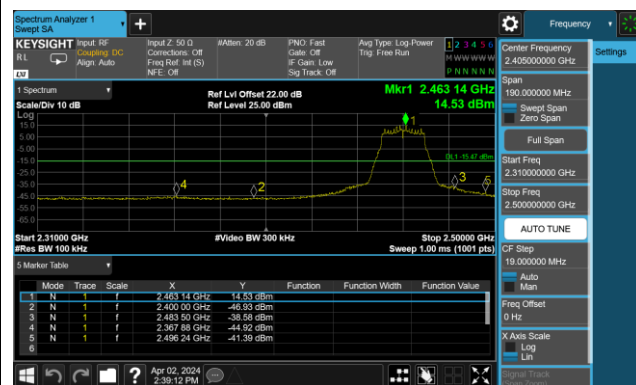

### 802.11 n20 CH11 (2462MHz)

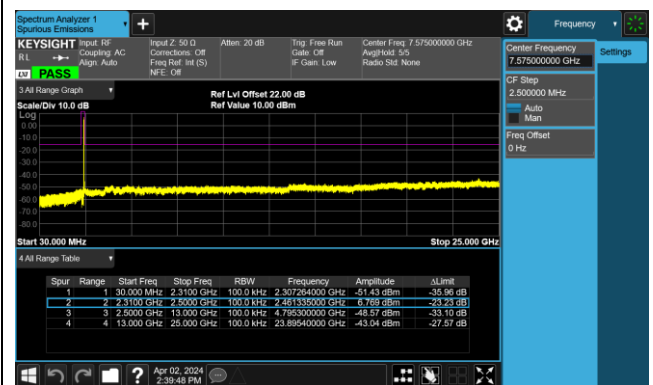

### 802.11 n40 CH03 (2422MHz)

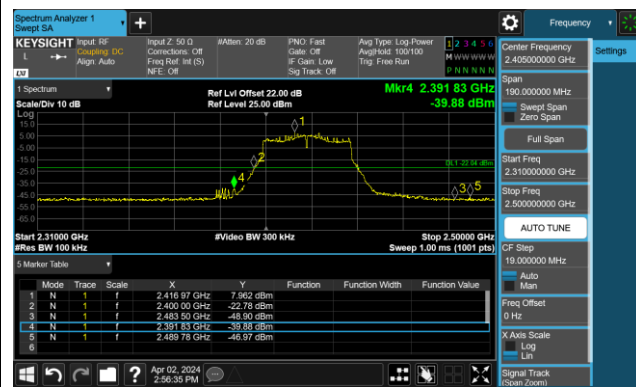

### 802.11 n40 CH03 (2422MHz)

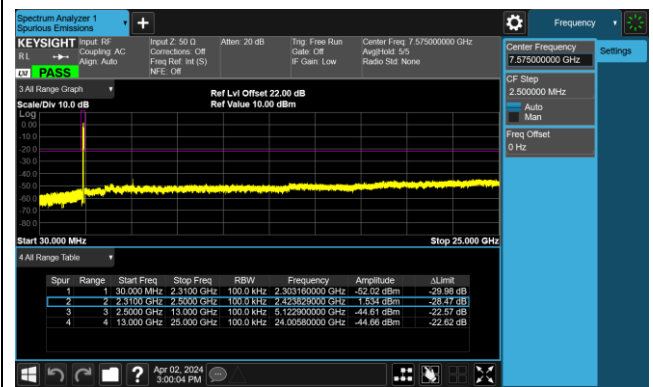

### 802.11 n40 CH06 (2437MHz)



### 802.11 n40 CH06 (2437MHz)

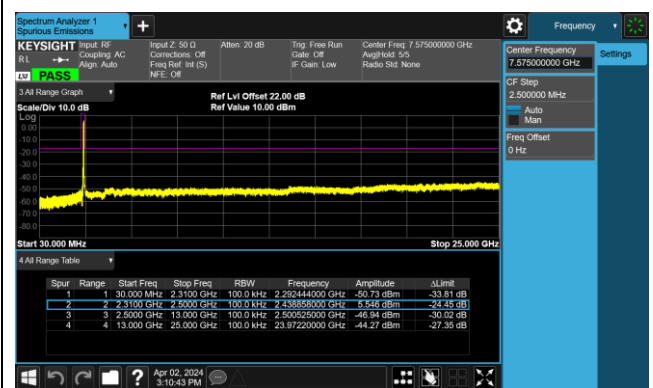

### 802.11 n40 CH09 (2452MHz)

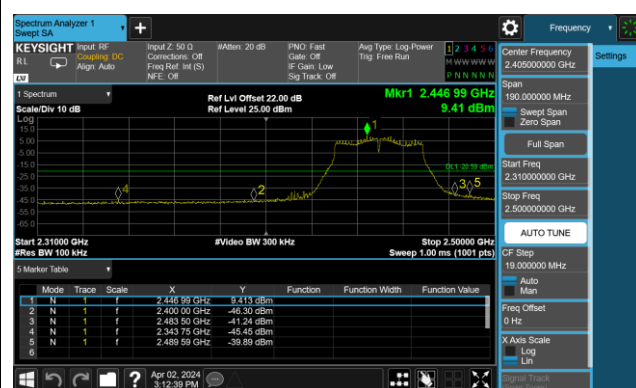

### 802.11 n40 CH09 (2452MHz)

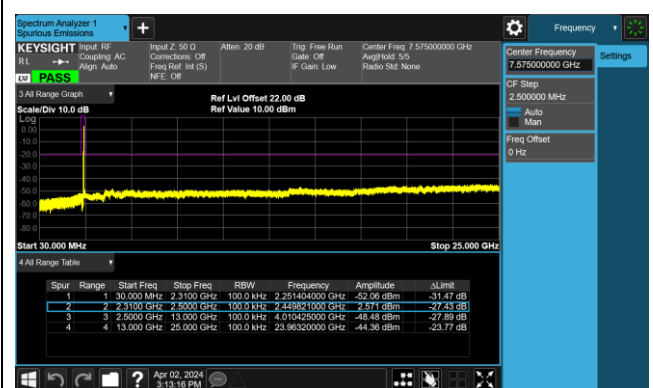

### 802.11 ax20 CH01 (2412MHz)

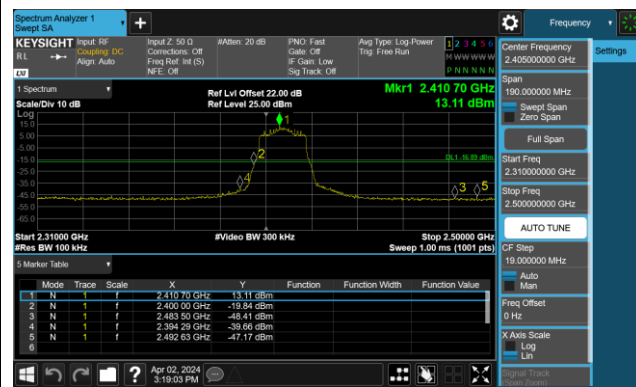

### 802.11 ax20 CH01 (2412MHz)

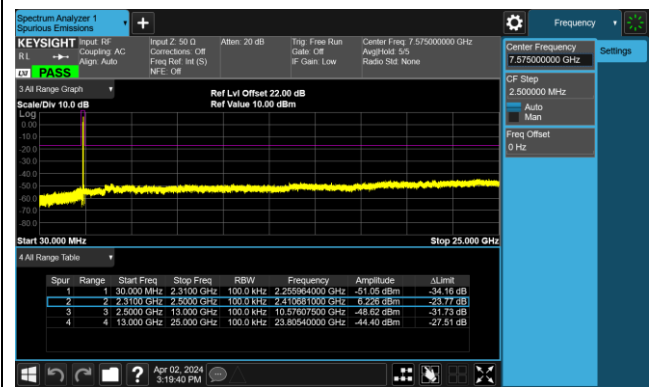

### 802.11 ax20 CH06 (2437MHz)

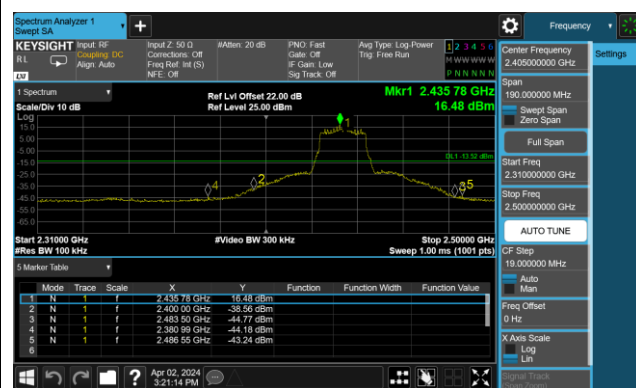

### 802.11 ax20 CH06 (2437MHz)

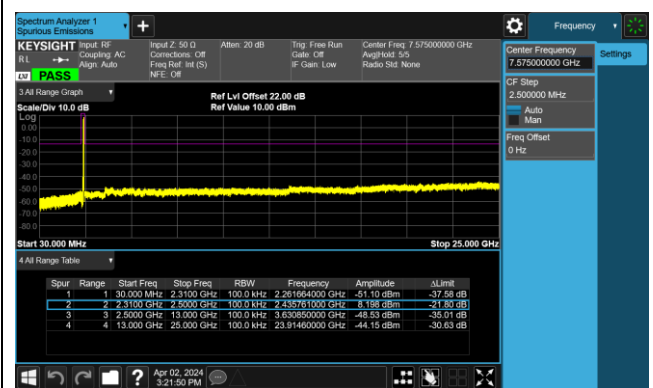

### 802.11 ax20 CH11 (2462MHz)

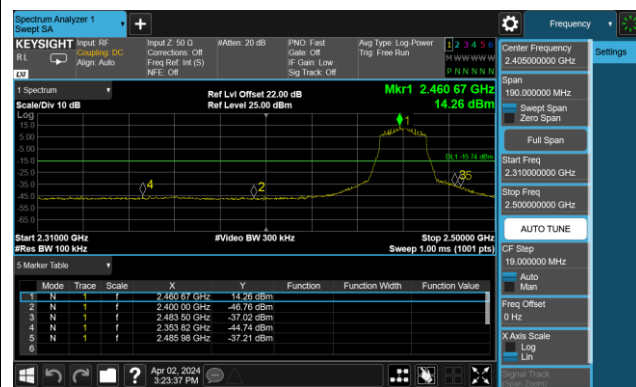

### 802.11 ax20 CH11 (2462MHz)

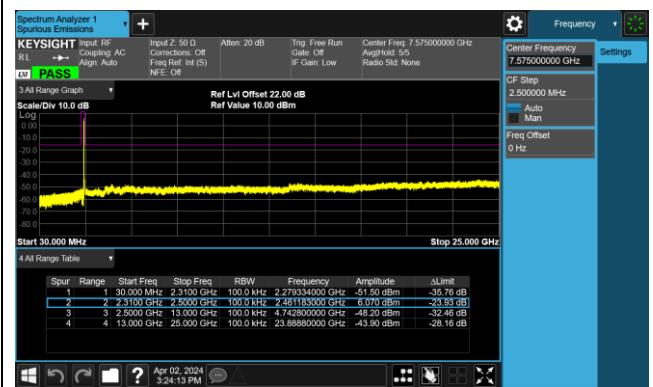

### 802.11 ax40 CH03 (2422MHz)

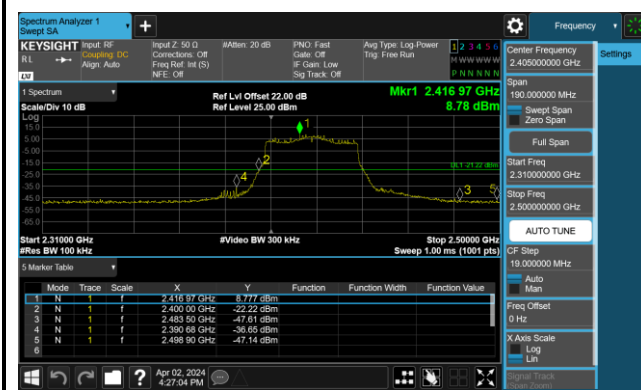

### 802.11 ax40 CH03 (2422MHz)

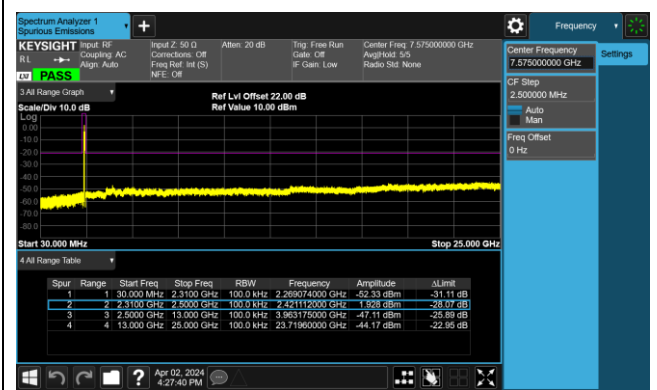

### 802.11 ax40 CH06 (2437MHz)

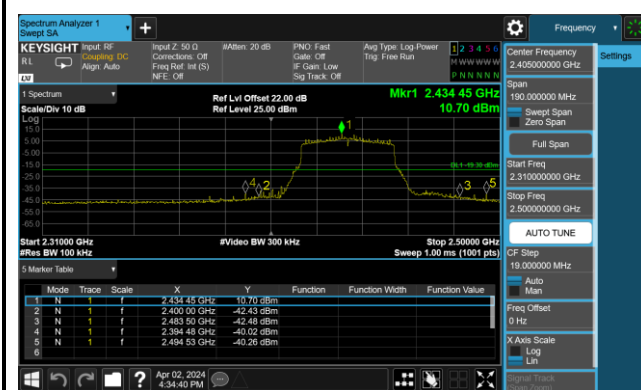

### 802.11 ax40 CH06 (2437MHz)

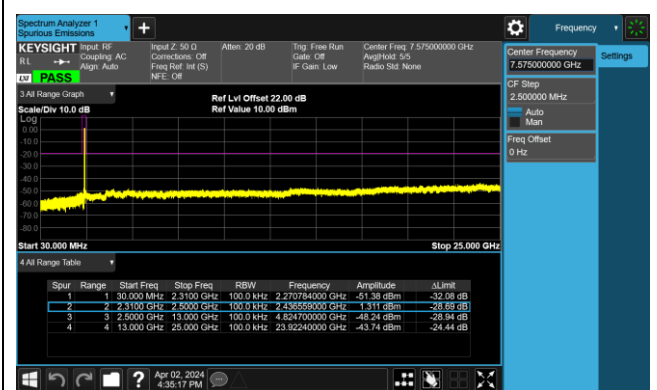

### 802.11 ax40 CH09 (2452MHz)

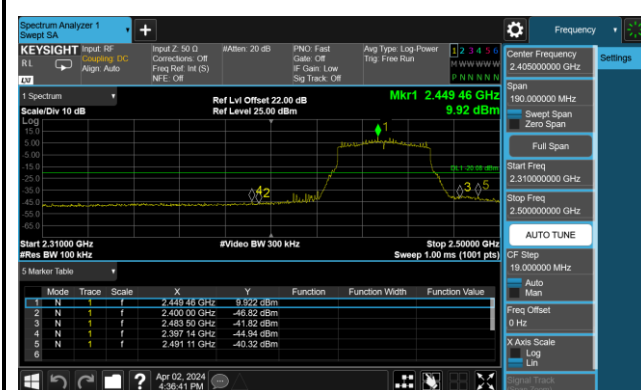

### 802.11 ax40 CH09 (2452MHz)

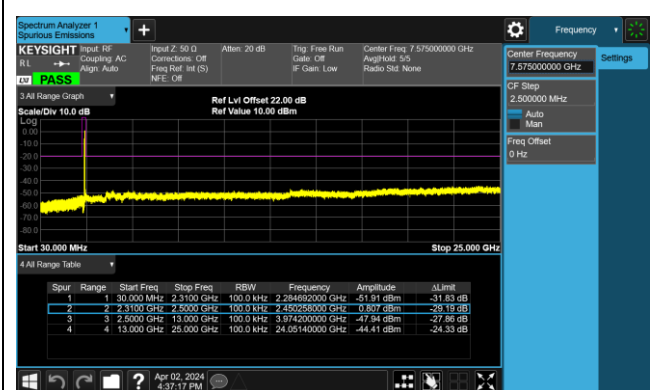

### 802.11be20 CH01 (2412MHz)

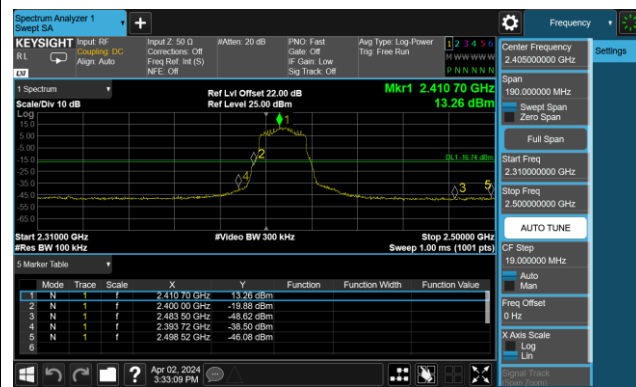

### 802.11be20 CH01 (2412MHz)

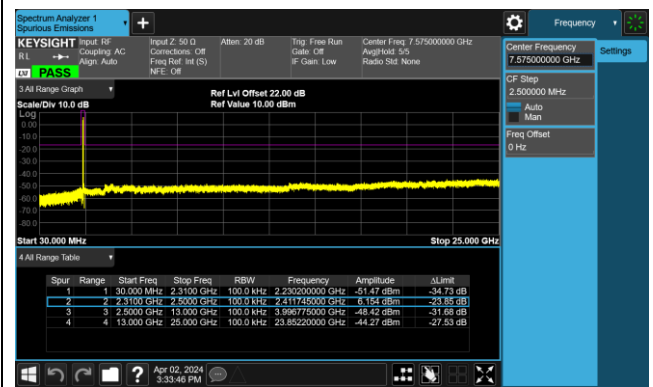

### 802.11be20 CH06 (2437MHz)

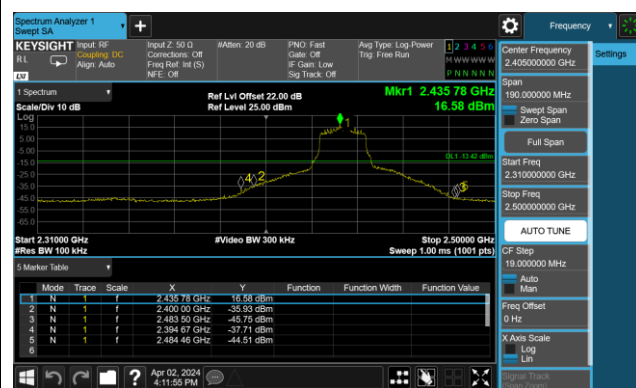

### 802.11be20 CH06 (2437MHz)

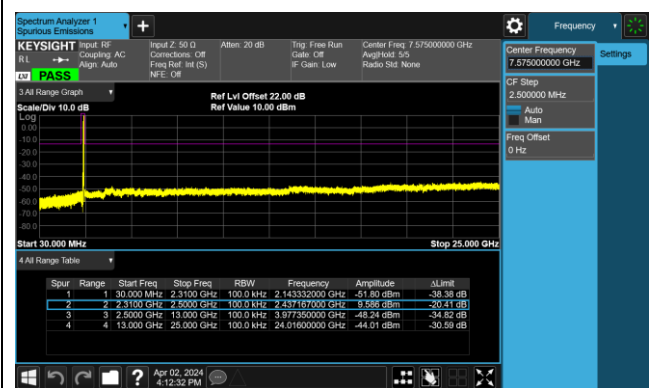

### 802.11be20 CH11 (2462MHz)

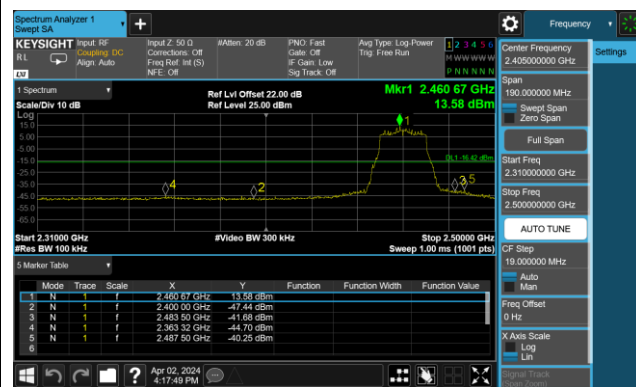

### 802.11be20 CH11 (2462MHz)

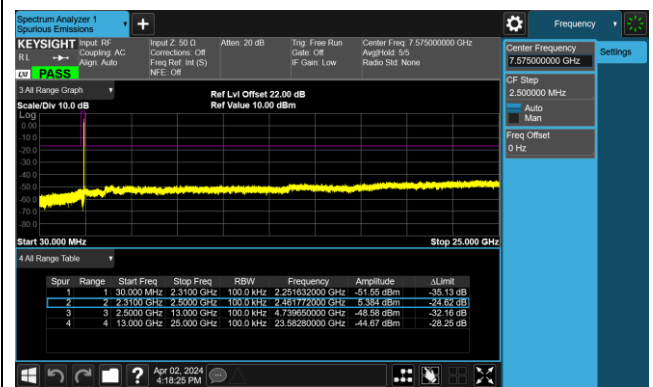

### 802.11be40 CH03 (2422MHz)

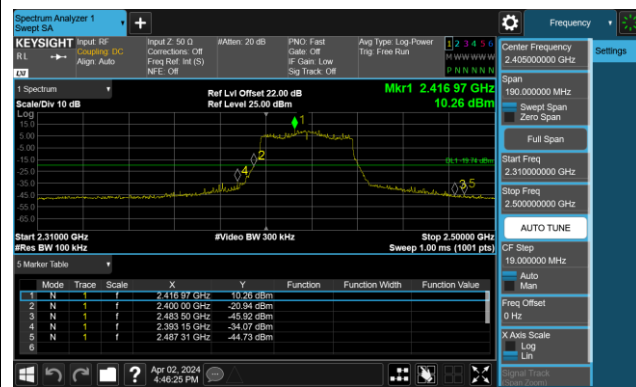

### 802.11be40 CH03 (2422MHz)

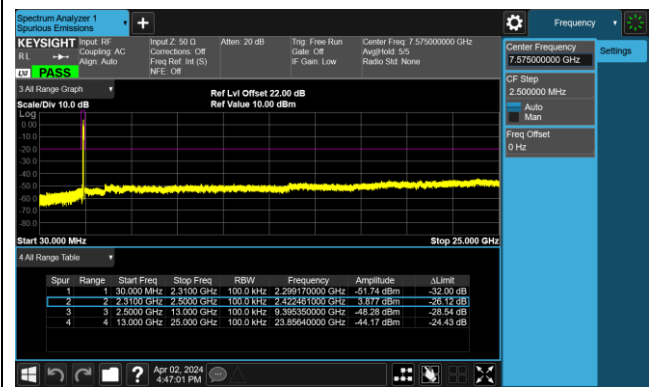

### 802.11be40 CH06 (2437MHz)



### 802.11be40 CH06 (2437MHz)

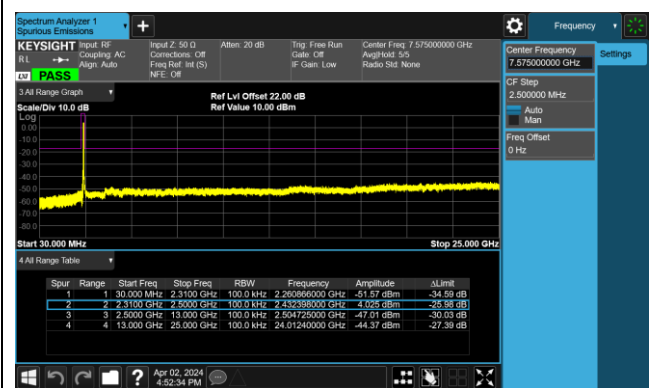

### 802.11be40 CH09 (2452MHz)

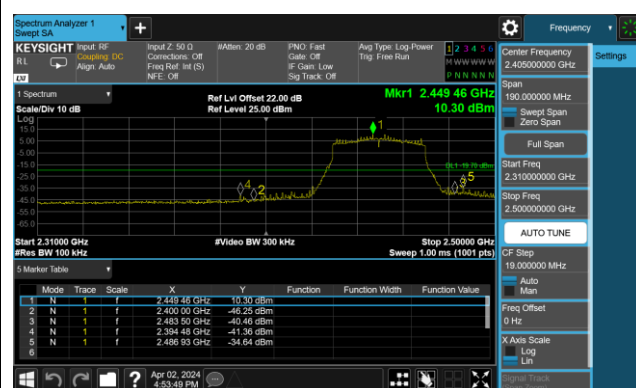

### 802.11be40 CH09 (2452MHz)

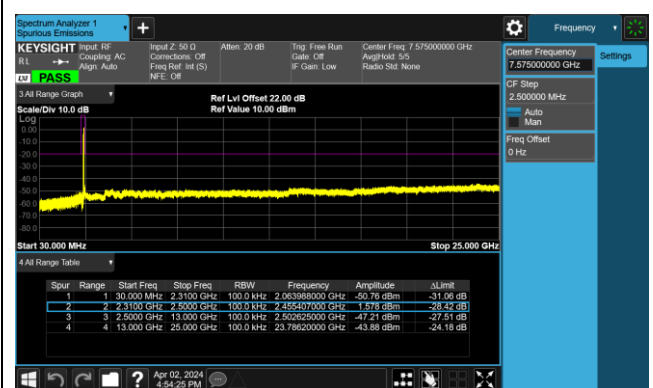

## 7.6. Radiated Spurious Emission Measurement

### 7.6.1. Test Limit

All out of band emissions appearing in a restricted band as specified in Section 15.205 of the Title 47CFR must not exceed the limits shown in Table per Section 15.209.

FCC Part 15 Subpart C Paragraph 15.209		
Frequency [MHz]	Field Strength [Uv/m]	Measured Distance [Meters]
0.009 - 0.490	2400/F (kHz)	300
0.490 - 1.705	24000/F (kHz)	30
1.705 - 30	30	30
30 - 88	100	3
88 - 216	150	3
216 - 960	200	3
Above 960	500	3

### 7.6.2. Test Procedure Used

ANSI C63.10 - 2013 - Section 11.11 & 11.12

ANSI C63.10 - 2013 Section 6.3 (General Requirements)

ANSI C63.10 - 2013 Section 6.4 (Standard test method below 30MHz)

ANSI C63.10 - 2013 Section 6.5 (Standard test method above 30MHz to 1GHz)

ANSI C63.10 - 2013 Section 6.6 (Standard test method above 1GHz)

### 7.6.3. Test Setting

**Table 1 - RBW as a function of frequency**

Frequency	RBW
9 ~ 150 kHz	200 ~ 300 Hz
0.15 ~ 30 MHz	9 ~ 10 kHz
30 ~ 1000 MHz	100 ~ 120 kHz
> 1000MHz	1MHz

**Quasi-Peak Measurements below 1GHz**

1. Analyzer center frequency was set to the frequency of the radiated spurious emission of interest
2. Span was set greater than 1MHz
3. RBW = as specified in Table 1
4. Detector = CISPR quasi-peak
5. Sweep time = auto couple
6. Trace was allowed to stabilize

**Peak Measurements above 1GHz**

1. Analyzer center frequency was set to the frequency of the radiated spurious emission of interest
2. RBW = 1MHz
3. VBW = 3MHz
4. Detector = peak
5. Sweep time = auto couple
6. Trace mode = max hold
7. Trace was allowed to stabilize

**Average Measurements above 1GHz (Method VB)**

1. Analyzer center frequency was set to the frequency of the radiated spurious emission of interest
2. RBW = 1MHz
3. VBW; If the EUT is configured to transmit with duty cycle  $\geq 98\%$ , set VBW = 10 Hz.  
If the EUT duty cycle is  $< 98\%$ , set VBW  $\geq 1/T$ . T is the minimum transmission duration.
4. Detector = Peak
5. Sweep time = auto
6. Trace mode = max hold
7. Trace was allowed to stabilize



### 7.6.4. Test Setup

#### Below 1GHz Test Setup:

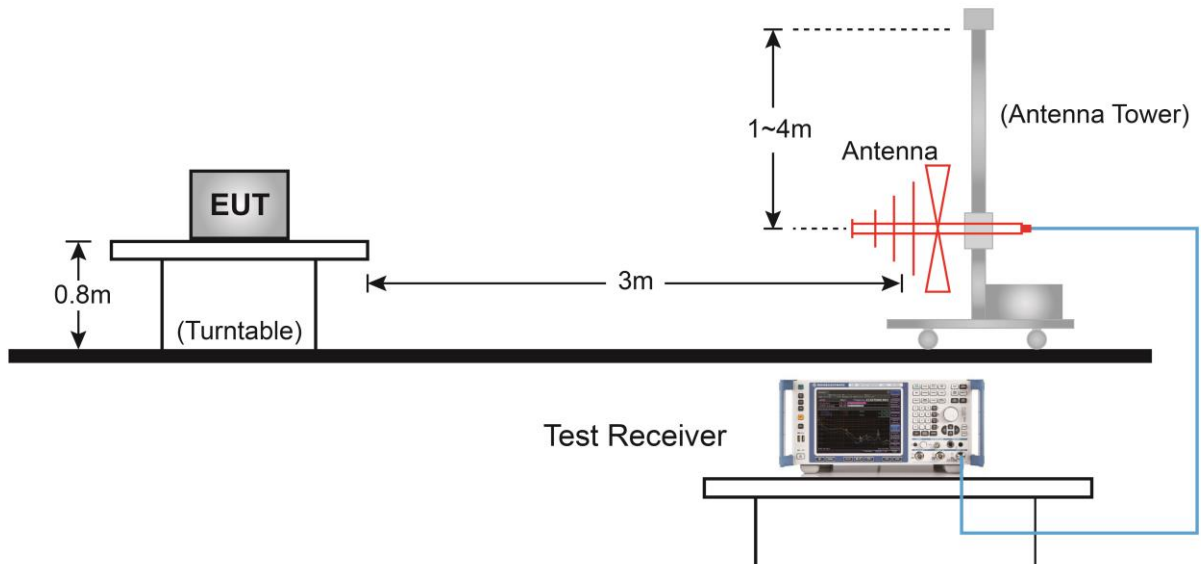

#### Above 1GHz Test Setup:

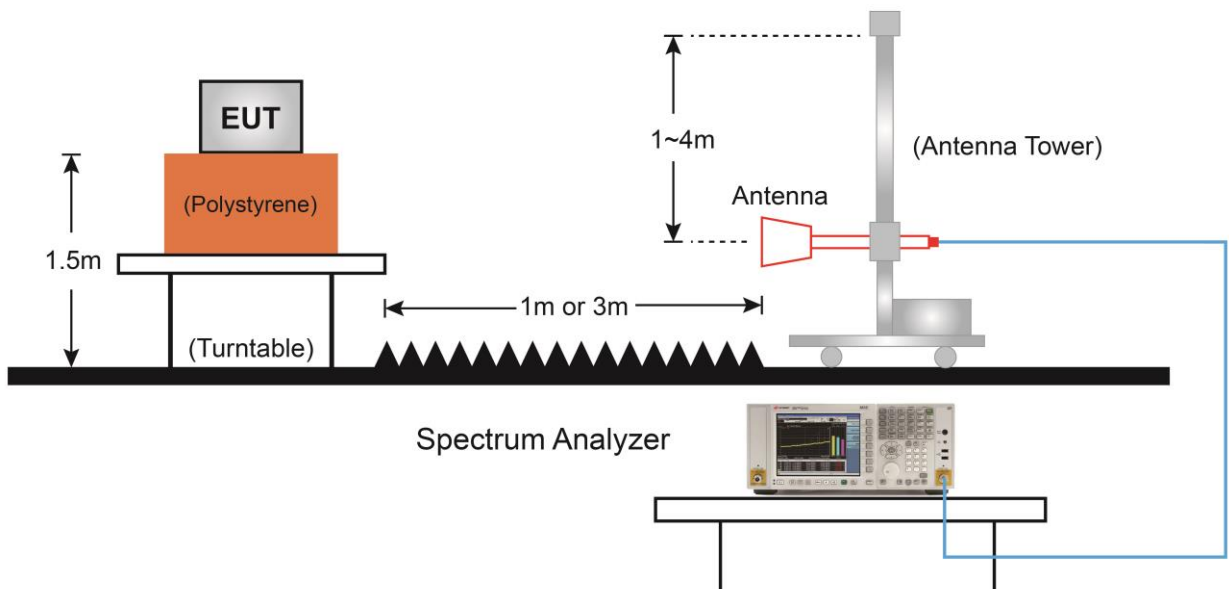

### 7.6.5. Test Result

EUT	BE5000 Whole Home Mesh Wi-Fi 7 System	Date of Test	2024-04-01
Factor	VULB 9162	Temp. / Humidity	24°C /60%
Polarity	Horizontal	Site / Test Engineer	AC2 / You
Test Mode	802.11n-20MHz_TX_CH 6_ANT 0+1	Test Voltage	AC 120V/60Hz

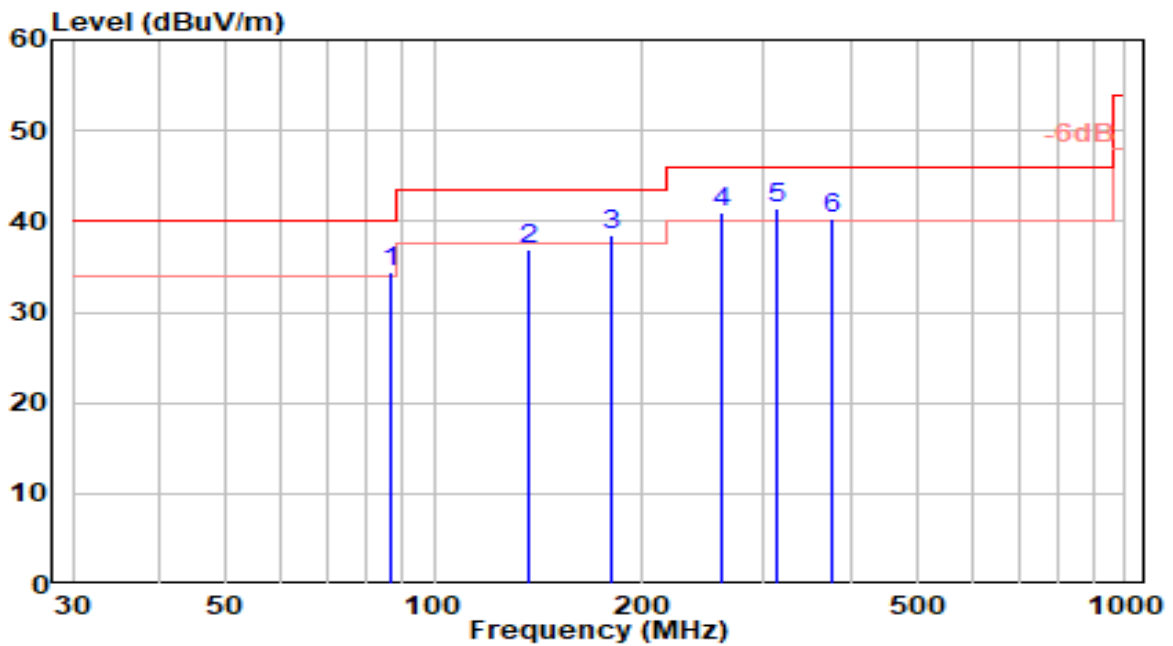

No	Frequency (MHz)	Reading (dBuV)	C.F (dB/m)	Measurement (dBuV/m)	Margin (dB)	Limit (dBuV/m)	Height (cm)	Angle (deg)	Remark (QP/PK/AV)
1	86.260	18.64	15.71	34.34	-5.66	40.00	150	253	QP
2	136.700	22.03	14.92	36.95	-6.55	43.50	150	244	QP
3	181.320	21.93	16.51	38.44	-5.06	43.50	200	243	QP
4	261.830	21.05	20.01	41.06	-4.94	46.00	100	243	QP
5	* 312.270	20.36	21.07	41.43	-4.57	46.00	100	228	QP
6	375.320	17.35	22.90	40.25	-5.75	46.00	100	360	QP

Note:

- "\*" means this data is the worst emission level.
- C.F (Correction Factor) = Antenna Factor (dB/m)+ Cable Loss (dB).
- Measurement (dBuV/m) = Reading(dBuV) + C.F (Correction Factor).
- The emission levels of other frequencies are very lower than the limit and not show in test report.
- The amplitude of radiated emissions (frequency range from 9kHz to 30MHz) is that proximity to ambient noise, which also are attenuated more than 20dB below the permissible value. Therefore, the data is not presented in the report.

EUT	BE5000 Whole Home Mesh Wi-Fi 7 System	Date of Test	2024-04-01
Factor	VULB 9162	Temp. / Humidity	24°C /60%
Polarity	Vertical	Site / Test Engineer	AC2 / You
Test Mode	802.11n-20MHz_TX_CH 6_ANT 0+1	Test Voltage	AC 120V/60Hz

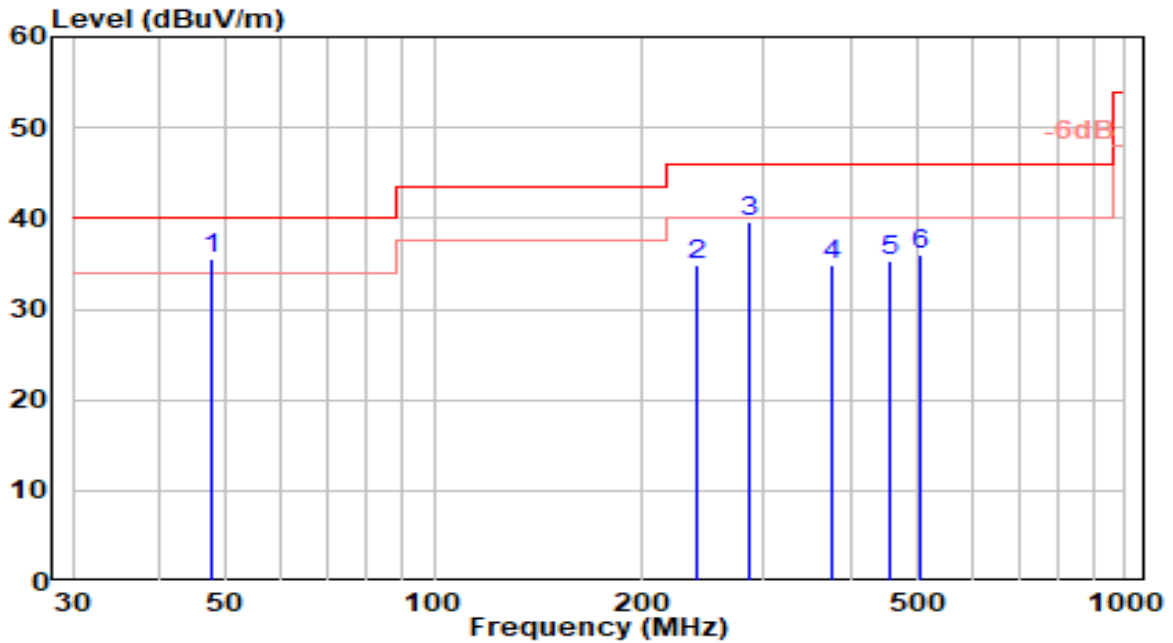

No	Frequency (MHz)	Reading (dBuV)	C.F (dB/m)	Measurement (dBuV/m)	Margin (dB)	Limit (dBuV/m)	Height (cm)	Angle (deg)	Remark (QP/PK/AV)
1	* 47.460	15.01	20.49	35.50	-4.50	40.00	150	293	QP
2	239.520	15.59	19.35	34.94	-11.06	46.00	100	232	QP
3	287.050	19.23	20.36	39.60	-6.40	46.00	100	296	QP
4	375.320	12.03	22.90	34.93	-11.07	46.00	100	324	QP
5	455.830	11.32	23.95	35.28	-10.72	46.00	100	274	QP
6	504.330	10.95	25.07	36.03	-9.97	46.00	150	278	QP

Note:

- "\*" means this data is the worst emission level.
- C.F (Correction Factor) = Antenna Factor (dB/m)+ Cable Loss (dB).
- Measurement (dBuV/m) = Reading(dBuV) + C.F (Correction Factor).
- The emission levels of other frequencies are very lower than the limit and not show in test report.
- The amplitude of radiated emissions (frequency range from 9kHz to 30MHz) is that proximity to ambient noise, which also are attenuated more than 20dB below the permissible value. Therefore, the data is not presented in the report.

EUT	BE5000 Whole Home Mesh Wi-Fi 7 System	Date of Test	2024-03-23
Factor	DRH18-E	Temp. / Humidity	24°C /60%
Polarity	Horizontal	Site / Test Engineer	AC2 / Marvin
Test Mode	802.11b_TX_CH 1_ANT 0+1	Test Voltage	AC 120V/60Hz

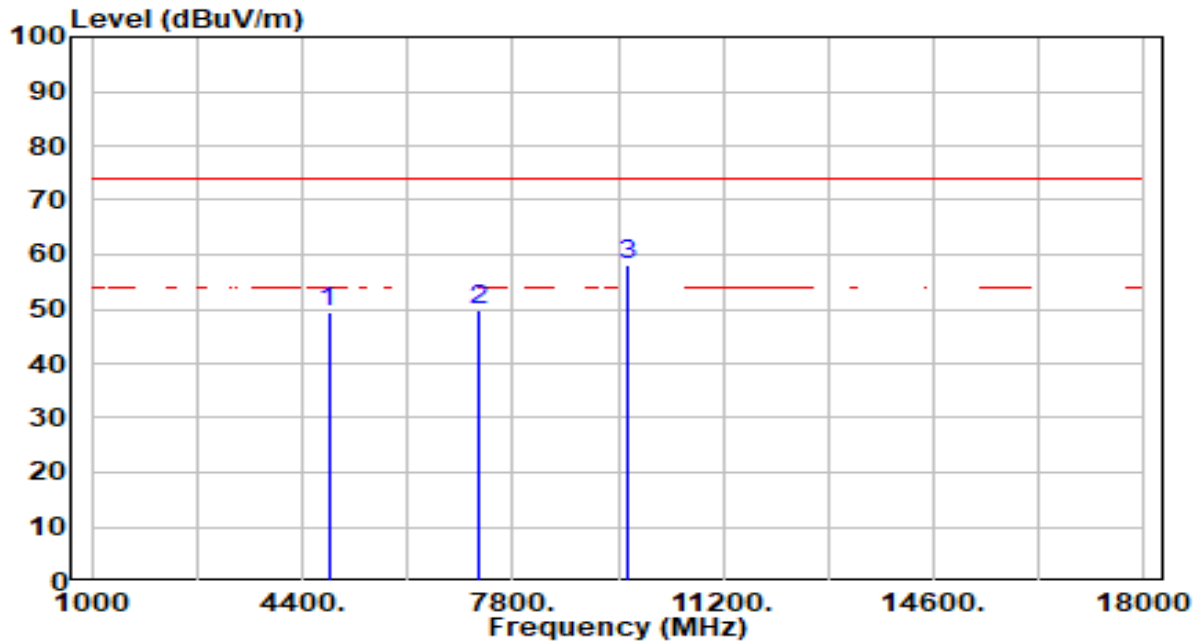

No	Frequency (MHz)	Reading (dBuV)	C.F (dB/m)	Measurement (dBuV/m)	Margin (dB)	Limit (dBuV/m)	Height (cm)	Angle (deg)	Remark (QP/PK/AV)
1	4824.000	49.30	0.23	49.54	-24.46	74.00	200	360	Peak
2	7236.000	44.28	5.54	49.83	-24.17	74.00	200	92	Peak
3	* 9648.000	52.89	5.30	58.19	-15.81	74.00	200	146	Peak

Note:

1. " \*", means this data is the worst emission level.
2. C.F (Correction Factor) = Antenna Factor (dB/m)+ Cable Loss (dB) – Preamplifier(dB).
3. Measurement (dBuV/m) = Reading(dBuV) + C.F (Correction Factor).
4. The emission levels of other frequencies are very lower than the limit and not show in test report.

EUT	BE5000 Whole Home Mesh Wi-Fi 7 System	Date of Test	2024-03-23
Factor	DRH18-E	Temp. / Humidity	24°C /60%
Polarity	Vertical	Site / Test Engineer	AC2 / Marvin
Test Mode	802.11b_TX_CH 1_ANT 0+1	Test Voltage	AC 120V/60Hz

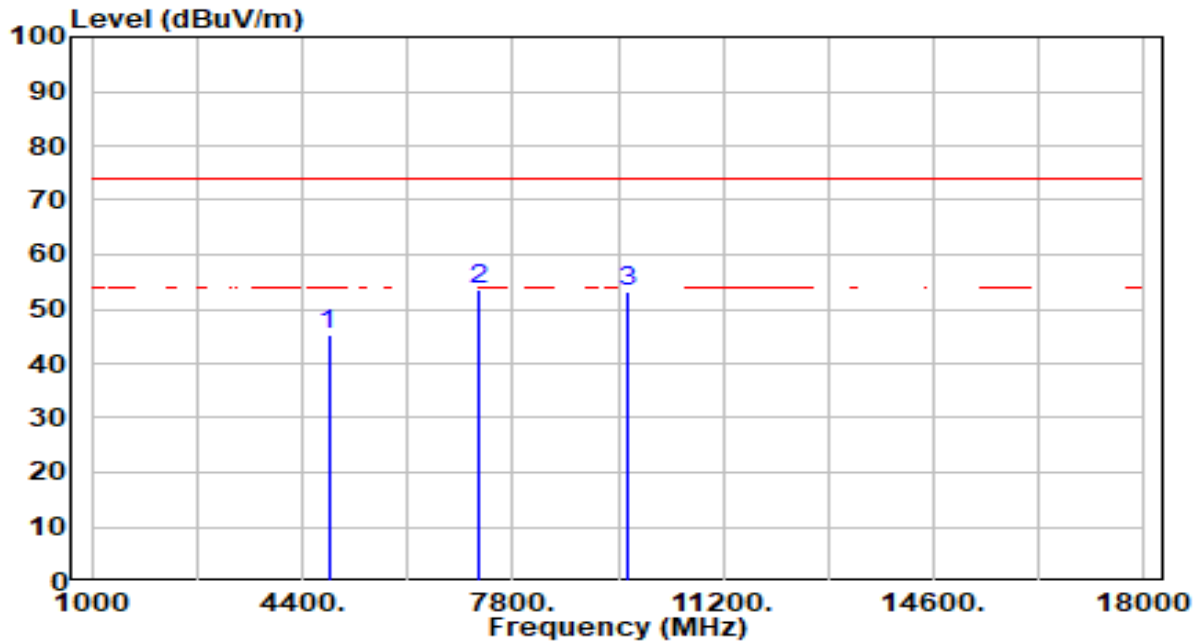

No	Frequency (MHz)	Reading (dBuV)	C.F (dB/m)	Measurement (dBuV/m)	Margin (dB)	Limit (dBuV/m)	Height (cm)	Angle (deg)	Remark (QP/PK/AV)
1	4824.000	44.98	0.23	45.21	-28.79	74.00	200	352	Peak
2	* 7236.000	48.10	5.54	53.65	-20.35	74.00	200	180	Peak
3	9648.000	48.07	5.30	53.37	-20.63	74.00	200	168	Peak

Note:

1. " \*", means this data is the worst emission level.
2. C.F (Correction Factor) = Antenna Factor (dB/m)+ Cable Loss (dB) – Preamplifier(dB).
3. Measurement (dBuV/m) = Reading(dBuV) + C.F (Correction Factor).
4. The emission levels of other frequencies are very lower than the limit and not show in test report.

EUT	BE5000 Whole Home Mesh Wi-Fi 7 System	Date of Test	2024-03-23
Factor	DRH18-E	Temp. / Humidity	24°C /60%
Polarity	Horizontal	Site / Test Engineer	AC2 / Marvin
Test Mode	802.11b_TX_CH 6_ANT 0+1	Test Voltage	AC 120V/60Hz

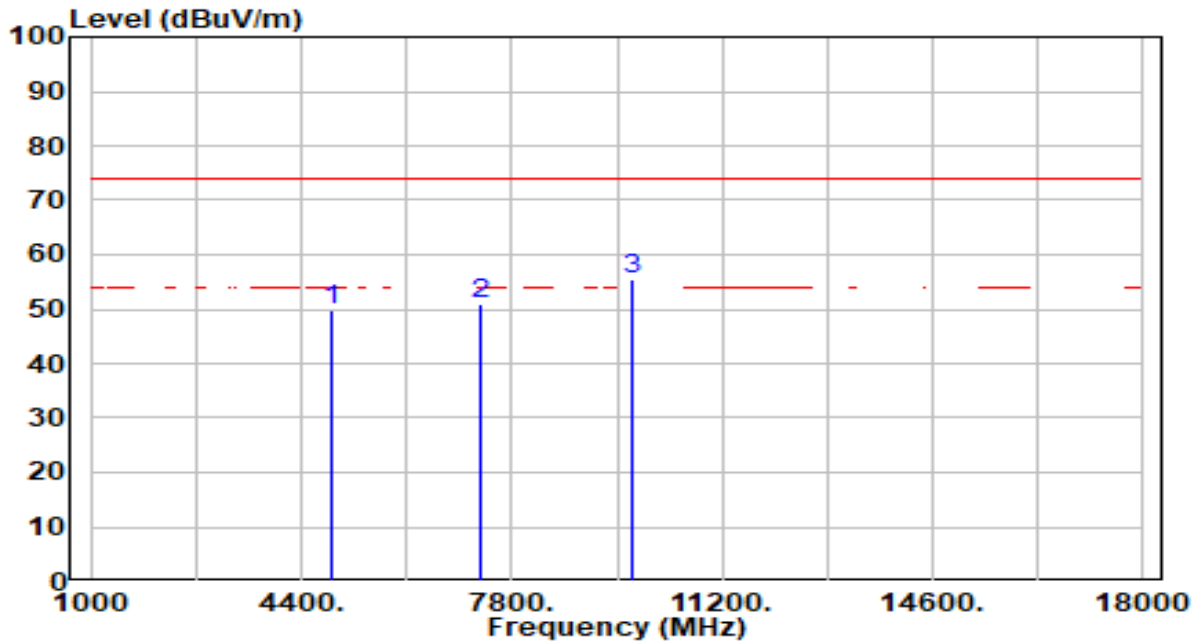

No	Frequency (MHz)	Reading (dBuV)	C.F (dB/m)	Measurement (dBuV/m)	Margin (dB)	Limit (dBuV/m)	Height (cm)	Angle (deg)	Remark (QP/PK/AV)
1	4874.000	49.40	0.36	49.77	-24.23	74.00	200	0	Peak
2	7311.000	45.46	5.59	51.05	-22.95	74.00	200	144	Peak
3	* 9748.000	49.96	5.34	55.31	-18.69	74.00	200	141	Peak

Note:

1. " \*", means this data is the worst emission level.
2. C.F (Correction Factor) = Antenna Factor (dB/m)+ Cable Loss (dB) – Preamplifier(dB).
3. Measurement (dBuV/m) = Reading(dBuV) + C.F (Correction Factor).
4. The emission levels of other frequencies are very lower than the limit and not show in test report.

EUT	BE5000 Whole Home Mesh Wi-Fi 7 System	Date of Test	2024-03-23
Factor	DRH18-E	Temp. / Humidity	24°C /60%
Polarity	Vertical	Site / Test Engineer	AC2 / Marvin
Test Mode	802.11b_TX_CH 6_ANT 0+1	Test Voltage	AC 120V/60Hz

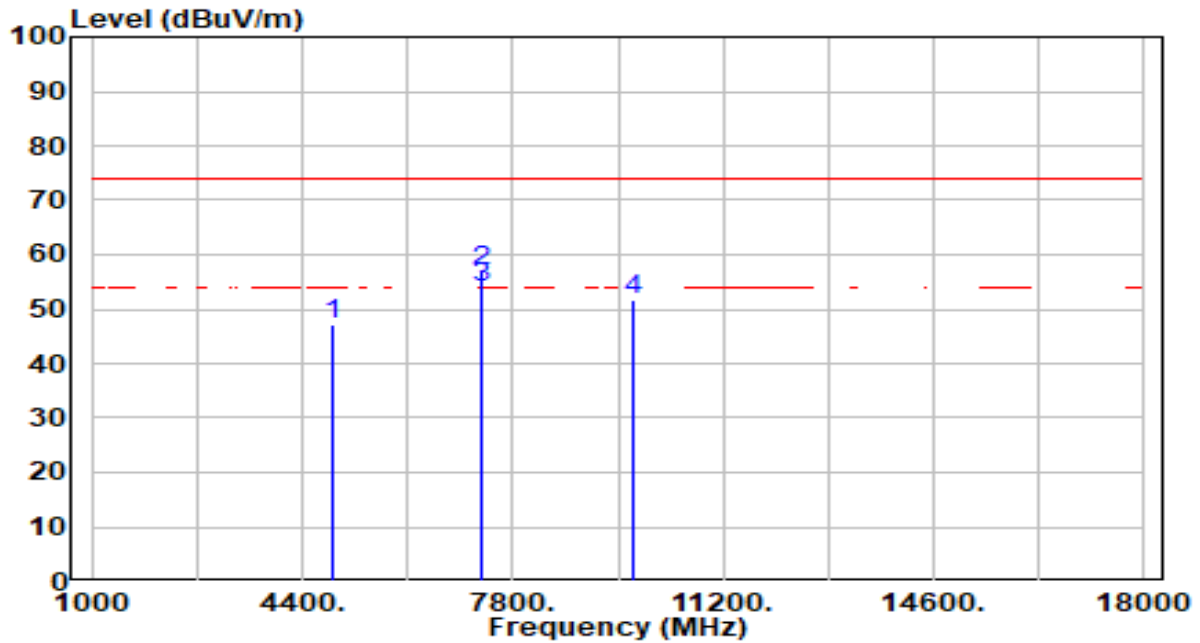

No	Frequency (MHz)	Reading (dBuV)	C.F (dB/m)	Measurement (dBuV/m)	Margin (dB)	Limit (dBuV/m)	Height (cm)	Angle (deg)	Remark (QP/PK/AV)
1	4874.000	46.91	0.36	47.27	-26.73	74.00	200	0	Peak
2	* 7311.000	51.55	5.59	57.14	-16.86	74.00	200	182	Peak
3	* 7311.000	48.24	5.59	53.83	-0.17	54.00	200	182	Average
4	9748.000	46.52	5.34	51.86	-22.14	74.00	200	170	Peak

Note:

- "\*" means this data is the worst emission level.
- C.F (Correction Factor) = Antenna Factor (dB/m)+ Cable Loss (dB) – Pre-amplifier(dB).
- Measurement (dBuV/m) = Reading(dBuV) + C.F (Correction Factor).
- The emission levels of other frequencies are very lower than the limit and not show in test report.

EUT	BE5000 Whole Home Mesh Wi-Fi 7 System	Date of Test	2024-03-23
Factor	DRH18-E	Temp. / Humidity	24°C /60%
Polarity	Horizontal	Site / Test Engineer	AC2 / Marvin
Test Mode	802.11b_TX_CH 11_ANT 0+1	Test Voltage	AC 120V/60Hz

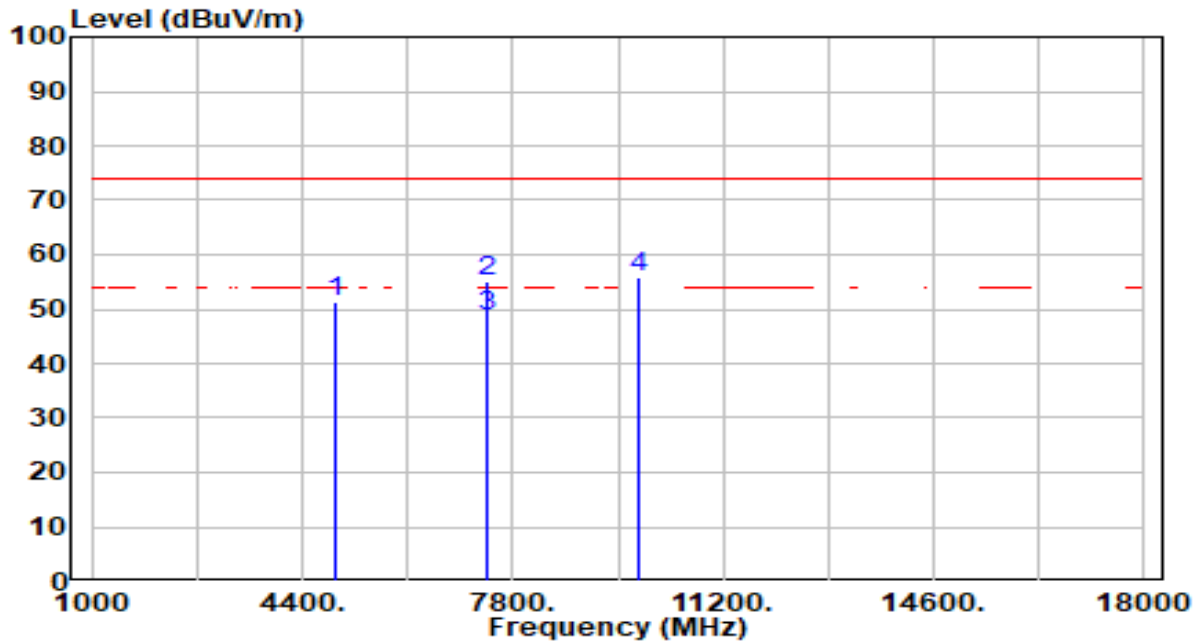

No	Frequency (MHz)	Reading (dBuV)	C.F (dB/m)	Measurement (dBuV/m)	Margin (dB)	Limit (dBuV/m)	Height (cm)	Angle (deg)	Remark (QP/PK/AV)
1	4924.000	50.79	0.49	51.29	-22.71	74.00	200	0	Peak
2	7386.000	49.30	5.64	54.94	-19.06	74.00	200	137	Peak
3	* 7386.000	43.06	5.64	48.70	-5.30	54.00	200	137	Average
4	* 9848.000	50.54	5.39	55.93	-18.07	74.00	200	177	Peak

Note:

- "\*" means this data is the worst emission level.
- C.F (Correction Factor) = Antenna Factor (dB/m)+ Cable Loss (dB) – Pre-amplifier(dB).
- Measurement (dBuV/m) = Reading(dBuV) + C.F (Correction Factor).
- The emission levels of other frequencies are very lower than the limit and not show in test report.



EUT	BE5000 Whole Home Mesh Wi-Fi 7 System	Date of Test	2024-03-23
Factor	DRH18-E	Temp. / Humidity	24°C /60%
Polarity	Vertical	Site / Test Engineer	AC2 / Marvin
Test Mode	802.11b_TX_CH 11_ANT 0+1	Test Voltage	AC 120V/60Hz

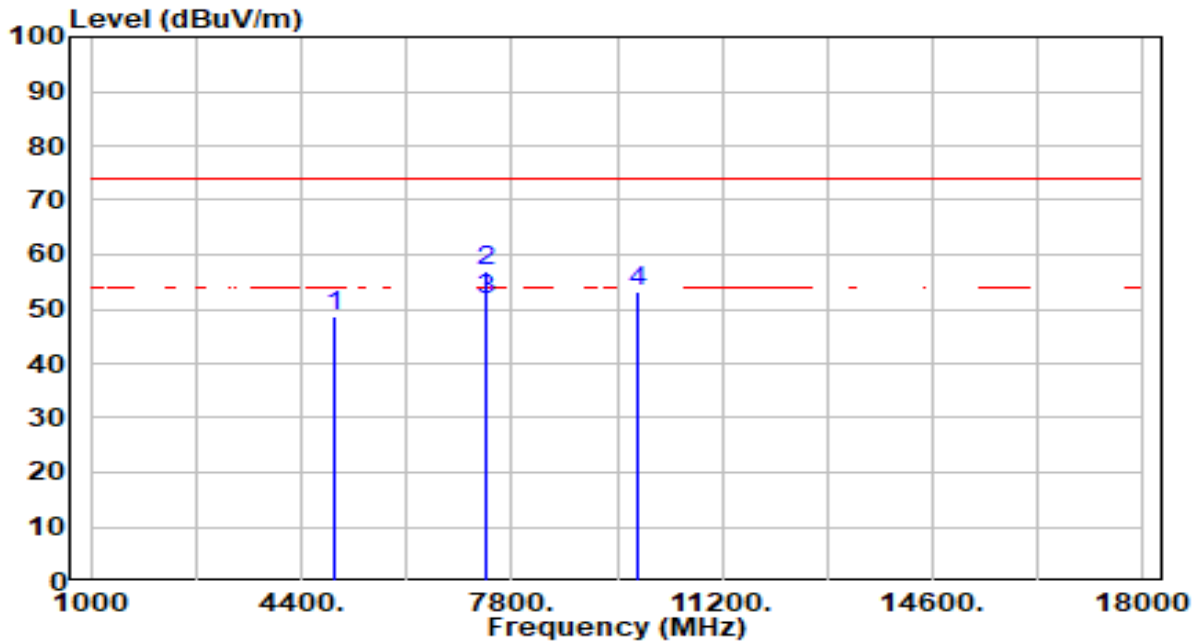

No	Frequency (MHz)	Reading (dBuV)	C.F (dB/m)	Measurement (dBuV/m)	Margin (dB)	Limit (dBuV/m)	Height (cm)	Angle (deg)	Remark (QP/PK/AV)
1	4924.000	48.35	0.49	48.84	-25.16	74.00	200	360	Peak
2	* 7386.000	51.45	5.64	57.09	-16.91	74.00	200	182	Peak
3	* 7386.000	46.03	5.64	51.67	-2.33	54.00	200	182	Average
4	9848.000	47.71	5.39	53.10	-20.90	74.00	200	174	Peak

Note:

- "\*" means this data is the worst emission level.
- C.F (Correction Factor) = Antenna Factor (dB/m)+ Cable Loss (dB) – Pre-amplifier(dB).
- Measurement (dBuV/m) = Reading(dBuV) + C.F (Correction Factor).
- The emission levels of other frequencies are very lower than the limit and not show in test report.

EUT	BE5000 Whole Home Mesh Wi-Fi 7 System	Date of Test	2024-03-23
Factor	DRH18-E	Temp. / Humidity	24°C /60%
Polarity	Horizontal	Site / Test Engineer	AC2 / Marvin
Test Mode	802.11g_TX_CH 1_ANT 0+1	Test Voltage	AC 120V/60Hz

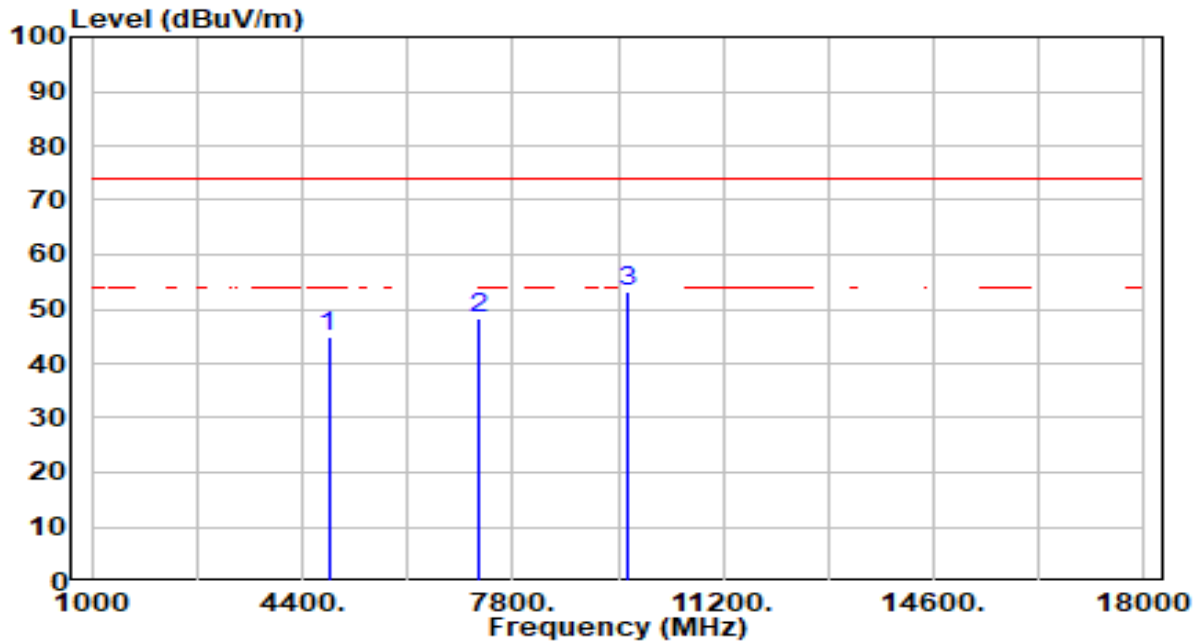

No	Frequency (MHz)	Reading (dBuV)	C.F (dB/m)	Measurement (dBuV/m)	Margin (dB)	Limit (dBuV/m)	Height (cm)	Angle (deg)	Remark (QP/PK/AV)
1	4824.000	44.84	0.23	45.07	-28.93	74.00	200	0	Peak
2	7236.000	42.71	5.54	48.26	-25.74	74.00	200	113	Peak
3	* 9648.000	47.78	5.30	53.08	-20.92	74.00	200	142	Peak

Note:

1. " \*", means this data is the worst emission level.
2. C.F (Correction Factor) = Antenna Factor (dB/m)+ Cable Loss (dB) – Pre-amplifier(dB).
3. Measurement (dBuV/m) = Reading(dBuV) + C.F (Correction Factor).
4. The emission levels of other frequencies are very lower than the limit and not show in test report.

EUT	BE5000 Whole Home Mesh Wi-Fi 7 System	Date of Test	2024-03-23
Factor	DRH18-E	Temp. / Humidity	24°C /60%
Polarity	Vertical	Site / Test Engineer	AC2 / Marvin
Test Mode	802.11g_TX_CH 1_ANT 0+1	Test Voltage	AC 120V/60Hz

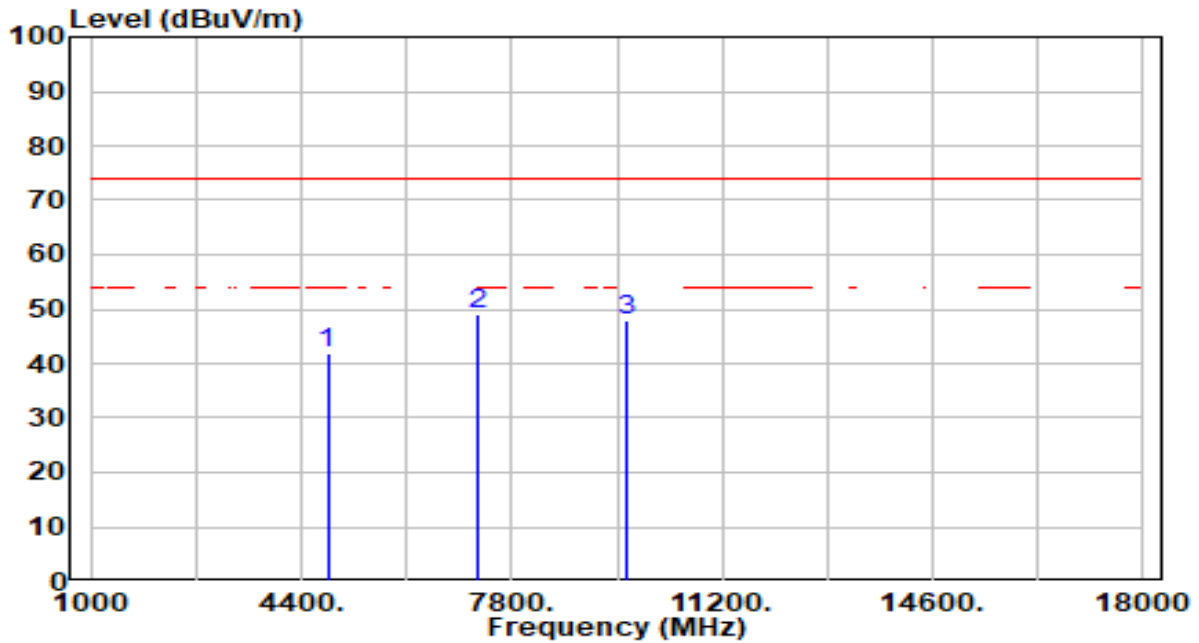

No	Frequency (MHz)	Reading (dBuV)	C.F (dB/m)	Measurement (dBuV/m)	Margin (dB)	Limit (dBuV/m)	Height (cm)	Angle (deg)	Remark (QP/PK/AV)
1	4824.000	41.56	0.23	41.80	-32.20	74.00	200	354	Peak
2	* 7236.000	43.59	5.54	49.13	-24.87	74.00	200	166	Peak
3	9648.000	42.61	5.30	47.91	-26.09	74.00	200	152	Peak

Note:

1. " \*", means this data is the worst emission level.
2. C.F (Correction Factor) = Antenna Factor (dB/m)+ Cable Loss (dB) – Preamplifier(dB).
3. Measurement (dBuV/m) = Reading(dBuV) + C.F (Correction Factor).
4. The emission levels of other frequencies are very lower than the limit and not show in test report.

EUT	BE5000 Whole Home Mesh Wi-Fi 7 System	Date of Test	2024-03-23
Factor	DRH18-E	Temp. / Humidity	24°C /60%
Polarity	Horizontal	Site / Test Engineer	AC2 / Marvin
Test Mode	802.11g_TX_CH 6_ANT 0+1	Test Voltage	AC 120V/60Hz

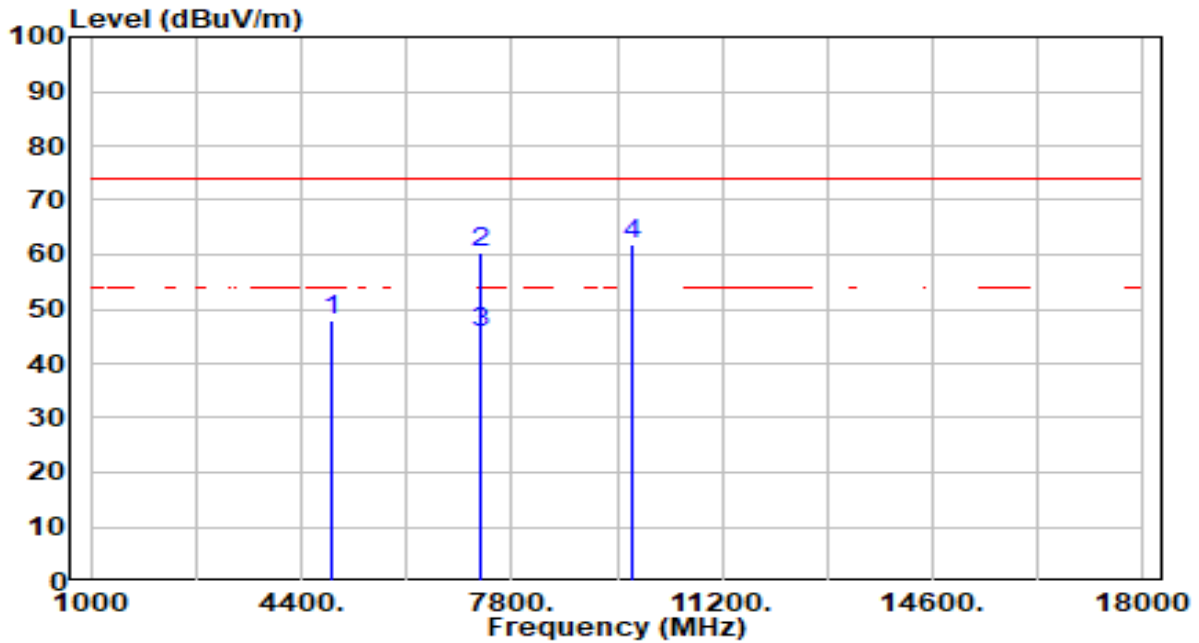

No	Frequency (MHz)	Reading (dBuV)	C.F (dB/m)	Measurement (dBuV/m)	Margin (dB)	Limit (dBuV/m)	Height (cm)	Angle (deg)	Remark (QP/PK/AV)
1	4874.000	47.48	0.36	47.84	-26.16	74.00	200	8	Peak
2	7311.000	54.61	5.59	60.20	-13.80	74.00	200	112	Peak
3	* 7311.000	40.19	5.59	45.78	-8.22	54.00	200	112	Average
4	* 9748.000	56.49	5.34	61.84	-12.16	74.00	200	147	Peak

Note:

- "\*" means this data is the worst emission level.
- C.F (Correction Factor) = Antenna Factor (dB/m)+ Cable Loss (dB) – Pre-amplifier(dB).
- Measurement (dBuV/m) = Reading(dBuV) + C.F (Correction Factor).
- The emission levels of other frequencies are very lower than the limit and not show in test report.

EUT	BE5000 Whole Home Mesh Wi-Fi 7 System	Date of Test	2024-03-23
Factor	DRH18-E	Temp. / Humidity	24°C /60%
Polarity	Vertical	Site / Test Engineer	AC2 / Marvin
Test Mode	802.11g_TX_CH 6_ANT 0+1	Test Voltage	AC 120V/60Hz

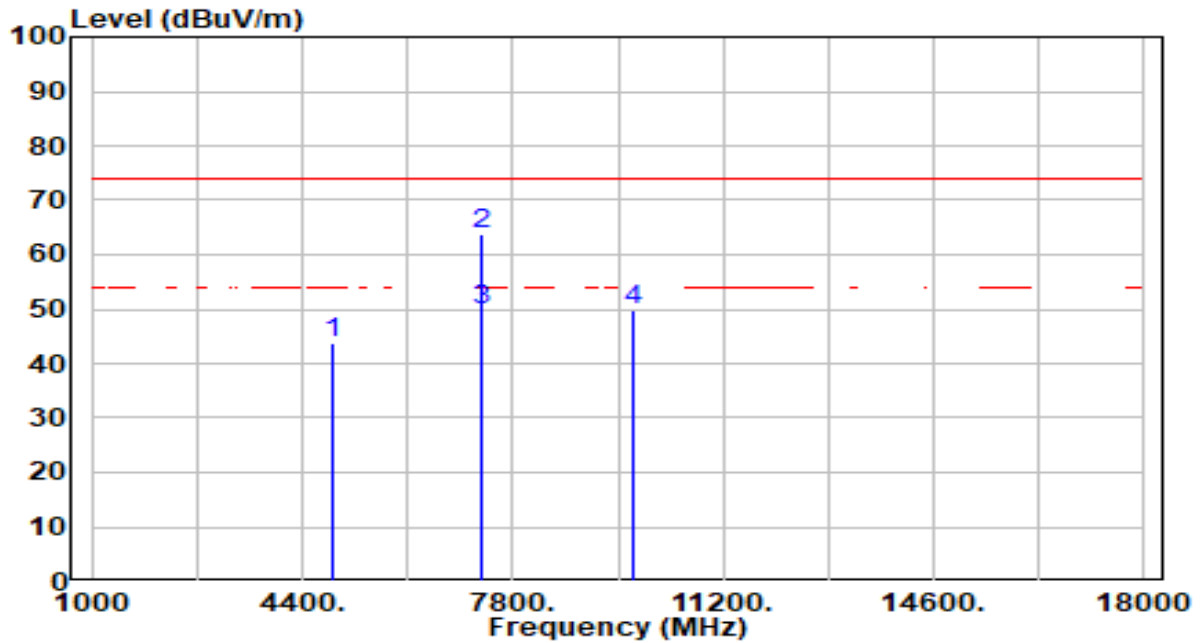

No	Frequency (MHz)	Reading (dBuV)	C.F (dB/m)	Measurement (dBuV/m)	Margin (dB)	Limit (dBuV/m)	Height (cm)	Angle (deg)	Remark (QP/PK/AV)
1	4874.000	43.24	0.36	43.61	-30.39	74.00	200	343	Peak
2	* 7311.000	58.19	5.59	63.78	-10.22	74.00	200	193	Peak
3	* 7311.000	44.09	5.59	49.68	-4.32	54.00	200	193	Average
4	9748.000	44.60	5.34	49.94	-24.06	74.00	200	167	Peak

Note:

- "\*" means this data is the worst emission level.
- C.F (Correction Factor) = Antenna Factor (dB/m)+ Cable Loss (dB) – Preamplifier(dB).
- Measurement (dBuV/m) = Reading(dBuV) + C.F (Correction Factor).
- The emission levels of other frequencies are very lower than the limit and not show in test report.

EUT	BE5000 Whole Home Mesh Wi-Fi 7 System	Date of Test	2024-03-23
Factor	DRH18-E	Temp. / Humidity	24°C /60%
Polarity	Horizontal	Site / Test Engineer	AC2 / Marvin
Test Mode	802.11g_TX_CH 11_ANT 0+1	Test Voltage	AC 120V/60Hz

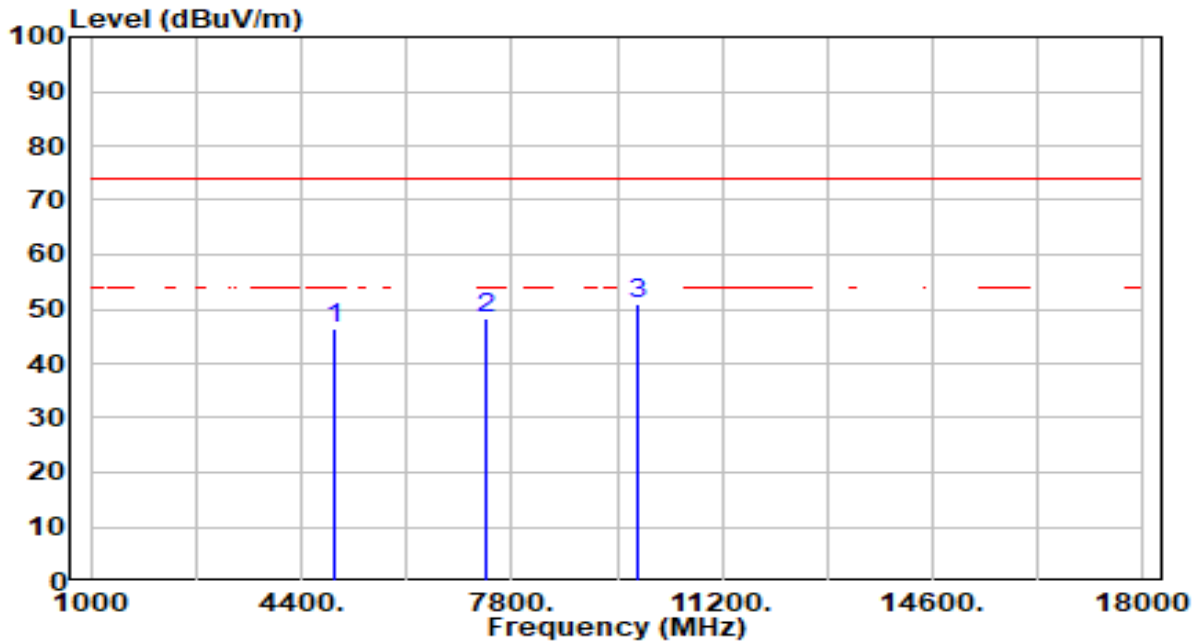

No	Frequency (MHz)	Reading (dBuV)	C.F (dB/m)	Measurement (dBuV/m)	Margin (dB)	Limit (dBuV/m)	Height (cm)	Angle (deg)	Remark (QP/PK/AV)
1	4924.000	45.97	0.49	46.46	-27.54	74.00	200	2	Peak
2	7386.000	42.77	5.64	48.40	-25.60	74.00	200	148	Peak
3	* 9848.000	45.40	5.39	50.79	-23.21	74.00	200	157	Peak

Note:

1. " \*", means this data is the worst emission level.
2. C.F (Correction Factor) = Antenna Factor (dB/m)+ Cable Loss (dB) – Preamplifier(dB).
3. Measurement (dBuV/m) = Reading(dBuV) + C.F (Correction Factor).
4. The emission levels of other frequencies are very lower than the limit and not show in test report.

EUT	BE5000 Whole Home Mesh Wi-Fi 7 System	Date of Test	2024-03-23
Factor	DRH18-E	Temp. / Humidity	24°C /60%
Polarity	Vertical	Site / Test Engineer	AC2 / Marvin
Test Mode	802.11g_TX_CH 11_ANT 0+1	Test Voltage	AC 120V/60Hz

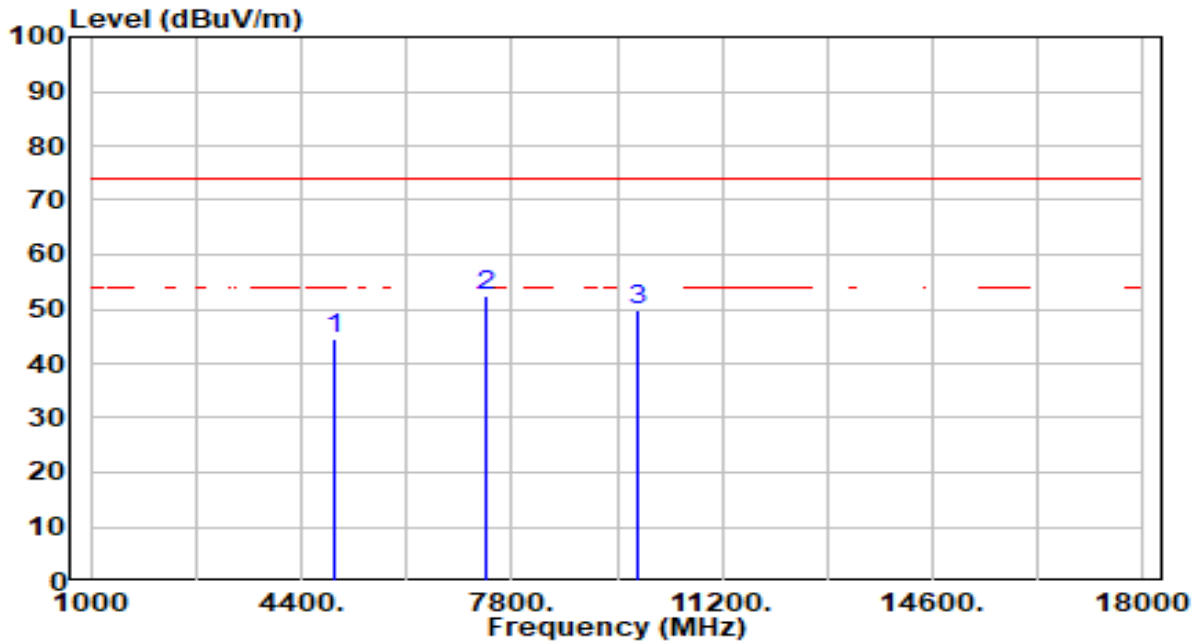

No	Frequency (MHz)	Reading (dBUV)	C.F (dB/m)	Measurement (dBUV/m)	Margin (dB)	Limit (dBUV/m)	Height (cm)	Angle (deg)	Remark (QP/PK/AV)
1	4924.000	43.91	0.49	44.41	-29.59	74.00	200	1	Peak
2	* 7386.000	46.67	5.64	52.30	-21.70	74.00	200	190	Peak
3	9848.000	44.26	5.39	49.65	-24.35	74.00	200	169	Peak

Note:

1. " \*", means this data is the worst emission level.
2. C.F (Correction Factor) = Antenna Factor (dB/m)+ Cable Loss (dB) – Preamplifier(dB).
3. Measurement (dBUV/m) = Reading(dBUV) + C.F (Correction Factor).
4. The emission levels of other frequencies are very lower than the limit and not show in test report.

EUT	BE5000 Whole Home Mesh Wi-Fi 7 System	Date of Test	2024-03-23
Factor	DRH18-E	Temp. / Humidity	24°C /60%
Polarity	Horizontal	Site / Test Engineer	AC2 / Marvin
Test Mode	802.11n-20MHz_TX_CH 1_ANT 0+1	Test Voltage	AC 120V/60Hz

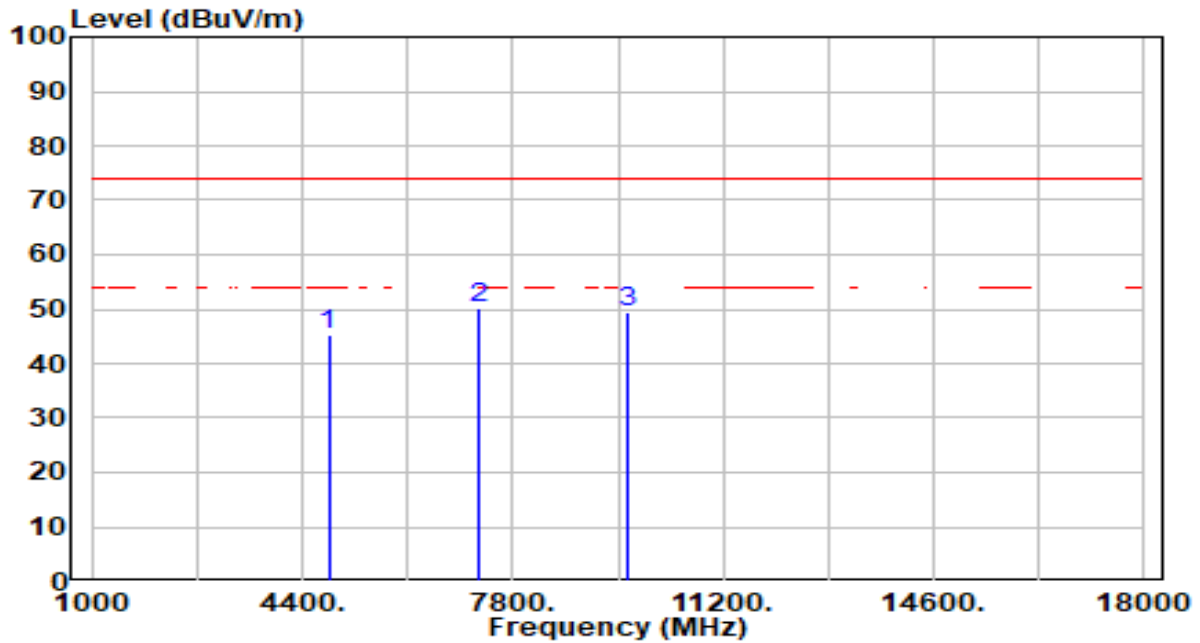

No	Frequency (MHz)	Reading (dBuV)	C.F (dB/m)	Measurement (dBuV/m)	Margin (dB)	Limit (dBuV/m)	Height (cm)	Angle (deg)	Remark (QP/PK/AV)
1	4824.000	45.12	0.23	45.36	-28.64	74.00	200	0	Peak
2	* 7236.000	44.52	5.54	50.06	-23.94	74.00	200	142	Peak
3	9648.000	44.16	5.30	49.46	-24.54	74.00	200	147	Peak

Note:

1. " \*", means this data is the worst emission level.
2. C.F (Correction Factor) = Antenna Factor (dB/m)+ Cable Loss (dB) – Preamplifier(dB).
3. Measurement (dBuV/m) = Reading(dBuV) + C.F (Correction Factor).
4. The emission levels of other frequencies are very lower than the limit and not show in test report.



EUT	BE5000 Whole Home Mesh Wi-Fi 7 System	Date of Test	2024-03-23
Factor	DRH18-E	Temp. / Humidity	24°C /60%
Polarity	Vertical	Site / Test Engineer	AC2 / Marvin
Test Mode	802.11n-20MHz_TX_CH 1_ANT 0+1	Test Voltage	AC 120V/60Hz

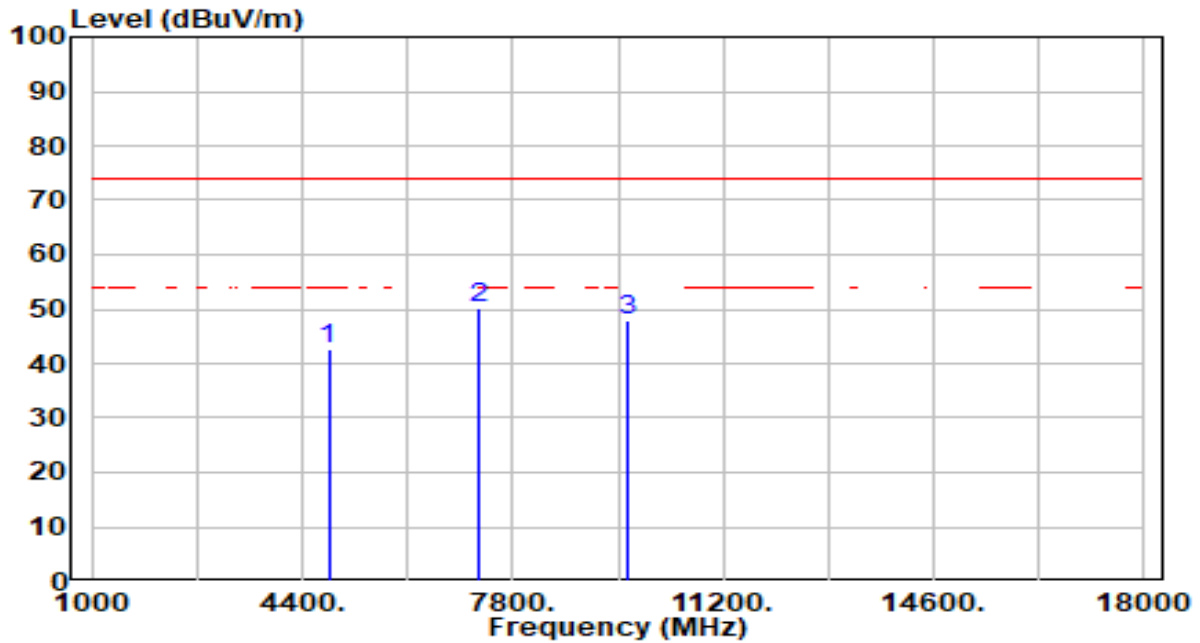

No	Frequency (MHz)	Reading (dBuV)	C.F (dB/m)	Measurement (dBuV/m)	Margin (dB)	Limit (dBuV/m)	Height (cm)	Angle (deg)	Remark (QP/PK/AV)
1	4824.000	42.36	0.23	42.59	-31.41	74.00	200	360	Peak
2	* 7236.000	44.57	5.54	50.11	-23.89	74.00	200	187	Peak
3	9648.000	42.63	5.30	47.93	-26.07	74.00	200	178	Peak

Note:

1. " \*", means this data is the worst emission level.
2. C.F (Correction Factor) = Antenna Factor (dB/m)+ Cable Loss (dB) – Preamplifier(dB).
3. Measurement (dBuV/m) = Reading(dBuV) + C.F (Correction Factor).
4. The emission levels of other frequencies are very lower than the limit and not show in test report.

EUT	BE5000 Whole Home Mesh Wi-Fi 7 System	Date of Test	2024-03-23
Factor	DRH18-E	Temp. / Humidity	24°C /60%
Polarity	Horizontal	Site / Test Engineer	AC2 / Marvin
Test Mode	802.11n-20MHz_TX_CH 6_ANT 0+1	Test Voltage	AC 120V/60Hz

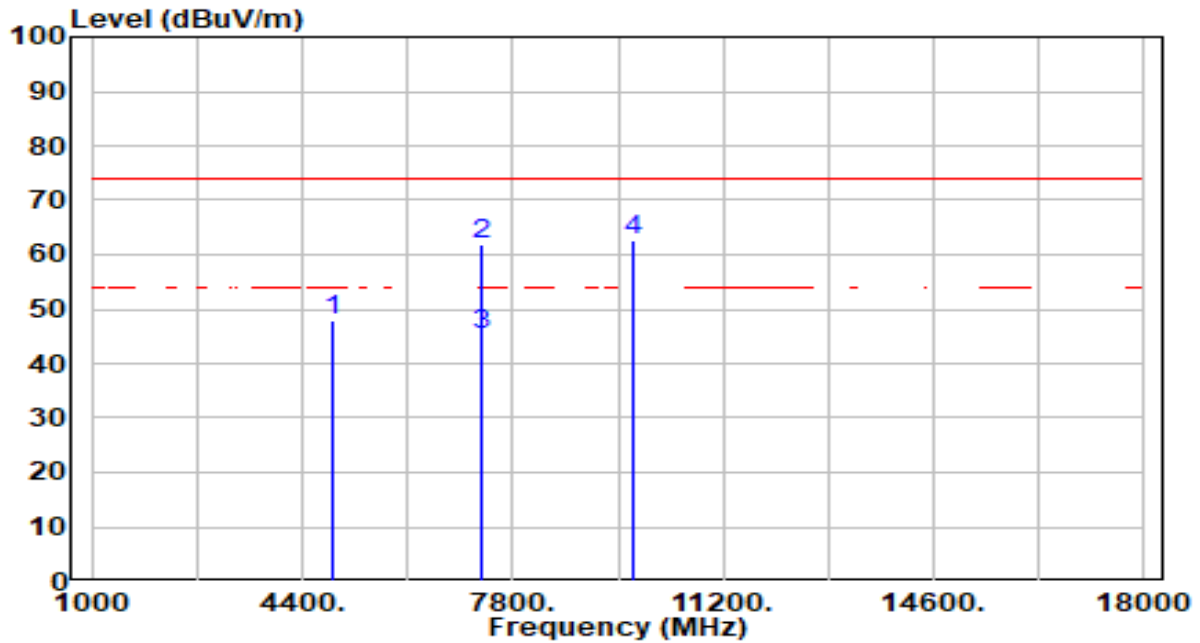

No	Frequency (MHz)	Reading (dBuV)	C.F (dB/m)	Measurement (dBuV/m)	Margin (dB)	Limit (dBuV/m)	Height (cm)	Angle (deg)	Remark (QP/PK/AV)
1	4874.000	47.38	0.36	47.74	-26.26	74.00	200	360	Peak
2	7311.000	56.40	5.59	61.99	-12.01	74.00	200	146	Peak
3	* 7311.000	39.55	5.59	45.14	-8.86	54.00	200	146	Average
4	* 9748.000	57.14	5.34	62.48	-11.52	74.00	200	144	Peak

Note:

- "\*" means this data is the worst emission level.
- C.F (Correction Factor) = Antenna Factor (dB/m)+ Cable Loss (dB) – Pre-amplifier(dB).
- Measurement (dBuV/m) = Reading(dBuV) + C.F (Correction Factor).
- The emission levels of other frequencies are very lower than the limit and not show in test report.

EUT	BE5000 Whole Home Mesh Wi-Fi 7 System	Date of Test	2024-03-23
Factor	DRH18-E	Temp. / Humidity	24°C /60%
Polarity	Vertical	Site / Test Engineer	AC2 / Marvin
Test Mode	802.11n-20MHz_TX_CH 6_ANT 0+1	Test Voltage	AC 120V/60Hz

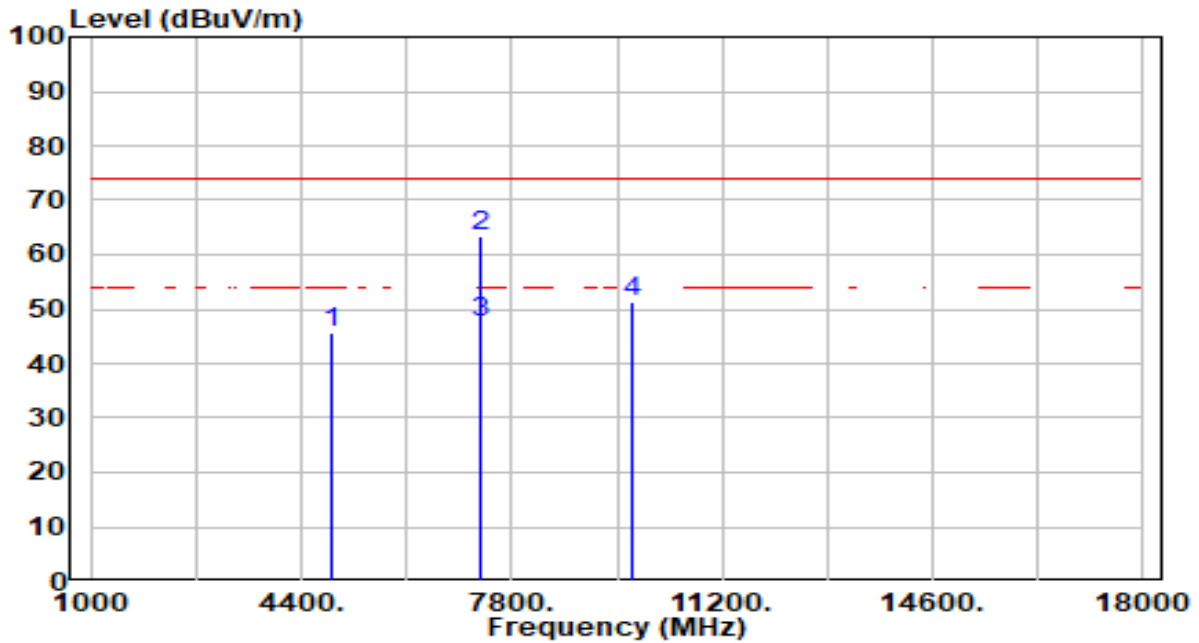

No	Frequency (MHz)	Reading (dBuV)	C.F (dB/m)	Measurement (dBuV/m)	Margin (dB)	Limit (dBuV/m)	Height (cm)	Angle (deg)	Remark (QP/PK/AV)
1	4874.000	45.18	0.36	45.55	-28.45	74.00	200	0	Peak
2	* 7311.000	57.94	5.59	63.53	-10.47	74.00	200	204	Peak
3	* 7311.000	41.97	5.59	47.56	-6.44	54.00	200	204	Average
4	9748.000	45.95	5.34	51.30	-22.70	74.00	200	161	Peak

Note:

- "\*" means this data is the worst emission level.
- C.F (Correction Factor) = Antenna Factor (dB/m)+ Cable Loss (dB) – Pre-amplifier(dB).
- Measurement (dBuV/m) = Reading(dBuV) + C.F (Correction Factor).
- The emission levels of other frequencies are very lower than the limit and not show in test report.

EUT	BE5000 Whole Home Mesh Wi-Fi 7 System	Date of Test	2024-03-23
Factor	DRH18-E	Temp. / Humidity	24°C /60%
Polarity	Horizontal	Site / Test Engineer	AC2 / Marvin
Test Mode	802.11n-20MHz_TX_CH 11_ANT 0+1	Test Voltage	AC 120V/60Hz

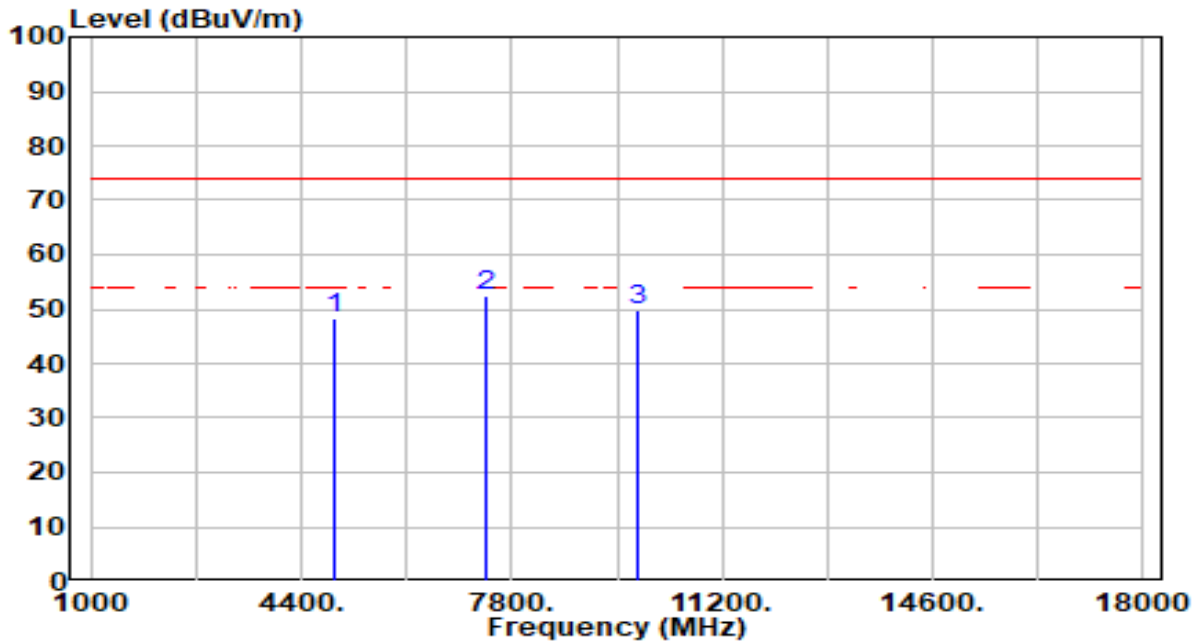

No	Frequency (MHz)	Reading (dBuV)	C.F (dB/m)	Measurement (dBuV/m)	Margin (dB)	Limit (dBuV/m)	Height (cm)	Angle (deg)	Remark (QP/PK/AV)
1	4924.000	47.88	0.49	48.37	-25.63	74.00	200	0	Peak
2	* 7386.000	46.87	5.64	52.51	-21.49	74.00	200	25	Peak
3	9848.000	44.51	5.39	49.89	-24.11	74.00	200	140	Peak

Note:

1. " \*", means this data is the worst emission level.
2. C.F (Correction Factor) = Antenna Factor (dB/m)+ Cable Loss (dB) – Preamplifier(dB).
3. Measurement (dBuV/m) = Reading(dBuV) + C.F (Correction Factor).
4. The emission levels of other frequencies are very lower than the limit and not show in test report.

EUT	BE5000 Whole Home Mesh Wi-Fi 7 System	Date of Test	2024-03-23
Factor	DRH18-E	Temp. / Humidity	24°C /60%
Polarity	Vertical	Site / Test Engineer	AC2 / Marvin
Test Mode	802.11n-20MHz_TX_CH 11_ANT 0+1	Test Voltage	AC 120V/60Hz

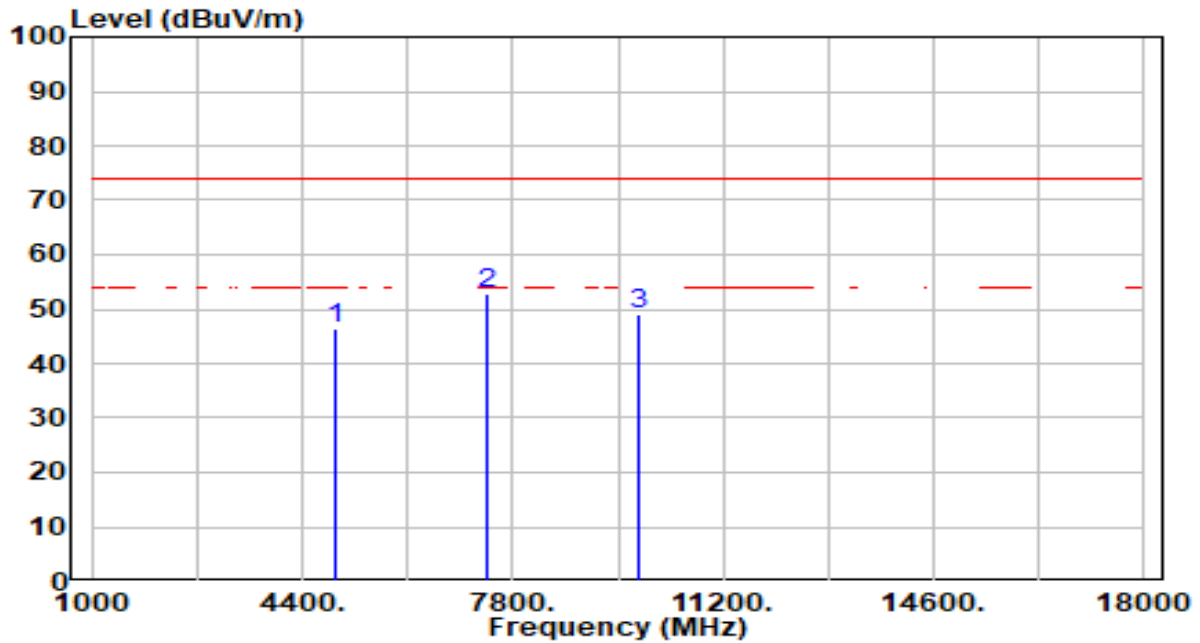

No	Frequency (MHz)	Reading (dBuV)	C.F (dB/m)	Measurement (dBuV/m)	Margin (dB)	Limit (dBuV/m)	Height (cm)	Angle (deg)	Remark (QP/PK/AV)
1	4924.000	46.04	0.49	46.54	-27.46	74.00	200	360	Peak
2	* 7386.000	47.03	5.64	52.67	-21.33	74.00	200	162	Peak
3	9848.000	43.49	5.39	48.88	-25.12	74.00	200	142	Peak

Note:

1. " \*", means this data is the worst emission level.
2. C.F (Correction Factor) = Antenna Factor (dB/m)+ Cable Loss (dB) – Preamplifier(dB).
3. Measurement (dBuV/m) = Reading(dBuV) + C.F (Correction Factor).
4. The emission levels of other frequencies are very lower than the limit and not show in test report.

EUT	BE5000 Whole Home Mesh Wi-Fi 7 System	Date of Test	2024-03-23
Factor	DRH18-E	Temp. / Humidity	24°C /60%
Polarity	Horizontal	Site / Test Engineer	AC2 / Marvin
Test Mode	802.11n-40MHz_TX_CH 3_ANT 0+1	Test Voltage	AC 120V/60Hz

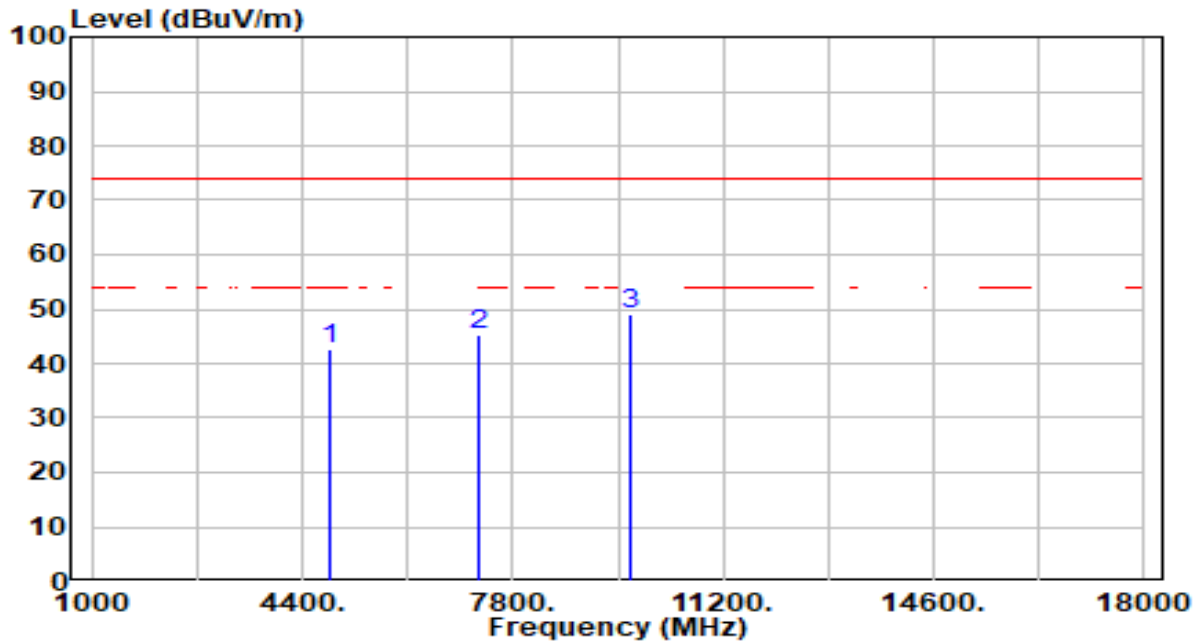

No	Frequency (MHz)	Reading (dBuV)	C.F (dB/m)	Measurement (dBuV/m)	Margin (dB)	Limit (dBuV/m)	Height (cm)	Angle (deg)	Remark (QP/PK/AV)
1	4844.000	42.51	0.28	42.80	-31.20	74.00	200	360	Peak
2	7266.000	39.73	5.56	45.29	-28.71	74.00	200	163	Peak
3	* 9688.000	43.62	5.32	48.94	-25.06	74.00	200	155	Peak

Note:

1. " \*", means this data is the worst emission level.
2. C.F (Correction Factor) = Antenna Factor (dB/m)+ Cable Loss (dB) – Pre-amplifier(dB).
3. Measurement (dBuV/m) = Reading(dBuV) + C.F (Correction Factor).
4. The emission levels of other frequencies are very lower than the limit and not show in test report.

EUT	BE5000 Whole Home Mesh Wi-Fi 7 System	Date of Test	2024-03-23
Factor	DRH18-E	Temp. / Humidity	24°C /60%
Polarity	Vertical	Site / Test Engineer	AC2 / Marvin
Test Mode	802.11n-40MHz_TX_CH 3_ANT 0+1	Test Voltage	AC 120V/60Hz

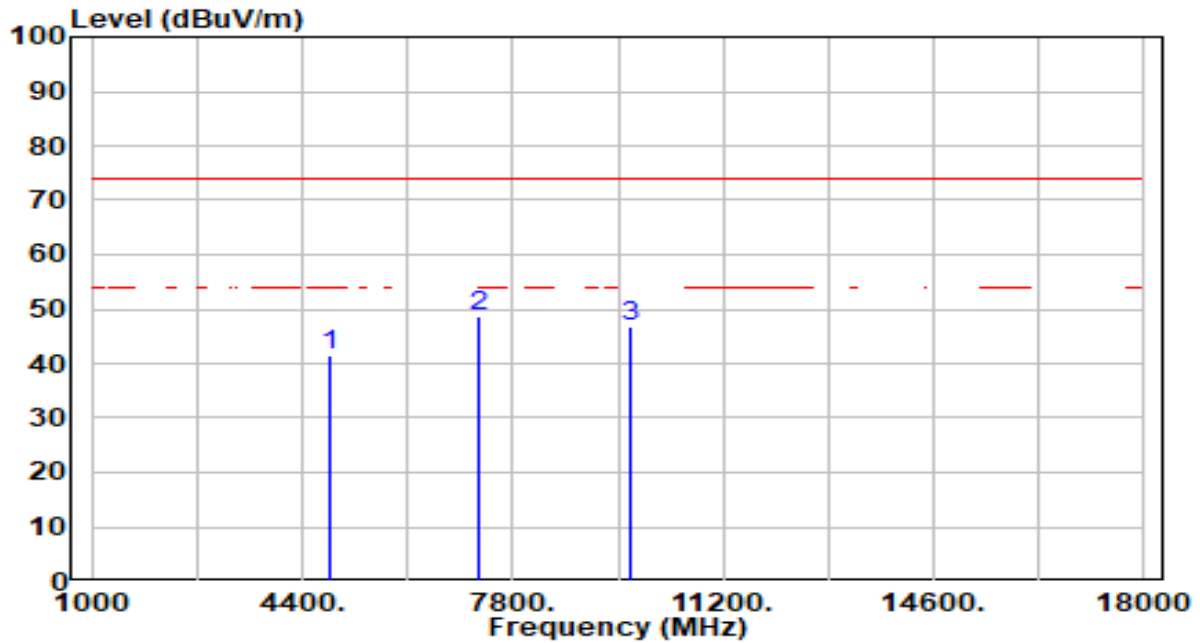

No	Frequency (MHz)	Reading (dBuV)	C.F (dB/m)	Measurement (dBuV/m)	Margin (dB)	Limit (dBuV/m)	Height (cm)	Angle (deg)	Remark (QP/PK/AV)
1	4844.000	41.32	0.28	41.60	-32.40	74.00	200	0	Peak
2	* 7266.000	43.04	5.56	48.60	-25.40	74.00	200	194	Peak
3	9688.000	41.42	5.32	46.73	-27.27	74.00	200	251	Peak

Note:

1. " \*", means this data is the worst emission level.
2. C.F (Correction Factor) = Antenna Factor (dB/m)+ Cable Loss (dB) – Pre-amplifier(dB).
3. Measurement (dBuV/m) = Reading(dBuV) + C.F (Correction Factor).
4. The emission levels of other frequencies are very lower than the limit and not show in test report.

EUT	BE5000 Whole Home Mesh Wi-Fi 7 System	Date of Test	2024-03-23
Factor	DRH18-E	Temp. / Humidity	24°C /60%
Polarity	Horizontal	Site / Test Engineer	AC2 / Marvin
Test Mode	802.11n-40MHz_TX_CH 6_ANT 0+1	Test Voltage	AC 120V/60Hz

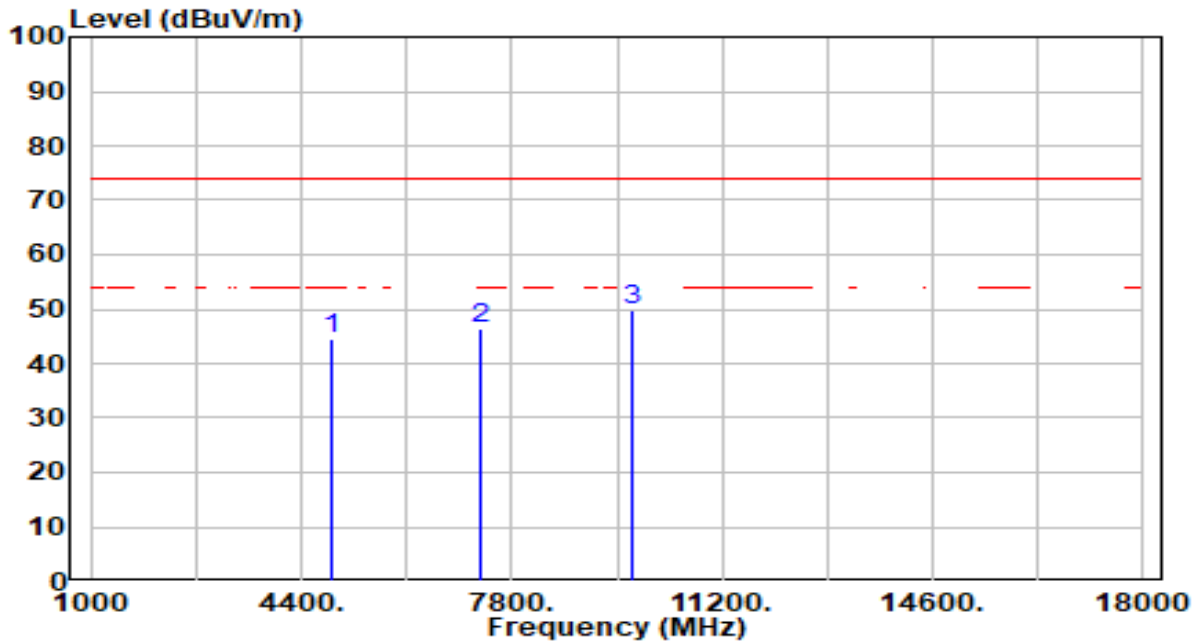

No	Frequency (MHz)	Reading (dBuV)	C.F (dB/m)	Measurement (dBuV/m)	Margin (dB)	Limit (dBuV/m)	Height (cm)	Angle (deg)	Remark (QP/PK/AV)
1	4874.000	44.24	0.36	44.60	-29.40	74.00	200	5	Peak
2	7311.000	40.65	5.59	46.24	-27.76	74.00	200	150	Peak
3	* 9748.000	44.43	5.34	49.78	-24.22	74.00	200	144	Peak

Note:

1. " \*", means this data is the worst emission level.
2. C.F (Correction Factor) = Antenna Factor (dB/m)+ Cable Loss (dB) – Preamplifier(dB).
3. Measurement (dBuV/m) = Reading(dBuV) + C.F (Correction Factor).
4. The emission levels of other frequencies are very lower than the limit and not show in test report.



EUT	BE5000 Whole Home Mesh Wi-Fi 7 System	Date of Test	2024-03-23
Factor	DRH18-E	Temp. / Humidity	24°C /60%
Polarity	Vertical	Site / Test Engineer	AC2 / Marvin
Test Mode	802.11n-40MHz_TX_CH 6_ANT 0+1	Test Voltage	AC 120V/60Hz

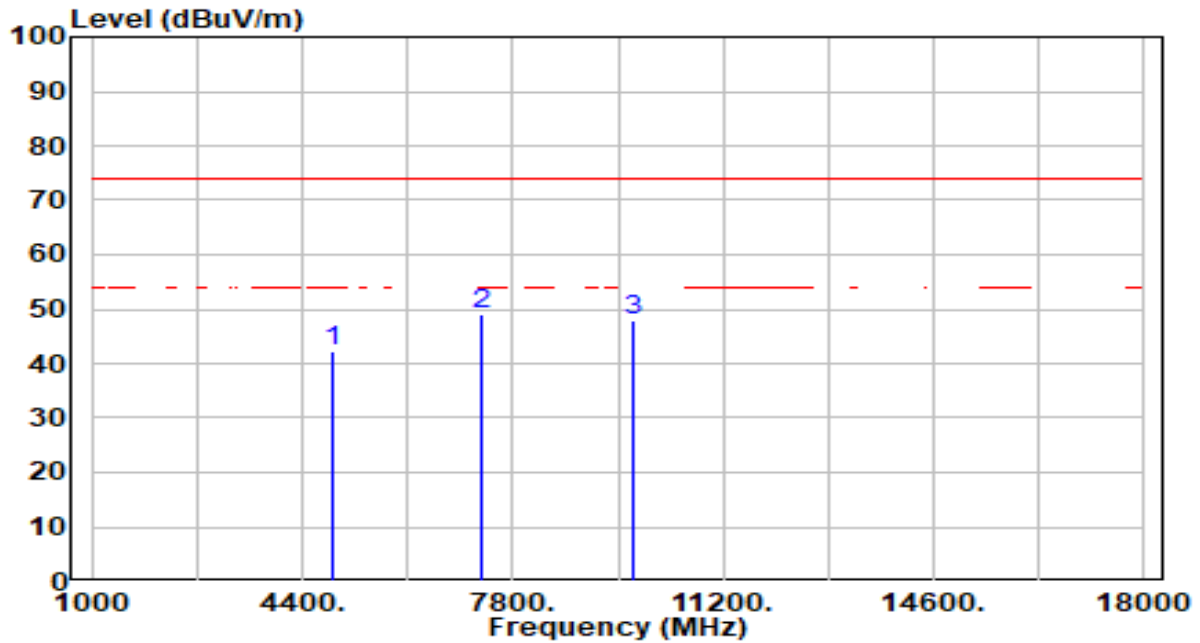

No	Frequency (MHz)	Reading (dBuV)	C.F (dB/m)	Measurement (dBuV/m)	Margin (dB)	Limit (dBuV/m)	Height (cm)	Angle (deg)	Remark (QP/PK/AV)
1	4874.000	41.81	0.36	42.17	-31.83	74.00	200	360	Peak
2	* 7311.000	43.52	5.59	49.11	-24.89	74.00	200	86	Peak
3	9748.000	42.66	5.34	48.00	-26.00	74.00	200	172	Peak

Note:

1. " \*", means this data is the worst emission level.
2. C.F (Correction Factor) = Antenna Factor (dB/m)+ Cable Loss (dB) – Preamplifier(dB).
3. Measurement (dBuV/m) = Reading(dBuV) + C.F (Correction Factor).
4. The emission levels of other frequencies are very lower than the limit and not show in test report.

EUT	BE5000 Whole Home Mesh Wi-Fi 7 System	Date of Test	2024-03-23
Factor	DRH18-E	Temp. / Humidity	24°C /60%
Polarity	Horizontal	Site / Test Engineer	AC2 / Marvin
Test Mode	802.11n-40MHz_TX_CH 9_ANT 0+1	Test Voltage	AC 120V/60Hz

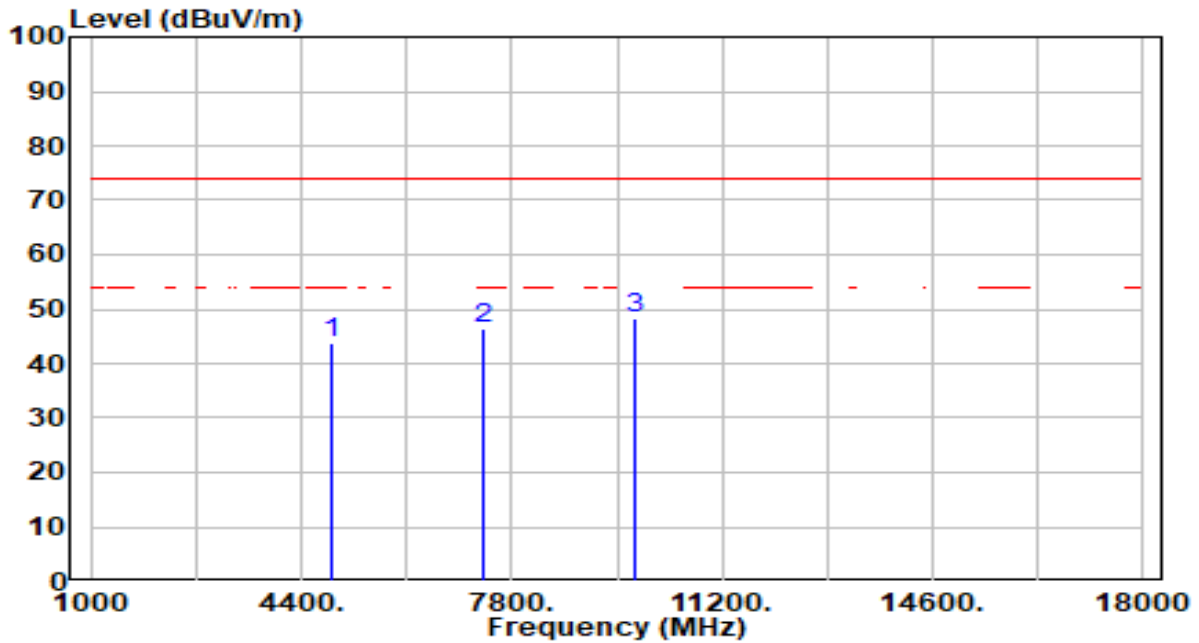

No	Frequency (MHz)	Reading (dBuV)	C.F (dB/m)	Measurement (dBuV/m)	Margin (dB)	Limit (dBuV/m)	Height (cm)	Angle (deg)	Remark (QP/PK/AV)
1	4904.000	43.18	0.44	43.62	-30.38	74.00	200	0	Peak
2	7356.000	40.66	5.62	46.28	-27.72	74.00	200	164	Peak
3	* 9808.000	42.84	5.37	48.21	-25.79	74.00	200	147	Peak

Note:

1. " \*", means this data is the worst emission level.
2. C.F (Correction Factor) = Antenna Factor (dB/m)+ Cable Loss (dB) – Preamplifier(dB).
3. Measurement (dBuV/m) = Reading(dBuV) + C.F (Correction Factor).
4. The emission levels of other frequencies are very lower than the limit and not show in test report.

EUT	BE5000 Whole Home Mesh Wi-Fi 7 System	Date of Test	2024-03-23
Factor	DRH18-E	Temp. / Humidity	24°C /60%
Polarity	Vertical	Site / Test Engineer	AC2 / Marvin
Test Mode	802.11n-40MHz_TX_CH 9_ANT 0+1	Test Voltage	AC 120V/60Hz

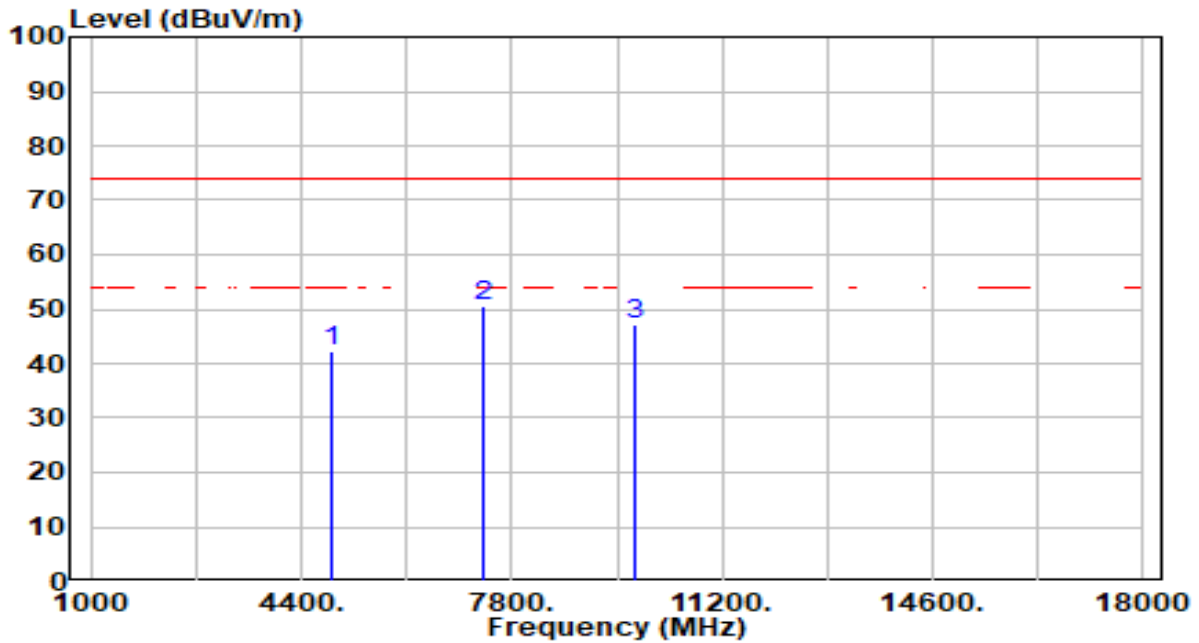

No	Frequency (MHz)	Reading (dBuV)	C.F (dB/m)	Measurement (dBuV/m)	Margin (dB)	Limit (dBuV/m)	Height (cm)	Angle (deg)	Remark (QP/PK/AV)
1	4904.000	41.66	0.44	42.10	-31.90	74.00	200	360	Peak
2	* 7356.000	45.11	5.62	50.73	-23.27	74.00	200	86	Peak
3	9808.000	41.77	5.37	47.14	-26.86	74.00	200	198	Peak

Note:

1. " \*", means this data is the worst emission level.
2. C.F (Correction Factor) = Antenna Factor (dB/m)+ Cable Loss (dB) – Preamplifier(dB).
3. Measurement (dBuV/m) = Reading(dBuV) + C.F (Correction Factor).
4. The emission levels of other frequencies are very lower than the limit and not show in test report.

EUT	BE5000 Whole Home Mesh Wi-Fi 7 System	Date of Test	2024-03-23
Factor	DRH18-E	Temp. / Humidity	24°C /60%
Polarity	Horizontal	Site / Test Engineer	AC2 / Marvin
Test Mode	802.11ax-20MHz_TX_CH 1_ANT 0+1	Test Voltage	AC 120V/60Hz

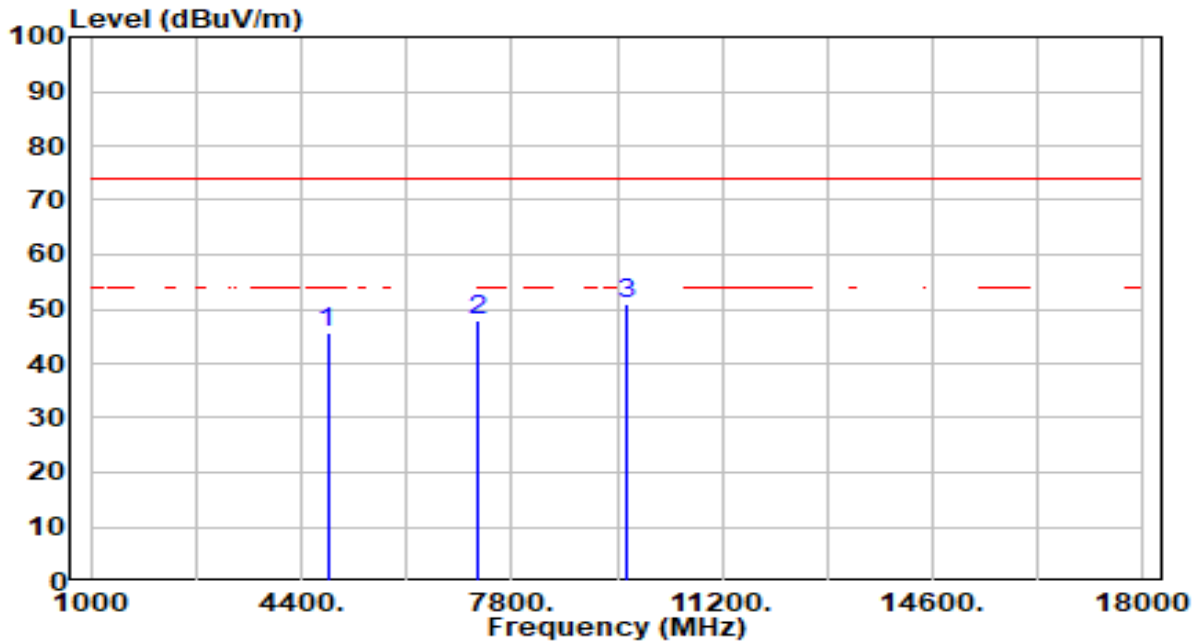

No	Frequency (MHz)	Reading (dBuV)	C.F (dB/m)	Measurement (dBuV/m)	Margin (dB)	Limit (dBuV/m)	Height (cm)	Angle (deg)	Remark (QP/PK/AV)
1	4824.000	45.28	0.23	45.51	-28.49	74.00	200	0	Peak
2	7236.000	42.27	5.54	47.82	-26.18	74.00	200	109	Peak
3	* 9648.000	45.60	5.30	50.90	-23.10	74.00	200	140	Peak

Note:

1. " \*", means this data is the worst emission level.
2. C.F (Correction Factor) = Antenna Factor (dB/m)+ Cable Loss (dB) – Preamplifier(dB).
3. Measurement (dBuV/m) = Reading(dBuV) + C.F (Correction Factor).
4. The emission levels of other frequencies are very lower than the limit and not show in test report.

EUT	BE5000 Whole Home Mesh Wi-Fi 7 System	Date of Test	2024-03-23
Factor	DRH18-E	Temp. / Humidity	24°C /60%
Polarity	Vertical	Site / Test Engineer	AC2 / Marvin
Test Mode	802.11ax-20MHz_TX_CH 1_ANT 0+1	Test Voltage	AC 120V/60Hz

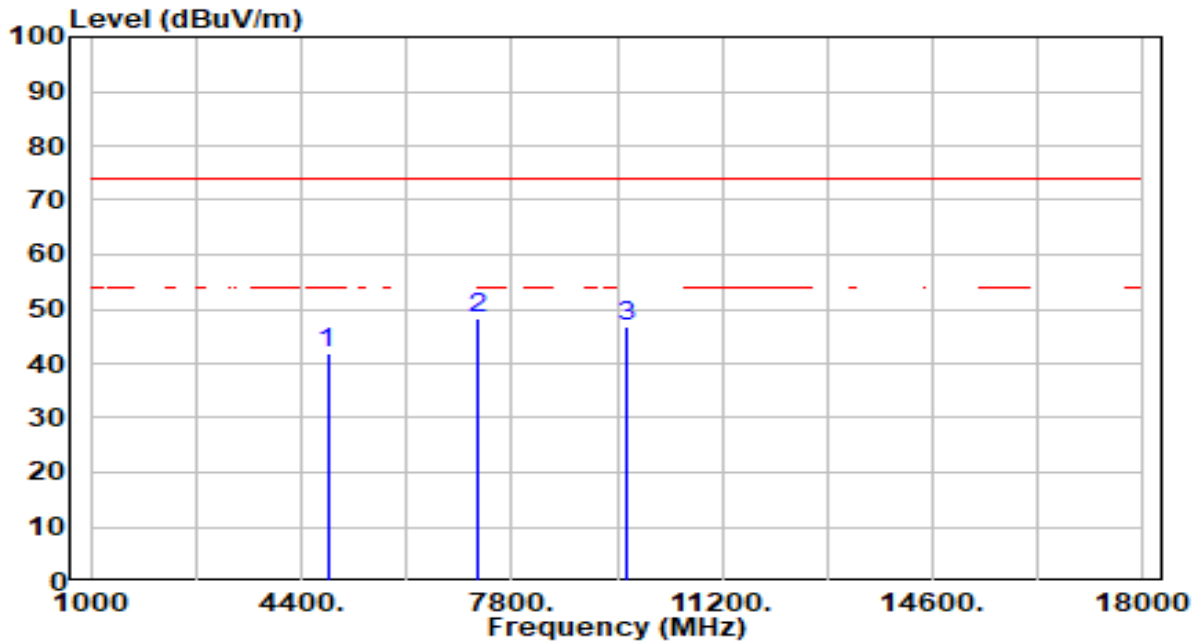

No	Frequency (MHz)	Reading (dBuV)	C.F (dB/m)	Measurement (dBuV/m)	Margin (dB)	Limit (dBuV/m)	Height (cm)	Angle (deg)	Remark (QP/PK/AV)
1	4824.000	41.49	0.23	41.72	-32.28	74.00	200	0	Peak
2	* 7236.000	42.93	5.54	48.47	-25.53	74.00	200	179	Peak
3	9648.000	41.44	5.30	46.74	-27.26	74.00	200	274	Peak

Note:

1. " \*", means this data is the worst emission level.
2. C.F (Correction Factor) = Antenna Factor (dB/m)+ Cable Loss (dB) – Pre-amplifier(dB).
3. Measurement (dBuV/m) = Reading(dBuV) + C.F (Correction Factor).
4. The emission levels of other frequencies are very lower than the limit and not show in test report.

EUT	BE5000 Whole Home Mesh Wi-Fi 7 System	Date of Test	2024-03-23
Factor	DRH18-E	Temp. / Humidity	24°C /60%
Polarity	Horizontal	Site / Test Engineer	AC2 / Marvin
Test Mode	802.11ax-20MHz_TX_CH 6_ANT 0+1	Test Voltage	AC 120V/60Hz

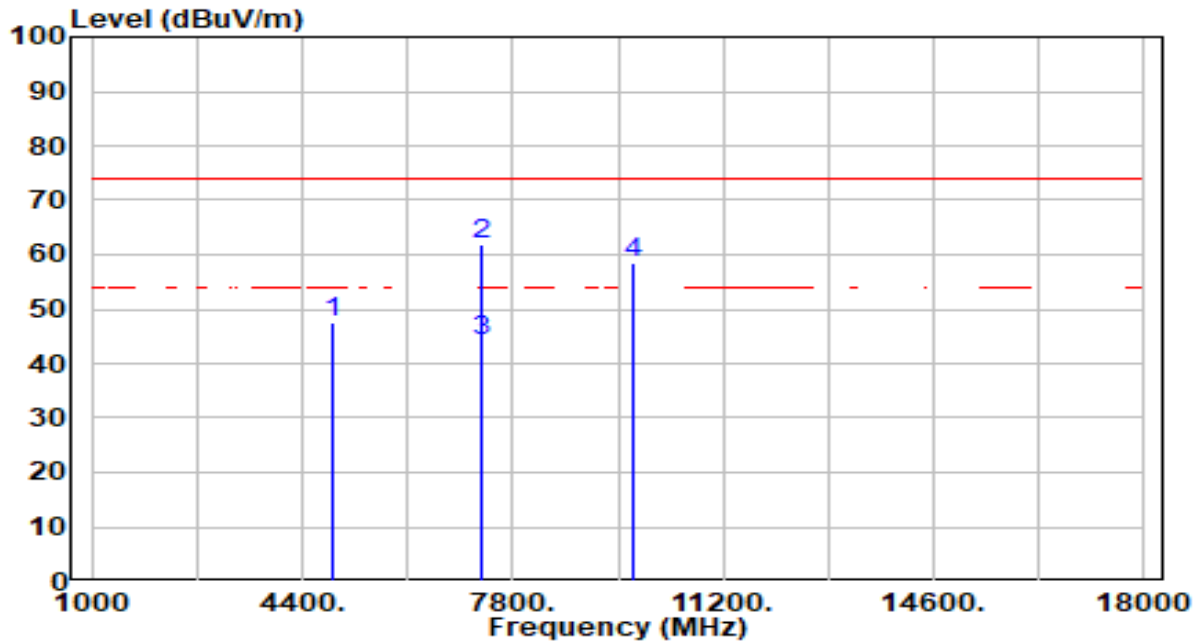

No	Frequency (MHz)	Reading (dBuV)	C.F (dB/m)	Measurement (dBuV/m)	Margin (dB)	Limit (dBuV/m)	Height (cm)	Angle (deg)	Remark (QP/PK/AV)
1	4874.000	47.10	0.36	47.46	-26.54	74.00	200	0	Peak
2	* 7311.000	56.34	5.59	61.93	-12.07	74.00	200	150	Peak
3	* 7311.000	38.58	5.59	44.17	-9.83	54.00	200	150	Average
4	9748.000	53.05	5.34	58.40	-15.60	74.00	200	135	Peak

Note:

- "\*" means this data is the worst emission level.
- C.F (Correction Factor) = Antenna Factor (dB/m)+ Cable Loss (dB) – Pre-amplifier(dB).
- Measurement (dBuV/m) = Reading(dBuV) + C.F (Correction Factor).
- The emission levels of other frequencies are very lower than the limit and not show in test report.

EUT	BE5000 Whole Home Mesh Wi-Fi 7 System	Date of Test	2024-03-23
Factor	DRH18-E	Temp. / Humidity	24°C /60%
Polarity	Vertical	Site / Test Engineer	AC2 / Marvin
Test Mode	802.11ax-20MHz_TX_CH 6_ANT 0+1	Test Voltage	AC 120V/60Hz

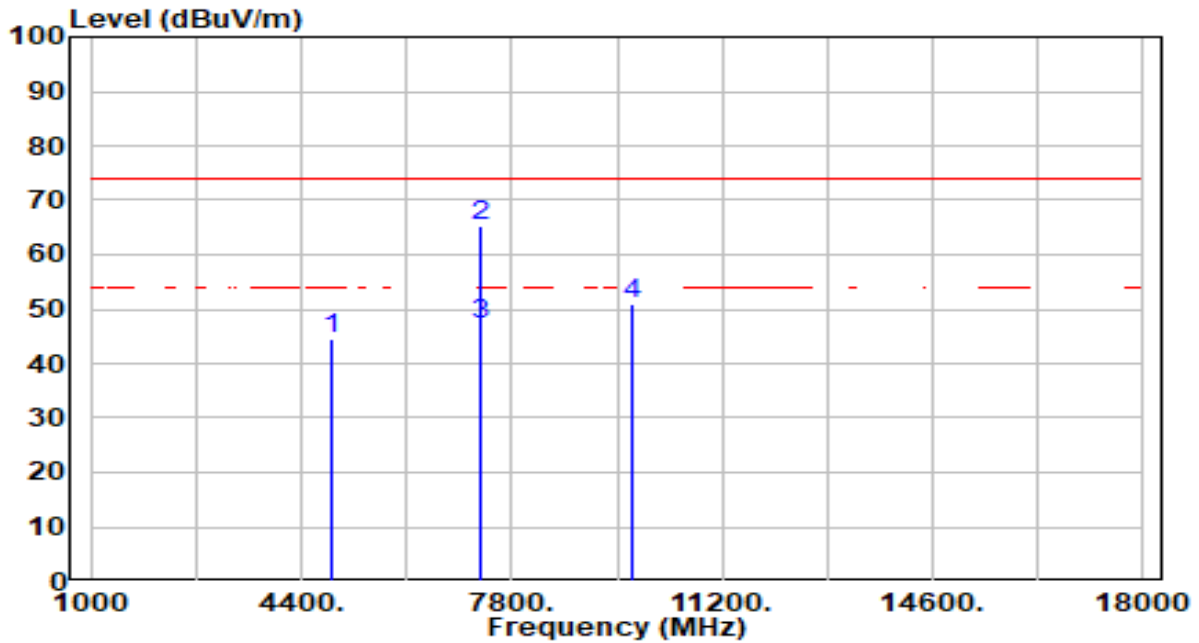

No	Frequency (MHz)	Reading (dBuV)	C.F (dB/m)	Measurement (dBuV/m)	Margin (dB)	Limit (dBuV/m)	Height (cm)	Angle (deg)	Remark (QP/PK/AV)
1	4874.000	44.10	0.36	44.47	-29.53	74.00	200	0	Peak
2	* 7311.000	59.68	5.59	65.27	-8.73	74.00	200	193	Peak
3	* 7311.000	41.56	5.59	47.15	-6.85	54.00	200	193	Average
4	9748.000	45.51	5.34	50.86	-23.14	74.00	200	158	Peak

Note:

- "\*" means this data is the worst emission level.
- C.F (Correction Factor) = Antenna Factor (dB/m)+ Cable Loss (dB) – Preamplifier(dB).
- Measurement (dBuV/m) = Reading(dBuV) + C.F (Correction Factor).
- The emission levels of other frequencies are very lower than the limit and not show in test report.

EUT	BE5000 Whole Home Mesh Wi-Fi 7 System	Date of Test	2024-03-23
Factor	DRH18-E	Temp. / Humidity	24°C /60%
Polarity	Horizontal	Site / Test Engineer	AC2 / Marvin
Test Mode	802.11ax-20MHz_TX_CH 11_ANT 0+1	Test Voltage	AC 120V/60Hz

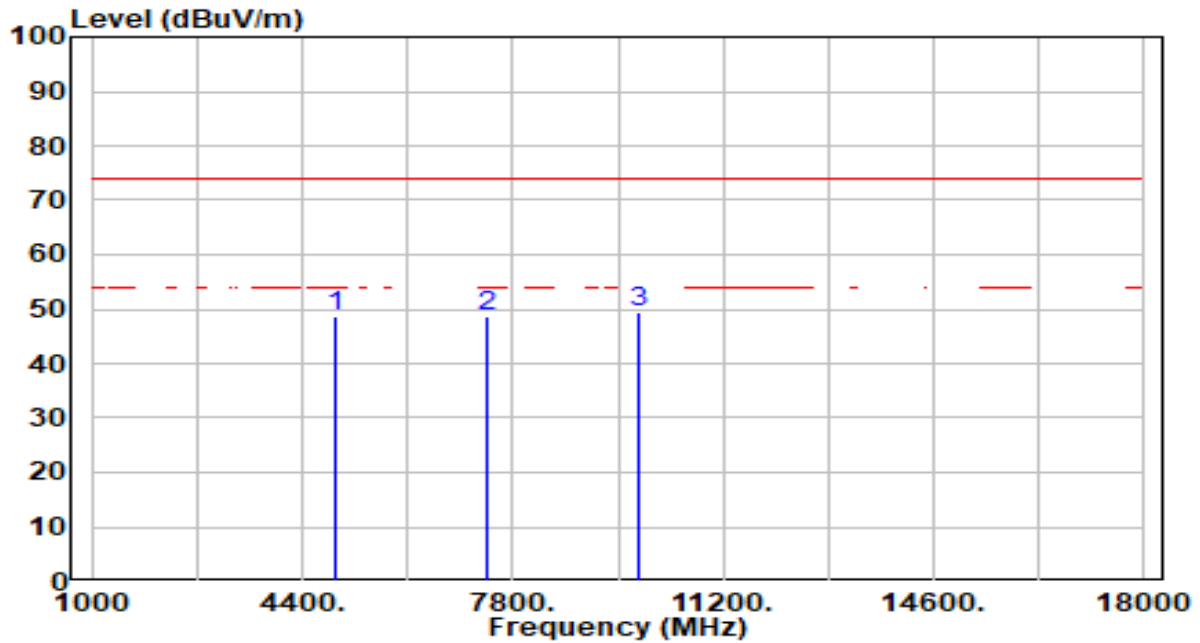

No	Frequency (MHz)	Reading (dBuV)	C.F (dB/m)	Measurement (dBuV/m)	Margin (dB)	Limit (dBuV/m)	Height (cm)	Angle (deg)	Remark (QP/PK/AV)
1	4924.000	48.01	0.49	48.51	-25.49	74.00	200	349	Peak
2	7386.000	42.87	5.64	48.50	-25.50	74.00	200	176	Peak
3	* 9848.000	44.12	5.39	49.51	-24.49	74.00	200	142	Peak

Note:

1. " \*", means this data is the worst emission level.
2. C.F (Correction Factor) = Antenna Factor (dB/m)+ Cable Loss (dB) – Preamplifier(dB).
3. Measurement (dBuV/m) = Reading(dBuV) + C.F (Correction Factor).
4. The emission levels of other frequencies are very lower than the limit and not show in test report.



EUT	BE5000 Whole Home Mesh Wi-Fi 7 System	Date of Test	2024-03-23
Factor	DRH18-E	Temp. / Humidity	24°C /60%
Polarity	Vertical	Site / Test Engineer	AC2 / Marvin
Test Mode	802.11ax-20MHz_TX_CH 11_ANT 0+1	Test Voltage	AC 120V/60Hz

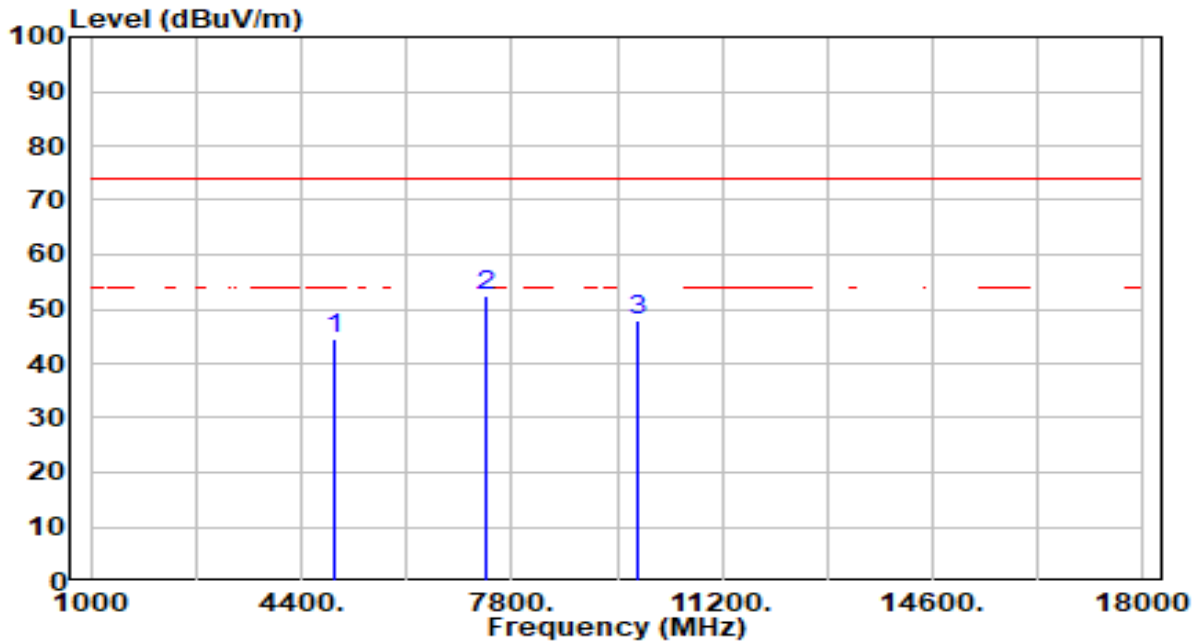

No	Frequency (MHz)	Reading (dBuV)	C.F (dB/m)	Measurement (dBuV/m)	Margin (dB)	Limit (dBuV/m)	Height (cm)	Angle (deg)	Remark (QP/PK/AV)
1	4924.000	44.14	0.49	44.64	-29.36	74.00	200	0	Peak
2	* 7386.000	46.95	5.64	52.59	-21.41	74.00	200	91	Peak
3	9848.000	42.67	5.39	48.05	-25.95	74.00	200	134	Peak

Note:

1. " \*", means this data is the worst emission level.
2. C.F (Correction Factor) = Antenna Factor (dB/m)+ Cable Loss (dB) – Preamplifier(dB).
3. Measurement (dBuV/m) = Reading(dBuV) + C.F (Correction Factor).
4. The emission levels of other frequencies are very lower than the limit and not show in test report.

EUT	BE5000 Whole Home Mesh Wi-Fi 7 System	Date of Test	2024-03-23
Factor	DRH18-E	Temp. / Humidity	24°C /60%
Polarity	Horizontal	Site / Test Engineer	AC2 / Marvin
Test Mode	802.11ax-40MHz_TX_CH 3_ANT 0+1	Test Voltage	AC 120V/60Hz

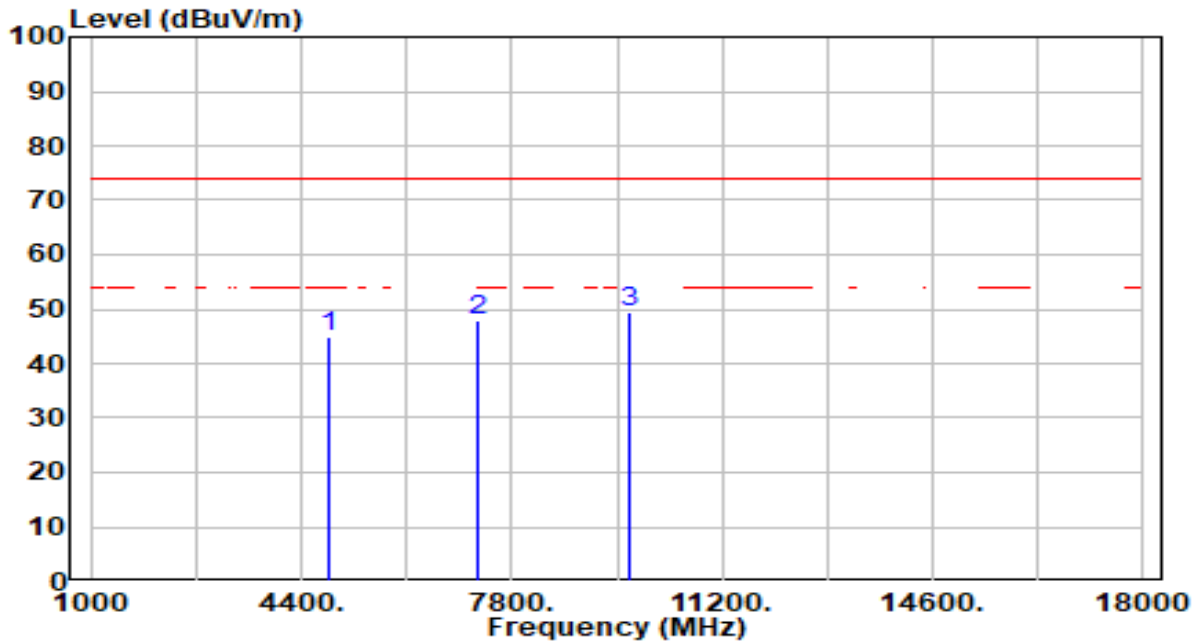

No	Frequency (MHz)	Reading (dBuV)	C.F (dB/m)	Measurement (dBuV/m)	Margin (dB)	Limit (dBuV/m)	Height (cm)	Angle (deg)	Remark (QP/PK/AV)
1	4844.000	44.56	0.28	44.85	-29.15	74.00	200	1	Peak
2	7266.000	42.26	5.56	47.82	-26.18	74.00	200	113	Peak
3	* 9688.000	44.17	5.32	49.49	-24.51	74.00	200	147	Peak

Note:

1. " \*", means this data is the worst emission level.
2. C.F (Correction Factor) = Antenna Factor (dB/m)+ Cable Loss (dB) – Preamplifier(dB).
3. Measurement (dBuV/m) = Reading(dBuV) + C.F (Correction Factor).
4. The emission levels of other frequencies are very lower than the limit and not show in test report.

EUT	BE5000 Whole Home Mesh Wi-Fi 7 System	Date of Test	2024-03-23
Factor	DRH18-E	Temp. / Humidity	24°C /60%
Polarity	Vertical	Site / Test Engineer	AC2 / Marvin
Test Mode	802.11ax-40MHz_TX_CH 3_ANT 0+1	Test Voltage	AC 120V/60Hz

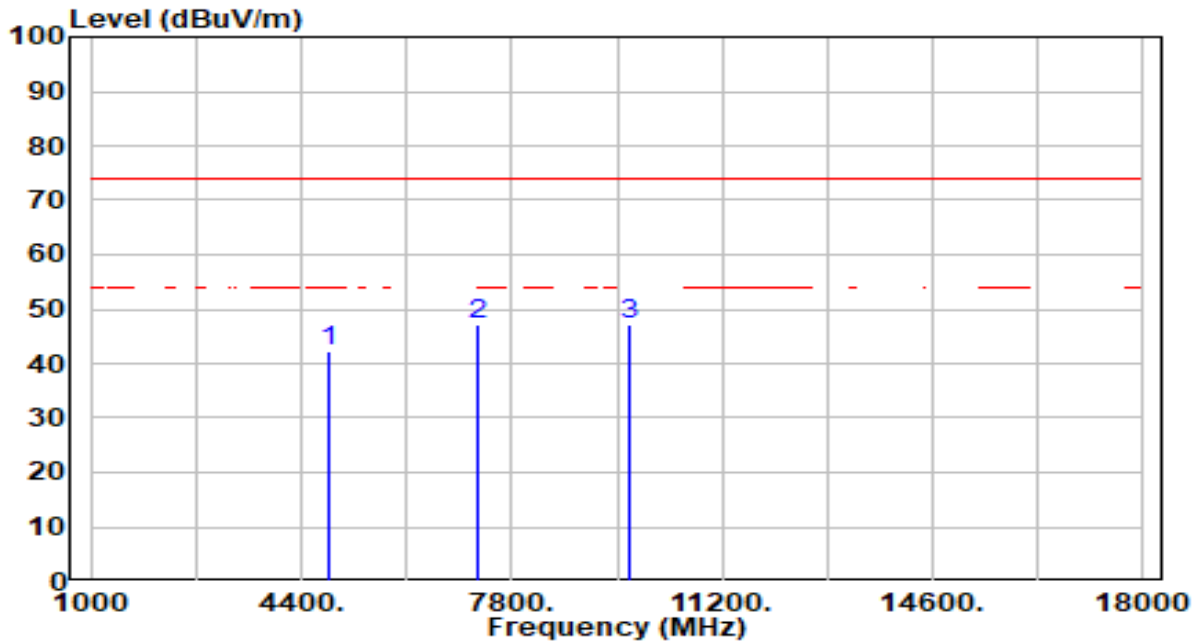

No	Frequency (MHz)	Reading (dBuV)	C.F (dB/m)	Measurement (dBuV/m)	Margin (dB)	Limit (dBuV/m)	Height (cm)	Angle (deg)	Remark (QP/PK/AV)
1	4844.000	41.83	0.28	42.11	-31.89	74.00	200	5	Peak
2	* 7266.000	41.77	5.56	47.33	-26.67	74.00	200	198	Peak
3	9688.000	41.73	5.32	47.05	-26.95	74.00	200	360	Peak

Note:

1. " \*", means this data is the worst emission level.
2. C.F (Correction Factor) = Antenna Factor (dB/m)+ Cable Loss (dB) – Pre-amplifier(dB).
3. Measurement (dBuV/m) = Reading(dBuV) + C.F (Correction Factor).
4. The emission levels of other frequencies are very lower than the limit and not show in test report.

EUT	BE5000 Whole Home Mesh Wi-Fi 7 System	Date of Test	2024-03-23
Factor	DRH18-E	Temp. / Humidity	24°C /60%
Polarity	Horizontal	Site / Test Engineer	AC2 / Marvin
Test Mode	802.11ax-40MHz_TX_CH 6_ANT 0+1	Test Voltage	AC 120V/60Hz

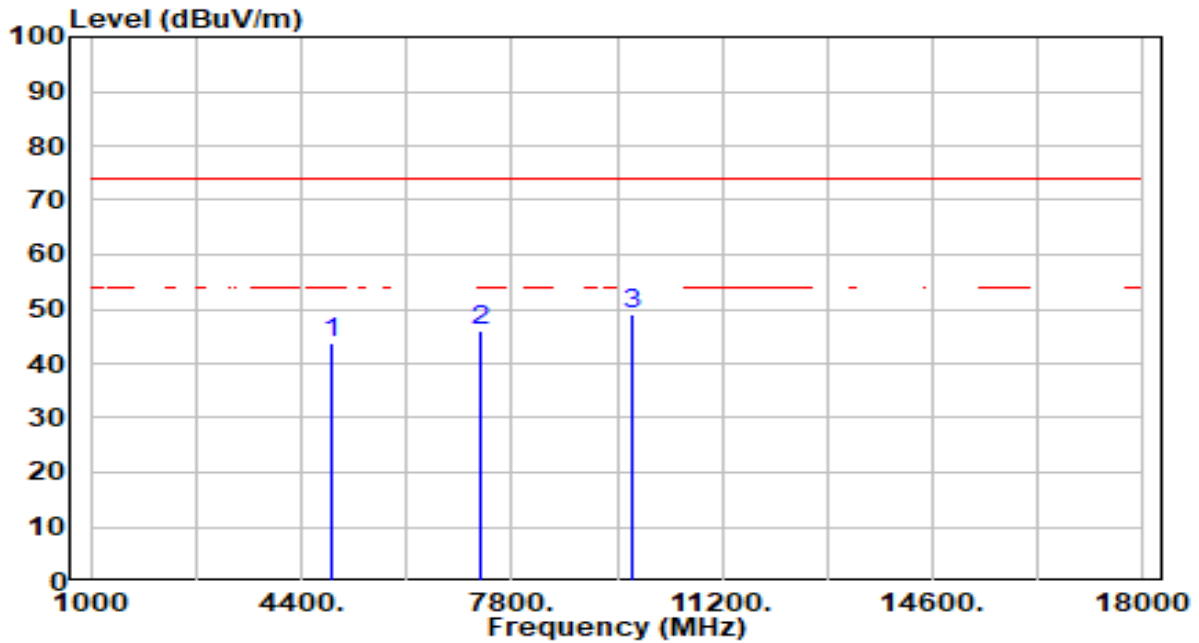

No	Frequency (MHz)	Reading (dBuV)	C.F (dB/m)	Measurement (dBuV/m)	Margin (dB)	Limit (dBuV/m)	Height (cm)	Angle (deg)	Remark (QP/PK/AV)
1	4874.000	43.47	0.36	43.83	-30.17	74.00	200	0	Peak
2	7311.000	40.59	5.59	46.18	-27.82	74.00	200	134	Peak
3	* 9748.000	43.53	5.34	48.87	-25.13	74.00	200	155	Peak

Note:

1. " \*", means this data is the worst emission level.
2. C.F (Correction Factor) = Antenna Factor (dB/m)+ Cable Loss (dB) – Preamplifier(dB).
3. Measurement (dBuV/m) = Reading(dBuV) + C.F (Correction Factor).
4. The emission levels of other frequencies are very lower than the limit and not show in test report.

EUT	BE5000 Whole Home Mesh Wi-Fi 7 System	Date of Test	2024-03-23
Factor	DRH18-E	Temp. / Humidity	24°C /60%
Polarity	Vertical	Site / Test Engineer	AC2 / Marvin
Test Mode	802.11ax-40MHz_TX_CH 6_ANT 0+1	Test Voltage	AC 120V/60Hz

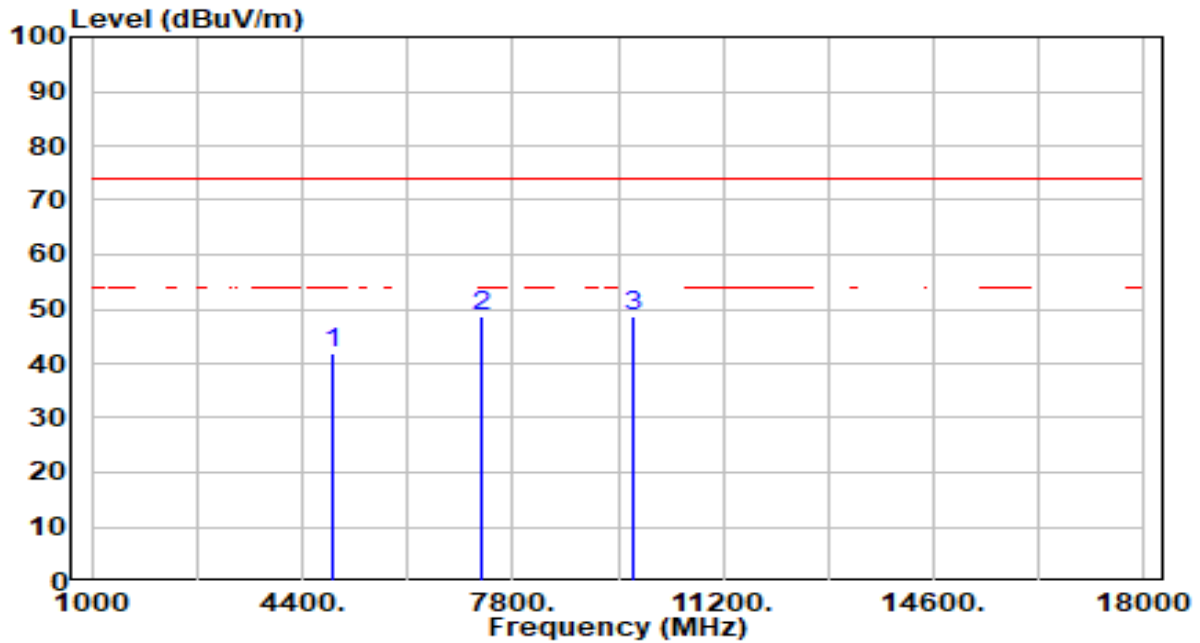

No	Frequency (MHz)	Reading (dBuV)	C.F (dB/m)	Measurement (dBuV/m)	Margin (dB)	Limit (dBuV/m)	Height (cm)	Angle (deg)	Remark (QP/PK/AV)
1	4874.000	41.54	0.36	41.90	-32.10	74.00	200	346	Peak
2	* 7311.000	43.26	5.59	48.85	-25.15	74.00	200	88	Peak
3	9748.000	43.32	5.34	48.67	-25.33	74.00	200	162	Peak

Note:

1. " \*", means this data is the worst emission level.
2. C.F (Correction Factor) = Antenna Factor (dB/m)+ Cable Loss (dB) – Preamplifier(dB).
3. Measurement (dBuV/m) = Reading(dBuV) + C.F (Correction Factor).
4. The emission levels of other frequencies are very lower than the limit and not show in test report.

EUT	BE5000 Whole Home Mesh Wi-Fi 7 System	Date of Test	2024-03-23
Factor	DRH18-E	Temp. / Humidity	24°C /60%
Polarity	Horizontal	Site / Test Engineer	AC2 / Marvin
Test Mode	802.11ax-40MHz_TX_CH 9_ANT 0+1	Test Voltage	AC 120V/60Hz

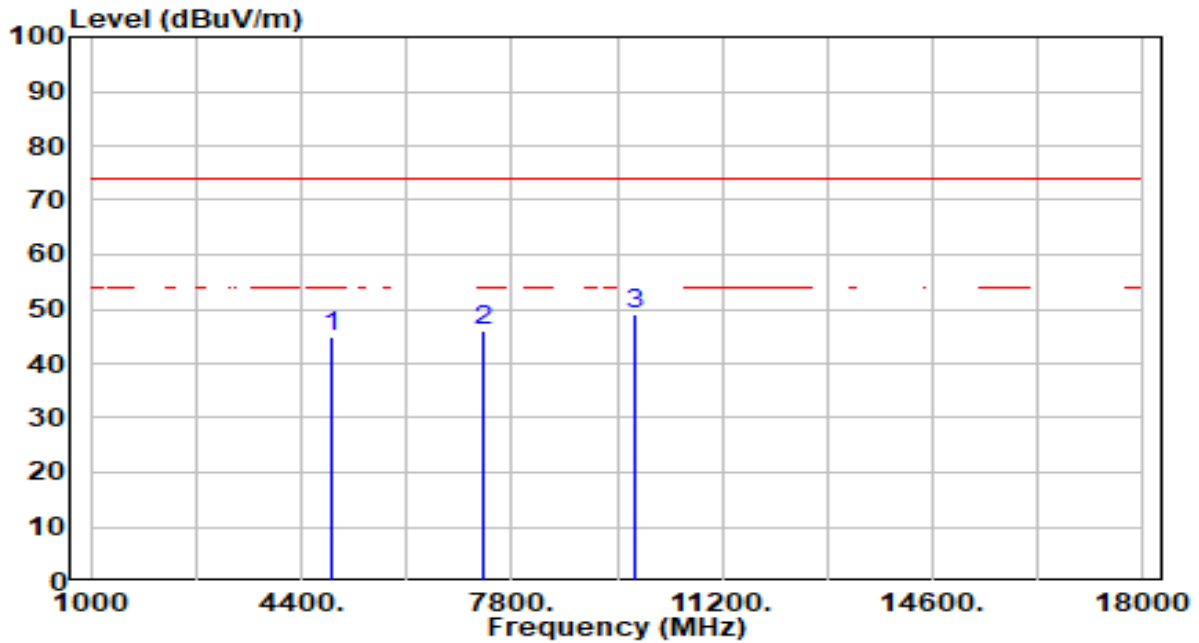

No	Frequency (MHz)	Reading (dBuV)	C.F (dB/m)	Measurement (dBuV/m)	Margin (dB)	Limit (dBuV/m)	Height (cm)	Angle (deg)	Remark (QP/PK/AV)
1	4904.000	44.58	0.44	45.02	-28.98	74.00	200	3	Peak
2	7356.000	40.32	5.62	45.94	-28.06	74.00	200	141	Peak
3	* 9808.000	43.81	5.37	49.18	-24.82	74.00	200	156	Peak

Note:

1. " \*", means this data is the worst emission level.
2. C.F (Correction Factor) = Antenna Factor (dB/m)+ Cable Loss (dB) – Preamplifier(dB).
3. Measurement (dBuV/m) = Reading(dBuV) + C.F (Correction Factor).
4. The emission levels of other frequencies are very lower than the limit and not show in test report.

EUT	BE5000 Whole Home Mesh Wi-Fi 7 System	Date of Test	2024-03-23
Factor	DRH18-E	Temp. / Humidity	24°C /60%
Polarity	Vertical	Site / Test Engineer	AC2 / Marvin
Test Mode	802.11ax-40MHz_TX_CH 9_ANT 0+1	Test Voltage	AC 120V/60Hz

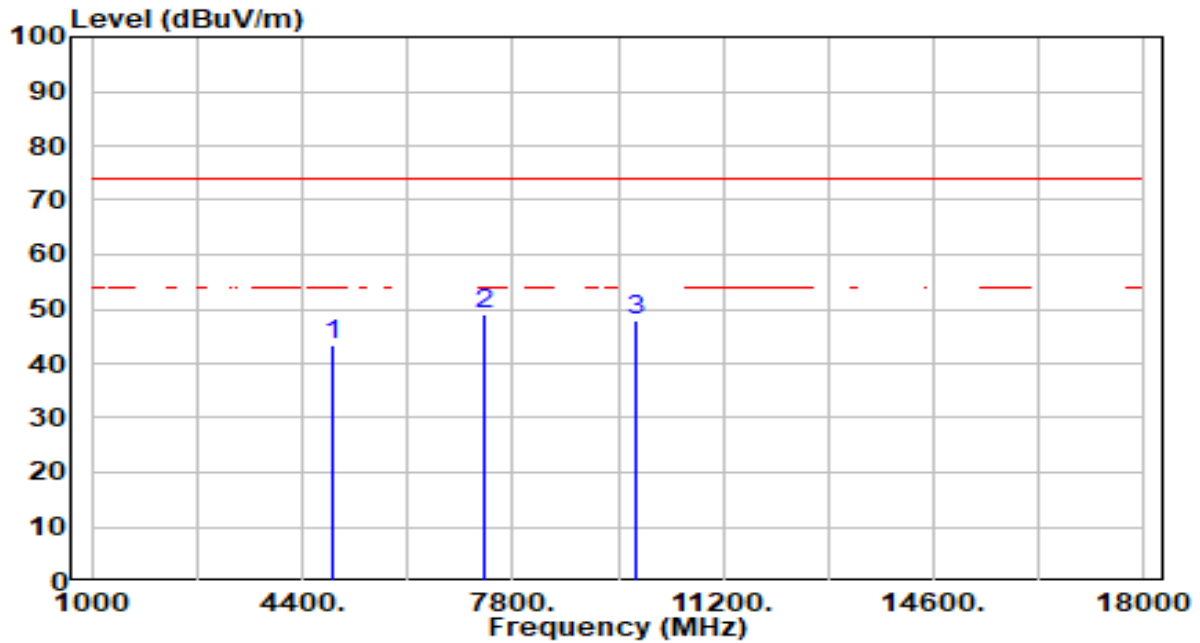

No	Frequency (MHz)	Reading (dBuV)	C.F (dB/m)	Measurement (dBuV/m)	Margin (dB)	Limit (dBuV/m)	Height (cm)	Angle (deg)	Remark (QP/PK/AV)
1	4904.000	42.96	0.44	43.40	-30.60	74.00	200	349	Peak
2	* 7356.000	43.52	5.62	49.13	-24.87	74.00	200	87	Peak
3	9808.000	42.72	5.37	48.09	-25.91	74.00	200	147	Peak

Note:

1. " \*", means this data is the worst emission level.
2. C.F (Correction Factor) = Antenna Factor (dB/m)+ Cable Loss (dB) – Preamplifier(dB).
3. Measurement (dBuV/m) = Reading(dBuV) + C.F (Correction Factor).
4. The emission levels of other frequencies are very lower than the limit and not show in test report.

EUT	BE5000 Whole Home Mesh Wi-Fi 7 System	Date of Test	2024-03-23
Factor	DRH18-E	Temp. / Humidity	24°C /60%
Polarity	Horizontal	Site / Test Engineer	AC2 / Marvin
Test Mode	802.11be-20MHz_TX_CH 1_ANT 0+1	Test Voltage	AC 120V/60Hz

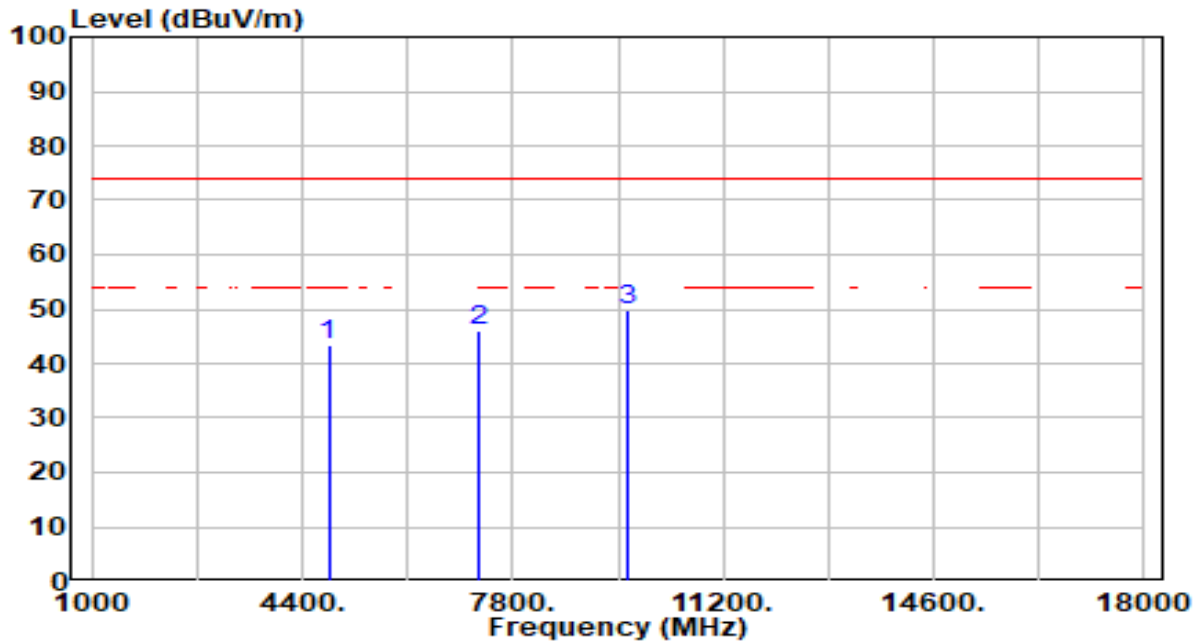

No	Frequency (MHz)	Reading (dBuV)	C.F (dB/m)	Measurement (dBuV/m)	Margin (dB)	Limit (dBuV/m)	Height (cm)	Angle (deg)	Remark (QP/PK/AV)
1	4824.000	43.11	0.23	43.34	-30.66	74.00	200	0	Peak
2	7236.000	40.58	5.54	46.12	-27.88	74.00	200	118	Peak
3	* 9648.000	44.64	5.30	49.95	-24.05	74.00	200	152	Peak

Note:

1. " \*", means this data is the worst emission level.
2. C.F (Correction Factor) = Antenna Factor (dB/m)+ Cable Loss (dB) – Preamplifier(dB).
3. Measurement (dBuV/m) = Reading(dBuV) + C.F (Correction Factor).
4. The emission levels of other frequencies are very lower than the limit and not show in test report.



EUT	BE5000 Whole Home Mesh Wi-Fi 7 System	Date of Test	2024-03-23
Factor	DRH18-E	Temp. / Humidity	24°C /60%
Polarity	Vertical	Site / Test Engineer	AC2 / Marvin
Test Mode	802.11be-20MHz_TX_CH 1_ANT 0+1	Test Voltage	AC 120V/60Hz

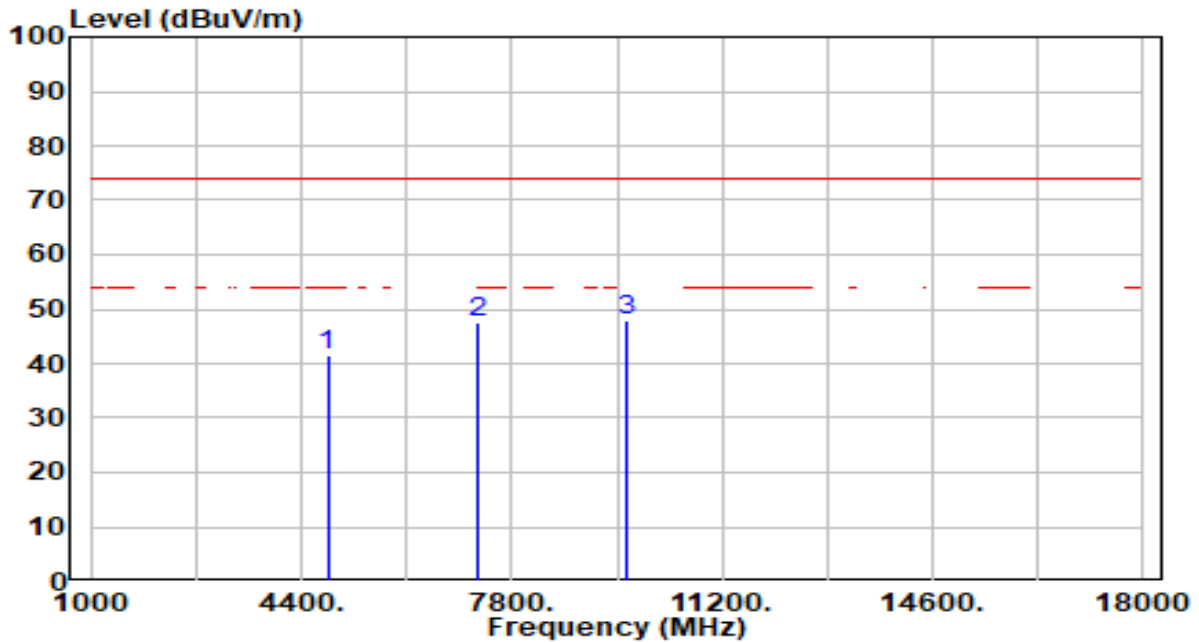

No	Frequency (MHz)	Reading (dBuV)	C.F (dB/m)	Measurement (dBuV/m)	Margin (dB)	Limit (dBuV/m)	Height (cm)	Angle (deg)	Remark (QP/PK/AV)
1	4824.000	41.12	0.23	41.35	-32.65	74.00	200	1	Peak
2	7236.000	42.02	5.54	47.57	-26.43	74.00	200	196	Peak
3	* 9648.000	42.80	5.30	48.10	-25.90	74.00	200	202	Peak

Note:

1. " \*", means this data is the worst emission level.
2. C.F (Correction Factor) = Antenna Factor (dB/m)+ Cable Loss (dB) – Preamplifier(dB).
3. Measurement (dBuV/m) = Reading(dBuV) + C.F (Correction Factor).
4. The emission levels of other frequencies are very lower than the limit and not show in test report.

EUT	BE5000 Whole Home Mesh Wi-Fi 7 System	Date of Test	2024-03-23
Factor	DRH18-E	Temp. / Humidity	24°C /60%
Polarity	Horizontal	Site / Test Engineer	AC2 / Marvin
Test Mode	802.11be-20MHz_TX_CH 6_ANT 0+1	Test Voltage	AC 120V/60Hz

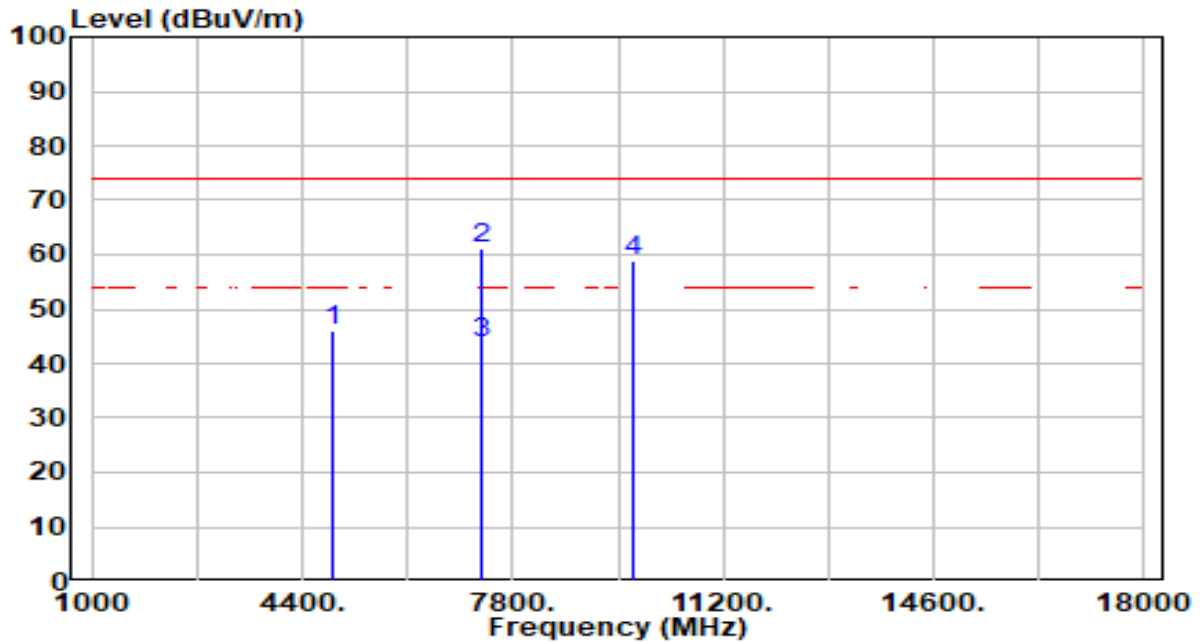

No	Frequency (MHz)	Reading (dBuV)	C.F (dB/m)	Measurement (dBuV/m)	Margin (dB)	Limit (dBuV/m)	Height (cm)	Angle (deg)	Remark (QP/PK/AV)
1	4874.000	45.49	0.36	45.85	-28.15	74.00	200	360	Peak
2	* 7311.000	55.52	5.59	61.11	-12.89	74.00	200	153	Peak
3	* 7311.000	38.34	5.59	43.93	-10.07	54.00	200	153	Average
4	9748.000	53.44	5.34	58.79	-15.21	74.00	200	156	Peak

Note:

- "\*" means this data is the worst emission level.
- C.F (Correction Factor) = Antenna Factor (dB/m)+ Cable Loss (dB) – Pre-amplifier(dB).
- Measurement (dBuV/m) = Reading(dBuV) + C.F (Correction Factor).
- The emission levels of other frequencies are very lower than the limit and not show in test report.

EUT	BE5000 Whole Home Mesh Wi-Fi 7 System	Date of Test	2024-03-23
Factor	DRH18-E	Temp. / Humidity	24°C /60%
Polarity	Vertical	Site / Test Engineer	AC2 / Marvin
Test Mode	802.11be-20MHz_TX_CH 6_ANT 0+1	Test Voltage	AC 120V/60Hz

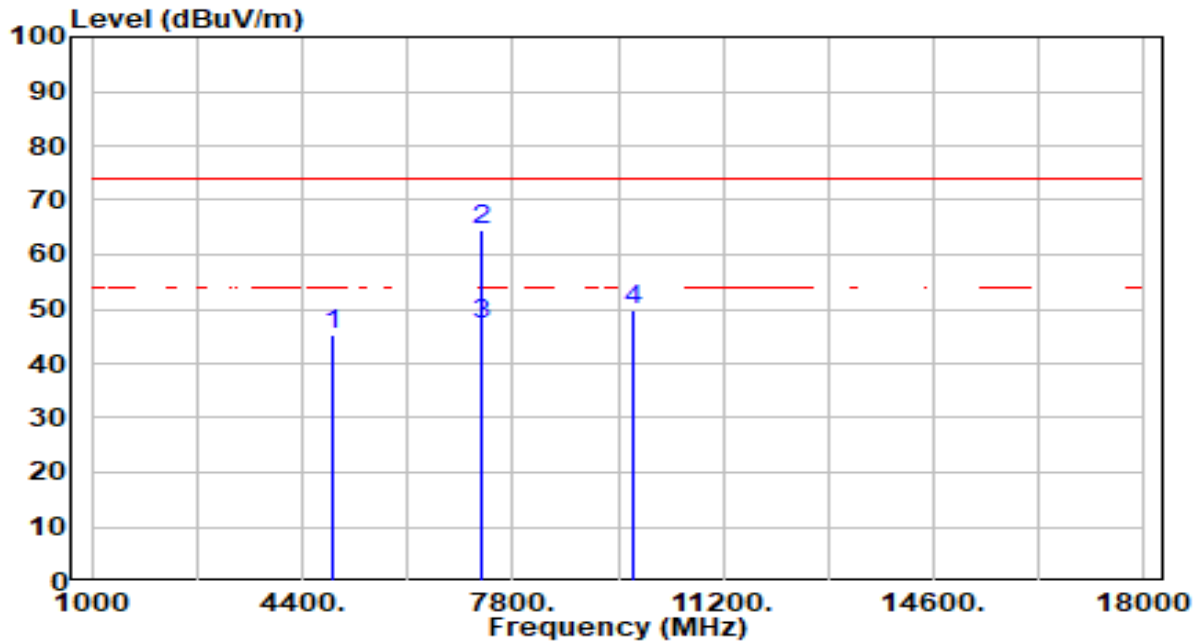

No	Frequency (MHz)	Reading (dBuV)	C.F (dB/m)	Measurement (dBuV/m)	Margin (dB)	Limit (dBuV/m)	Height (cm)	Angle (deg)	Remark (QP/PK/AV)
1	4874.000	45.02	0.36	45.39	-28.61	74.00	200	0	Peak
2	* 7311.000	58.93	5.59	64.52	-9.48	74.00	200	199	Peak
3	* 7311.000	41.75	5.59	47.34	-6.66	54.00	200	199	Average
4	9748.000	44.55	5.34	49.90	-24.10	74.00	200	360	Peak

Note:

- "\*" means this data is the worst emission level.
- C.F (Correction Factor) = Antenna Factor (dB/m)+ Cable Loss (dB) – Preamplifier(dB).
- Measurement (dBuV/m) = Reading(dBuV) + C.F (Correction Factor).
- The emission levels of other frequencies are very lower than the limit and not show in test report.

EUT	BE5000 Whole Home Mesh Wi-Fi 7 System	Date of Test	2024-03-23
Factor	DRH18-E	Temp. / Humidity	24°C /60%
Polarity	Horizontal	Site / Test Engineer	AC2 / Marvin
Test Mode	802.11be-20MHz_TX_CH 11_ANT 0+1	Test Voltage	AC 120V/60Hz

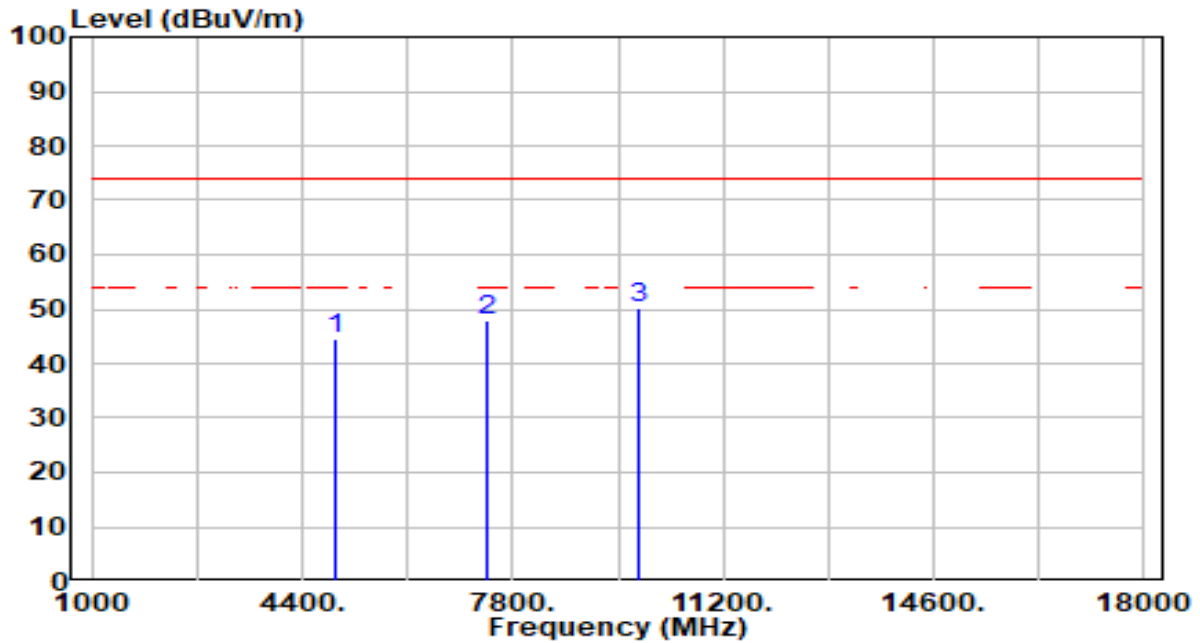

No	Frequency (MHz)	Reading (dBuV)	C.F (dB/m)	Measurement (dBuV/m)	Margin (dB)	Limit (dBuV/m)	Height (cm)	Angle (deg)	Remark (QP/PK/AV)
1	4924.000	44.16	0.49	44.65	-29.35	74.00	200	0	Peak
2	7386.000	42.15	5.64	47.78	-26.22	74.00	200	150	Peak
3	* 9848.000	44.98	5.39	50.37	-23.63	74.00	200	153	Peak

Note:

1. " \*", means this data is the worst emission level.
2. C.F (Correction Factor) = Antenna Factor (dB/m)+ Cable Loss (dB) – Preamplifier(dB).
3. Measurement (dBuV/m) = Reading(dBuV) + C.F (Correction Factor).
4. The emission levels of other frequencies are very lower than the limit and not show in test report.

EUT	BE5000 Whole Home Mesh Wi-Fi 7 System	Date of Test	2024-03-23
Factor	DRH18-E	Temp. / Humidity	24°C /60%
Polarity	Vertical	Site / Test Engineer	AC2 / Marvin
Test Mode	802.11be-20MHz_TX_CH 11_ANT 0+1	Test Voltage	AC 120V/60Hz

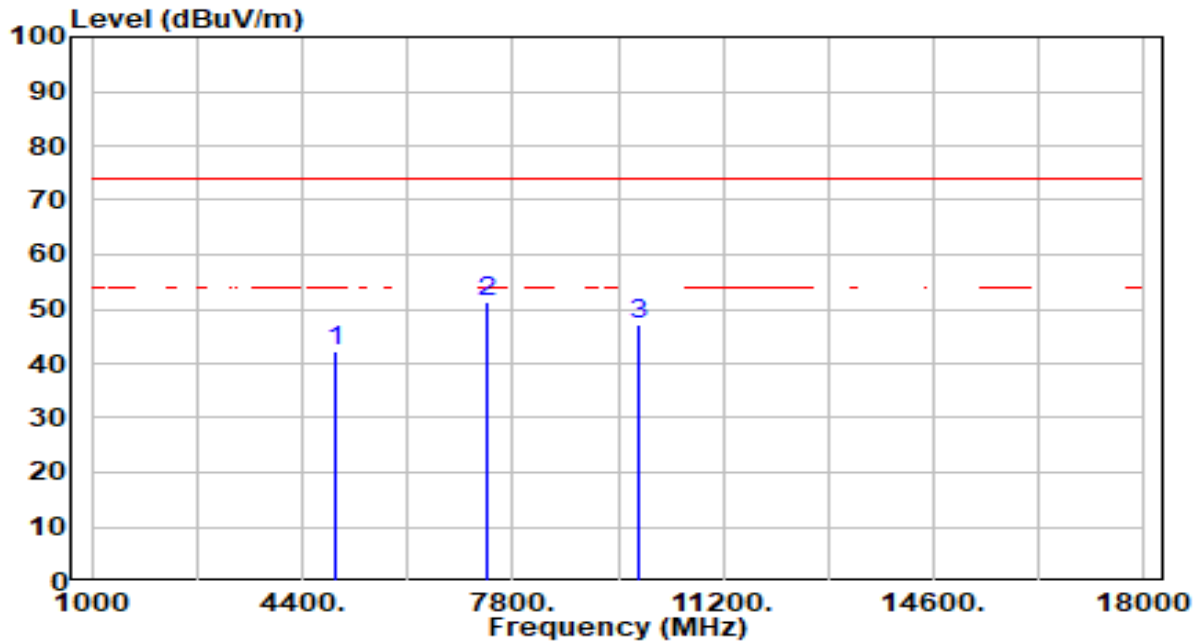

No	Frequency (MHz)	Reading (dBuV)	C.F (dB/m)	Measurement (dBuV/m)	Margin (dB)	Limit (dBuV/m)	Height (cm)	Angle (deg)	Remark (QP/PK/AV)
1	4924.000	41.89	0.49	42.38	-31.62	74.00	200	0	Peak
2	* 7386.000	45.69	5.64	51.32	-22.68	74.00	200	195	Peak
3	9848.000	41.89	5.39	47.28	-26.72	74.00	200	157	Peak

Note:

1. " \*", means this data is the worst emission level.
2. C.F (Correction Factor) = Antenna Factor (dB/m)+ Cable Loss (dB) – Preamplifier(dB).
3. Measurement (dBuV/m) = Reading(dBuV) + C.F (Correction Factor).
4. The emission levels of other frequencies are very lower than the limit and not show in test report.

EUT	BE5000 Whole Home Mesh Wi-Fi 7 System	Date of Test	2024-03-23
Factor	DRH18-E	Temp. / Humidity	24°C /60%
Polarity	Horizontal	Site / Test Engineer	AC2 / Marvin
Test Mode	802.11be-40MHz_TX_CH 3_ANT 0+1	Test Voltage	AC 120V/60Hz

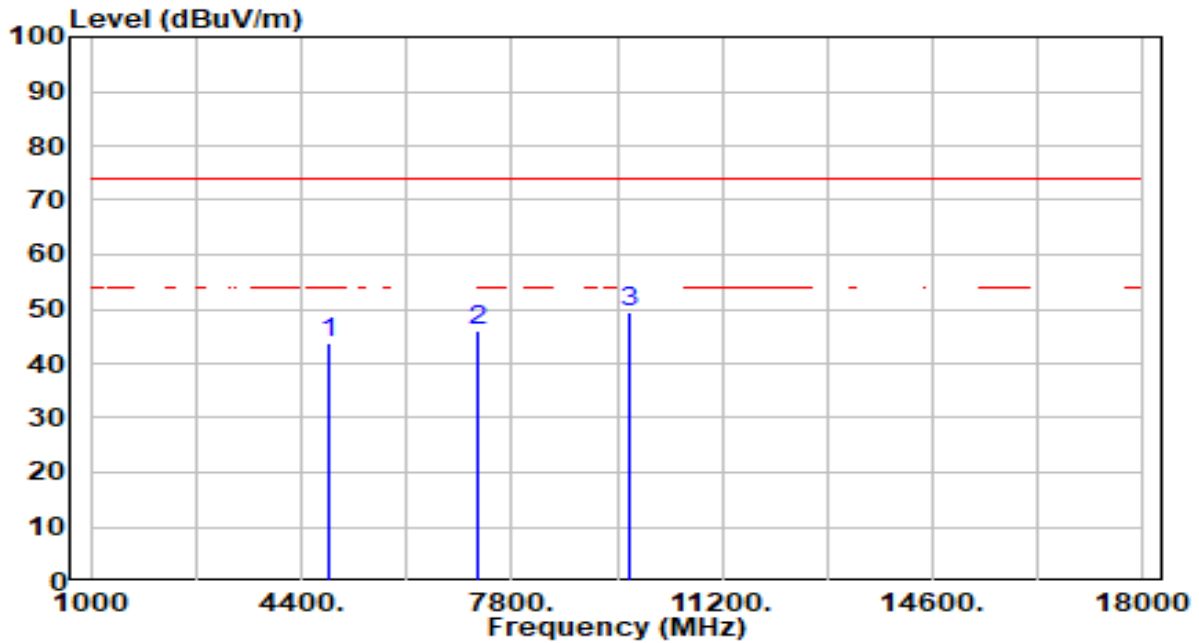

No	Frequency (MHz)	Reading (dBuV)	C.F (dB/m)	Measurement (dBuV/m)	Margin (dB)	Limit (dBuV/m)	Height (cm)	Angle (deg)	Remark (QP/PK/AV)
1	4844.000	43.36	0.28	43.64	-30.36	74.00	200	0	Peak
2	7266.000	40.32	5.56	45.89	-28.11	74.00	200	120	Peak
3	* 9688.000	43.97	5.32	49.29	-24.71	74.00	200	160	Peak

Note:

1. " \*", means this data is the worst emission level.
2. C.F (Correction Factor) = Antenna Factor (dB/m)+ Cable Loss (dB) – Preamplifier(dB).
3. Measurement (dBuV/m) = Reading(dBuV) + C.F (Correction Factor).
4. The emission levels of other frequencies are very lower than the limit and not show in test report.

EUT	BE5000 Whole Home Mesh Wi-Fi 7 System	Date of Test	2024-03-23
Factor	DRH18-E	Temp. / Humidity	24°C /60%
Polarity	Vertical	Site / Test Engineer	AC2 / Marvin
Test Mode	802.11be-40MHz_TX_CH 3_ANT 0+1	Test Voltage	AC 120V/60Hz

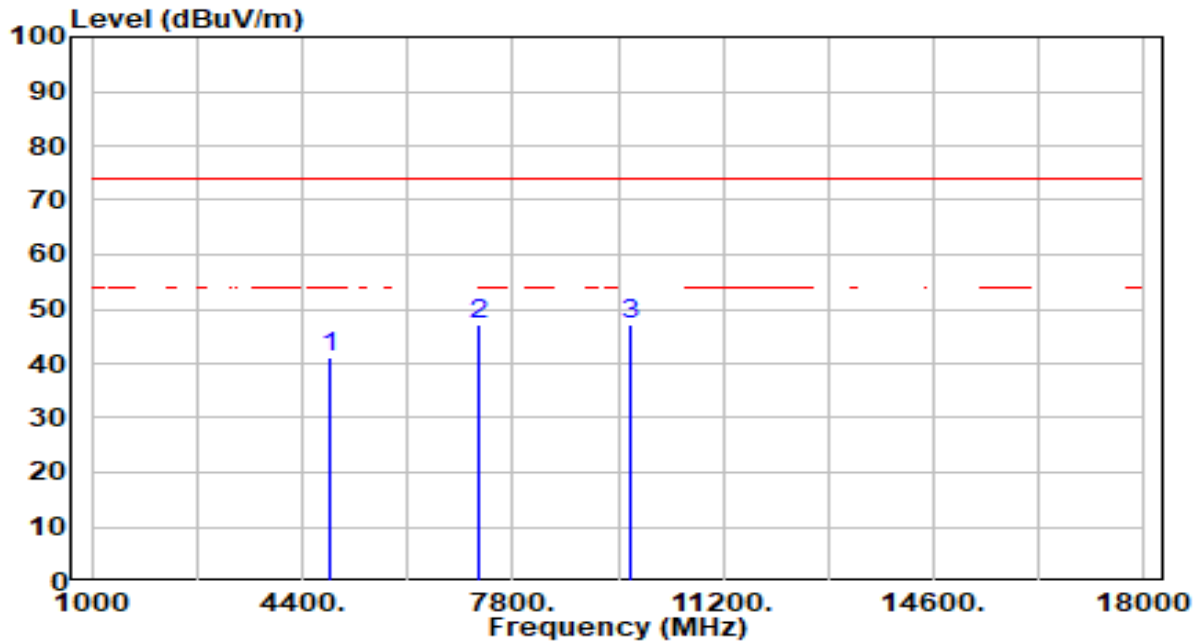

No	Frequency (MHz)	Reading (dBuV)	C.F (dB/m)	Measurement (dBuV/m)	Margin (dB)	Limit (dBuV/m)	Height (cm)	Angle (deg)	Remark (QP/PK/AV)
1	4844.000	41.03	0.28	41.32	-32.68	74.00	200	0	Peak
2	* 7266.000	41.52	5.56	47.08	-26.92	74.00	200	41	Peak
3	9688.000	41.71	5.32	47.03	-26.97	74.00	200	360	Peak

Note:

1. " \*", means this data is the worst emission level.
2. C.F (Correction Factor) = Antenna Factor (dB/m)+ Cable Loss (dB) – Preamplifier(dB).
3. Measurement (dBuV/m) = Reading(dBuV) + C.F (Correction Factor).
4. The emission levels of other frequencies are very lower than the limit and not show in test report.

EUT	BE5000 Whole Home Mesh Wi-Fi 7 System	Date of Test	2024-03-23
Factor	DRH18-E	Temp. / Humidity	24°C /60%
Polarity	Horizontal	Site / Test Engineer	AC2 / Marvin
Test Mode	802.11be-40MHz_TX_CH 6_ANT 0+1	Test Voltage	AC 120V/60Hz

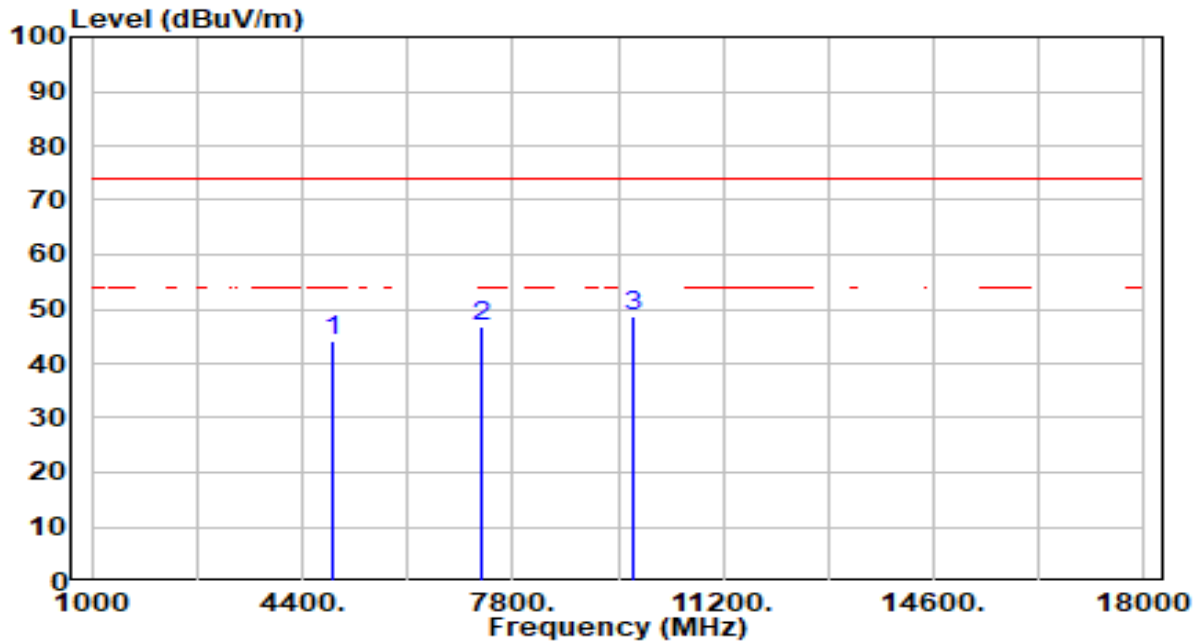

No	Frequency (MHz)	Reading (dBuV)	C.F (dB/m)	Measurement (dBuV/m)	Margin (dB)	Limit (dBuV/m)	Height (cm)	Angle (deg)	Remark (QP/PK/AV)
1	4874.000	43.74	0.36	44.10	-29.90	74.00	200	0	Peak
2	7311.000	41.12	5.59	46.71	-27.29	74.00	200	129	Peak
3	* 9748.000	43.18	5.34	48.53	-25.47	74.00	200	155	Peak

Note:

1. " \*", means this data is the worst emission level.
2. C.F (Correction Factor) = Antenna Factor (dB/m)+ Cable Loss (dB) – Preamplifier(dB).
3. Measurement (dBuV/m) = Reading(dBuV) + C.F (Correction Factor).
4. The emission levels of other frequencies are very lower than the limit and not show in test report.



EUT	BE5000 Whole Home Mesh Wi-Fi 7 System	Date of Test	2024-03-23
Factor	DRH18-E	Temp. / Humidity	24°C /60%
Polarity	Vertical	Site / Test Engineer	AC2 / Marvin
Test Mode	802.11be-40MHz_TX_CH 6_ANT 0+1	Test Voltage	AC 120V/60Hz

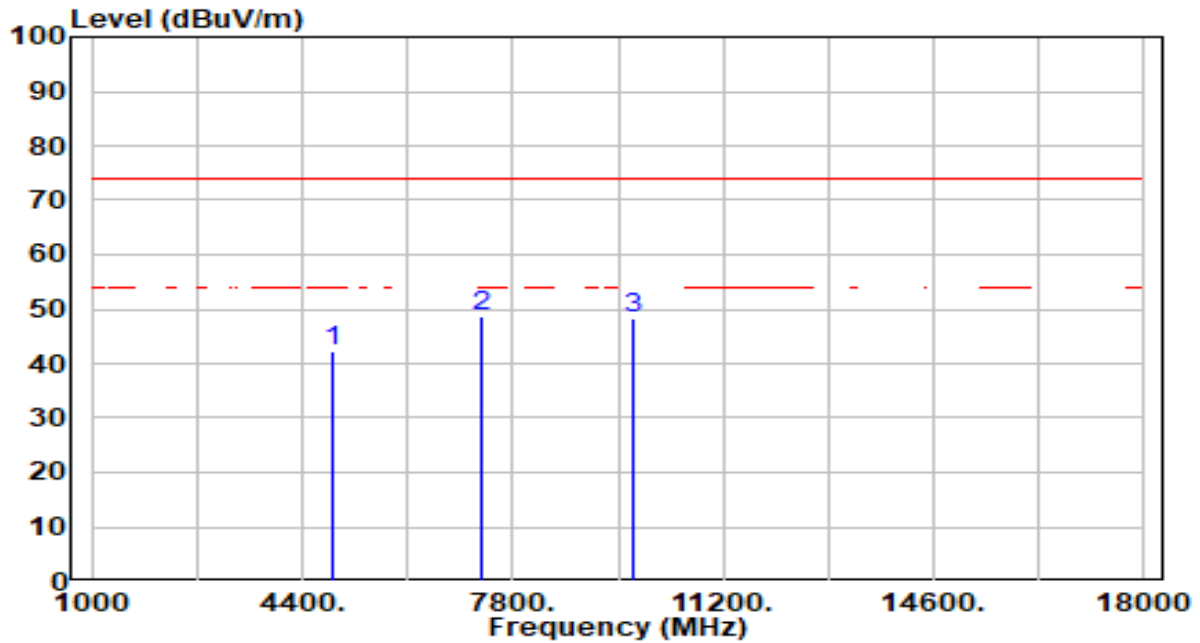

No	Frequency (MHz)	Reading (dBuV)	C.F (dB/m)	Measurement (dBuV/m)	Margin (dB)	Limit (dBuV/m)	Height (cm)	Angle (deg)	Remark (QP/PK/AV)
1	4874.000	42.07	0.36	42.43	-31.57	74.00	200	352	Peak
2	* 7311.000	43.08	5.59	48.66	-25.34	74.00	200	192	Peak
3	9748.000	42.89	5.34	48.23	-25.77	74.00	200	180	Peak

Note:

1. " \*", means this data is the worst emission level.
2. C.F (Correction Factor) = Antenna Factor (dB/m)+ Cable Loss (dB) – Preamplifier(dB).
3. Measurement (dBuV/m) = Reading(dBuV) + C.F (Correction Factor).
4. The emission levels of other frequencies are very lower than the limit and not show in test report.

EUT	BE5000 Whole Home Mesh Wi-Fi 7 System	Date of Test	2024-03-23
Factor	DRH18-E	Temp. / Humidity	24°C /60%
Polarity	Horizontal	Site / Test Engineer	AC2 / Marvin
Test Mode	802.11be-40MHz_TX_CH 9_ANT 0+1	Test Voltage	AC 120V/60Hz

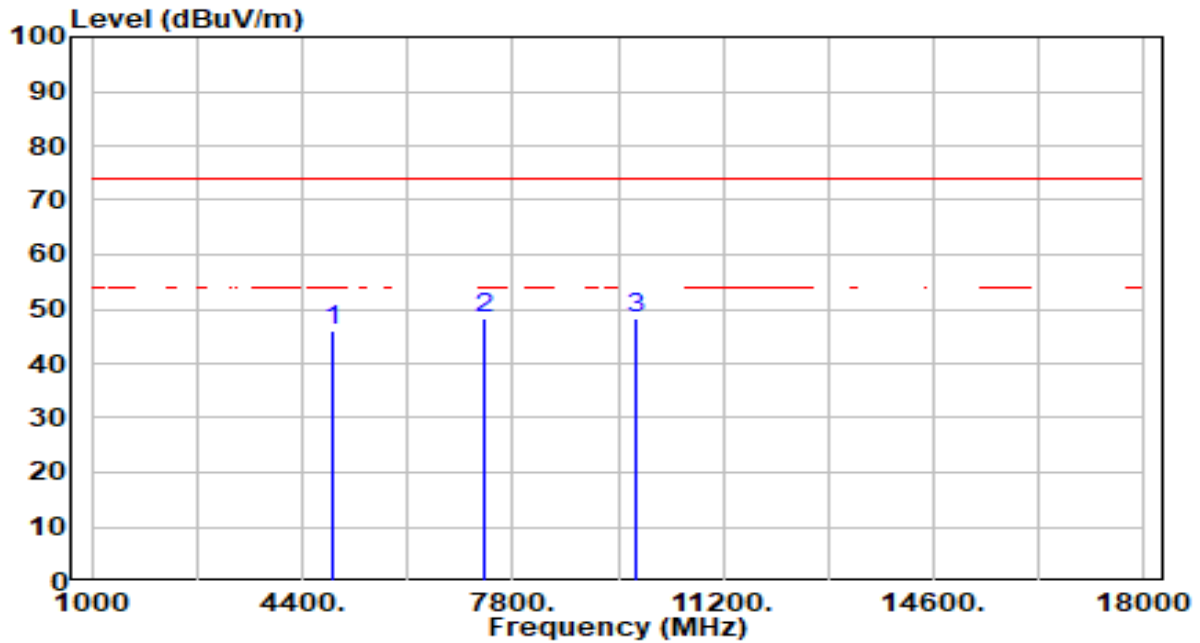

No	Frequency (MHz)	Reading (dBuV)	C.F (dB/m)	Measurement (dBuV/m)	Margin (dB)	Limit (dBuV/m)	Height (cm)	Angle (deg)	Remark (QP/PK/AV)
1	4904.000	45.47	0.44	45.91	-28.09	74.00	200	0	Peak
2	* 7356.000	42.78	5.62	48.40	-25.60	74.00	200	161	Peak
3	9808.000	42.75	5.37	48.12	-25.88	74.00	200	149	Peak

Note:

1. " \*", means this data is the worst emission level.
2. C.F (Correction Factor) = Antenna Factor (dB/m)+ Cable Loss (dB) – Preamplifier(dB).
3. Measurement (dBuV/m) = Reading(dBuV) + C.F (Correction Factor).
4. The emission levels of other frequencies are very lower than the limit and not show in test report.

EUT	BE5000 Whole Home Mesh Wi-Fi 7 System	Date of Test	2024-03-23
Factor	DRH18-E	Temp. / Humidity	24°C /60%
Polarity	Vertical	Site / Test Engineer	AC2 / Marvin
Test Mode	802.11be-40MHz_TX_CH 9_ANT 0+1	Test Voltage	AC 120V/60Hz

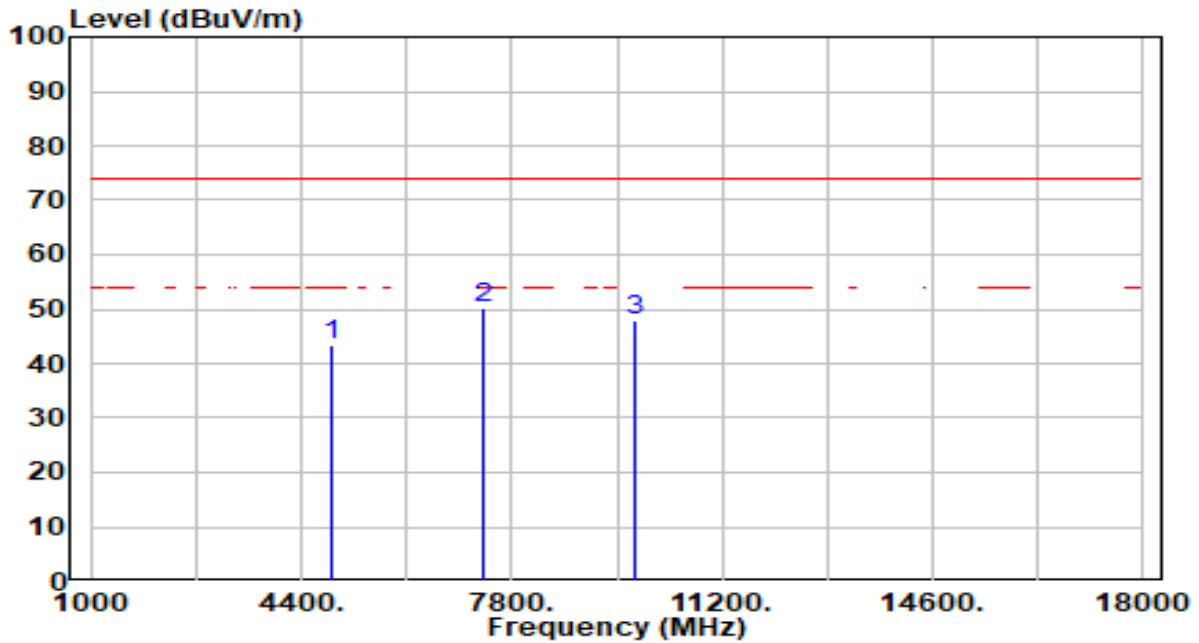

No	Frequency (MHz)	Reading (dBuV)	C.F (dB/m)	Measurement (dBuV/m)	Margin (dB)	Limit (dBuV/m)	Height (cm)	Angle (deg)	Remark (QP/PK/AV)
1	4904.000	42.93	0.44	43.37	-30.63	74.00	200	349	Peak
2	* 7356.000	44.47	5.62	50.08	-23.92	74.00	200	83	Peak
3	9808.000	42.54	5.37	47.91	-26.09	74.00	200	26	Peak

Note:

1. " \*", means this data is the worst emission level.
2. C.F (Correction Factor) = Antenna Factor (dB/m)+ Cable Loss (dB) – Preamplifier(dB).
3. Measurement (dBuV/m) = Reading(dBuV) + C.F (Correction Factor).
4. The emission levels of other frequencies are very lower than the limit and not show in test report.

EUT	BE5000 Whole Home Mesh Wi-Fi 7 System	Date of Test	2024-04-08
Factor	BBHA 9170	Temp. / Humidity	24°C /60%
Polarity	Horizontal	Site / Test Engineer	AC2 / Stanley
Test Mode	802.11n-20MHz_TX_CH 6_ANT 0+1	Test Voltage	AC 120V/60Hz

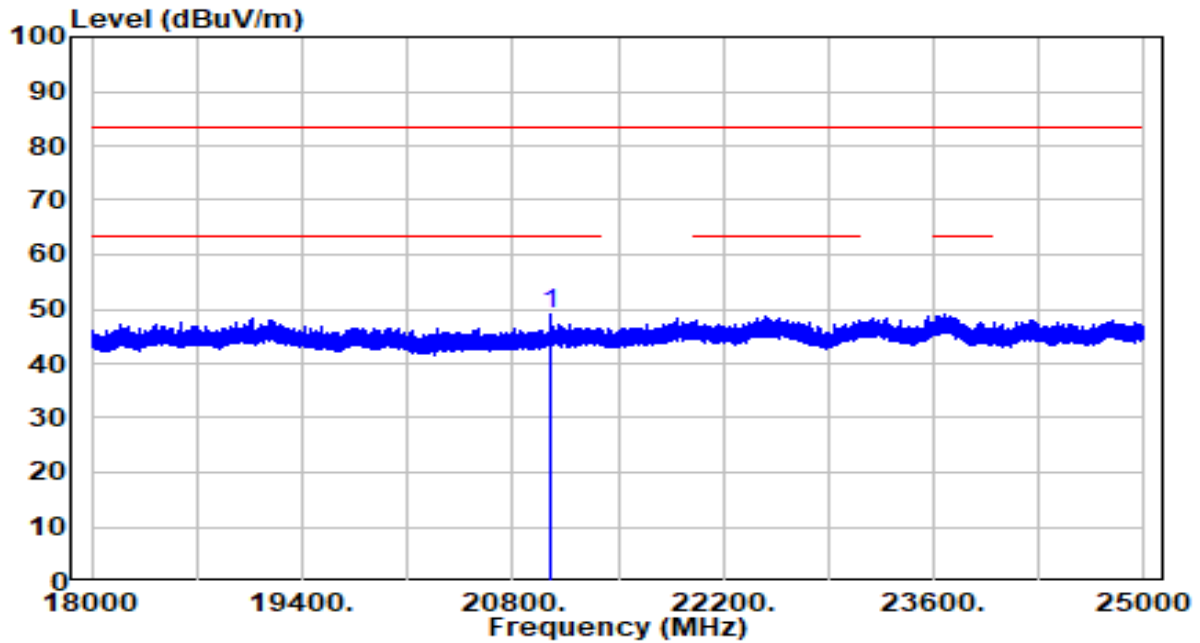

No	Frequency (MHz)	Reading (dBuV)	C.F (dB/m)	Measurement (dBuV/m)	Margin (dB)	Limit (dBuV/m)	Height (cm)	Angle (deg)	Remark (QP/PK/AV)	
1	*	21045.220	38.06	10.93	49.00	-34.50	83.50	150	360	Peak

Note:

1. " \*", means this data is the worst emission level.
2. C.F (Correction Factor) = Antenna Factor (dB/m) + Cable Loss (dB) – Preamplifier(dB).
3. Measurement (dBuV/m) = Reading(dBuV) + C.F (Correction Factor).
4. The emission levels of other frequencies are very lower than the limit and not show in test report.

EUT	BE5000 Whole Home Mesh Wi-Fi 7 System	Date of Test	2024-04-08
Factor	BBHA 9170	Temp. / Humidity	24°C /60%
Polarity	Vertical	Site / Test Engineer	AC2 / Stanley
Test Mode	802.11n-20MHz_TX_CH 6_ANT 0+1	Test Voltage	AC 120V/60Hz

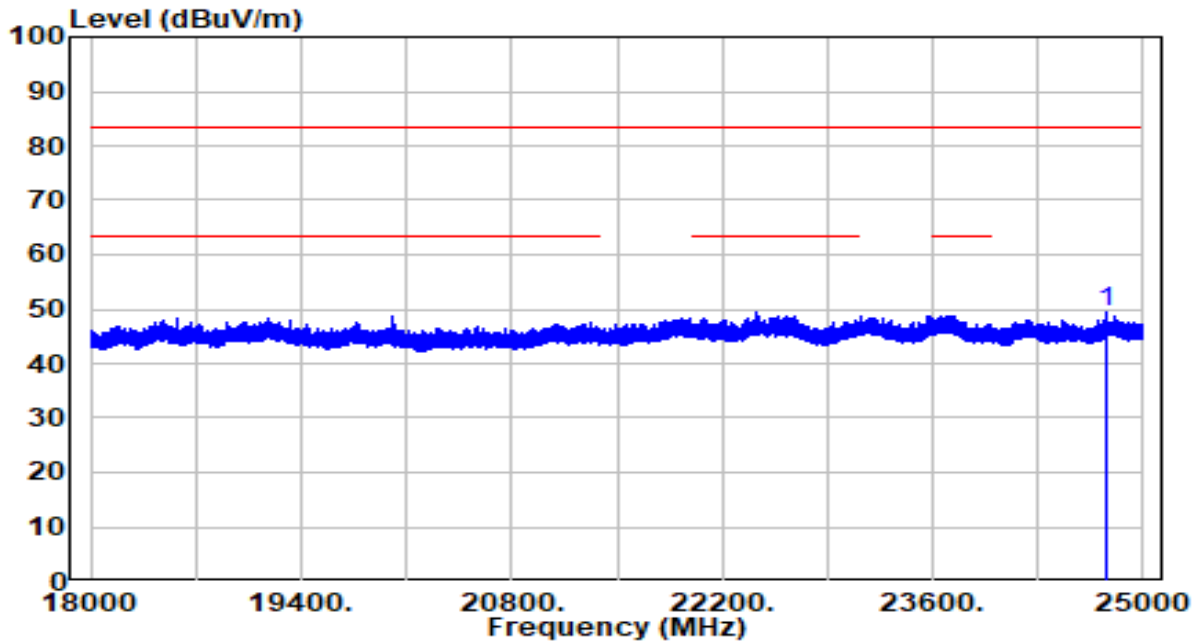

No	Frequency (MHz)	Reading (dBuV)	C.F (dB/m)	Measurement (dBuV/m)	Margin (dB)	Limit (dBuV/m)	Height (cm)	Angle (deg)	Remark (QP/PK/AV)	
1	*	24749.090	36.62	12.83	49.45	-34.05	83.50	150	0	Peak

Note:

1. " \*", means this data is the worst emission level.
2. C.F (Correction Factor) = Antenna Factor (dB/m) + Cable Loss (dB) – Preamplifier(dB).
3. Measurement (dBuV/m) = Reading(dBuV) + C.F (Correction Factor).
4. The emission levels of other frequencies are very lower than the limit and not show in test report.

## 7.7. Radiated Restricted Band Edge Measurement

### 7.7.1. Test Limit

**For 15.205 requirement:**

Radiated emissions which fall in the restricted bands, as defined in Section 15.205(a) of FCC part 15, must also comply with the radiated emission limits specified in Section 15.209(a).

Frequency (MHz)	Frequency (MHz)	Frequency (MHz)	Frequency (GHz)
0.090 - 0.110	16.42 - 16.423	399.9 - 410	4.5 - 5.15
<sup>1</sup> 0.495 - 0.505	16.69475 - 16.69525	608 - 614	5.35 - 5.46
2.1735 - 2.1905	16.80425 - 16.80475	960 - 1240	7.25 - 7.75
4.125 - 4.128	25.5 - 25.67	1300 - 1427	8.025 - 8.5
4.17725 - 4.17775	37.5 - 38.25	1435 - 1626.5	9.0 - 9.2
4.20725 - 4.20775	73 - 74.6	1645.5 - 1646.5	9.3 - 9.5
6.215 - 6.218	74.8 - 75.2	1660 - 1710	10.6 - 12.7
6.26775 - 6.26825	108 - 121.94	1718.8 - 1722.2	13.25 - 13.4
6.31175 - 6.31225	123 - 138	2200 - 2300	14.47 - 14.5
8.291 - 8.294	149.9 - 150.05	2310 - 2390	15.35 - 16.2
8.362 - 8.366	156.52475 - 156.52525	2483.5 - 2500	17.7 - 21.4
8.37625 - 8.38675	156.7 - 156.9	2690 - 2900	22.01 - 23.12
8.41425 - 8.41475	162.0125 - 167.17	3260 - 3267	23.6 - 24.0
12.29 - 12.293	167.72 - 173.2	3332 - 3339	31.2 - 31.8
12.51975 - 12.52025	240 - 285	3345.8 - 3358	36.43 - 36.5
12.57675 - 12.57725	322 - 335.4	3600 - 4400	( <sup>2</sup> )
13.36 - 13.41	--	--	--

All out of band emissions appearing in a restricted band as specified in Section 15.205 of the Title 47CFR must not exceed the limits shown in Table per Section 15.209.

FCC Part 15 Subpart C Paragraph 15.209 Limits		
Frequency [MHz]	Field Strength [uV/m]	Measured Distance [Meters]
0.009 - 0.490	2400/F (kHz)	300
0.490 - 1.705	24000/F (kHz)	30
1.705 - 30	30	30
30 - 88	100	3
88 - 216	150	3
216 - 960	200	3
Above 960	500	3

### 7.7.2. Test Procedure Used

ANSI C63.10-2013 Section 6.3 & 6.6 & 11.13

### 7.7.3. Test Setting

#### Peak Field Strength Measurements

1. Analyzer center frequency was set to the frequency of the radiated spurious emission of interest
2. RBW = 1MHz
3. VBW = 3MHz
4. Detector = peak
5. Sweep time = auto couple
6. Trace mode = max hold
7. Trace was allowed to stabilize

### Average Measurements above 1GHz (Method VB)

1. Analyzer center frequency was set to the frequency of the radiated spurious emission of interest
2. RBW = 1MHz
3. VBW; If the EUT is configured to transmit with duty cycle  $\geq 98\%$ , set VBW = 10 Hz.

If the EUT duty cycle is  $< 98\%$ , set  $VBW \geq 1/T$ . T is the minimum transmission duration.

4. Detector = Peak
5. Sweep time = auto
6. Trace mode = max hold
7. Trace was allowed to stabilize

#### 7.7.4. Test Setup

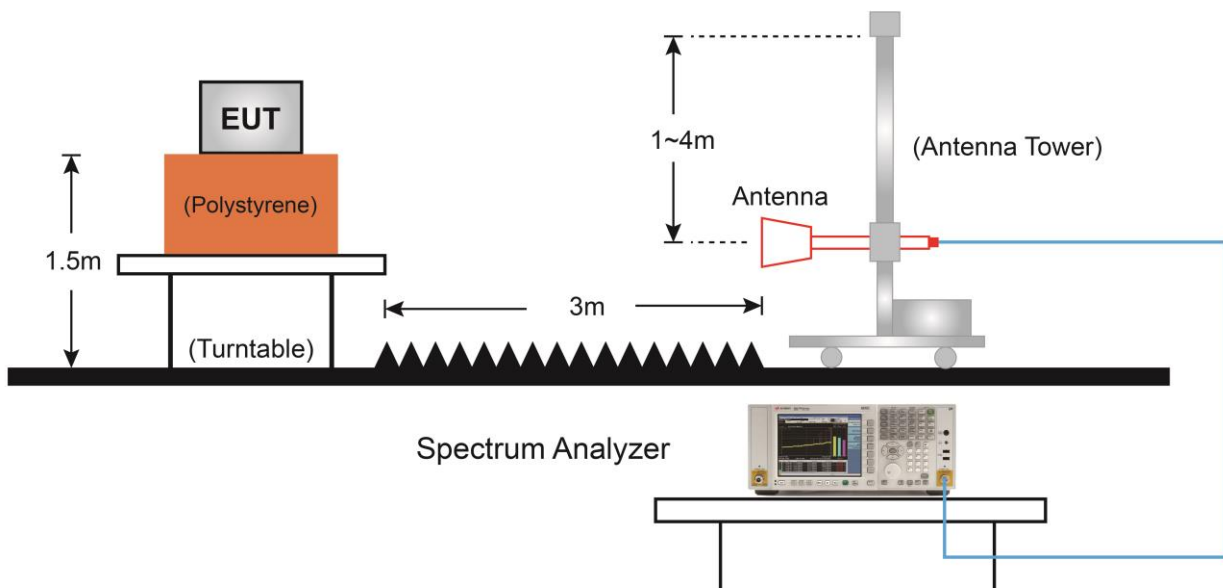



### 7.7.5. Test Result

EUT	BE5000 Whole Home Mesh Wi-Fi 7 System	Date of Test	2024-03-23
Factor	DRH18-E	Temp. / Humidity	24°C /60%
Polarity	Horizontal	Site / Test Engineer	AC2 / Marvin
Test Mode	802.11b_TX_CH 1_ANT 0+1	Test Voltage	AC 120V/60Hz

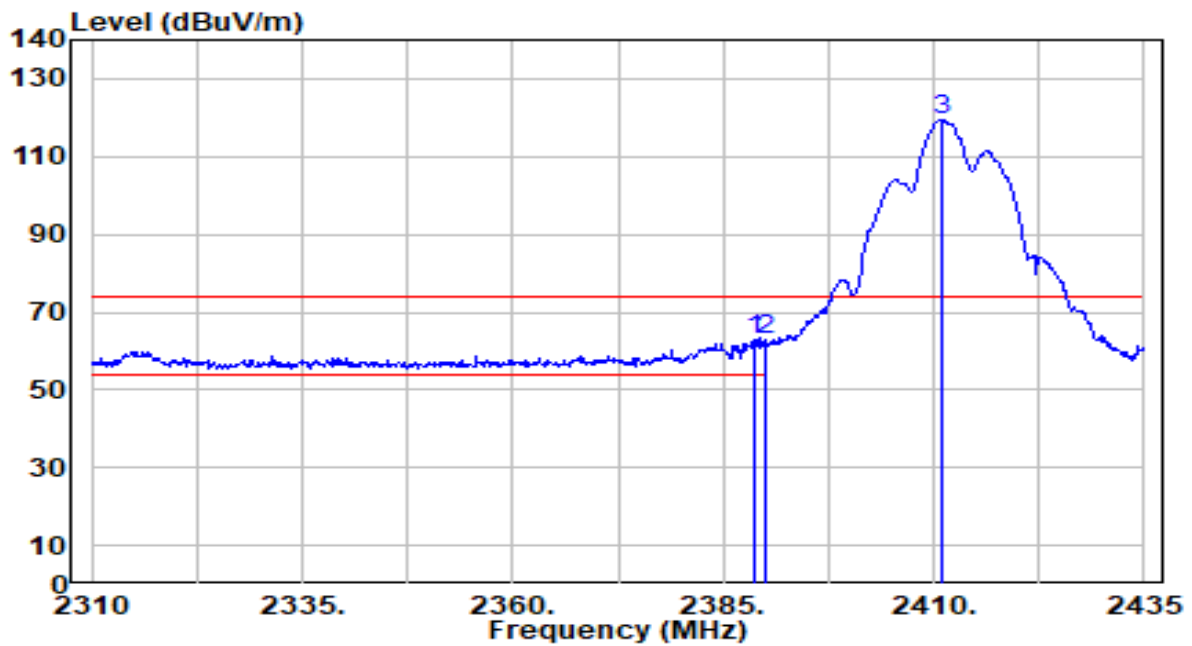

No	Frequency (MHz)	Reading (dBuV)	C.F (dB/m)	Measurement (dBuV/m)	Margin (dB)	Limit (dBuV/m)	Height (cm)	Angle (deg)	Remark (QP/PK/AV)
1	* 2388.625	32.65	30.44	63.10	-10.90	74.00	104	87	Peak
2	2390.000	32.45	30.45	62.89	-11.11	74.00	104	87	Peak
3	2410.875	89.14	30.49	119.64	N/A	N/A	104	87	Peak

Note:

1. " \*", means this data is the worst emission level.
2. C.F (Correction Factor) = Antenna Factor (dB/m)+ Cable Loss (dB).
3. Measurement (dBuV/m) = Reading(dBuV) + C.F (Correction Factor).
4. The emission levels of other frequencies are very lower than the limit and not show in test report.

EUT	BE5000 Whole Home Mesh Wi-Fi 7 System	Date of Test	2024-03-23
Factor	DRH18-E	Temp. / Humidity	24°C /60%
Polarity	Horizontal	Site / Test Engineer	AC2 / Marvin
Test Mode	802.11b_TX_CH 1_ANT 0+1	Test Voltage	AC 120V/60Hz

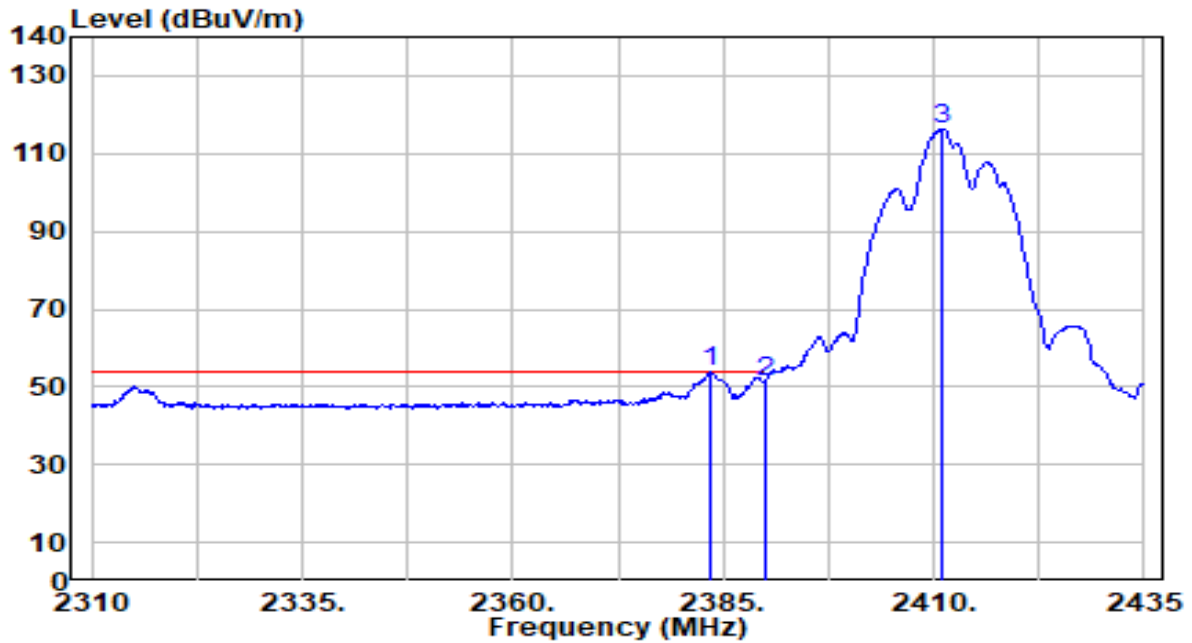

No	Frequency (MHz)	Reading (dBUV)	C.F (dB/m)	Measurement (dBUV/m)	Margin (dB)	Limit (dBUV/m)	Height (cm)	Angle (deg)	Remark (QP/PK/AV)
1	*	23.39	30.43	53.82	-0.18	54.00	104	87	Average
2		21.00	30.45	51.44	-2.56	54.00	104	87	Average
3		85.90	30.49	116.39	N/A	N/A	104	87	Average

Note:

1. " \*", means this data is the worst emission level.
2. C.F (Correction Factor) = Antenna Factor (dB/m)+ Cable Loss (dB).
3. Measurement (dBUV/m) = Reading(dBUV) + C.F (Correction Factor).
4. The emission levels of other frequencies are very lower than the limit and not show in test report.

EUT	BE5000 Whole Home Mesh Wi-Fi 7 System	Date of Test	2024-03-23
Factor	DRH18-E	Temp. / Humidity	24°C /60%
Polarity	Vertical	Site / Test Engineer	AC2 / Marvin
Test Mode	802.11b_TX_CH 1_ANT 0+1	Test Voltage	AC 120V/60Hz

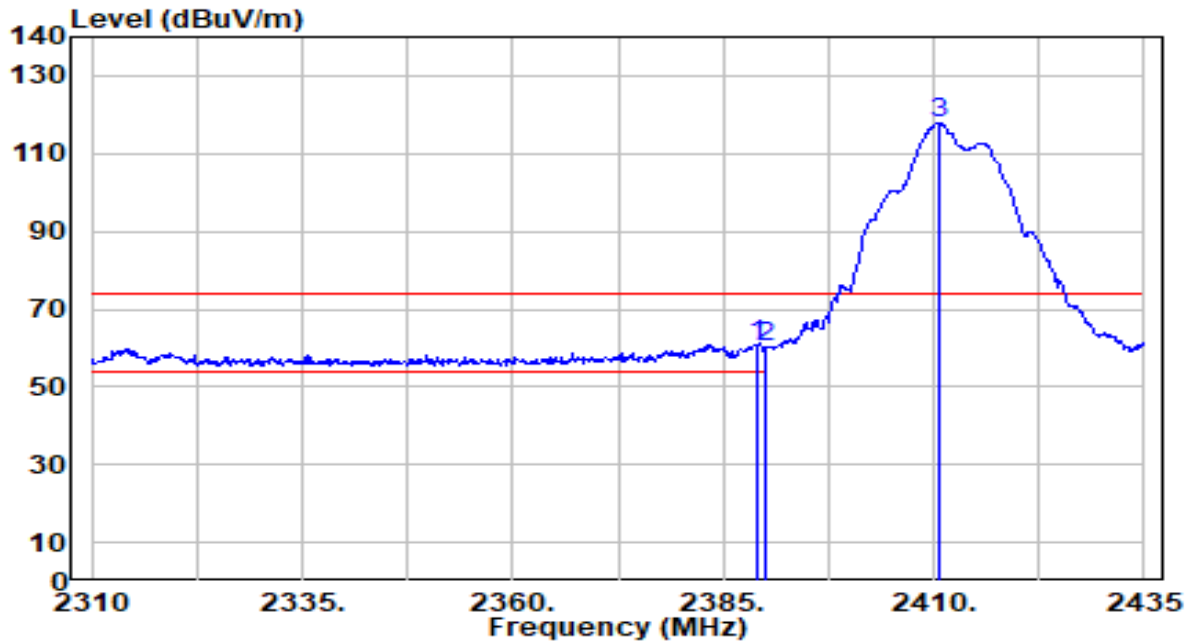

No	Frequency (MHz)	Reading (dBUV)	C.F (dB/m)	Measurement (dBUV/m)	Margin (dB)	Limit (dBUV/m)	Height (cm)	Angle (deg)	Remark (QP/PK/AV)	
1	*	2389.000	30.55	30.44	61.00	-13.00	74.00	278	187	Peak
2		2390.000	29.58	30.45	60.03	-13.97	74.00	278	187	Peak
3		2410.625	87.31	30.49	117.80	N/A	N/A	278	187	Peak

Note:

1. " \*", means this data is the worst emission level.
2. C.F (Correction Factor) = Antenna Factor (dB/m)+ Cable Loss (dB).
3. Measurement (dBUV/m) = Reading(dBUV) + C.F (Correction Factor).
4. The emission levels of other frequencies are very lower than the limit and not show in test report.

EUT	BE5000 Whole Home Mesh Wi-Fi 7 System	Date of Test	2024-03-23
Factor	DRH18-E	Temp. / Humidity	24°C /60%
Polarity	Vertical	Site / Test Engineer	AC2 / Marvin
Test Mode	802.11b_TX_CH 1_ANT 0+1	Test Voltage	AC 120V/60Hz

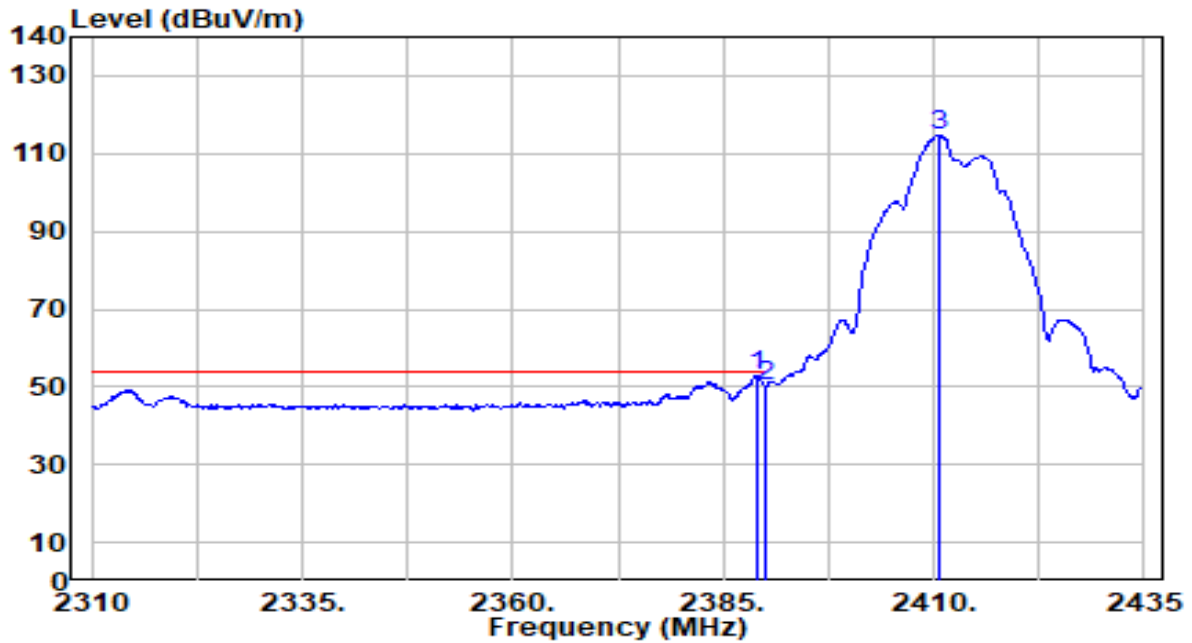

No	Frequency (MHz)	Reading (dBUV)	C.F (dB/m)	Measurement (dBUV/m)	Margin (dB)	Limit (dBUV/m)	Height (cm)	Angle (deg)	Remark (QP/PK/AV)
1	* 2389.000	22.63	30.44	53.08	-0.92	54.00	278	187	Average
2	2390.000	19.66	30.45	50.11	-3.89	54.00	278	187	Average
3	2410.750	84.14	30.49	114.63	N/A	N/A	278	187	Average

Note:

1. " \*", means this data is the worst emission level.
2. C.F (Correction Factor) = Antenna Factor (dB/m)+ Cable Loss (dB).
3. Measurement (dBUV/m) = Reading(dBUV) + C.F (Correction Factor).
4. The emission levels of other frequencies are very lower than the limit and not show in test report.

EUT	BE5000 Whole Home Mesh Wi-Fi 7 System	Date of Test	2024-03-23
Factor	DRH18-E	Temp. / Humidity	24°C /60%
Polarity	Horizontal	Site / Test Engineer	AC2 / Marvin
Test Mode	802.11b_TX_CH 6_ANT 0+1	Test Voltage	AC 120V/60Hz

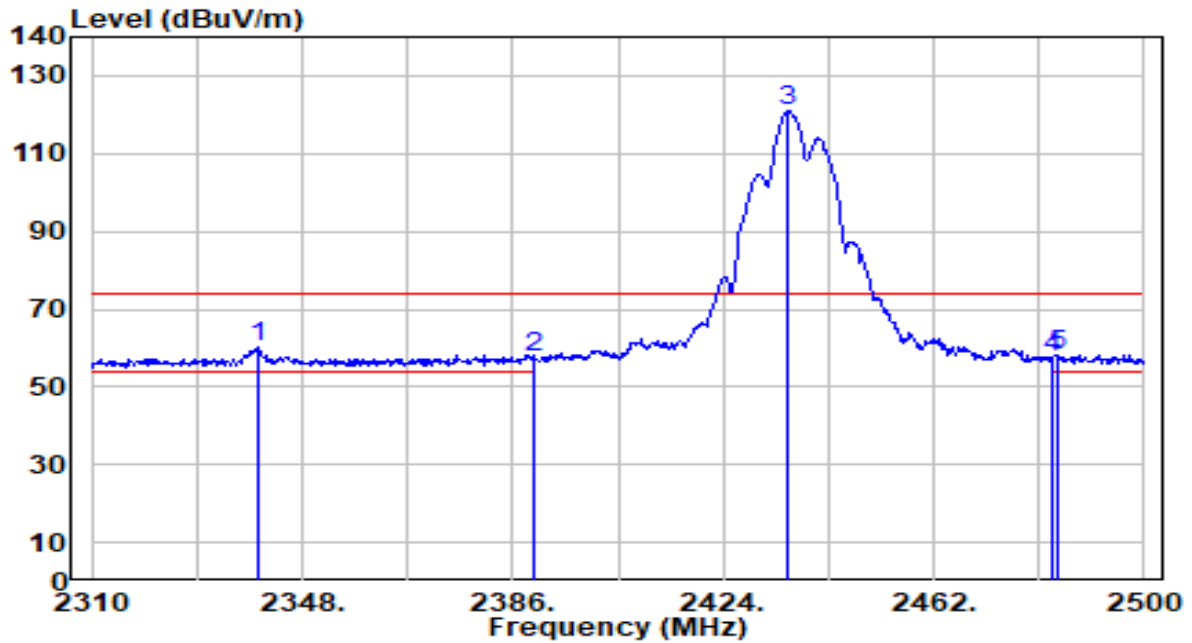

No	Frequency (MHz)	Reading (dBuV)	C.F (dB/m)	Measurement (dBuV/m)	Margin (dB)	Limit (dBuV/m)	Height (cm)	Angle (deg)	Remark (QP/PK/AV)
1	* 2339.830	29.80	30.31	60.10	-13.90	74.00	309	264	Peak
2	2390.000	27.19	30.45	57.64	-16.36	74.00	309	264	Peak
3	2435.780	90.46	30.52	120.98	N/A	N/A	309	264	Peak
4	2483.500	26.88	30.59	57.47	-16.53	74.00	309	264	Peak
5	2484.230	27.47	30.59	58.05	-15.95	74.00	309	264	Peak

Note:

- "\*" means this data is the worst emission level.
- C.F (Correction Factor) = Antenna Factor (dB/m)+ Cable Loss (dB).
- Measurement (dBuV/m) = Reading(dBuV) + C.F (Correction Factor).
- The emission levels of other frequencies are very lower than the limit and not show in test report.

EUT	BE5000 Whole Home Mesh Wi-Fi 7 System	Date of Test	2024-03-23
Factor	DRH18-E	Temp. / Humidity	24°C /60%
Polarity	Horizontal	Site / Test Engineer	AC2 / Marvin
Test Mode	802.11b_TX_CH 6_ANT 0+1	Test Voltage	AC 120V/60Hz

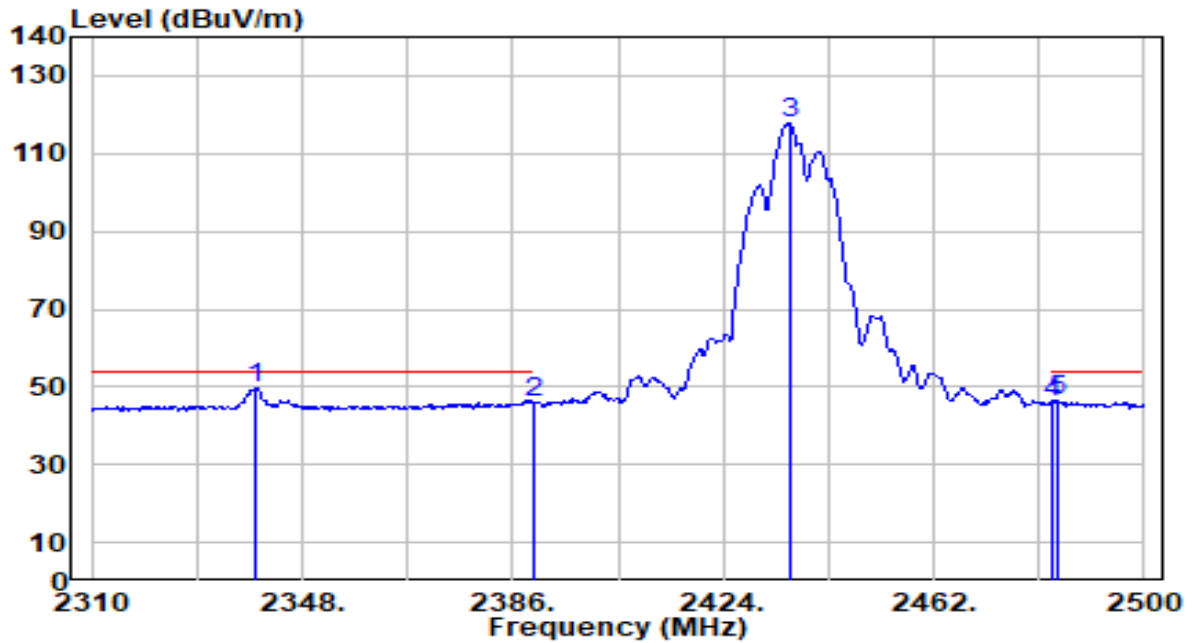

No	Frequency (MHz)	Reading (dBuV)	C.F (dB/m)	Measurement (dBuV/m)	Margin (dB)	Limit (dBuV/m)	Height (cm)	Angle (deg)	Remark (QP/PK/AV)
1	* 2339.640	19.53	30.30	49.84	-4.16	54.00	309	264	Average
2	2390.000	15.44	30.45	45.89	-8.11	54.00	309	264	Average
3	2435.970	87.35	30.52	117.87	N/A	N/A	309	264	Average
4	2483.500	15.52	30.59	46.10	-7.90	54.00	309	264	Average
5	2484.230	15.65	30.59	46.24	-7.76	54.00	309	264	Average

Note:

- " \*", means this data is the worst emission level.
- C.F (Correction Factor) = Antenna Factor (dB/m)+ Cable Loss (dB).
- Measurement (dBuV/m) = Reading(dBuV) + C.F (Correction Factor).
- The emission levels of other frequencies are very lower than the limit and not show in test report.

EUT	BE5000 Whole Home Mesh Wi-Fi 7 System	Date of Test	2024-03-23
Factor	DRH18-E	Temp. / Humidity	24°C /60%
Polarity	Vertical	Site / Test Engineer	AC2 / Marvin
Test Mode	802.11b_TX_CH 6_ANT 0+1	Test Voltage	AC 120V/60Hz

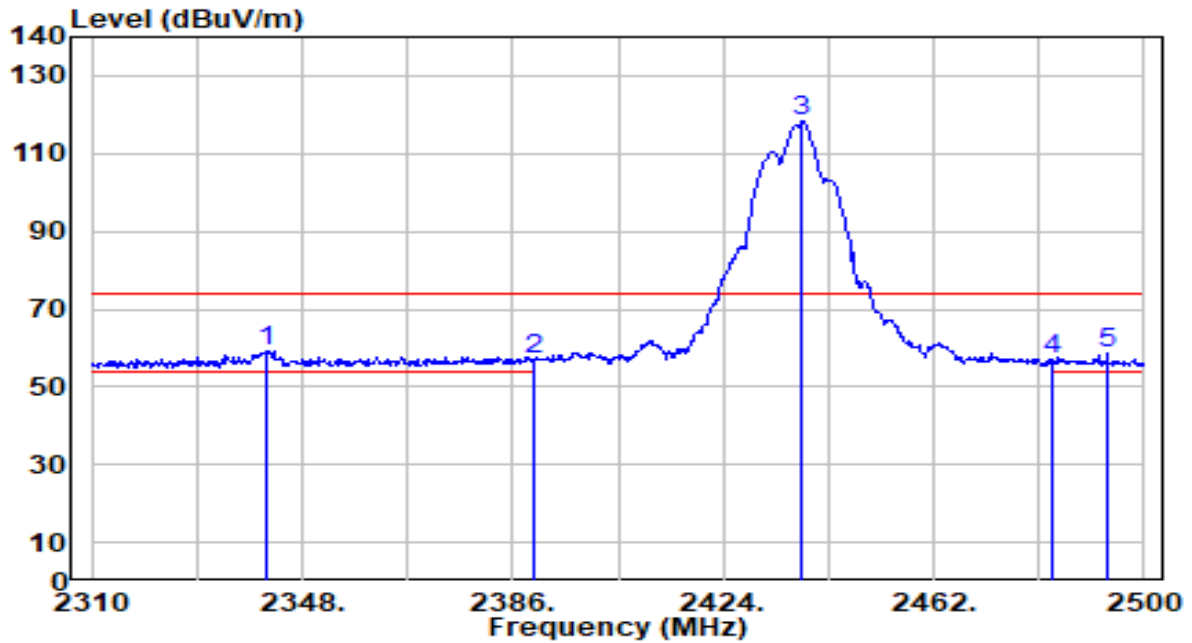

No	Frequency (MHz)	Reading (dBuV)	C.F (dB/m)	Measurement (dBuV/m)	Margin (dB)	Limit (dBuV/m)	Height (cm)	Angle (deg)	Remark (QP/PK/AV)
1	* 2341.350	28.85	30.31	59.16	-14.84	74.00	200	179	Peak
2	2390.000	26.68	30.45	57.12	-16.88	74.00	200	179	Peak
3	2438.250	87.76	30.53	118.29	N/A	N/A	200	179	Peak
4	2483.500	26.52	30.59	57.11	-16.89	74.00	200	179	Peak
5	2493.350	27.95	30.60	58.55	-15.45	74.00	200	179	Peak

Note:

- " \*", means this data is the worst emission level.
- C.F (Correction Factor) = Antenna Factor (dB/m)+ Cable Loss (dB).
- Measurement (dBuV/m) = Reading(dBuV) + C.F (Correction Factor).
- The emission levels of other frequencies are very lower than the limit and not show in test report.

EUT	BE5000 Whole Home Mesh Wi-Fi 7 System	Date of Test	2024-03-23
Factor	DRH18-E	Temp. / Humidity	24°C /60%
Polarity	Vertical	Site / Test Engineer	AC2 / Marvin
Test Mode	802.11b_TX_CH 6_ANT 0+1	Test Voltage	AC 120V/60Hz

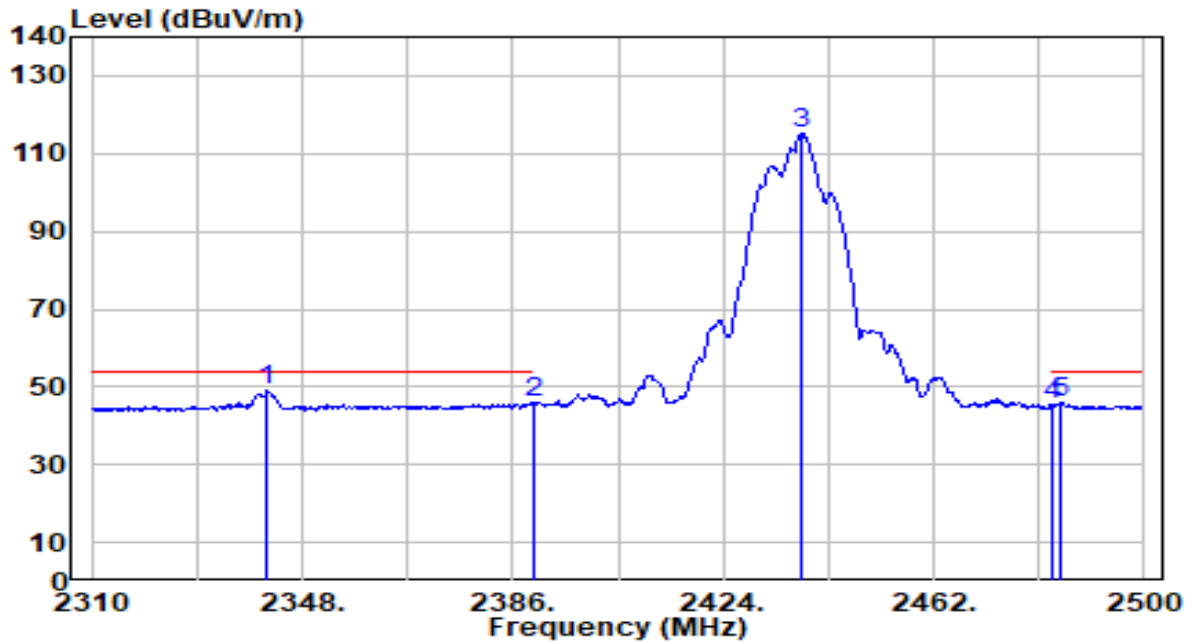

No	Frequency (MHz)	Reading (dBuV)	C.F (dB/m)	Measurement (dBuV/m)	Margin (dB)	Limit (dBuV/m)	Height (cm)	Angle (deg)	Remark (QP/PK/AV)
1	* 2341.730	18.62	30.31	48.93	-5.07	54.00	200	179	Average
2	2390.000	15.29	30.45	45.74	-8.26	54.00	200	179	Average
3	2438.060	84.64	30.53	115.16	N/A	N/A	200	179	Average
4	2483.500	14.89	30.59	45.47	-8.53	54.00	200	179	Average
5	2484.990	15.32	30.59	45.91	-8.09	54.00	200	179	Average

Note:

1. " \*", means this data is the worst emission level.
2. C.F (Correction Factor) = Antenna Factor (dB/m)+ Cable Loss (dB).
3. Measurement (dBuV/m) = Reading(dBuV) + C.F (Correction Factor).
4. The emission levels of other frequencies are very lower than the limit and not show in test report.



EUT	BE5000 Whole Home Mesh Wi-Fi 7 System	Date of Test	2024-03-23
Factor	DRH18-E	Temp. / Humidity	24°C /60%
Polarity	Horizontal	Site / Test Engineer	AC2 / Marvin
Test Mode	802.11b_TX_CH 11_ANT 0+1	Test Voltage	AC 120V/60Hz

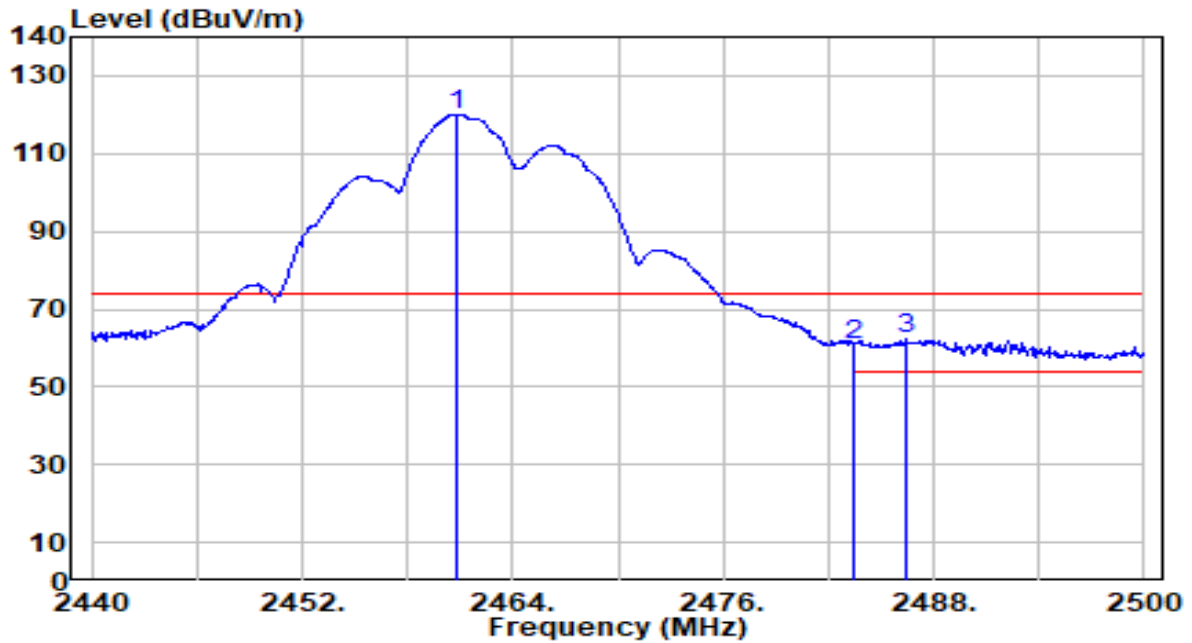

No	Frequency (MHz)	Reading (dBUV)	C.F (dB/m)	Measurement (dBUV/m)	Margin (dB)	Limit (dBUV/m)	Height (cm)	Angle (deg)	Remark (QP/PK/AV)
1	2460.820	89.58	30.56	120.13	N/A	N/A	305	264	Peak
2	2483.500	30.35	30.59	60.94	-13.06	74.00	305	264	Peak
3	* 2486.440	31.63	30.59	62.22	-11.78	74.00	305	264	Peak

Note:

1. " \*", means this data is the worst emission level.
2. C.F (Correction Factor) = Antenna Factor (dB/m)+ Cable Loss (dB).
3. Measurement (dBUV/m) = Reading(dBUV) + C.F (Correction Factor).
4. The emission levels of other frequencies are very lower than the limit and not show in test report.

EUT	BE5000 Whole Home Mesh Wi-Fi 7 System	Date of Test	2024-03-23
Factor	DRH18-E	Temp. / Humidity	24°C /60%
Polarity	Horizontal	Site / Test Engineer	AC2 / Marvin
Test Mode	802.11b_TX_CH 11_ANT 0+1	Test Voltage	AC 120V/60Hz

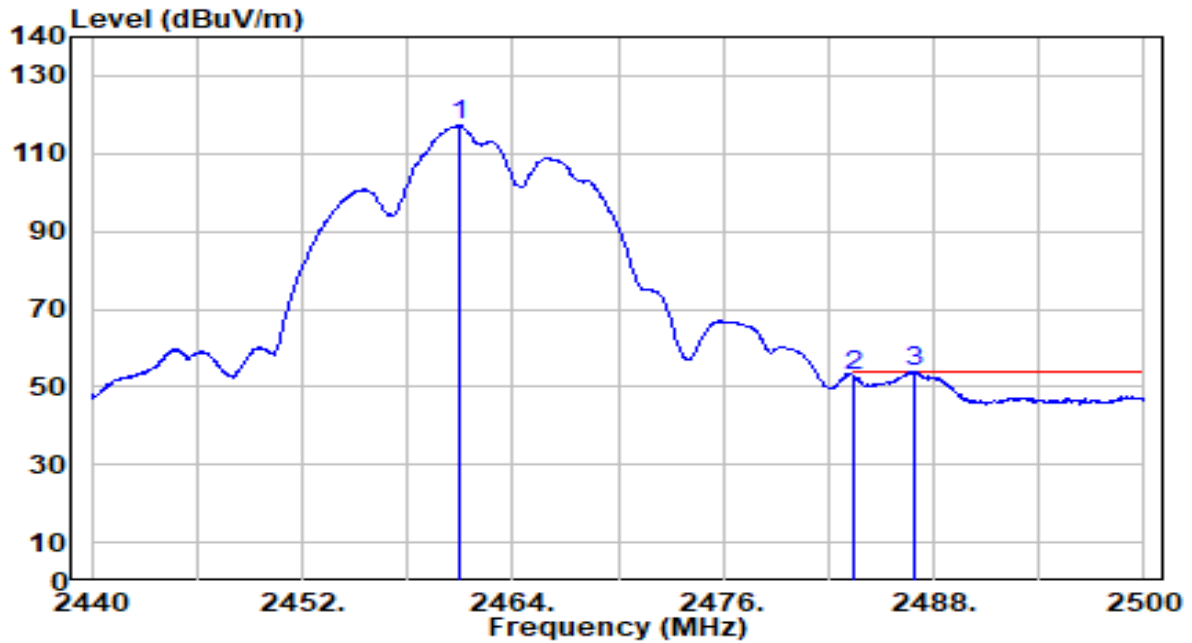

No	Frequency (MHz)	Reading (dBUV)	C.F (dB/m)	Measurement (dBUV/m)	Margin (dB)	Limit (dBUV/m)	Height (cm)	Angle (deg)	Remark (QP/PK/AV)
1	2461.000	86.59	30.56	117.15	N/A	N/A	305	264	Average
2	2483.500	22.04	30.59	52.63	-1.37	54.00	305	264	Average
3	* 2486.860	23.29	30.59	53.88	-0.12	54.00	305	264	Average

Note:

1. " \*", means this data is the worst emission level.
2. C.F (Correction Factor) = Antenna Factor (dB/m)+ Cable Loss (dB).
3. Measurement (dBUV/m) = Reading(dBUV) + C.F (Correction Factor).
4. The emission levels of other frequencies are very lower than the limit and not show in test report.

EUT	BE5000 Whole Home Mesh Wi-Fi 7 System	Date of Test	2024-03-23
Factor	DRH18-E	Temp. / Humidity	24°C /60%
Polarity	Vertical	Site / Test Engineer	AC2 / Marvin
Test Mode	802.11b_TX_CH 11_ANT 0+1	Test Voltage	AC 120V/60Hz

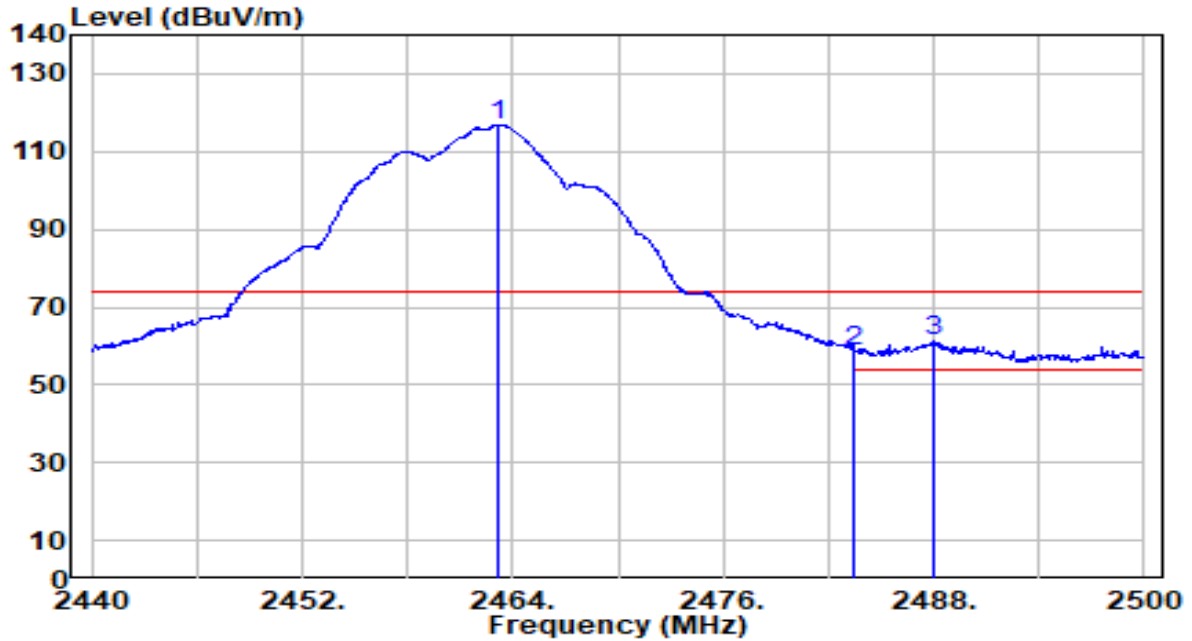

No	Frequency (MHz)	Reading (dBUV)	C.F (dB/m)	Measurement (dBUV/m)	Margin (dB)	Limit (dBUV/m)	Height (cm)	Angle (deg)	Remark (QP/PK/AV)
1	2463.160	86.39	30.56	116.95	N/A	N/A	300	183	Peak
2	2483.500	28.08	30.59	58.66	-15.34	74.00	300	183	Peak
3	* 2487.940	30.64	30.59	61.23	-12.77	74.00	300	183	Peak

Note:

1. " \*", means this data is the worst emission level.
2. C.F (Correction Factor) = Antenna Factor (dB/m)+ Cable Loss (dB).
3. Measurement (dBUV/m) = Reading(dBUV) + C.F (Correction Factor).
4. The emission levels of other frequencies are very lower than the limit and not show in test report.

EUT	BE5000 Whole Home Mesh Wi-Fi 7 System	Date of Test	2024-03-23
Factor	DRH18-E	Temp. / Humidity	24°C /60%
Polarity	Vertical	Site / Test Engineer	AC2 / Marvin
Test Mode	802.11b_TX_CH 11_ANT 0+1	Test Voltage	AC 120V/60Hz

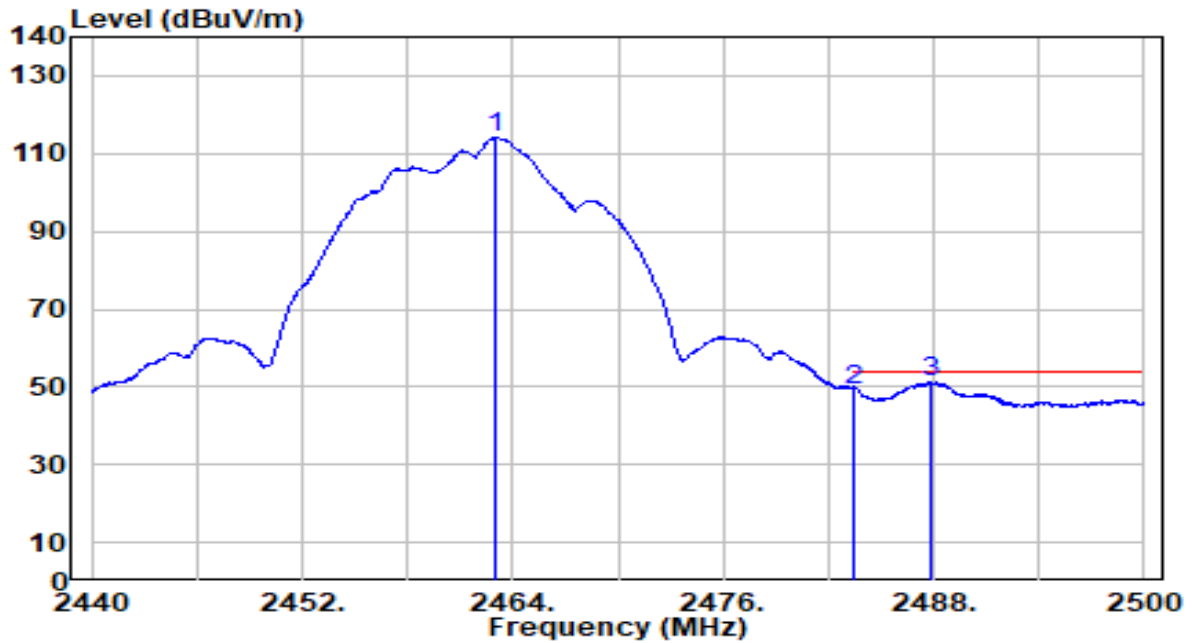

No	Frequency (MHz)	Reading (dBUV)	C.F (dB/m)	Measurement (dBUV/m)	Margin (dB)	Limit (dBUV/m)	Height (cm)	Angle (deg)	Remark (QP/PK/AV)
1	2462.980	83.35	30.56	113.92	N/A	N/A	300	183	Average
2	2483.500	18.65	30.59	49.24	-4.76	54.00	300	183	Average
3	* 2487.820	20.47	30.59	51.07	-2.93	54.00	300	183	Average

Note:

1. " \*", means this data is the worst emission level.
2. C.F (Correction Factor) = Antenna Factor (dB/m)+ Cable Loss (dB).
3. Measurement (dBUV/m) = Reading(dBUV) + C.F (Correction Factor).
4. The emission levels of other frequencies are very lower than the limit and not show in test report.

EUT	BE5000 Whole Home Mesh Wi-Fi 7 System	Date of Test	2024-03-23
Factor	DRH18-E	Temp. / Humidity	24°C /60%
Polarity	Horizontal	Site / Test Engineer	AC2 / Marvin
Test Mode	802.11g_TX_CH 1_ANT 0+1	Test Voltage	AC 120V/60Hz

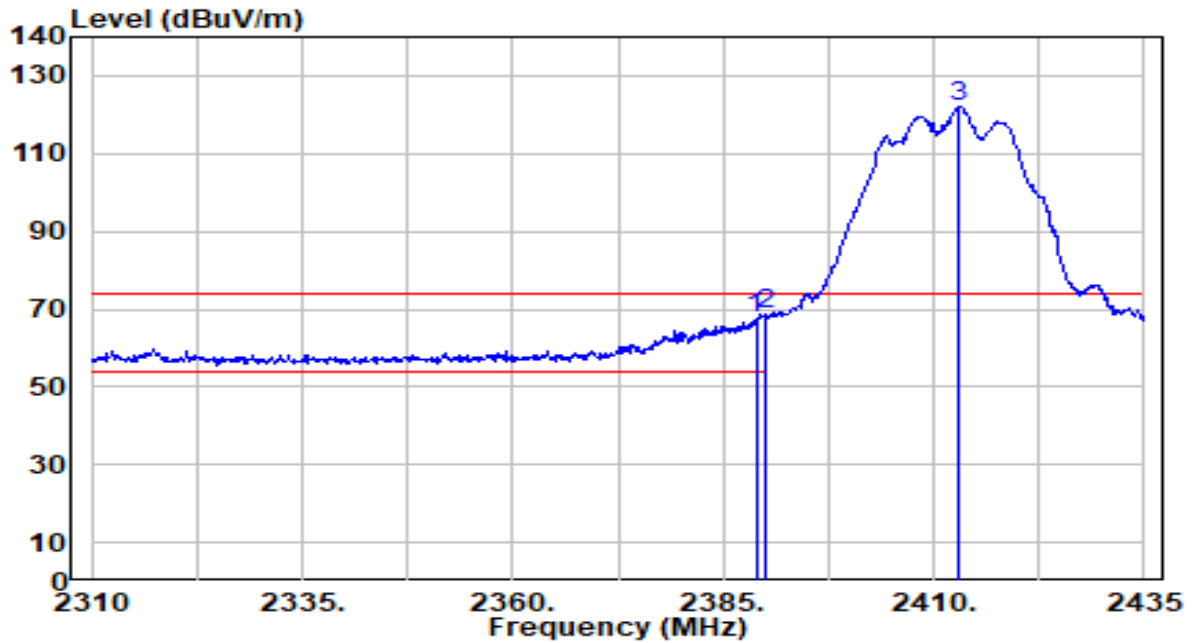

No	Frequency (MHz)	Reading (dBuV)	C.F (dB/m)	Measurement (dBuV/m)	Margin (dB)	Limit (dBuV/m)	Height (cm)	Angle (deg)	Remark (QP/PK/AV)
1	2388.875	37.14	30.44	67.58	-6.42	74.00	319	262	Peak
2	* 2390.000	38.14	30.45	68.59	-5.41	74.00	319	262	Peak
3	2412.875	91.49	30.49	121.98	N/A	N/A	319	262	Peak

Note:

1. " \*", means this data is the worst emission level.
2. C.F (Correction Factor) = Antenna Factor (dB/m)+ Cable Loss (dB).
3. Measurement (dBuV/m) = Reading(dBuV) + C.F (Correction Factor).
4. The emission levels of other frequencies are very lower than the limit and not show in test report.

EUT	BE5000 Whole Home Mesh Wi-Fi 7 System	Date of Test	2024-03-23
Factor	DRH18-E	Temp. / Humidity	24°C /60%
Polarity	Horizontal	Site / Test Engineer	AC2 / Marvin
Test Mode	802.11g_TX_CH 1_ANT 0+1	Test Voltage	AC 120V/60Hz

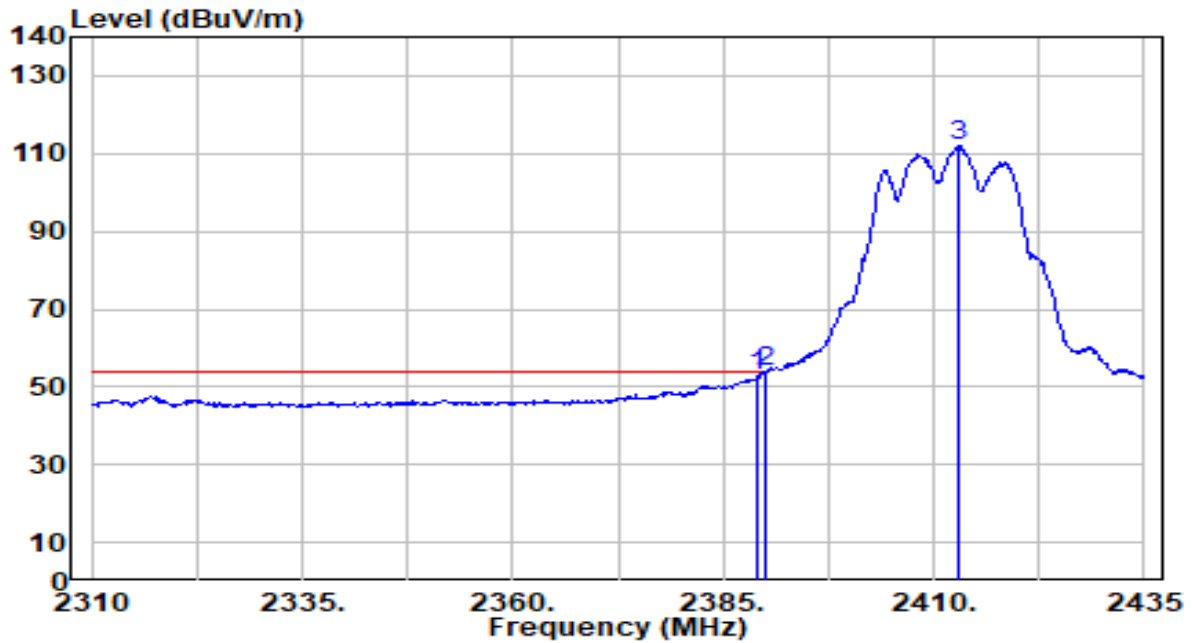

No	Frequency (MHz)	Reading (dBUV)	C.F (dB/m)	Measurement (dBUV/m)	Margin (dB)	Limit (dBUV/m)	Height (cm)	Angle (deg)	Remark (QP/PK/AV)
1	2389.000	22.37	30.44	52.81	-1.19	54.00	319	262	Average
2	* 2390.000	23.37	30.45	53.81	-0.19	54.00	319	262	Average
3	2413.000	81.61	30.49	112.10	N/A	N/A	319	262	Average

Note:

1. " \*", means this data is the worst emission level.
2. C.F (Correction Factor) = Antenna Factor (dB/m)+ Cable Loss (dB).
3. Measurement (dBUV/m) = Reading(dBUV) + C.F (Correction Factor).
4. The emission levels of other frequencies are very lower than the limit and not show in test report.

EUT	BE5000 Whole Home Mesh Wi-Fi 7 System	Date of Test	2024-03-23
Factor	DRH18-E	Temp. / Humidity	24°C /60%
Polarity	Vertical	Site / Test Engineer	AC2 / Marvin
Test Mode	802.11g_TX_CH 1_ANT 0+1	Test Voltage	AC 120V/60Hz

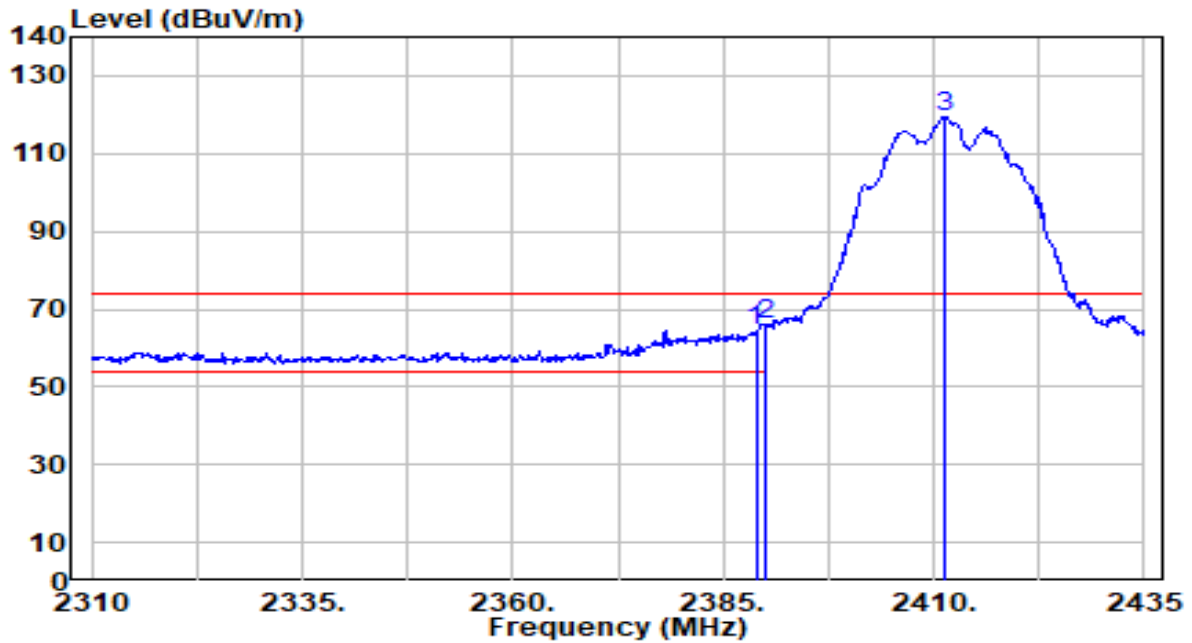

No	Frequency (MHz)	Reading (dBUV)	C.F (dB/m)	Measurement (dBUV/m)	Margin (dB)	Limit (dBUV/m)	Height (cm)	Angle (deg)	Remark (QP/PK/AV)
1	2388.875	34.03	30.44	64.48	-9.52	74.00	206	177	Peak
2	* 2390.000	35.54	30.45	65.99	-8.01	74.00	206	177	Peak
3	2411.250	88.95	30.49	119.44	N/A	N/A	206	177	Peak

Note:

1. " \*", means this data is the worst emission level.
2. C.F (Correction Factor) = Antenna Factor (dB/m)+ Cable Loss (dB).
3. Measurement (dBUV/m) = Reading(dBUV) + C.F (Correction Factor).
4. The emission levels of other frequencies are very lower than the limit and not show in test report.

EUT	BE5000 Whole Home Mesh Wi-Fi 7 System	Date of Test	2024-03-23
Factor	DRH18-E	Temp. / Humidity	24°C /60%
Polarity	Vertical	Site / Test Engineer	AC2 / Marvin
Test Mode	802.11g_TX_CH 1_ANT 0+1	Test Voltage	AC 120V/60Hz

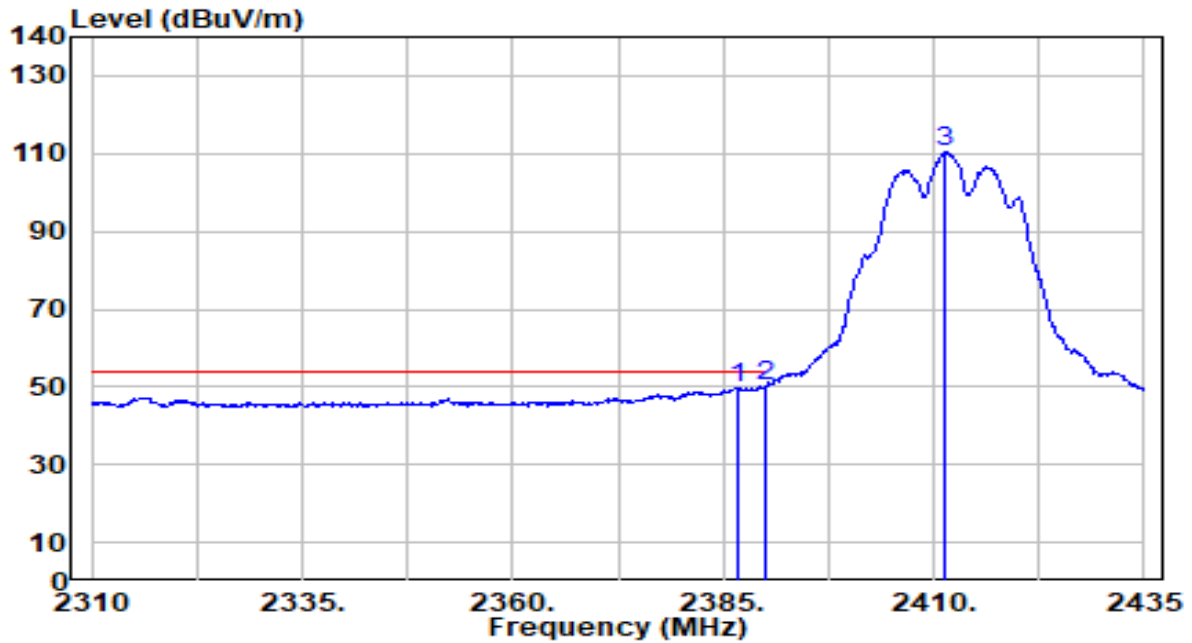

No	Frequency (MHz)	Reading (dBuV)	C.F (dB/m)	Measurement (dBuV/m)	Margin (dB)	Limit (dBuV/m)	Height (cm)	Angle (deg)	Remark (QP/PK/AV)
1	2386.625	19.48	30.44	49.92	-4.08	54.00	206	177	Average
2	* 2390.000	19.89	30.45	50.34	-3.66	54.00	206	177	Average
3	2411.250	79.96	30.49	110.45	N/A	N/A	206	177	Average

Note:

1. " \*", means this data is the worst emission level.
2. C.F (Correction Factor) = Antenna Factor (dB/m)+ Cable Loss (dB).
3. Measurement (dBuV/m) = Reading(dBuV) + C.F (Correction Factor).
4. The emission levels of other frequencies are very lower than the limit and not show in test report.



EUT	BE5000 Whole Home Mesh Wi-Fi 7 System	Date of Test	2024-03-23
Factor	DRH18-E	Temp. / Humidity	24°C /60%
Polarity	Horizontal	Site / Test Engineer	AC2 / Marvin
Test Mode	802.11g_TX_CH 6_ANT 0+1	Test Voltage	AC 120V/60Hz

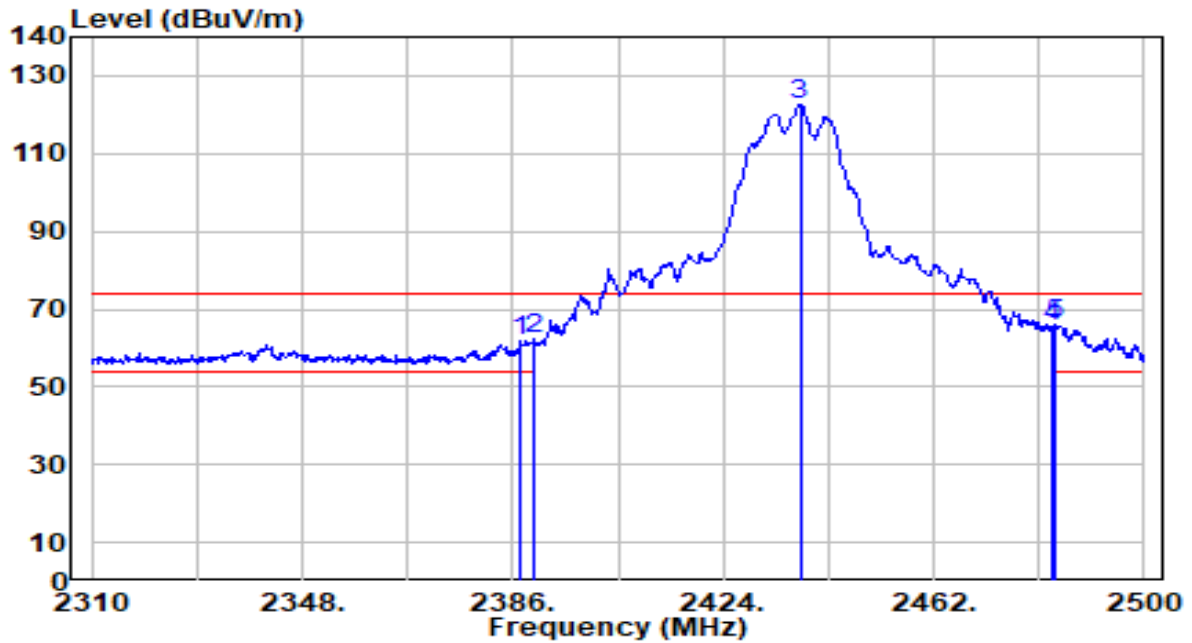

No	Frequency (MHz)	Reading (dBUV)	C.F (dB/m)	Measurement (dBUV/m)	Margin (dB)	Limit (dBUV/m)	Height (cm)	Angle (deg)	Remark (QP/PK/AV)
1	2387.520	31.48	30.44	61.92	-12.08	74.00	100	86	Peak
2	2390.000	31.77	30.45	62.22	-11.78	74.00	100	86	Peak
3	2437.870	91.96	30.53	122.49	N/A	N/A	100	86	Peak
4	2483.500	34.98	30.59	65.57	-8.43	74.00	100	86	Peak
5	* 2484.040	35.30	30.59	65.89	-8.11	74.00	100	86	Peak

Note:

1. " \*", means this data is the worst emission level.
2. C.F (Correction Factor) = Antenna Factor (dB/m)+ Cable Loss (dB).
3. Measurement (dBUV/m) = Reading(dBUV) + C.F (Correction Factor).
4. The emission levels of other frequencies are very lower than the limit and not show in test report.

EUT	BE5000 Whole Home Mesh Wi-Fi 7 System	Date of Test	2024-03-23
Factor	DRH18-E	Temp. / Humidity	24°C /60%
Polarity	Horizontal	Site / Test Engineer	AC2 / Marvin
Test Mode	802.11g_TX_CH 6_ANT 0+1	Test Voltage	AC 120V/60Hz

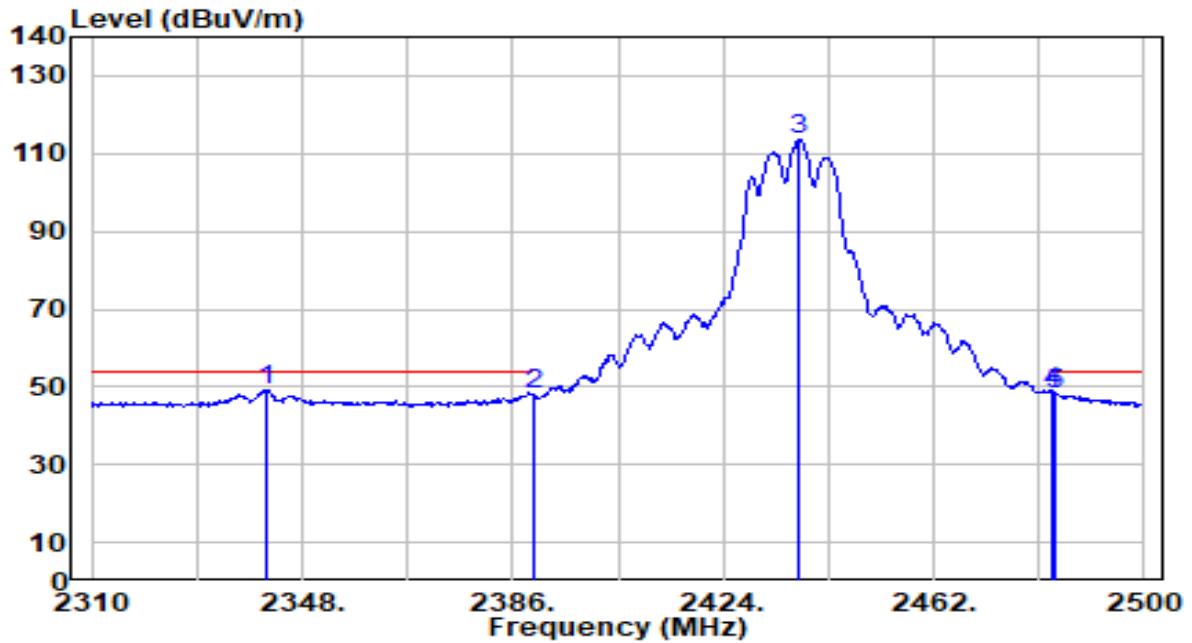

No	Frequency (MHz)	Reading (dBuV)	C.F (dB/m)	Measurement (dBuV/m)	Margin (dB)	Limit (dBuV/m)	Height (cm)	Angle (deg)	Remark (QP/PK/AV)
1	* 2341.730	18.92	30.31	49.24	-4.76	54.00	100	86	Average
2	2390.000	17.37	30.45	47.82	-6.18	54.00	100	86	Average
3	2437.490	83.22	30.53	113.74	N/A	N/A	100	86	Average
4	2483.500	18.23	30.59	48.82	-5.18	54.00	100	86	Average
5	2484.040	17.61	30.59	48.20	-5.80	54.00	100	86	Average

Note:

- " \*", means this data is the worst emission level.
- C.F (Correction Factor) = Antenna Factor (dB/m)+ Cable Loss (dB).
- Measurement (dBuV/m) = Reading(dBuV) + C.F (Correction Factor).
- The emission levels of other frequencies are very lower than the limit and not show in test report.

EUT	BE5000 Whole Home Mesh Wi-Fi 7 System	Date of Test	2024-03-23
Factor	DRH18-E	Temp. / Humidity	24°C /60%
Polarity	Vertical	Site / Test Engineer	AC2 / Marvin
Test Mode	802.11g_TX_CH 6_ANT 0+1	Test Voltage	AC 120V/60Hz

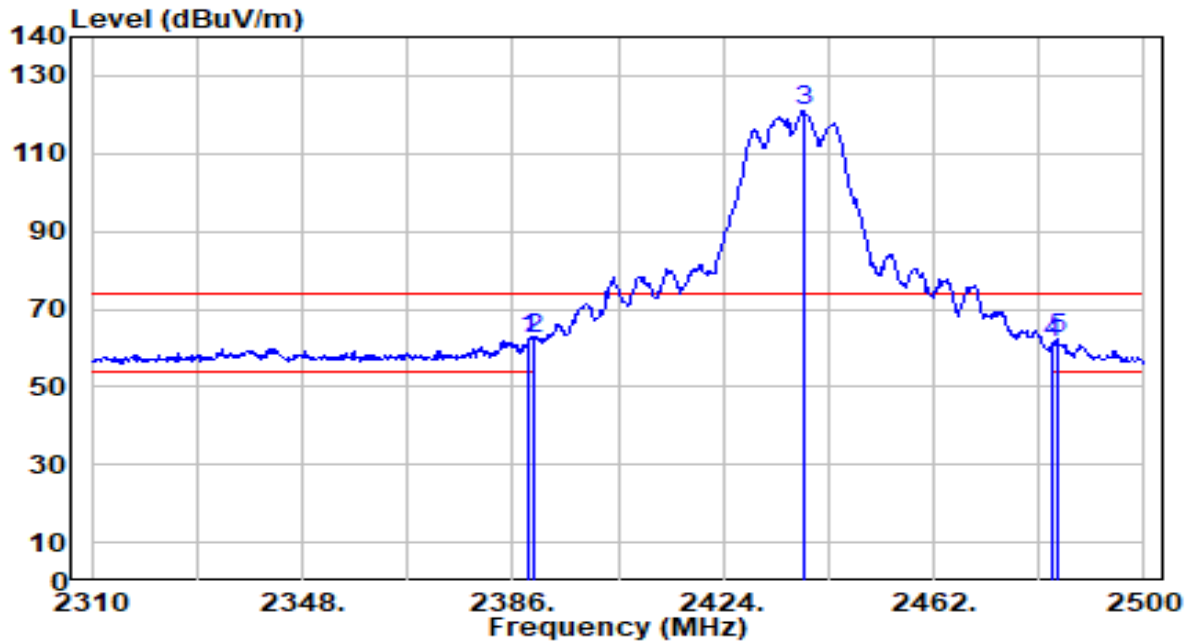

No	Frequency (MHz)	Reading (dBUV)	C.F (dB/m)	Measurement (dBUV/m)	Margin (dB)	Limit (dBUV/m)	Height (cm)	Angle (deg)	Remark (QP/PK/AV)	
1	*	2389.040	31.88	30.44	62.33	-11.67	74.00	200	180	Peak
2		2390.000	31.83	30.45	62.28	-11.72	74.00	200	180	Peak
3		2438.440	90.23	30.53	120.76	N/A	N/A	200	180	Peak
4		2483.500	30.64	30.59	61.23	-12.77	74.00	200	180	Peak
5		2484.230	31.49	30.59	62.08	-11.92	74.00	200	180	Peak

Note:

- "\*" means this data is the worst emission level.
- C.F (Correction Factor) = Antenna Factor (dB/m)+ Cable Loss (dB).
- Measurement (dBUV/m) = Reading(dBUV) + C.F (Correction Factor).
- The emission levels of other frequencies are very lower than the limit and not show in test report.

EUT	BE5000 Whole Home Mesh Wi-Fi 7 System	Date of Test	2024-03-23
Factor	DRH18-E	Temp. / Humidity	24°C /60%
Polarity	Vertical	Site / Test Engineer	AC2 / Marvin
Test Mode	802.11g_TX_CH 6_ANT 0+1	Test Voltage	AC 120V/60Hz

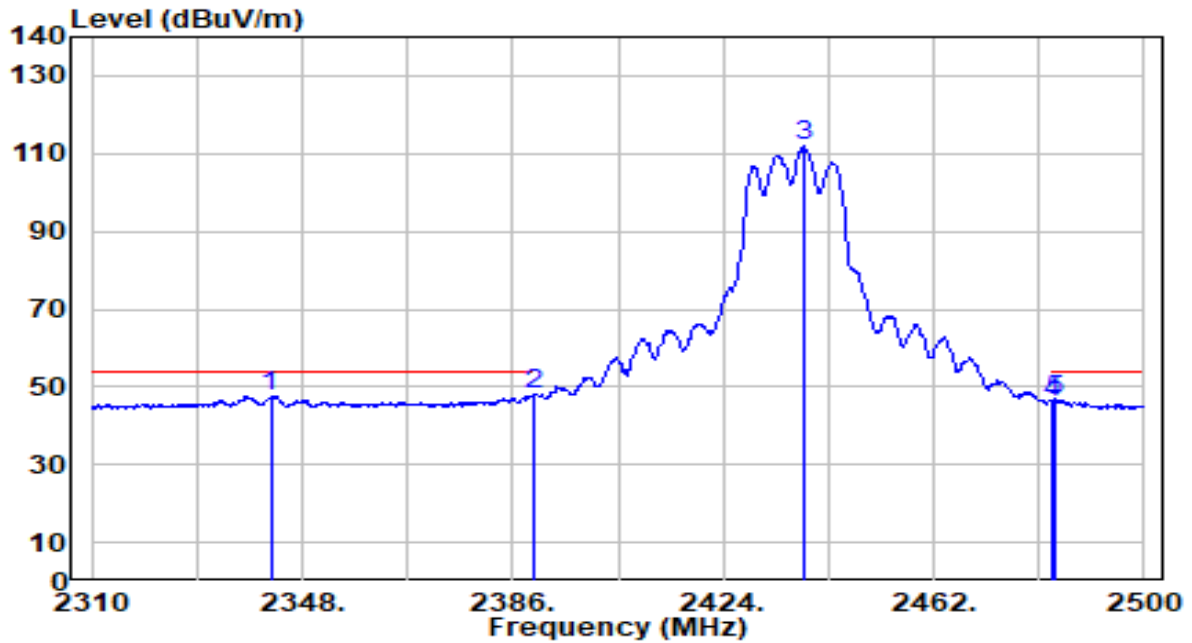

No	Frequency (MHz)	Reading (dBuV)	C.F (dB/m)	Measurement (dBuV/m)	Margin (dB)	Limit (dBuV/m)	Height (cm)	Angle (deg)	Remark (QP/PK/AV)
1	2342.300	17.47	30.31	47.78	-6.22	54.00	200	180	Average
2	* 2390.000	17.74	30.45	48.19	-5.81	54.00	200	180	Average
3	2438.440	81.33	30.53	111.86	N/A	N/A	200	180	Average
4	2483.500	15.61	30.59	46.20	-7.80	54.00	200	180	Average
5	2484.040	16.08	30.59	46.67	-7.33	54.00	200	180	Average

Note:

- "\*" means this data is the worst emission level.
- C.F (Correction Factor) = Antenna Factor (dB/m)+ Cable Loss (dB).
- Measurement (dBuV/m) = Reading(dBuV) + C.F (Correction Factor).
- The emission levels of other frequencies are very lower than the limit and not show in test report.

EUT	BE5000 Whole Home Mesh Wi-Fi 7 System	Date of Test	2024-03-23
Factor	DRH18-E	Temp. / Humidity	24°C /60%
Polarity	Horizontal	Site / Test Engineer	AC2 / Marvin
Test Mode	802.11g_TX_CH 11_ANT 0+1	Test Voltage	AC 120V/60Hz

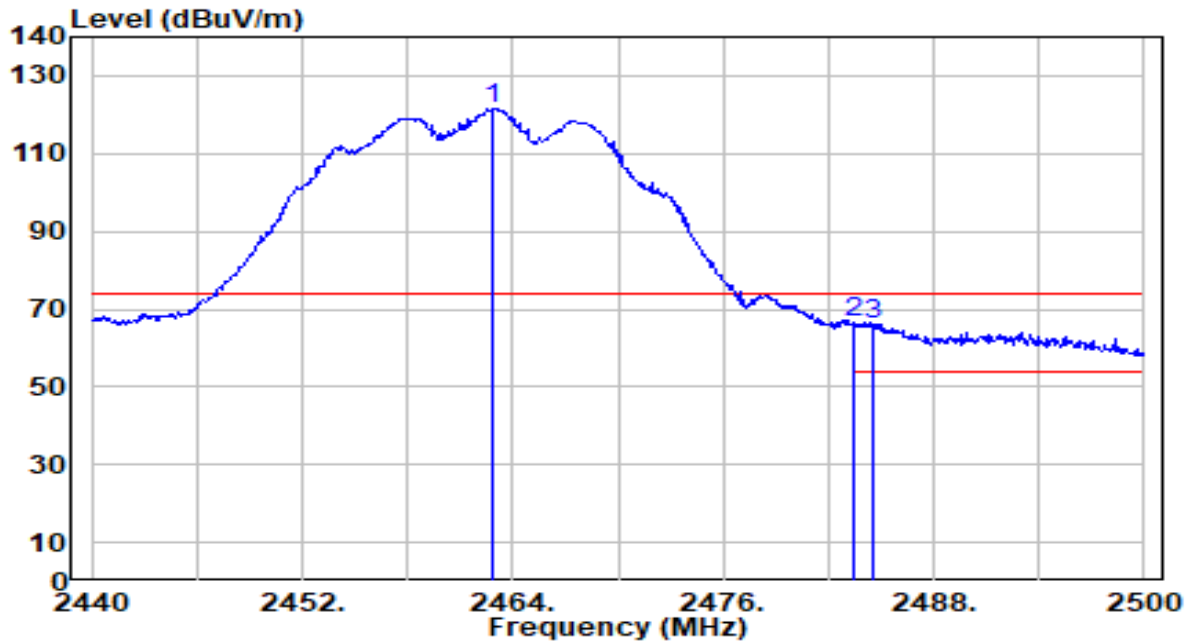

No	Frequency (MHz)	Reading (dBUV)	C.F (dB/m)	Measurement (dBUV/m)	Margin (dB)	Limit (dBUV/m)	Height (cm)	Angle (deg)	Remark (QP/PK/AV)
1	2462.920	90.82	30.56	121.38	N/A	N/A	307	264	Peak
2	* 2483.500	36.06	30.59	66.64	-7.36	74.00	307	264	Peak
3	2484.580	35.64	30.59	66.23	-7.77	74.00	307	264	Peak

Note:

1. " \*", means this data is the worst emission level.
2. C.F (Correction Factor) = Antenna Factor (dB/m)+ Cable Loss (dB).
3. Measurement (dBUV/m) = Reading(dBUV) + C.F (Correction Factor).
4. The emission levels of other frequencies are very lower than the limit and not show in test report.

EUT	BE5000 Whole Home Mesh Wi-Fi 7 System	Date of Test	2024-03-23
Factor	DRH18-E	Temp. / Humidity	24°C /60%
Polarity	Horizontal	Site / Test Engineer	AC2 / Marvin
Test Mode	802.11g_TX_CH 11_ANT 0+1	Test Voltage	AC 120V/60Hz

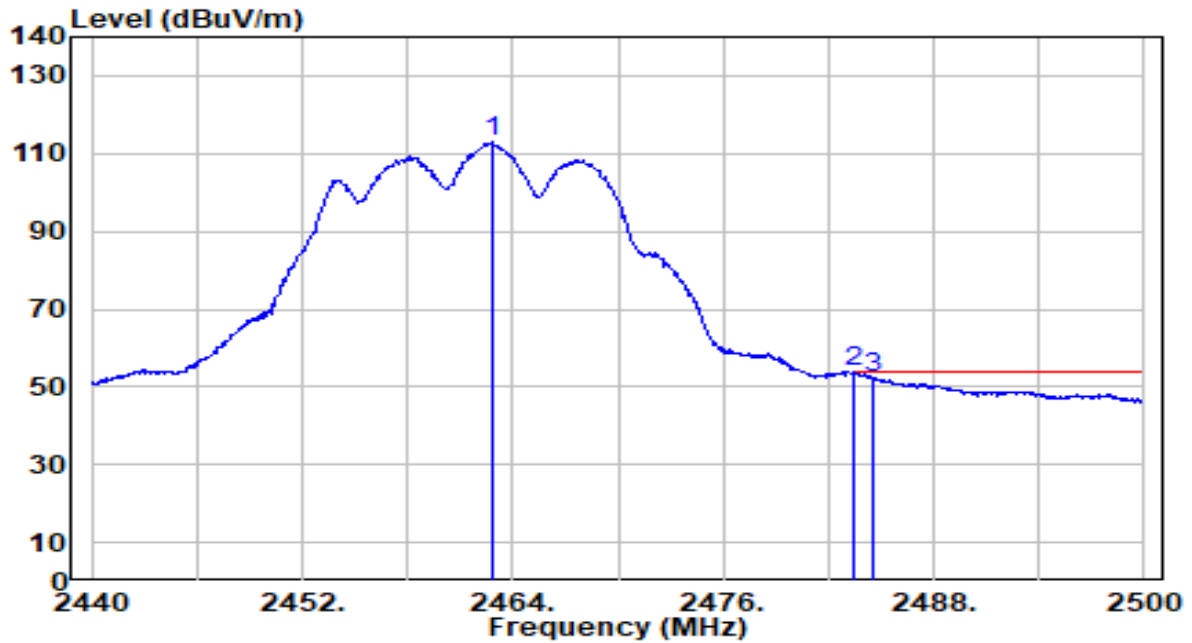

No	Frequency (MHz)	Reading (dBUV)	C.F (dB/m)	Measurement (dBUV/m)	Margin (dB)	Limit (dBUV/m)	Height (cm)	Angle (deg)	Remark (QP/PK/AV)
1	2462.800	82.25	30.56	112.81	N/A	N/A	307	264	Average
2	* 2483.500	23.22	30.59	53.81	-0.19	54.00	307	264	Average
3	2484.520	21.84	30.59	52.43	-1.57	54.00	307	264	Average

Note:

1. " \*", means this data is the worst emission level.
2. C.F (Correction Factor) = Antenna Factor (dB/m)+ Cable Loss (dB).
3. Measurement (dBUV/m) = Reading(dBUV) + C.F (Correction Factor).
4. The emission levels of other frequencies are very lower than the limit and not show in test report.

EUT	BE5000 Whole Home Mesh Wi-Fi 7 System	Date of Test	2024-03-23
Factor	DRH18-E	Temp. / Humidity	24°C /60%
Polarity	Vertical	Site / Test Engineer	AC2 / Marvin
Test Mode	802.11g_TX_CH 11_ANT 0+1	Test Voltage	AC 120V/60Hz

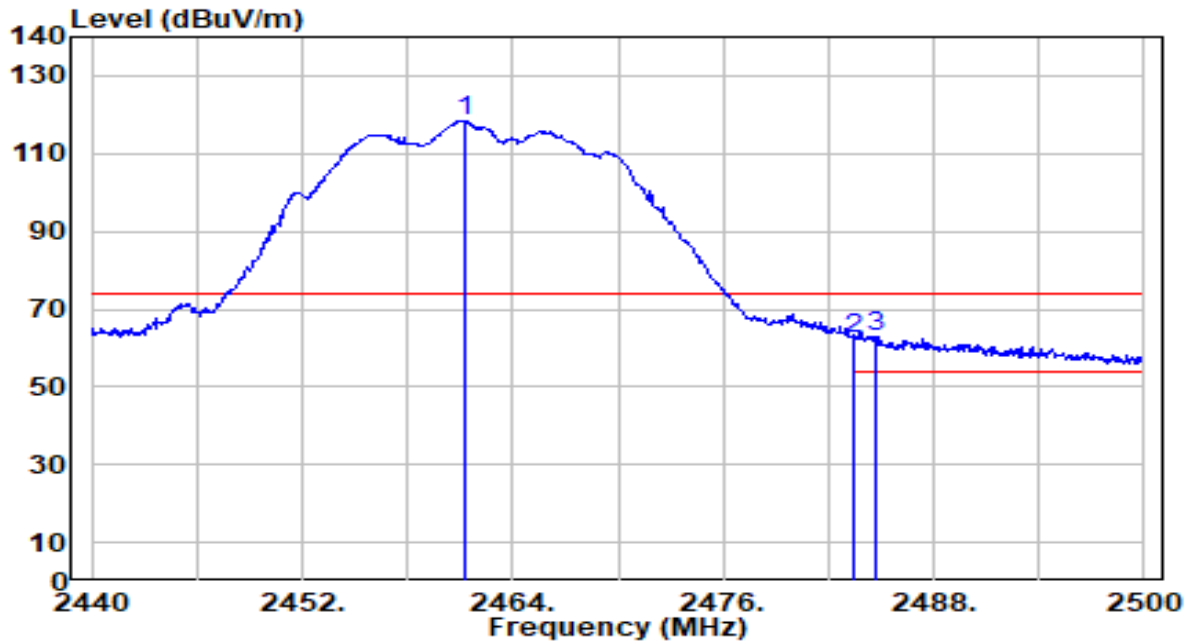

No	Frequency (MHz)	Reading (dBuV)	C.F (dB/m)	Measurement (dBuV/m)	Margin (dB)	Limit (dBuV/m)	Height (cm)	Angle (deg)	Remark (QP/PK/AV)
1	2461.240	87.73	30.56	118.28	N/A	N/A	300	183	Peak
2	2483.500	31.51	30.59	62.10	-11.90	74.00	300	183	Peak
3	* 2484.640	32.40	30.59	62.99	-11.01	74.00	300	183	Peak

Note:

1. " \*", means this data is the worst emission level.
2. C.F (Correction Factor) = Antenna Factor (dB/m)+ Cable Loss (dB).
3. Measurement (dBuV/m) = Reading(dBuV) + C.F (Correction Factor).
4. The emission levels of other frequencies are very lower than the limit and not show in test report.

EUT	BE5000 Whole Home Mesh Wi-Fi 7 System	Date of Test	2024-03-23
Factor	DRH18-E	Temp. / Humidity	24°C /60%
Polarity	Vertical	Site / Test Engineer	AC2 / Marvin
Test Mode	802.11g_TX_CH 11_ANT 0+1	Test Voltage	AC 120V/60Hz

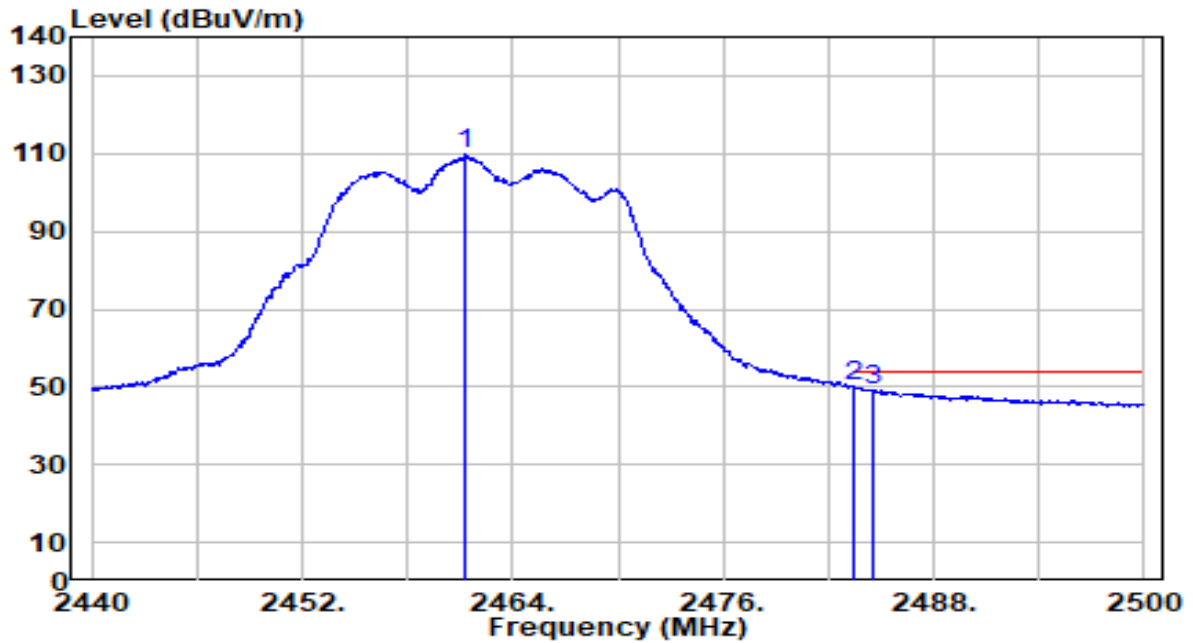

No	Frequency (MHz)	Reading (dBUV)	C.F (dB/m)	Measurement (dBUV/m)	Margin (dB)	Limit (dBUV/m)	Height (cm)	Angle (deg)	Remark (QP/PK/AV)
1	2461.300	79.37	30.56	109.93	N/A	N/A	300	183	Average
2	* 2483.500	19.50	30.59	50.09	-3.91	54.00	300	183	Average
3	2484.520	18.50	30.59	49.09	-4.91	54.00	300	183	Average

Note:

1. " \*", means this data is the worst emission level.
2. C.F (Correction Factor) = Antenna Factor (dB/m)+ Cable Loss (dB).
3. Measurement (dBUV/m) = Reading(dBUV) + C.F (Correction Factor).
4. The emission levels of other frequencies are very lower than the limit and not show in test report.



EUT	BE5000 Whole Home Mesh Wi-Fi 7 System	Date of Test	2024-03-23
Factor	DRH18-E	Temp. / Humidity	24°C /60%
Polarity	Horizontal	Site / Test Engineer	AC2 / Marvin
Test Mode	802.11n-20MHz_TX_CH 1_ANT 0+1	Test Voltage	AC 120V/60Hz

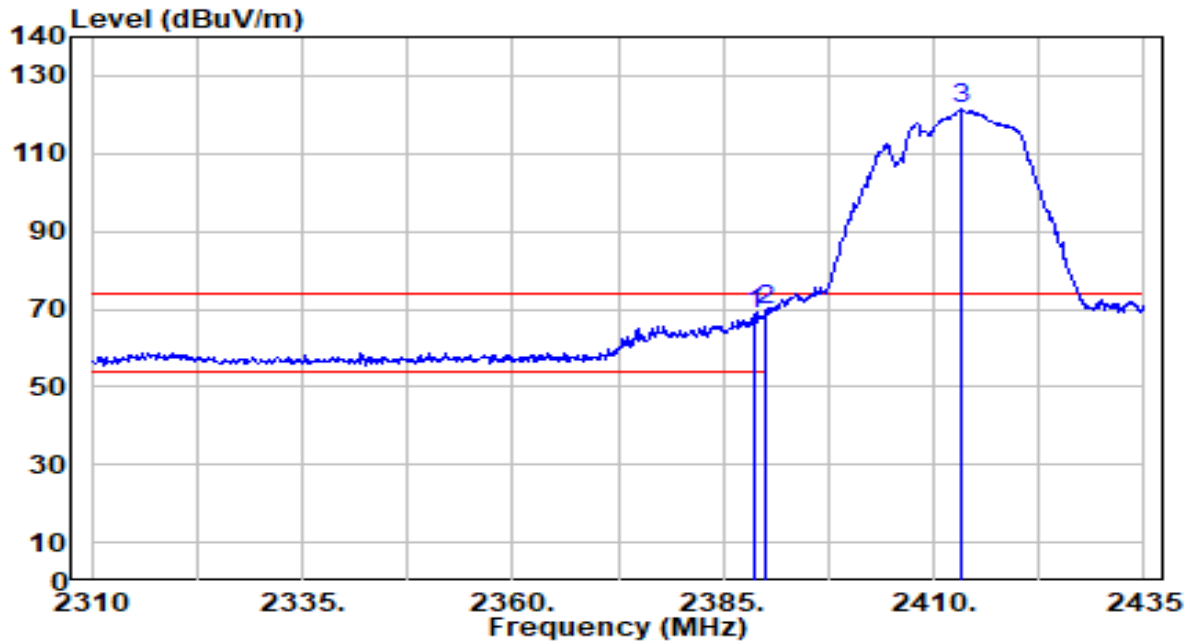

No	Frequency (MHz)	Reading (dBuV)	C.F (dB/m)	Measurement (dBuV/m)	Margin (dB)	Limit (dBuV/m)	Height (cm)	Angle (deg)	Remark (QP/PK/AV)
1	2388.625	38.17	30.44	68.61	-5.39	74.00	318	262	Peak
2	* 2390.000	39.05	30.45	69.50	-4.50	74.00	318	262	Peak
3	2413.375	90.77	30.49	121.27	N/A	N/A	318	262	Peak

Note:

1. " \*", means this data is the worst emission level.
2. C.F (Correction Factor) = Antenna Factor (dB/m)+ Cable Loss (dB).
3. Measurement (dBuV/m) = Reading(dBuV) + C.F (Correction Factor).
4. The emission levels of other frequencies are very lower than the limit and not show in test report.

EUT	BE5000 Whole Home Mesh Wi-Fi 7 System	Date of Test	2024-03-23
Factor	DRH18-E	Temp. / Humidity	24°C /60%
Polarity	Horizontal	Site / Test Engineer	AC2 / Marvin
Test Mode	802.11n-20MHz_TX_CH 1_ANT 0+1	Test Voltage	AC 120V/60Hz

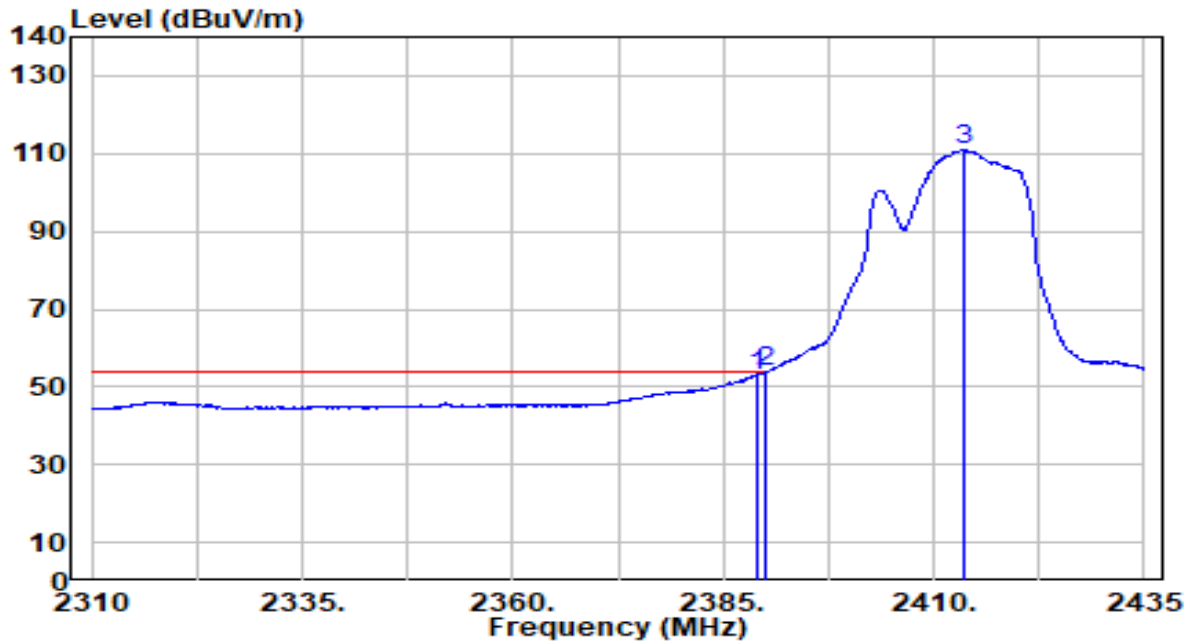

No	Frequency (MHz)	Reading (dBuV)	C.F (dB/m)	Measurement (dBuV/m)	Margin (dB)	Limit (dBuV/m)	Height (cm)	Angle (deg)	Remark (QP/PK/AV)
1	2389.000	22.45	30.44	52.89	-1.11	54.00	318	262	Average
2	* 2390.000	23.40	30.45	53.85	-0.15	54.00	318	262	Average
3	2413.625	80.51	30.49	111.01	N/A	N/A	318	262	Average

Note:

1. " \*", means this data is the worst emission level.
2. C.F (Correction Factor) = Antenna Factor (dB/m)+ Cable Loss (dB).
3. Measurement (dBuV/m) = Reading(dBuV) + C.F (Correction Factor).
4. The emission levels of other frequencies are very lower than the limit and not show in test report.

EUT	BE5000 Whole Home Mesh Wi-Fi 7 System	Date of Test	2024-03-23
Factor	DRH18-E	Temp. / Humidity	24°C /60%
Polarity	Vertical	Site / Test Engineer	AC2 / Marvin
Test Mode	802.11n-20MHz_TX_CH 1_ANT 0+1	Test Voltage	AC 120V/60Hz

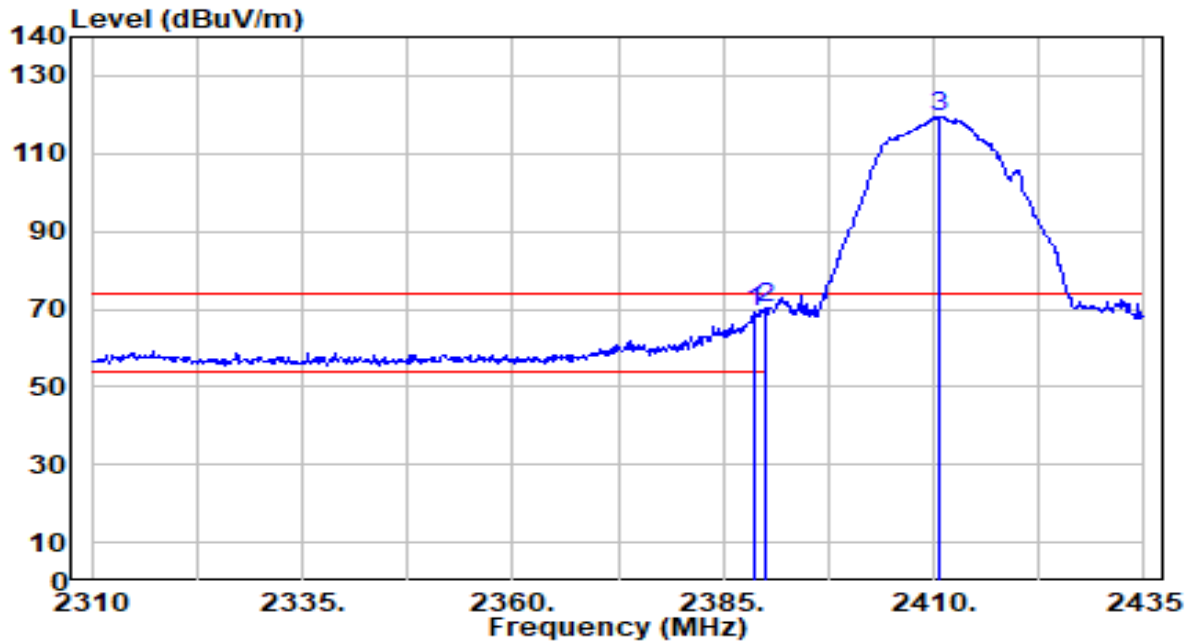

No	Frequency (MHz)	Reading (dBuV)	C.F (dB/m)	Measurement (dBuV/m)	Margin (dB)	Limit (dBuV/m)	Height (cm)	Angle (deg)	Remark (QP/PK/AV)
1	2388.750	38.89	30.44	69.33	-4.67	74.00	204	177	Peak
2	* 2390.000	39.58	30.45	70.03	-3.97	74.00	204	177	Peak
3	2410.750	89.11	30.49	119.60	N/A	N/A	204	177	Peak

Note:

1. " \*", means this data is the worst emission level.
2. C.F (Correction Factor) = Antenna Factor (dB/m)+ Cable Loss (dB).
3. Measurement (dBuV/m) = Reading(dBuV) + C.F (Correction Factor).
4. The emission levels of other frequencies are very lower than the limit and not show in test report.

EUT	BE5000 Whole Home Mesh Wi-Fi 7 System	Date of Test	2024-03-23
Factor	DRH18-E	Temp. / Humidity	24°C /60%
Polarity	Vertical	Site / Test Engineer	AC2 / Marvin
Test Mode	802.11n-20MHz_TX_CH 1_ANT 0+1	Test Voltage	AC 120V/60Hz

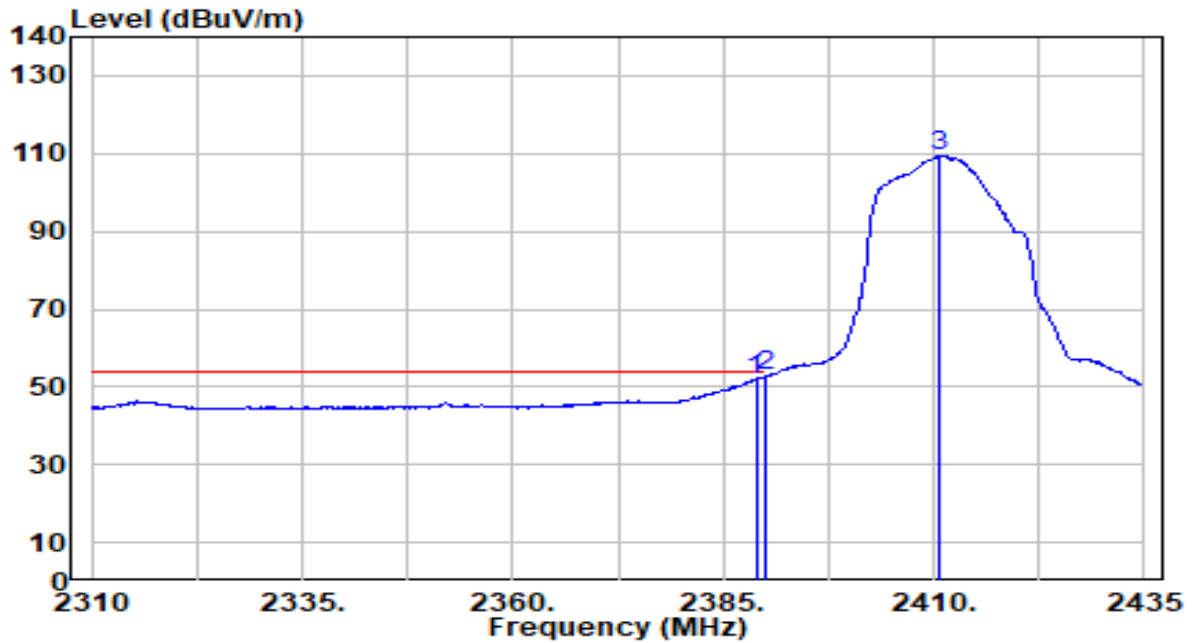

No	Frequency (MHz)	Reading (dBuV)	C.F (dB/m)	Measurement (dBuV/m)	Margin (dB)	Limit (dBuV/m)	Height (cm)	Angle (deg)	Remark (QP/PK/AV)
1	2388.875	21.58	30.44	52.03	-1.97	54.00	204	177	Average
2	* 2390.000	22.20	30.45	52.65	-1.35	54.00	204	177	Average
3	2410.500	78.97	30.49	109.46	N/A	N/A	204	177	Average

Note:

1. " \*", means this data is the worst emission level.
2. C.F (Correction Factor) = Antenna Factor (dB/m)+ Cable Loss (dB).
3. Measurement (dBuV/m) = Reading(dBuV) + C.F (Correction Factor).
4. The emission levels of other frequencies are very lower than the limit and not show in test report.

EUT	BE5000 Whole Home Mesh Wi-Fi 7 System	Date of Test	2024-03-23
Factor	DRH18-E	Temp. / Humidity	24°C /60%
Polarity	Horizontal	Site / Test Engineer	AC2 / Marvin
Test Mode	802.11n-20MHz_TX_CH 6_ANT 0+1	Test Voltage	AC 120V/60Hz

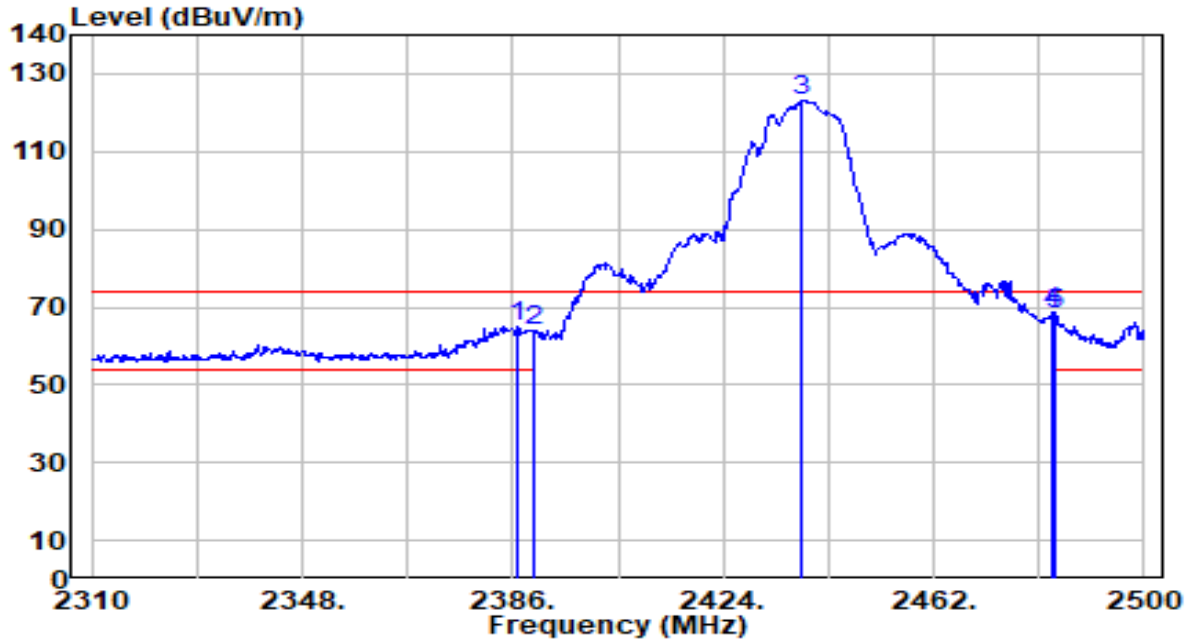

No	Frequency (MHz)	Reading (dBuV)	C.F (dB/m)	Measurement (dBuV/m)	Margin (dB)	Limit (dBuV/m)	Height (cm)	Angle (deg)	Remark (QP/PK/AV)
1	2386.760	34.49	30.44	64.93	-9.07	74.00	312	262	Peak
2	2390.000	33.60	30.45	64.05	-9.95	74.00	312	262	Peak
3	2438.250	92.69	30.53	123.22	N/A	N/A	312	262	Peak
4	* 2483.500	38.16	30.59	68.75	-5.25	74.00	312	262	Peak
5	2484.040	37.61	30.59	68.20	-5.80	74.00	312	262	Peak

Note:

1. " \*", means this data is the worst emission level.
2. C.F (Correction Factor) = Antenna Factor (dB/m)+ Cable Loss (dB).
3. Measurement (dBuV/m) = Reading(dBuV) + C.F (Correction Factor).
4. The emission levels of other frequencies are very lower than the limit and not show in test report.

EUT	BE5000 Whole Home Mesh Wi-Fi 7 System	Date of Test	2024-03-23
Factor	DRH18-E	Temp. / Humidity	24°C /60%
Polarity	Horizontal	Site / Test Engineer	AC2 / Marvin
Test Mode	802.11n-20MHz_TX_CH 6_ANT 0+1	Test Voltage	AC 120V/60Hz

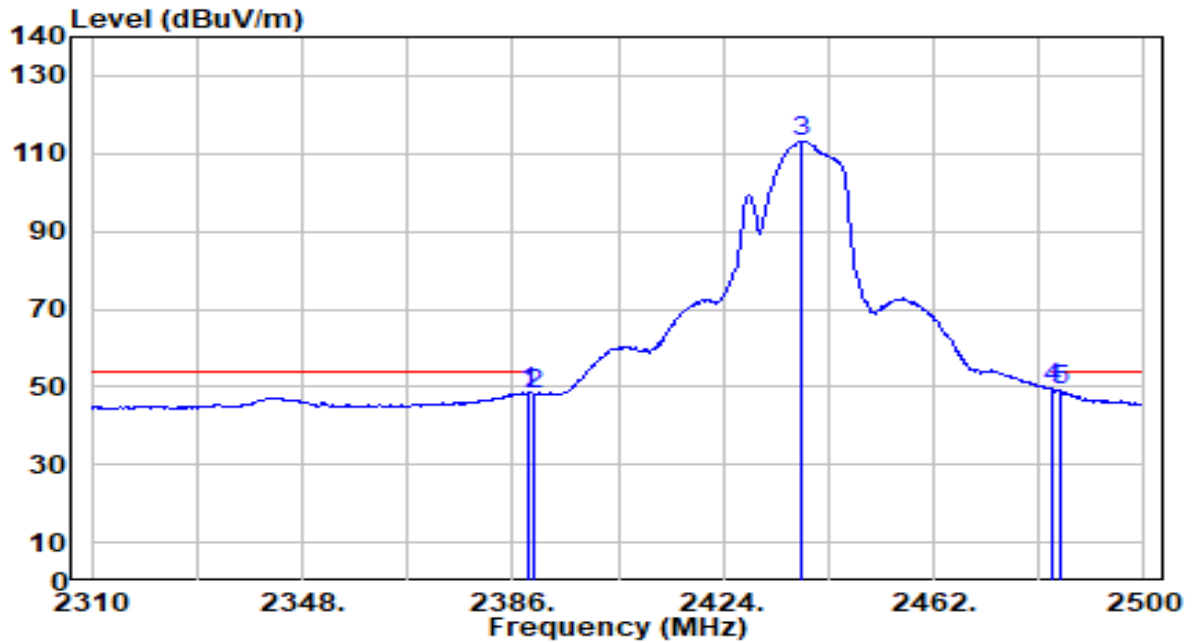

No	Frequency (MHz)	Reading (dBuV)	C.F (dB/m)	Measurement (dBuV/m)	Margin (dB)	Limit (dBuV/m)	Height (cm)	Angle (deg)	Remark (QP/PK/AV)
1	2389.040	18.24	30.44	48.68	-5.32	54.00	312	262	Average
2	2390.000	17.80	30.45	48.24	-5.76	54.00	312	262	Average
3	2438.250	82.70	30.53	113.22	N/A	N/A	312	262	Average
4	* 2483.500	18.82	30.59	49.41	-4.59	54.00	312	262	Average
5	2484.800	18.36	30.59	48.95	-5.05	54.00	312	262	Average

Note:

1. " \*", means this data is the worst emission level.
2. C.F (Correction Factor) = Antenna Factor (dB/m)+ Cable Loss (dB).
3. Measurement (dBuV/m) = Reading(dBuV) + C.F (Correction Factor).
4. The emission levels of other frequencies are very lower than the limit and not show in test report.

EUT	BE5000 Whole Home Mesh Wi-Fi 7 System	Date of Test	2024-03-23
Factor	DRH18-E	Temp. / Humidity	24°C /60%
Polarity	Vertical	Site / Test Engineer	AC2 / Marvin
Test Mode	802.11n-20MHz_TX_CH 6_ANT 0+1	Test Voltage	AC 120V/60Hz

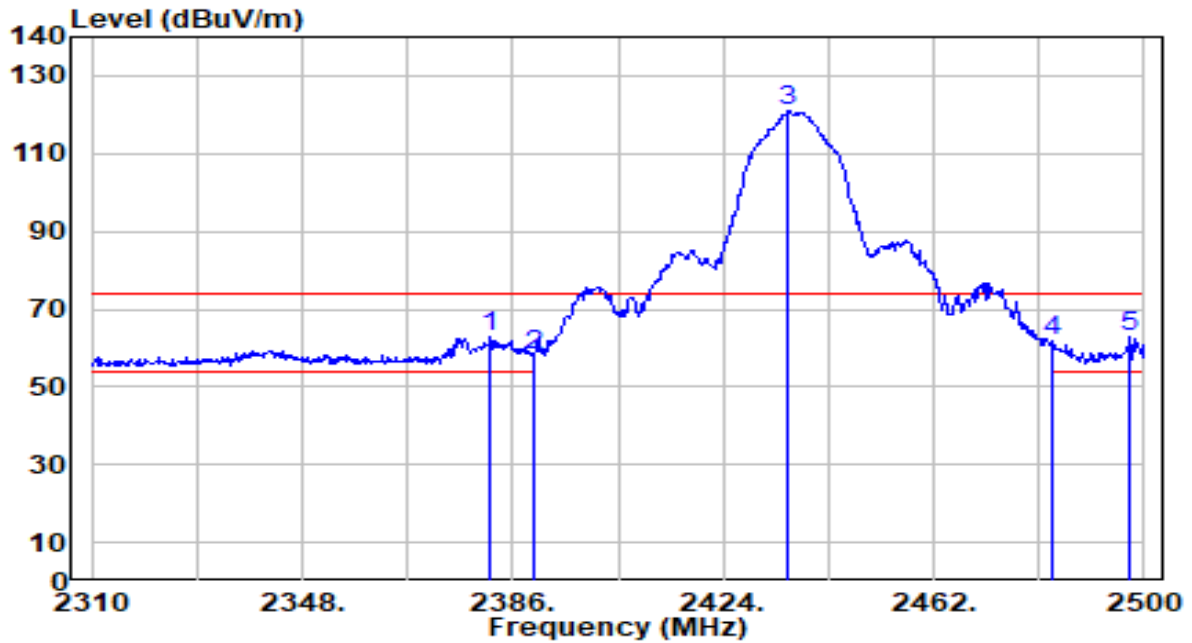

No	Frequency (MHz)	Reading (dBuV)	C.F (dB/m)	Measurement (dBuV/m)	Margin (dB)	Limit (dBuV/m)	Height (cm)	Angle (deg)	Remark (QP/PK/AV)
1	2382.010	32.29	30.42	62.72	-11.28	74.00	200	167	Peak
2	2390.000	27.74	30.45	58.19	-15.81	74.00	200	167	Peak
3	2435.780	90.27	30.52	120.79	N/A	N/A	200	167	Peak
4	2483.500	31.40	30.59	61.99	-12.01	74.00	200	167	Peak
5	* 2497.530	32.46	30.61	63.07	-10.93	74.00	200	167	Peak

Note:

1. " \*", means this data is the worst emission level.
2. C.F (Correction Factor) = Antenna Factor (dB/m)+ Cable Loss (dB).
3. Measurement (dBuV/m) = Reading(dBuV) + C.F (Correction Factor).
4. The emission levels of other frequencies are very lower than the limit and not show in test report.

EUT	BE5000 Whole Home Mesh Wi-Fi 7 System	Date of Test	2024-03-23
Factor	DRH18-E	Temp. / Humidity	24°C /60%
Polarity	Vertical	Site / Test Engineer	AC2 / Marvin
Test Mode	802.11n-20MHz_TX_CH 6_ANT 0+1	Test Voltage	AC 120V/60Hz

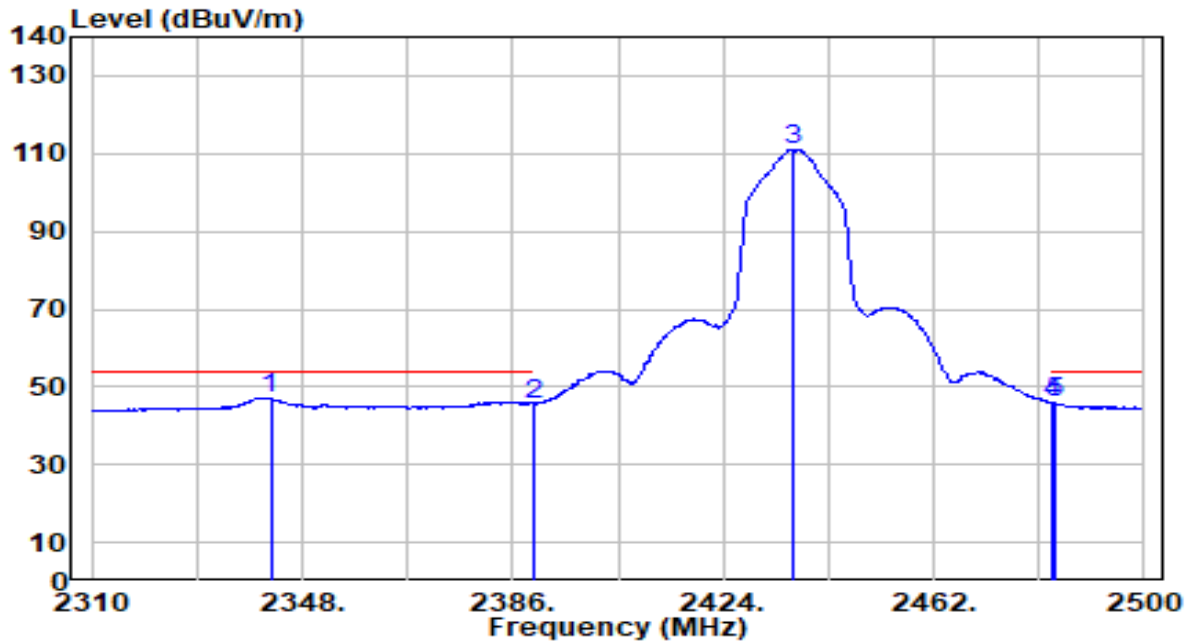

No	Frequency (MHz)	Reading (dBuV)	C.F (dB/m)	Measurement (dBuV/m)	Margin (dB)	Limit (dBuV/m)	Height (cm)	Angle (deg)	Remark (QP/PK/AV)
1	* 2342.300	16.93	30.31	47.24	-6.76	54.00	200	167	Average
2	2390.000	15.18	30.45	45.63	-8.37	54.00	200	167	Average
3	2436.540	80.39	30.52	110.92	N/A	N/A	200	167	Average
4	2483.500	15.33	30.59	45.92	-8.08	54.00	200	167	Average
5	2484.040	15.15	30.59	45.74	-8.26	54.00	200	167	Average

Note:

- " \*", means this data is the worst emission level.
- C.F (Correction Factor) = Antenna Factor (dB/m)+ Cable Loss (dB).
- Measurement (dBuV/m) = Reading(dBuV) + C.F (Correction Factor).
- The emission levels of other frequencies are very lower than the limit and not show in test report.



EUT	BE5000 Whole Home Mesh Wi-Fi 7 System	Date of Test	2024-03-23
Factor	DRH18-E	Temp. / Humidity	24°C /60%
Polarity	Horizontal	Site / Test Engineer	AC2 / Marvin
Test Mode	802.11n-20MHz_TX_CH 11_ANT 0+1	Test Voltage	AC 120V/60Hz

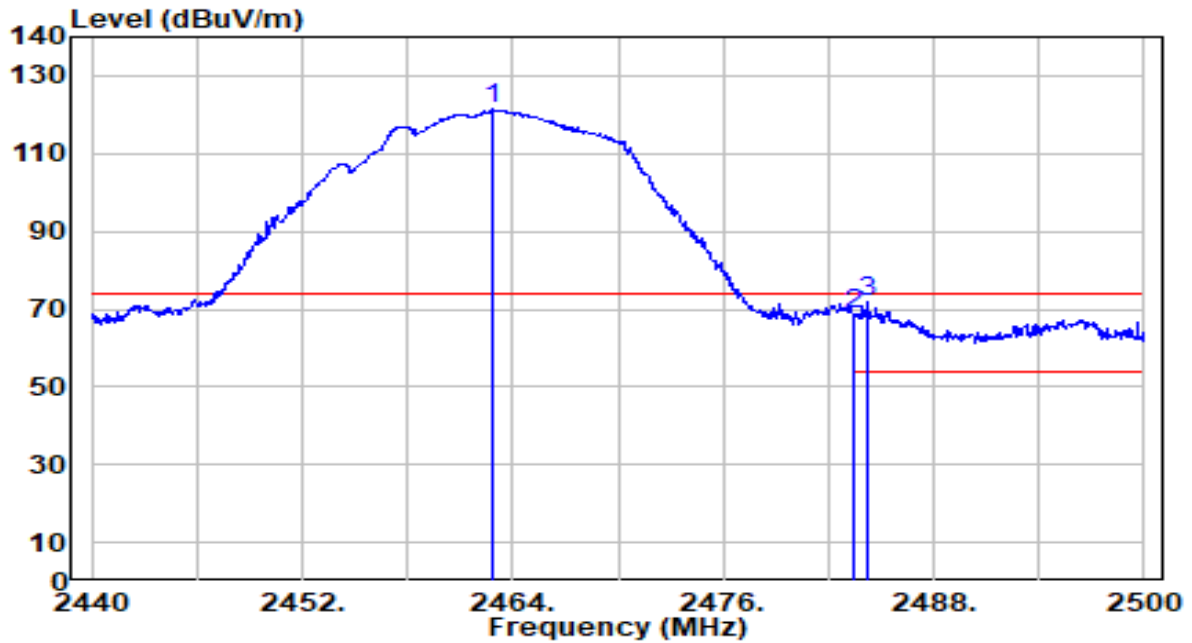

No	Frequency (MHz)	Reading (dBUV)	C.F (dB/m)	Measurement (dBUV/m)	Margin (dB)	Limit (dBUV/m)	Height (cm)	Angle (deg)	Remark (QP/PK/AV)
1	2462.800	90.70	30.56	121.26	N/A	N/A	120	84	Peak
2	2483.500	38.27	30.59	68.86	-5.14	74.00	120	84	Peak
3	* 2484.220	41.24	30.59	71.83	-2.17	74.00	120	84	Peak

Note:

1. " \*", means this data is the worst emission level.
2. C.F (Correction Factor) = Antenna Factor (dB/m)+ Cable Loss (dB).
3. Measurement (dBUV/m) = Reading(dBUV) + C.F (Correction Factor).
4. The emission levels of other frequencies are very lower than the limit and not show in test report.

EUT	BE5000 Whole Home Mesh Wi-Fi 7 System	Date of Test	2024-03-23
Factor	DRH18-E	Temp. / Humidity	24°C /60%
Polarity	Horizontal	Site / Test Engineer	AC2 / Marvin
Test Mode	802.11n-20MHz_TX_CH 11_ANT 0+1	Test Voltage	AC 120V/60Hz

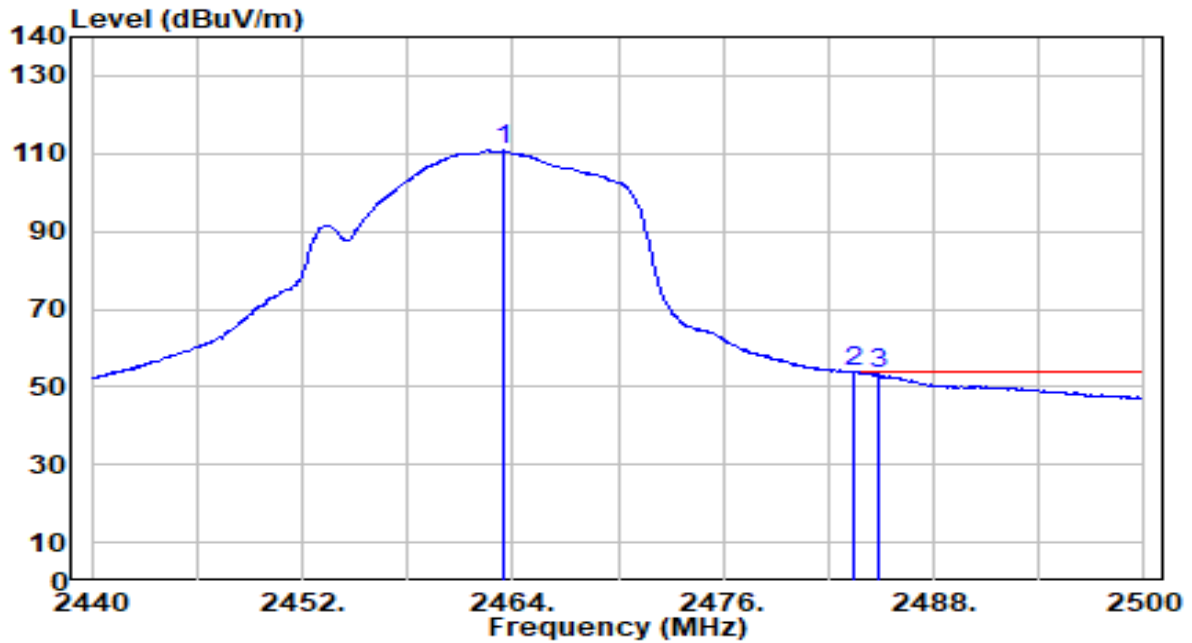

No	Frequency (MHz)	Reading (dBUV)	C.F (dB/m)	Measurement (dBUV/m)	Margin (dB)	Limit (dBUV/m)	Height (cm)	Angle (deg)	Remark (QP/PK/AV)
1	2463.460	80.29	30.56	110.85	N/A	N/A	120	84	Average
2	* 2483.500	23.31	30.59	53.89	-0.11	54.00	120	84	Average
3	2484.820	22.63	30.59	53.22	-0.78	54.00	120	84	Average

Note:

1. " \*", means this data is the worst emission level.
2. C.F (Correction Factor) = Antenna Factor (dB/m)+ Cable Loss (dB).
3. Measurement (dBUV/m) = Reading(dBUV) + C.F (Correction Factor).
4. The emission levels of other frequencies are very lower than the limit and not show in test report.

EUT	BE5000 Whole Home Mesh Wi-Fi 7 System	Date of Test	2024-03-23
Factor	DRH18-E	Temp. / Humidity	24°C /60%
Polarity	Vertical	Site / Test Engineer	AC2 / Marvin
Test Mode	802.11n-20MHz_TX_CH 11_ANT 0+1	Test Voltage	AC 120V/60Hz

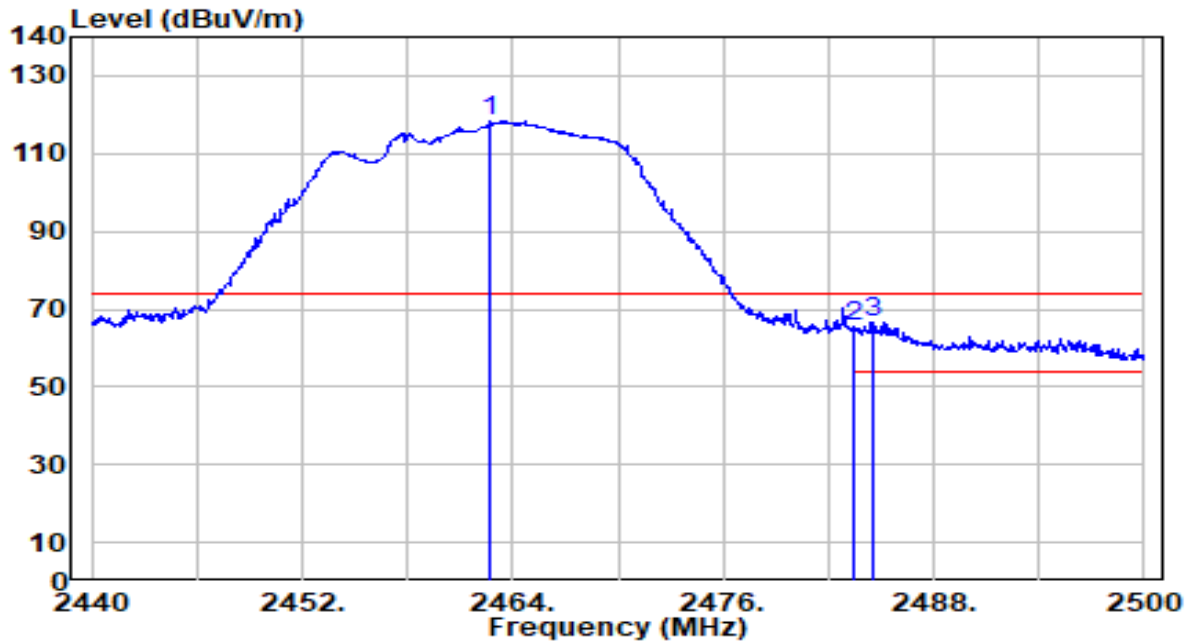

No	Frequency (MHz)	Reading (dBuV)	C.F (dB/m)	Measurement (dBuV/m)	Margin (dB)	Limit (dBuV/m)	Height (cm)	Angle (deg)	Remark (QP/PK/AV)
1	2462.680	87.60	30.56	118.16	N/A	N/A	300	192	Peak
2	2483.500	34.79	30.59	65.38	-8.62	74.00	300	192	Peak
3	* 2484.520	36.23	30.59	66.81	-7.19	74.00	300	192	Peak

Note:

1. " \*", means this data is the worst emission level.
2. C.F (Correction Factor) = Antenna Factor (dB/m)+ Cable Loss (dB).
3. Measurement (dBuV/m) = Reading(dBuV) + C.F (Correction Factor).
4. The emission levels of other frequencies are very lower than the limit and not show in test report.

EUT	BE5000 Whole Home Mesh Wi-Fi 7 System	Date of Test	2024-03-23
Factor	DRH18-E	Temp. / Humidity	24°C /60%
Polarity	Vertical	Site / Test Engineer	AC2 / Marvin
Test Mode	802.11n-20MHz_TX_CH 11_ANT 0+1	Test Voltage	AC 120V/60Hz

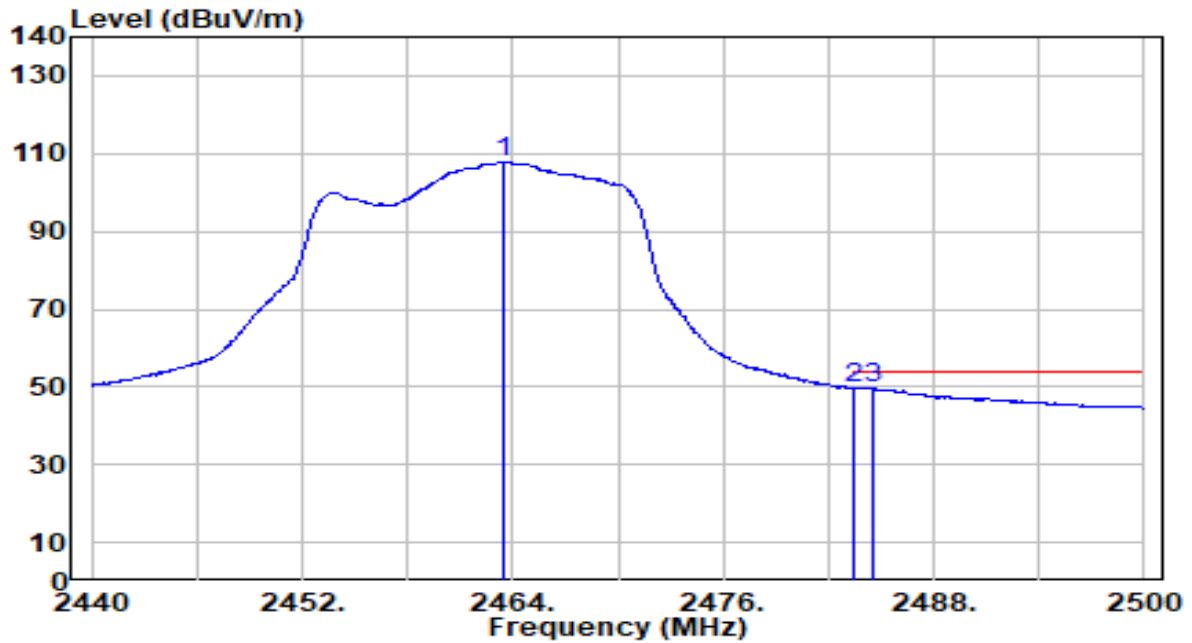

No	Frequency (MHz)	Reading (dBuV)	C.F (dB/m)	Measurement (dBuV/m)	Margin (dB)	Limit (dBuV/m)	Height (cm)	Angle (deg)	Remark (QP/PK/AV)
1	2463.460	77.45	30.56	108.01	N/A	N/A	300	192	Average
2	* 2483.500	19.05	30.59	49.64	-4.36	54.00	300	192	Average
3	2484.520	18.98	30.59	49.57	-4.43	54.00	300	192	Average

Note:

1. " \*", means this data is the worst emission level.
2. C.F (Correction Factor) = Antenna Factor (dB/m)+ Cable Loss (dB).
3. Measurement (dBuV/m) = Reading(dBuV) + C.F (Correction Factor).
4. The emission levels of other frequencies are very lower than the limit and not show in test report.

EUT	BE5000 Whole Home Mesh Wi-Fi 7 System	Date of Test	2024-03-23
Factor	DRH18-E	Temp. / Humidity	24°C /60%
Polarity	Horizontal	Site / Test Engineer	AC2 / Marvin
Test Mode	802.11n-40MHz_TX_CH 3_ANT 0+1	Test Voltage	AC 120V/60Hz

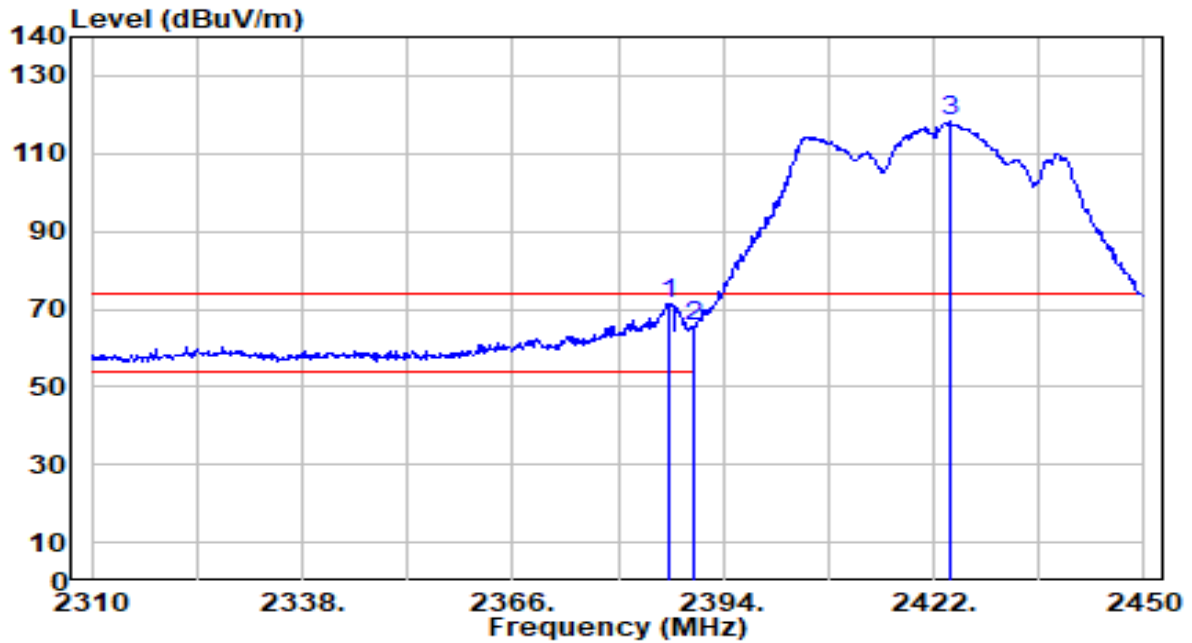

No	Frequency (MHz)	Reading (dBuV)	C.F (dB/m)	Measurement (dBuV/m)	Margin (dB)	Limit (dBuV/m)	Height (cm)	Angle (deg)	Remark (QP/PK/AV)	
1	*	2386.860	41.04	30.44	71.48	-2.52	74.00	130	86	Peak
2		2390.000	34.96	30.45	65.41	-8.59	74.00	130	86	Peak
3		2424.240	87.60	30.51	118.11	N/A	N/A	130	86	Peak

Note:

1. " \*", means this data is the worst emission level.
2. C.F (Correction Factor) = Antenna Factor (dB/m)+ Cable Loss (dB).
3. Measurement (dBuV/m) = Reading(dBuV) + C.F (Correction Factor).
4. The emission levels of other frequencies are very lower than the limit and not show in test report.

EUT	BE5000 Whole Home Mesh Wi-Fi 7 System	Date of Test	2024-03-23
Factor	DRH18-E	Temp. / Humidity	24°C /60%
Polarity	Horizontal	Site / Test Engineer	AC2 / Marvin
Test Mode	802.11n-40MHz_TX_CH 3_ANT 0+1	Test Voltage	AC 120V/60Hz

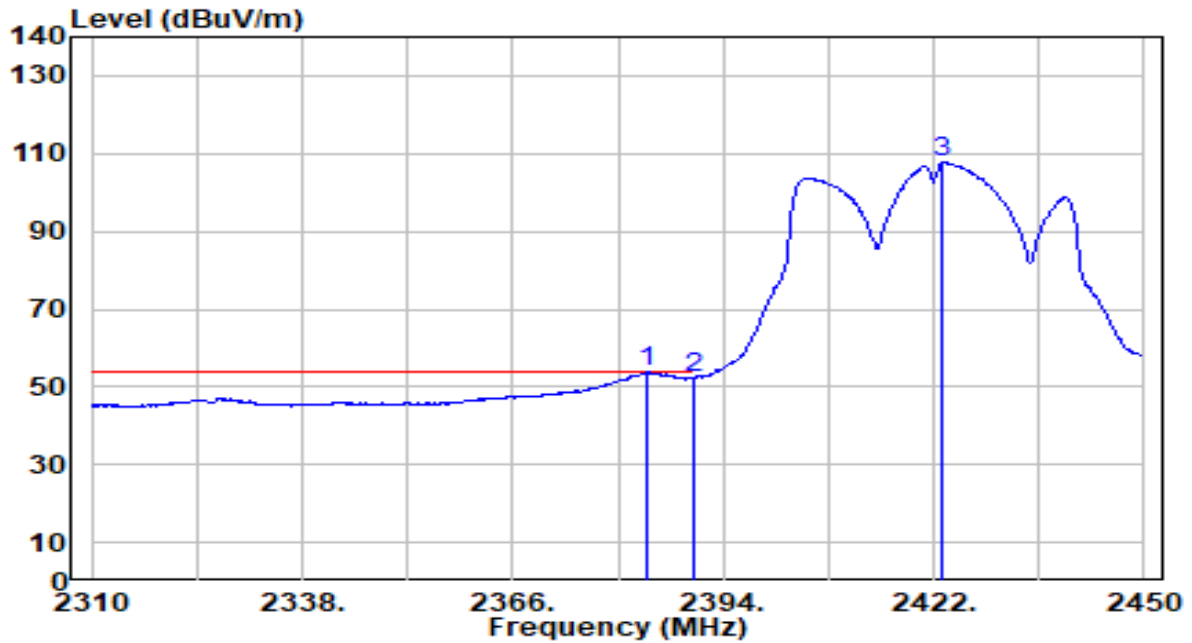

No	Frequency (MHz)	Reading (dBuV)	C.F (dB/m)	Measurement (dBuV/m)	Margin (dB)	Limit (dBuV/m)	Height (cm)	Angle (deg)	Remark (QP/PK/AV)
1	*	23.41	30.43	53.84	-0.16	54.00	130	86	Average
2		21.80	30.45	52.25	-1.75	54.00	130	86	Average
3		77.26	30.51	107.77	N/A	N/A	130	86	Average

Note:

1. " \*", means this data is the worst emission level.
2. C.F (Correction Factor) = Antenna Factor (dB/m)+ Cable Loss (dB).
3. Measurement (dBuV/m) = Reading(dBuV) + C.F (Correction Factor).
4. The emission levels of other frequencies are very lower than the limit and not show in test report.

EUT	BE5000 Whole Home Mesh Wi-Fi 7 System	Date of Test	2024-03-23
Factor	DRH18-E	Temp. / Humidity	24°C /60%
Polarity	Vertical	Site / Test Engineer	AC2 / Marvin
Test Mode	802.11n-40MHz_TX_CH 3_ANT 0+1	Test Voltage	AC 120V/60Hz

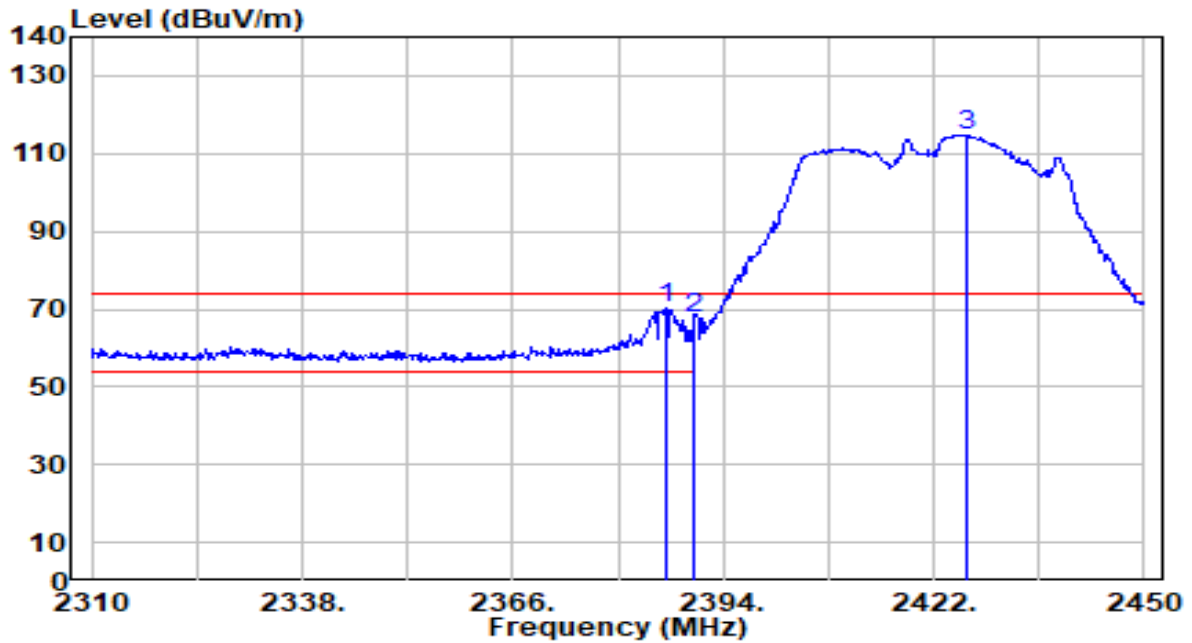

No	Frequency (MHz)	Reading (dBuV)	C.F (dB/m)	Measurement (dBuV/m)	Margin (dB)	Limit (dBuV/m)	Height (cm)	Angle (deg)	Remark (QP/PK/AV)	
1	*	2386.300	39.72	30.44	70.16	-3.84	74.00	300	189	Peak
2		2390.000	37.04	30.45	67.49	-6.51	74.00	300	189	Peak
3		2426.480	84.30	30.51	114.81	N/A	N/A	300	189	Peak

Note:

1. "\*" , means this data is the worst emission level.
2. C.F (Correction Factor) = Antenna Factor (dB/m)+ Cable Loss (dB).
3. Measurement (dBuV/m) = Reading(dBuV) + C.F (Correction Factor).
4. The emission levels of other frequencies are very lower than the limit and not show in test report.

EUT	BE5000 Whole Home Mesh Wi-Fi 7 System	Date of Test	2024-03-23
Factor	DRH18-E	Temp. / Humidity	24°C /60%
Polarity	Vertical	Site / Test Engineer	AC2 / Marvin
Test Mode	802.11n-40MHz_TX_CH 3_ANT 0+1	Test Voltage	AC 120V/60Hz

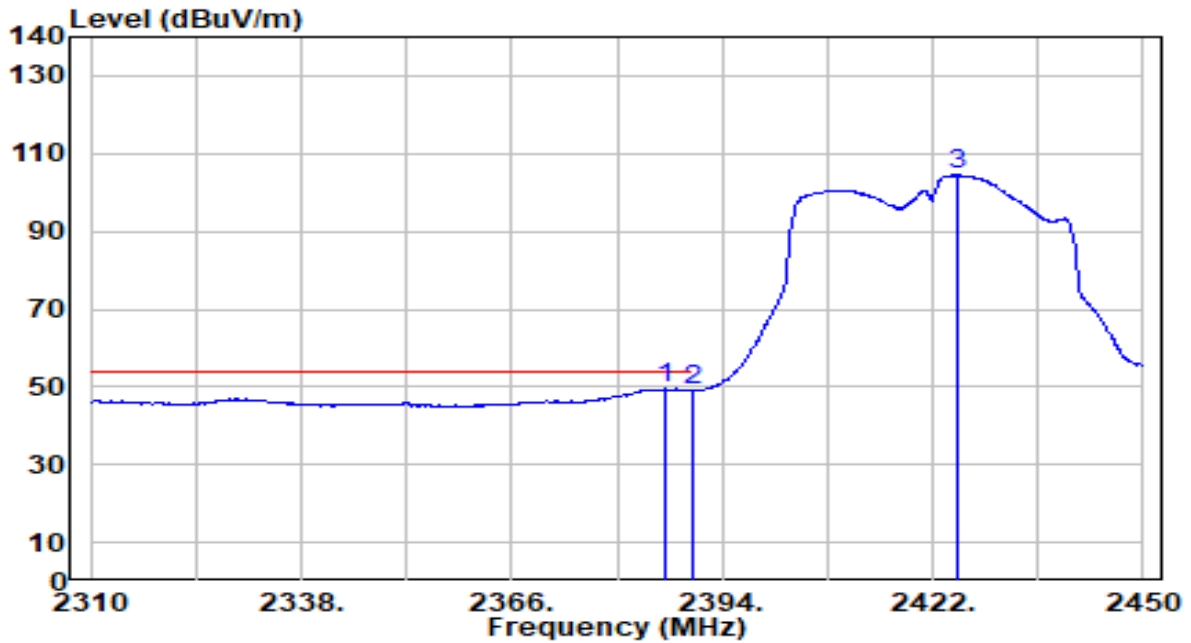

No	Frequency (MHz)	Reading (dBuV)	C.F (dB/m)	Measurement (dBuV/m)	Margin (dB)	Limit (dBuV/m)	Height (cm)	Angle (deg)	Remark (QP/PK/AV)	
1	*	2386.440	19.18	30.44	49.61	-4.39	54.00	300	189	Average
2		2390.000	18.68	30.45	49.13	-4.87	54.00	300	189	Average
3		2425.220	73.97	30.51	104.48	N/A	N/A	300	189	Average

Note:

1. " \*", means this data is the worst emission level.
2. C.F (Correction Factor) = Antenna Factor (dB/m)+ Cable Loss (dB).
3. Measurement (dBuV/m) = Reading(dBuV) + C.F (Correction Factor).
4. The emission levels of other frequencies are very lower than the limit and not show in test report.



EUT	BE5000 Whole Home Mesh Wi-Fi 7 System	Date of Test	2024-03-23
Factor	DRH18-E	Temp. / Humidity	24°C /60%
Polarity	Horizontal	Site / Test Engineer	AC2 / Marvin
Test Mode	802.11n-40MHz_TX_CH 6_ANT 0+1	Test Voltage	AC 120V/60Hz

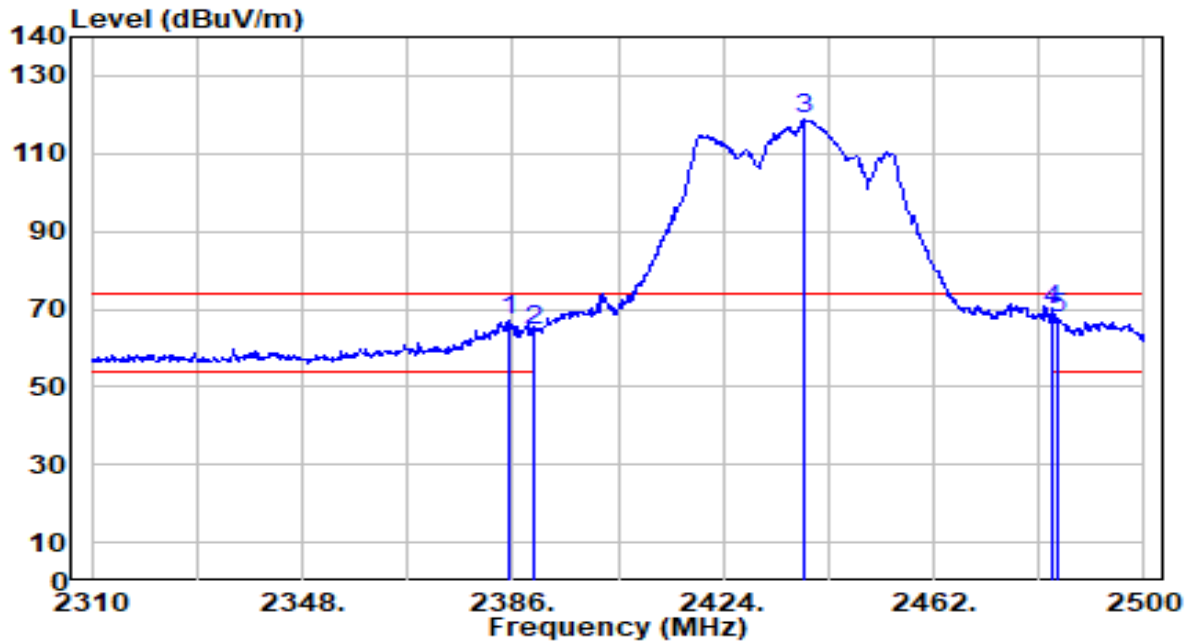

No	Frequency (MHz)	Reading (dBuV)	C.F (dB/m)	Measurement (dBuV/m)	Margin (dB)	Limit (dBuV/m)	Height (cm)	Angle (deg)	Remark (QP/PK/AV)
1	2385.240	36.46	30.43	66.89	-7.11	74.00	121	87	Peak
2	2390.000	34.19	30.45	64.64	-9.36	74.00	121	87	Peak
3	2438.630	88.11	30.53	118.63	N/A	N/A	121	87	Peak
4	* 2483.500	39.08	30.59	69.66	-4.34	74.00	121	87	Peak
5	2484.420	37.28	30.59	67.87	-6.13	74.00	121	87	Peak

Note:

1. " \*", means this data is the worst emission level.
2. C.F (Correction Factor) = Antenna Factor (dB/m)+ Cable Loss (dB).
3. Measurement (dBuV/m) = Reading(dBuV) + C.F (Correction Factor).
4. The emission levels of other frequencies are very lower than the limit and not show in test report.

EUT	BE5000 Whole Home Mesh Wi-Fi 7 System	Date of Test	2024-03-23
Factor	DRH18-E	Temp. / Humidity	24°C /60%
Polarity	Horizontal	Site / Test Engineer	AC2 / Marvin
Test Mode	802.11n-40MHz_TX_CH 6_ANT 0+1	Test Voltage	AC 120V/60Hz

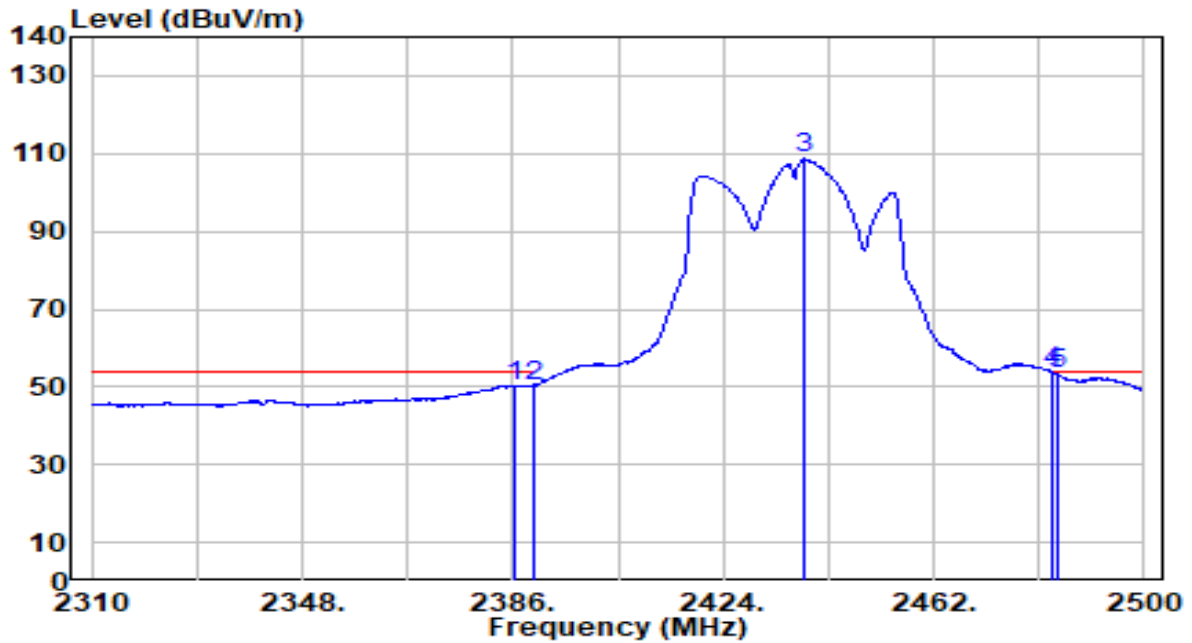

No	Frequency (MHz)	Reading (dBuV)	C.F (dB/m)	Measurement (dBuV/m)	Margin (dB)	Limit (dBuV/m)	Height (cm)	Angle (deg)	Remark (QP/PK/AV)
1	2386.190	19.93	30.44	50.37	-3.63	54.00	121	87	Average
2	2390.000	19.99	30.45	50.44	-3.56	54.00	121	87	Average
3	2438.440	78.20	30.53	108.73	N/A	N/A	121	87	Average
4	* 2483.500	23.28	30.59	53.86	-0.14	54.00	121	87	Average
5	2484.230	22.69	30.59	53.28	-0.72	54.00	121	87	Average

Note:

1. " \*", means this data is the worst emission level.
2. C.F (Correction Factor) = Antenna Factor (dB/m)+ Cable Loss (dB).
3. Measurement (dBuV/m) = Reading(dBuV) + C.F (Correction Factor).
4. The emission levels of other frequencies are very lower than the limit and not show in test report.

EUT	BE5000 Whole Home Mesh Wi-Fi 7 System	Date of Test	2024-03-23
Factor	DRH18-E	Temp. / Humidity	24°C /60%
Polarity	Vertical	Site / Test Engineer	AC2 / Marvin
Test Mode	802.11n-40MHz_TX_CH 6_ANT 0+1	Test Voltage	AC 120V/60Hz

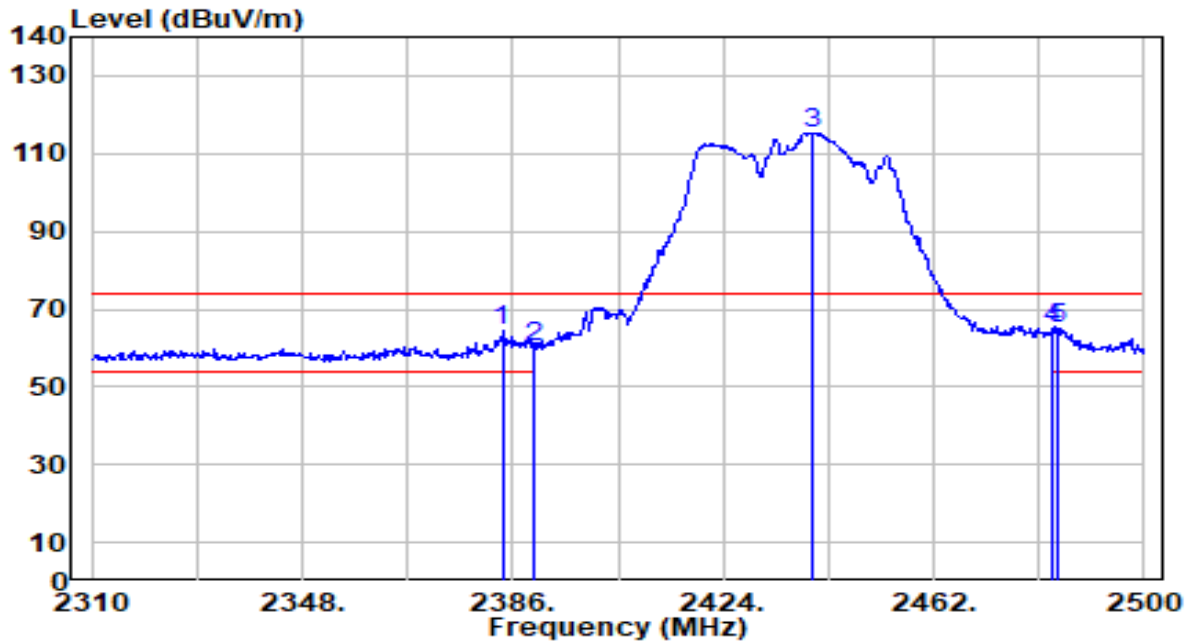

No	Frequency (MHz)	Reading (dBUV)	C.F (dB/m)	Measurement (dBUV/m)	Margin (dB)	Limit (dBUV/m)	Height (cm)	Angle (deg)	Remark (QP/PK/AV)
1	2384.100	34.04	30.43	64.47	-9.53	74.00	307	192	Peak
2	2390.000	29.85	30.45	60.30	-13.70	74.00	307	192	Peak
3	2439.960	84.83	30.53	115.36	N/A	N/A	307	192	Peak
4	2483.500	34.18	30.59	64.77	-9.23	74.00	307	192	Peak
5	* 2484.610	34.59	30.59	65.17	-8.83	74.00	307	192	Peak

Note:

1. " \*", means this data is the worst emission level.
2. C.F (Correction Factor) = Antenna Factor (dB/m)+ Cable Loss (dB).
3. Measurement (dBUV/m) = Reading(dBUV) + C.F (Correction Factor).
4. The emission levels of other frequencies are very lower than the limit and not show in test report.

EUT	BE5000 Whole Home Mesh Wi-Fi 7 System	Date of Test	2024-03-23
Factor	DRH18-E	Temp. / Humidity	24°C /60%
Polarity	Vertical	Site / Test Engineer	AC2 / Marvin
Test Mode	802.11n-40MHz_TX_CH 6_ANT 0+1	Test Voltage	AC 120V/60Hz

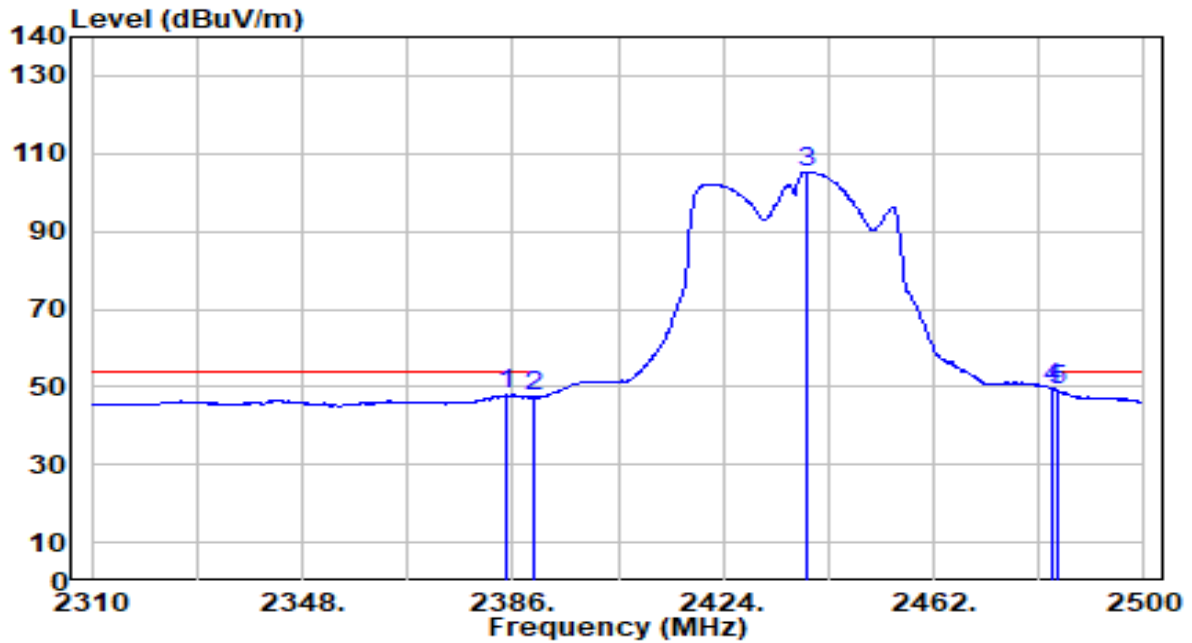

No	Frequency (MHz)	Reading (dBuV)	C.F (dB/m)	Measurement (dBuV/m)	Margin (dB)	Limit (dBuV/m)	Height (cm)	Angle (deg)	Remark (QP/PK/AV)
1	2385.050	17.46	30.43	47.90	-6.10	54.00	307	192	Average
2	2390.000	16.88	30.45	47.33	-6.67	54.00	307	192	Average
3	2439.200	74.72	30.53	105.25	N/A	N/A	307	192	Average
4	* 2483.500	18.94	30.59	49.53	-4.47	54.00	307	192	Average
5	2484.420	18.74	30.59	49.33	-4.67	54.00	307	192	Average

Note:

1. " \*", means this data is the worst emission level.
2. C.F (Correction Factor) = Antenna Factor (dB/m)+ Cable Loss (dB).
3. Measurement (dBuV/m) = Reading(dBuV) + C.F (Correction Factor).
4. The emission levels of other frequencies are very lower than the limit and not show in test report.

EUT	BE5000 Whole Home Mesh Wi-Fi 7 System	Date of Test	2024-03-23
Factor	DRH18-E	Temp. / Humidity	24°C /60%
Polarity	Horizontal	Site / Test Engineer	AC2 / Marvin
Test Mode	802.11n-40MHz_TX_CH 9_ANT 0+1	Test Voltage	AC 120V/60Hz

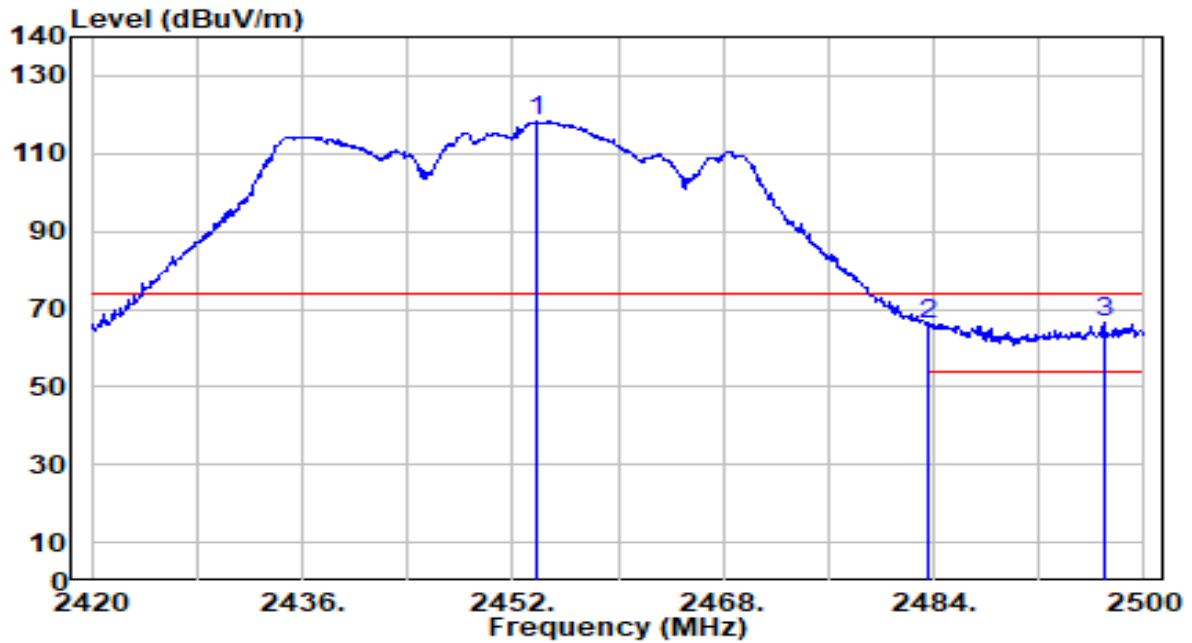

No	Frequency (MHz)	Reading (dBuV)	C.F (dB/m)	Measurement (dBuV/m)	Margin (dB)	Limit (dBuV/m)	Height (cm)	Angle (deg)	Remark (QP/PK/AV)
1	2453.840	87.74	30.55	118.28	N/A	N/A	313	260	Peak
2	2483.500	35.47	30.59	66.06	-7.94	74.00	313	260	Peak
3	* 2496.960	35.75	30.61	66.36	-7.64	74.00	313	260	Peak

Note:

1. " \*", means this data is the worst emission level.
2. C.F (Correction Factor) = Antenna Factor (dB/m)+ Cable Loss (dB).
3. Measurement (dBuV/m) = Reading(dBuV) + C.F (Correction Factor).
4. The emission levels of other frequencies are very lower than the limit and not show in test report.

EUT	BE5000 Whole Home Mesh Wi-Fi 7 System	Date of Test	2024-03-23
Factor	DRH18-E	Temp. / Humidity	24°C /60%
Polarity	Horizontal	Site / Test Engineer	AC2 / Marvin
Test Mode	802.11n-40MHz_TX_CH 9_ANT 0+1	Test Voltage	AC 120V/60Hz

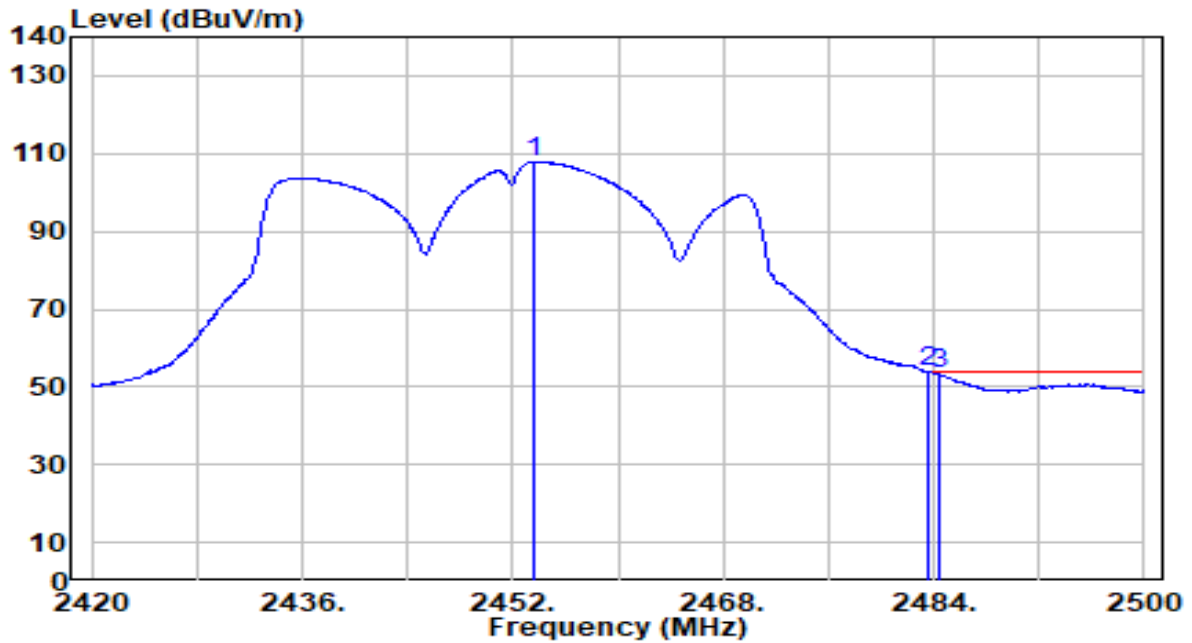

No	Frequency (MHz)	Reading (dBuV)	C.F (dB/m)	Measurement (dBuV/m)	Margin (dB)	Limit (dBuV/m)	Height (cm)	Angle (deg)	Remark (QP/PK/AV)
1	2453.600	77.39	30.55	107.93	N/A	N/A	313	260	Average
2	* 2483.500	23.26	30.59	53.84	-0.16	54.00	313	260	Average
3	2484.480	22.67	30.59	53.26	-0.74	54.00	313	260	Average

Note:

1. " \*", means this data is the worst emission level.
2. C.F (Correction Factor) = Antenna Factor (dB/m)+ Cable Loss (dB).
3. Measurement (dBuV/m) = Reading(dBuV) + C.F (Correction Factor).
4. The emission levels of other frequencies are very lower than the limit and not show in test report.

EUT	BE5000 Whole Home Mesh Wi-Fi 7 System	Date of Test	2024-03-23
Factor	DRH18-E	Temp. / Humidity	24°C /60%
Polarity	Vertical	Site / Test Engineer	AC2 / Marvin
Test Mode	802.11n-40MHz_TX_CH 9_ANT 0+1	Test Voltage	AC 120V/60Hz

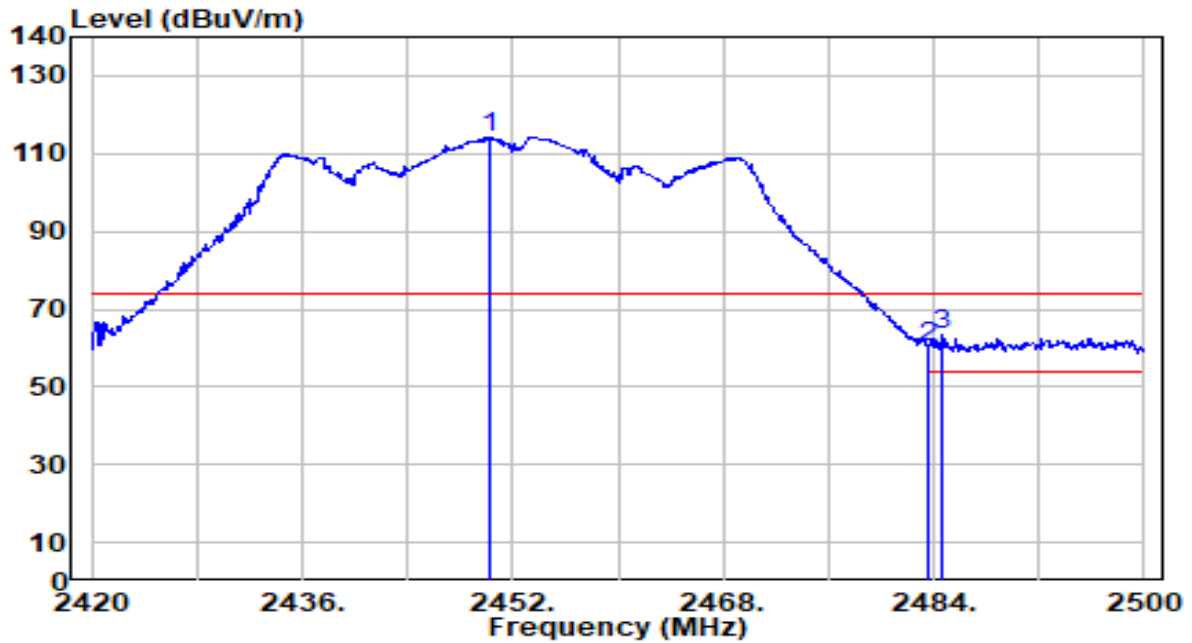

No	Frequency (MHz)	Reading (dBuV)	C.F (dB/m)	Measurement (dBuV/m)	Margin (dB)	Limit (dBuV/m)	Height (cm)	Angle (deg)	Remark (QP/PK/AV)
1	2450.240	83.63	30.54	114.18	N/A	N/A	200	167	Peak
2	2483.500	29.38	30.59	59.96	-14.04	74.00	200	167	Peak
3	* 2484.640	32.89	30.59	63.48	-10.52	74.00	200	167	Peak

Note:

1. " \*", means this data is the worst emission level.
2. C.F (Correction Factor) = Antenna Factor (dB/m)+ Cable Loss (dB).
3. Measurement (dBuV/m) = Reading(dBuV) + C.F (Correction Factor).
4. The emission levels of other frequencies are very lower than the limit and not show in test report.

EUT	BE5000 Whole Home Mesh Wi-Fi 7 System	Date of Test	2024-03-23
Factor	DRH18-E	Temp. / Humidity	24°C /60%
Polarity	Vertical	Site / Test Engineer	AC2 / Marvin
Test Mode	802.11n-40MHz_TX_CH 9_ANT 0+1	Test Voltage	AC 120V/60Hz

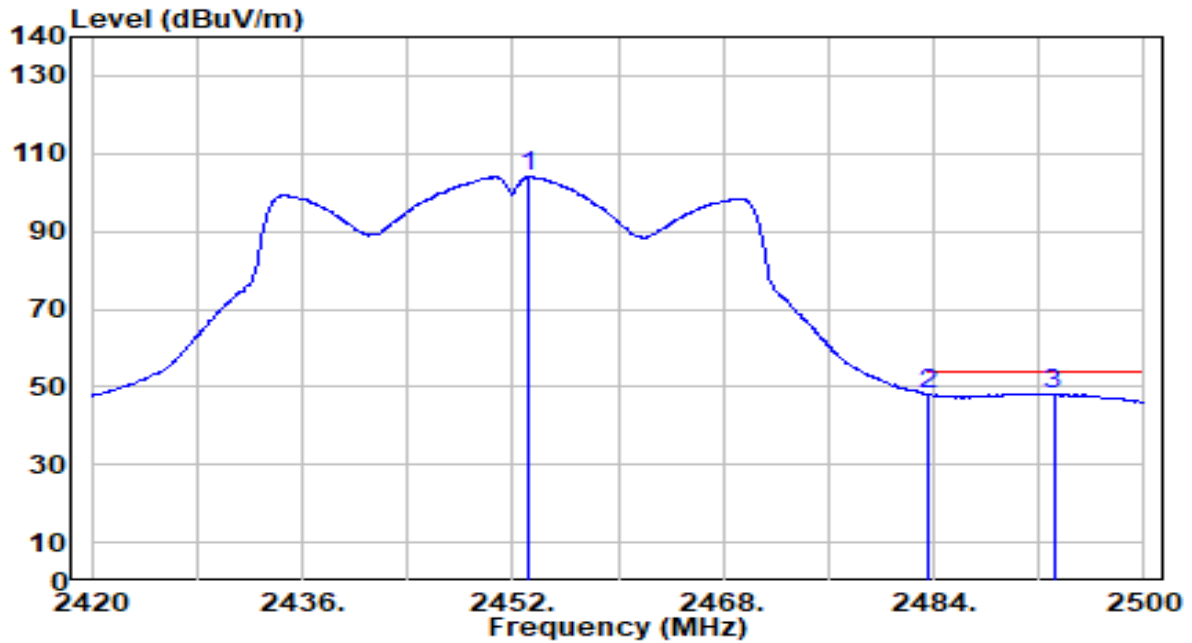

No	Frequency (MHz)	Reading (dBuV)	C.F (dB/m)	Measurement (dBuV/m)	Margin (dB)	Limit (dBuV/m)	Height (cm)	Angle (deg)	Remark (QP/PK/AV)
1	2453.280	73.55	30.55	104.09	N/A	N/A	200	167	Average
2	2483.500	17.46	30.59	48.05	-5.95	54.00	200	167	Average
3	* 2493.120	17.68	30.60	48.29	-5.71	54.00	200	167	Average

Note:

1. " \*", means this data is the worst emission level.
2. C.F (Correction Factor) = Antenna Factor (dB/m)+ Cable Loss (dB).
3. Measurement (dBuV/m) = Reading(dBuV) + C.F (Correction Factor).
4. The emission levels of other frequencies are very lower than the limit and not show in test report.



EUT	BE5000 Whole Home Mesh Wi-Fi 7 System	Date of Test	2024-03-23
Factor	DRH18-E	Temp. / Humidity	24°C /60%
Polarity	Horizontal	Site / Test Engineer	AC2 / Marvin
Test Mode	802.11ax-20MHz_TX_CH 1_ANT 0+1	Test Voltage	AC 120V/60Hz

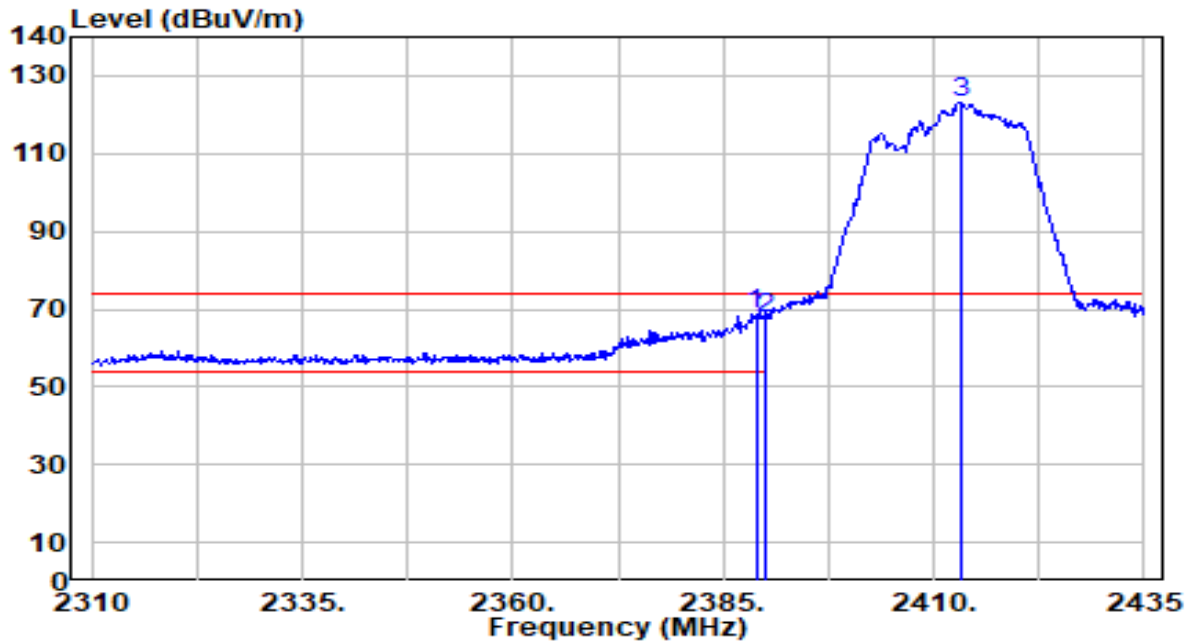

No	Frequency (MHz)	Reading (dBUV)	C.F (dB/m)	Measurement (dBUV/m)	Margin (dB)	Limit (dBUV/m)	Height (cm)	Angle (deg)	Remark (QP/PK/AV)	
1	*	2388.875	38.33	30.44	68.78	-5.22	74.00	318	262	Peak
2		2390.000	37.09	30.45	67.54	-6.46	74.00	318	262	Peak
3		2413.125	92.85	30.49	123.34	N/A	N/A	318	262	Peak

Note:

1. " \*", means this data is the worst emission level.
2. C.F (Correction Factor) = Antenna Factor (dB/m)+ Cable Loss (dB).
3. Measurement (dBUV/m) = Reading(dBUV) + C.F (Correction Factor).
4. The emission levels of other frequencies are very lower than the limit and not show in test report.

EUT	BE5000 Whole Home Mesh Wi-Fi 7 System	Date of Test	2024-03-23
Factor	DRH18-E	Temp. / Humidity	24°C /60%
Polarity	Horizontal	Site / Test Engineer	AC2 / Marvin
Test Mode	802.11ax-20MHz_TX_CH 1_ANT 0+1	Test Voltage	AC 120V/60Hz

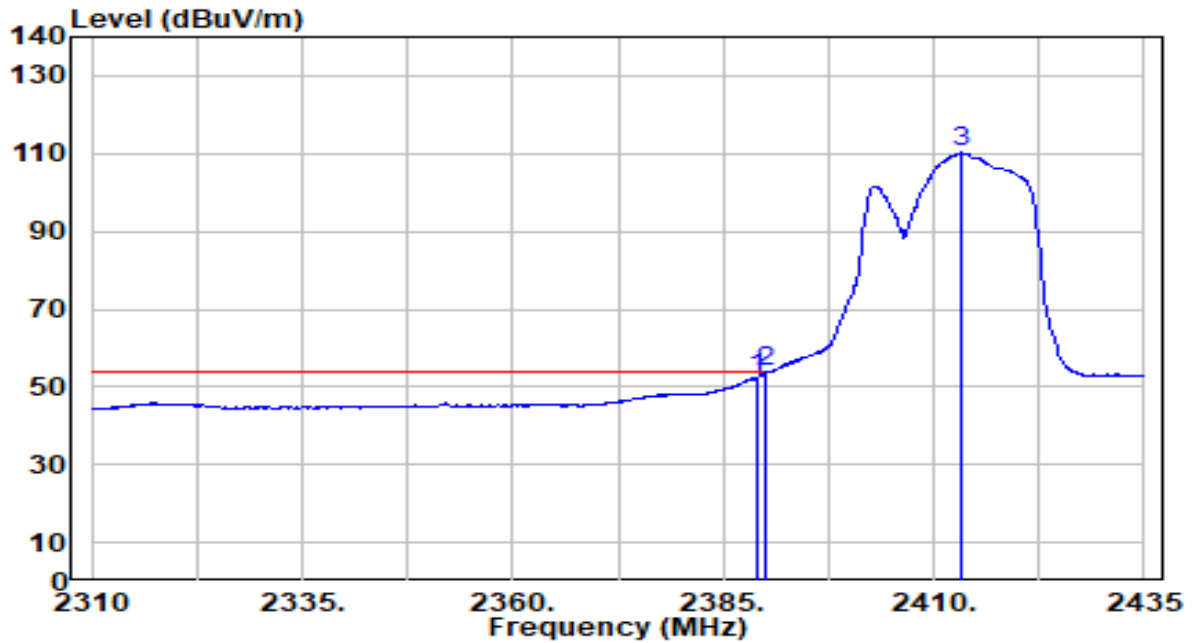

No	Frequency (MHz)	Reading (dBuV)	C.F (dB/m)	Measurement (dBuV/m)	Margin (dB)	Limit (dBuV/m)	Height (cm)	Angle (deg)	Remark (QP/PK/AV)
1	2389.000	22.01	30.44	52.45	-1.55	54.00	318	262	Average
2	* 2390.000	23.39	30.45	53.84	-0.16	54.00	318	262	Average
3	2413.375	79.66	30.49	110.16	N/A	N/A	318	262	Average

Note:

1. " \*", means this data is the worst emission level.
2. C.F (Correction Factor) = Antenna Factor (dB/m)+ Cable Loss (dB).
3. Measurement (dBuV/m) = Reading(dBuV) + C.F (Correction Factor).
4. The emission levels of other frequencies are very lower than the limit and not show in test report.

EUT	BE5000 Whole Home Mesh Wi-Fi 7 System	Date of Test	2024-03-23
Factor	DRH18-E	Temp. / Humidity	24°C /60%
Polarity	Vertical	Site / Test Engineer	AC2 / Marvin
Test Mode	802.11ax-20MHz_TX_CH 1_ANT 0+1	Test Voltage	AC 120V/60Hz

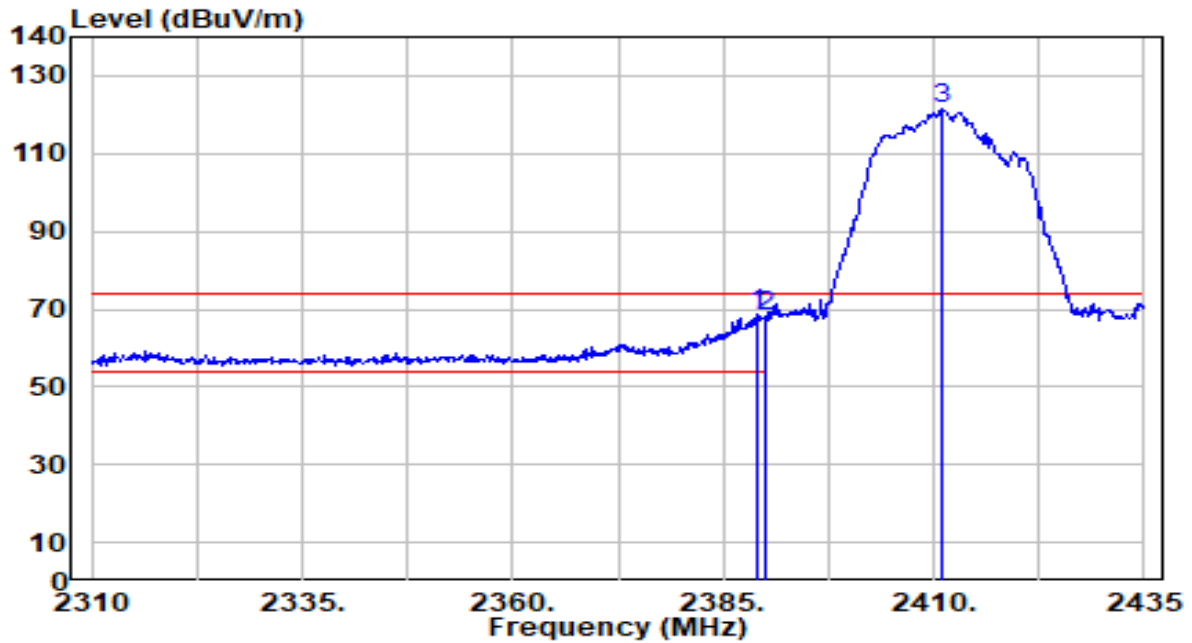

No	Frequency (MHz)	Reading (dBuV)	C.F (dB/m)	Measurement (dBuV/m)	Margin (dB)	Limit (dBuV/m)	Height (cm)	Angle (deg)	Remark (QP/PK/AV)	
1	*	2389.125	38.08	30.45	68.53	-5.47	74.00	203	177	Peak
2		2390.000	37.73	30.45	68.18	-5.82	74.00	203	177	Peak
3		2410.875	90.96	30.49	121.45	N/A	N/A	203	177	Peak

Note:

1. " \*", means this data is the worst emission level.
2. C.F (Correction Factor) = Antenna Factor (dB/m)+ Cable Loss (dB).
3. Measurement (dBuV/m) = Reading(dBuV) + C.F (Correction Factor).
4. The emission levels of other frequencies are very lower than the limit and not show in test report.

EUT	BE5000 Whole Home Mesh Wi-Fi 7 System	Date of Test	2024-03-23
Factor	DRH18-E	Temp. / Humidity	24°C /60%
Polarity	Vertical	Site / Test Engineer	AC2 / Marvin
Test Mode	802.11ax-20MHz_TX_CH 1_ANT 0+1	Test Voltage	AC 120V/60Hz

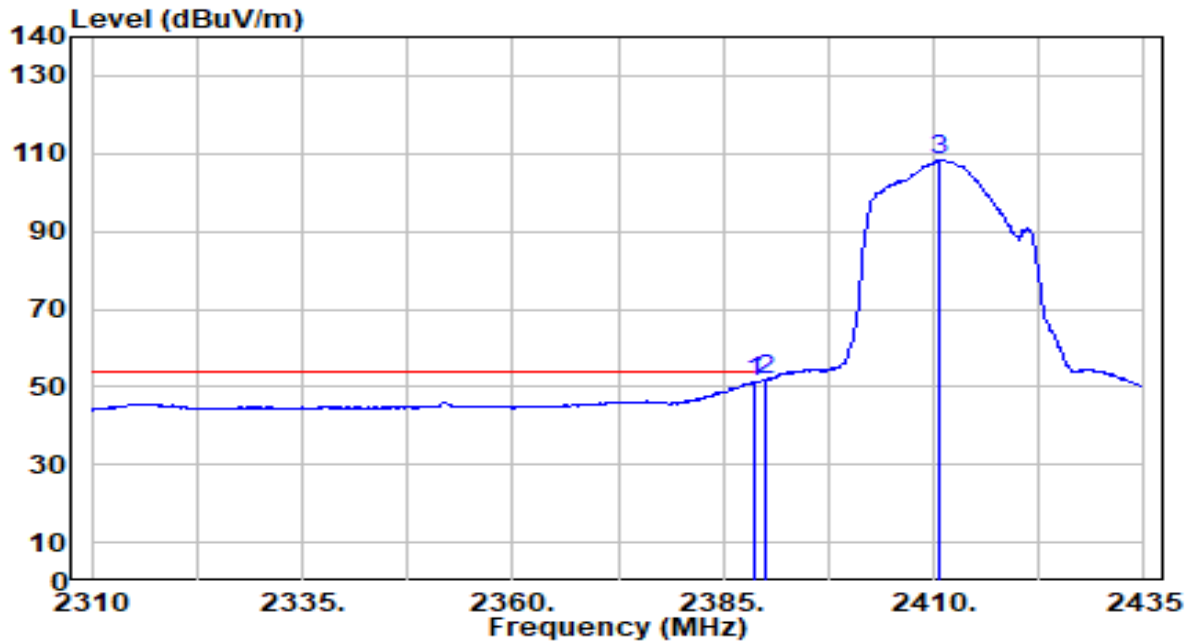

No	Frequency (MHz)	Reading (dBuV)	C.F (dB/m)	Measurement (dBuV/m)	Margin (dB)	Limit (dBuV/m)	Height (cm)	Angle (deg)	Remark (QP/PK/AV)
1	2388.750	20.85	30.44	51.30	-2.70	54.00	203	177	Average
2	* 2390.000	21.22	30.45	51.67	-2.33	54.00	203	177	Average
3	2410.500	77.87	30.49	108.36	N/A	N/A	203	177	Average

Note:

1. " \*", means this data is the worst emission level.
2. C.F (Correction Factor) = Antenna Factor (dB/m)+ Cable Loss (dB).
3. Measurement (dBuV/m) = Reading(dBuV) + C.F (Correction Factor).
4. The emission levels of other frequencies are very lower than the limit and not show in test report.

EUT	BE5000 Whole Home Mesh Wi-Fi 7 System	Date of Test	2024-03-23
Factor	DRH18-E	Temp. / Humidity	24°C /60%
Polarity	Horizontal	Site / Test Engineer	AC2 / Marvin
Test Mode	802.11ax-20MHz_TX_CH 6_ANT 0+1	Test Voltage	AC 120V/60Hz

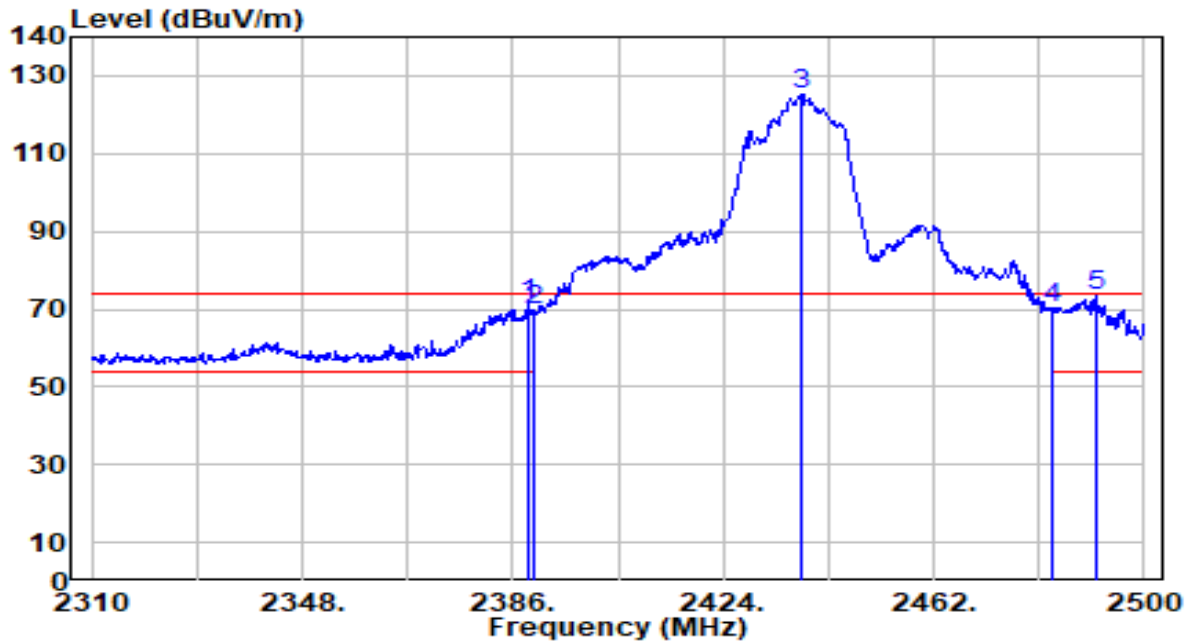

No	Frequency (MHz)	Reading (dBuV)	C.F (dB/m)	Measurement (dBuV/m)	Margin (dB)	Limit (dBuV/m)	Height (cm)	Angle (deg)	Remark (QP/PK/AV)
1	2388.660	40.86	30.44	71.31	-2.69	74.00	100	87	Peak
2	2390.000	39.22	30.45	69.67	-4.33	74.00	100	87	Peak
3	2438.060	94.74	30.53	125.27	N/A	N/A	100	87	Peak
4	2483.500	39.59	30.59	70.18	-3.82	74.00	100	87	Peak
5	* 2491.260	42.63	30.60	73.22	-0.78	74.00	100	87	Peak

Note:

1. " \*", means this data is the worst emission level.
2. C.F (Correction Factor) = Antenna Factor (dB/m)+ Cable Loss (dB).
3. Measurement (dBuV/m) = Reading(dBuV) + C.F (Correction Factor).
4. The emission levels of other frequencies are very lower than the limit and not show in test report.

EUT	BE5000 Whole Home Mesh Wi-Fi 7 System	Date of Test	2024-03-23
Factor	DRH18-E	Temp. / Humidity	24°C /60%
Polarity	Horizontal	Site / Test Engineer	AC2 / Marvin
Test Mode	802.11ax-20MHz_TX_CH 6_ANT 0+1	Test Voltage	AC 120V/60Hz

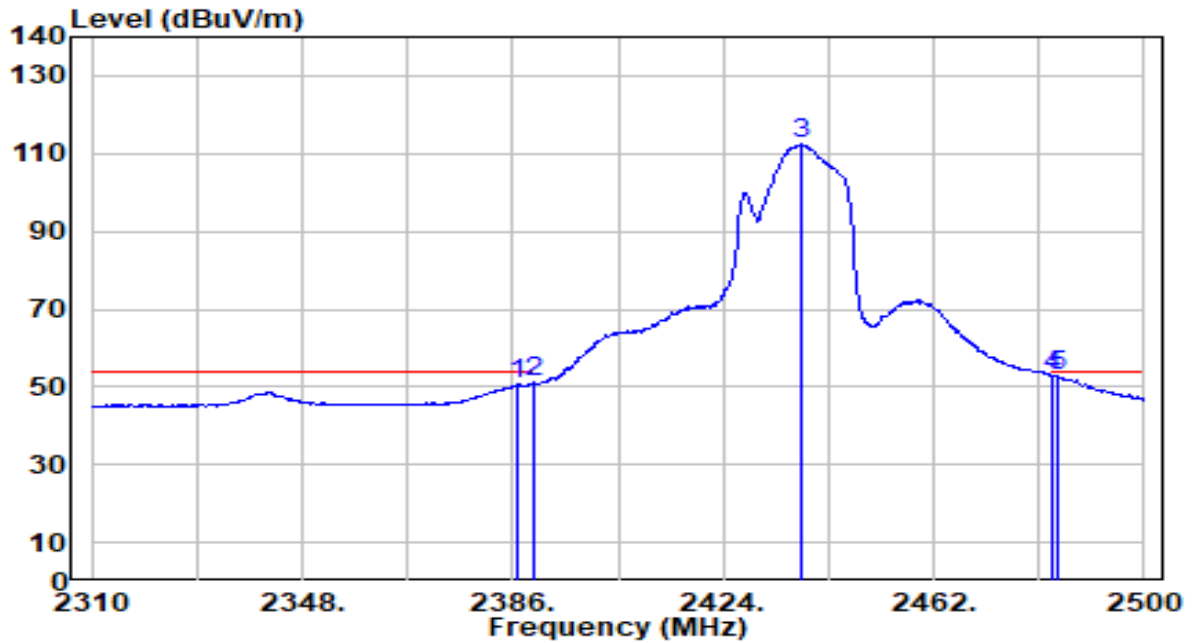

No	Frequency (MHz)	Reading (dBuV)	C.F (dB/m)	Measurement (dBuV/m)	Margin (dB)	Limit (dBuV/m)	Height (cm)	Angle (deg)	Remark (QP/PK/AV)
1	2386.950	20.25	30.44	50.69	-3.31	54.00	100	87	Average
2	2390.000	20.92	30.45	51.37	-2.63	54.00	100	87	Average
3	2438.250	81.82	30.53	112.35	N/A	N/A	100	87	Average
4	* 2483.500	22.37	30.59	52.96	-1.04	54.00	100	87	Average
5	2484.230	22.24	30.59	52.83	-1.17	54.00	100	87	Average

Note:

1. " \*", means this data is the worst emission level.
2. C.F (Correction Factor) = Antenna Factor (dB/m)+ Cable Loss (dB).
3. Measurement (dBuV/m) = Reading(dBuV) + C.F (Correction Factor).
4. The emission levels of other frequencies are very lower than the limit and not show in test report.

EUT	BE5000 Whole Home Mesh Wi-Fi 7 System	Date of Test	2024-03-23
Factor	DRH18-E	Temp. / Humidity	24°C /60%
Polarity	Vertical	Site / Test Engineer	AC2 / Marvin
Test Mode	802.11ax-20MHz_TX_CH 6_ANT 0+1	Test Voltage	AC 120V/60Hz

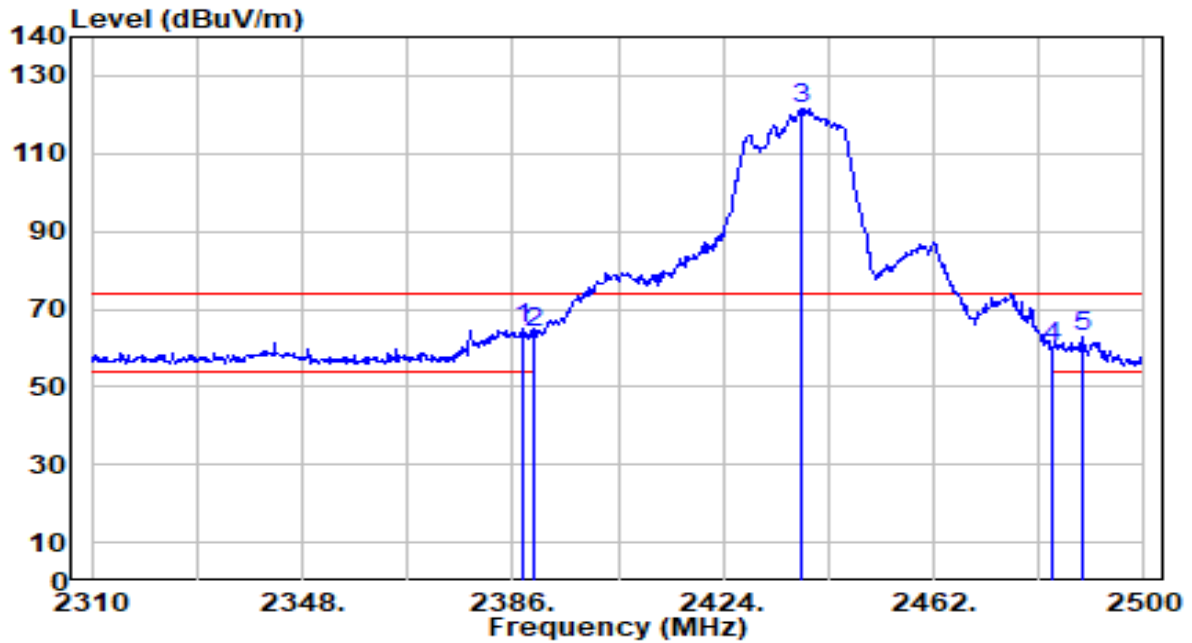

No	Frequency (MHz)	Reading (dBuV)	C.F (dB/m)	Measurement (dBuV/m)	Margin (dB)	Limit (dBuV/m)	Height (cm)	Angle (deg)	Remark (QP/PK/AV)	
1	*	2387.710	34.41	30.44	64.85	-9.15	74.00	308	192	Peak
2		2390.000	33.24	30.45	63.69	-10.31	74.00	308	192	Peak
3		2438.060	91.18	30.53	121.71	N/A	N/A	308	192	Peak
4		2483.500	29.77	30.59	60.36	-13.64	74.00	308	192	Peak
5		2488.790	32.26	30.59	62.86	-11.14	74.00	308	192	Peak

Note:

1. " \*", means this data is the worst emission level.
2. C.F (Correction Factor) = Antenna Factor (dB/m)+ Cable Loss (dB).
3. Measurement (dBuV/m) = Reading(dBuV) + C.F (Correction Factor).
4. The emission levels of other frequencies are very lower than the limit and not show in test report.

EUT	BE5000 Whole Home Mesh Wi-Fi 7 System	Date of Test	2024-03-23
Factor	DRH18-E	Temp. / Humidity	24°C /60%
Polarity	Vertical	Site / Test Engineer	AC2 / Marvin
Test Mode	802.11ax-20MHz_TX_CH 6_ANT 0+1	Test Voltage	AC 120V/60Hz

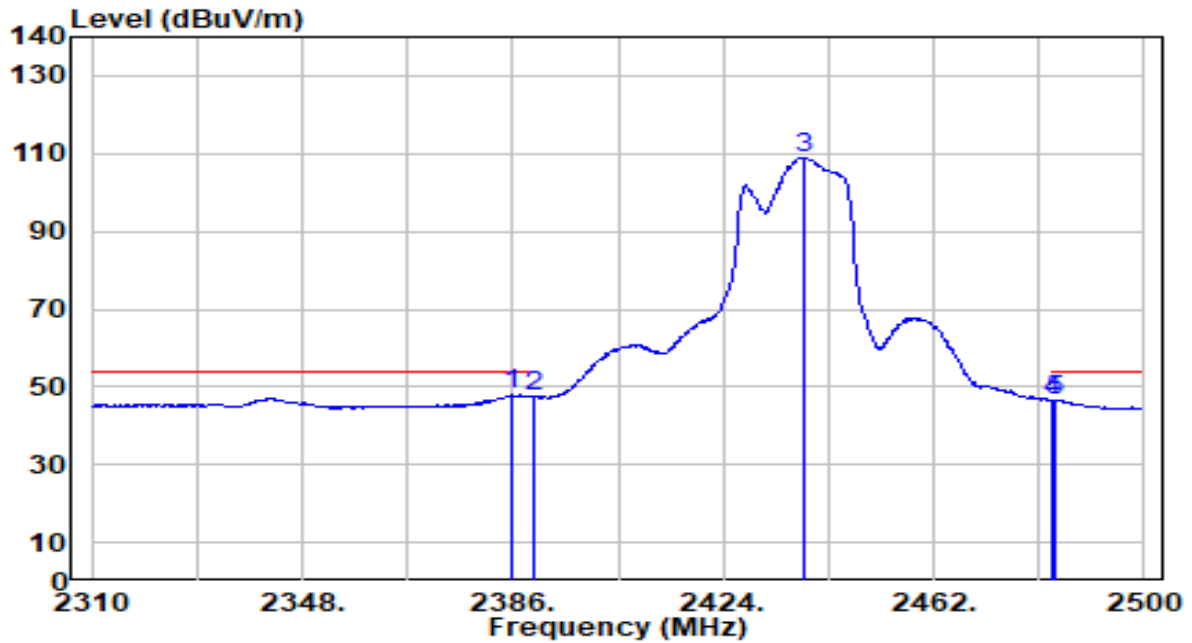

No	Frequency (MHz)	Reading (dBuV)	C.F (dB/m)	Measurement (dBuV/m)	Margin (dB)	Limit (dBuV/m)	Height (cm)	Angle (deg)	Remark (QP/PK/AV)	
1	*	2386.000	17.43	30.44	47.86	-6.14	54.00	308	192	Average
2		2390.000	16.86	30.45	47.31	-6.69	54.00	308	192	Average
3		2438.820	78.51	30.53	109.04	N/A	N/A	308	192	Average
4		2483.500	16.06	30.59	46.65	-7.35	54.00	308	192	Average
5		2484.040	15.90	30.59	46.49	-7.51	54.00	308	192	Average

Note:

1. " \*", means this data is the worst emission level.
2. C.F (Correction Factor) = Antenna Factor (dB/m)+ Cable Loss (dB).
3. Measurement (dBuV/m) = Reading(dBuV) + C.F (Correction Factor).
4. The emission levels of other frequencies are very lower than the limit and not show in test report.



EUT	BE5000 Whole Home Mesh Wi-Fi 7 System	Date of Test	2024-03-23
Factor	DRH18-E	Temp. / Humidity	24°C /60%
Polarity	Horizontal	Site / Test Engineer	AC2 / Marvin
Test Mode	802.11ax-20MHz_TX_CH 11_ANT 0+1	Test Voltage	AC 120V/60Hz

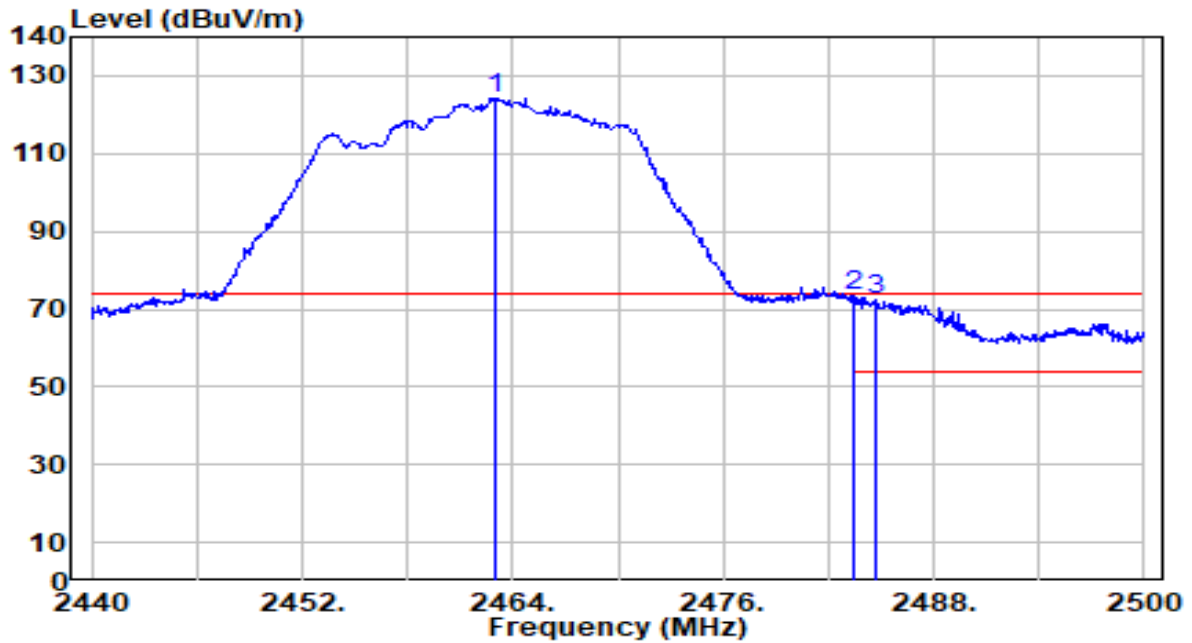

No	Frequency (MHz)	Reading (dBuV)	C.F (dB/m)	Measurement (dBuV/m)	Margin (dB)	Limit (dBuV/m)	Height (cm)	Angle (deg)	Remark (QP/PK/AV)
1	2463.040	93.62	30.56	124.18	N/A	N/A	304	263	Peak
2	* 2483.500	43.03	30.59	73.62	-0.38	74.00	304	263	Peak
3	2484.640	41.78	30.59	72.37	-1.63	74.00	304	263	Peak

Note:

1. " \*", means this data is the worst emission level.
2. C.F (Correction Factor) = Antenna Factor (dB/m)+ Cable Loss (dB).
3. Measurement (dBuV/m) = Reading(dBuV) + C.F (Correction Factor).
4. The emission levels of other frequencies are very lower than the limit and not show in test report.

EUT	BE5000 Whole Home Mesh Wi-Fi 7 System	Date of Test	2024-03-23
Factor	DRH18-E	Temp. / Humidity	24°C /60%
Polarity	Horizontal	Site / Test Engineer	AC2 / Marvin
Test Mode	802.11ax-20MHz_TX_CH 11_ANT 0+1	Test Voltage	AC 120V/60Hz

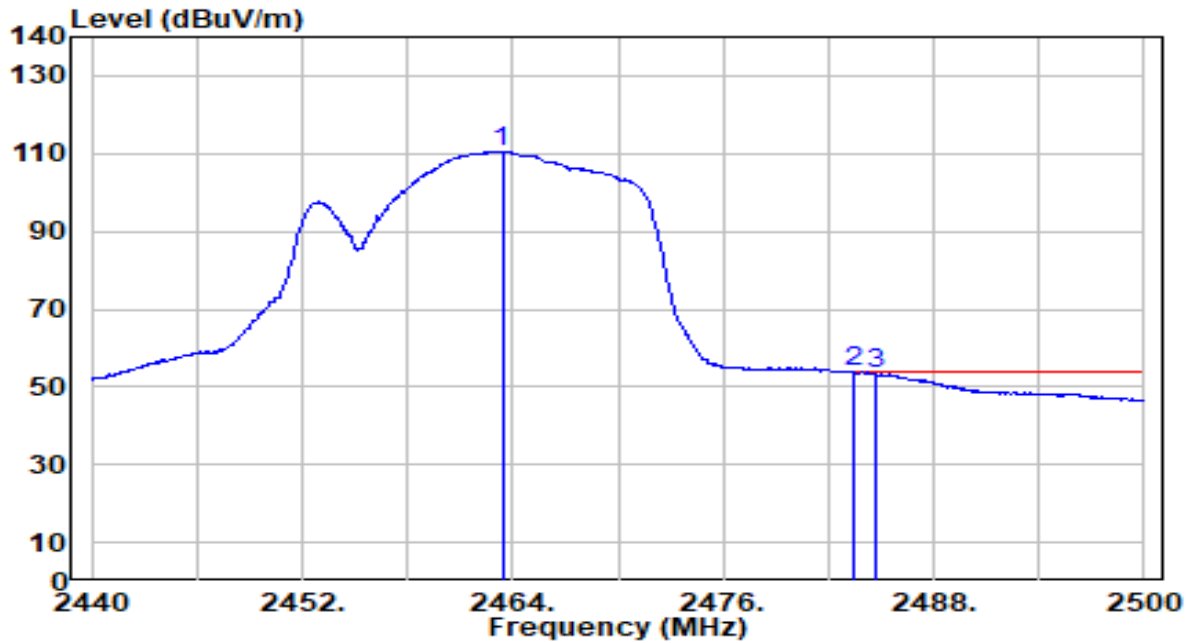

No	Frequency (MHz)	Reading (dBuV)	C.F (dB/m)	Measurement (dBuV/m)	Margin (dB)	Limit (dBuV/m)	Height (cm)	Angle (deg)	Remark (QP/PK/AV)
1	2463.400	80.08	30.56	110.64	N/A	N/A	304	263	Average
2	* 2483.500	23.22	30.59	53.81	-0.19	54.00	304	263	Average
3	2484.640	22.76	30.59	53.35	-0.65	54.00	304	263	Average

Note:

1. " \*", means this data is the worst emission level.
2. C.F (Correction Factor) = Antenna Factor (dB/m)+ Cable Loss (dB).
3. Measurement (dBuV/m) = Reading(dBuV) + C.F (Correction Factor).
4. The emission levels of other frequencies are very lower than the limit and not show in test report.

EUT	BE5000 Whole Home Mesh Wi-Fi 7 System	Date of Test	2024-03-23
Factor	DRH18-E	Temp. / Humidity	24°C /60%
Polarity	Vertical	Site / Test Engineer	AC2 / Marvin
Test Mode	802.11ax-20MHz_TX_CH 11_ANT 0+1	Test Voltage	AC 120V/60Hz

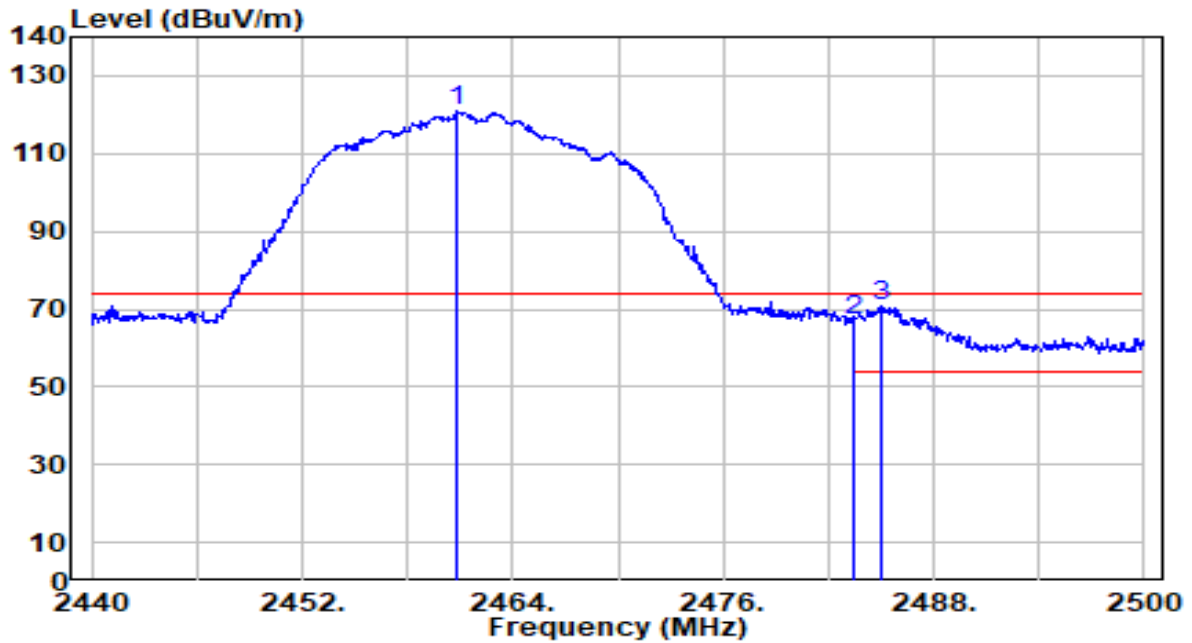

No	Frequency (MHz)	Reading (dBuV)	C.F (dB/m)	Measurement (dBuV/m)	Margin (dB)	Limit (dBuV/m)	Height (cm)	Angle (deg)	Remark (QP/PK/AV)
1	2460.880	90.21	30.56	120.76	N/A	N/A	206	169	Peak
2	2483.500	36.76	30.59	67.35	-6.65	74.00	206	169	Peak
3	* 2485.000	40.22	30.59	70.81	-3.19	74.00	206	169	Peak

Note:

1. " \*", means this data is the worst emission level.
2. C.F (Correction Factor) = Antenna Factor (dB/m)+ Cable Loss (dB).
3. Measurement (dBuV/m) = Reading(dBuV) + C.F (Correction Factor).
4. The emission levels of other frequencies are very lower than the limit and not show in test report.

EUT	BE5000 Whole Home Mesh Wi-Fi 7 System	Date of Test	2024-03-23
Factor	DRH18-E	Temp. / Humidity	24°C /60%
Polarity	Vertical	Site / Test Engineer	AC2 / Marvin
Test Mode	802.11ax-20MHz_TX_CH 11_ANT 0+1	Test Voltage	AC 120V/60Hz

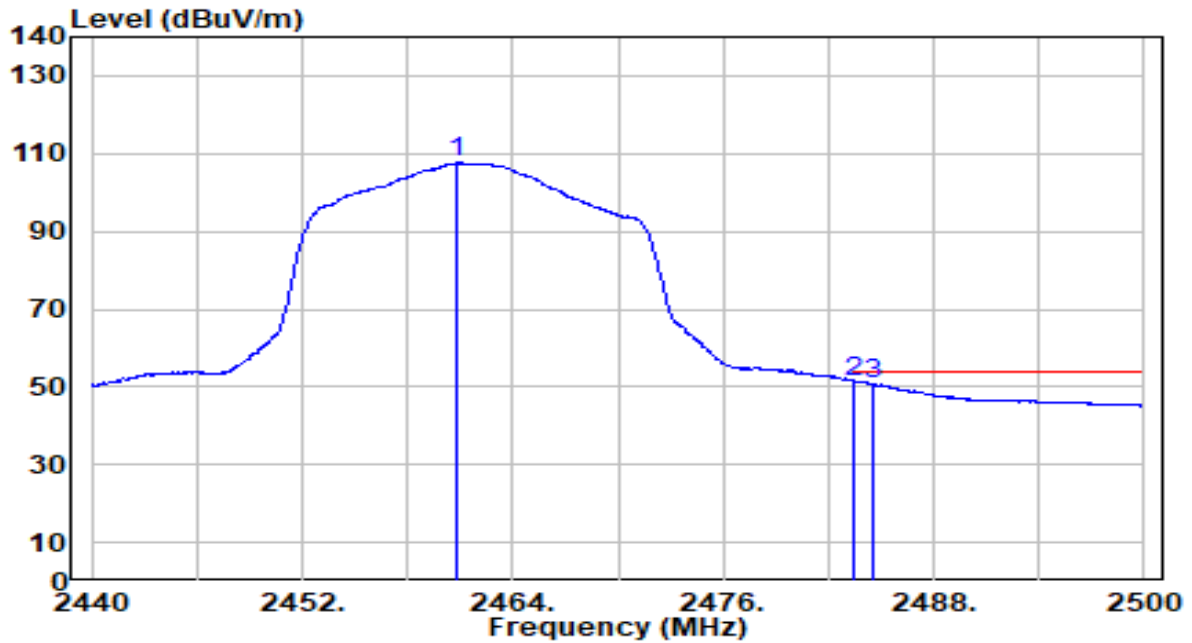

No	Frequency (MHz)	Reading (dBuV)	C.F (dB/m)	Measurement (dBuV/m)	Margin (dB)	Limit (dBuV/m)	Height (cm)	Angle (deg)	Remark (QP/PK/AV)
1	2460.880	77.28	30.56	107.84	N/A	N/A	206	169	Average
2	* 2483.500	20.89	30.59	51.48	-2.52	54.00	206	169	Average
3	2484.580	20.07	30.59	50.66	-3.34	54.00	206	169	Average

Note:

1. " \*", means this data is the worst emission level.
2. C.F (Correction Factor) = Antenna Factor (dB/m)+ Cable Loss (dB).
3. Measurement (dBuV/m) = Reading(dBuV) + C.F (Correction Factor).
4. The emission levels of other frequencies are very lower than the limit and not show in test report.

EUT	BE5000 Whole Home Mesh Wi-Fi 7 System	Date of Test	2024-03-23
Factor	DRH18-E	Temp. / Humidity	24°C /60%
Polarity	Horizontal	Site / Test Engineer	AC2 / Marvin
Test Mode	802.11ax-40MHz_TX_CH 3_ANT 0+1	Test Voltage	AC 120V/60Hz

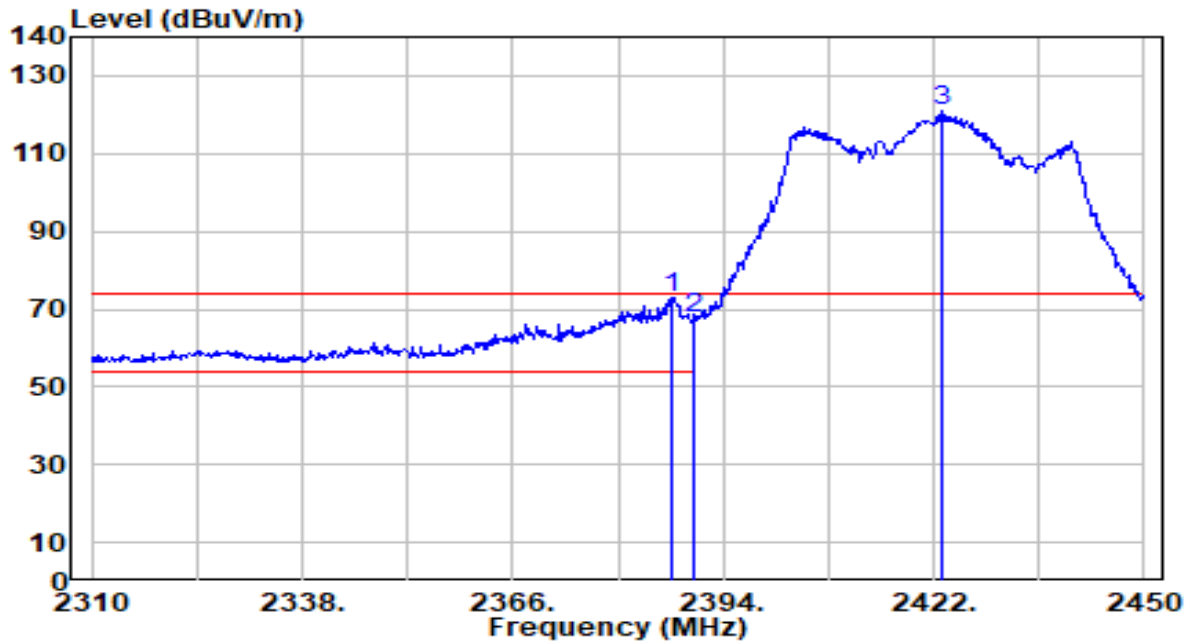

No	Frequency (MHz)	Reading (dBuV)	C.F (dB/m)	Measurement (dBuV/m)	Margin (dB)	Limit (dBuV/m)	Height (cm)	Angle (deg)	Remark (QP/PK/AV)	
1	*	2387.140	42.46	30.44	72.90	-1.10	74.00	130	86	Peak
2		2390.000	36.96	30.45	67.41	-6.59	74.00	130	86	Peak
3		2423.260	90.34	30.51	120.84	N/A	N/A	130	86	Peak

Note:

1. " \*", means this data is the worst emission level.
2. C.F (Correction Factor) = Antenna Factor (dB/m)+ Cable Loss (dB).
3. Measurement (dBuV/m) = Reading(dBuV) + C.F (Correction Factor).
4. The emission levels of other frequencies are very lower than the limit and not show in test report.

EUT	BE5000 Whole Home Mesh Wi-Fi 7 System	Date of Test	2024-03-23
Factor	DRH18-E	Temp. / Humidity	24°C /60%
Polarity	Horizontal	Site / Test Engineer	AC2 / Marvin
Test Mode	802.11ax-40MHz_TX_CH 3_ANT 0+1	Test Voltage	AC 120V/60Hz

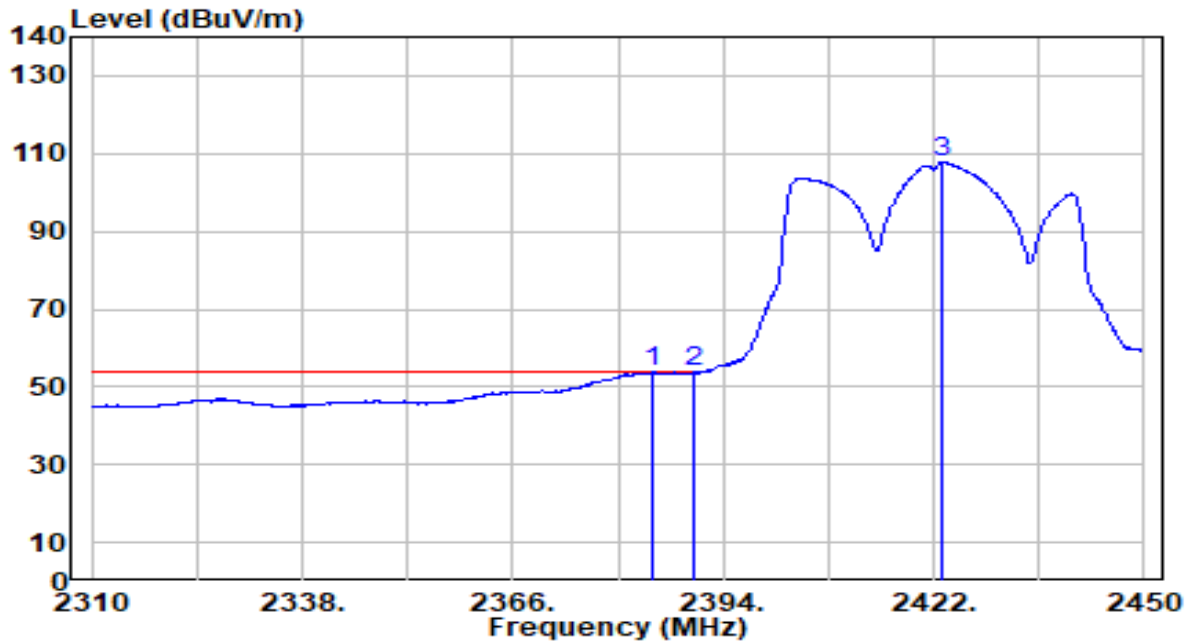

No	Frequency (MHz)	Reading (dBuV)	C.F (dB/m)	Measurement (dBuV/m)	Margin (dB)	Limit (dBuV/m)	Height (cm)	Angle (deg)	Remark (QP/PK/AV)
1	*	23.38	30.43	53.81	-0.19	54.00	130	86	Average
2		23.32	30.45	53.77	-0.23	54.00	130	86	Average
3		77.19	30.51	107.69	N/A	N/A	130	86	Average

Note:

1. "\*" , means this data is the worst emission level.
2. C.F (Correction Factor) = Antenna Factor (dB/m)+ Cable Loss (dB).
3. Measurement (dBuV/m) = Reading(dBuV) + C.F (Correction Factor).
4. The emission levels of other frequencies are very lower than the limit and not show in test report.

EUT	BE5000 Whole Home Mesh Wi-Fi 7 System	Date of Test	2024-03-23
Factor	DRH18-E	Temp. / Humidity	24°C /60%
Polarity	Vertical	Site / Test Engineer	AC2 / Marvin
Test Mode	802.11ax-40MHz_TX_CH 3_ANT 0+1	Test Voltage	AC 120V/60Hz

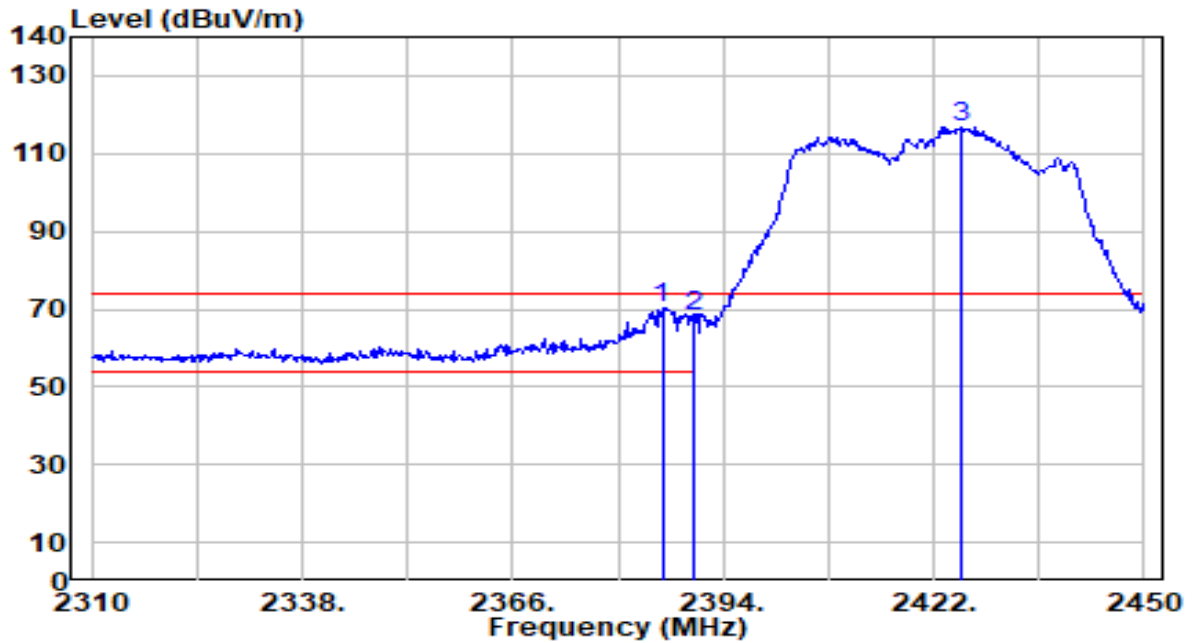

No	Frequency (MHz)	Reading (dBUV)	C.F (dB/m)	Measurement (dBUV/m)	Margin (dB)	Limit (dBUV/m)	Height (cm)	Angle (deg)	Remark (QP/PK/AV)	
1	*	2385.880	39.69	30.44	70.13	-3.87	74.00	309	190	Peak
2		2390.000	37.93	30.45	68.38	-5.62	74.00	309	190	Peak
3		2425.780	86.18	30.51	116.69	N/A	N/A	309	190	Peak

Note:

1. " \*", means this data is the worst emission level.
2. C.F (Correction Factor) = Antenna Factor (dB/m)+ Cable Loss (dB).
3. Measurement (dBUV/m) = Reading(dBUV) + C.F (Correction Factor).
4. The emission levels of other frequencies are very lower than the limit and not show in test report.

EUT	BE5000 Whole Home Mesh Wi-Fi 7 System	Date of Test	2024-03-23
Factor	DRH18-E	Temp. / Humidity	24°C /60%
Polarity	Vertical	Site / Test Engineer	AC2 / Marvin
Test Mode	802.11ax-40MHz_TX_CH 3_ANT 0+1	Test Voltage	AC 120V/60Hz

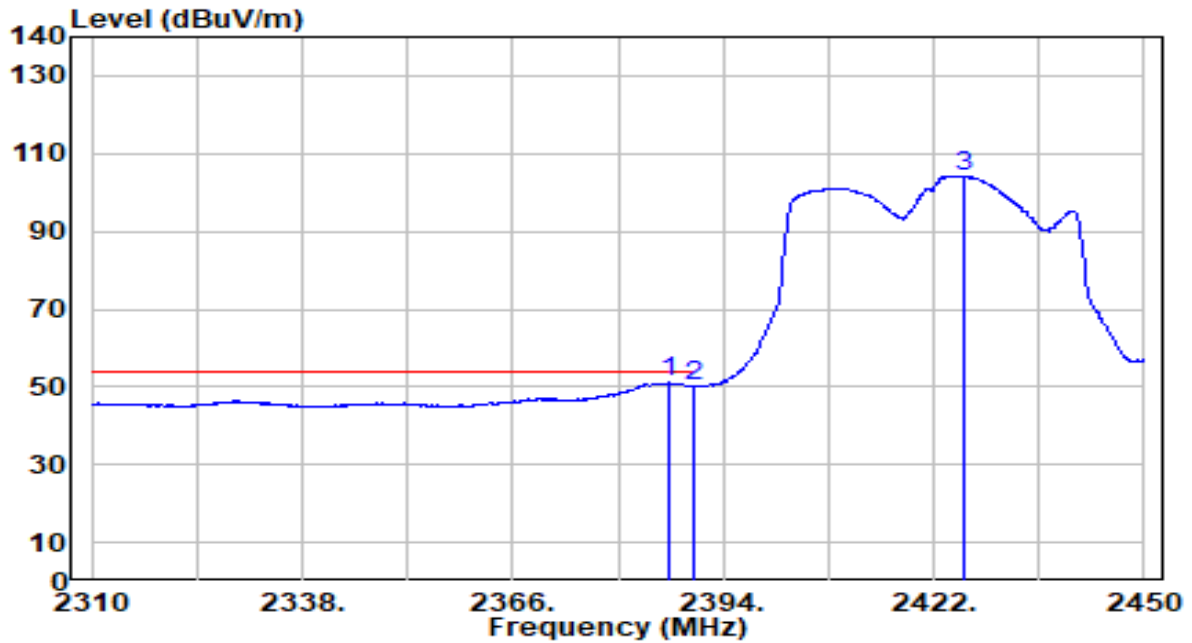

No	Frequency (MHz)	Reading (dBuV)	C.F (dB/m)	Measurement (dBuV/m)	Margin (dB)	Limit (dBuV/m)	Height (cm)	Angle (deg)	Remark (QP/PK/AV)
1	*	20.62	30.44	51.06	-2.94	54.00	309	190	Average
2		19.98	30.45	50.43	-3.57	54.00	309	190	Average
3		73.74	30.51	104.25	N/A	N/A	309	190	Average

Note:

1. " \*", means this data is the worst emission level.
2. C.F (Correction Factor) = Antenna Factor (dB/m)+ Cable Loss (dB).
3. Measurement (dBuV/m) = Reading(dBuV) + C.F (Correction Factor).
4. The emission levels of other frequencies are very lower than the limit and not show in test report.



EUT	BE5000 Whole Home Mesh Wi-Fi 7 System	Date of Test	2024-03-23
Factor	DRH18-E	Temp. / Humidity	24°C /60%
Polarity	Horizontal	Site / Test Engineer	AC2 / Marvin
Test Mode	802.11ax-40MHz_TX_CH 6_ANT 0+1	Test Voltage	AC 120V/60Hz

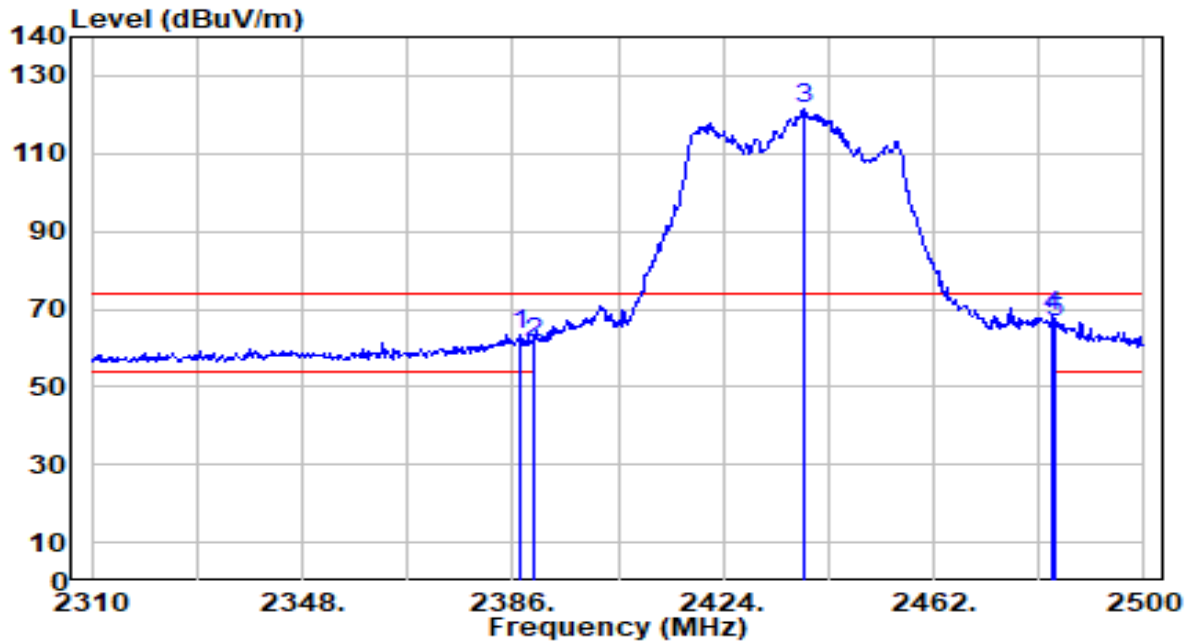

No	Frequency (MHz)	Reading (dBUV)	C.F (dB/m)	Measurement (dBUV/m)	Margin (dB)	Limit (dBUV/m)	Height (cm)	Angle (deg)	Remark (QP/PK/AV)
1	2387.140	33.10	30.44	63.54	-10.46	74.00	314	263	Peak
2	2390.000	30.95	30.45	61.40	-12.60	74.00	314	263	Peak
3	2438.820	90.79	30.53	121.32	N/A	N/A	314	263	Peak
4	* 2483.500	37.30	30.59	67.89	-6.11	74.00	314	263	Peak
5	2484.040	36.14	30.59	66.73	-7.27	74.00	314	263	Peak

Note:

- "\*" means this data is the worst emission level.
- C.F (Correction Factor) = Antenna Factor (dB/m)+ Cable Loss (dB).
- Measurement (dBUV/m) = Reading(dBUV) + C.F (Correction Factor).
- The emission levels of other frequencies are very lower than the limit and not show in test report.

EUT	BE5000 Whole Home Mesh Wi-Fi 7 System	Date of Test	2024-03-23
Factor	DRH18-E	Temp. / Humidity	24°C /60%
Polarity	Horizontal	Site / Test Engineer	AC2 / Marvin
Test Mode	802.11ax-40MHz_TX_CH 6_ANT 0+1	Test Voltage	AC 120V/60Hz

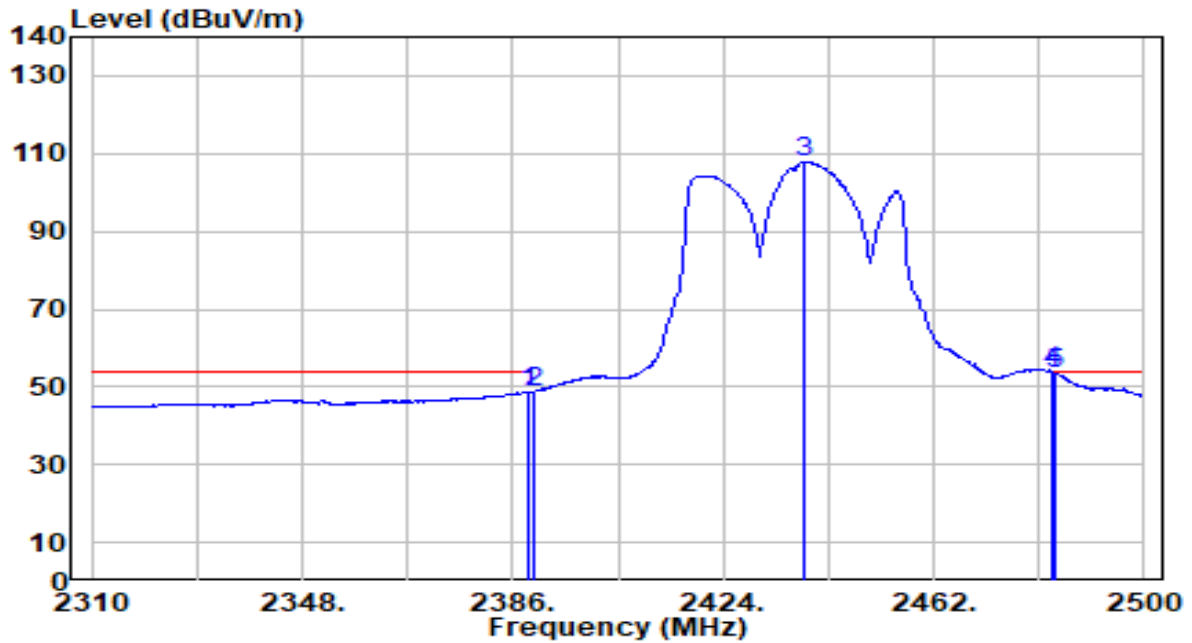

No	Frequency (MHz)	Reading (dBuV)	C.F (dB/m)	Measurement (dBuV/m)	Margin (dB)	Limit (dBuV/m)	Height (cm)	Angle (deg)	Remark (QP/PK/AV)
1	2388.660	18.20	30.44	48.65	-5.35	54.00	314	263	Average
2	2390.000	18.36	30.45	48.81	-5.19	54.00	314	263	Average
3	2438.630	77.43	30.53	107.96	N/A	N/A	314	263	Average
4	* 2483.500	23.25	30.59	53.84	-0.16	54.00	314	263	Average
5	2484.040	22.93	30.59	53.52	-0.48	54.00	314	263	Average

Note:

- "\*" means this data is the worst emission level.
- C.F (Correction Factor) = Antenna Factor (dB/m)+ Cable Loss (dB).
- Measurement (dBuV/m) = Reading(dBuV) + C.F (Correction Factor).
- The emission levels of other frequencies are very lower than the limit and not show in test report.

EUT	BE5000 Whole Home Mesh Wi-Fi 7 System	Date of Test	2024-03-23
Factor	DRH18-E	Temp. / Humidity	24°C /60%
Polarity	Vertical	Site / Test Engineer	AC2 / Marvin
Test Mode	802.11ax-40MHz_TX_CH 6_ANT 0+1	Test Voltage	AC 120V/60Hz

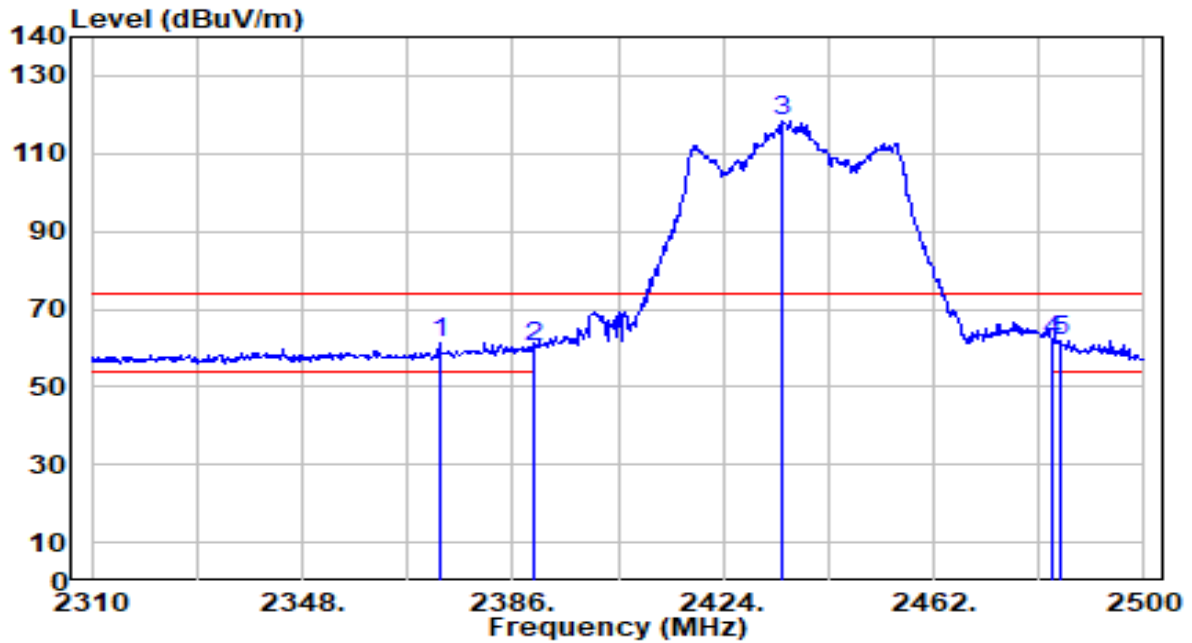

No	Frequency (MHz)	Reading (dBuV)	C.F (dB/m)	Measurement (dBuV/m)	Margin (dB)	Limit (dBuV/m)	Height (cm)	Angle (deg)	Remark (QP/PK/AV)
1	2372.700	31.03	30.40	61.43	-12.57	74.00	223	176	Peak
2	2390.000	29.56	30.45	60.01	-13.99	74.00	223	176	Peak
3	2434.830	87.93	30.52	118.45	N/A	N/A	223	176	Peak
4	2483.500	31.19	30.59	61.78	-12.22	74.00	223	176	Peak
5	* 2484.800	31.41	30.59	62.00	-12.00	74.00	223	176	Peak

Note:

1. " \*", means this data is the worst emission level.
2. C.F (Correction Factor) = Antenna Factor (dB/m)+ Cable Loss (dB).
3. Measurement (dBuV/m) = Reading(dBuV) + C.F (Correction Factor).
4. The emission levels of other frequencies are very lower than the limit and not show in test report.

EUT	BE5000 Whole Home Mesh Wi-Fi 7 System	Date of Test	2024-03-23
Factor	DRH18-E	Temp. / Humidity	24°C /60%
Polarity	Vertical	Site / Test Engineer	AC2 / Marvin
Test Mode	802.11ax-40MHz_TX_CH 6_ANT 0+1	Test Voltage	AC 120V/60Hz

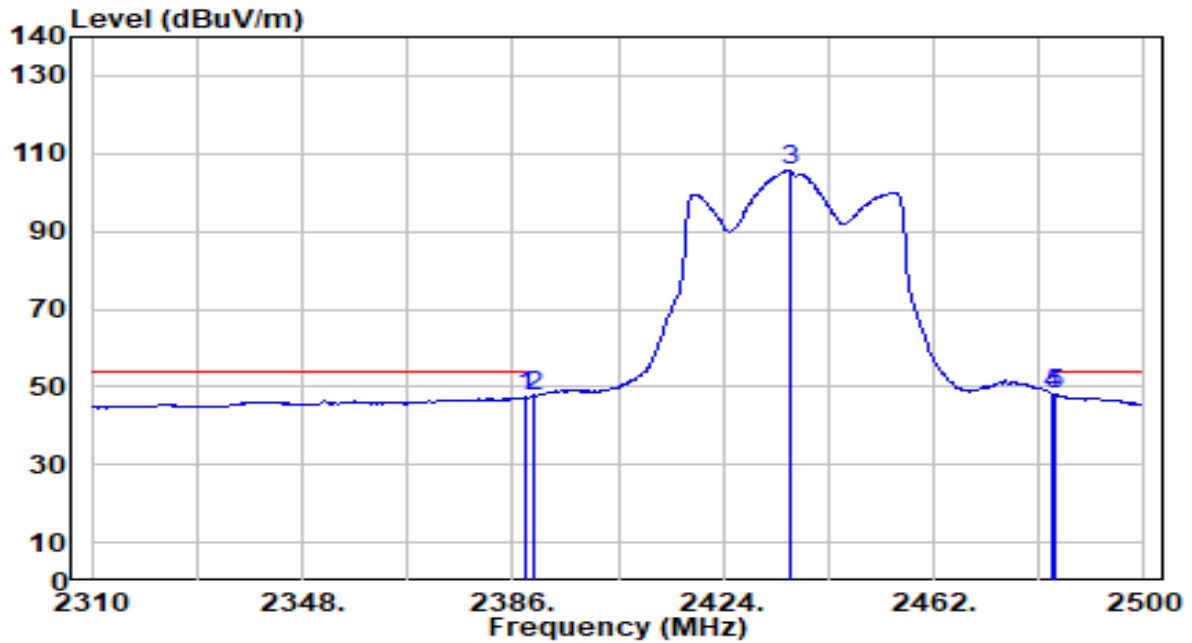

No	Frequency (MHz)	Reading (dBuV)	C.F (dB/m)	Measurement (dBuV/m)	Margin (dB)	Limit (dBuV/m)	Height (cm)	Angle (deg)	Remark (QP/PK/AV)
1	2388.470	16.93	30.44	47.37	-6.63	54.00	223	176	Average
2	2390.000	17.14	30.45	47.58	-6.42	54.00	223	176	Average
3	2435.970	75.10	30.52	105.63	N/A	N/A	223	176	Average
4	* 2483.500	17.60	30.59	48.19	-5.81	54.00	223	176	Average
5	2484.040	17.42	30.59	48.01	-5.99	54.00	223	176	Average

Note:

1. " \*", means this data is the worst emission level.
2. C.F (Correction Factor) = Antenna Factor (dB/m)+ Cable Loss (dB).
3. Measurement (dBuV/m) = Reading(dBuV) + C.F (Correction Factor).
4. The emission levels of other frequencies are very lower than the limit and not show in test report.

EUT	BE5000 Whole Home Mesh Wi-Fi 7 System	Date of Test	2024-03-23
Factor	DRH18-E	Temp. / Humidity	24°C /60%
Polarity	Horizontal	Site / Test Engineer	AC2 / Marvin
Test Mode	802.11ax-40MHz_TX_CH 9_ANT 0+1	Test Voltage	AC 120V/60Hz

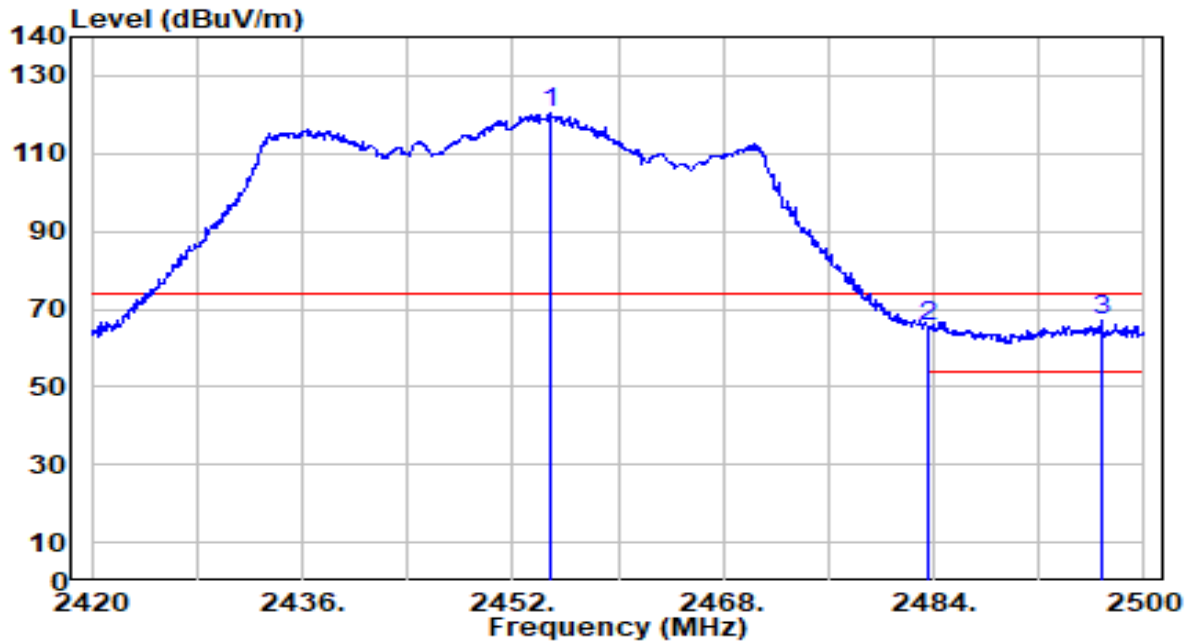

No	Frequency (MHz)	Reading (dBUV)	C.F (dB/m)	Measurement (dBUV/m)	Margin (dB)	Limit (dBUV/m)	Height (cm)	Angle (deg)	Remark (QP/PK/AV)
1	2454.960	89.84	30.55	120.39	N/A	N/A	313	261	Peak
2	2483.500	34.75	30.59	65.33	-8.67	74.00	313	261	Peak
3	* 2496.720	36.47	30.61	67.08	-6.92	74.00	313	261	Peak

Note:

1. " \*", means this data is the worst emission level.
2. C.F (Correction Factor) = Antenna Factor (dB/m)+ Cable Loss (dB).
3. Measurement (dBUV/m) = Reading(dBUV) + C.F (Correction Factor).
4. The emission levels of other frequencies are very lower than the limit and not show in test report.

EUT	BE5000 Whole Home Mesh Wi-Fi 7 System	Date of Test	2024-03-23
Factor	DRH18-E	Temp. / Humidity	24°C /60%
Polarity	Horizontal	Site / Test Engineer	AC2 / Marvin
Test Mode	802.11ax-40MHz_TX_CH 9_ANT 0+1	Test Voltage	AC 120V/60Hz

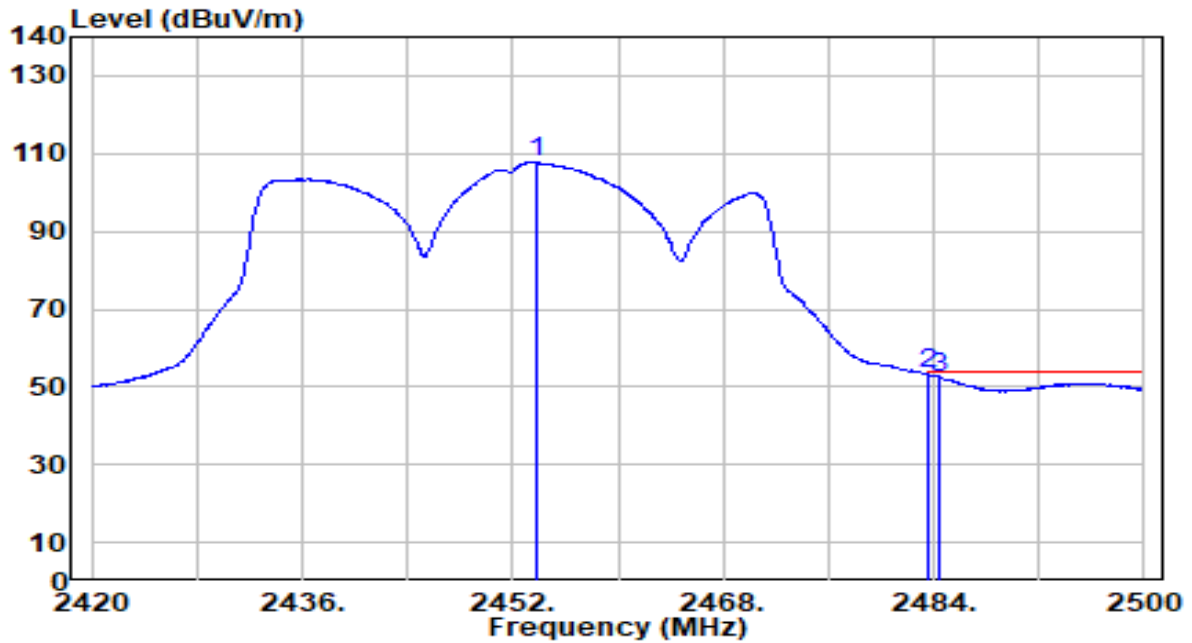

No	Frequency (MHz)	Reading (dBuV)	C.F (dB/m)	Measurement (dBuV/m)	Margin (dB)	Limit (dBuV/m)	Height (cm)	Angle (deg)	Remark (QP/PK/AV)
1	2453.840	77.11	30.55	107.66	N/A	N/A	313	261	Average
2	* 2483.500	22.65	30.59	53.23	-0.17	54.00	313	261	Average
3	2484.480	21.75	30.59	52.34	-1.26	54.00	313	261	Average

Note:

1. " \*", means this data is the worst emission level.
2. C.F (Correction Factor) = Antenna Factor (dB/m)+ Cable Loss (dB).
3. Measurement (dBuV/m) = Reading(dBuV) + C.F (Correction Factor).
4. The emission levels of other frequencies are very lower than the limit and not show in test report.

EUT	BE5000 Whole Home Mesh Wi-Fi 7 System	Date of Test	2024-03-23
Factor	DRH18-E	Temp. / Humidity	24°C /60%
Polarity	Vertical	Site / Test Engineer	AC2 / Marvin
Test Mode	802.11ax-40MHz_TX_CH 9_ANT 0+1	Test Voltage	AC 120V/60Hz

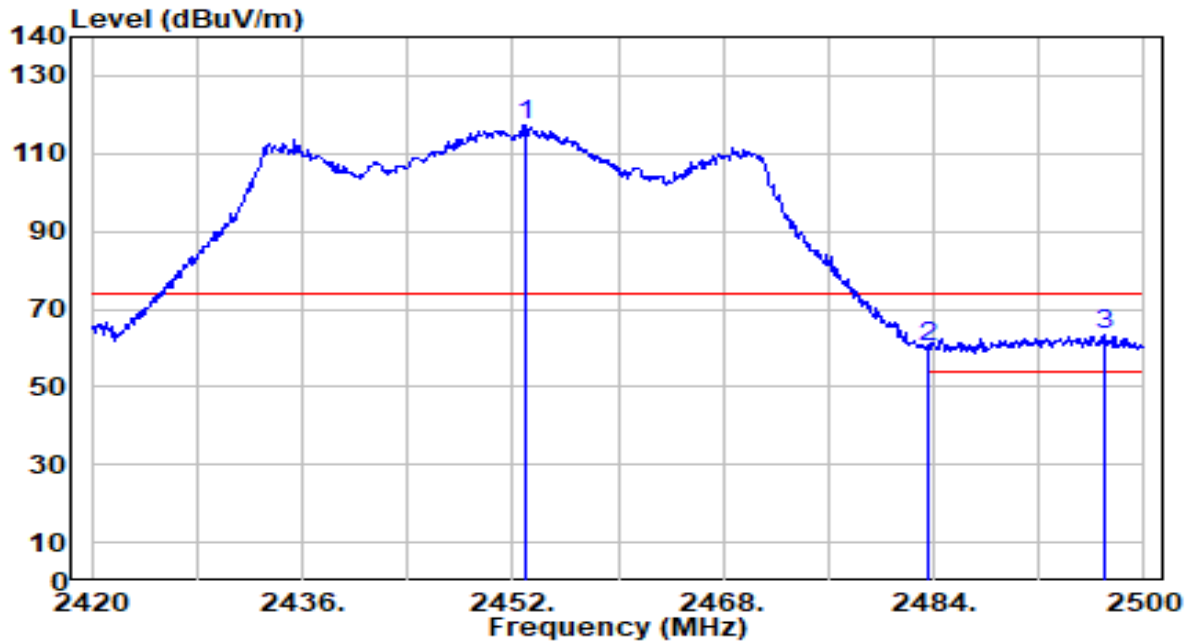

No	Frequency (MHz)	Reading (dBuV)	C.F (dB/m)	Measurement (dBuV/m)	Margin (dB)	Limit (dBuV/m)	Height (cm)	Angle (deg)	Remark (QP/PK/AV)
1	2453.040	86.77	30.55	117.32	N/A	N/A	200	166	Peak
2	2483.500	29.80	30.59	60.39	-13.61	74.00	200	166	Peak
3	* 2496.960	32.70	30.61	63.30	-10.70	74.00	200	166	Peak

Note:

1. " \*", means this data is the worst emission level.
2. C.F (Correction Factor) = Antenna Factor (dB/m)+ Cable Loss (dB).
3. Measurement (dBuV/m) = Reading(dBuV) + C.F (Correction Factor).
4. The emission levels of other frequencies are very lower than the limit and not show in test report.

EUT	BE5000 Whole Home Mesh Wi-Fi 7 System	Date of Test	2024-03-23
Factor	DRH18-E	Temp. / Humidity	24°C /60%
Polarity	Vertical	Site / Test Engineer	AC2 / Marvin
Test Mode	802.11ax-40MHz_TX_CH 9_ANT 0+1	Test Voltage	AC 120V/60Hz

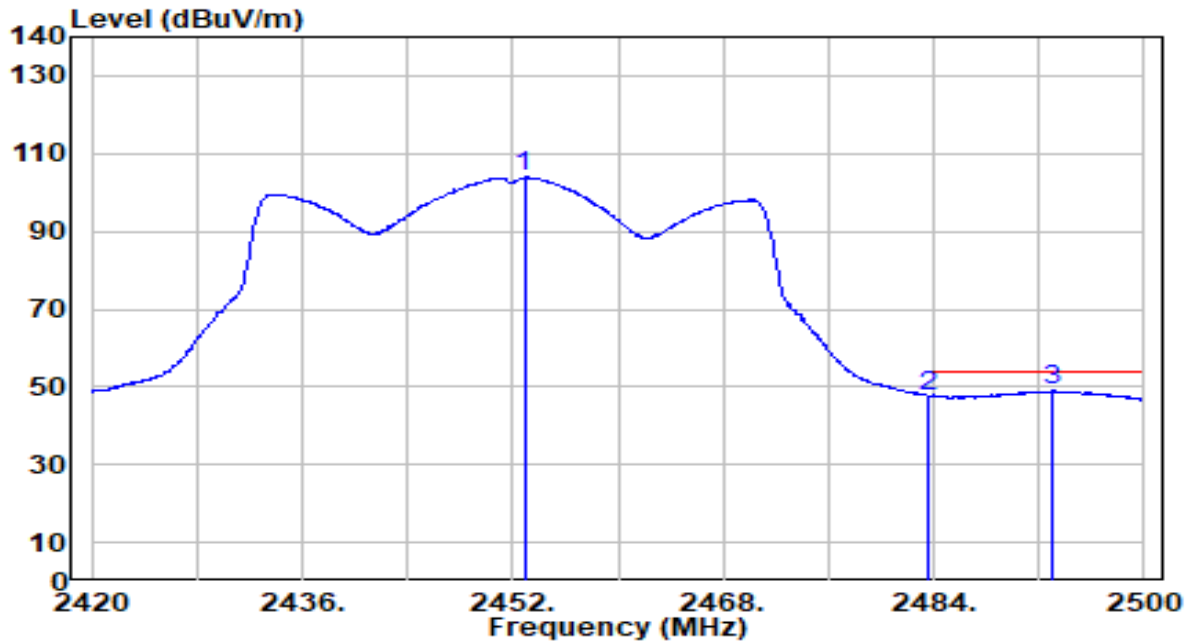

No	Frequency (MHz)	Reading (dBUV)	C.F (dB/m)	Measurement (dBUV/m)	Margin (dB)	Limit (dBUV/m)	Height (cm)	Angle (deg)	Remark (QP/PK/AV)
1	2452.880	73.44	30.55	103.99	N/A	N/A	200	166	Average
2	2483.500	17.21	30.59	47.80	-6.20	54.00	200	166	Average
3	* 2493.040	18.35	30.60	48.95	-5.05	54.00	200	166	Average

Note:

1. " \*", means this data is the worst emission level.
2. C.F (Correction Factor) = Antenna Factor (dB/m)+ Cable Loss (dB).
3. Measurement (dBUV/m) = Reading(dBUV) + C.F (Correction Factor).
4. The emission levels of other frequencies are very lower than the limit and not show in test report.



EUT	BE5000 Whole Home Mesh Wi-Fi 7 System	Date of Test	2024-03-23
Factor	DRH18-E	Temp. / Humidity	24°C /60%
Polarity	Horizontal	Site / Test Engineer	AC2 / Marvin
Test Mode	802.11be-20MHz_TX_CH 1_ANT 0+1	Test Voltage	AC 120V/60Hz

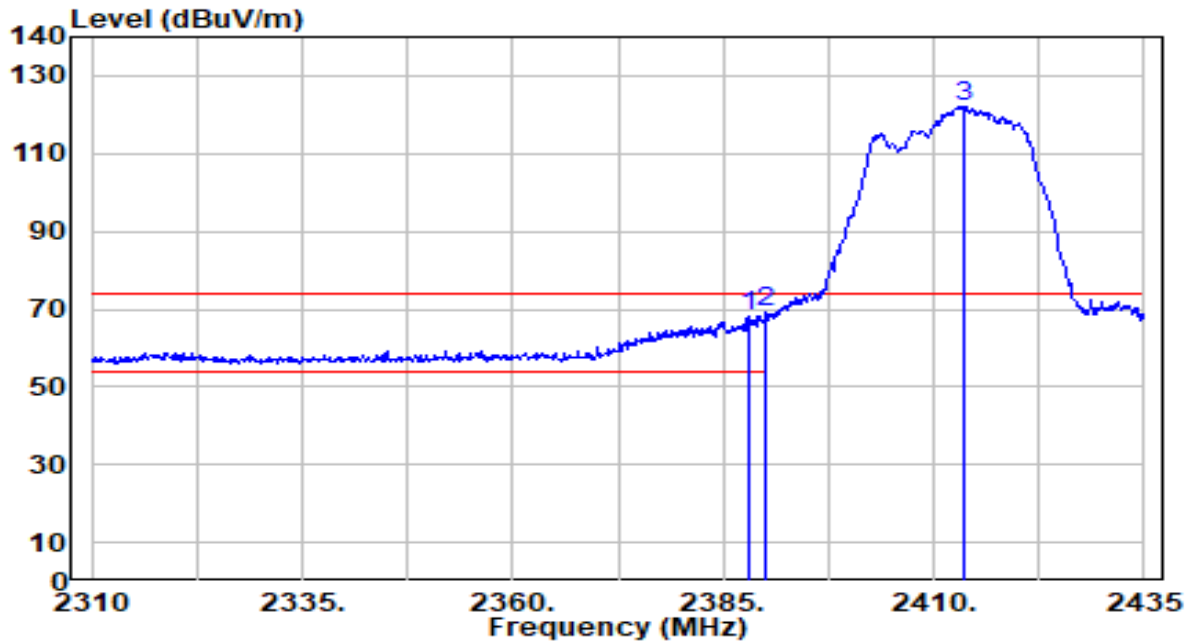

No	Frequency (MHz)	Reading (dBUV)	C.F (dB/m)	Measurement (dBUV/m)	Margin (dB)	Limit (dBUV/m)	Height (cm)	Angle (deg)	Remark (QP/PK/AV)
1	2388.125	37.56	30.44	68.00	-6.00	74.00	321	263	Peak
2	* 2390.000	38.67	30.45	69.12	-4.88	74.00	321	263	Peak
3	2413.500	91.59	30.49	122.09	N/A	N/A	321	263	Peak

Note:

1. " \*", means this data is the worst emission level.
2. C.F (Correction Factor) = Antenna Factor (dB/m)+ Cable Loss (dB).
3. Measurement (dBUV/m) = Reading(dBUV) + C.F (Correction Factor).
4. The emission levels of other frequencies are very lower than the limit and not show in test report.

EUT	BE5000 Whole Home Mesh Wi-Fi 7 System	Date of Test	2024-03-23
Factor	DRH18-E	Temp. / Humidity	24°C /60%
Polarity	Horizontal	Site / Test Engineer	AC2 / Marvin
Test Mode	802.11be-20MHz_TX_CH 1_ANT 0+1	Test Voltage	AC 120V/60Hz

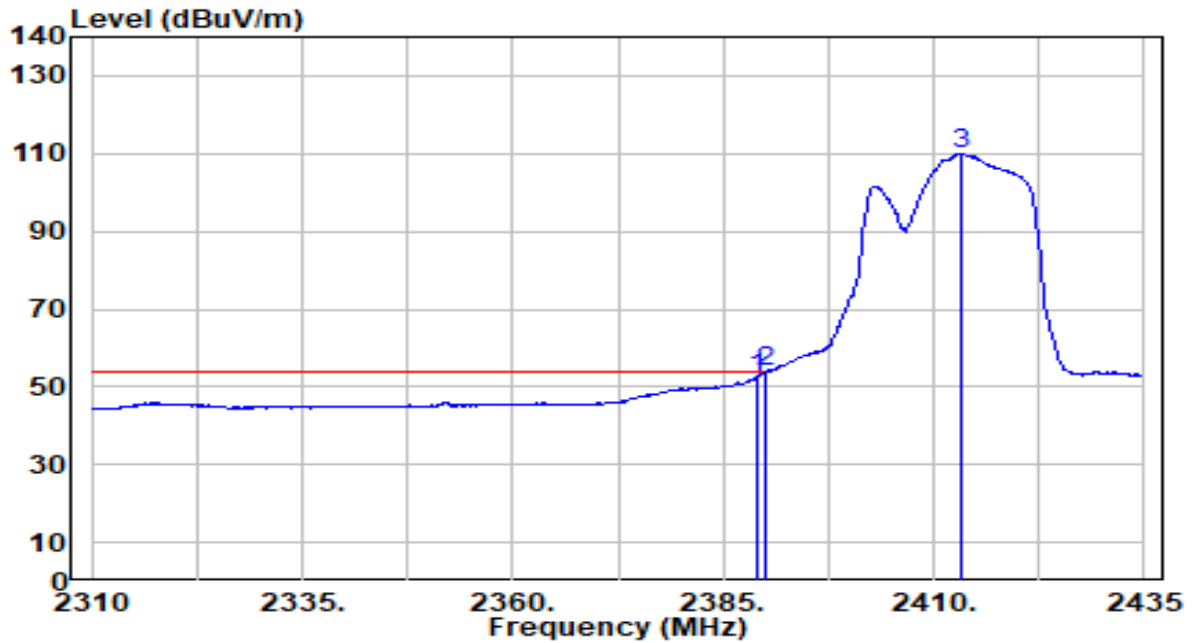

No	Frequency (MHz)	Reading (dBuV)	C.F (dB/m)	Measurement (dBuV/m)	Margin (dB)	Limit (dBuV/m)	Height (cm)	Angle (deg)	Remark (QP/PK/AV)
1	2389.000	21.89	30.44	52.34	-1.66	54.00	321	263	Average
2	* 2390.000	23.38	30.45	53.82	-0.18	54.00	321	263	Average
3	2413.125	79.64	30.49	110.14	N/A	N/A	321	263	Average

Note:

1. " \*", means this data is the worst emission level.
2. C.F (Correction Factor) = Antenna Factor (dB/m)+ Cable Loss (dB).
3. Measurement (dBuV/m) = Reading(dBuV) + C.F (Correction Factor).
4. The emission levels of other frequencies are very lower than the limit and not show in test report.

EUT	BE5000 Whole Home Mesh Wi-Fi 7 System	Date of Test	2024-03-23
Factor	DRH18-E	Temp. / Humidity	24°C /60%
Polarity	Vertical	Site / Test Engineer	AC2 / Marvin
Test Mode	802.11be-20MHz_TX_CH 1_ANT 0+1	Test Voltage	AC 120V/60Hz

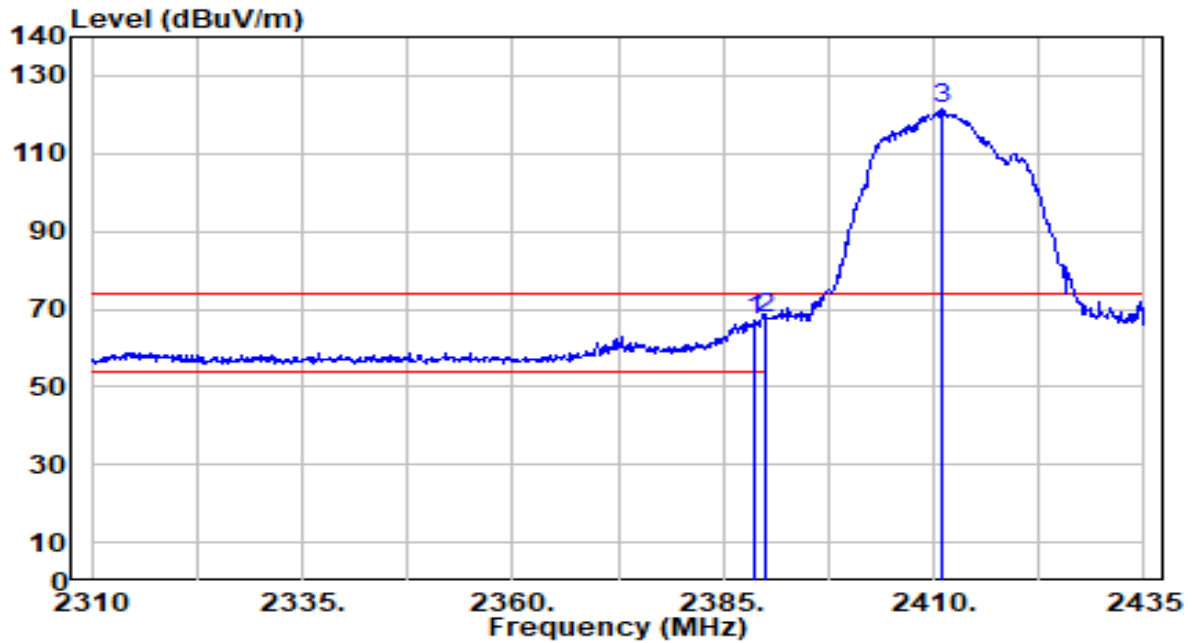

No	Frequency (MHz)	Reading (dBuV)	C.F (dB/m)	Measurement (dBuV/m)	Margin (dB)	Limit (dBuV/m)	Height (cm)	Angle (deg)	Remark (QP/PK/AV)
1	2388.750	36.46	30.44	66.91	-7.09	74.00	206	178	Peak
2	* 2390.000	37.27	30.45	67.72	-6.28	74.00	206	178	Peak
3	2410.875	90.96	30.49	121.45	N/A	N/A	206	178	Peak

Note:

1. " \*", means this data is the worst emission level.
2. C.F (Correction Factor) = Antenna Factor (dB/m)+ Cable Loss (dB).
3. Measurement (dBuV/m) = Reading(dBuV) + C.F (Correction Factor).
4. The emission levels of other frequencies are very lower than the limit and not show in test report.

EUT	BE5000 Whole Home Mesh Wi-Fi 7 System	Date of Test	2024-03-23
Factor	DRH18-E	Temp. / Humidity	24°C /60%
Polarity	Vertical	Site / Test Engineer	AC2 / Marvin
Test Mode	802.11be-20MHz_TX_CH 1_ANT 0+1	Test Voltage	AC 120V/60Hz

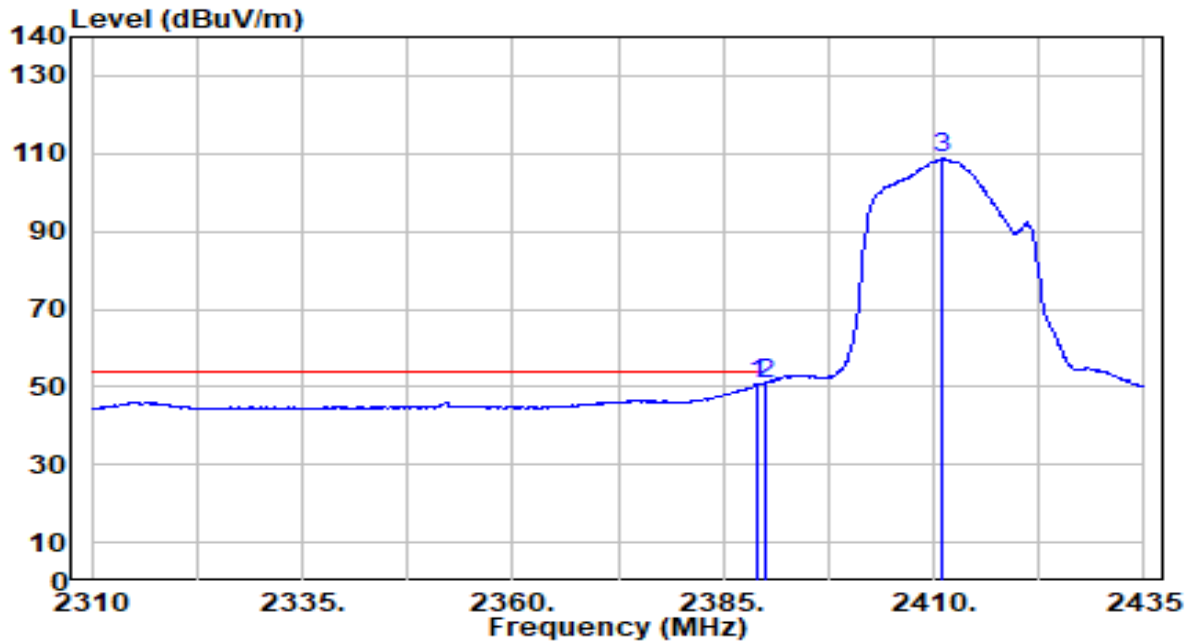

No	Frequency (MHz)	Reading (dBuV)	C.F (dB/m)	Measurement (dBuV/m)	Margin (dB)	Limit (dBuV/m)	Height (cm)	Angle (deg)	Remark (QP/PK/AV)
1	2389.000	20.04	30.44	50.49	-3.51	54.00	206	178	Average
2	* 2390.000	20.38	30.45	50.83	-3.17	54.00	206	178	Average
3	2411.125	78.18	30.49	108.67	N/A	N/A	206	178	Average

Note:

1. " \*", means this data is the worst emission level.
2. C.F (Correction Factor) = Antenna Factor (dB/m)+ Cable Loss (dB).
3. Measurement (dBuV/m) = Reading(dBuV) + C.F (Correction Factor).
4. The emission levels of other frequencies are very lower than the limit and not show in test report.

EUT	BE5000 Whole Home Mesh Wi-Fi 7 System	Date of Test	2024-03-23
Factor	DRH18-E	Temp. / Humidity	24°C /60%
Polarity	Horizontal	Site / Test Engineer	AC2 / Marvin
Test Mode	802.11be-20MHz_TX_CH 6_ANT 0+1	Test Voltage	AC 120V/60Hz

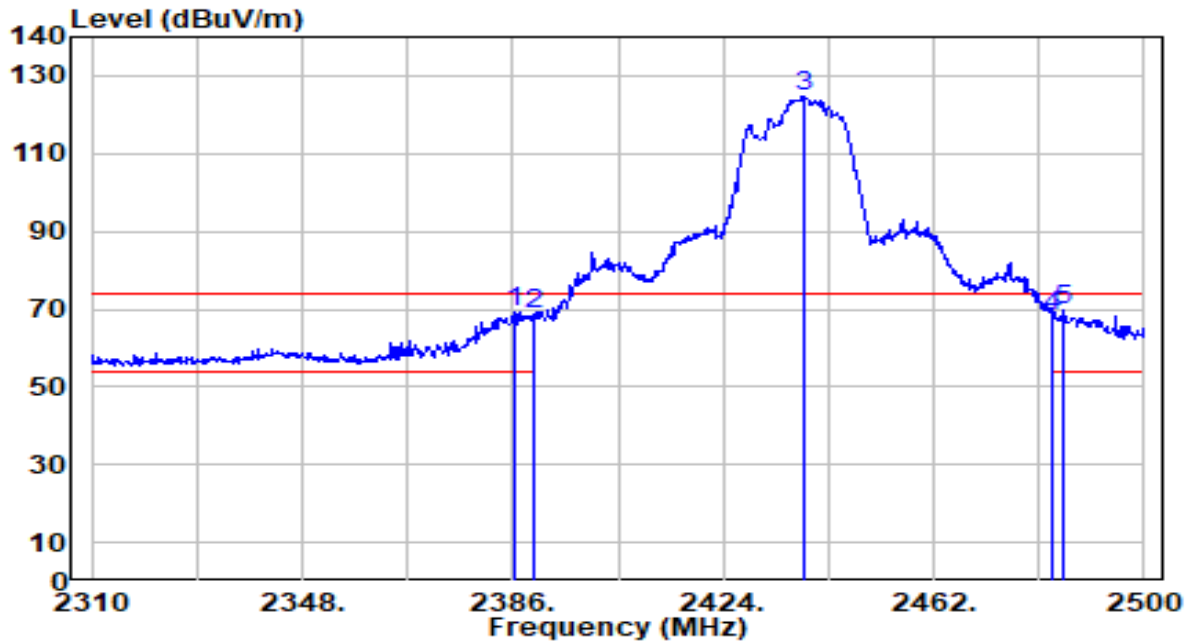

No	Frequency (MHz)	Reading (dBuV)	C.F (dB/m)	Measurement (dBuV/m)	Margin (dB)	Limit (dBuV/m)	Height (cm)	Angle (deg)	Remark (QP/PK/AV)
1	2386.570	38.94	30.44	69.38	-4.62	74.00	310	262	Peak
2	2390.000	37.98	30.45	68.43	-5.57	74.00	310	262	Peak
3	2438.440	94.32	30.53	124.85	N/A	N/A	310	262	Peak
4	2483.500	37.35	30.59	67.94	-6.06	74.00	310	262	Peak
5	* 2485.560	38.95	30.59	69.54	-4.46	74.00	310	262	Peak

Note:

1. " \*", means this data is the worst emission level.
2. C.F (Correction Factor) = Antenna Factor (dB/m)+ Cable Loss (dB).
3. Measurement (dBuV/m) = Reading(dBuV) + C.F (Correction Factor).
4. The emission levels of other frequencies are very lower than the limit and not show in test report.

EUT	BE5000 Whole Home Mesh Wi-Fi 7 System	Date of Test	2024-03-23
Factor	DRH18-E	Temp. / Humidity	24°C /60%
Polarity	Horizontal	Site / Test Engineer	AC2 / Marvin
Test Mode	802.11be-20MHz_TX_CH 6_ANT 0+1	Test Voltage	AC 120V/60Hz

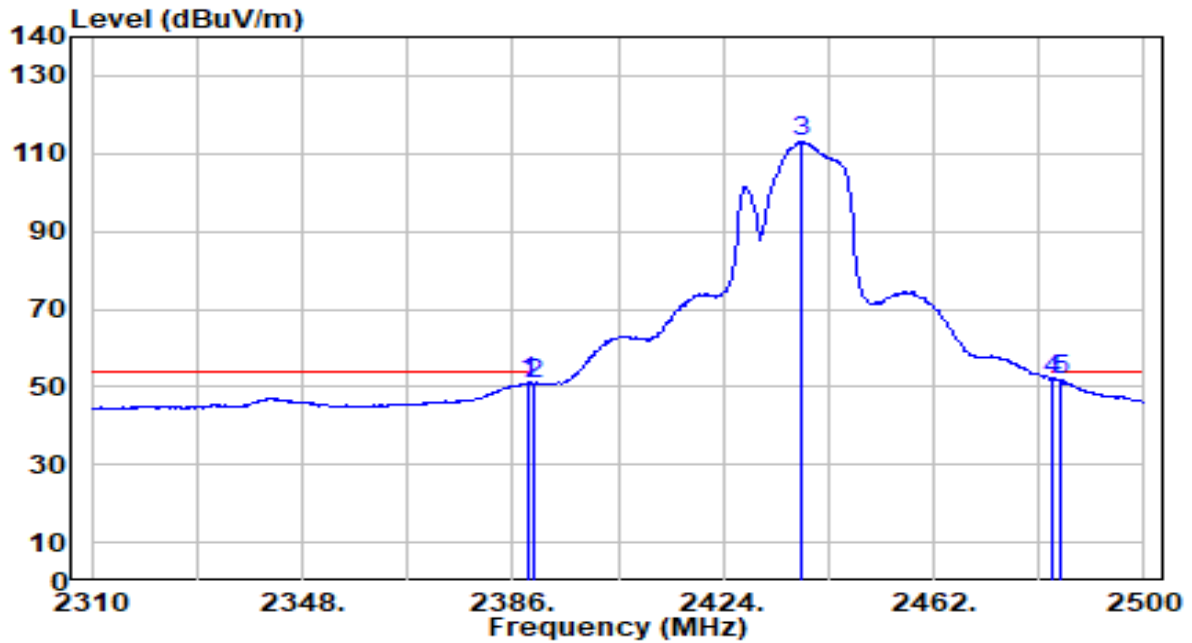

No	Frequency (MHz)	Reading (dBuV)	C.F (dB/m)	Measurement (dBuV/m)	Margin (dB)	Limit (dBuV/m)	Height (cm)	Angle (deg)	Remark (QP/PK/AV)
1	2389.040	20.64	30.44	51.08	-2.92	54.00	310	262	Average
2	2390.000	20.45	30.45	50.90	-3.10	54.00	310	262	Average
3	2438.060	82.46	30.53	112.99	N/A	N/A	310	262	Average
4	2483.500	21.33	30.59	51.92	-2.08	54.00	310	262	Average
5	* 2484.800	21.36	30.59	51.95	-2.05	54.00	310	262	Average

Note:

1. " \*", means this data is the worst emission level.
2. C.F (Correction Factor) = Antenna Factor (dB/m)+ Cable Loss (dB).
3. Measurement (dBuV/m) = Reading(dBuV) + C.F (Correction Factor).
4. The emission levels of other frequencies are very lower than the limit and not show in test report.

EUT	BE5000 Whole Home Mesh Wi-Fi 7 System	Date of Test	2024-03-23
Factor	DRH18-E	Temp. / Humidity	24°C /60%
Polarity	Vertical	Site / Test Engineer	AC2 / Marvin
Test Mode	802.11be-20MHz_TX_CH 6_ANT 0+1	Test Voltage	AC 120V/60Hz

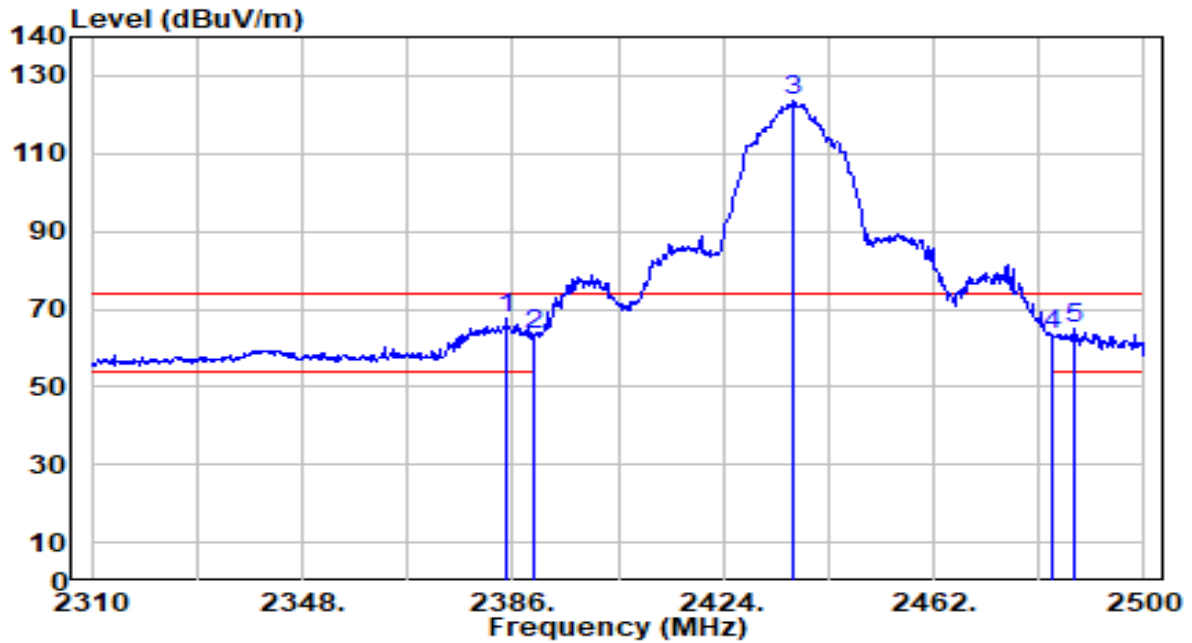

No	Frequency (MHz)	Reading (dBuV)	C.F (dB/m)	Measurement (dBuV/m)	Margin (dB)	Limit (dBuV/m)	Height (cm)	Angle (deg)	Remark (QP/PK/AV)	
1	*	2384.860	37.44	30.43	67.87	-6.13	74.00	200	169	Peak
2		2390.000	33.21	30.45	63.65	-10.35	74.00	200	169	Peak
3		2436.730	92.90	30.53	123.42	N/A	N/A	200	169	Peak
4		2483.500	32.75	30.59	63.34	-10.66	74.00	200	169	Peak
5		2487.270	34.20	30.59	64.79	-9.21	74.00	200	169	Peak

Note:

- "\*" means this data is the worst emission level.
- C.F (Correction Factor) = Antenna Factor (dB/m)+ Cable Loss (dB).
- Measurement (dBuV/m) = Reading(dBuV) + C.F (Correction Factor).
- The emission levels of other frequencies are very lower than the limit and not show in test report.

EUT	BE5000 Whole Home Mesh Wi-Fi 7 System	Date of Test	2024-03-23
Factor	DRH18-E	Temp. / Humidity	24°C /60%
Polarity	Vertical	Site / Test Engineer	AC2 / Marvin
Test Mode	802.11be-20MHz_TX_CH 6_ANT 0+1	Test Voltage	AC 120V/60Hz

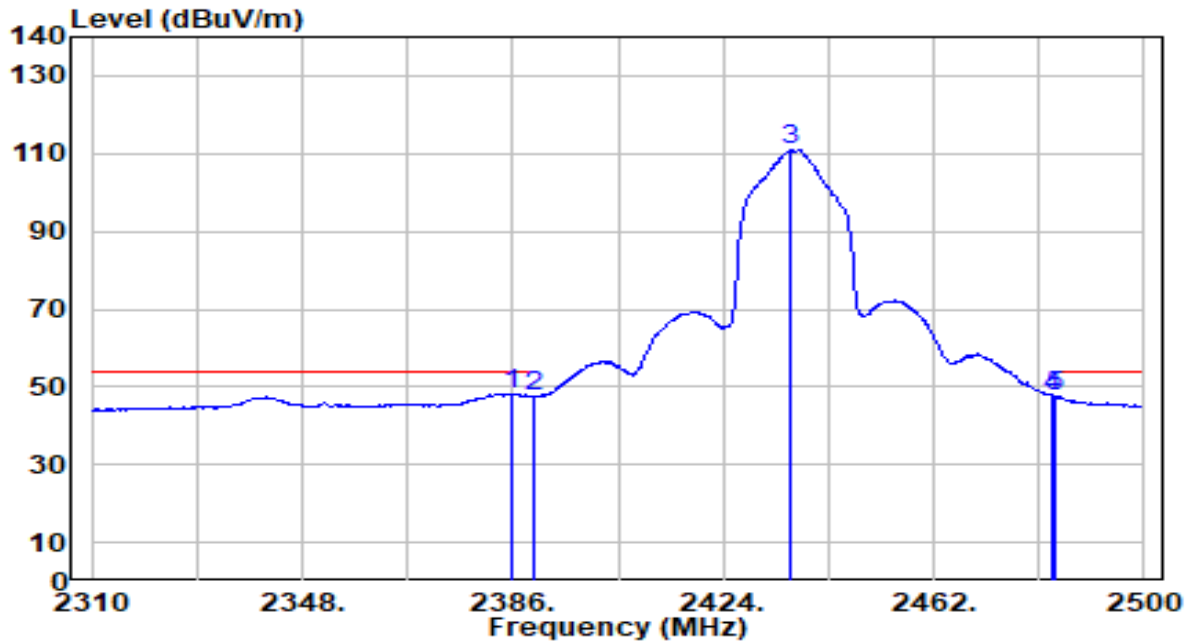

No	Frequency (MHz)	Reading (dBuV)	C.F (dB/m)	Measurement (dBuV/m)	Margin (dB)	Limit (dBuV/m)	Height (cm)	Angle (deg)	Remark (QP/PK/AV)	
1	*	2386.000	17.66	30.44	48.10	-5.90	54.00	200	169	Average
2		2390.000	16.95	30.45	47.40	-6.60	54.00	200	169	Average
3		2436.160	80.37	30.52	110.90	N/A	N/A	200	169	Average
4		2483.500	17.20	30.59	47.79	-6.21	54.00	200	169	Average
5		2484.040	16.93	30.59	47.51	-6.49	54.00	200	169	Average

Note:

1. " \*", means this data is the worst emission level.
2. C.F (Correction Factor) = Antenna Factor (dB/m)+ Cable Loss (dB).
3. Measurement (dBuV/m) = Reading(dBuV) + C.F (Correction Factor).
4. The emission levels of other frequencies are very lower than the limit and not show in test report.



EUT	BE5000 Whole Home Mesh Wi-Fi 7 System	Date of Test	2024-03-23
Factor	DRH18-E	Temp. / Humidity	24°C /60%
Polarity	Horizontal	Site / Test Engineer	AC2 / Marvin
Test Mode	802.11be-20MHz_TX_CH 11_ANT 0+1	Test Voltage	AC 120V/60Hz

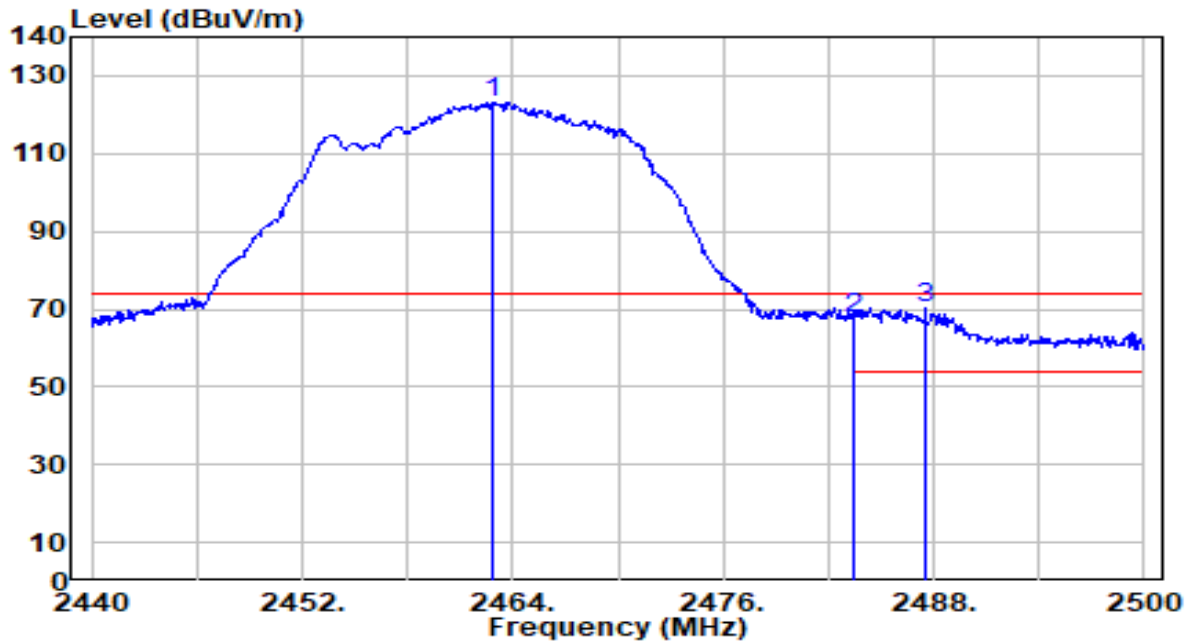

No	Frequency (MHz)	Reading (dBuV)	C.F (dB/m)	Measurement (dBuV/m)	Margin (dB)	Limit (dBuV/m)	Height (cm)	Angle (deg)	Remark (QP/PK/AV)
1	2462.920	92.68	30.56	123.24	N/A	N/A	317	254	Peak
2	2483.500	37.21	30.59	67.80	-6.20	74.00	317	254	Peak
3	* 2487.520	39.89	30.59	70.48	-3.52	74.00	317	254	Peak

Note:

1. " \*", means this data is the worst emission level.
2. C.F (Correction Factor) = Antenna Factor (dB/m)+ Cable Loss (dB).
3. Measurement (dBuV/m) = Reading(dBuV) + C.F (Correction Factor).
4. The emission levels of other frequencies are very lower than the limit and not show in test report.

EUT	BE5000 Whole Home Mesh Wi-Fi 7 System	Date of Test	2024-03-23
Factor	DRH18-E	Temp. / Humidity	24°C /60%
Polarity	Horizontal	Site / Test Engineer	AC2 / Marvin
Test Mode	802.11be-20MHz_TX_CH 11_ANT 0+1	Test Voltage	AC 120V/60Hz

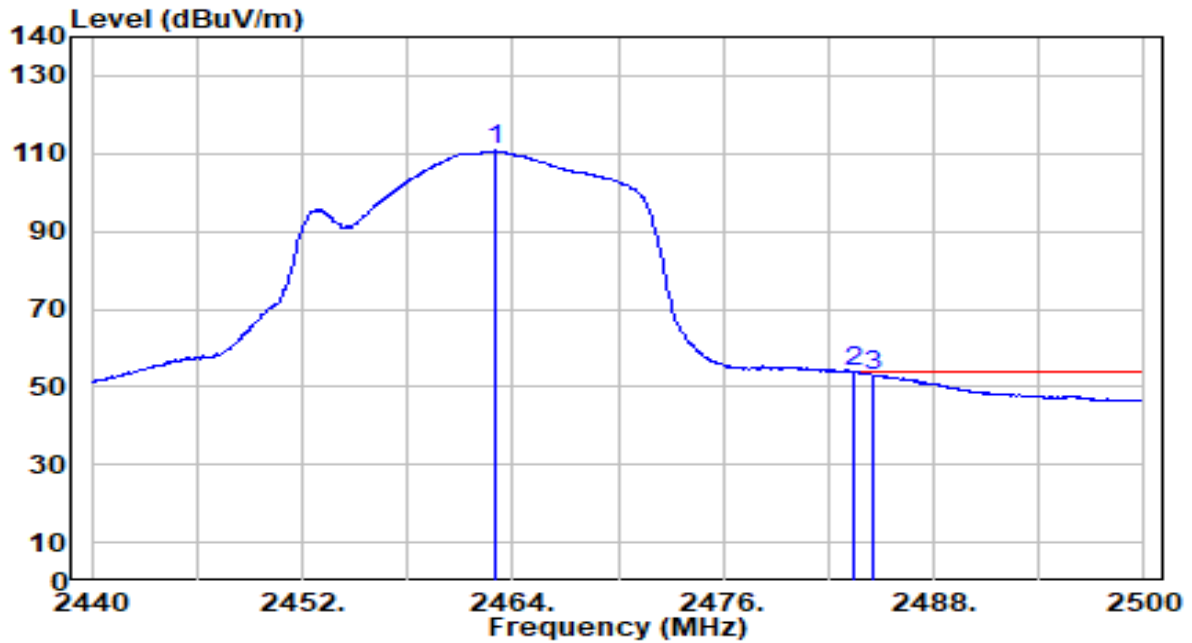

No	Frequency (MHz)	Reading (dBuV)	C.F (dB/m)	Measurement (dBuV/m)	Margin (dB)	Limit (dBuV/m)	Height (cm)	Angle (deg)	Remark (QP/PK/AV)
1	2462.980	80.18	30.56	110.74	N/A	N/A	317	254	Average
2	* 2483.500	23.29	30.59	53.88	-0.12	54.00	317	254	Average
3	2484.520	22.47	30.59	53.06	-0.94	54.00	317	254	Average

Note:

1. " \*", means this data is the worst emission level.
2. C.F (Correction Factor) = Antenna Factor (dB/m)+ Cable Loss (dB).
3. Measurement (dBuV/m) = Reading(dBuV) + C.F (Correction Factor).
4. The emission levels of other frequencies are very lower than the limit and not show in test report.

EUT	BE5000 Whole Home Mesh Wi-Fi 7 System	Date of Test	2024-03-23
Factor	DRH18-E	Temp. / Humidity	24°C /60%
Polarity	Vertical	Site / Test Engineer	AC2 / Marvin
Test Mode	802.11be-20MHz_TX_CH 11_ANT 0+1	Test Voltage	AC 120V/60Hz

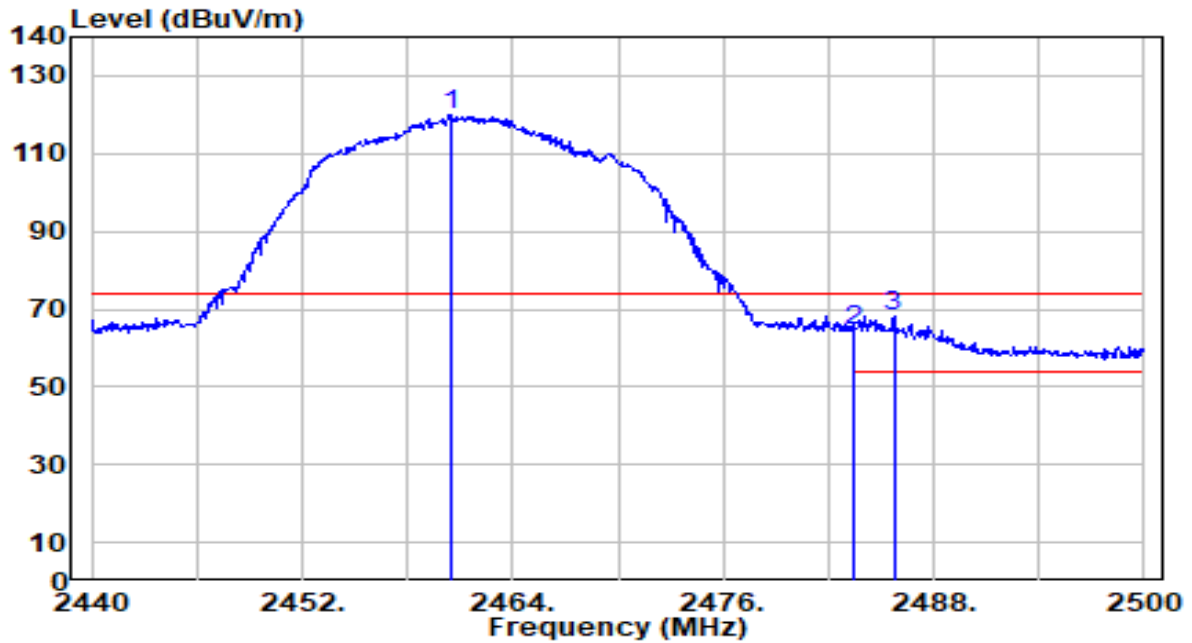

No	Frequency (MHz)	Reading (dBuV)	C.F (dB/m)	Measurement (dBuV/m)	Margin (dB)	Limit (dBuV/m)	Height (cm)	Angle (deg)	Remark (QP/PK/AV)
1	2460.460	89.25	30.56	119.81	N/A	N/A	206	169	Peak
2	2483.500	33.81	30.59	64.39	-9.61	74.00	206	169	Peak
3	* 2485.720	37.48	30.59	68.08	-5.92	74.00	206	169	Peak

Note:

1. " \*", means this data is the worst emission level.
2. C.F (Correction Factor) = Antenna Factor (dB/m)+ Cable Loss (dB).
3. Measurement (dBuV/m) = Reading(dBuV) + C.F (Correction Factor).
4. The emission levels of other frequencies are very lower than the limit and not show in test report.

EUT	BE5000 Whole Home Mesh Wi-Fi 7 System	Date of Test	2024-03-23
Factor	DRH18-E	Temp. / Humidity	24°C /60%
Polarity	Vertical	Site / Test Engineer	AC2 / Marvin
Test Mode	802.11be-20MHz_TX_CH 11_ANT 0+1	Test Voltage	AC 120V/60Hz

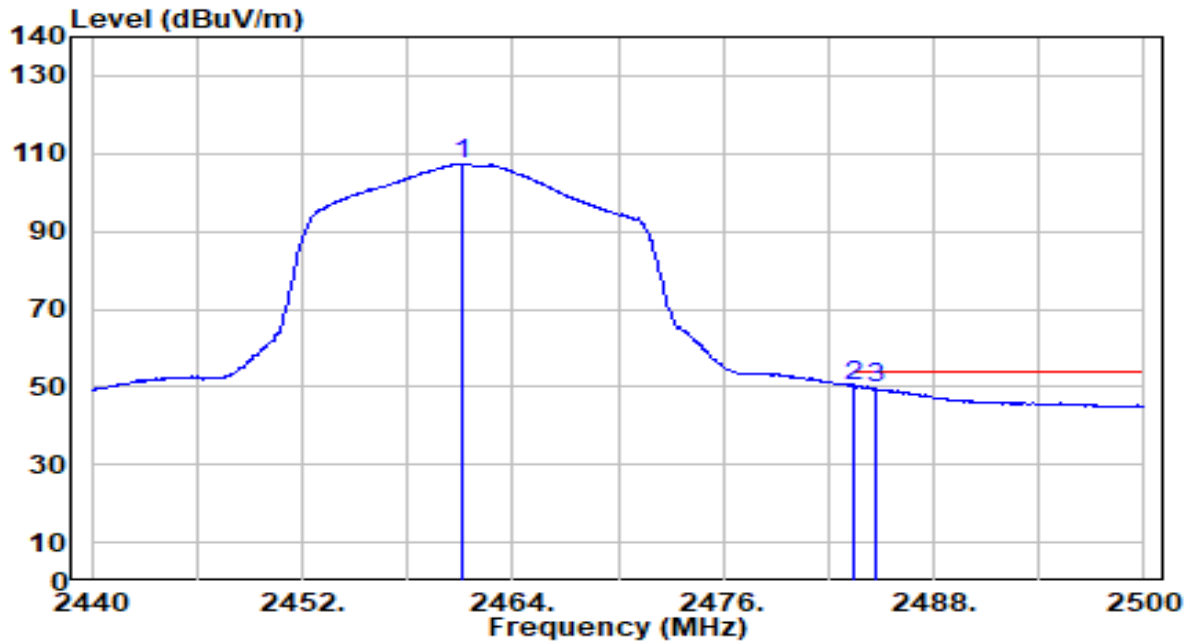

No	Frequency (MHz)	Reading (dBuV)	C.F (dB/m)	Measurement (dBuV/m)	Margin (dB)	Limit (dBuV/m)	Height (cm)	Angle (deg)	Remark (QP/PK/AV)
1	2461.060	76.86	30.56	107.41	N/A	N/A	206	169	Average
2	* 2483.500	19.52	30.59	50.11	-3.89	54.00	206	169	Average
3	2484.640	18.86	30.59	49.44	-4.56	54.00	206	169	Average

Note:

1. " \*", means this data is the worst emission level.
2. C.F (Correction Factor) = Antenna Factor (dB/m)+ Cable Loss (dB).
3. Measurement (dBuV/m) = Reading(dBuV) + C.F (Correction Factor).
4. The emission levels of other frequencies are very lower than the limit and not show in test report.

EUT	BE5000 Whole Home Mesh Wi-Fi 7 System	Date of Test	2024-03-23
Factor	DRH18-E	Temp. / Humidity	24°C /60%
Polarity	Horizontal	Site / Test Engineer	AC2 / Marvin
Test Mode	802.11be-40MHz_TX_CH 3_ANT 0+1	Test Voltage	AC 120V/60Hz

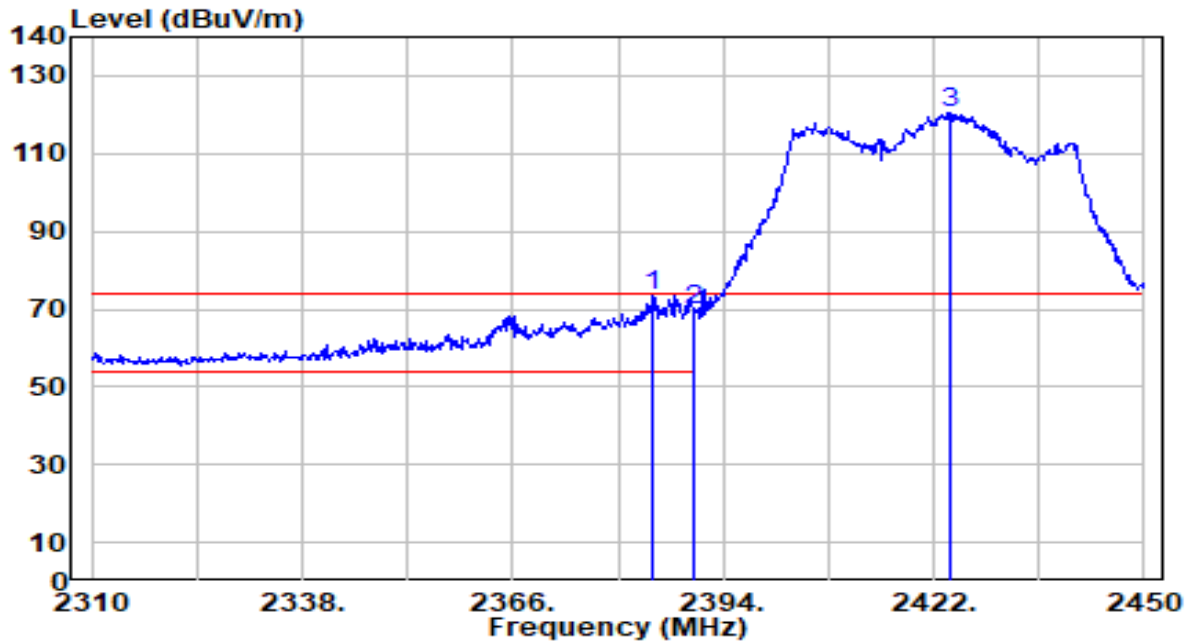

No	Frequency (MHz)	Reading (dBuV)	C.F (dB/m)	Measurement (dBuV/m)	Margin (dB)	Limit (dBuV/m)	Height (cm)	Angle (deg)	Remark (QP/PK/AV)	
1	*	2384.760	42.92	30.43	73.35	-0.65	74.00	313	261	Peak
2		2390.000	39.06	30.45	69.51	-4.49	74.00	313	261	Peak
3		2424.100	89.88	30.51	120.39	N/A	N/A	313	261	Peak

Note:

1. " \*", means this data is the worst emission level.
2. C.F (Correction Factor) = Antenna Factor (dB/m)+ Cable Loss (dB).
3. Measurement (dBuV/m) = Reading(dBuV) + C.F (Correction Factor).
4. The emission levels of other frequencies are very lower than the limit and not show in test report.

EUT	BE5000 Whole Home Mesh Wi-Fi 7 System	Date of Test	2024-03-23
Factor	DRH18-E	Temp. / Humidity	24°C /60%
Polarity	Horizontal	Site / Test Engineer	AC2 / Marvin
Test Mode	802.11be-40MHz_TX_CH 3_ANT 0+1	Test Voltage	AC 120V/60Hz

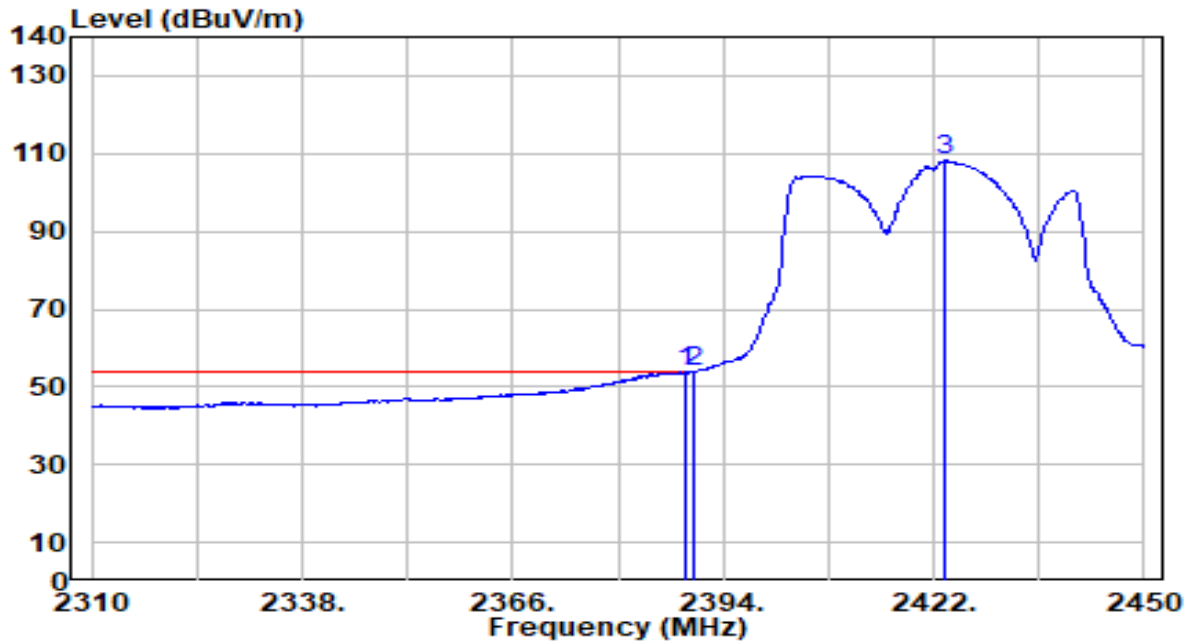

No	Frequency (MHz)	Reading (dBuV)	C.F (dB/m)	Measurement (dBuV/m)	Margin (dB)	Limit (dBuV/m)	Height (cm)	Angle (deg)	Remark (QP/PK/AV)
1	2388.960	23.33	30.44	53.78	-0.22	54.00	313	261	Average
2	* 2390.000	23.37	30.45	53.82	-0.18	54.00	313	261	Average
3	2423.540	77.58	30.51	108.09	N/A	N/A	313	261	Average

Note:

1. " \*", means this data is the worst emission level.
2. C.F (Correction Factor) = Antenna Factor (dB/m)+ Cable Loss (dB).
3. Measurement (dBuV/m) = Reading(dBuV) + C.F (Correction Factor).
4. The emission levels of other frequencies are very lower than the limit and not show in test report.

EUT	BE5000 Whole Home Mesh Wi-Fi 7 System	Date of Test	2024-03-23
Factor	DRH18-E	Temp. / Humidity	24°C /60%
Polarity	Vertical	Site / Test Engineer	AC2 / Marvin
Test Mode	802.11be-40MHz_TX_CH 3_ANT 0+1	Test Voltage	AC 120V/60Hz

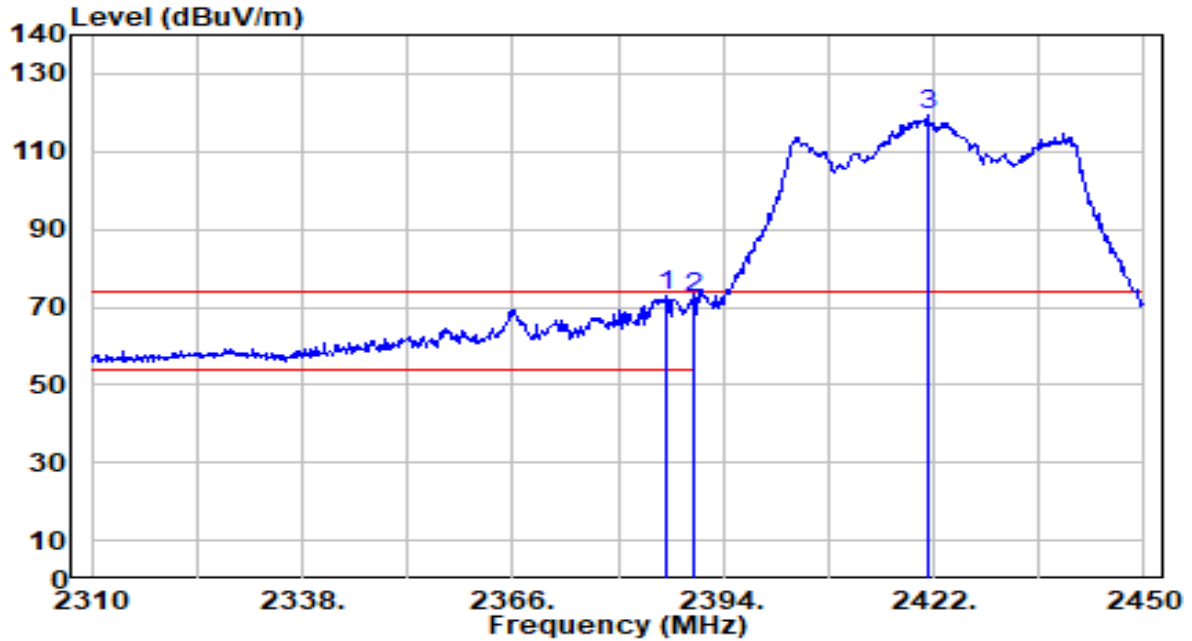

No	Frequency (MHz)	Reading (dBUV)	C.F (dB/m)	Measurement (dBUV/m)	Margin (dB)	Limit (dBUV/m)	Height (cm)	Angle (deg)	Remark (QP/PK/AV)	
1	*	2386.300	42.23	30.44	72.67	-1.33	74.00	200	175	Peak
2		2390.000	41.78	30.45	72.22	-1.78	74.00	200	175	Peak
3		2421.300	88.96	30.50	119.47	N/A	N/A	200	175	Peak

Note:

1. " \*", means this data is the worst emission level.
2. C.F (Correction Factor) = Antenna Factor (dB/m)+ Cable Loss (dB).
3. Measurement (dBUV/m) = Reading(dBUV) + C.F (Correction Factor).
4. The emission levels of other frequencies are very lower than the limit and not show in test report.

EUT	BE5000 Whole Home Mesh Wi-Fi 7 System	Date of Test	2024-03-23
Factor	DRH18-E	Temp. / Humidity	24°C /60%
Polarity	Vertical	Site / Test Engineer	AC2 / Marvin
Test Mode	802.11be-40MHz_TX_CH 3_ANT 0+1	Test Voltage	AC 120V/60Hz

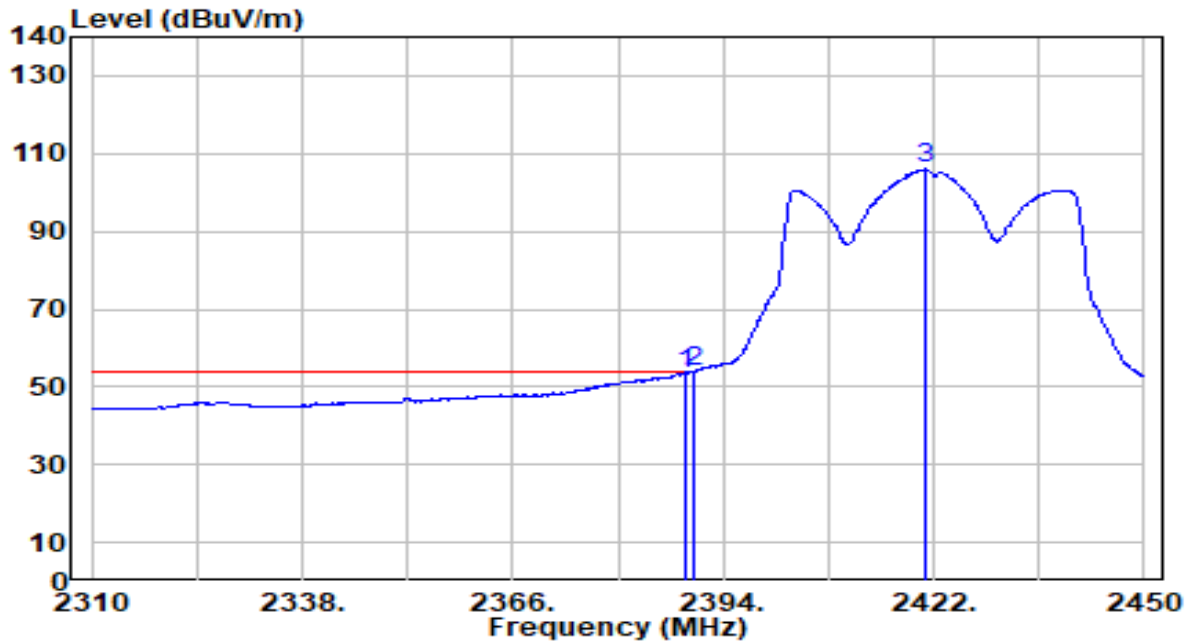

No	Frequency (MHz)	Reading (dBUV)	C.F (dB/m)	Measurement (dBUV/m)	Margin (dB)	Limit (dBUV/m)	Height (cm)	Angle (deg)	Remark (QP/PK/AV)
1	2388.960	23.11	30.44	53.55	-0.45	54.00	200	175	Average
2	* 2390.000	23.28	30.45	53.73	-0.27	54.00	200	175	Average
3	2420.880	75.49	30.50	105.99	N/A	N/A	200	175	Average

Note:

1. " \*", means this data is the worst emission level.
2. C.F (Correction Factor) = Antenna Factor (dB/m)+ Cable Loss (dB).
3. Measurement (dBUV/m) = Reading(dBUV) + C.F (Correction Factor).
4. The emission levels of other frequencies are very lower than the limit and not show in test report.



EUT	BE5000 Whole Home Mesh Wi-Fi 7 System	Date of Test	2024-03-23
Factor	DRH18-E	Temp. / Humidity	24°C /60%
Polarity	Horizontal	Site / Test Engineer	AC2 / Marvin
Test Mode	802.11be-40MHz_TX_CH 6_ANT 0+1	Test Voltage	AC 120V/60Hz

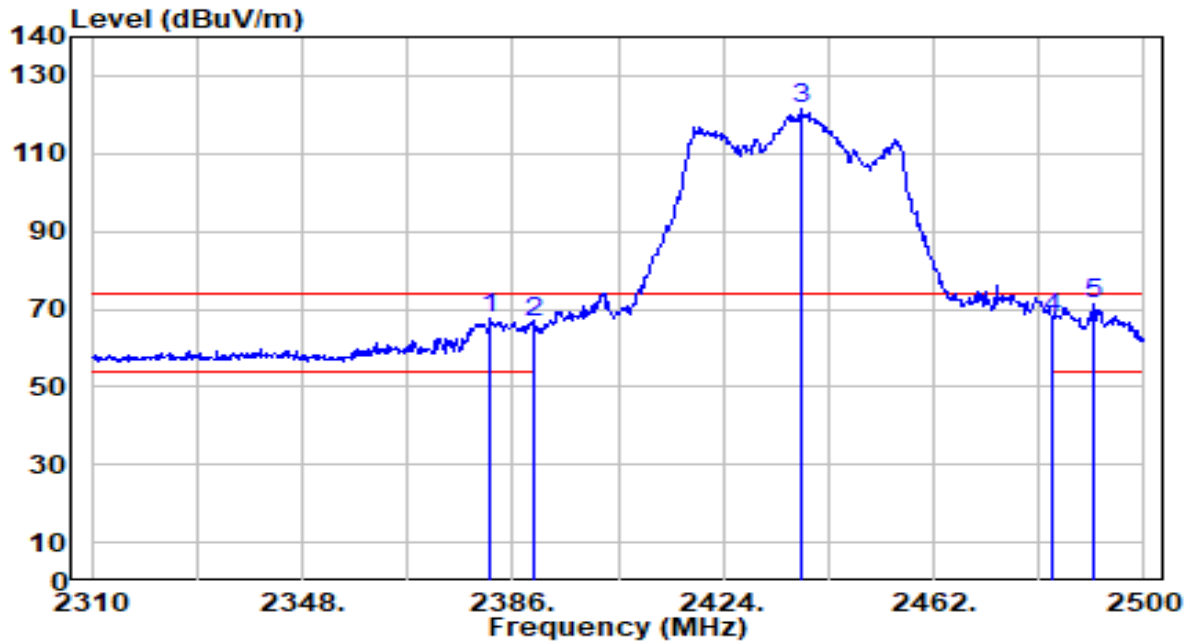

No	Frequency (MHz)	Reading (dBuV)	C.F (dB/m)	Measurement (dBuV/m)	Margin (dB)	Limit (dBuV/m)	Height (cm)	Angle (deg)	Remark (QP/PK/AV)
1	2381.820	37.00	30.42	67.43	-6.57	74.00	121	87	Peak
2	2390.000	35.87	30.45	66.32	-7.68	74.00	121	87	Peak
3	2438.060	90.81	30.53	121.34	N/A	N/A	121	87	Peak
4	2483.500	37.01	30.59	67.59	-6.41	74.00	121	87	Peak
5	* 2491.070	40.88	30.60	71.48	-2.52	74.00	121	87	Peak

Note:

1. " \*", means this data is the worst emission level.
2. C.F (Correction Factor) = Antenna Factor (dB/m)+ Cable Loss (dB).
3. Measurement (dBuV/m) = Reading(dBuV) + C.F (Correction Factor).
4. The emission levels of other frequencies are very lower than the limit and not show in test report.

EUT	BE5000 Whole Home Mesh Wi-Fi 7 System	Date of Test	2024-03-23
Factor	DRH18-E	Temp. / Humidity	24°C /60%
Polarity	Horizontal	Site / Test Engineer	AC2 / Marvin
Test Mode	802.11be-40MHz_TX_CH 6_ANT 0+1	Test Voltage	AC 120V/60Hz

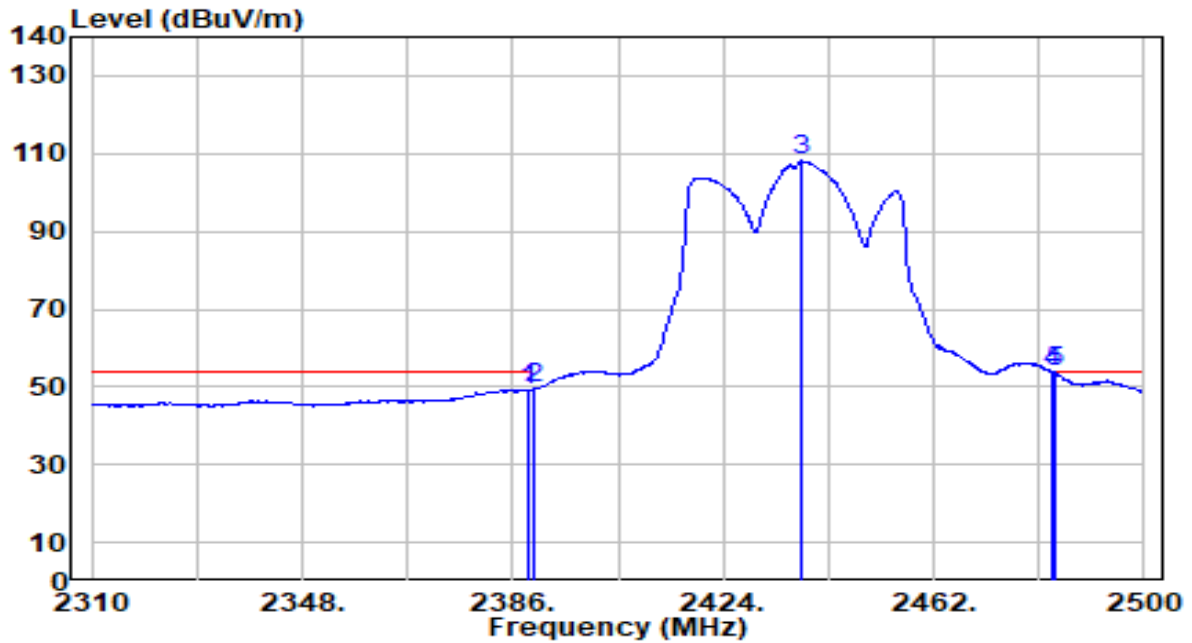

No	Frequency (MHz)	Reading (dBuV)	C.F (dB/m)	Measurement (dBuV/m)	Margin (dB)	Limit (dBuV/m)	Height (cm)	Angle (deg)	Remark (QP/PK/AV)
1	2388.660	18.89	30.44	49.34	-4.66	54.00	121	87	Average
2	2390.000	19.10	30.45	49.55	-4.45	54.00	121	87	Average
3	2438.250	77.56	30.53	108.09	N/A	N/A	121	87	Average
4	* 2483.500	23.31	30.59	53.90	-0.10	54.00	121	87	Average
5	2484.040	23.06	30.59	53.64	-0.36	54.00	121	87	Average

Note:

- "\*" means this data is the worst emission level.
- C.F (Correction Factor) = Antenna Factor (dB/m)+ Cable Loss (dB).
- Measurement (dBuV/m) = Reading(dBuV) + C.F (Correction Factor).
- The emission levels of other frequencies are very lower than the limit and not show in test report.

EUT	BE5000 Whole Home Mesh Wi-Fi 7 System	Date of Test	2024-03-23
Factor	DRH18-E	Temp. / Humidity	24°C /60%
Polarity	Vertical	Site / Test Engineer	AC2 / Marvin
Test Mode	802.11be-40MHz_TX_CH 6_ANT 0+1	Test Voltage	AC 120V/60Hz

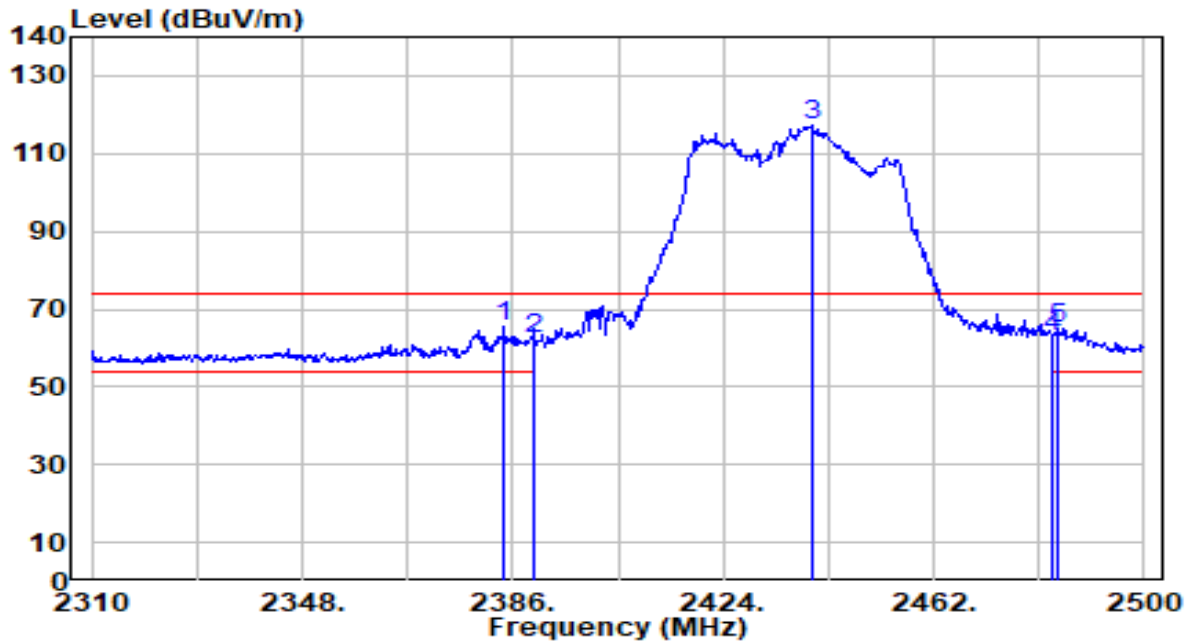

No	Frequency (MHz)	Reading (dBUV)	C.F (dB/m)	Measurement (dBUV/m)	Margin (dB)	Limit (dBUV/m)	Height (cm)	Angle (deg)	Remark (QP/PK/AV)
1	* 2384.480	35.32	30.43	65.75	-8.25	74.00	310	192	Peak
2	2390.000	31.67	30.45	62.12	-11.88	74.00	310	192	Peak
3	2439.960	86.61	30.53	117.13	N/A	N/A	310	192	Peak
4	2483.500	32.39	30.59	62.97	-11.03	74.00	310	192	Peak
5	2484.610	34.60	30.59	65.19	-8.81	74.00	310	192	Peak

Note:

1. " \*", means this data is the worst emission level.
2. C.F (Correction Factor) = Antenna Factor (dB/m)+ Cable Loss (dB).
3. Measurement (dBUV/m) = Reading(dBUV) + C.F (Correction Factor).
4. The emission levels of other frequencies are very lower than the limit and not show in test report.

EUT	BE5000 Whole Home Mesh Wi-Fi 7 System	Date of Test	2024-03-23
Factor	DRH18-E	Temp. / Humidity	24°C /60%
Polarity	Vertical	Site / Test Engineer	AC2 / Marvin
Test Mode	802.11be-40MHz_TX_CH 6_ANT 0+1	Test Voltage	AC 120V/60Hz

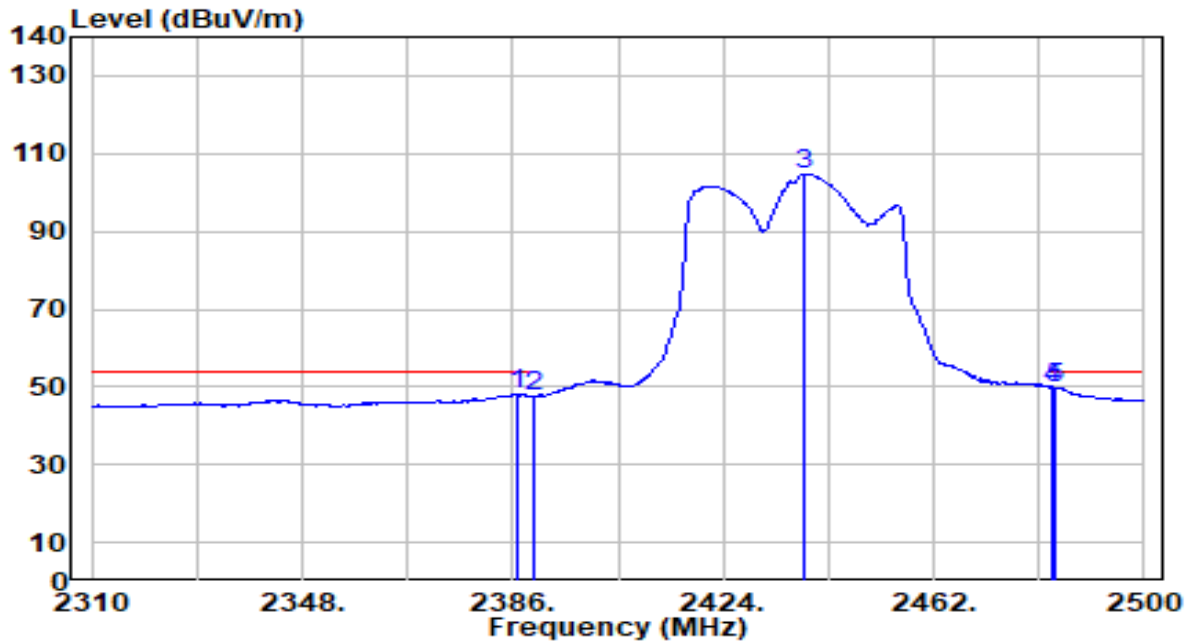

No	Frequency (MHz)	Reading (dBuV)	C.F (dB/m)	Measurement (dBuV/m)	Margin (dB)	Limit (dBuV/m)	Height (cm)	Angle (deg)	Remark (QP/PK/AV)
1	2386.760	17.64	30.44	48.07	-5.93	54.00	310	192	Average
2	2390.000	17.19	30.45	47.64	-6.36	54.00	310	192	Average
3	2438.630	74.32	30.53	104.85	N/A	N/A	310	192	Average
4	* 2483.500	19.29	30.59	49.87	-4.13	54.00	310	192	Average
5	2484.040	19.13	30.59	49.72	-4.28	54.00	310	192	Average

Note:

- "\*" means this data is the worst emission level.
- C.F (Correction Factor) = Antenna Factor (dB/m)+ Cable Loss (dB).
- Measurement (dBuV/m) = Reading(dBuV) + C.F (Correction Factor).
- The emission levels of other frequencies are very lower than the limit and not show in test report.

EUT	BE5000 Whole Home Mesh Wi-Fi 7 System	Date of Test	2024-03-23
Factor	DRH18-E	Temp. / Humidity	24°C /60%
Polarity	Horizontal	Site / Test Engineer	AC2 / Marvin
Test Mode	802.11be-40MHz_TX_CH 9_ANT 0+1	Test Voltage	AC 120V/60Hz

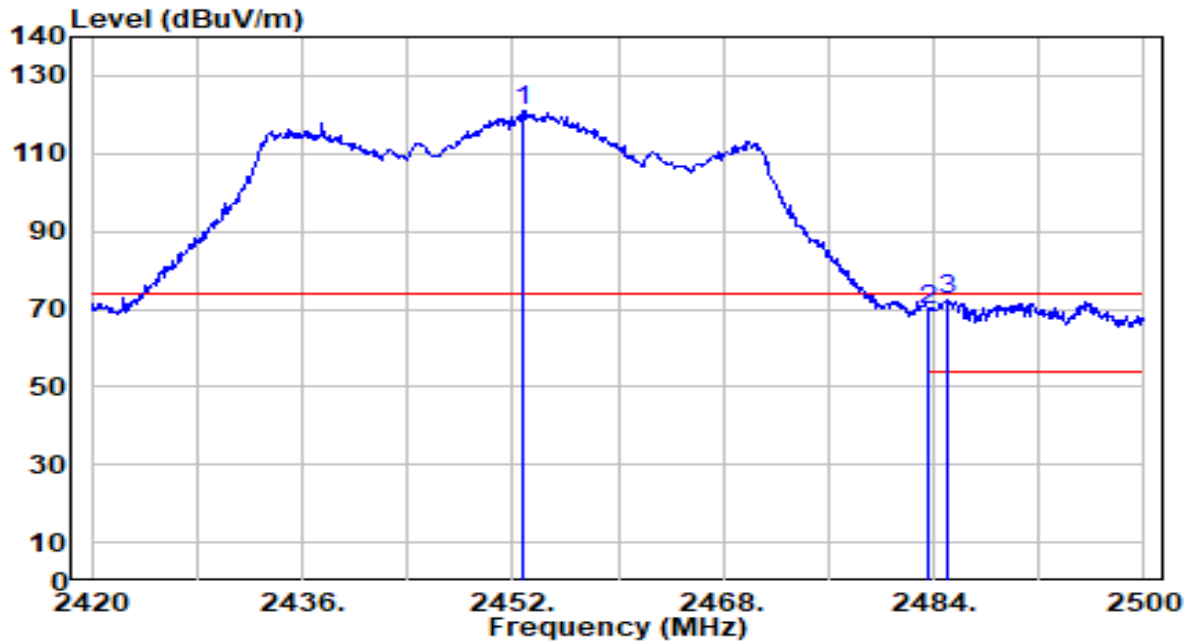

No	Frequency (MHz)	Reading (dBUV)	C.F (dB/m)	Measurement (dBUV/m)	Margin (dB)	Limit (dBUV/m)	Height (cm)	Angle (deg)	Remark (QP/PK/AV)
1	2452.720	90.47	30.55	121.01	N/A	N/A	132	84	Peak
2	2483.500	38.97	30.59	69.56	-4.44	74.00	132	84	Peak
3	* 2484.960	41.89	30.59	72.48	-1.52	74.00	132	84	Peak

Note:

1. " \*", means this data is the worst emission level.
2. C.F (Correction Factor) = Antenna Factor (dB/m)+ Cable Loss (dB).
3. Measurement (dBUV/m) = Reading(dBUV) + C.F (Correction Factor).
4. The emission levels of other frequencies are very lower than the limit and not show in test report.

EUT	BE5000 Whole Home Mesh Wi-Fi 7 System	Date of Test	2024-03-23
Factor	DRH18-E	Temp. / Humidity	24°C /60%
Polarity	Horizontal	Site / Test Engineer	AC2 / Marvin
Test Mode	802.11be-40MHz_TX_CH 9_ANT 0+1	Test Voltage	AC 120V/60Hz

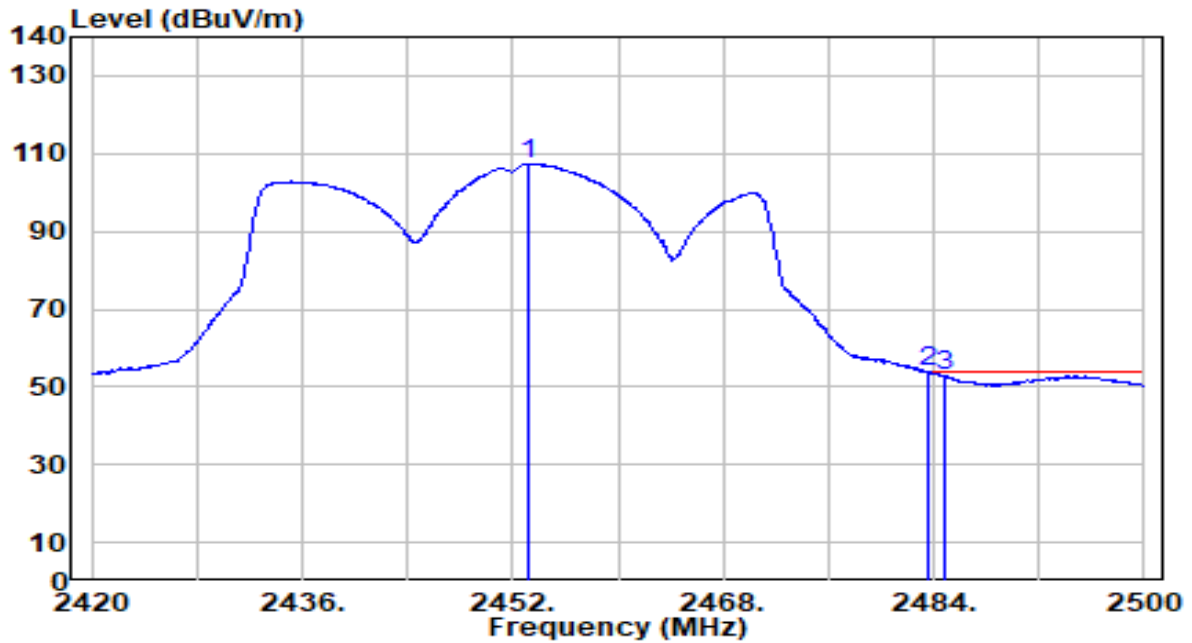

No	Frequency (MHz)	Reading (dBUV)	C.F (dB/m)	Measurement (dBUV/m)	Margin (dB)	Limit (dBUV/m)	Height (cm)	Angle (deg)	Remark (QP/PK/AV)
1	2453.200	76.95	30.55	107.50	N/A	N/A	132	84	Average
2	* 2483.500	23.23	30.59	53.81	-0.19	54.00	132	84	Average
3	2484.800	22.41	30.59	53.00	-1.00	54.00	132	84	Average

Note:

1. " \*", means this data is the worst emission level.
2. C.F (Correction Factor) = Antenna Factor (dB/m)+ Cable Loss (dB).
3. Measurement (dBUV/m) = Reading(dBUV) + C.F (Correction Factor).
4. The emission levels of other frequencies are very lower than the limit and not show in test report.

EUT	BE5000 Whole Home Mesh Wi-Fi 7 System	Date of Test	2024-03-23
Factor	DRH18-E	Temp. / Humidity	24°C /60%
Polarity	Vertical	Site / Test Engineer	AC2 / Marvin
Test Mode	802.11be-40MHz_TX_CH 9_ANT 0+1	Test Voltage	AC 120V/60Hz

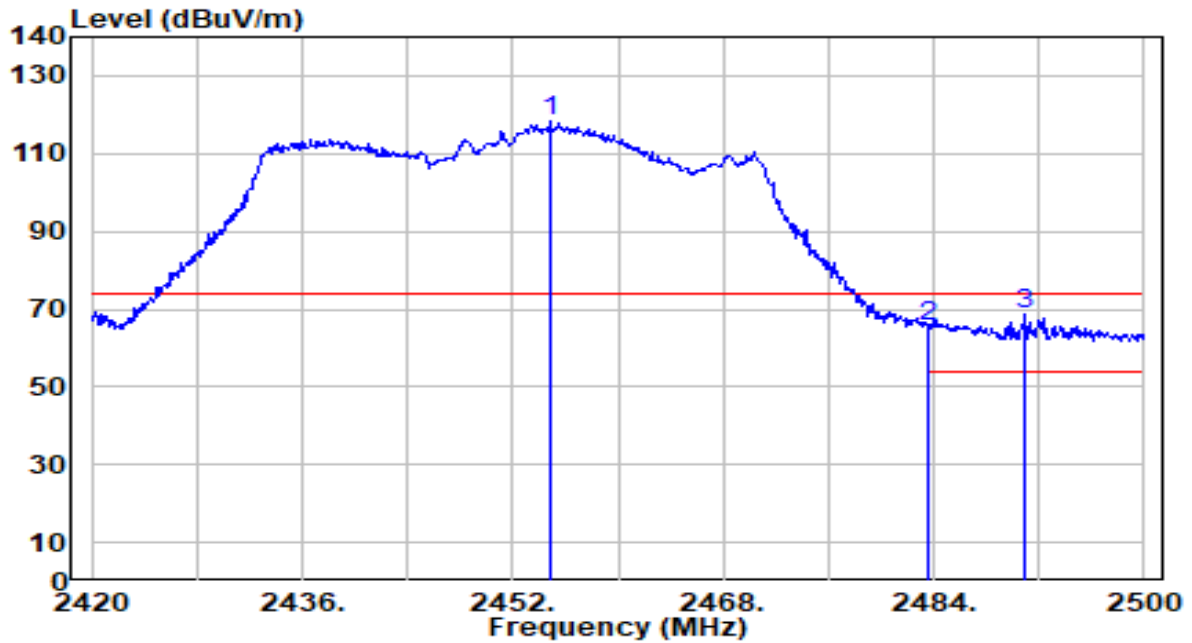

No	Frequency (MHz)	Reading (dBuV)	C.F (dB/m)	Measurement (dBuV/m)	Margin (dB)	Limit (dBuV/m)	Height (cm)	Angle (deg)	Remark (QP/PK/AV)
1	2454.880	87.58	30.55	118.12	N/A	N/A	300	191	Peak
2	2483.500	34.84	30.59	65.42	-8.58	74.00	300	191	Peak
3	* 2490.960	38.08	30.60	68.68	-5.32	74.00	300	191	Peak

Note:

1. " \*", means this data is the worst emission level.
2. C.F (Correction Factor) = Antenna Factor (dB/m)+ Cable Loss (dB).
3. Measurement (dBuV/m) = Reading(dBuV) + C.F (Correction Factor).
4. The emission levels of other frequencies are very lower than the limit and not show in test report.

EUT	BE5000 Whole Home Mesh Wi-Fi 7 System	Date of Test	2024-03-23
Factor	DRH18-E	Temp. / Humidity	24°C /60%
Polarity	Vertical	Site / Test Engineer	AC2 / Marvin
Test Mode	802.11be-40MHz_TX_CH 9_ANT 0+1	Test Voltage	AC 120V/60Hz

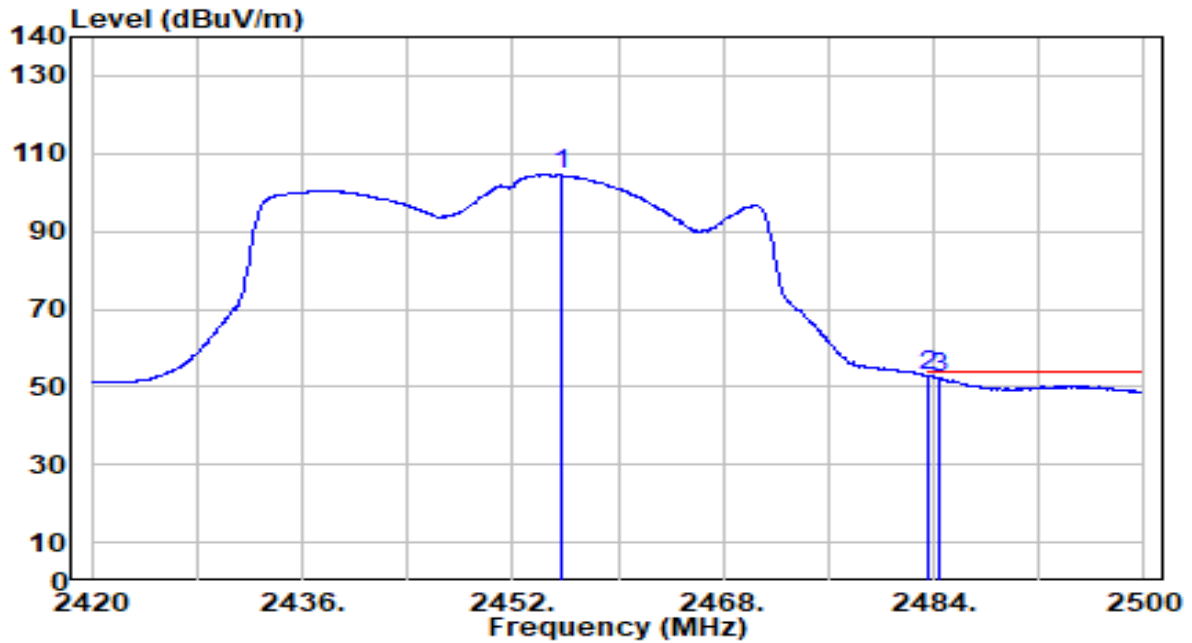

No	Frequency (MHz)	Reading (dBuV)	C.F (dB/m)	Measurement (dBuV/m)	Margin (dB)	Limit (dBuV/m)	Height (cm)	Angle (deg)	Remark (QP/PK/AV)
1	2455.680	73.93	30.55	104.48	N/A	N/A	300	191	Average
2	* 2483.500	22.37	30.59	52.96	-1.04	54.00	300	191	Average
3	2484.480	21.60	30.59	52.19	-1.81	54.00	300	191	Average

Note:

1. " \*", means this data is the worst emission level.
2. C.F (Correction Factor) = Antenna Factor (dB/m)+ Cable Loss (dB).
3. Measurement (dBuV/m) = Reading(dBuV) + C.F (Correction Factor).
4. The emission levels of other frequencies are very lower than the limit and not show in test report.



## 7.8. AC Conducted Emissions Measurement

### 7.8.1. Test Limit

FCC Part 15 Subpart C Paragraph 15.207 Limits		
Frequency (MHz)	QP (dBuV)	AV (dBuV)
0.15 - 0.50	66 - 56	56 - 46
0.50 - 5.0	56	46
5.0 - 30	60	50

Note 1: The lower limit shall apply at the transition frequencies.

Note 2: The limit decreases linearly with the logarithm of the frequency in the range 0.15MHz to 0.5MHz.

### 7.8.2. Test Setup

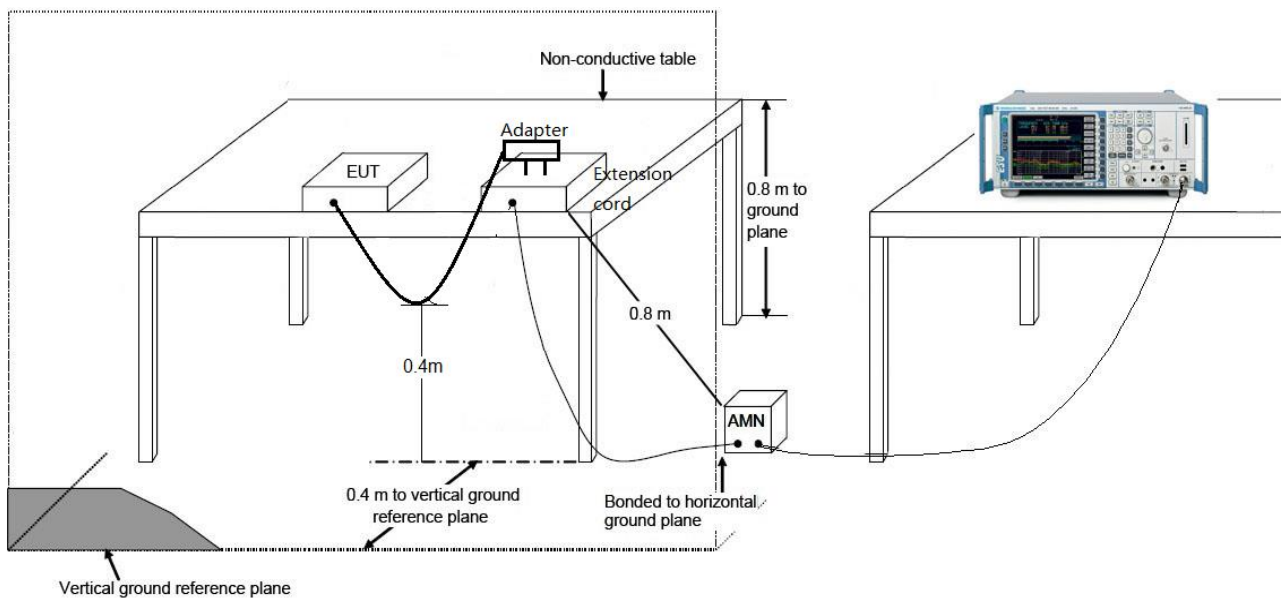

### 7.8.3. Test Result

EUT	BE5000 Whole Home Mesh Wi-Fi 7 System	Date of Test	2024-04-17
Factor	CE_ENV216-L1 (Filter ON)	Temp. / Humidity	23.8°C /52%
Polarity	Line1	Site / Test Engineer	SR2 / Bob
Test Mode	802.11n-20MHz_TX_CH 6_ANT 0+1	Test Voltage	AC 120V/60Hz

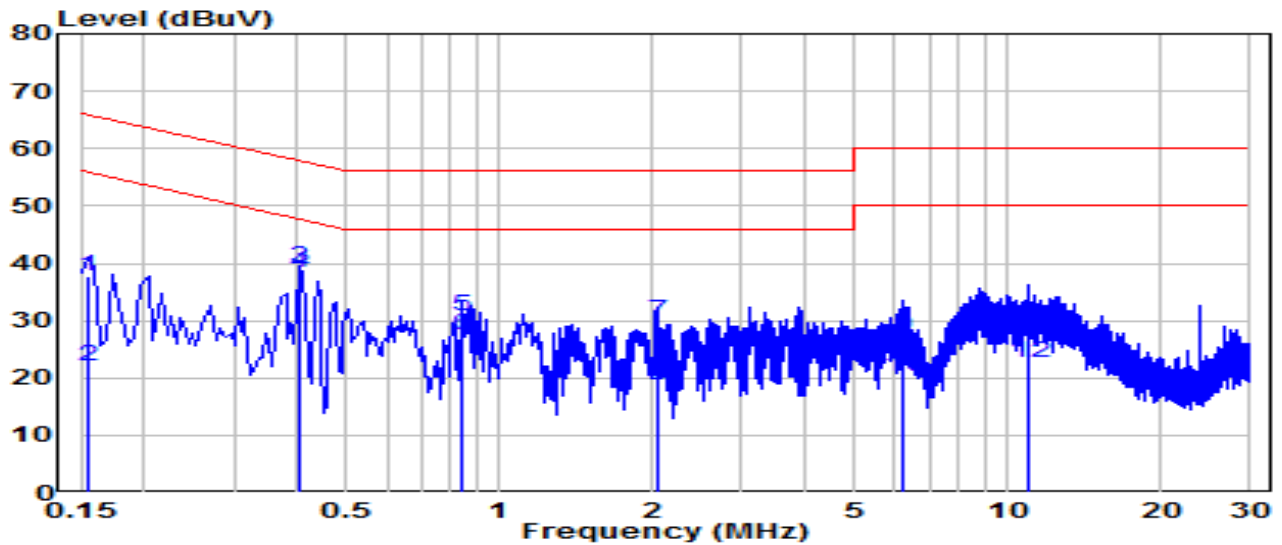

No	Frequency (MHz)	Reading (dBUV)	C.F (dB)	Measurement (dBUV)	Margin (dB)	Limit (dBUV)	Remark (QP/PK/AV)
1	0.154	27.99	9.63	37.62	-28.13	65.75	QP
2	0.154	12.41	9.63	22.04	-33.72	55.75	Average
3	* 0.406	29.52	9.64	39.16	-18.56	57.72	QP
4	* 0.406	28.81	9.64	38.46	-9.26	47.72	Average
5	0.847	21.19	9.67	30.86	-25.14	56.00	QP
6	0.847	17.84	9.67	27.51	-18.49	46.00	Average
7	2.044	20.08	9.70	29.78	-26.22	56.00	QP
8	2.044	8.96	9.70	18.66	-27.34	46.00	Average
9	6.220	17.42	9.78	27.19	-32.81	60.00	QP
10	6.220	10.44	9.78	20.21	-29.79	50.00	Average
11	11.043	19.17	9.88	29.05	-30.95	60.00	QP
12	11.043	12.67	9.88	22.54	-27.46	50.00	Average

Note:

- "\*", means this data is the worst emission level.
- C.F (Correction Factor) = LISN Factor (dB)+ Cable Loss (dB).
- Measurement (dBUV) = Reading(dBUV) + C.F (Correction Factor).

EUT	BE5000 Whole Home Mesh Wi-Fi 7 System	Date of Test	2024-04-17
Factor	CE_ENV216-N (Filter ON)	Temp. / Humidity	23.8°C /52%
Polarity	Neutral	Site / Test Engineer	SR2 / Bob
Test Mode	802.11n-20MHz_TX_CH 6_ANT 0+1	Test Voltage	AC 120V/60Hz

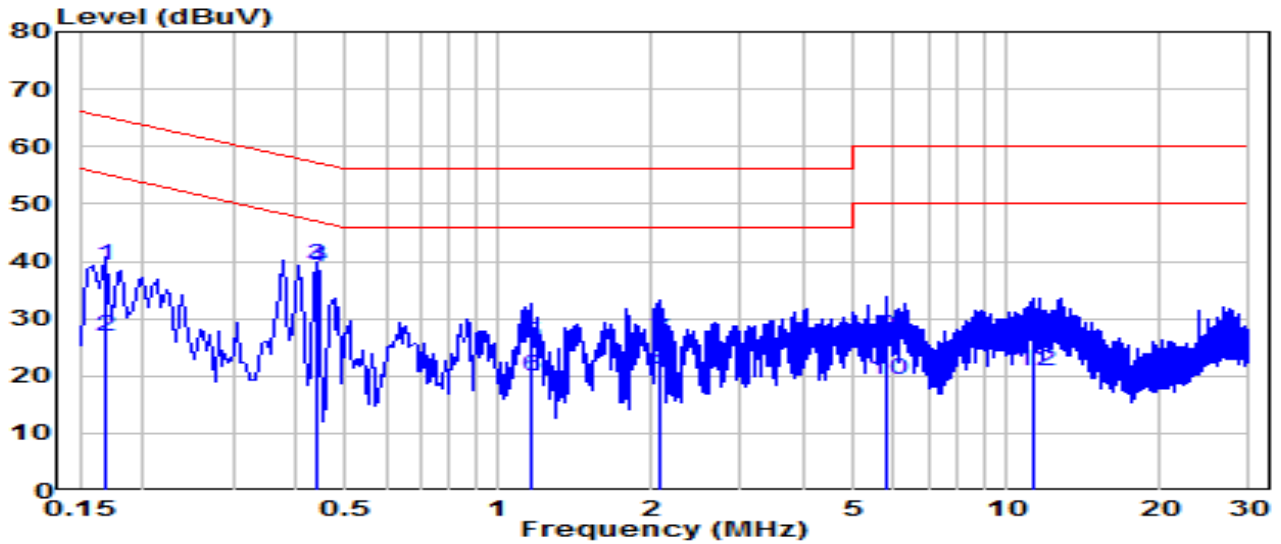

No	Frequency (MHz)	Reading (dBuV)	C.F (dB)	Measurement (dBuV)	Margin (dB)	Limit (dBuV)	Remark (QP/PK/AV)
1	0.168	29.55	9.63	39.19	-25.87	65.06	QP
2	0.168	17.30	9.63	26.93	-28.13	55.06	Average
3	* 0.438	29.59	9.65	39.24	-17.86	57.10	QP
4	* 0.438	29.27	9.65	38.92	-8.18	47.10	Average
5	1.158	16.08	9.68	25.77	-30.23	56.00	QP
6	1.158	10.15	9.68	19.83	-26.17	46.00	Average
7	2.089	16.54	9.71	26.25	-29.75	56.00	QP
8	2.089	11.45	9.71	21.16	-24.84	46.00	Average
9	5.788	17.00	9.78	26.78	-33.22	60.00	QP
10	5.788	9.63	9.78	19.41	-30.59	50.00	Average
11	11.237	17.32	9.90	27.22	-32.78	60.00	QP
12	11.237	10.81	9.90	20.71	-29.29	50.00	Average

Note:

1. " \*", means this data is the worst emission level.
2. C.F (Correction Factor) = LISN Factor (dB)+ Cable Loss (dB).
3. Measurement (dBuV) = Reading(dBuV) + C.F (Correction Factor).

EUT	BE5000 Whole Home Mesh Wi-Fi 7 System	Date of Test	2024-04-17
Factor	CE_ENV216-L1 (Filter ON)	Temp. / Humidity	23.8°C /52%
Polarity	Line1	Site / Test Engineer	SR2 / Bob
Test Mode	802.11n-20MHz_TX_CH 6_ANT 0+1	Test Voltage	AC 240V/60Hz

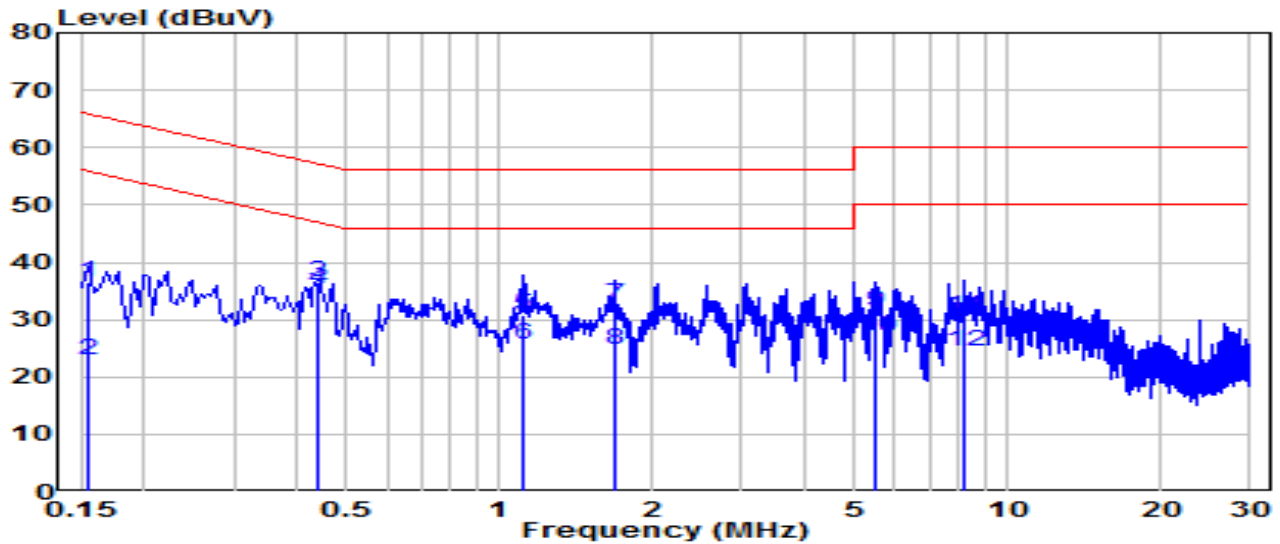

No	Frequency (MHz)	Reading (dBUV)	C.F (dB)	Measurement (dBUV)	Margin (dB)	Limit (dBUV)	Remark (QP/PK/AV)
1	0.154	26.87	9.63	36.50	-29.25	65.75	QP
2	0.154	13.18	9.63	22.81	-32.95	55.75	Average
3	* 0.438	26.91	9.65	36.55	-20.55	57.10	QP
4	* 0.438	25.68	9.65	35.32	-11.78	47.10	Average
5	1.108	21.09	9.68	30.77	-25.23	56.00	QP
6	1.108	15.96	9.68	25.65	-20.35	46.00	Average
7	1.684	22.84	9.69	32.53	-23.47	56.00	QP
8	1.684	15.05	9.69	24.75	-21.25	46.00	Average
9	5.477	21.55	9.76	31.31	-28.69	60.00	QP
10	5.477	17.12	9.76	26.88	-23.12	50.00	Average
11	8.209	20.81	9.83	30.63	-29.37	60.00	QP
12	8.209	14.70	9.83	24.53	-25.47	50.00	Average

Note:

- "\*", means this data is the worst emission level.
- C.F (Correction Factor) = LISN Factor (dB)+ Cable Loss (dB).
- Measurement (dBUV) = Reading(dBUV) + C.F (Correction Factor).

EUT	BE5000 Whole Home Mesh Wi-Fi 7 System	Date of Test	2024-04-17
Factor	CE_ENV216-N (Filter ON)	Temp. / Humidity	23.8°C /52%
Polarity	Neutral	Site / Test Engineer	SR2 / Bob
Test Mode	802.11n-20MHz_TX_CH 6_ANT 0+1	Test Voltage	AC 240V/60Hz

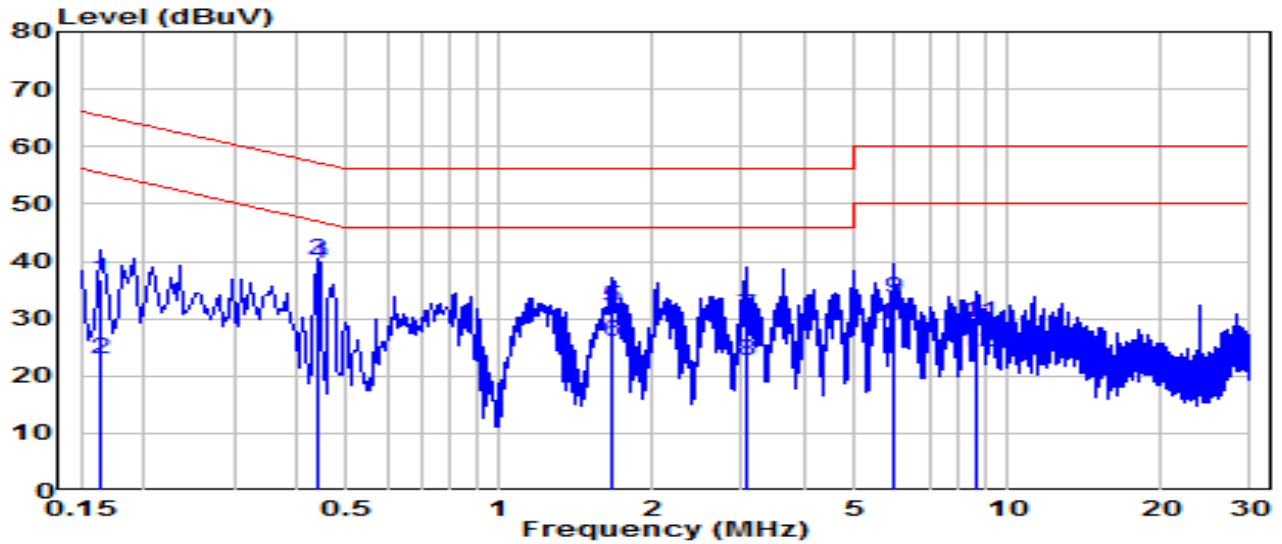

No	Frequency (MHz)	Reading (dBuV)	C.F (dB)	Measurement (dBuV)	Margin (dB)	Limit (dBuV)	Remark (QP/PK/AV)
1	0.163	27.29	9.63	36.92	-28.37	65.28	QP
2	0.163	13.41	9.63	23.04	-32.24	55.28	Average
3	* 0.438	30.47	9.65	40.12	-16.98	57.10	QP
4	* 0.438	29.76	9.65	39.41	-7.69	47.10	Average
5	1.675	22.24	9.70	31.94	-24.06	56.00	QP
6	1.675	16.19	9.70	25.89	-20.11	46.00	Average
7	3.057	20.79	9.73	30.52	-25.48	56.00	QP
8	3.057	12.88	9.73	22.60	-23.40	46.00	Average
9	5.995	23.75	9.78	33.53	-26.47	60.00	QP
10	5.995	19.20	9.78	28.98	-21.02	50.00	Average
11	8.717	19.45	9.86	29.31	-30.69	60.00	QP
12	8.717	14.45	9.86	24.30	-25.70	50.00	Average

Note:

1. " \*", means this data is the worst emission level.
2. C.F (Correction Factor) = LISN Factor (dB)+ Cable Loss (dB).
3. Measurement (dBuV) = Reading(dBuV) + C.F (Correction Factor).

## 8. CONCLUSION

The data collected relate only the item(s) tested and show that the device is compliance with Part 15C of the FCC Rules.

## **Appendix A : Test Setup Photograph**

Refer to “2403TW0113-UT” file.

## **Appendix B : External Photograph**

Refer to “2403TW0113-UE” file.

## **Appendix C : Internal Photograph**

Refer to “2403TW0113-UI” file.

————— The End —————