

802.11be-EHT20 Power Spectral Density - Ant 1

Channel 36 (5180MHz)

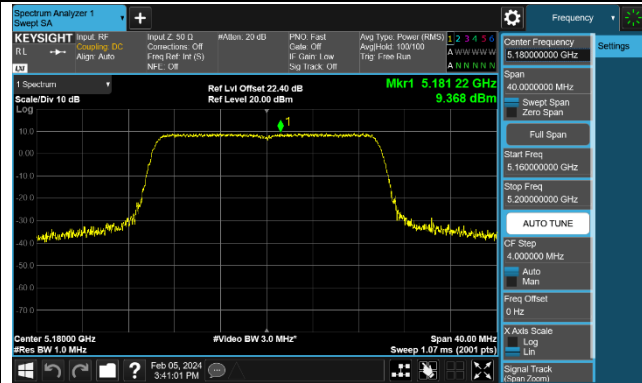

Channel 44 (5220MHz)

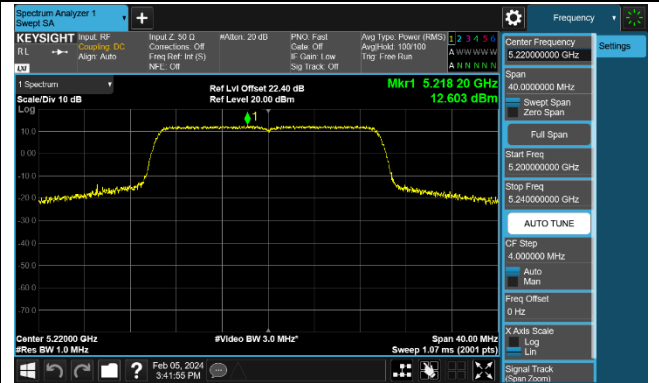

Channel 48 (5240MHz)

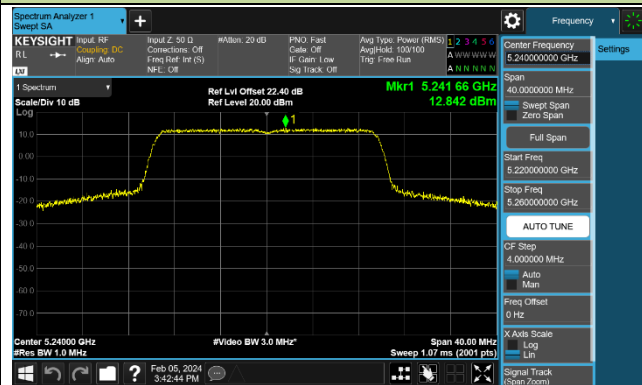

Channel 52 (5260MHz)

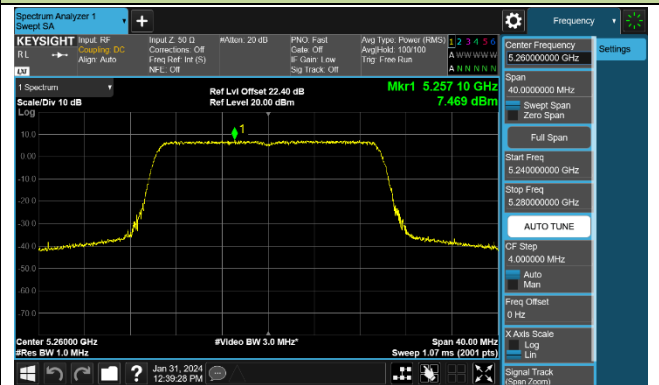

Channel 60 (5300MHz)

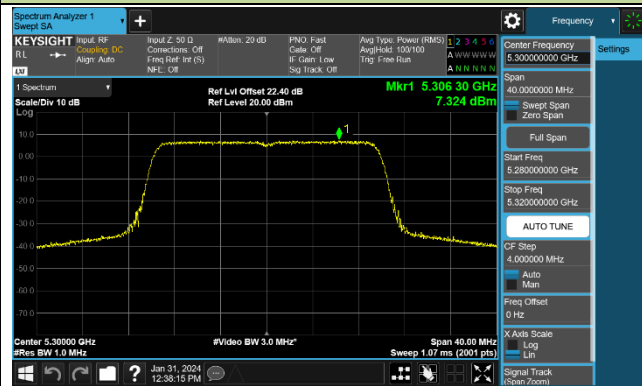

Channel 64 (5320MHz)

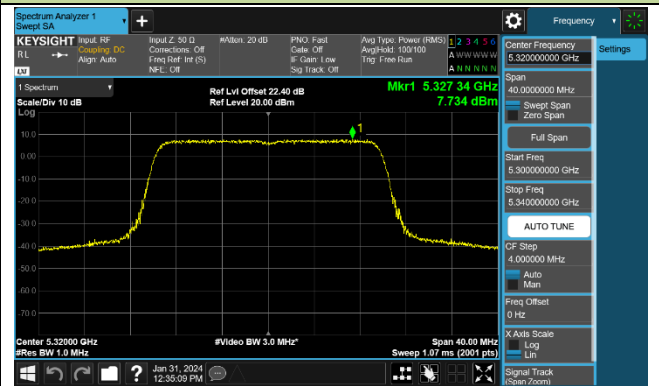

Channel 100 (5500MHz)

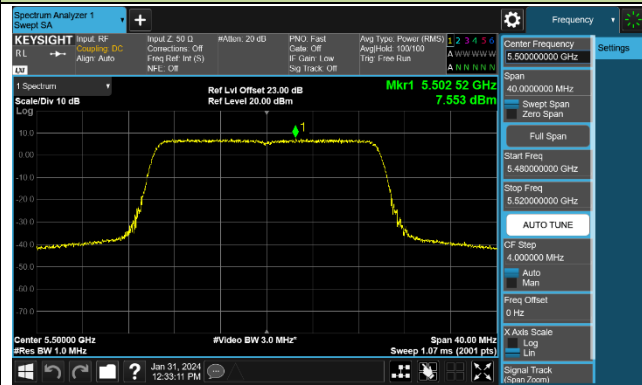

Channel 116 (5580MHz)

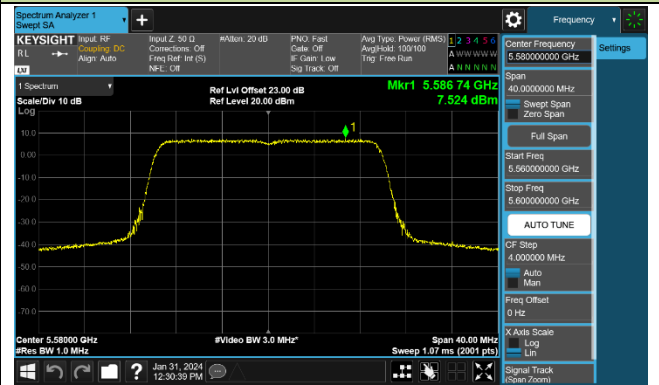

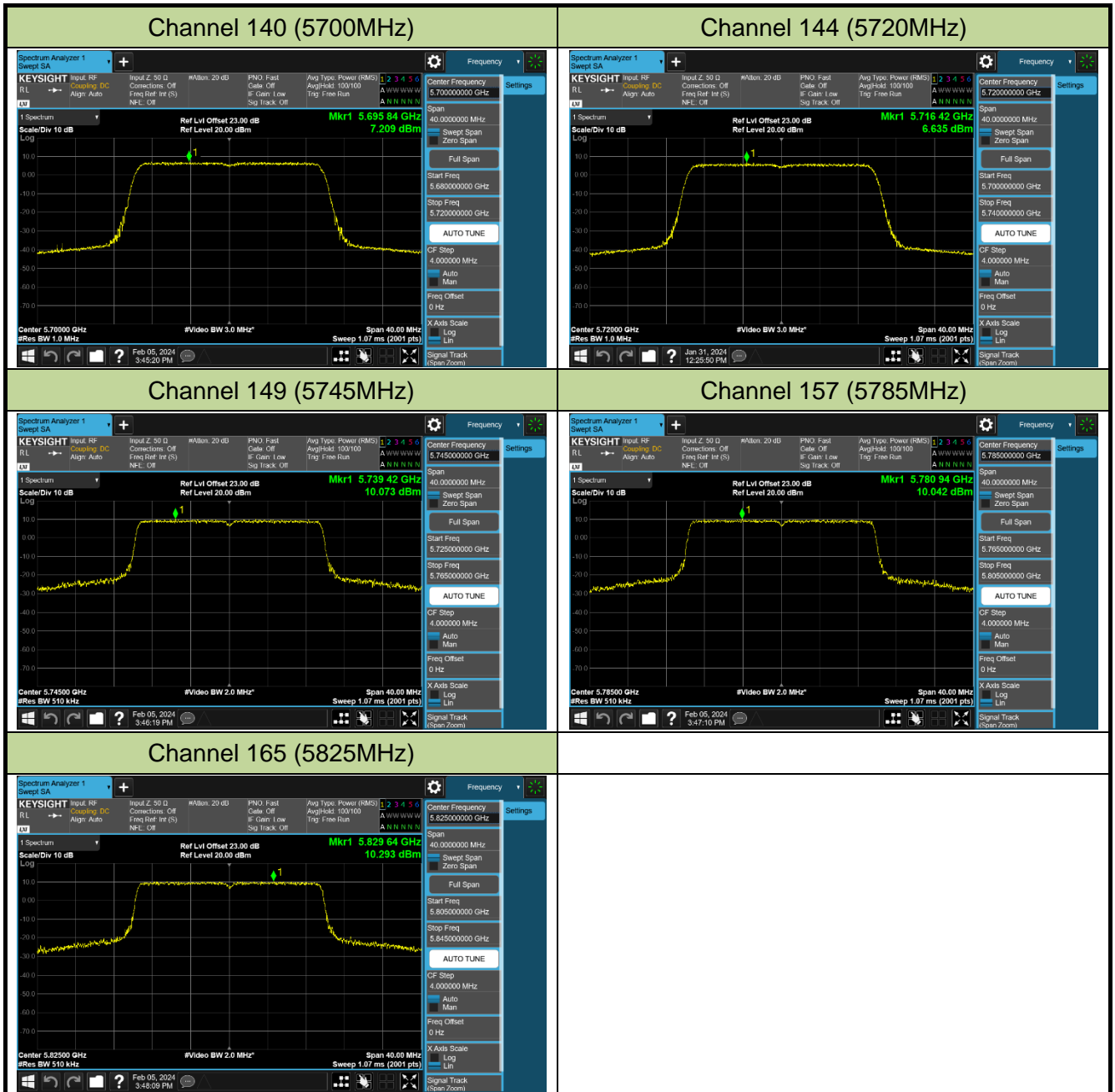

802.11be-EHT40 Power Spectral Density - Ant 1

Channel 38 (5190MHz)

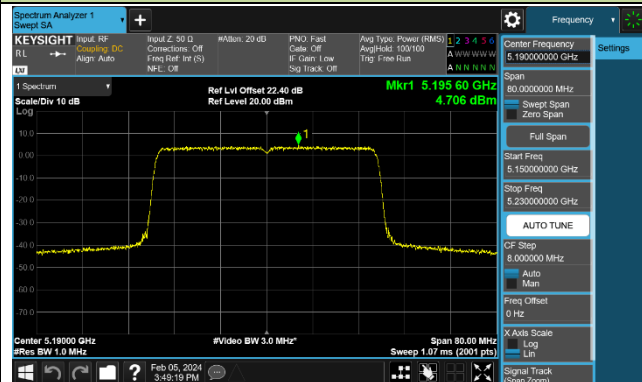

Channel 46 (5230MHz)

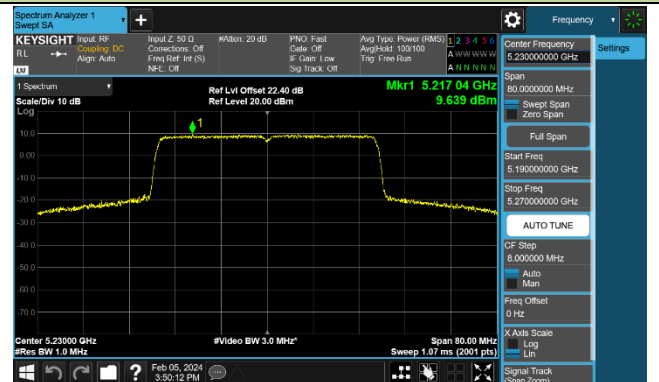

Channel 54 (5270MHz)

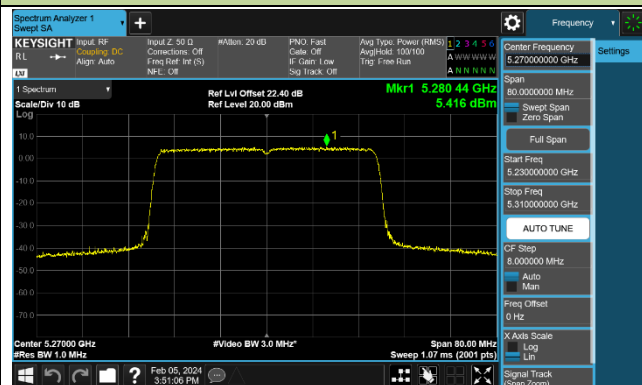

Channel 62 (5310MHz)

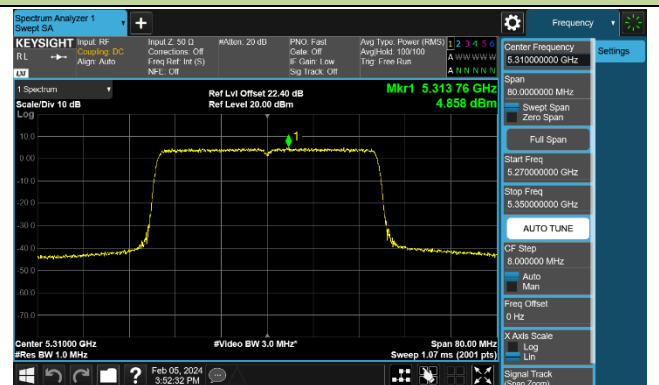

Channel 102 (5510MHz)

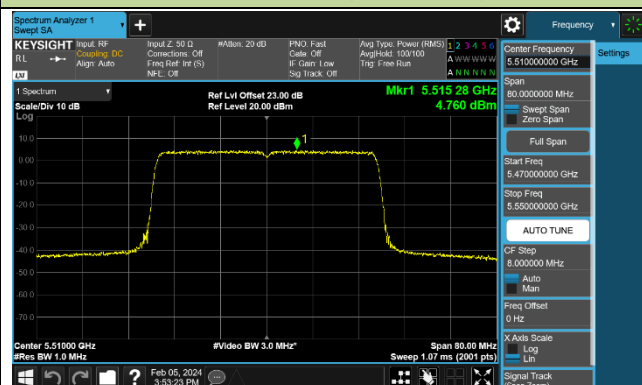

Channel 110 (5550MHz)

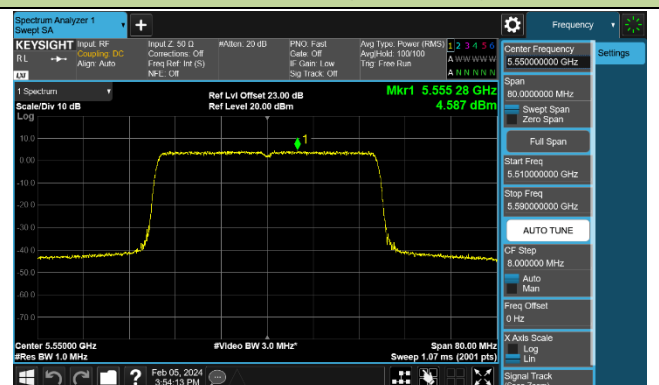

Channel 134 (5670MHz)

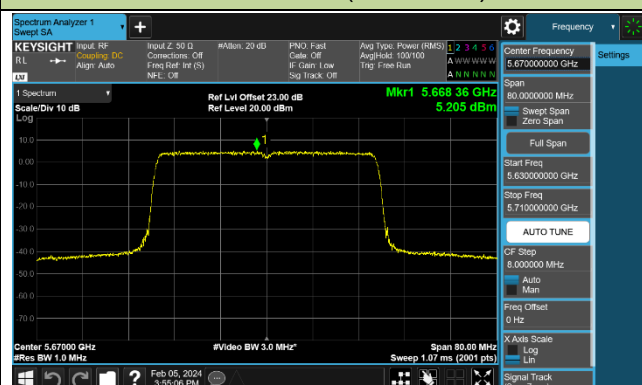

Channel 142 (5710MHz)

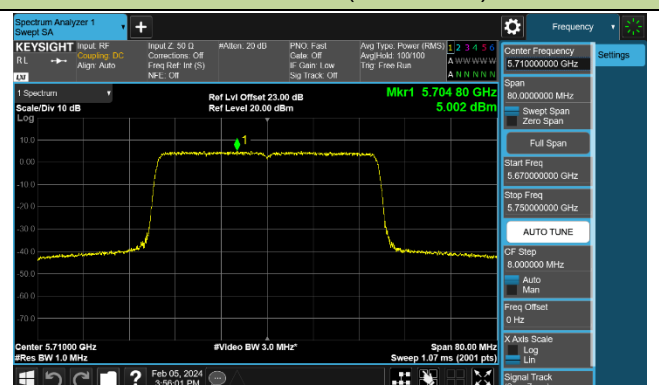

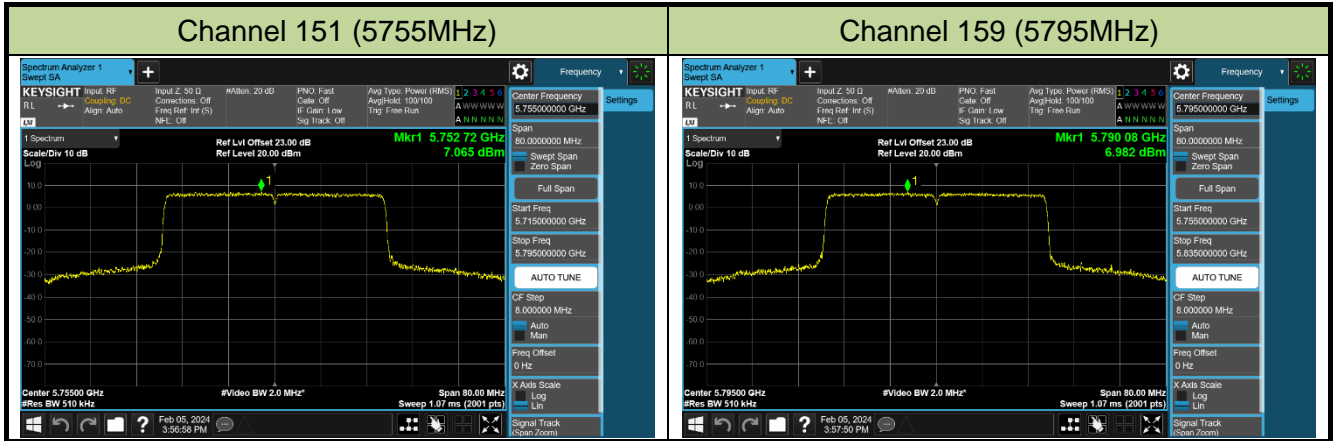

802.11be-EHT80 Power Spectral Density - Ant 1

Channel 42 (5210MHz)

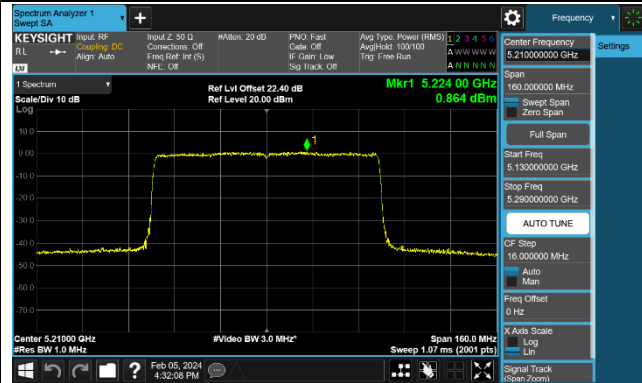

Channel 58 (5290MHz)

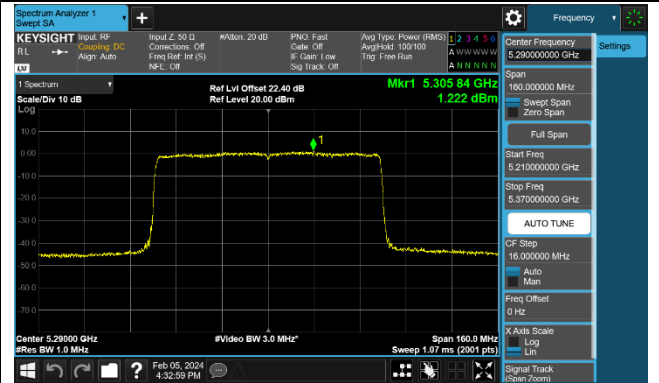

Channel 106 (5530MHz)

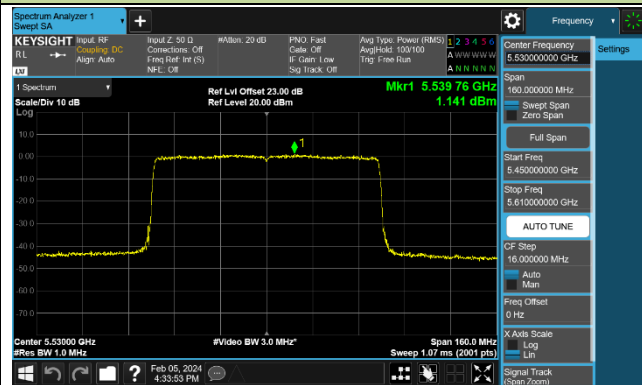

Channel 122 (5610MHz)

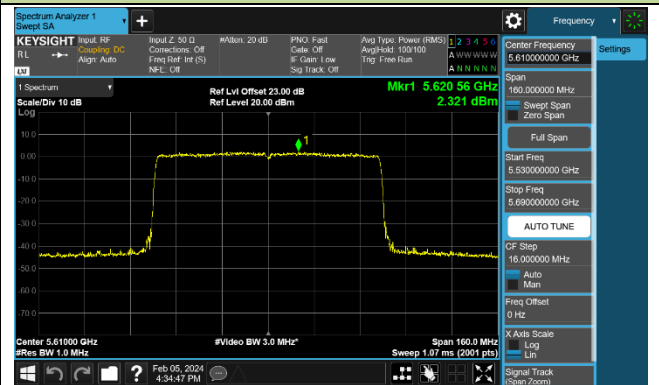

Channel 138 (5690MHz)

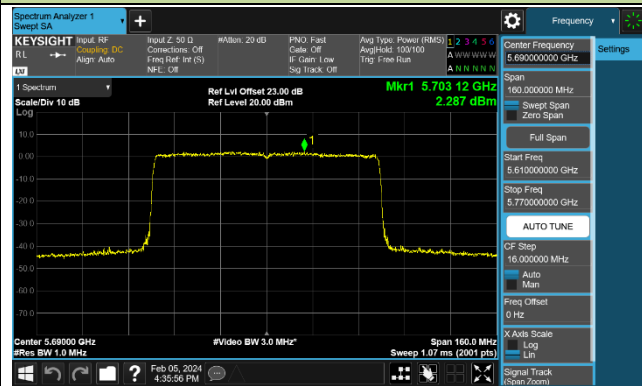

Channel 155 (5775MHz)

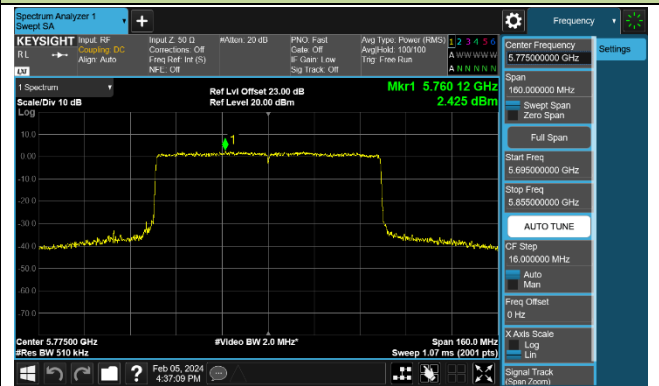

802.11be-EHT160 Power Spectral Density - Ant 1

Channel 50 (5250MHz)

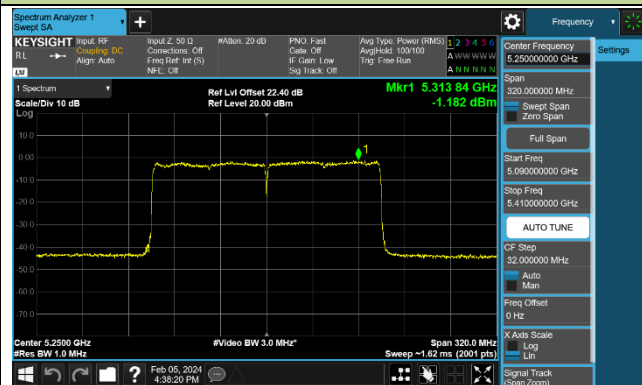

Channel 114 (5570MHz)

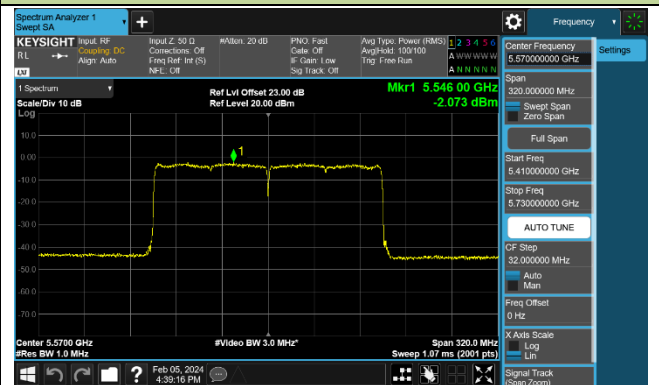

7.7. Frequency Stability Measurement

7.7.1. Test Limit

Manufactures of U-NII devices are responsible for ensuring frequency stability such that an emission is maintained within the band of operation under all conditions of normal operation as specified in the user's manual.

7.7.2. Test Limit

Frequency Stability Under Temperature Variations:

The equipment under test was connected to an external AC or DC power supply and input rated voltage. RF output was connected to a frequency counter or spectrum analyzer via feed through attenuators. The EUT was placed inside the temperature chamber. Set the spectrum analyzer RBW low enough to obtain the desired frequency resolution and measure EUT 20°C operating frequency as reference frequency. Turn EUT off and set the chamber temperature to highest. After the temperature stabilized for approximately 30 minutes recorded the frequency. Repeat step measure with 10°C decreased per stage until the lowest temperature reached.

Frequency Stability Under Voltage Variations:

Set chamber temperature to 20°C. Use a variable AC power supply / DC power source to power the EUT and set the voltage to rated voltage. Set the spectrum analyzer RBW low enough to obtain the desired frequency resolution and recorded the frequency.

Reduce the input voltage to specify extreme voltage variation ($\pm 15\%$) and endpoint, record the maximum frequency change.

7.7.3. Test Setup

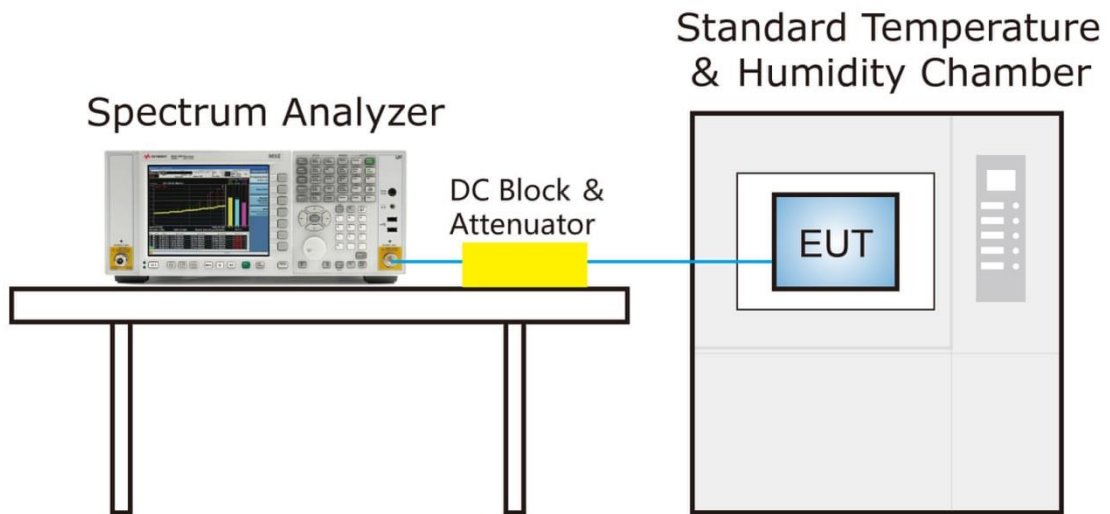

7.7.4. Test Result

Grantee ensure that the product meets e-CFR Title 47 section 15.407(g) and KDB 789033 D02v02r01 frequency stability such that the emissions are maintained within the band of operation under all conditions of normal operation as specified in the user's manual.

7.8. Radiated Spurious Emission Measurement

7.8.1. Test Limit

All out of band emissions appearing in a restricted band as specified in Section 15.205 of the Title 47CFR must not exceed the limits shown in Table per Section 15.209.

FCC Part 15 Subpart C Paragraph 15.209		
Frequency [MHz]	Field Strength [uV/m]	Measured Distance [Meters]
0.009 - 0.490	2400/F (kHz)	300
0.490 - 1.705	24000/F (kHz)	30
1.705 - 30	30	30
30 - 88	100	3
88 - 216	150	3
216 - 960	200	3
Above 960	500	3

7.8.2. Test Procedure Used

KDB 789033 D02v02r01- Section G

7.8.3. Test Setting

Table 1 - RBW as a function of frequency

Frequency	RBW
9 ~ 150 kHz	200 ~ 300 Hz
0.15 ~ 30 MHz	9 ~ 10 kHz
30 ~ 1000 MHz	100 ~ 120 kHz
>1000 MHz	1 MHz

Quasi-Peak Measurements below 1GHz

1. Analyzer center frequency was set to the frequency of the radiated spurious emission of interest
2. Span was set greater than 1MHz
3. RBW = as specified in Table 1
4. Detector = CISPR quasi-peak
5. Sweep time = auto couple
6. Trace was allowed to stabilize

Peak Measurements above 1GHz

1. Analyzer center frequency was set to the frequency of the radiated spurious emission of interest
2. RBW = 1MHz
3. VBW = 3MHz
4. Detector = peak
5. Sweep time = auto couple
6. Trace mode = max hold
7. Trace was allowed to stabilize

Average Measurements above 1GHz (Method VB)

1. Analyzer center frequency was set to the frequency of the radiated spurious emission of interest
2. RBW = 1MHz
3. VBW; If the EUT is configured to transmit with duty cycle $\geq 98\%$, set VBW = 10 Hz.
If the EUT duty cycle is $< 98\%$, set VBW $\geq 1/T$. T is the minimum transmission duration.
4. Detector = Peak
5. Sweep time = auto
6. Trace mode = max hold
7. Trace was allowed to stabilize

7.8.4. Test Setup

Below 1GHz Test Setup:

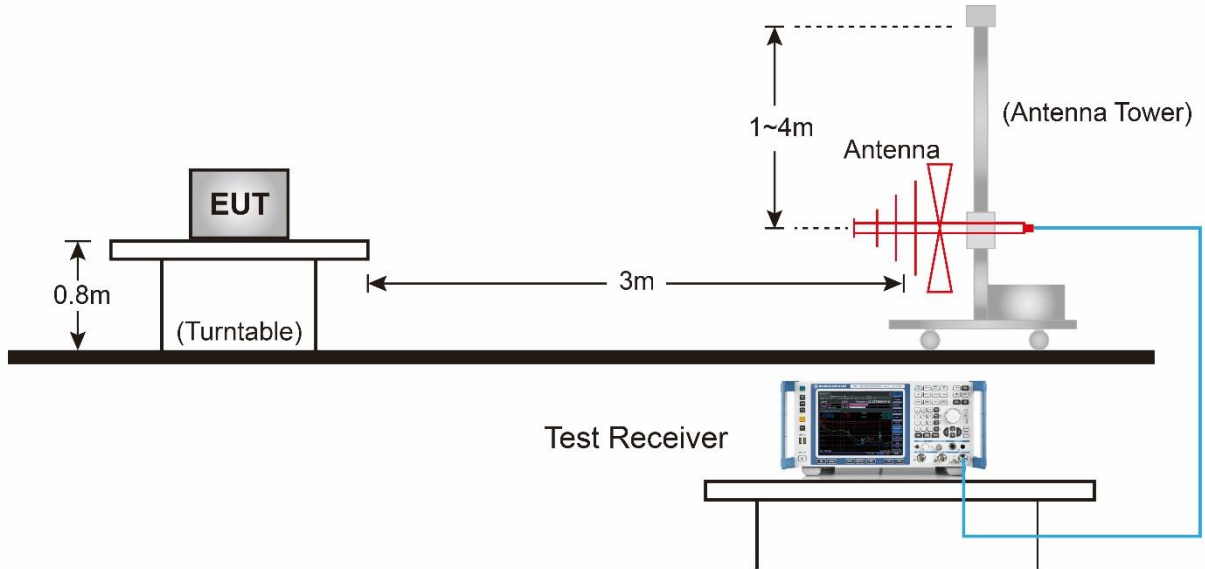

Above 1GHz Test Setup:

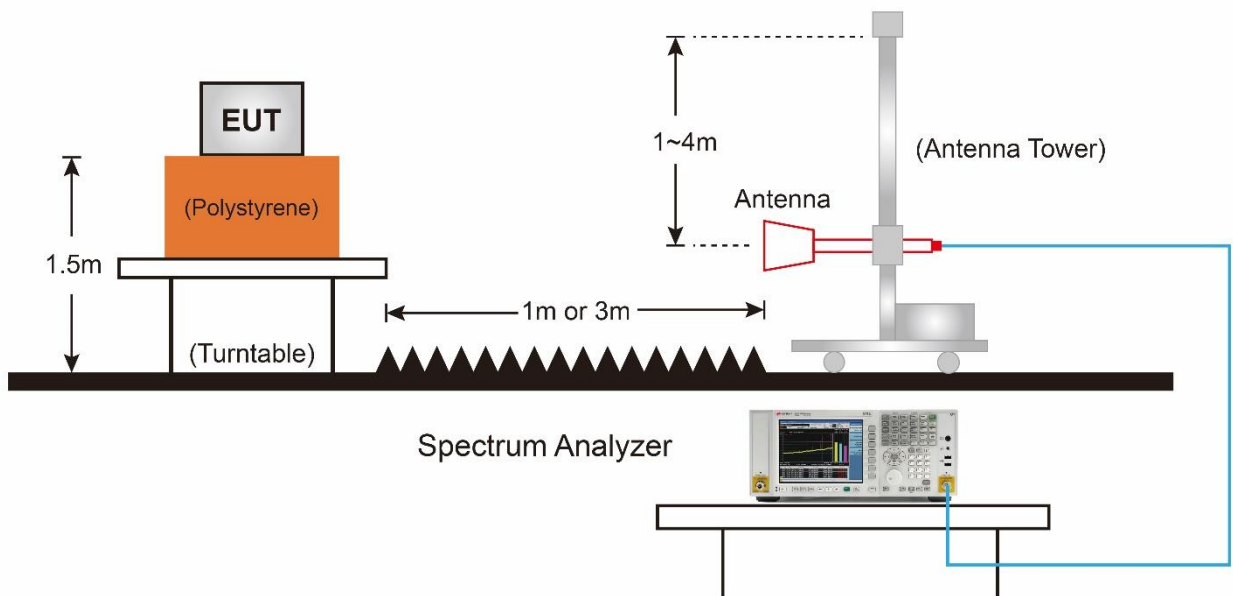

7.8.5. Test Result

EUT	BE3600 Dual-Band Wi-Fi 7 Router	Date of Test	2024-02-05
Factor	VULB 9162	Temp. / Humidity	20°C /65%
Polarity	Horizontal	Site / Test Engineer	AC2 / Stanley
Test Mode	802.11ac-20MHz_TX_Band1_CH 44_ANT 0+1	Test Voltage	AC 120V/60Hz

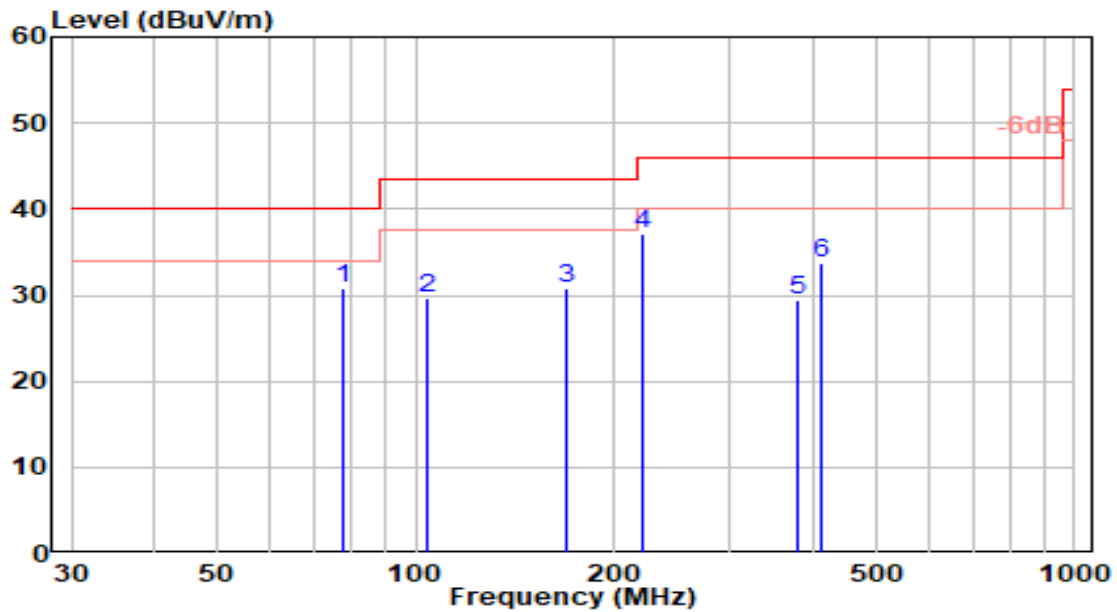

No	Frequency (MHz)	Reading (dBUV)	C.F (dB/m)	Measurement (dBUV/m)	Margin (dB)	Limit (dBUV/m)	Height (cm)	Angle (deg)	Remark (QP/PK/AV)
1	77.280	16.57	14.31	30.88	-9.12	40.00	200	322	QP
2	103.640	11.40	18.34	29.74	-13.76	43.50	150	81	QP
3	168.840	15.02	15.77	30.80	-12.70	43.50	200	14	QP
4	* 221.070	18.68	18.40	37.08	-8.92	46.00	150	14	QP
5	378.590	6.41	22.95	29.37	-16.63	46.00	100	48	QP
6	413.750	10.26	23.46	33.72	-12.28	46.00	150	147	QP

Note:

1. " *", means this data is the worst emission level.
2. C.F (Correction Factor) = Antenna Factor (dB/m) + Cable Loss (dB).
3. Measurement (dBUV/m) = Reading(dBUV) + C.F (Correction Factor).
4. The emission levels of other frequencies are very lower than the limit and not show in test report.
5. The amplitude of radiated emissions (frequency range from 9kHz to 30MHz) is that proximity to ambient noise, which also are attenuated more than 20dB below the permissible value. Therefore, the data is not presented in the report.

EUT	BE3600 Dual-Band Wi-Fi 7 Router	Date of Test	2024-02-05
Factor	VULB 9162	Temp. / Humidity	20°C /65%
Polarity	Vertical	Site / Test Engineer	AC2 / Stanley
Test Mode	802.11ac-20MHz_TX_Band1_CH 44_ANT 0+1	Test Voltage	AC 120V/60Hz

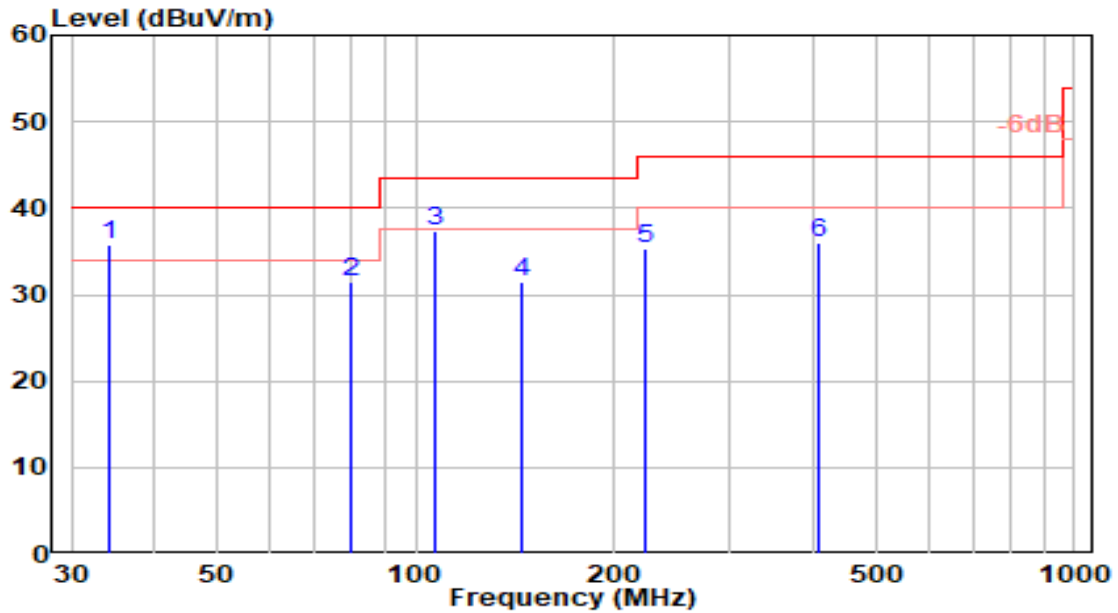

No	Frequency (MHz)	Reading (dBuV)	C.F (dB/m)	Measurement (dBuV/m)	Margin (dB)	Limit (dBuV/m)	Height (cm)	Angle (deg)	Remark (QP/PK/AV)
1	* 34.240	18.23	17.57	35.80	-4.20	40.00	150	7	QP
2	79.430	17.63	13.93	31.56	-8.44	40.00	100	7	QP
3	107.180	19.09	18.36	37.45	-6.05	43.50	100	1	QP
4	144.450	16.65	14.92	31.57	-11.93	43.50	200	71	QP
5	222.240	16.94	18.47	35.41	-10.59	46.00	200	314	QP
6	410.540	12.60	23.42	36.02	-9.98	46.00	150	156	QP

Note:

- "*", means this data is the worst emission level.
- C.F (Correction Factor) = Antenna Factor (dB/m) + Cable Loss (dB).
- Measurement (dBuV/m) = Reading(dBuV) + C.F (Correction Factor).
- The emission levels of other frequencies are very lower than the limit and not show in test report.
- The amplitude of radiated emissions (frequency range from 9kHz to 30MHz) is that proximity to ambient noise, which also are attenuated more than 20dB below the permissible value. Therefore, the data is not presented in the report.

EUT	BE3600 Dual-Band Wi-Fi 7 Router	Date of Test	2024-02-06
Factor	DRH18-E	Temp. / Humidity	20°C /65%
Polarity	Horizontal	Site / Test Engineer	AC2 / Stanley
Test Mode	802.11a_TX_Band1_CH 36_ANT 0+1	Test Voltage	AC 120V/60Hz

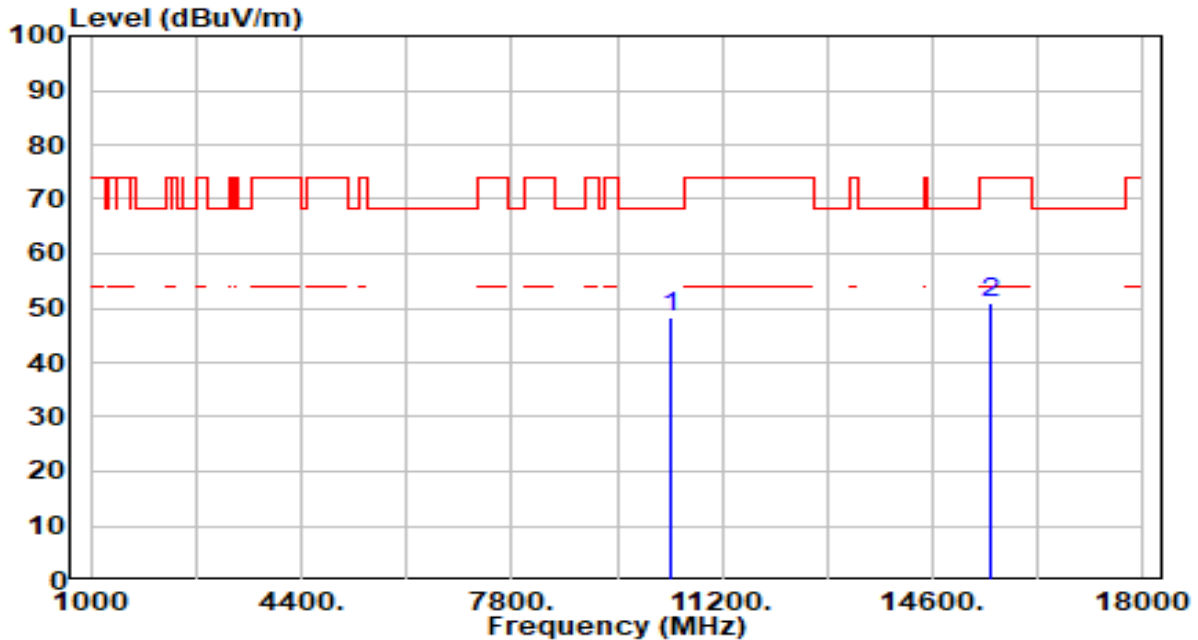

No	Frequency (MHz)	Reading (dBuV)	C.F (dB/m)	Measurement (dBuV/m)	Margin (dB)	Limit (dBuV/m)	Height (cm)	Angle (deg)	Remark (QP/PK/AV)
1	*	43.50	4.87	48.37	-19.83	68.20	300	129	Peak
2		44.87	6.21	51.07	-22.93	74.00	300	126	Peak

Note:

1. " *", means this data is the worst emission level.
2. C.F (Correction Factor) = Antenna Factor (dB/m)+ Cable Loss (dB) – Preamplifier(dB).
3. Measurement (dBuV/m) = Reading(dBuV) + C.F (Correction Factor).
4. The emission levels of other frequencies are very lower than the limit and not show in test report.

EUT	BE3600 Dual-Band Wi-Fi 7 Router	Date of Test	2024-02-06
Factor	DRH18-E	Temp. / Humidity	20°C /65%
Polarity	Vertical	Site / Test Engineer	AC2 / Stanley
Test Mode	802.11a_TX_Band1_CH 36_ANT 0+1	Test Voltage	AC 120V/60Hz

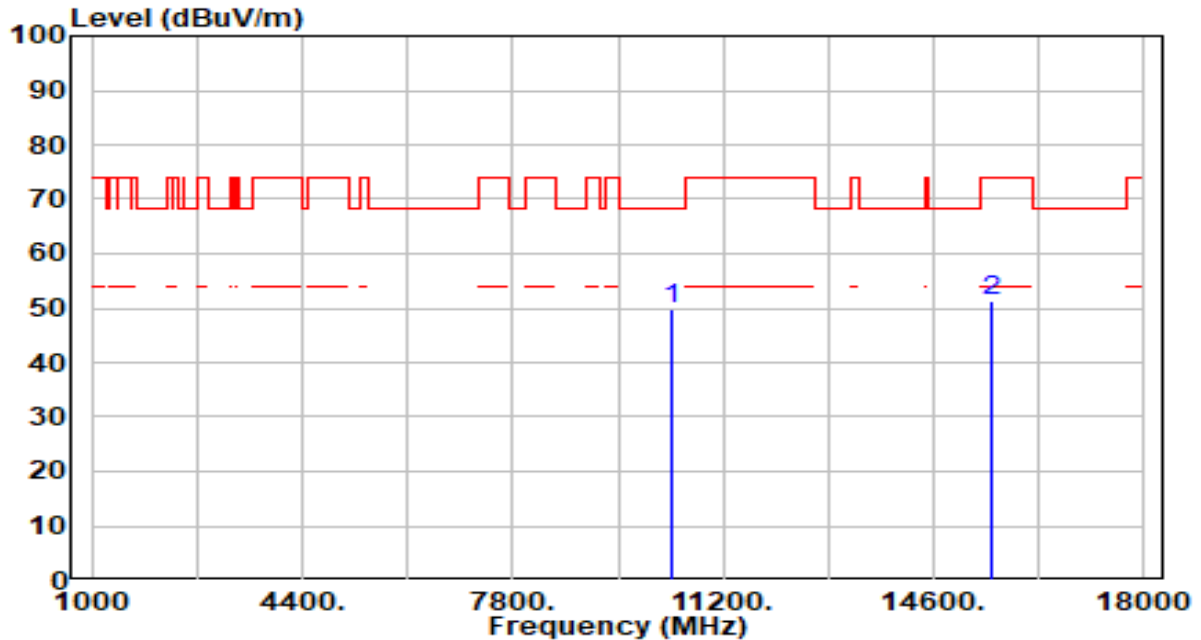

No	Frequency (MHz)	Reading (dBuV)	C.F (dB/m)	Measurement (dBuV/m)	Margin (dB)	Limit (dBuV/m)	Height (cm)	Angle (deg)	Remark (QP/PK/AV)
1	* 10360.000	45.00	4.87	49.87	-18.33	68.20	100	94	Peak
2	15540.000	45.17	6.21	51.38	-22.62	74.00	200	292	Peak

Note:

1. " *", means this data is the worst emission level.
2. C.F (Correction Factor) = Antenna Factor (dB/m)+ Cable Loss (dB) – Preamplifier(dB).
3. Measurement (dBuV/m) = Reading(dBuV) + C.F (Correction Factor).
4. The emission levels of other frequencies are very lower than the limit and not show in test report.

EUT	BE3600 Dual-Band Wi-Fi 7 Router	Date of Test	2024-02-06
Factor	DRH18-E	Temp. / Humidity	20°C /65%
Polarity	Horizontal	Site / Test Engineer	AC2 / Stanley
Test Mode	802.11a_TX_Band1_CH 44_ANT 0+1	Test Voltage	AC 120V/60Hz

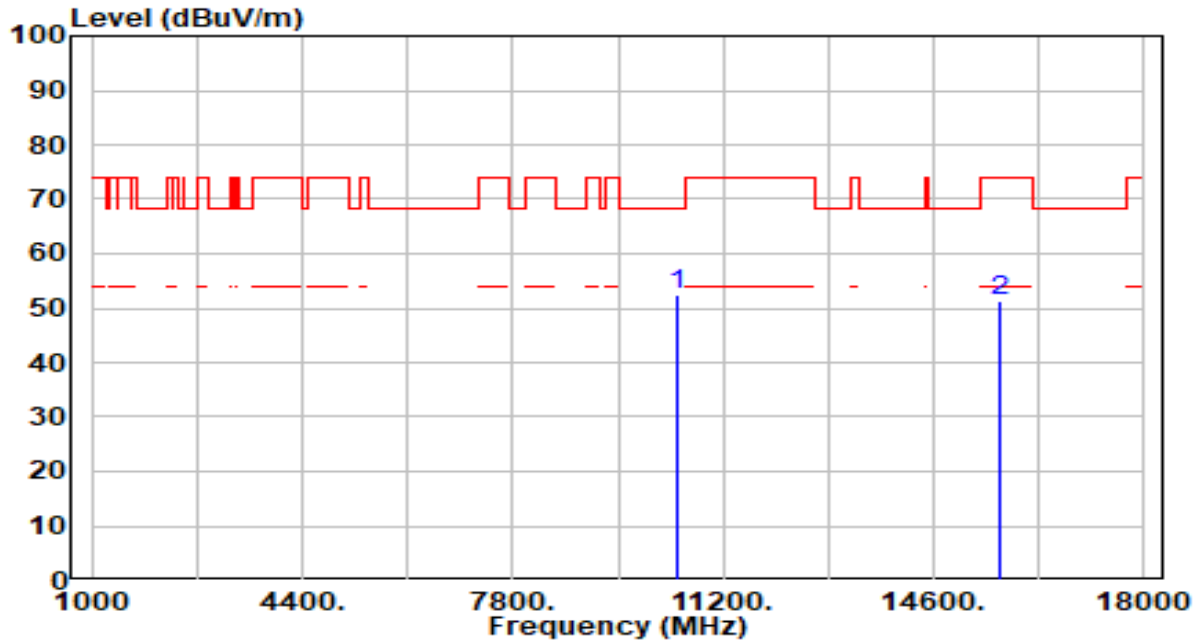

No	Frequency (MHz)	Reading (dBuV)	C.F (dB/m)	Measurement (dBuV/m)	Margin (dB)	Limit (dBuV/m)	Height (cm)	Angle (deg)	Remark (QP/PK/AV)
1	* 10440.000	47.71	4.76	52.48	-15.72	68.20	100	210	Peak
2	15660.000	44.96	6.27	51.22	-22.78	74.00	100	146	Peak

Note:

1. " *", means this data is the worst emission level.
2. C.F (Correction Factor) = Antenna Factor (dB/m)+ Cable Loss (dB) – Preamplifier(dB).
3. Measurement (dBuV/m) = Reading(dBuV) + C.F (Correction Factor).
4. The emission levels of other frequencies are very lower than the limit and not show in test report.

EUT	BE3600 Dual-Band Wi-Fi 7 Router	Date of Test	2024-02-06
Factor	DRH18-E	Temp. / Humidity	20°C /65%
Polarity	Vertical	Site / Test Engineer	AC2 / Stanley
Test Mode	802.11a_TX_Band1_CH 44_ANT 0+1	Test Voltage	AC 120V/60Hz

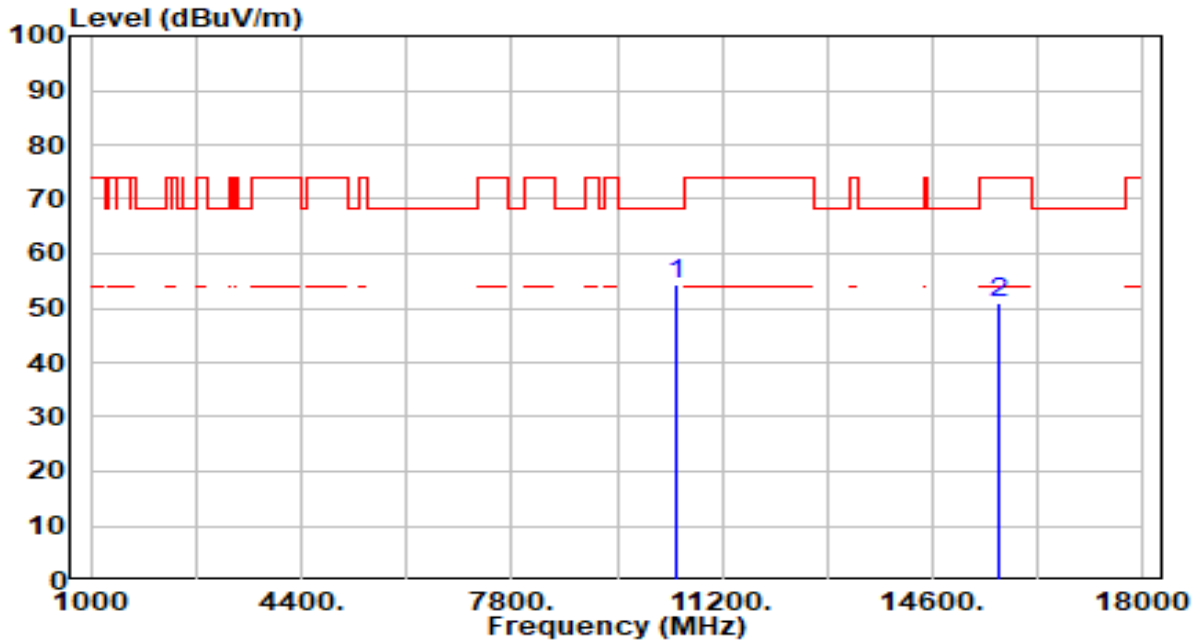

No	Frequency (MHz)	Reading (dBuV)	C.F (dB/m)	Measurement (dBuV/m)	Margin (dB)	Limit (dBuV/m)	Height (cm)	Angle (deg)	Remark (QP/PK/AV)
1	* 10440.000	49.57	4.76	54.34	-13.86	68.20	100	141	Peak
2	15660.000	44.84	6.27	51.11	-22.89	74.00	100	32	Peak

Note:

1. " *", means this data is the worst emission level.
2. C.F (Correction Factor) = Antenna Factor (dB/m)+ Cable Loss (dB) – Preamplifier(dB).
3. Measurement (dBuV/m) = Reading(dBuV) + C.F (Correction Factor).
4. The emission levels of other frequencies are very lower than the limit and not show in test report.

EUT	BE3600 Dual-Band Wi-Fi 7 Router	Date of Test	2024-02-06
Factor	DRH18-E	Temp. / Humidity	20°C /65%
Polarity	Horizontal	Site / Test Engineer	AC2 / Stanley
Test Mode	802.11a_TX_Band1_CH 48_ANT 0+1	Test Voltage	AC 120V/60Hz

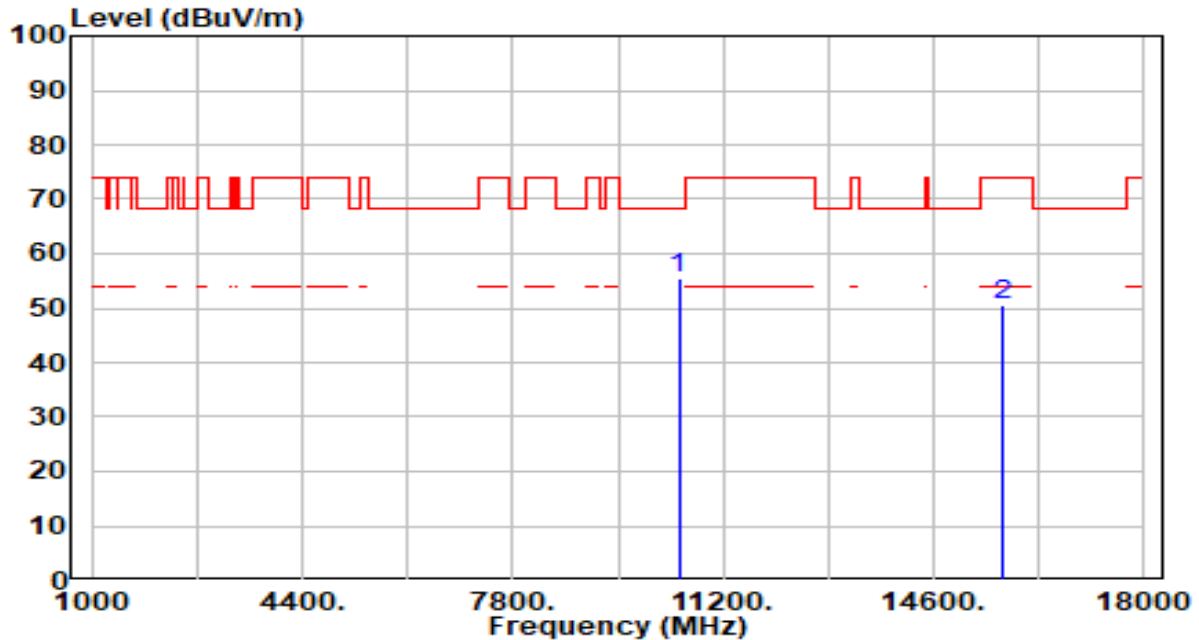

No	Frequency (MHz)	Reading (dBuV)	C.F (dB/m)	Measurement (dBuV/m)	Margin (dB)	Limit (dBuV/m)	Height (cm)	Angle (deg)	Remark (QP/PK/AV)
1	* 10480.000	50.66	4.71	55.37	-12.83	68.20	100	152	Peak
2	15720.000	44.29	6.39	50.67	-23.33	74.00	100	28	Peak

Note:

1. " *", means this data is the worst emission level.
2. C.F (Correction Factor) = Antenna Factor (dB/m)+ Cable Loss (dB) – Preamplifier(dB).
3. Measurement (dBuV/m) = Reading(dBuV) + C.F (Correction Factor).
4. The emission levels of other frequencies are very lower than the limit and not show in test report.

EUT	BE3600 Dual-Band Wi-Fi 7 Router	Date of Test	2024-02-06
Factor	DRH18-E	Temp. / Humidity	20°C /65%
Polarity	Vertical	Site / Test Engineer	AC2 / Stanley
Test Mode	802.11a_TX_Band1_CH 48_ANT 0+1	Test Voltage	AC 120V/60Hz

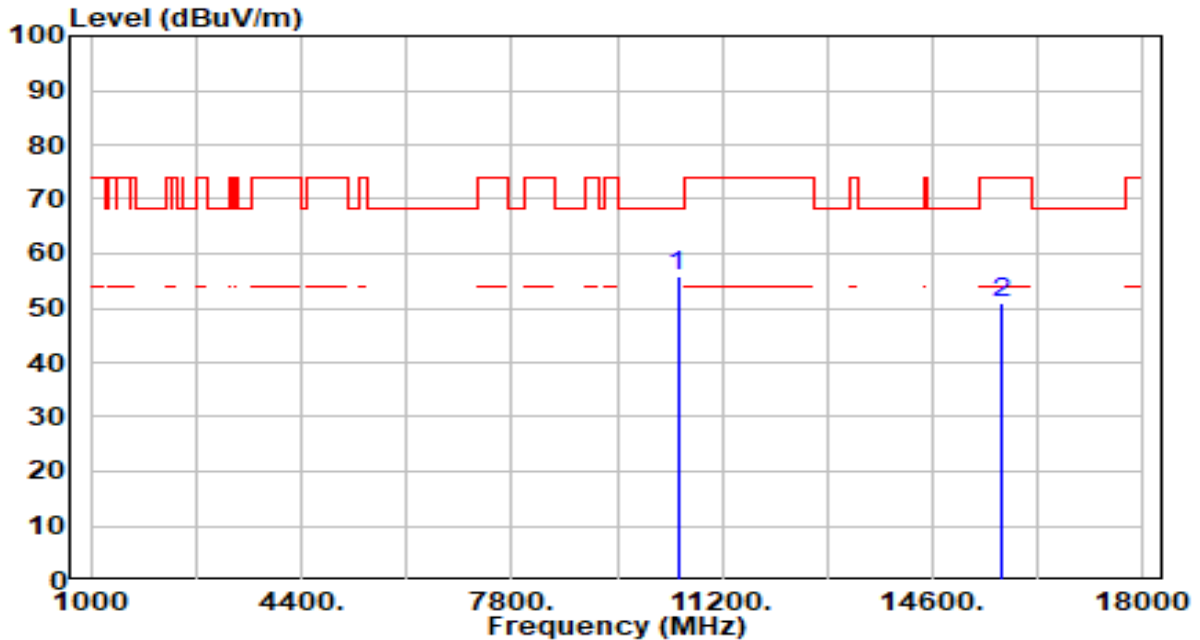

No	Frequency (MHz)	Reading (dBuV)	C.F (dB/m)	Measurement (dBuV/m)	Margin (dB)	Limit (dBuV/m)	Height (cm)	Angle (deg)	Remark (QP/PK/AV)
1	* 10480.000	51.31	4.71	56.02	-12.18	68.20	100	142	Peak
2	15720.000	44.66	6.39	51.04	-22.96	74.00	100	348	Peak

Note:

1. " *", means this data is the worst emission level.
2. C.F (Correction Factor) = Antenna Factor (dB/m)+ Cable Loss (dB) – Preamplifier(dB).
3. Measurement (dBuV/m) = Reading(dBuV) + C.F (Correction Factor).
4. The emission levels of other frequencies are very lower than the limit and not show in test report.

EUT	BE3600 Dual-Band Wi-Fi 7 Router	Date of Test	2024-02-06
Factor	DRH18-E	Temp. / Humidity	20°C /65%
Polarity	Horizontal	Site / Test Engineer	AC2 / Stanley
Test Mode	802.11a_TX_Band2_CH 52_ANT 0+1	Test Voltage	AC 120V/60Hz

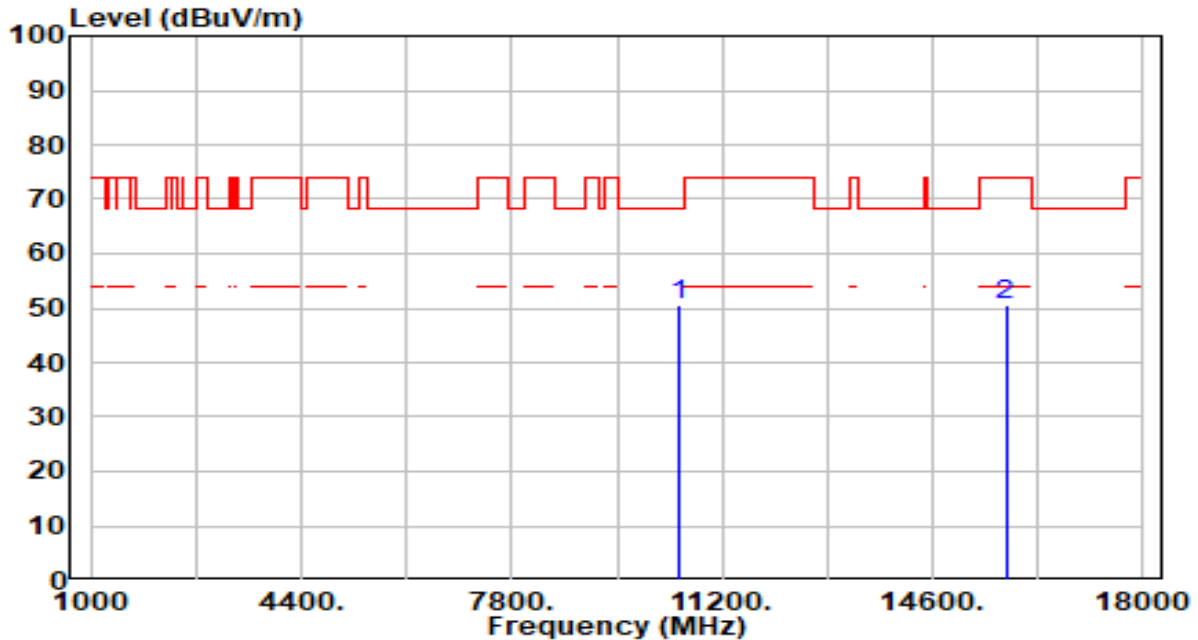

No	Frequency (MHz)	Reading (dBuV)	C.F (dB/m)	Measurement (dBuV/m)	Margin (dB)	Limit (dBuV/m)	Height (cm)	Angle (deg)	Remark (QP/PK/AV)
1	*	46.02	4.67	50.69	-17.51	68.20	100	210	Peak
2		43.88	6.51	50.39	-23.61	74.00	100	290	Peak

Note:

1. " *", means this data is the worst emission level.
2. C.F (Correction Factor) = Antenna Factor (dB/m)+ Cable Loss (dB) – Preamplifier(dB).
3. Measurement (dBuV/m) = Reading(dBuV) + C.F (Correction Factor).
4. The emission levels of other frequencies are very lower than the limit and not show in test report.

EUT	BE3600 Dual-Band Wi-Fi 7 Router	Date of Test	2024-02-06
Factor	DRH18-E	Temp. / Humidity	20°C /65%
Polarity	Vertical	Site / Test Engineer	AC2 / Stanley
Test Mode	802.11a_TX_Band2_CH 52_ANT 0+1	Test Voltage	AC 120V/60Hz

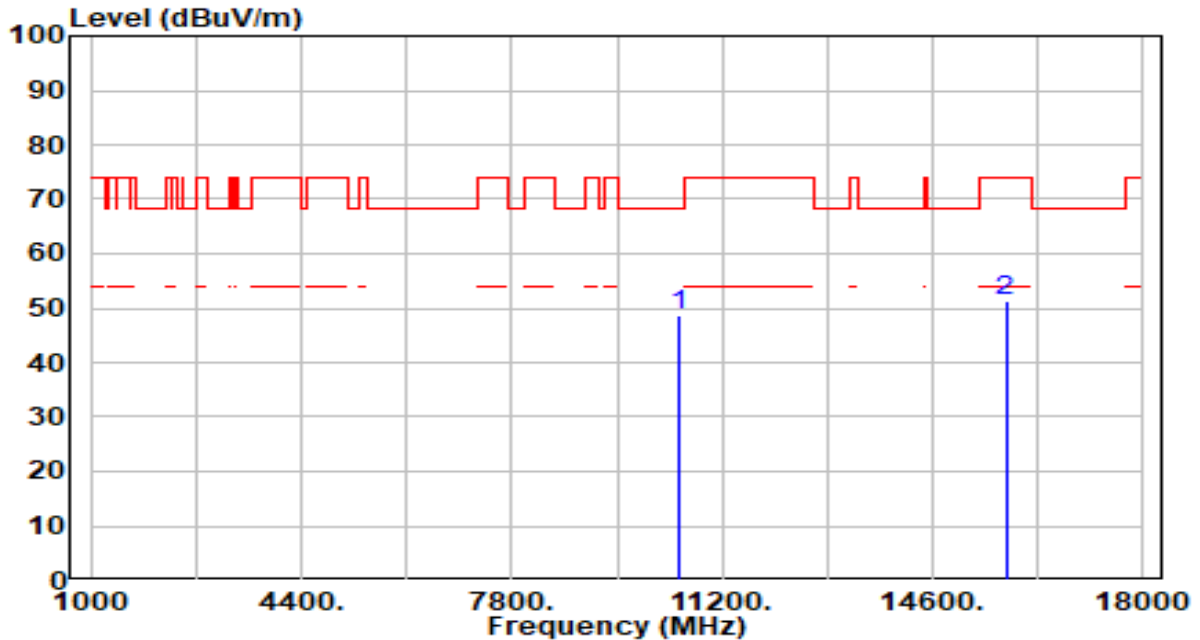

No	Frequency (MHz)	Reading (dBuV)	C.F (dB/m)	Measurement (dBuV/m)	Margin (dB)	Limit (dBuV/m)	Height (cm)	Angle (deg)	Remark (QP/PK/AV)
1	*	44.01	4.67	48.68	-19.52	68.20	100	141	Peak
2		44.79	6.51	51.30	-22.70	74.00	100	43	Peak

Note:

1. " *", means this data is the worst emission level.
2. C.F (Correction Factor) = Antenna Factor (dB/m)+ Cable Loss (dB) – Preamplifier(dB).
3. Measurement (dBuV/m) = Reading(dBuV) + C.F (Correction Factor).
4. The emission levels of other frequencies are very lower than the limit and not show in test report.

EUT	BE3600 Dual-Band Wi-Fi 7 Router	Date of Test	2024-02-06
Factor	DRH18-E	Temp. / Humidity	20°C /65%
Polarity	Horizontal	Site / Test Engineer	AC2 / Stanley
Test Mode	802.11a_TX_Band2_CH 60_ANT 0+1	Test Voltage	AC 120V/60Hz

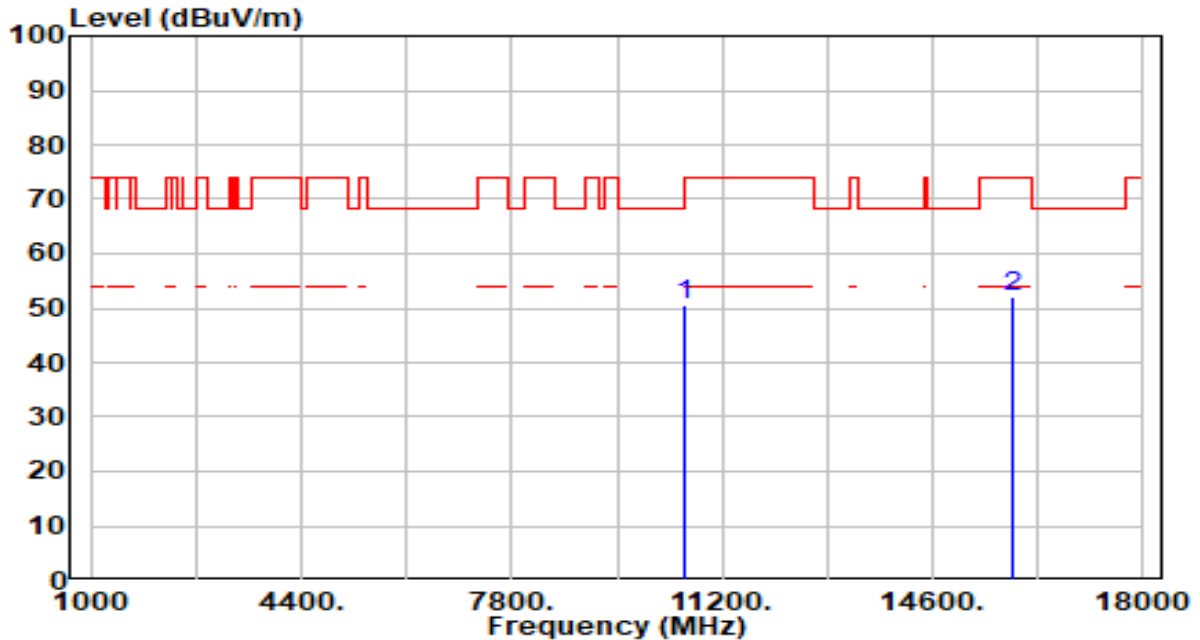

No	Frequency (MHz)	Reading (dBuV)	C.F (dB/m)	Measurement (dBuV/m)	Margin (dB)	Limit (dBuV/m)	Height (cm)	Angle (deg)	Remark (QP/PK/AV)
1	* 10600.000	45.78	4.61	50.39	-17.81	68.20	100	216	Peak
2	15900.000	45.47	6.55	52.02	-21.98	74.00	100	293	Peak

Note:

1. " *", means this data is the worst emission level.
2. C.F (Correction Factor) = Antenna Factor (dB/m)+ Cable Loss (dB) – Preamplifier(dB).
3. Measurement (dBuV/m) = Reading(dBuV) + C.F (Correction Factor).
4. The emission levels of other frequencies are very lower than the limit and not show in test report.

EUT	BE3600 Dual-Band Wi-Fi 7 Router	Date of Test	2024-02-06
Factor	DRH18-E	Temp. / Humidity	20°C /65%
Polarity	Vertical	Site / Test Engineer	AC2 / Stanley
Test Mode	802.11a_TX_Band2_CH 60_ANT 0+1	Test Voltage	AC 120V/60Hz

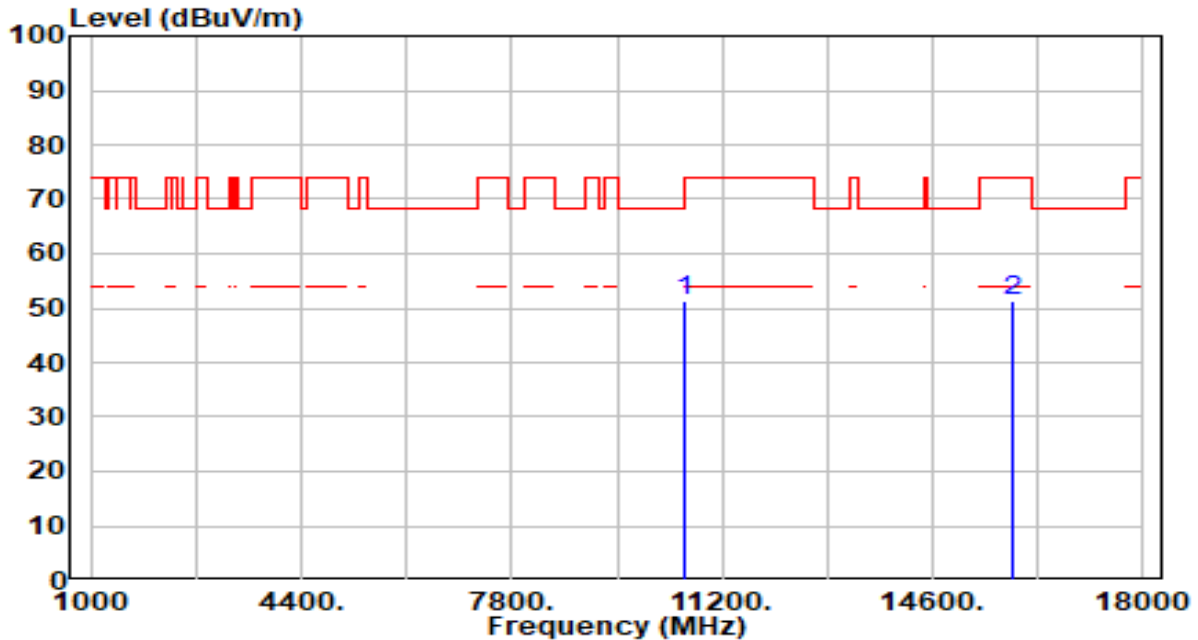

No	Frequency (MHz)	Reading (dBuV)	C.F (dB/m)	Measurement (dBuV/m)	Margin (dB)	Limit (dBuV/m)	Height (cm)	Angle (deg)	Remark (QP/PK/AV)
1	*	46.79	4.61	51.40	-16.80	68.20	100	162	Peak
2		44.70	6.55	51.25	-22.75	74.00	100	342	Peak

Note:

1. " *", means this data is the worst emission level.
2. C.F (Correction Factor) = Antenna Factor (dB/m)+ Cable Loss (dB) – Preamplifier(dB).
3. Measurement (dBuV/m) = Reading(dBuV) + C.F (Correction Factor).
4. The emission levels of other frequencies are very lower than the limit and not show in test report.

EUT	BE3600 Dual-Band Wi-Fi 7 Router	Date of Test	2024-02-06
Factor	DRH18-E	Temp. / Humidity	20°C /65%
Polarity	Horizontal	Site / Test Engineer	AC2 / Stanley
Test Mode	802.11a_TX_Band2_CH 64_ANT 0+1	Test Voltage	AC 120V/60Hz

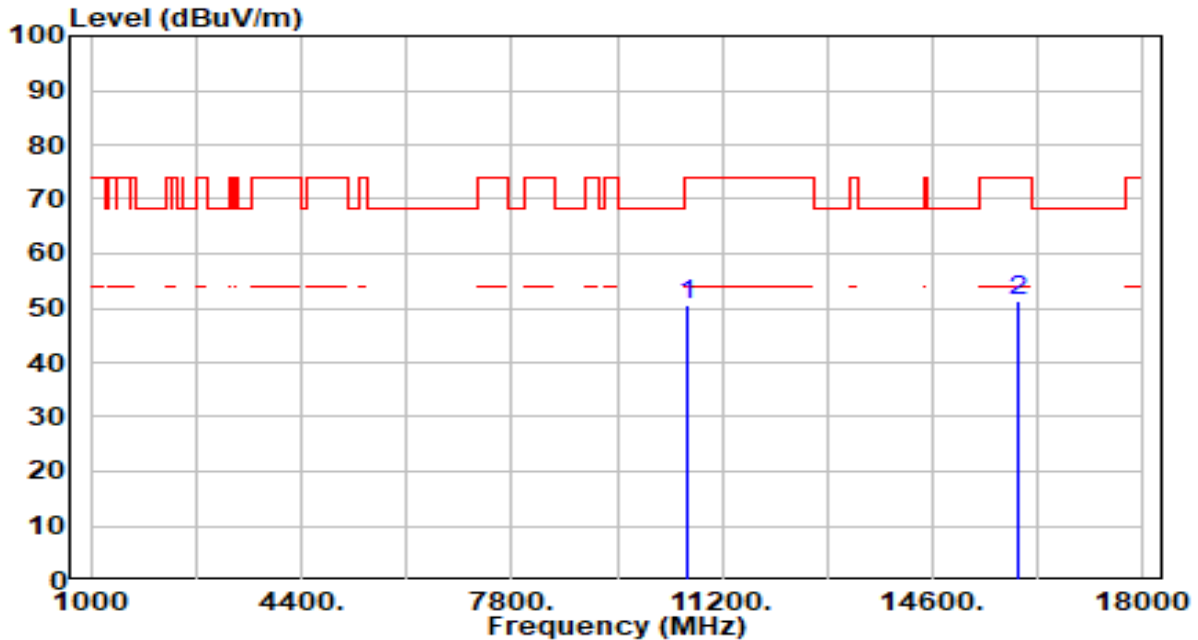

No	Frequency (MHz)	Reading (dBuV)	C.F (dB/m)	Measurement (dBuV/m)	Margin (dB)	Limit (dBuV/m)	Height (cm)	Angle (deg)	Remark (QP/PK/AV)
1	10640.000	45.93	4.62	50.55	-23.45	74.00	100	215	Peak
2	* 15960.000	44.84	6.55	51.39	-22.61	74.00	100	80	Peak

Note:

1. " *", means this data is the worst emission level.
2. C.F (Correction Factor) = Antenna Factor (dB/m)+ Cable Loss (dB) – Preamplifier(dB).
3. Measurement (dBuV/m) = Reading(dBuV) + C.F (Correction Factor).
4. The emission levels of other frequencies are very lower than the limit and not show in test report.

EUT	BE3600 Dual-Band Wi-Fi 7 Router	Date of Test	2024-02-06
Factor	DRH18-E	Temp. / Humidity	20°C /65%
Polarity	Vertical	Site / Test Engineer	AC2 / Stanley
Test Mode	802.11a_TX_Band2_CH 64_ANT 0+1	Test Voltage	AC 120V/60Hz

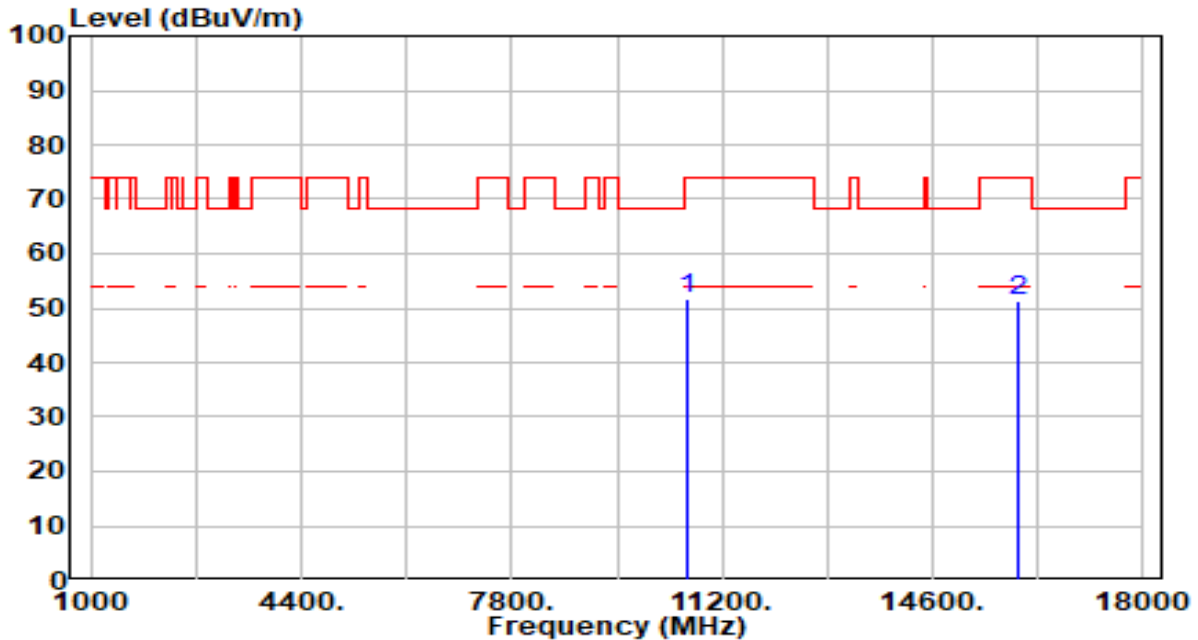

No	Frequency (MHz)	Reading (dBuV)	C.F (dB/m)	Measurement (dBuV/m)	Margin (dB)	Limit (dBuV/m)	Height (cm)	Angle (deg)	Remark (QP/PK/AV)
1	* 10640.000	46.93	4.62	51.55	-22.45	74.00	100	245	Peak
2	15960.000	44.75	6.55	51.30	-22.70	74.00	100	351	Peak

Note:

1. " *", means this data is the worst emission level.
2. C.F (Correction Factor) = Antenna Factor (dB/m)+ Cable Loss (dB) – Preamplifier(dB).
3. Measurement (dBuV/m) = Reading(dBuV) + C.F (Correction Factor).
4. The emission levels of other frequencies are very lower than the limit and not show in test report.

EUT	BE3600 Dual-Band Wi-Fi 7 Router	Date of Test	2024-02-06
Factor	DRH18-E	Temp. / Humidity	20°C /65%
Polarity	Horizontal	Site / Test Engineer	AC2 / Stanley
Test Mode	802.11a_TX_Band3_CH 100_ANT 0+1	Test Voltage	AC 120V/60Hz

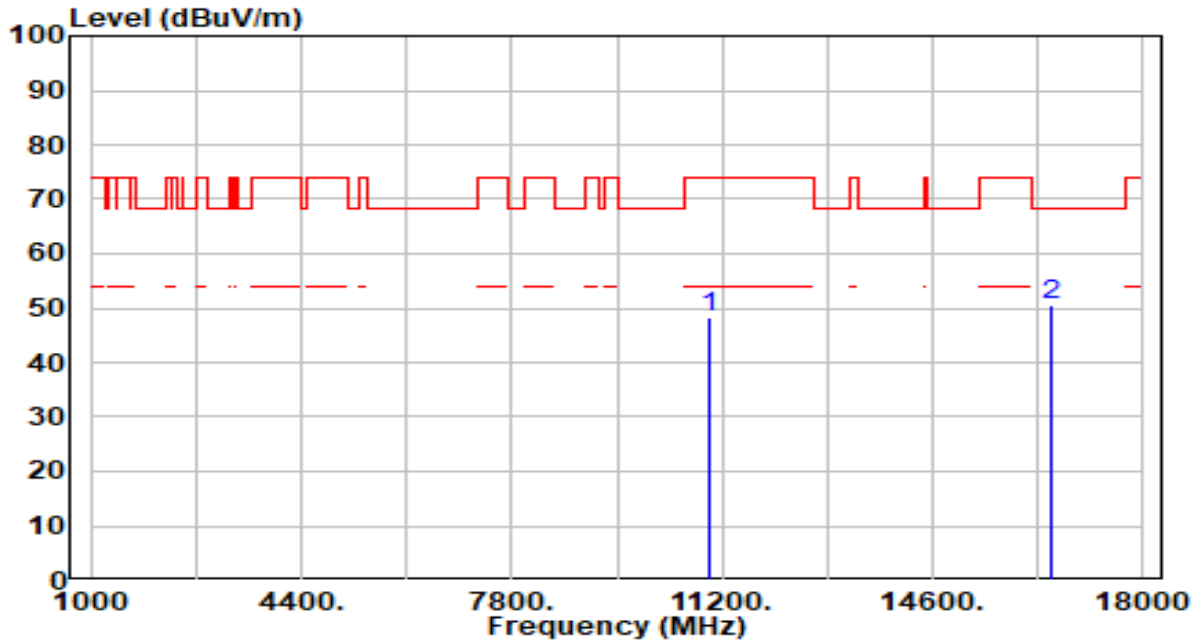

No	Frequency (MHz)	Reading (dBUV)	C.F (dB/m)	Measurement (dBUV/m)	Margin (dB)	Limit (dBUV/m)	Height (cm)	Angle (deg)	Remark (QP/PK/AV)
1	11000.000	43.76	4.52	48.28	-25.72	74.00	100	173	Peak
2	* 16500.000	44.33	6.10	50.43	-17.77	68.20	100	357	Peak

Note:

1. " *", means this data is the worst emission level.
2. C.F (Correction Factor) = Antenna Factor (dB/m)+ Cable Loss (dB) – Preamplifier(dB).
3. Measurement (dBUV/m) = Reading(dBUV) + C.F (Correction Factor).
4. The emission levels of other frequencies are very lower than the limit and not show in test report.

EUT	BE3600 Dual-Band Wi-Fi 7 Router	Date of Test	2024-02-06
Factor	DRH18-E	Temp. / Humidity	20°C /65%
Polarity	Vertical	Site / Test Engineer	AC2 / Stanley
Test Mode	802.11a_TX_Band3_CH 100_ANT 0+1	Test Voltage	AC 120V/60Hz

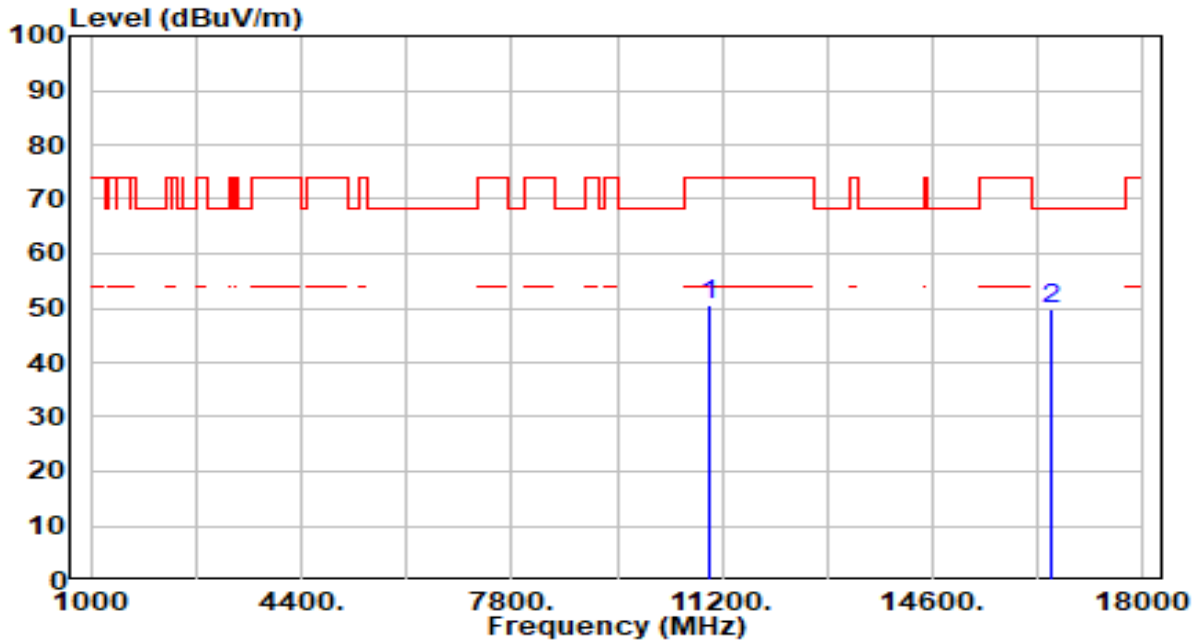

No	Frequency (MHz)	Reading (dBUV)	C.F (dB/m)	Measurement (dBUV/m)	Margin (dB)	Limit (dBUV/m)	Height (cm)	Angle (deg)	Remark (QP/PK/AV)
1	11000.000	46.09	4.52	50.61	-23.39	74.00	100	193	Peak
2	* 16500.000	43.68	6.10	49.78	-18.42	68.20	100	66	Peak

Note:

1. " *", means this data is the worst emission level.
2. C.F (Correction Factor) = Antenna Factor (dB/m)+ Cable Loss (dB) – Preamplifier(dB).
3. Measurement (dBUV/m) = Reading(dBUV) + C.F (Correction Factor).
4. The emission levels of other frequencies are very lower than the limit and not show in test report.

EUT	BE3600 Dual-Band Wi-Fi 7 Router	Date of Test	2024-02-06
Factor	DRH18-E	Temp. / Humidity	20°C /65%
Polarity	Horizontal	Site / Test Engineer	AC2 / Stanley
Test Mode	802.11a_TX_Band3_CH 116_ANT 0+1	Test Voltage	AC 120V/60Hz

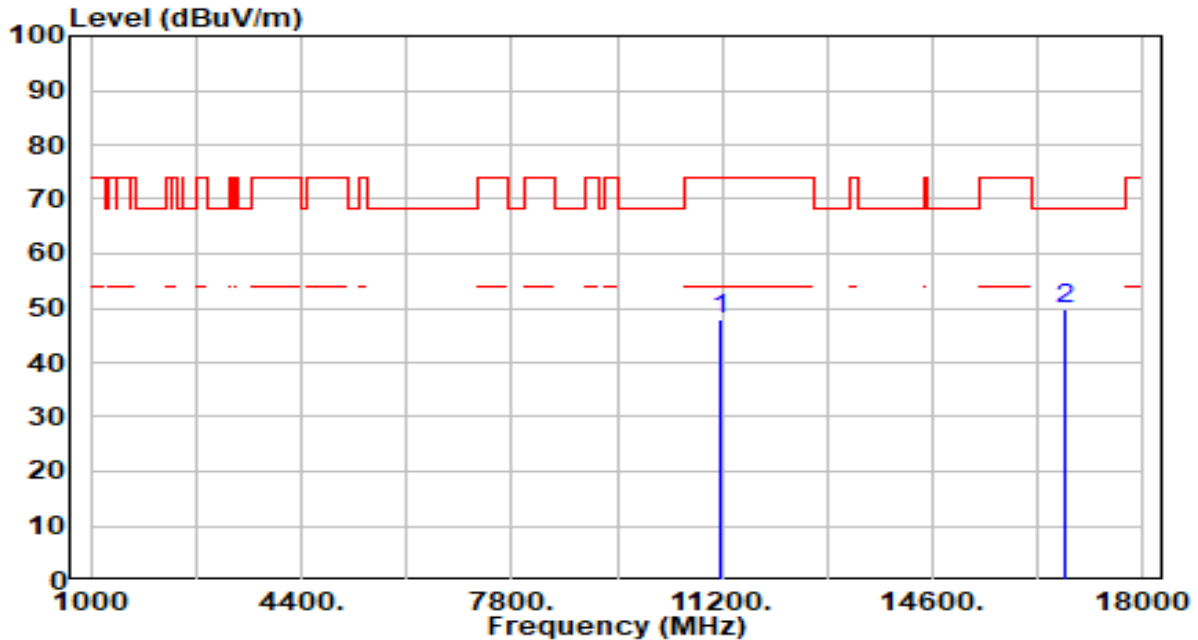

No	Frequency (MHz)	Reading (dBuV)	C.F (dB/m)	Measurement (dBuV/m)	Margin (dB)	Limit (dBuV/m)	Height (cm)	Angle (deg)	Remark (QP/PK/AV)
1	11160.000	43.05	4.94	47.99	-26.01	74.00	100	218	Peak
2	* 16740.000	43.76	6.19	49.95	-18.25	68.20	100	241	Peak

Note:

1. " *", means this data is the worst emission level.
2. C.F (Correction Factor) = Antenna Factor (dB/m)+ Cable Loss (dB) – Preamplifier(dB).
3. Measurement (dBuV/m) = Reading(dBuV) + C.F (Correction Factor).
4. The emission levels of other frequencies are very lower than the limit and not show in test report.

EUT	BE3600 Dual-Band Wi-Fi 7 Router	Date of Test	2024-02-06
Factor	DRH18-E	Temp. / Humidity	20°C /65%
Polarity	Vertical	Site / Test Engineer	AC2 / Stanley
Test Mode	802.11a_TX_Band3_CH 116_ANT 0+1	Test Voltage	AC 120V/60Hz

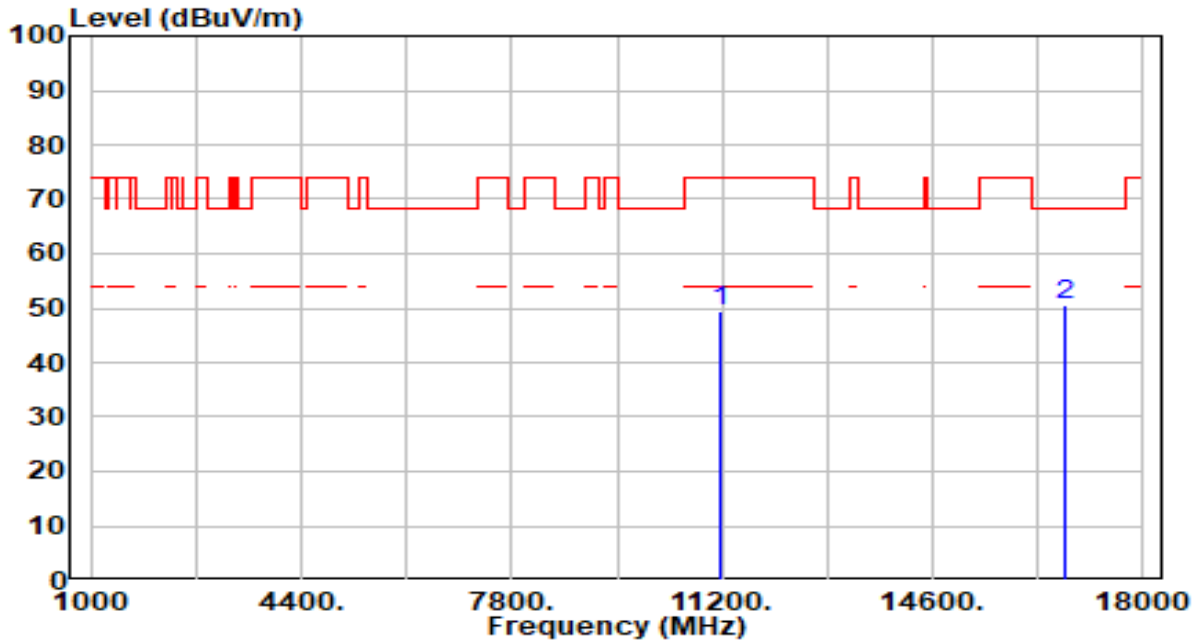

No	Frequency (MHz)	Reading (dBuV)	C.F (dB/m)	Measurement (dBuV/m)	Margin (dB)	Limit (dBuV/m)	Height (cm)	Angle (deg)	Remark (QP/PK/AV)
1	11160.000	44.48	4.94	49.41	-24.59	74.00	100	274	Peak
2	* 16740.000	44.43	6.19	50.62	-17.58	68.20	100	251	Peak

Note:

1. " *", means this data is the worst emission level.
2. C.F (Correction Factor) = Antenna Factor (dB/m)+ Cable Loss (dB) – Preamplifier(dB).
3. Measurement (dBuV/m) = Reading(dBuV) + C.F (Correction Factor).
4. The emission levels of other frequencies are very lower than the limit and not show in test report.

EUT	BE3600 Dual-Band Wi-Fi 7 Router	Date of Test	2024-02-06
Factor	DRH18-E	Temp. / Humidity	20°C /65%
Polarity	Horizontal	Site / Test Engineer	AC2 / Stanley
Test Mode	802.11a_TX_Band3_CH 140_ANT 0+1	Test Voltage	AC 120V/60Hz

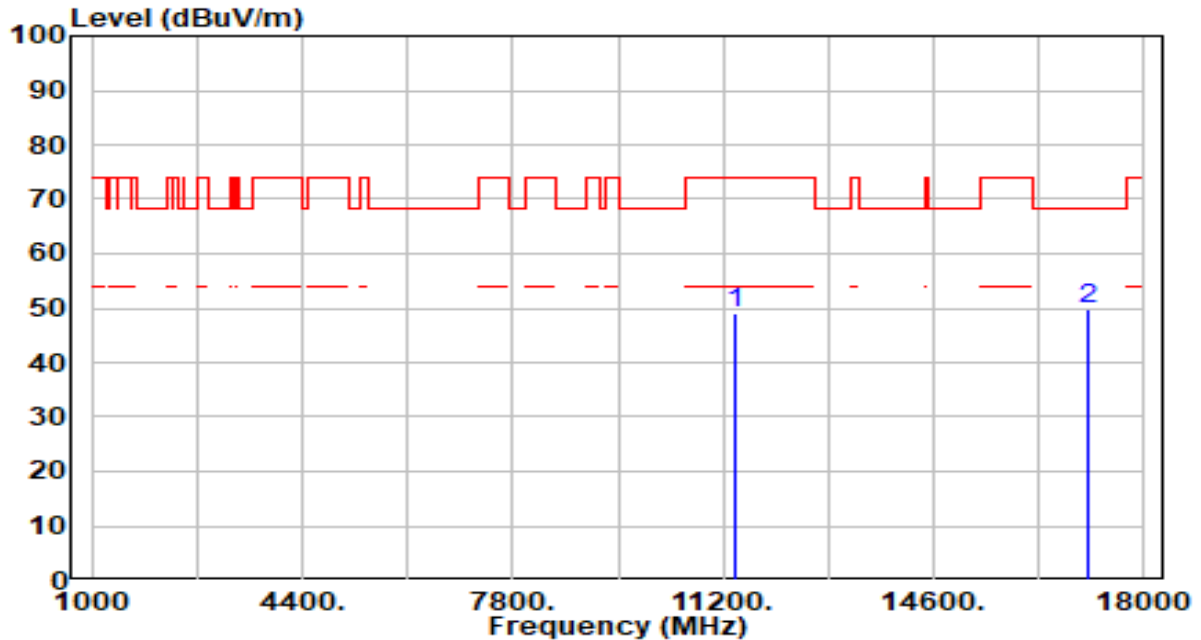

No	Frequency (MHz)	Reading (dBuV)	C.F (dB/m)	Measurement (dBuV/m)	Margin (dB)	Limit (dBuV/m)	Height (cm)	Angle (deg)	Remark (QP/PK/AV)
1	11400.000	43.62	5.26	48.89	-25.11	74.00	100	0	Peak
2	* 17100.000	43.90	5.97	49.87	-18.33	68.20	100	0	Peak

Note:

1. " *", means this data is the worst emission level.
2. C.F (Correction Factor) = Antenna Factor (dB/m)+ Cable Loss (dB) – Preamplifier(dB).
3. Measurement (dBuV/m) = Reading(dBuV) + C.F (Correction Factor).
4. The emission levels of other frequencies are very lower than the limit and not show in test report.

EUT	BE3600 Dual-Band Wi-Fi 7 Router	Date of Test	2024-02-06
Factor	DRH18-E	Temp. / Humidity	20°C /65%
Polarity	Vertical	Site / Test Engineer	AC2 / Stanley
Test Mode	802.11a_TX_Band3_CH 140_ANT 0+1	Test Voltage	AC 120V/60Hz

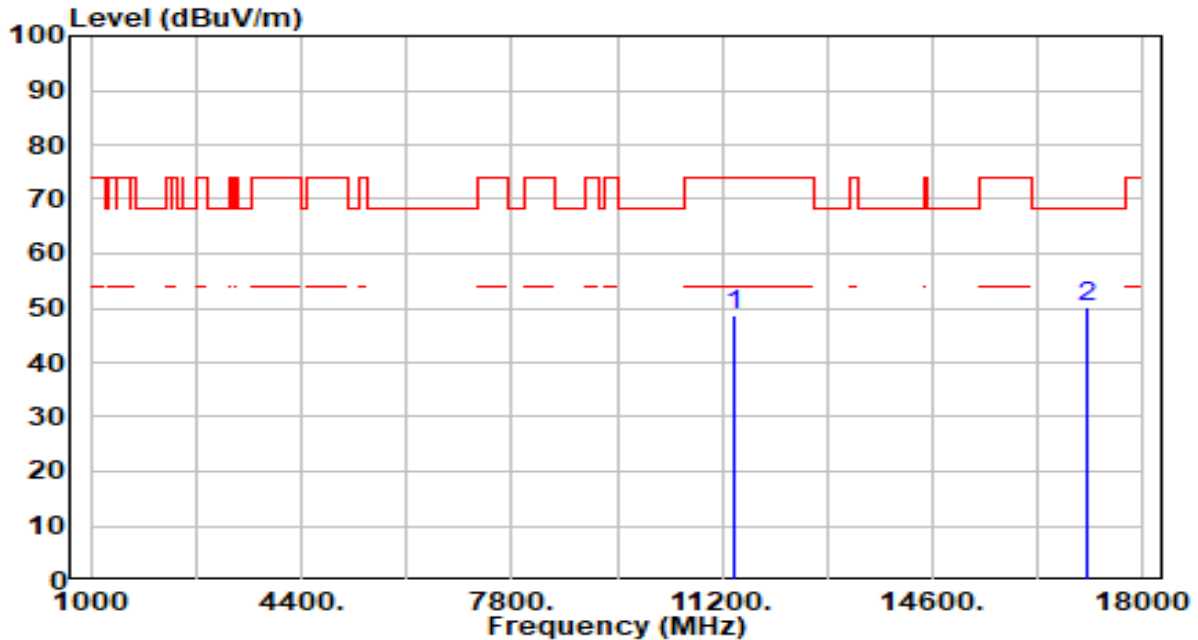

No	Frequency (MHz)	Reading (dBuV)	C.F (dB/m)	Measurement (dBuV/m)	Margin (dB)	Limit (dBuV/m)	Height (cm)	Angle (deg)	Remark (QP/PK/AV)
1	11400.000	43.57	5.26	48.83	-25.17	74.00	100	256	Peak
2	* 17100.000	44.06	5.97	50.03	-18.17	68.20	100	57	Peak

Note:

1. " *", means this data is the worst emission level.
2. C.F (Correction Factor) = Antenna Factor (dB/m)+ Cable Loss (dB) – Preamplifier(dB).
3. Measurement (dBuV/m) = Reading(dBuV) + C.F (Correction Factor).
4. The emission levels of other frequencies are very lower than the limit and not show in test report.

EUT	BE3600 Dual-Band Wi-Fi 7 Router	Date of Test	2024-02-06
Factor	DRH18-E	Temp. / Humidity	20°C /65%
Polarity	Horizontal	Site / Test Engineer	AC2 / Stanley
Test Mode	802.11a_TX_Band3_CH 144_ANT 0+1	Test Voltage	AC 120V/60Hz

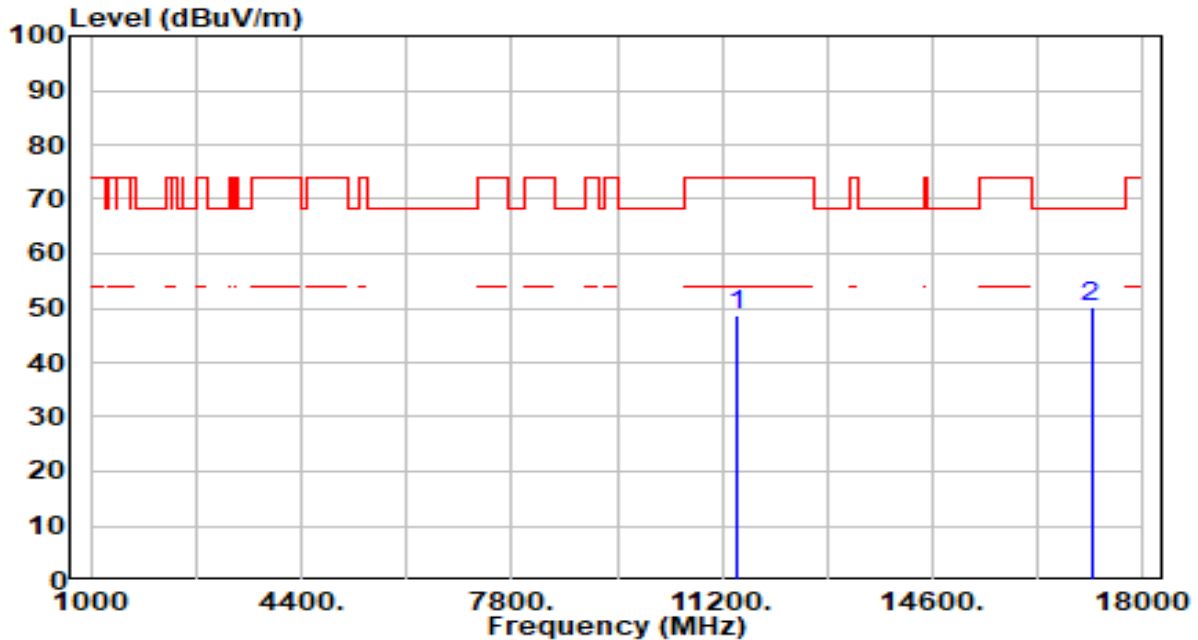

No	Frequency (MHz)	Reading (dBUV)	C.F (dB/m)	Measurement (dBUV/m)	Margin (dB)	Limit (dBUV/m)	Height (cm)	Angle (deg)	Remark (QP/PK/AV)
1	11440.000	43.30	5.29	48.59	-25.41	74.00	100	184	Peak
2	* 17160.000	44.30	5.87	50.17	-18.03	68.20	100	0	Peak

Note:

1. " *", means this data is the worst emission level.
2. C.F (Correction Factor) = Antenna Factor (dB/m)+ Cable Loss (dB) – Preamplifier(dB).
3. Measurement (dBUV/m) = Reading(dBUV) + C.F (Correction Factor).
4. The emission levels of other frequencies are very lower than the limit and not show in test report.

EUT	BE3600 Dual-Band Wi-Fi 7 Router	Date of Test	2024-02-06
Factor	DRH18-E	Temp. / Humidity	20°C /65%
Polarity	Vertical	Site / Test Engineer	AC2 / Stanley
Test Mode	802.11a_TX_Band3_CH 144_ANT 0+1	Test Voltage	AC 120V/60Hz

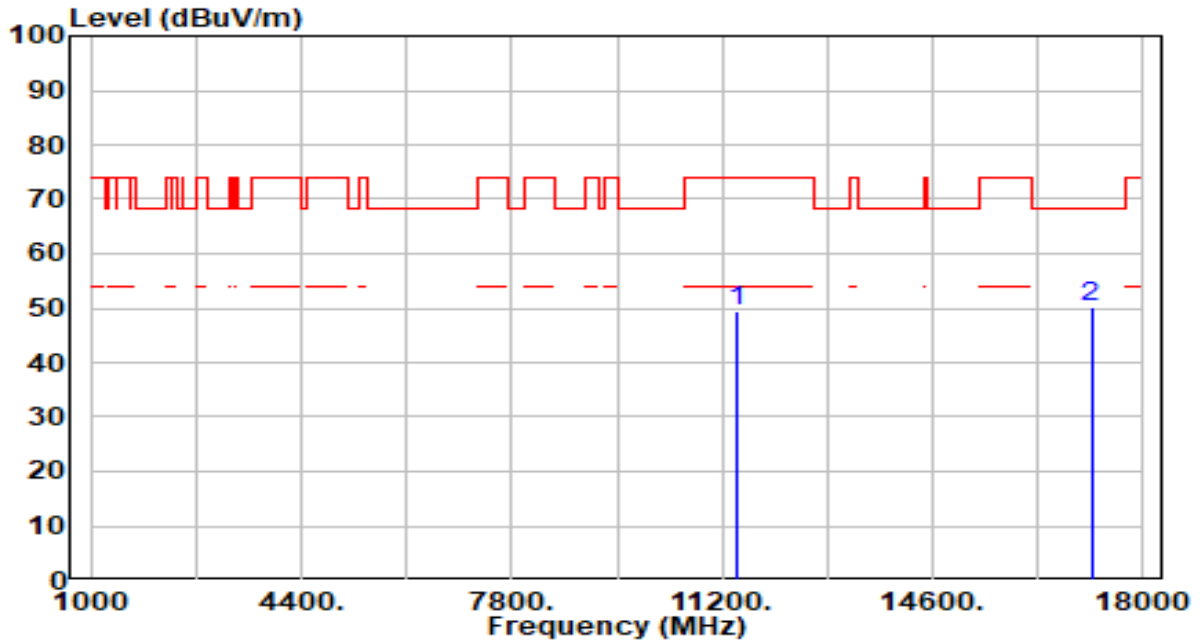

No	Frequency (MHz)	Reading (dBuV)	C.F (dB/m)	Measurement (dBuV/m)	Margin (dB)	Limit (dBuV/m)	Height (cm)	Angle (deg)	Remark (QP/PK/AV)
1	11440.000	44.17	5.29	49.46	-24.54	74.00	100	236	Peak
2	* 17160.000	44.46	5.87	50.34	-17.86	68.20	100	331	Peak

Note:

1. " *", means this data is the worst emission level.
2. C.F (Correction Factor) = Antenna Factor (dB/m)+ Cable Loss (dB) – Preamplifier(dB).
3. Measurement (dBuV/m) = Reading(dBuV) + C.F (Correction Factor).
4. The emission levels of other frequencies are very lower than the limit and not show in test report.

EUT	BE3600 Dual-Band Wi-Fi 7 Router	Date of Test	2024-02-06
Factor	DRH18-E	Temp. / Humidity	20°C /65%
Polarity	Horizontal	Site / Test Engineer	AC2 / Stanley
Test Mode	802.11a_TX_Band4_CH 149_ANT 0+1	Test Voltage	AC 120V/60Hz

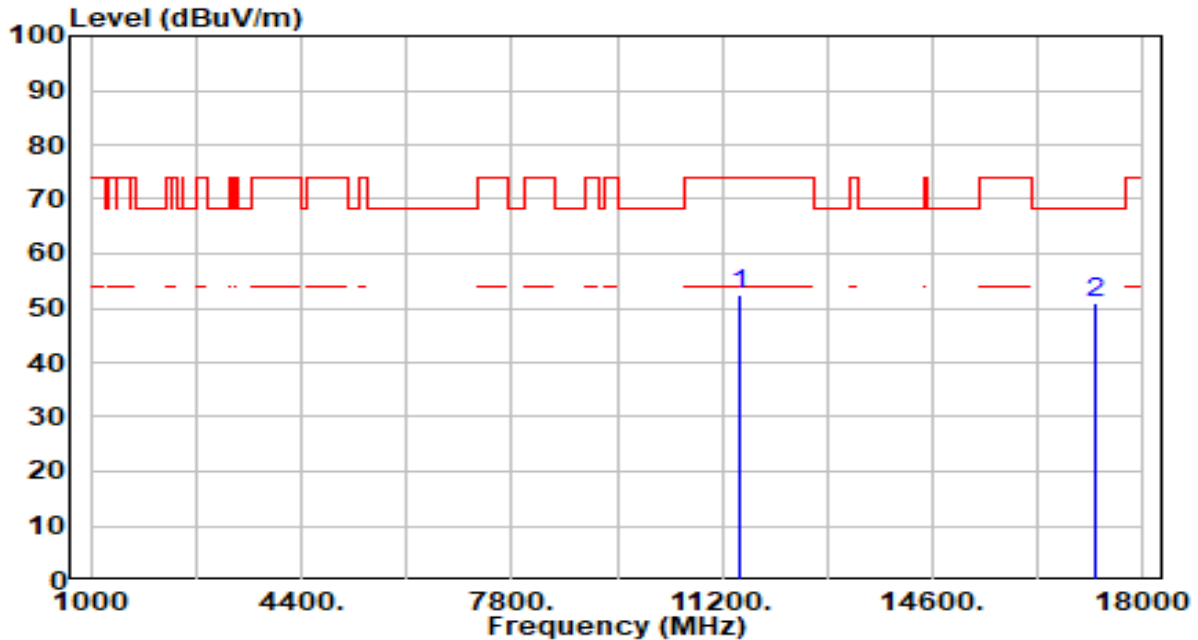

No	Frequency (MHz)	Reading (dBuV)	C.F (dB/m)	Measurement (dBuV/m)	Margin (dB)	Limit (dBuV/m)	Height (cm)	Angle (deg)	Remark (QP/PK/AV)
1	11490.000	47.00	5.32	52.32	-21.68	74.00	100	172	Peak
2	* 17235.000	45.21	5.71	50.92	-17.28	68.20	100	40	Peak

Note:

1. " *", means this data is the worst emission level.
2. C.F (Correction Factor) = Antenna Factor (dB/m)+ Cable Loss (dB) – Preamplifier(dB).
3. Measurement (dBuV/m) = Reading(dBuV) + C.F (Correction Factor).
4. The emission levels of other frequencies are very lower than the limit and not show in test report.

EUT	BE3600 Dual-Band Wi-Fi 7 Router	Date of Test	2024-02-06
Factor	DRH18-E	Temp. / Humidity	20°C /65%
Polarity	Vertical	Site / Test Engineer	AC2 / Stanley
Test Mode	802.11a_TX_Band4_CH 149_ANT 0+1	Test Voltage	AC 120V/60Hz

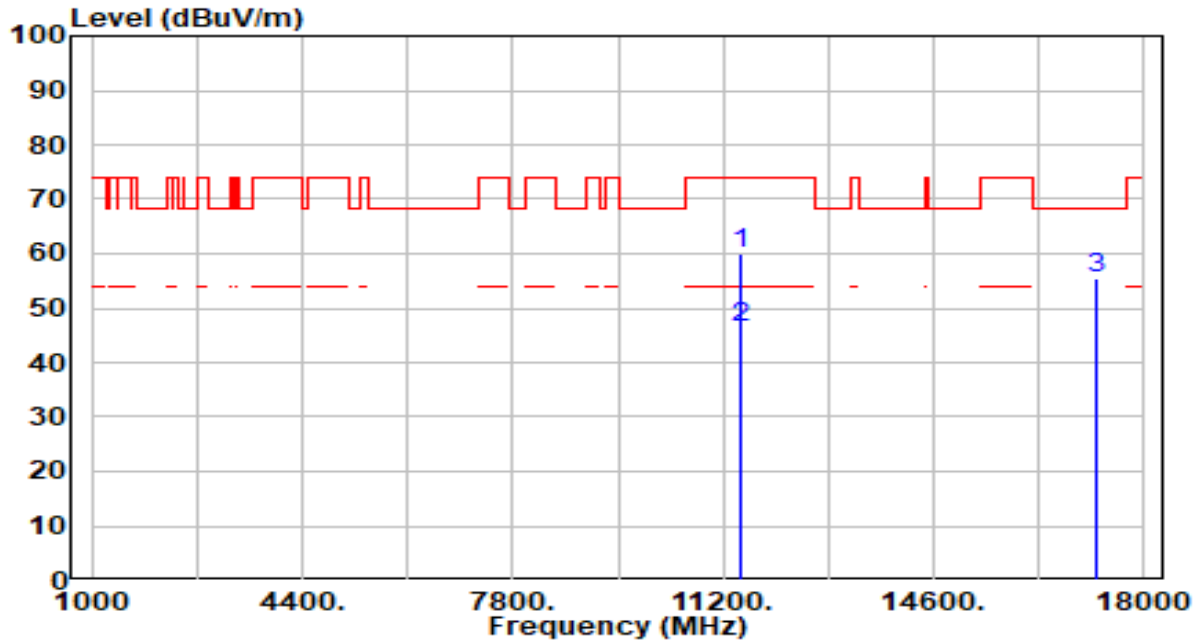

No	Frequency (MHz)	Reading (dBuV)	C.F (dB/m)	Measurement (dBuV/m)	Margin (dB)	Limit (dBuV/m)	Height (cm)	Angle (deg)	Remark (QP/PK/AV)
1	11490.000	54.74	5.32	60.06	-13.94	74.00	100	256	Peak
2	* 11490.000	41.06	5.32	46.38	-7.62	54.00	100	256	Average
3	* 17235.000	49.62	5.71	55.33	-12.87	68.20	100	254	Peak

Note:

1. " *", means this data is the worst emission level.
2. C.F (Correction Factor) = Antenna Factor (dB/m)+ Cable Loss (dB) – Pre-amplifier(dB).
3. Measurement (dBuV/m) = Reading(dBuV) + C.F (Correction Factor).
4. The emission levels of other frequencies are very lower than the limit and not show in test report.

EUT	BE3600 Dual-Band Wi-Fi 7 Router	Date of Test	2024-02-06
Factor	DRH18-E	Temp. / Humidity	20°C /65%
Polarity	Horizontal	Site / Test Engineer	AC2 / Stanley
Test Mode	802.11a_TX_Band4_CH 157_ANT 0+1	Test Voltage	AC 120V/60Hz

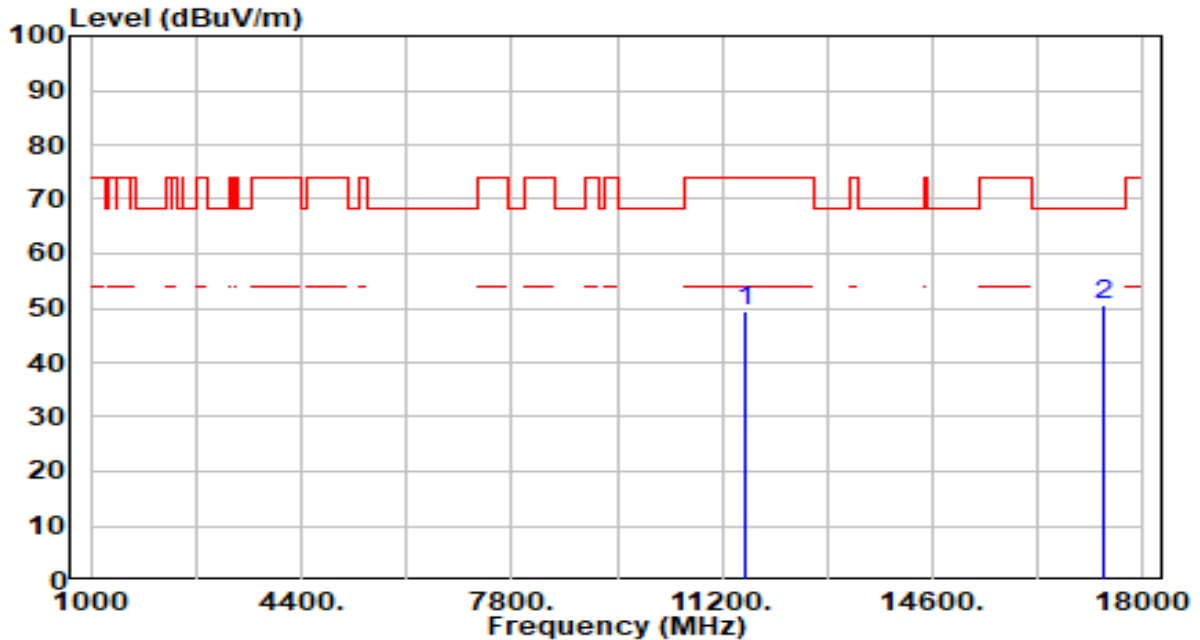

No	Frequency (MHz)	Reading (dBuV)	C.F (dB/m)	Measurement (dBuV/m)	Margin (dB)	Limit (dBuV/m)	Height (cm)	Angle (deg)	Remark (QP/PK/AV)
1	11570.000	44.21	5.38	49.59	-24.41	74.00	100	360	Peak
2	* 17355.000	45.12	5.39	50.51	-17.69	68.20	100	35	Peak

Note:

1. " *", means this data is the worst emission level.
2. C.F (Correction Factor) = Antenna Factor (dB/m)+ Cable Loss (dB) – Preamplifier(dB).
3. Measurement (dBuV/m) = Reading(dBuV) + C.F (Correction Factor).
4. The emission levels of other frequencies are very lower than the limit and not show in test report.

EUT	BE3600 Dual-Band Wi-Fi 7 Router	Date of Test	2024-02-06
Factor	DRH18-E	Temp. / Humidity	20°C /65%
Polarity	Vertical	Site / Test Engineer	AC2 / Stanley
Test Mode	802.11a_TX_Band4_CH 157_ANT 0+1	Test Voltage	AC 120V/60Hz

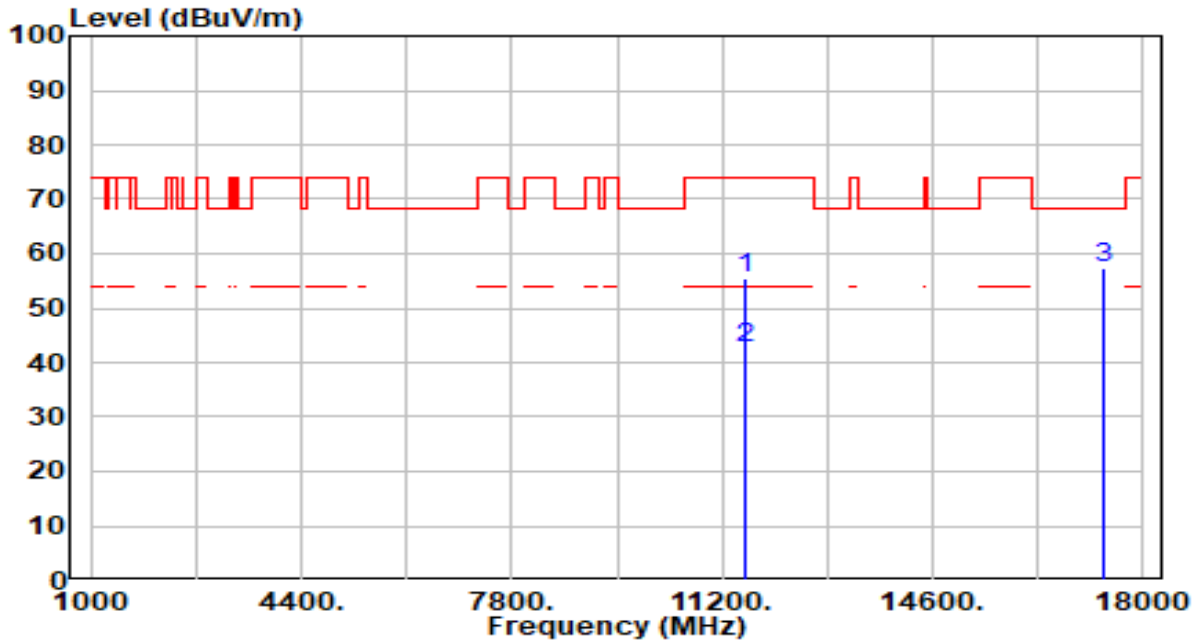

No	Frequency (MHz)	Reading (dBuV)	C.F (dB/m)	Measurement (dBuV/m)	Margin (dB)	Limit (dBuV/m)	Height (cm)	Angle (deg)	Remark (QP/PK/AV)
1	11570.000	50.16	5.38	55.54	-18.46	74.00	100	256	Peak
2	* 11570.000	37.40	5.38	42.78	-11.22	54.00	100	256	Average
3	* 17355.000	51.93	5.39	57.32	-10.88	68.20	100	259	Peak

Note:

1. " *", means this data is the worst emission level.
2. C.F (Correction Factor) = Antenna Factor (dB/m)+ Cable Loss (dB) – Pre-amplifier(dB).
3. Measurement (dBuV/m) = Reading(dBuV) + C.F (Correction Factor).
4. The emission levels of other frequencies are very lower than the limit and not show in test report.

EUT	BE3600 Dual-Band Wi-Fi 7 Router	Date of Test	2024-02-06
Factor	DRH18-E	Temp. / Humidity	20°C /65%
Polarity	Horizontal	Site / Test Engineer	AC2 / Stanley
Test Mode	802.11a_TX_Band4_CH 165_ANT 0+1	Test Voltage	AC 120V/60Hz

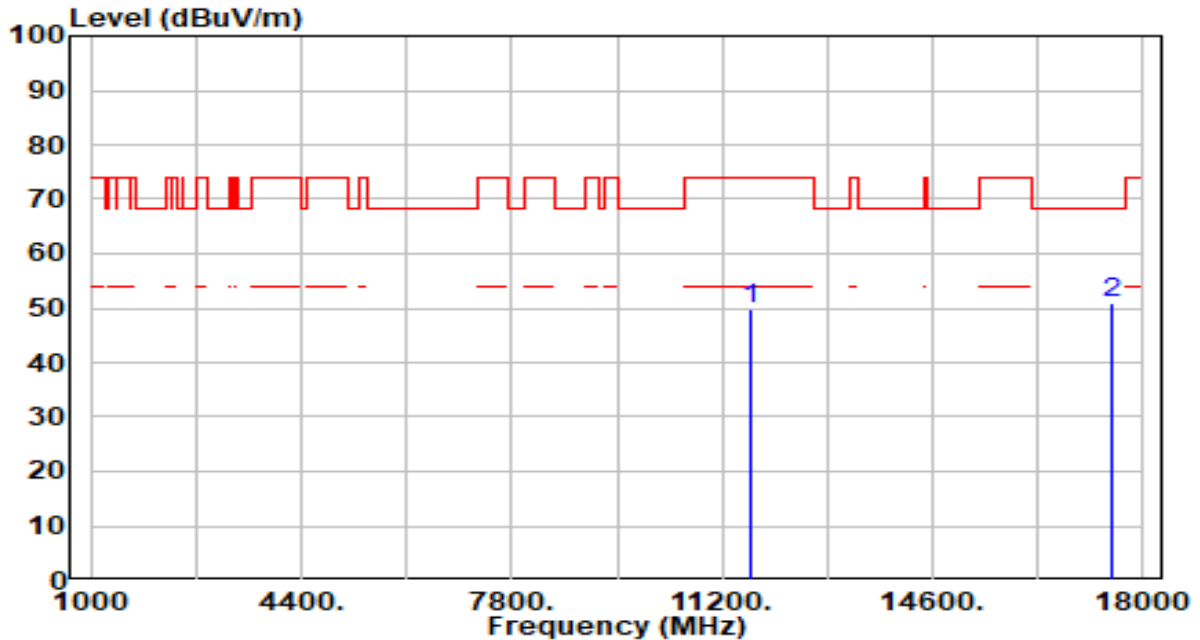

No	Frequency (MHz)	Reading (dBuV)	C.F (dB/m)	Measurement (dBuV/m)	Margin (dB)	Limit (dBuV/m)	Height (cm)	Angle (deg)	Remark (QP/PK/AV)
1	11650.000	44.35	5.36	49.71	-24.29	74.00	100	170	Peak
2	* 17475.000	45.70	5.29	50.99	-17.21	68.20	100	107	Peak

Note:

1. " *", means this data is the worst emission level.
2. C.F (Correction Factor) = Antenna Factor (dB/m)+ Cable Loss (dB) – Preamplifier(dB).
3. Measurement (dBuV/m) = Reading(dBuV) + C.F (Correction Factor).
4. The emission levels of other frequencies are very lower than the limit and not show in test report.

EUT	BE3600 Dual-Band Wi-Fi 7 Router	Date of Test	2024-02-06
Factor	DRH18-E	Temp. / Humidity	20°C /65%
Polarity	Vertical	Site / Test Engineer	AC2 / Stanley
Test Mode	802.11a_TX_Band4_CH 165_ANT 0+1	Test Voltage	AC 120V/60Hz

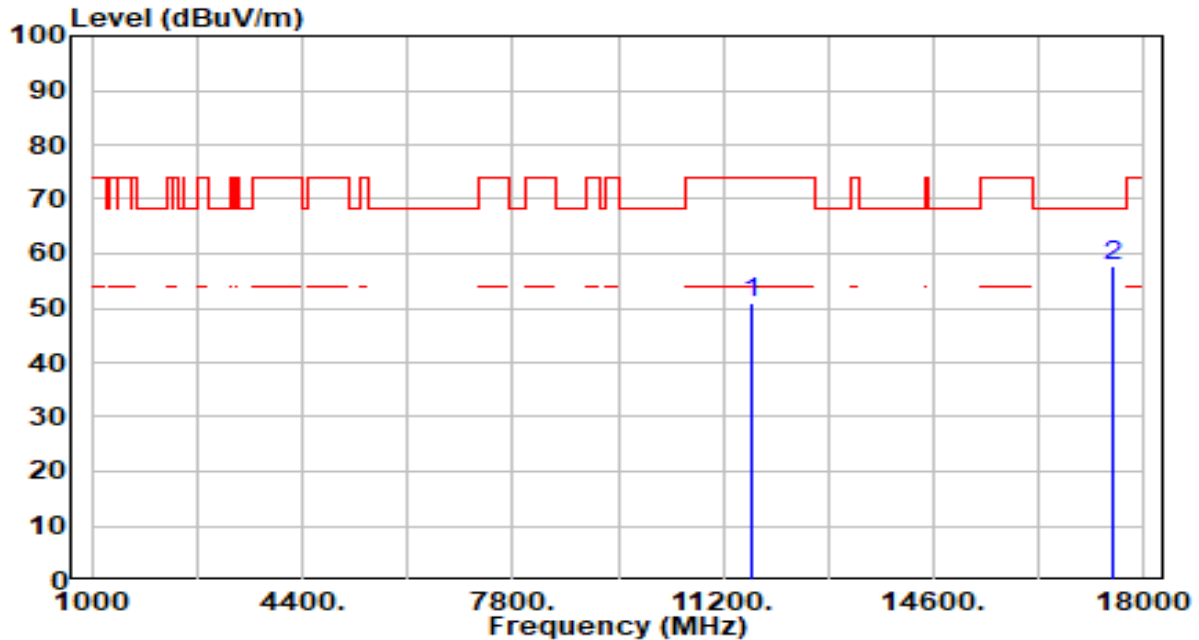

No	Frequency (MHz)	Reading (dBuV)	C.F (dB/m)	Measurement (dBuV/m)	Margin (dB)	Limit (dBuV/m)	Height (cm)	Angle (deg)	Remark (QP/PK/AV)
1	11650.000	45.67	5.36	51.04	-22.96	74.00	100	251	Peak
2	* 17475.000	52.59	5.29	57.88	-10.32	68.20	100	254	Peak

Note:

1. " *", means this data is the worst emission level.
2. C.F (Correction Factor) = Antenna Factor (dB/m)+ Cable Loss (dB) – Preamplifier(dB).
3. Measurement (dBuV/m) = Reading(dBuV) + C.F (Correction Factor).
4. The emission levels of other frequencies are very lower than the limit and not show in test report.

EUT	BE3600 Dual-Band Wi-Fi 7 Router	Date of Test	2024-02-06
Factor	DRH18-E	Temp. / Humidity	20°C /65%
Polarity	Horizontal	Site / Test Engineer	AC2 / Marvin
Test Mode	802.11ac-20MHz_TX_Band1_CH 36_ANT 0+1	Test Voltage	AC 120V/60Hz

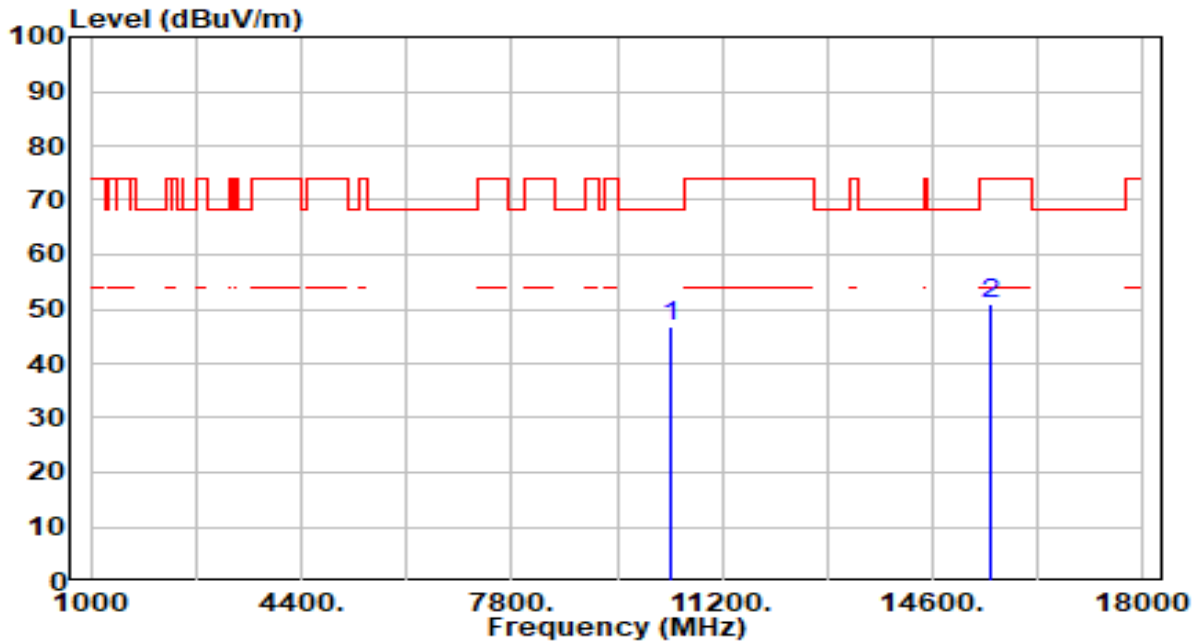

No	Frequency (MHz)	Reading (dBuV)	C.F (dB/m)	Measurement (dBuV/m)	Margin (dB)	Limit (dBuV/m)	Height (cm)	Angle (deg)	Remark (QP/PK/AV)
1	* 10360.000	42.04	4.87	46.91	-21.29	68.20	100	62	Peak
2	15540.000	44.84	6.21	51.04	-22.96	74.00	100	97	Peak

Note:

1. " *", means this data is the worst emission level.
2. C.F (Correction Factor) = Antenna Factor (dB/m)+ Cable Loss (dB) – Pre-amplifier(dB).
3. Measurement (dBuV/m) = Reading(dBuV) + C.F (Correction Factor).
4. The emission levels of other frequencies are very lower than the limit and not show in test report.

EUT	BE3600 Dual-Band Wi-Fi 7 Router	Date of Test	2024-02-06
Factor	DRH18-E	Temp. / Humidity	20°C /65%
Polarity	Vertical	Site / Test Engineer	AC2 / Marvin
Test Mode	802.11ac-20MHz_TX_Band1_CH 36_ANT 0+1	Test Voltage	AC 120V/60Hz

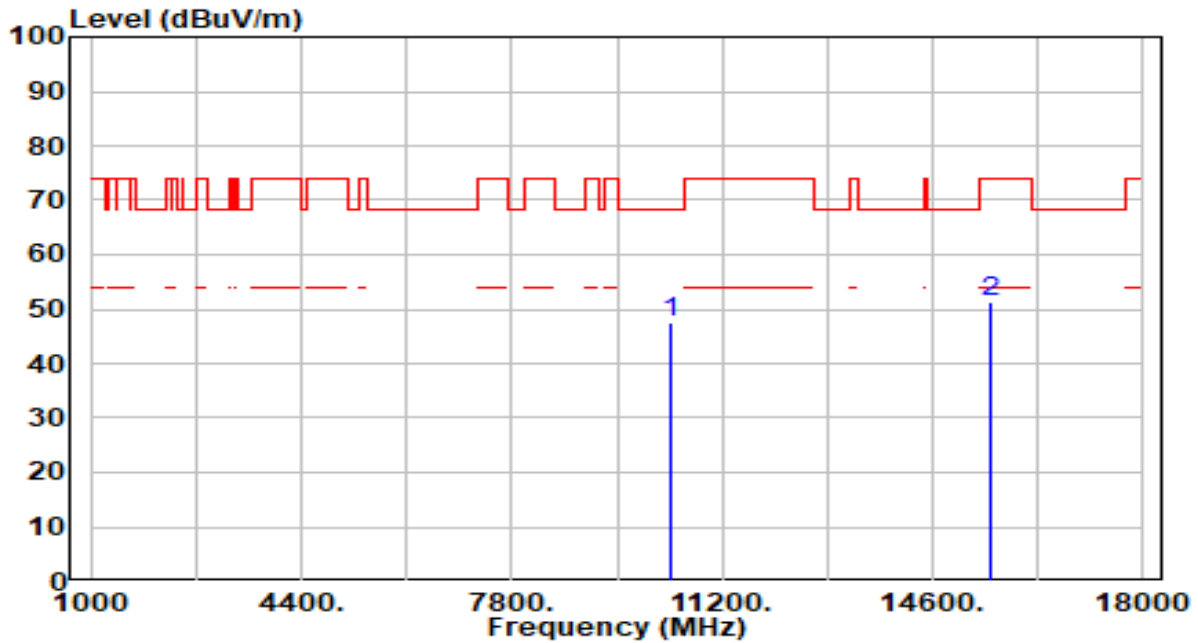

No	Frequency (MHz)	Reading (dBuV)	C.F (dB/m)	Measurement (dBuV/m)	Margin (dB)	Limit (dBuV/m)	Height (cm)	Angle (deg)	Remark (QP/PK/AV)
1	* 10360.000	42.72	4.87	47.59	-20.61	68.20	100	146	Peak
2	15540.000	44.96	6.21	51.17	-22.83	74.00	100	326	Peak

Note:

1. " *", means this data is the worst emission level.
2. C.F (Correction Factor) = Antenna Factor (dB/m)+ Cable Loss (dB) – Pre-amplifier(dB).
3. Measurement (dBuV/m) = Reading(dBuV) + C.F (Correction Factor).
4. The emission levels of other frequencies are very lower than the limit and not show in test report.

EUT	BE3600 Dual-Band Wi-Fi 7 Router	Date of Test	2024-02-06
Factor	DRH18-E	Temp. / Humidity	20°C /65%
Polarity	Horizontal	Site / Test Engineer	AC2 / Marvin
Test Mode	802.11ac-20MHz_TX_Band1_CH 44_ANT 0+1	Test Voltage	AC 120V/60Hz

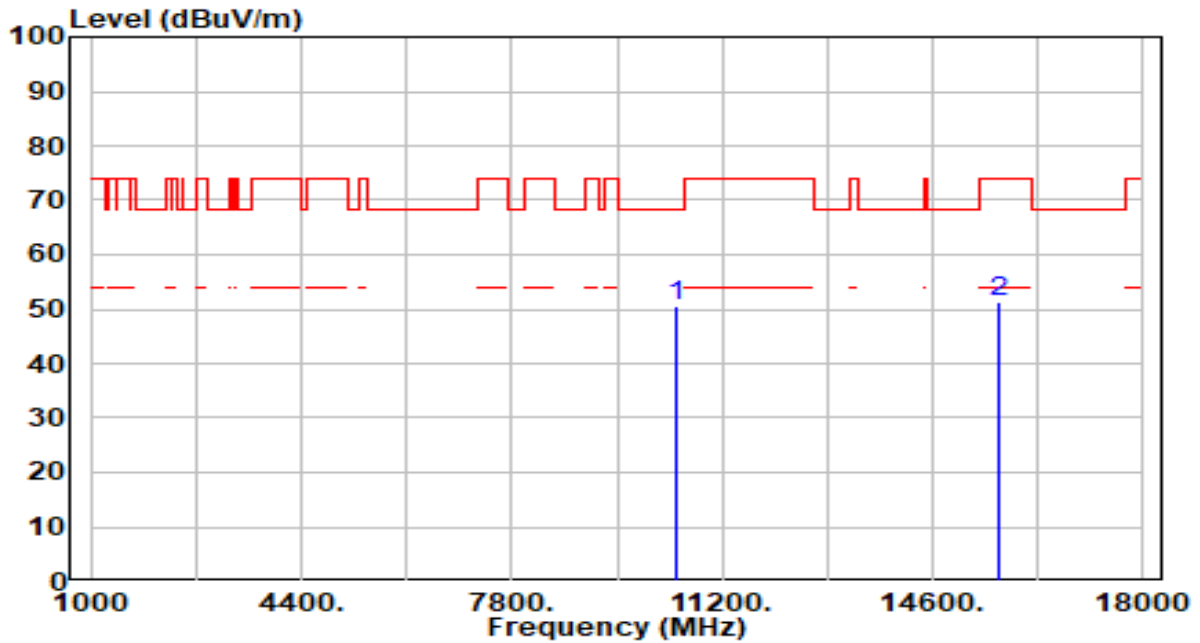

No	Frequency (MHz)	Reading (dBuV)	C.F (dB/m)	Measurement (dBuV/m)	Margin (dB)	Limit (dBuV/m)	Height (cm)	Angle (deg)	Remark (QP/PK/AV)
1	* 10440.000	45.71	4.76	50.48	-17.72	68.20	100	170	Peak
2	15660.000	44.98	6.27	51.25	-22.75	74.00	100	310	Peak

Note:

1. " *", means this data is the worst emission level.
2. C.F (Correction Factor) = Antenna Factor (dB/m)+ Cable Loss (dB) – Pre-amplifier(dB).
3. Measurement (dBuV/m) = Reading(dBuV) + C.F (Correction Factor).
4. The emission levels of other frequencies are very lower than the limit and not show in test report.

EUT	BE3600 Dual-Band Wi-Fi 7 Router	Date of Test	2024-02-06
Factor	DRH18-E	Temp. / Humidity	20°C /65%
Polarity	Vertical	Site / Test Engineer	AC2 / Marvin
Test Mode	802.11ac-20MHz_TX_Band1_CH 44_ANT 0+1	Test Voltage	AC 120V/60Hz

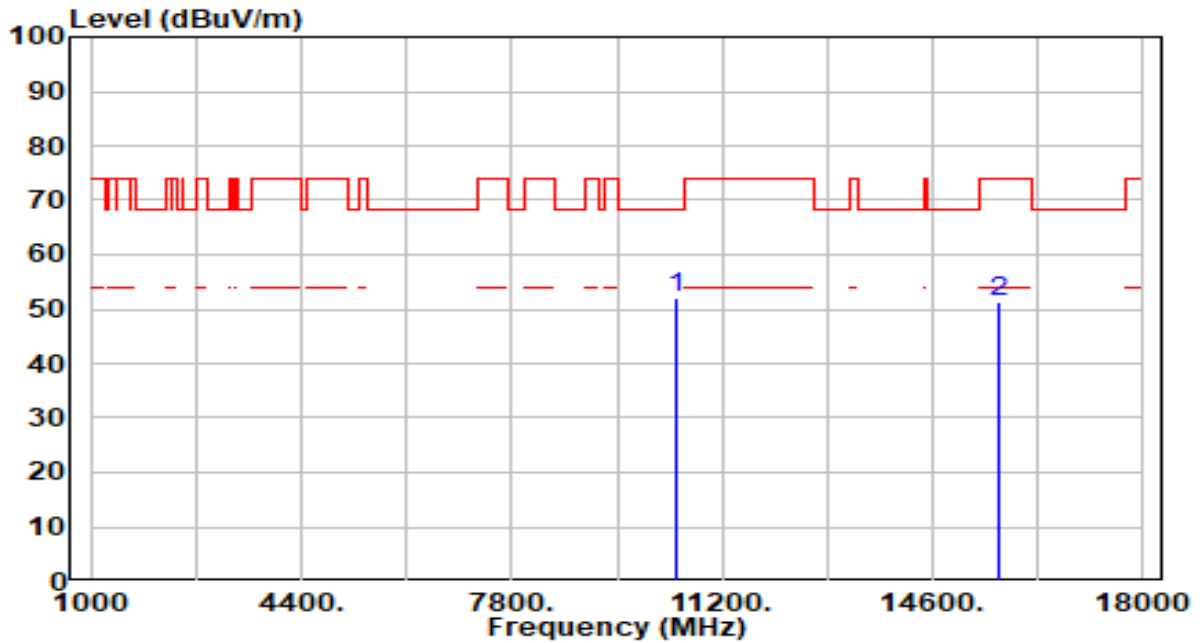

No	Frequency (MHz)	Reading (dBuV)	C.F (dB/m)	Measurement (dBuV/m)	Margin (dB)	Limit (dBuV/m)	Height (cm)	Angle (deg)	Remark (QP/PK/AV)
1	* 10440.000	47.46	4.76	52.22	-15.98	68.20	100	137	Peak
2	15660.000	45.03	6.27	51.29	-22.71	74.00	100	273	Peak

Note:

1. " *", means this data is the worst emission level.
2. C.F (Correction Factor) = Antenna Factor (dB/m)+ Cable Loss (dB) – Pre-amplifier(dB).
3. Measurement (dBuV/m) = Reading(dBuV) + C.F (Correction Factor).
4. The emission levels of other frequencies are very lower than the limit and not show in test report.

EUT	BE3600 Dual-Band Wi-Fi 7 Router	Date of Test	2024-02-06
Factor	DRH18-E	Temp. / Humidity	20°C /65%
Polarity	Horizontal	Site / Test Engineer	AC2 / Marvin
Test Mode	802.11ac-20MHz_TX_Band1_CH 48_ANT 0+1	Test Voltage	AC 120V/60Hz

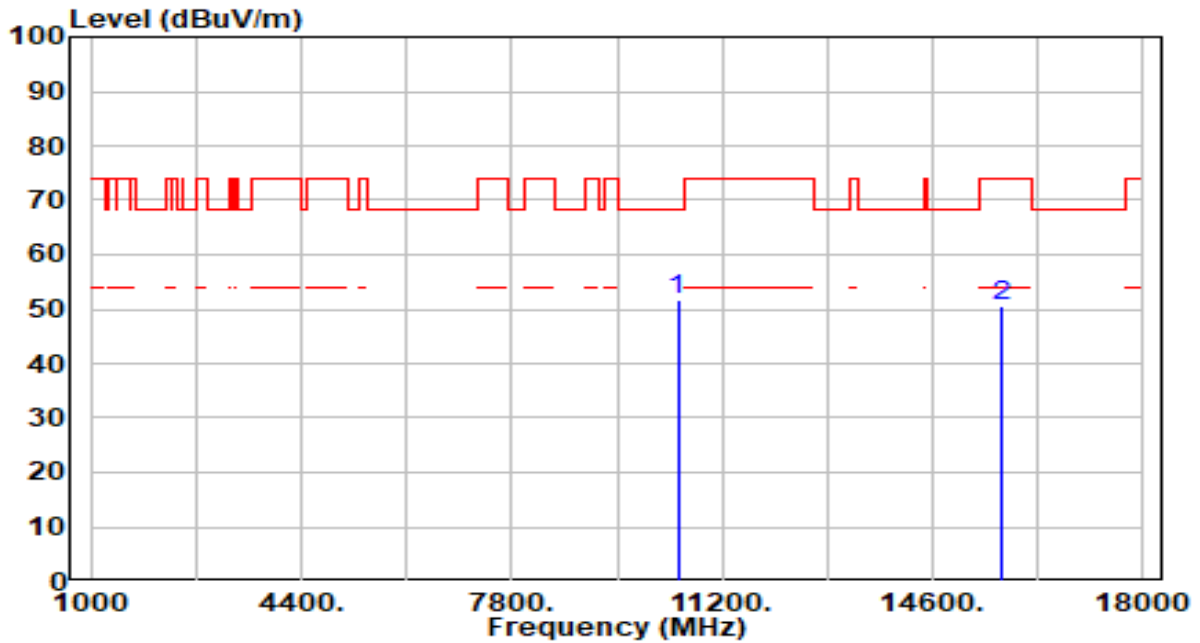

No	Frequency (MHz)	Reading (dBuV)	C.F (dB/m)	Measurement (dBuV/m)	Margin (dB)	Limit (dBuV/m)	Height (cm)	Angle (deg)	Remark (QP/PK/AV)
1	* 10480.000	47.16	4.71	51.87	-16.33	68.20	100	211	Peak
2	15720.000	44.02	6.39	50.41	-23.59	74.00	100	220	Peak

Note:

1. " *", means this data is the worst emission level.
2. C.F (Correction Factor) = Antenna Factor (dB/m)+ Cable Loss (dB) – Pre-amplifier(dB).
3. Measurement (dBuV/m) = Reading(dBuV) + C.F (Correction Factor).
4. The emission levels of other frequencies are very lower than the limit and not show in test report.

EUT	BE3600 Dual-Band Wi-Fi 7 Router	Date of Test	2024-02-06
Factor	DRH18-E	Temp. / Humidity	20°C /65%
Polarity	Vertical	Site / Test Engineer	AC2 / Marvin
Test Mode	802.11ac-20MHz_TX_Band1_CH 48_ANT 0+1	Test Voltage	AC 120V/60Hz

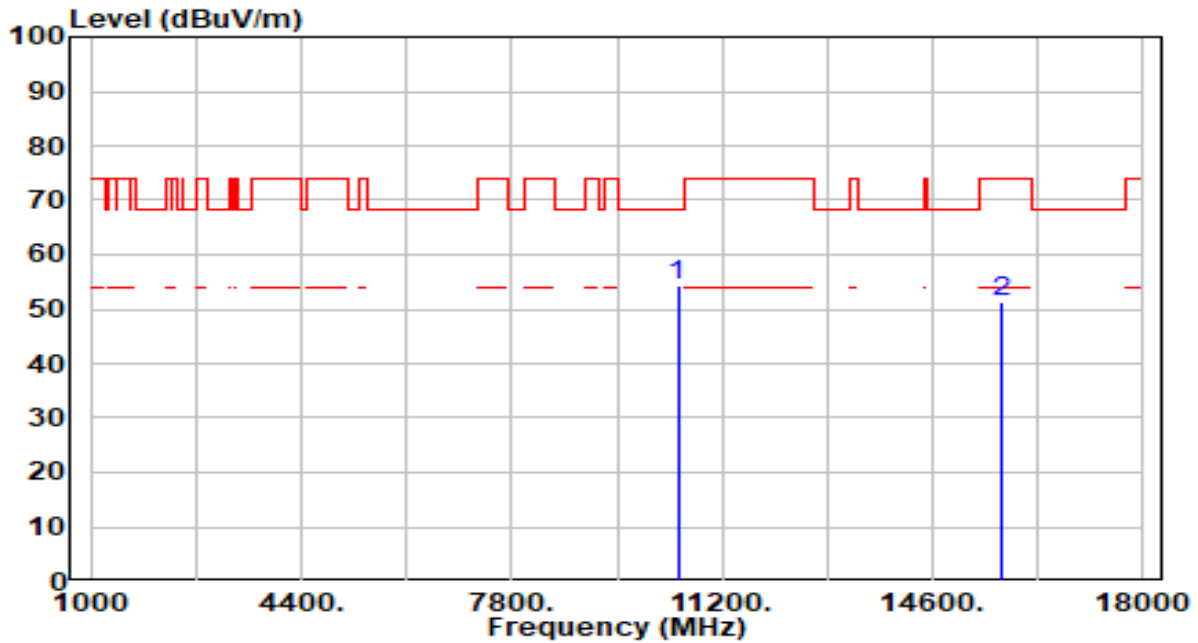

No	Frequency (MHz)	Reading (dBuV)	C.F (dB/m)	Measurement (dBuV/m)	Margin (dB)	Limit (dBuV/m)	Height (cm)	Angle (deg)	Remark (QP/PK/AV)
1	* 10480.000	49.71	4.71	54.42	-13.78	68.20	100	142	Peak
2	15720.000	44.88	6.39	51.27	-22.73	74.00	100	98	Peak

Note:

1. " *", means this data is the worst emission level.
2. C.F (Correction Factor) = Antenna Factor (dB/m)+ Cable Loss (dB) – Pre-amplifier(dB).
3. Measurement (dBuV/m) = Reading(dBuV) + C.F (Correction Factor).
4. The emission levels of other frequencies are very lower than the limit and not show in test report.

EUT	BE3600 Dual-Band Wi-Fi 7 Router	Date of Test	2024-02-06
Factor	DRH18-E	Temp. / Humidity	20°C /65%
Polarity	Horizontal	Site / Test Engineer	AC2 / Marvin
Test Mode	802.11ac-20MHz_TX_Band2_CH 52_ANT 0+1	Test Voltage	AC 120V/60Hz

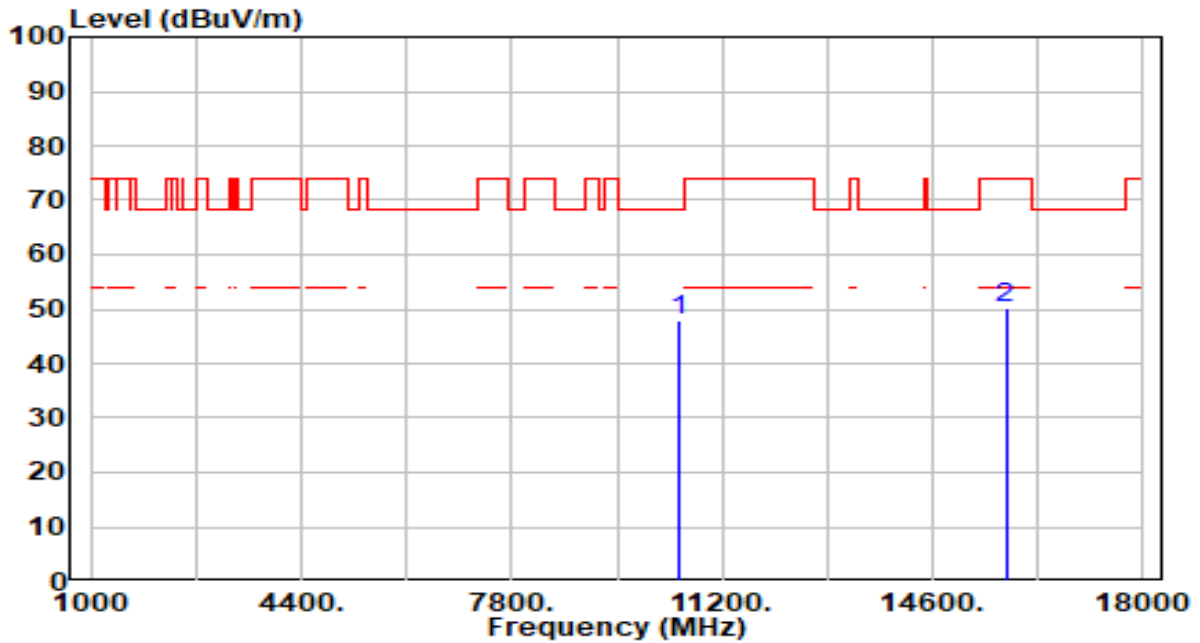

No	Frequency (MHz)	Reading (dBuV)	C.F (dB/m)	Measurement (dBuV/m)	Margin (dB)	Limit (dBuV/m)	Height (cm)	Angle (deg)	Remark (QP/PK/AV)
1	* 10520.000	43.31	4.67	47.98	-20.22	68.20	100	215	Peak
2	15780.000	43.80	6.51	50.31	-23.69	74.00	100	0	Peak

Note:

1. " *", means this data is the worst emission level.
2. C.F (Correction Factor) = Antenna Factor (dB/m)+ Cable Loss (dB) – Pre-amplifier(dB).
3. Measurement (dBuV/m) = Reading(dBuV) + C.F (Correction Factor).
4. The emission levels of other frequencies are very lower than the limit and not show in test report.

EUT	BE3600 Dual-Band Wi-Fi 7 Router	Date of Test	2024-02-06
Factor	DRH18-E	Temp. / Humidity	20°C /65%
Polarity	Vertical	Site / Test Engineer	AC2 / Marvin
Test Mode	802.11ac-20MHz_TX_Band2_CH 52_ANT 0+1	Test Voltage	AC 120V/60Hz

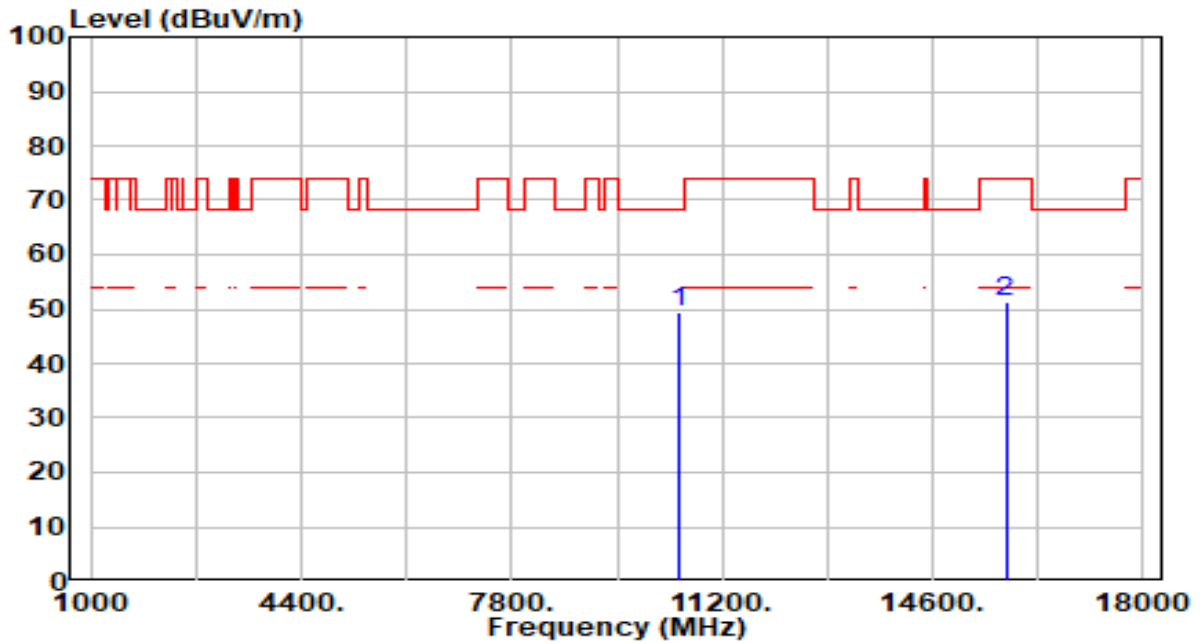

No	Frequency (MHz)	Reading (dBuV)	C.F (dB/m)	Measurement (dBuV/m)	Margin (dB)	Limit (dBuV/m)	Height (cm)	Angle (deg)	Remark (QP/PK/AV)
1	* 10520.000	44.91	4.67	49.58	-18.62	68.20	100	142	Peak
2	15780.000	44.96	6.51	51.47	-22.53	74.00	100	313	Peak

Note:

1. " *", means this data is the worst emission level.
2. C.F (Correction Factor) = Antenna Factor (dB/m)+ Cable Loss (dB) – Pre-amplifier(dB).
3. Measurement (dBuV/m) = Reading(dBuV) + C.F (Correction Factor).
4. The emission levels of other frequencies are very lower than the limit and not show in test report.

EUT	BE3600 Dual-Band Wi-Fi 7 Router	Date of Test	2024-02-06
Factor	DRH18-E	Temp. / Humidity	20°C /65%
Polarity	Horizontal	Site / Test Engineer	AC2 / Marvin
Test Mode	802.11ac-20MHz_TX_Band2_CH 60_ANT 0+1	Test Voltage	AC 120V/60Hz

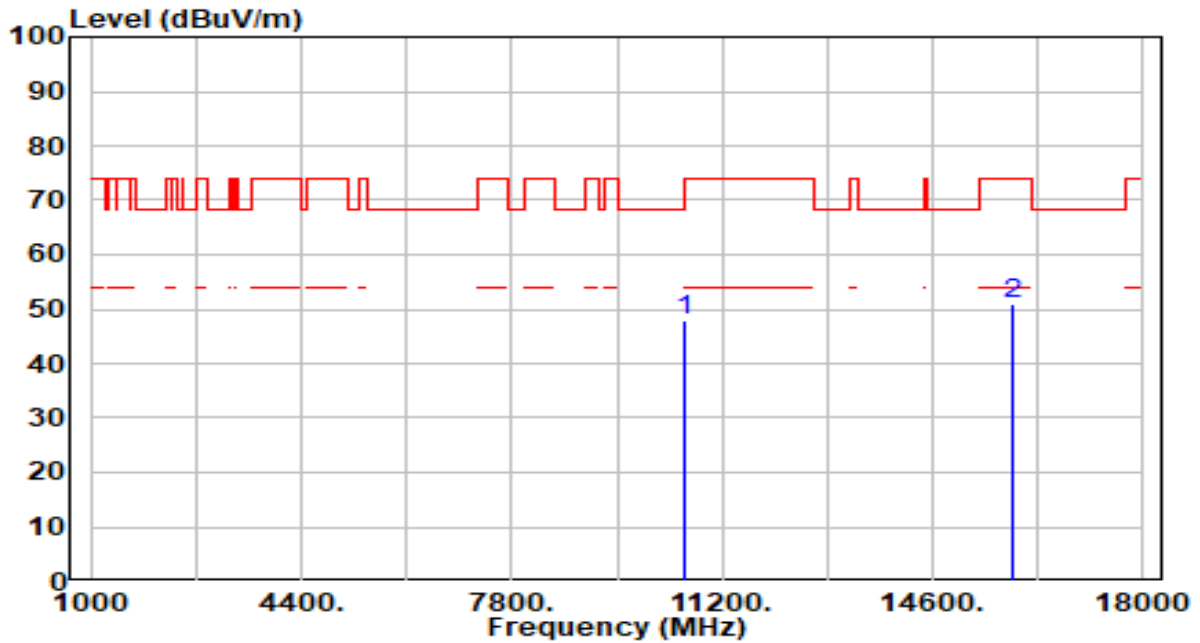

No	Frequency (MHz)	Reading (dBuV)	C.F (dB/m)	Measurement (dBuV/m)	Margin (dB)	Limit (dBuV/m)	Height (cm)	Angle (deg)	Remark (QP/PK/AV)
1	* 10600.000	43.29	4.61	47.91	-20.29	68.20	100	210	Peak
2	15900.000	44.43	6.55	50.98	-23.02	74.00	100	280	Peak

Note:

1. " *", means this data is the worst emission level.
2. C.F (Correction Factor) = Antenna Factor (dB/m)+ Cable Loss (dB) – Pre-amplifier(dB).
3. Measurement (dBuV/m) = Reading(dBuV) + C.F (Correction Factor).
4. The emission levels of other frequencies are very lower than the limit and not show in test report.

EUT	BE3600 Dual-Band Wi-Fi 7 Router	Date of Test	2024-02-06
Factor	DRH18-E	Temp. / Humidity	20°C /65%
Polarity	Vertical	Site / Test Engineer	AC2 / Marvin
Test Mode	802.11ac-20MHz_TX_Band2_CH 60_ANT 0+1	Test Voltage	AC 120V/60Hz

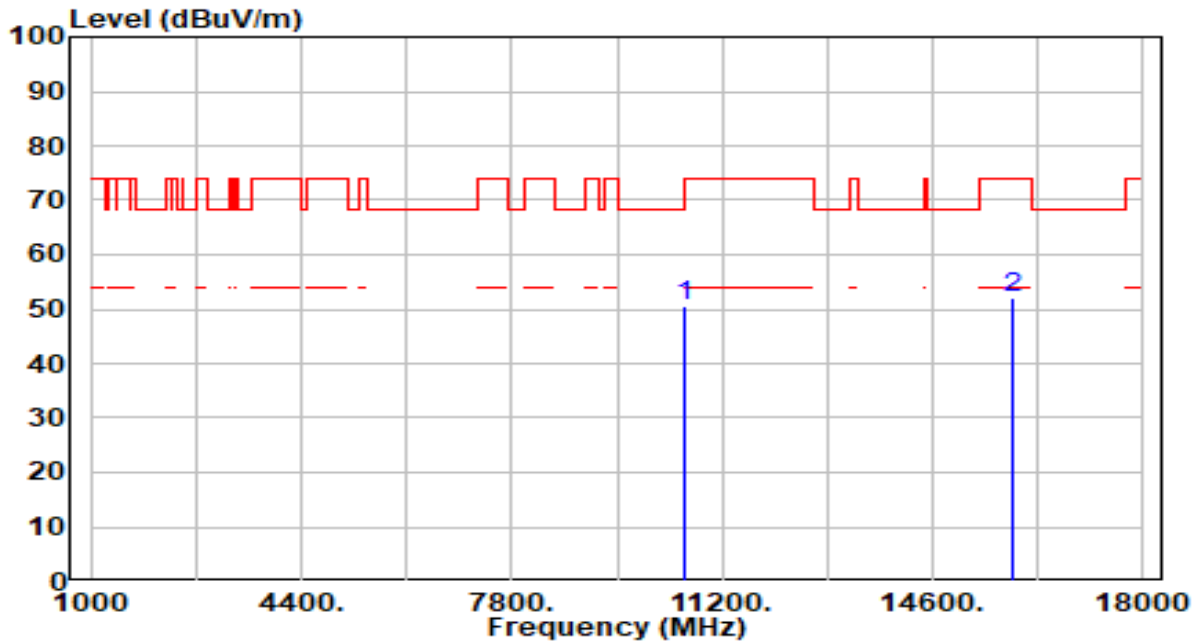

No	Frequency (MHz)	Reading (dBuV)	C.F (dB/m)	Measurement (dBuV/m)	Margin (dB)	Limit (dBuV/m)	Height (cm)	Angle (deg)	Remark (QP/PK/AV)
1	* 10600.000	45.86	4.61	50.47	-17.73	68.20	100	209	Peak
2	15900.000	45.42	6.55	51.97	-22.03	74.00	100	206	Peak

Note:

1. " *", means this data is the worst emission level.
2. C.F (Correction Factor) = Antenna Factor (dB/m)+ Cable Loss (dB) – Pre-amplifier(dB).
3. Measurement (dBuV/m) = Reading(dBuV) + C.F (Correction Factor).
4. The emission levels of other frequencies are very lower than the limit and not show in test report.

EUT	BE3600 Dual-Band Wi-Fi 7 Router	Date of Test	2024-02-06
Factor	DRH18-E	Temp. / Humidity	20°C /65%
Polarity	Horizontal	Site / Test Engineer	AC2 / Marvin
Test Mode	802.11ac-20MHz_TX_Band2_CH 64_ANT 0+1	Test Voltage	AC 120V/60Hz

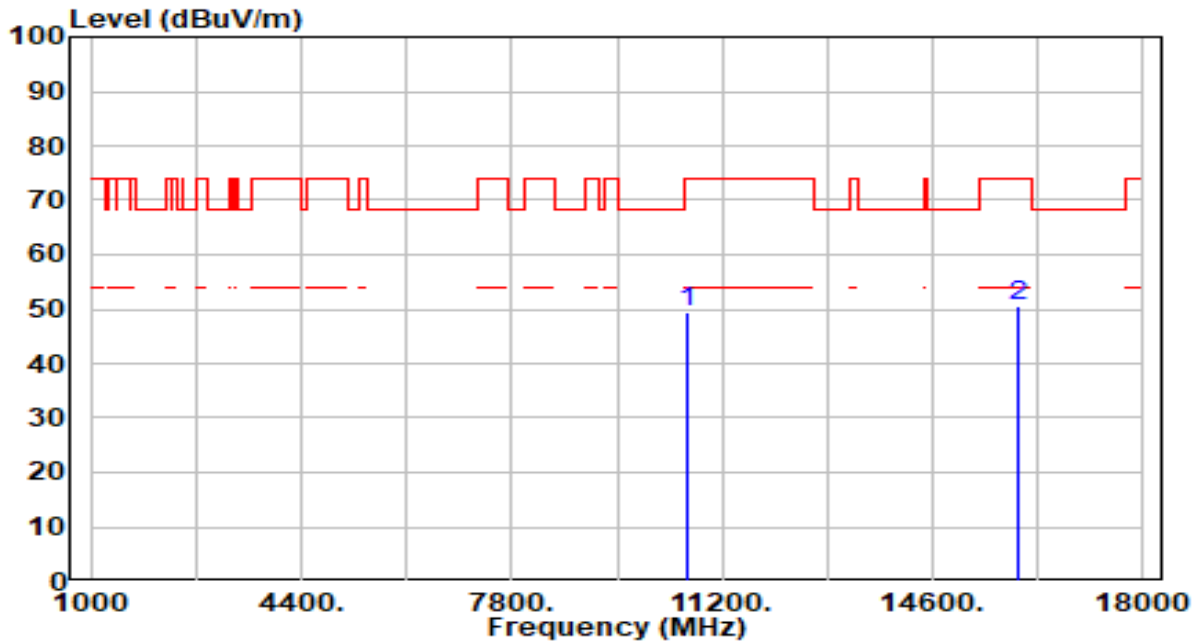

No	Frequency (MHz)	Reading (dBuV)	C.F (dB/m)	Measurement (dBuV/m)	Margin (dB)	Limit (dBuV/m)	Height (cm)	Angle (deg)	Remark (QP/PK/AV)
1	10640.000	44.71	4.62	49.33	-24.67	74.00	100	216	Peak
2	* 15960.000	44.16	6.55	50.71	-23.29	74.00	100	236	Peak

Note:

1. " *", means this data is the worst emission level.
2. C.F (Correction Factor) = Antenna Factor (dB/m)+ Cable Loss (dB) – Pre-amplifier(dB).
3. Measurement (dBuV/m) = Reading(dBuV) + C.F (Correction Factor).
4. The emission levels of other frequencies are very lower than the limit and not show in test report.

EUT	BE3600 Dual-Band Wi-Fi 7 Router	Date of Test	2024-02-06
Factor	DRH18-E	Temp. / Humidity	20°C /65%
Polarity	Vertical	Site / Test Engineer	AC2 / Marvin
Test Mode	802.11ac-20MHz_TX_Band2_CH 64_ANT 0+1	Test Voltage	AC 120V/60Hz

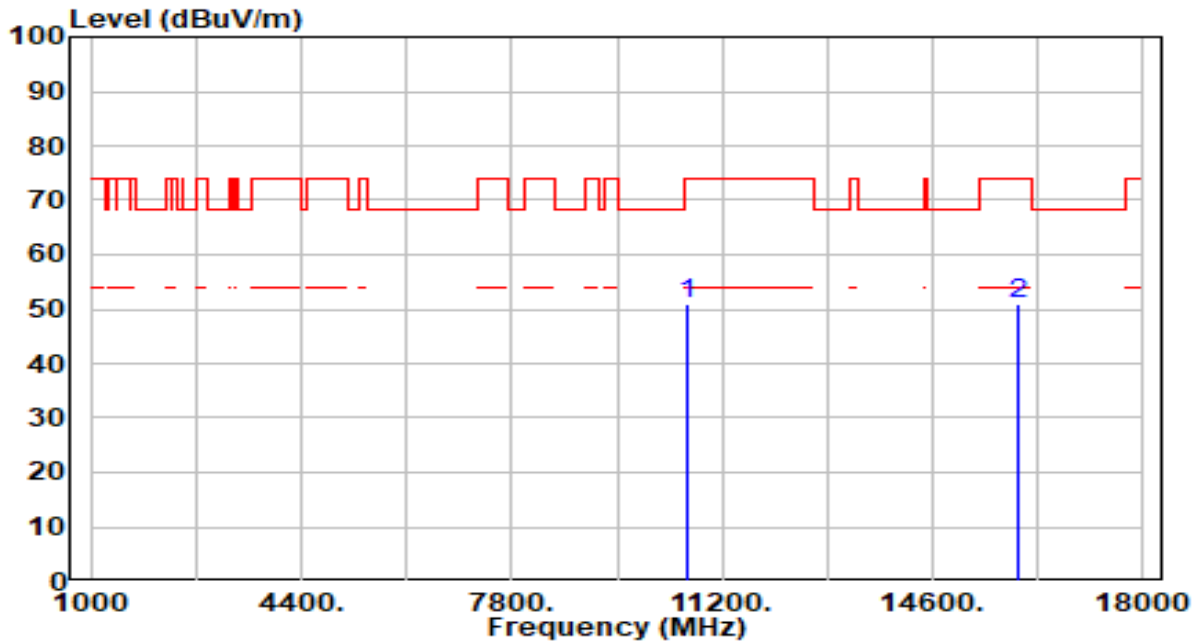

No	Frequency (MHz)	Reading (dBuV)	C.F (dB/m)	Measurement (dBuV/m)	Margin (dB)	Limit (dBuV/m)	Height (cm)	Angle (deg)	Remark (QP/PK/AV)
1	10640.000	46.16	4.62	50.78	-23.22	74.00	100	166	Peak
2	* 15960.000	44.31	6.55	50.86	-23.14	74.00	100	236	Peak

Note:

1. " *", means this data is the worst emission level.
2. C.F (Correction Factor) = Antenna Factor (dB/m)+ Cable Loss (dB) – Pre-amplifier(dB).
3. Measurement (dBuV/m) = Reading(dBuV) + C.F (Correction Factor).
4. The emission levels of other frequencies are very lower than the limit and not show in test report.

EUT	BE3600 Dual-Band Wi-Fi 7 Router	Date of Test	2024-02-06
Factor	DRH18-E	Temp. / Humidity	20°C /65%
Polarity	Horizontal	Site / Test Engineer	AC2 / Marvin
Test Mode	802.11ac-20MHz_TX_Band3_CH 100_ANT 0+1	Test Voltage	AC 120V/60Hz

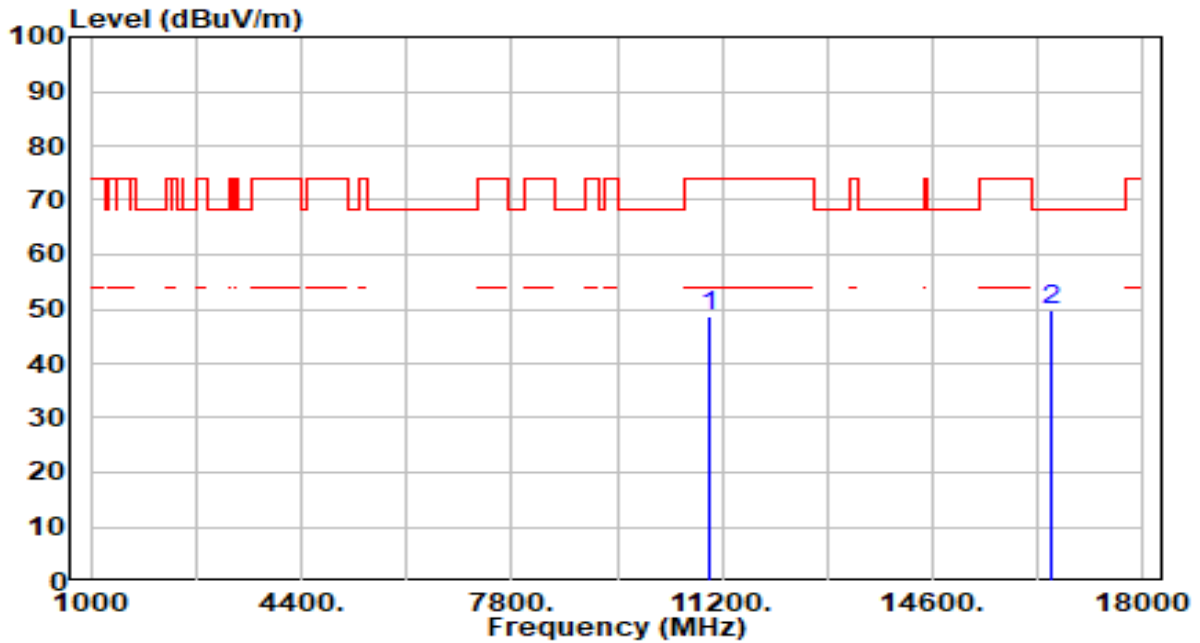

No	Frequency (MHz)	Reading (dBuV)	C.F (dB/m)	Measurement (dBuV/m)	Margin (dB)	Limit (dBuV/m)	Height (cm)	Angle (deg)	Remark (QP/PK/AV)
1	11000.000	44.12	4.52	48.64	-25.36	74.00	100	183	Peak
2	* 16500.000	43.56	6.10	49.66	-18.54	68.20	100	311	Peak

Note:

1. " *", means this data is the worst emission level.
2. C.F (Correction Factor) = Antenna Factor (dB/m)+ Cable Loss (dB) – Pre-amplifier(dB).
3. Measurement (dBuV/m) = Reading(dBuV) + C.F (Correction Factor).
4. The emission levels of other frequencies are very lower than the limit and not show in test report.

EUT	BE3600 Dual-Band Wi-Fi 7 Router	Date of Test	2024-02-06
Factor	DRH18-E	Temp. / Humidity	20°C /65%
Polarity	Vertical	Site / Test Engineer	AC2 / Marvin
Test Mode	802.11ac-20MHz_TX_Band3_CH 100_ANT 0+1	Test Voltage	AC 120V/60Hz

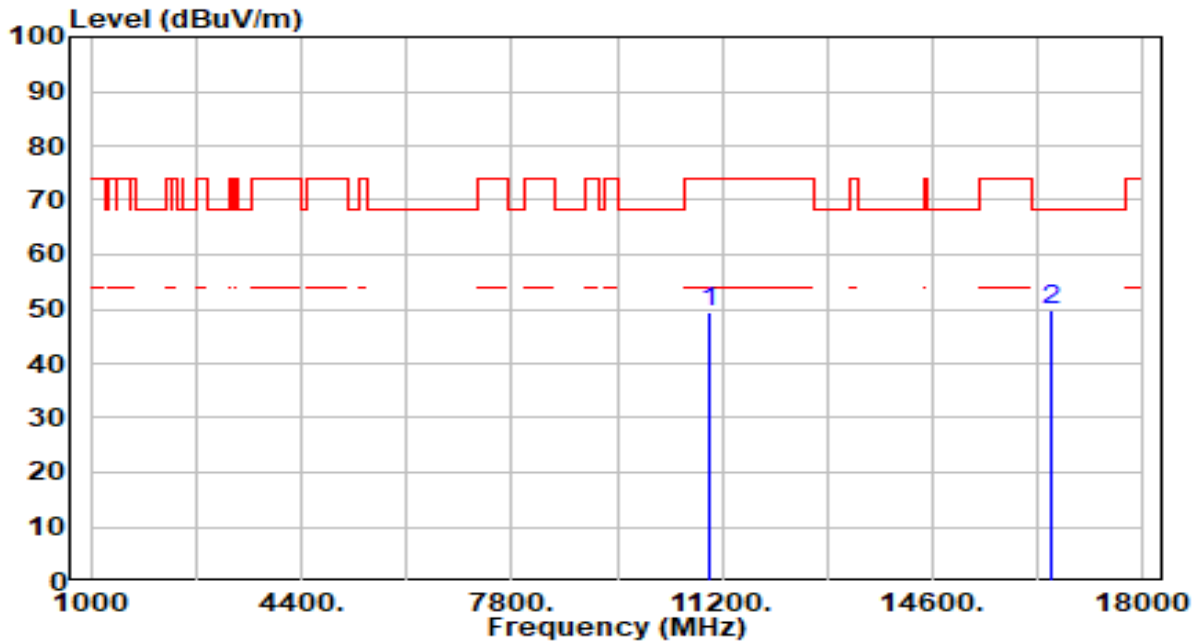

No	Frequency (MHz)	Reading (dBuV)	C.F (dB/m)	Measurement (dBuV/m)	Margin (dB)	Limit (dBuV/m)	Height (cm)	Angle (deg)	Remark (QP/PK/AV)
1	11000.000	44.88	4.52	49.40	-24.60	74.00	100	143	Peak
2	* 16500.000	43.86	6.10	49.96	-18.24	68.20	100	305	Peak

Note:

1. " *", means this data is the worst emission level.
2. C.F (Correction Factor) = Antenna Factor (dB/m)+ Cable Loss (dB) – Pre-amplifier(dB).
3. Measurement (dBuV/m) = Reading(dBuV) + C.F (Correction Factor).
4. The emission levels of other frequencies are very lower than the limit and not show in test report.

EUT	BE3600 Dual-Band Wi-Fi 7 Router	Date of Test	2024-02-06
Factor	DRH18-E	Temp. / Humidity	20°C /65%
Polarity	Horizontal	Site / Test Engineer	AC2 / Marvin
Test Mode	802.11ac-20MHz_TX_Band3_CH 116_ANT 0+1	Test Voltage	AC 120V/60Hz

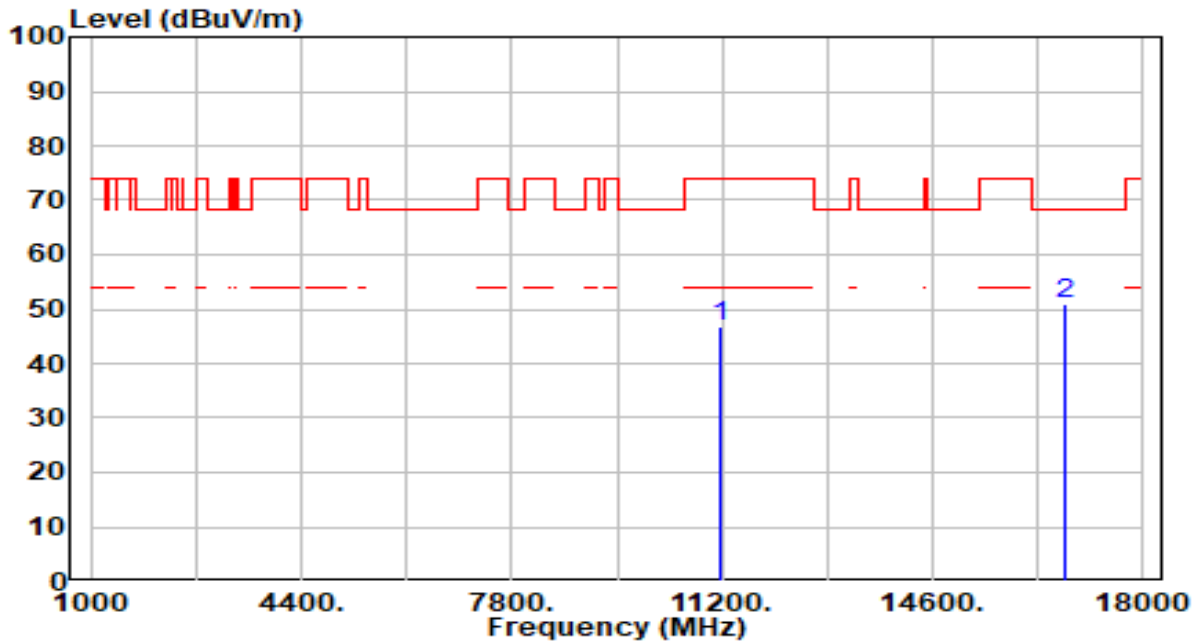

No	Frequency (MHz)	Reading (dBuV)	C.F (dB/m)	Measurement (dBuV/m)	Margin (dB)	Limit (dBuV/m)	Height (cm)	Angle (deg)	Remark (QP/PK/AV)
1	11160.000	41.93	4.94	46.86	-27.14	74.00	100	0	Peak
2	* 16740.000	44.66	6.19	50.85	-17.35	68.20	100	64	Peak

Note:

1. " *", means this data is the worst emission level.
2. C.F (Correction Factor) = Antenna Factor (dB/m)+ Cable Loss (dB) – Pre-amplifier(dB).
3. Measurement (dBuV/m) = Reading(dBuV) + C.F (Correction Factor).
4. The emission levels of other frequencies are very lower than the limit and not show in test report.

EUT	BE3600 Dual-Band Wi-Fi 7 Router	Date of Test	2024-02-06
Factor	DRH18-E	Temp. / Humidity	20°C /65%
Polarity	Vertical	Site / Test Engineer	AC2 / Marvin
Test Mode	802.11ac-20MHz_TX_Band3_CH 116_ANT 0+1	Test Voltage	AC 120V/60Hz

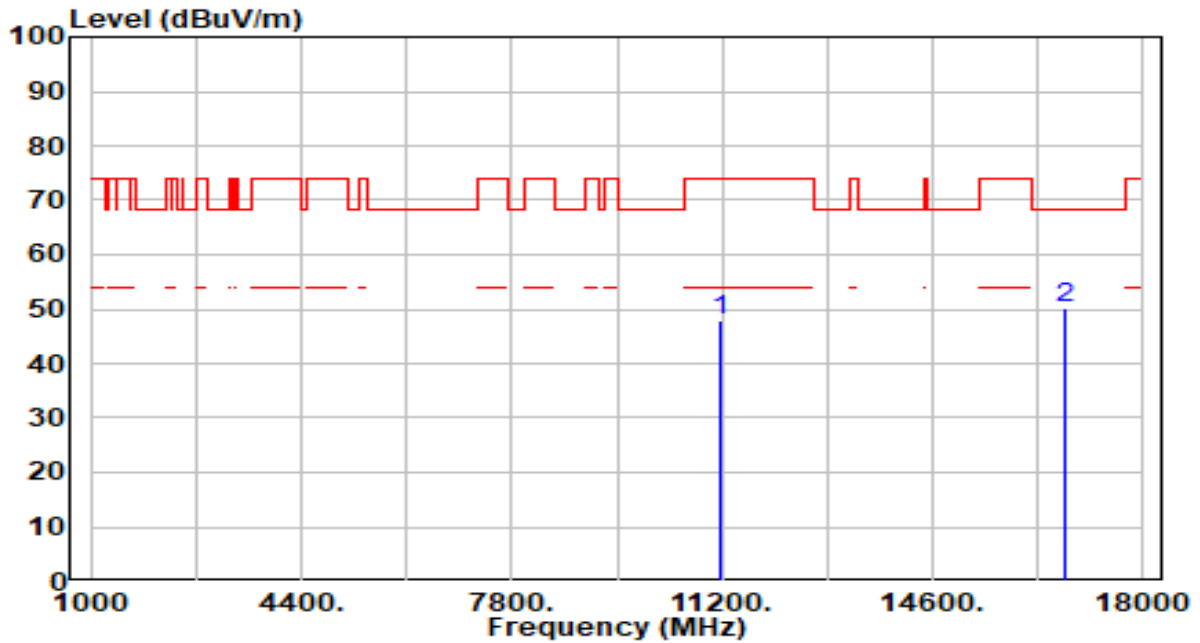

No	Frequency (MHz)	Reading (dBuV)	C.F (dB/m)	Measurement (dBuV/m)	Margin (dB)	Limit (dBuV/m)	Height (cm)	Angle (deg)	Remark (QP/PK/AV)
1	11160.000	43.11	4.94	48.04	-25.96	74.00	100	136	Peak
2	* 16740.000	43.89	6.19	50.08	-18.12	68.20	100	360	Peak

Note:

1. " *", means this data is the worst emission level.
2. C.F (Correction Factor) = Antenna Factor (dB/m)+ Cable Loss (dB) – Pre-amplifier(dB).
3. Measurement (dBuV/m) = Reading(dBuV) + C.F (Correction Factor).
4. The emission levels of other frequencies are very lower than the limit and not show in test report.

EUT	BE3600 Dual-Band Wi-Fi 7 Router	Date of Test	2024-02-06
Factor	DRH18-E	Temp. / Humidity	20°C /65%
Polarity	Horizontal	Site / Test Engineer	AC2 / Marvin
Test Mode	802.11ac-20MHz_TX_Band3_CH 140_ANT 0+1	Test Voltage	AC 120V/60Hz



No	Frequency (MHz)	Reading (dBuV)	C.F (dB/m)	Measurement (dBuV/m)	Margin (dB)	Limit (dBuV/m)	Height (cm)	Angle (deg)	Remark (QP/PK/AV)
1	11400.000	42.52	5.26	47.79	-26.21	74.00	100	52	Peak
2	* 17100.000	43.22	5.97	49.20	-19.00	68.20	100	346	Peak

Note:

1. " *", means this data is the worst emission level.
2. C.F (Correction Factor) = Antenna Factor (dB/m)+ Cable Loss (dB) – Pre-amplifier(dB).
3. Measurement (dBuV/m) = Reading(dBuV) + C.F (Correction Factor).
4. The emission levels of other frequencies are very lower than the limit and not show in test report.

EUT	BE3600 Dual-Band Wi-Fi 7 Router	Date of Test	2024-02-06
Factor	DRH18-E	Temp. / Humidity	20°C /65%
Polarity	Vertical	Site / Test Engineer	AC2 / Marvin
Test Mode	802.11ac-20MHz_TX_Band3_CH 140_ANT 0+1	Test Voltage	AC 120V/60Hz

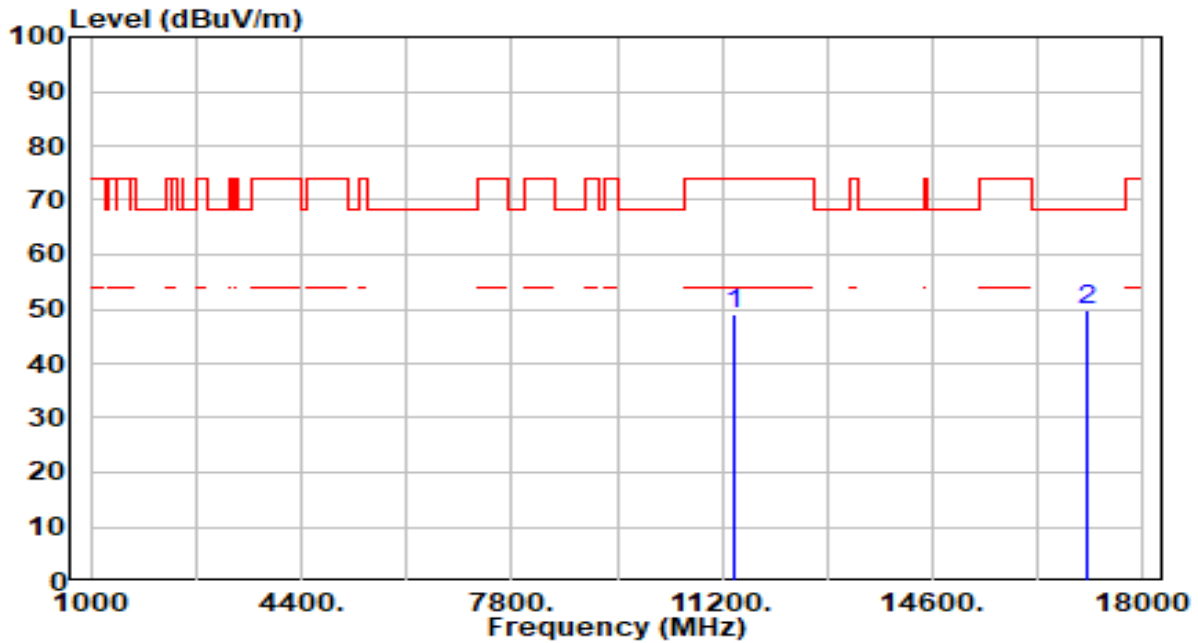

No	Frequency (MHz)	Reading (dBuV)	C.F (dB/m)	Measurement (dBuV/m)	Margin (dB)	Limit (dBuV/m)	Height (cm)	Angle (deg)	Remark (QP/PK/AV)
1	11400.000	43.69	5.26	48.95	-25.05	74.00	100	125	Peak
2	* 17100.000	43.83	5.97	49.80	-18.40	68.20	100	192	Peak

Note:

1. " *", means this data is the worst emission level.
2. C.F (Correction Factor) = Antenna Factor (dB/m)+ Cable Loss (dB) – Pre-amplifier(dB).
3. Measurement (dBuV/m) = Reading(dBuV) + C.F (Correction Factor).
4. The emission levels of other frequencies are very lower than the limit and not show in test report.

EUT	BE3600 Dual-Band Wi-Fi 7 Router	Date of Test	2024-02-06
Factor	DRH18-E	Temp. / Humidity	20°C /65%
Polarity	Horizontal	Site / Test Engineer	AC2 / Marvin
Test Mode	802.11ac-20MHz_TX_Band3_CH 144_ANT 0+1	Test Voltage	AC 120V/60Hz

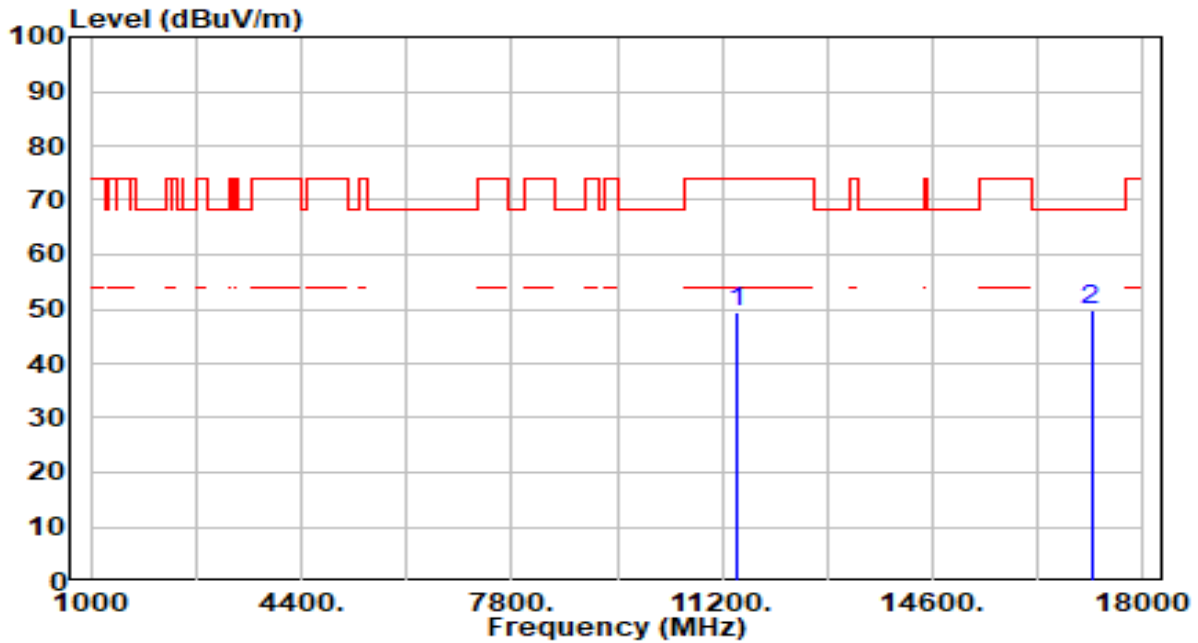

No	Frequency (MHz)	Reading (dBuV)	C.F (dB/m)	Measurement (dBuV/m)	Margin (dB)	Limit (dBuV/m)	Height (cm)	Angle (deg)	Remark (QP/PK/AV)
1	11440.000	44.29	5.29	49.57	-24.43	74.00	100	174	Peak
2	* 17160.000	43.97	5.87	49.84	-18.36	68.20	100	274	Peak

Note:

1. " *", means this data is the worst emission level.
2. C.F (Correction Factor) = Antenna Factor (dB/m)+ Cable Loss (dB) – Pre-amplifier(dB).
3. Measurement (dBuV/m) = Reading(dBuV) + C.F (Correction Factor).
4. The emission levels of other frequencies are very lower than the limit and not show in test report.

EUT	BE3600 Dual-Band Wi-Fi 7 Router	Date of Test	2024-02-06
Factor	DRH18-E	Temp. / Humidity	20°C /65%
Polarity	Vertical	Site / Test Engineer	AC2 / Marvin
Test Mode	802.11ac-20MHz_TX_Band3_CH 144_ANT 0+1	Test Voltage	AC 120V/60Hz

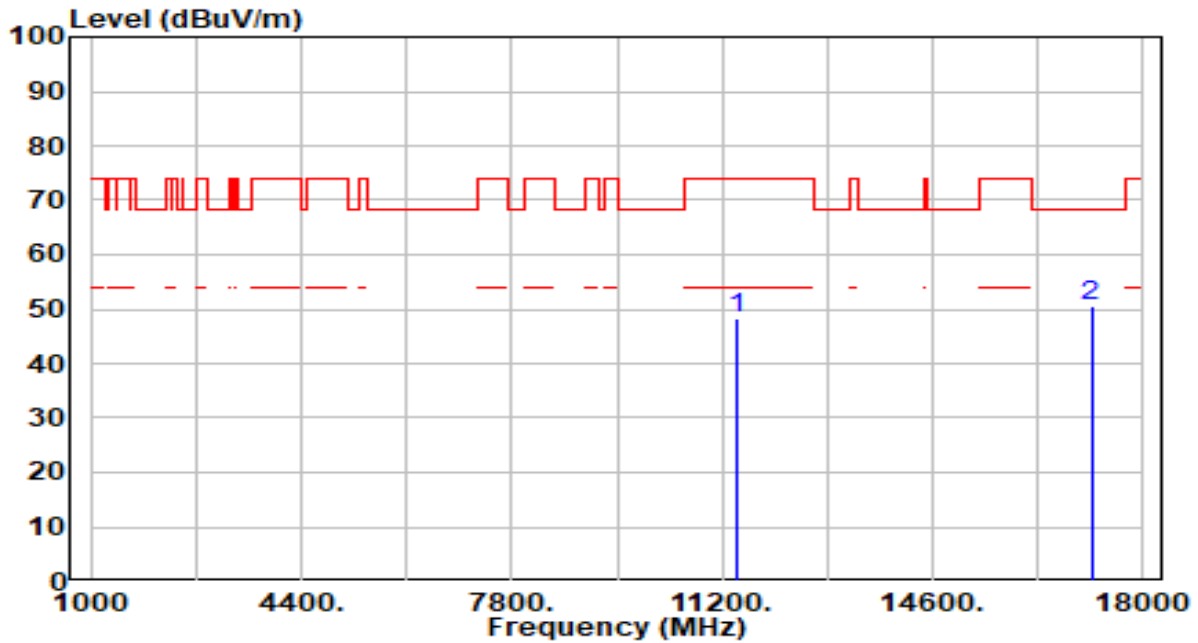

No	Frequency (MHz)	Reading (dBuV)	C.F (dB/m)	Measurement (dBuV/m)	Margin (dB)	Limit (dBuV/m)	Height (cm)	Angle (deg)	Remark (QP/PK/AV)
1	11440.000	43.03	5.29	48.31	-25.69	74.00	100	207	Peak
2	* 17160.000	44.76	5.87	50.63	-17.57	68.20	100	22	Peak

Note:

1. " *", means this data is the worst emission level.
2. C.F (Correction Factor) = Antenna Factor (dB/m)+ Cable Loss (dB) – Pre-amplifier(dB).
3. Measurement (dBuV/m) = Reading(dBuV) + C.F (Correction Factor).
4. The emission levels of other frequencies are very lower than the limit and not show in test report.

EUT	BE3600 Dual-Band Wi-Fi 7 Router	Date of Test	2024-02-06
Factor	DRH18-E	Temp. / Humidity	20°C /65%
Polarity	Horizontal	Site / Test Engineer	AC2 / Marvin
Test Mode	802.11ac-20MHz_TX_Band4_CH 149_ANT 0+1	Test Voltage	AC 120V/60Hz

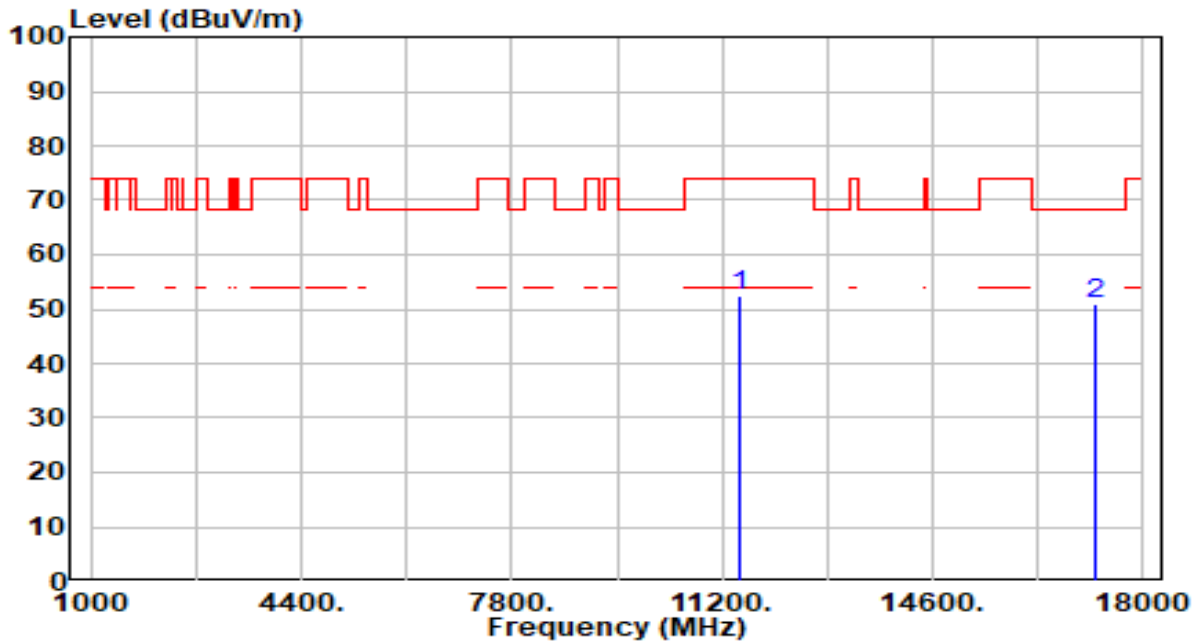

No	Frequency (MHz)	Reading (dBuV)	C.F (dB/m)	Measurement (dBuV/m)	Margin (dB)	Limit (dBuV/m)	Height (cm)	Angle (deg)	Remark (QP/PK/AV)
1	11490.000	46.96	5.32	52.28	-21.72	74.00	100	193	Peak
2	* 17235.000	45.10	5.71	50.81	-17.39	68.20	100	0	Peak

Note:

1. " *", means this data is the worst emission level.
2. C.F (Correction Factor) = Antenna Factor (dB/m)+ Cable Loss (dB) – Pre-amplifier(dB).
3. Measurement (dBuV/m) = Reading(dBuV) + C.F (Correction Factor).
4. The emission levels of other frequencies are very lower than the limit and not show in test report.

EUT	BE3600 Dual-Band Wi-Fi 7 Router	Date of Test	2024-02-06
Factor	DRH18-E	Temp. / Humidity	20°C /65%
Polarity	Vertical	Site / Test Engineer	AC2 / Marvin
Test Mode	802.11ac-20MHz_TX_Band4_CH 149_ANT 0+1	Test Voltage	AC 120V/60Hz

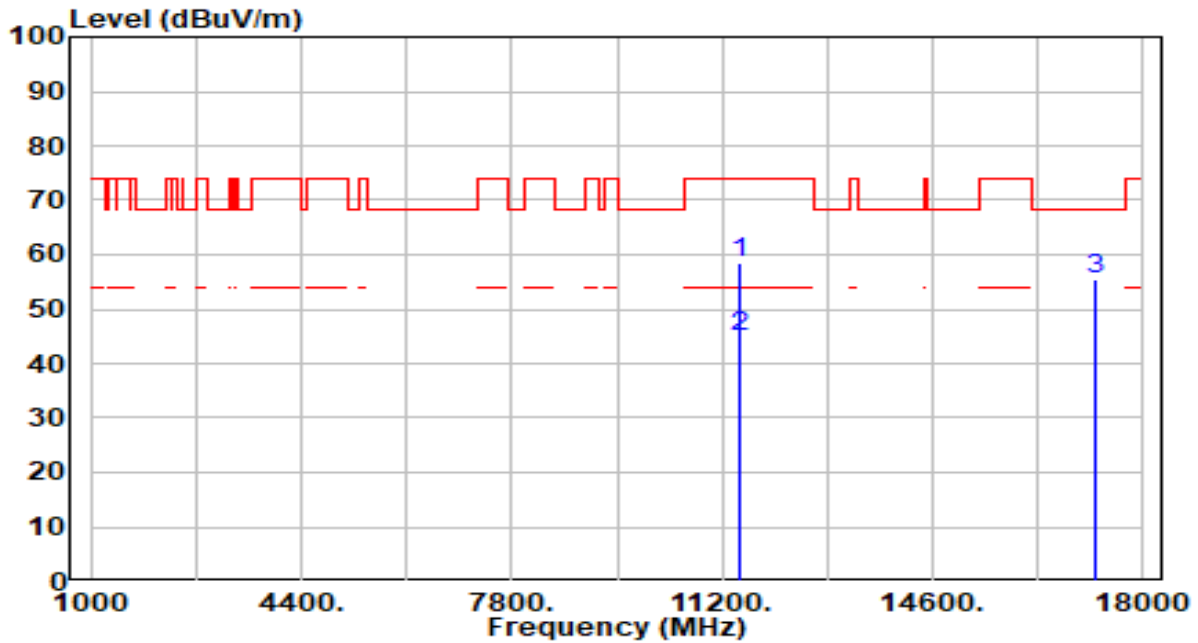

No	Frequency (MHz)	Reading (dBuV)	C.F (dB/m)	Measurement (dBuV/m)	Margin (dB)	Limit (dBuV/m)	Height (cm)	Angle (deg)	Remark (QP/PK/AV)
1	11490.000	53.23	5.32	58.55	-15.45	74.00	100	239	Peak
2	* 11490.000	39.60	5.32	44.92	-9.08	54.00	100	239	Average
3	* 17235.000	49.84	5.71	55.55	-12.65	68.20	100	254	Peak

Note:

1. " *", means this data is the worst emission level.
2. C.F (Correction Factor) = Antenna Factor (dB/m)+ Cable Loss (dB) – Preamplifier(dB).
3. Measurement (dBuV/m) = Reading(dBuV) + C.F (Correction Factor).
4. The emission levels of other frequencies are very lower than the limit and not show in test report.

EUT	BE3600 Dual-Band Wi-Fi 7 Router	Date of Test	2024-02-06
Factor	DRH18-E	Temp. / Humidity	20°C /65%
Polarity	Horizontal	Site / Test Engineer	AC2 / Marvin
Test Mode	802.11ac-20MHz_TX_Band4_CH 157_ANT 0+1	Test Voltage	AC 120V/60Hz

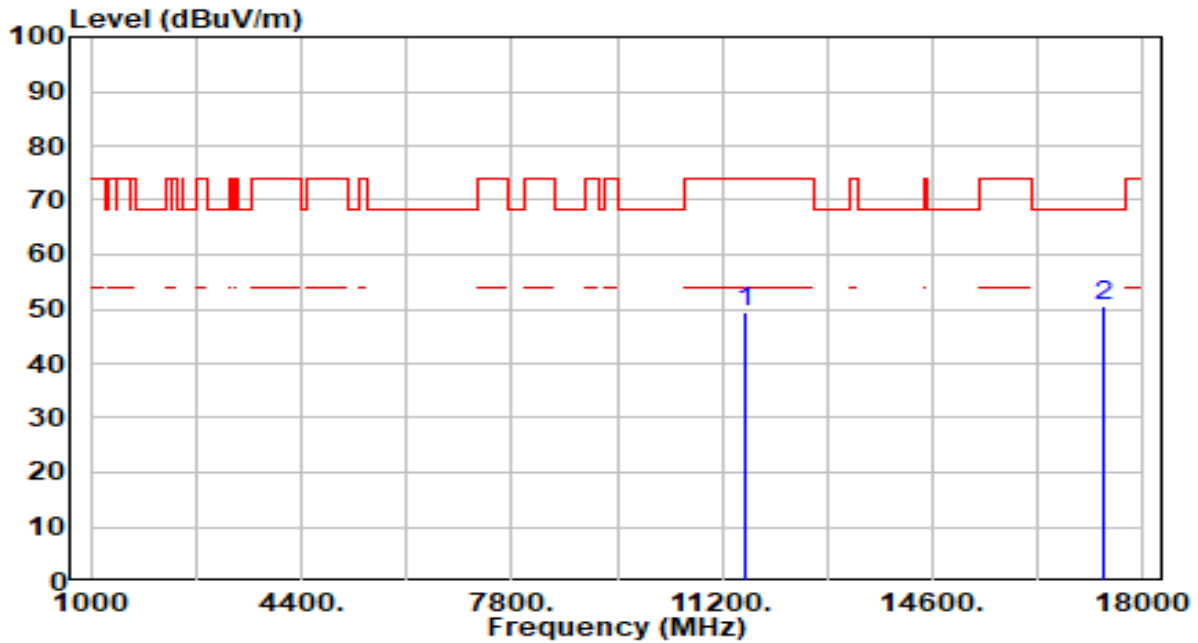

No	Frequency (MHz)	Reading (dBuV)	C.F (dB/m)	Measurement (dBuV/m)	Margin (dB)	Limit (dBuV/m)	Height (cm)	Angle (deg)	Remark (QP/PK/AV)
1	11570.000	44.23	5.38	49.61	-24.39	74.00	100	194	Peak
2	* 17355.000	45.00	5.39	50.39	-17.81	68.20	100	55	Peak

Note:

1. " *", means this data is the worst emission level.
2. C.F (Correction Factor) = Antenna Factor (dB/m)+ Cable Loss (dB) – Pre-amplifier(dB).
3. Measurement (dBuV/m) = Reading(dBuV) + C.F (Correction Factor).
4. The emission levels of other frequencies are very lower than the limit and not show in test report.

EUT	BE3600 Dual-Band Wi-Fi 7 Router	Date of Test	2024-02-06
Factor	DRH18-E	Temp. / Humidity	20°C /65%
Polarity	Vertical	Site / Test Engineer	AC2 / Marvin
Test Mode	802.11ac-20MHz_TX_Band4_CH 157_ANT 0+1	Test Voltage	AC 120V/60Hz

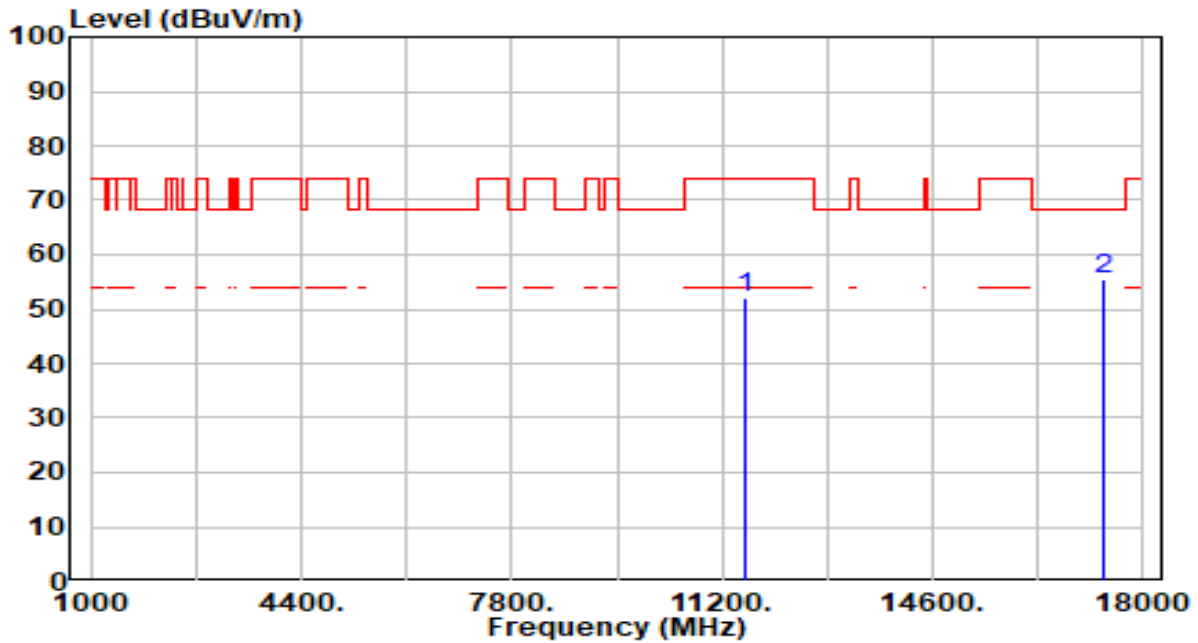

No	Frequency (MHz)	Reading (dBuV)	C.F (dB/m)	Measurement (dBuV/m)	Margin (dB)	Limit (dBuV/m)	Height (cm)	Angle (deg)	Remark (QP/PK/AV)
1	11570.000	46.84	5.38	52.22	-21.78	74.00	100	242	Peak
2	* 17355.000	50.21	5.39	55.59	-12.61	68.20	100	262	Peak

Note:

1. " *", means this data is the worst emission level.
2. C.F (Correction Factor) = Antenna Factor (dB/m)+ Cable Loss (dB) – Pre-amplifier(dB).
3. Measurement (dBuV/m) = Reading(dBuV) + C.F (Correction Factor).
4. The emission levels of other frequencies are very lower than the limit and not show in test report.

EUT	BE3600 Dual-Band Wi-Fi 7 Router	Date of Test	2024-02-06
Factor	DRH18-E	Temp. / Humidity	20°C /65%
Polarity	Horizontal	Site / Test Engineer	AC2 / Marvin
Test Mode	802.11ac-20MHz_TX_Band4_CH 165_ANT 0+1	Test Voltage	AC 120V/60Hz

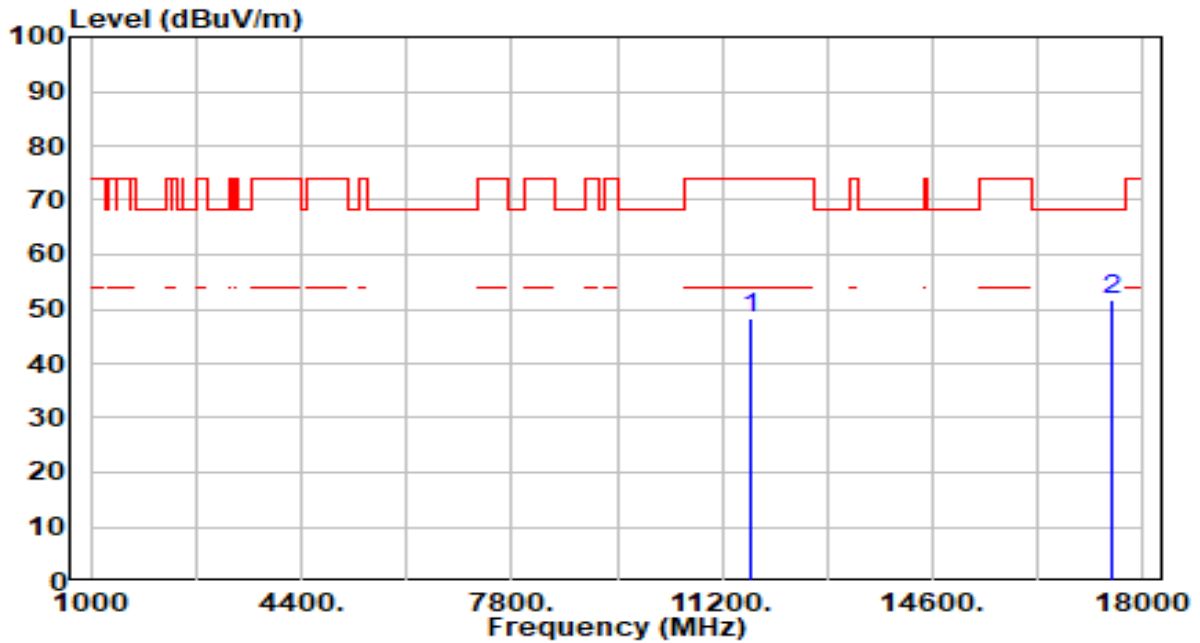

No	Frequency (MHz)	Reading (dBuV)	C.F (dB/m)	Measurement (dBuV/m)	Margin (dB)	Limit (dBuV/m)	Height (cm)	Angle (deg)	Remark (QP/PK/AV)
1	11650.000	42.95	5.36	48.31	-25.69	74.00	100	10	Peak
2	* 17475.000	46.51	5.29	51.81	-16.39	68.20	100	36	Peak

Note:

1. " *", means this data is the worst emission level.
2. C.F (Correction Factor) = Antenna Factor (dB/m)+ Cable Loss (dB) – Pre-amplifier(dB).
3. Measurement (dBuV/m) = Reading(dBuV) + C.F (Correction Factor).
4. The emission levels of other frequencies are very lower than the limit and not show in test report.

EUT	BE3600 Dual-Band Wi-Fi 7 Router	Date of Test	2024-02-06
Factor	DRH18-E	Temp. / Humidity	20°C /65%
Polarity	Vertical	Site / Test Engineer	AC2 / Marvin
Test Mode	802.11ac-20MHz_TX_Band4_CH 165_ANT 0+1	Test Voltage	AC 120V/60Hz

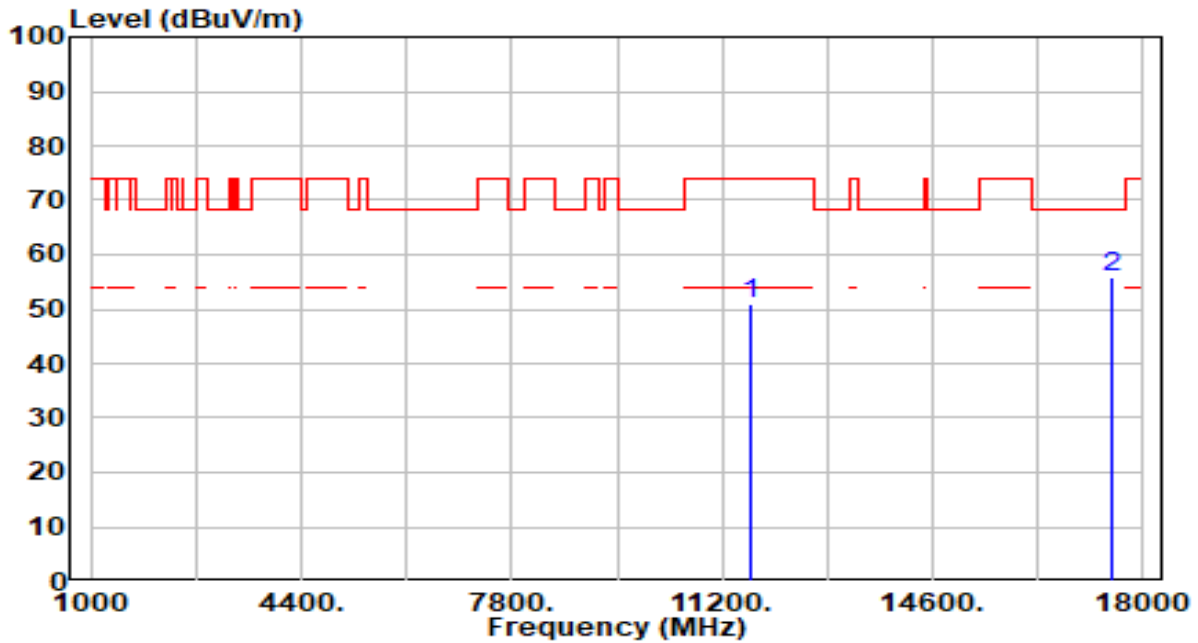

No	Frequency (MHz)	Reading (dBuV)	C.F (dB/m)	Measurement (dBuV/m)	Margin (dB)	Limit (dBuV/m)	Height (cm)	Angle (deg)	Remark (QP/PK/AV)
1	11650.000	45.58	5.36	50.95	-23.05	74.00	100	240	Peak
2	* 17475.000	50.71	5.29	56.01	-12.19	68.20	100	252	Peak

Note:

- "*", means this data is the worst emission level.
- C.F (Correction Factor) = Antenna Factor (dB/m)+ Cable Loss (dB) – Pre-amplifier(dB).
- Measurement (dBuV/m) = Reading(dBuV) + C.F (Correction Factor).
- The emission levels of other frequencies are very lower than the limit and not show in test report.

EUT	BE3600 Dual-Band Wi-Fi 7 Router	Date of Test	2024-02-06
Factor	DRH18-E	Temp. / Humidity	20°C /65%
Polarity	Horizontal	Site / Test Engineer	AC2 / Marvin
Test Mode	802.11ac-40MHz_TX_Band1_CH 38_ANT 0+1	Test Voltage	AC 120V/60Hz

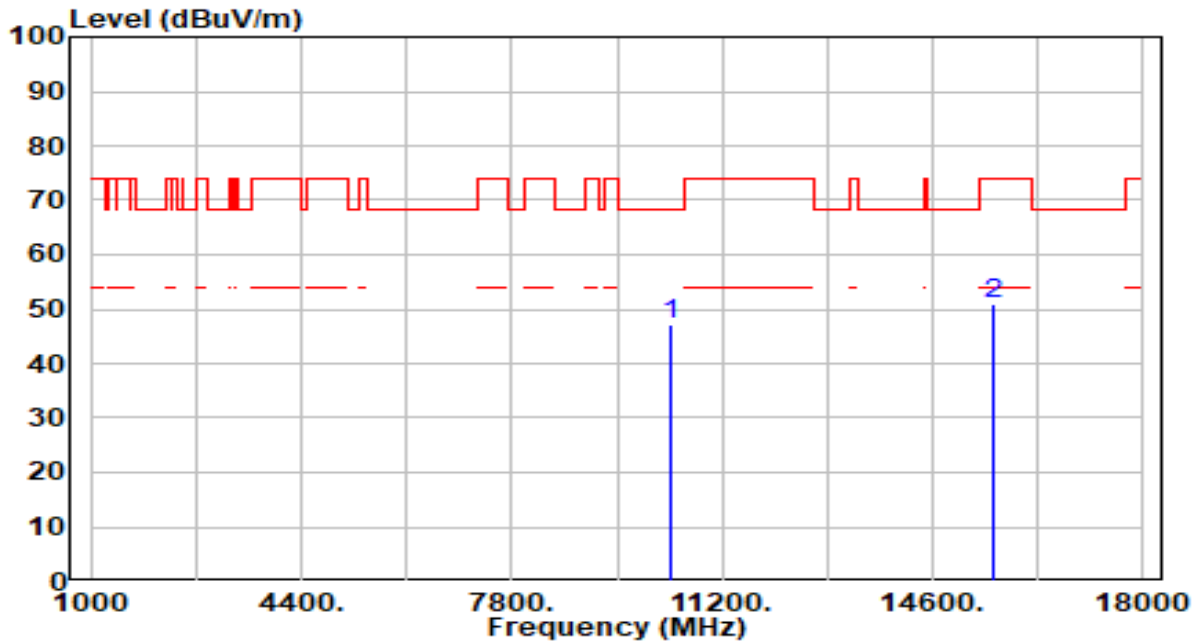

No	Frequency (MHz)	Reading (dBuV)	C.F (dB/m)	Measurement (dBuV/m)	Margin (dB)	Limit (dBuV/m)	Height (cm)	Angle (deg)	Remark (QP/PK/AV)
1	* 10380.000	42.49	4.84	47.33	-20.87	68.20	100	154	Peak
2	15570.000	44.73	6.18	50.91	-23.09	74.00	100	133	Peak

Note:

1. " *", means this data is the worst emission level.
2. C.F (Correction Factor) = Antenna Factor (dB/m)+ Cable Loss (dB) – Pre-amplifier(dB).
3. Measurement (dBuV/m) = Reading(dBuV) + C.F (Correction Factor).
4. The emission levels of other frequencies are very lower than the limit and not show in test report.

EUT	BE3600 Dual-Band Wi-Fi 7 Router	Date of Test	2024-02-06
Factor	DRH18-E	Temp. / Humidity	20°C /65%
Polarity	Vertical	Site / Test Engineer	AC2 / Marvin
Test Mode	802.11ac-40MHz_TX_Band1_CH 38_ANT 0+1	Test Voltage	AC 120V/60Hz

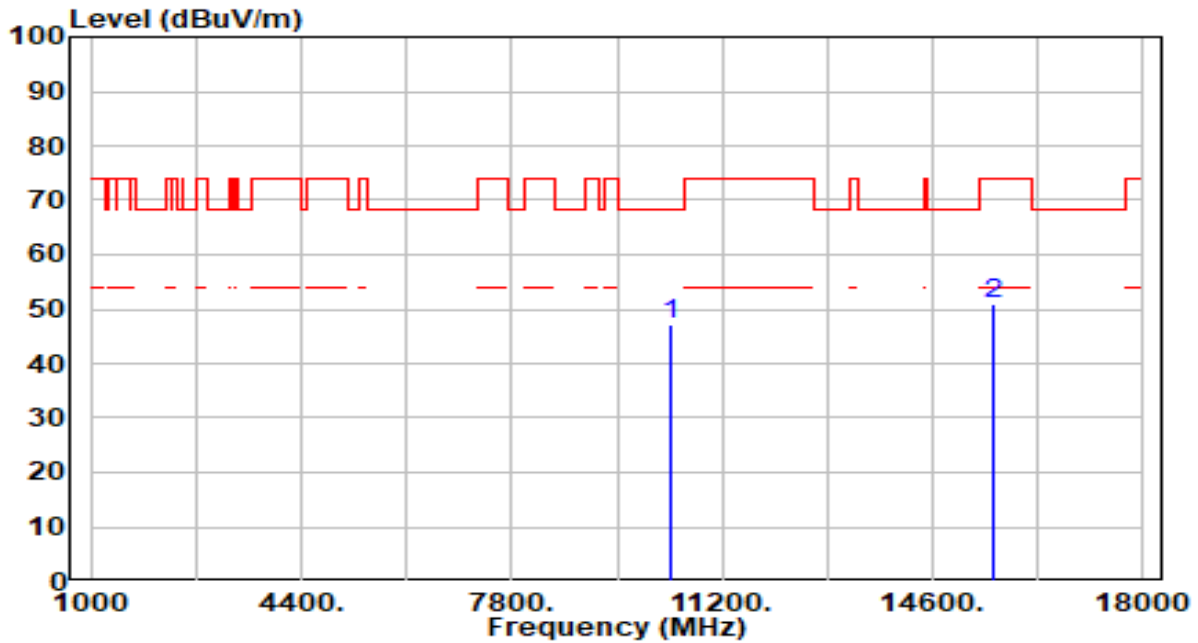

No	Frequency (MHz)	Reading (dBuV)	C.F (dB/m)	Measurement (dBuV/m)	Margin (dB)	Limit (dBuV/m)	Height (cm)	Angle (deg)	Remark (QP/PK/AV)
1	* 10380.000	42.24	4.84	47.08	-21.12	68.20	100	247	Peak
2	15570.000	44.61	6.18	50.78	-23.22	74.00	100	185	Peak

Note:

1. " *", means this data is the worst emission level.
2. C.F (Correction Factor) = Antenna Factor (dB/m)+ Cable Loss (dB) – Pre-amplifier(dB).
3. Measurement (dBuV/m) = Reading(dBuV) + C.F (Correction Factor).
4. The emission levels of other frequencies are very lower than the limit and not show in test report.

EUT	BE3600 Dual-Band Wi-Fi 7 Router	Date of Test	2024-02-06
Factor	DRH18-E	Temp. / Humidity	20°C /65%
Polarity	Horizontal	Site / Test Engineer	AC2 / Marvin
Test Mode	802.11ac-40MHz_TX_Band1_CH 46_ANT 0+1	Test Voltage	AC 120V/60Hz

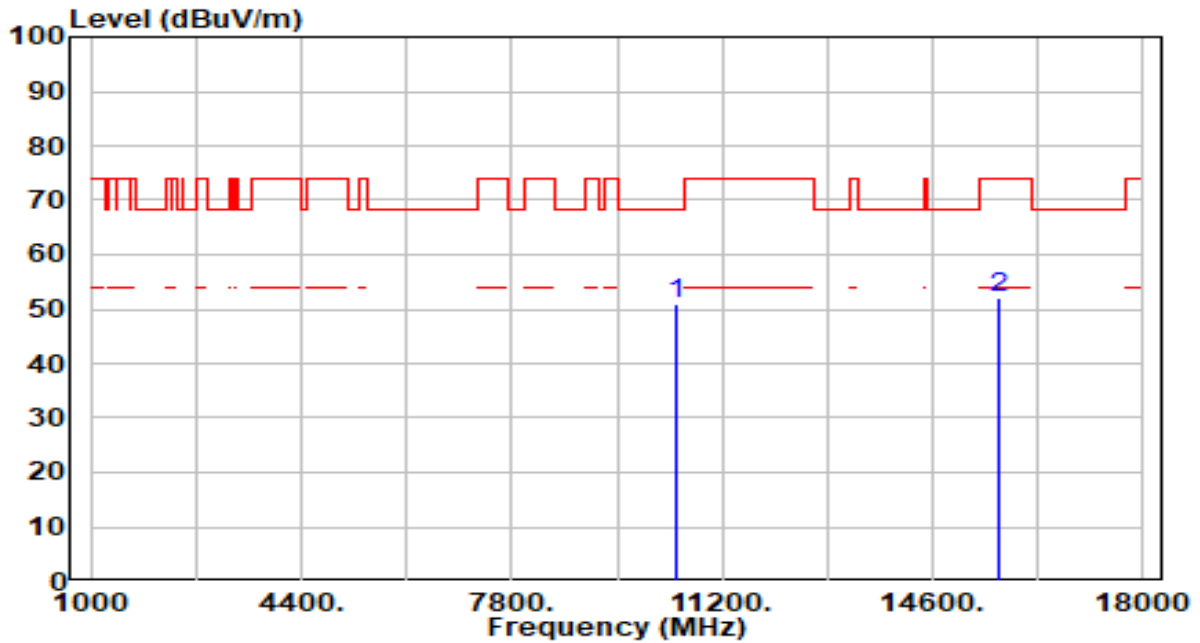

No	Frequency (MHz)	Reading (dBuV)	C.F (dB/m)	Measurement (dBuV/m)	Margin (dB)	Limit (dBuV/m)	Height (cm)	Angle (deg)	Remark (QP/PK/AV)
1	* 10460.000	46.20	4.74	50.94	-17.26	68.20	100	209	Peak
2	15690.000	45.58	6.33	51.90	-22.10	74.00	100	307	Peak

Note:

1. " *", means this data is the worst emission level.
2. C.F (Correction Factor) = Antenna Factor (dB/m)+ Cable Loss (dB) – Pre-amplifier(dB).
3. Measurement (dBuV/m) = Reading(dBuV) + C.F (Correction Factor).
4. The emission levels of other frequencies are very lower than the limit and not show in test report.

EUT	BE3600 Dual-Band Wi-Fi 7 Router	Date of Test	2024-02-06
Factor	DRH18-E	Temp. / Humidity	20°C /65%
Polarity	Vertical	Site / Test Engineer	AC2 / Marvin
Test Mode	802.11ac-40MHz_TX_Band1_CH 46_ANT 0+1	Test Voltage	AC 120V/60Hz

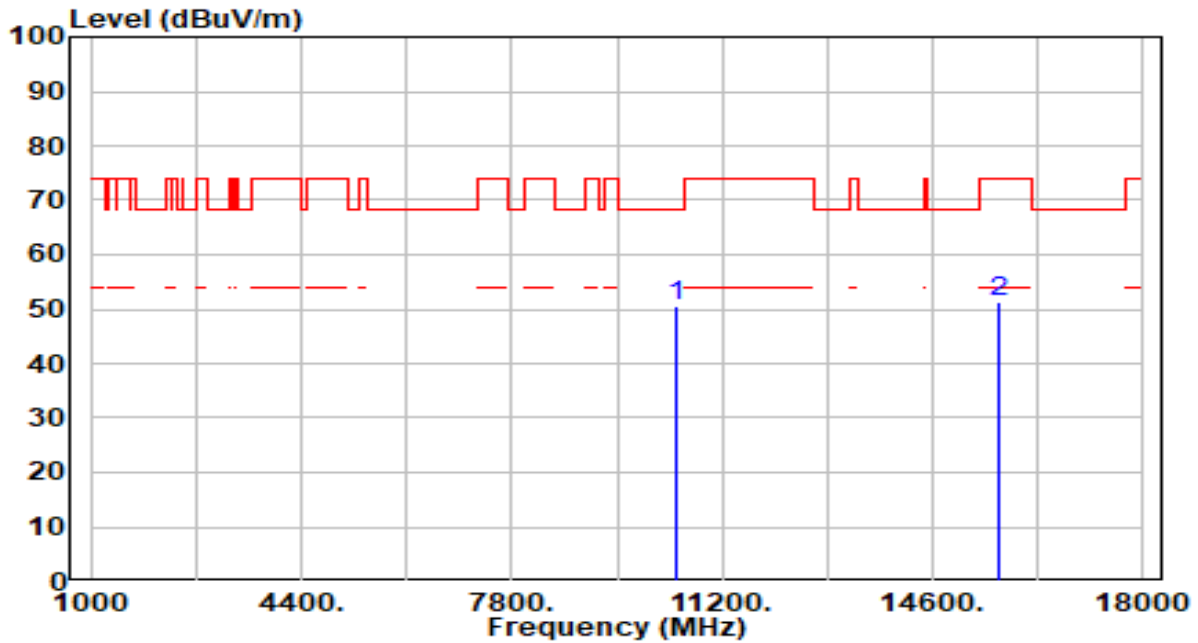

No	Frequency (MHz)	Reading (dBuV)	C.F (dB/m)	Measurement (dBuV/m)	Margin (dB)	Limit (dBuV/m)	Height (cm)	Angle (deg)	Remark (QP/PK/AV)
1	* 10460.000	45.73	4.74	50.47	-17.73	68.20	100	141	Peak
2	15690.000	45.08	6.33	51.41	-22.59	74.00	100	360	Peak

Note:

1. " *", means this data is the worst emission level.
2. C.F (Correction Factor) = Antenna Factor (dB/m)+ Cable Loss (dB) – Pre-amplifier(dB).
3. Measurement (dBuV/m) = Reading(dBuV) + C.F (Correction Factor).
4. The emission levels of other frequencies are very lower than the limit and not show in test report.

EUT	BE3600 Dual-Band Wi-Fi 7 Router	Date of Test	2024-02-06
Factor	DRH18-E	Temp. / Humidity	20°C /65%
Polarity	Horizontal	Site / Test Engineer	AC2 / Marvin
Test Mode	802.11ac-40MHz_TX_Band2_CH 54_ANT 0+1	Test Voltage	AC 120V/60Hz

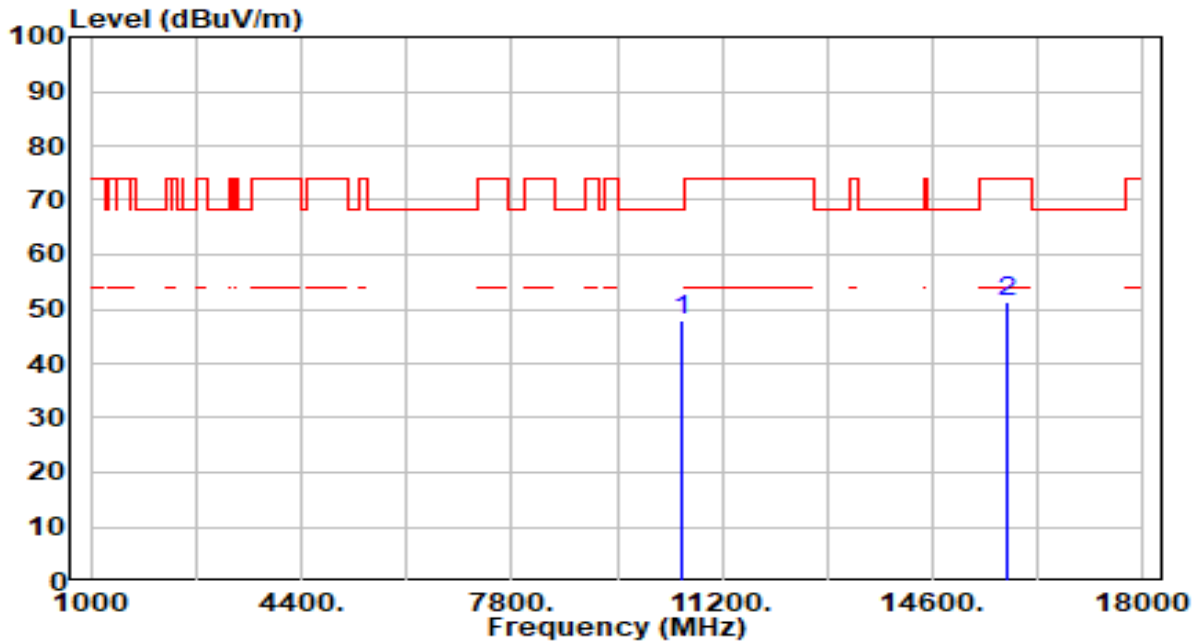

No	Frequency (MHz)	Reading (dBuV)	C.F (dB/m)	Measurement (dBuV/m)	Margin (dB)	Limit (dBuV/m)	Height (cm)	Angle (deg)	Remark (QP/PK/AV)
1	* 10540.000	43.22	4.66	47.88	-20.32	68.20	100	209	Peak
2	15810.000	44.76	6.55	51.31	-22.69	74.00	100	195	Peak

Note:

1. " *", means this data is the worst emission level.
2. C.F (Correction Factor) = Antenna Factor (dB/m)+ Cable Loss (dB) – Pre-amplifier(dB).
3. Measurement (dBuV/m) = Reading(dBuV) + C.F (Correction Factor).
4. The emission levels of other frequencies are very lower than the limit and not show in test report.

EUT	BE3600 Dual-Band Wi-Fi 7 Router	Date of Test	2024-02-06
Factor	DRH18-E	Temp. / Humidity	20°C /65%
Polarity	Vertical	Site / Test Engineer	AC2 / Marvin
Test Mode	802.11ac-40MHz_TX_Band2_CH 54_ANT 0+1	Test Voltage	AC 120V/60Hz

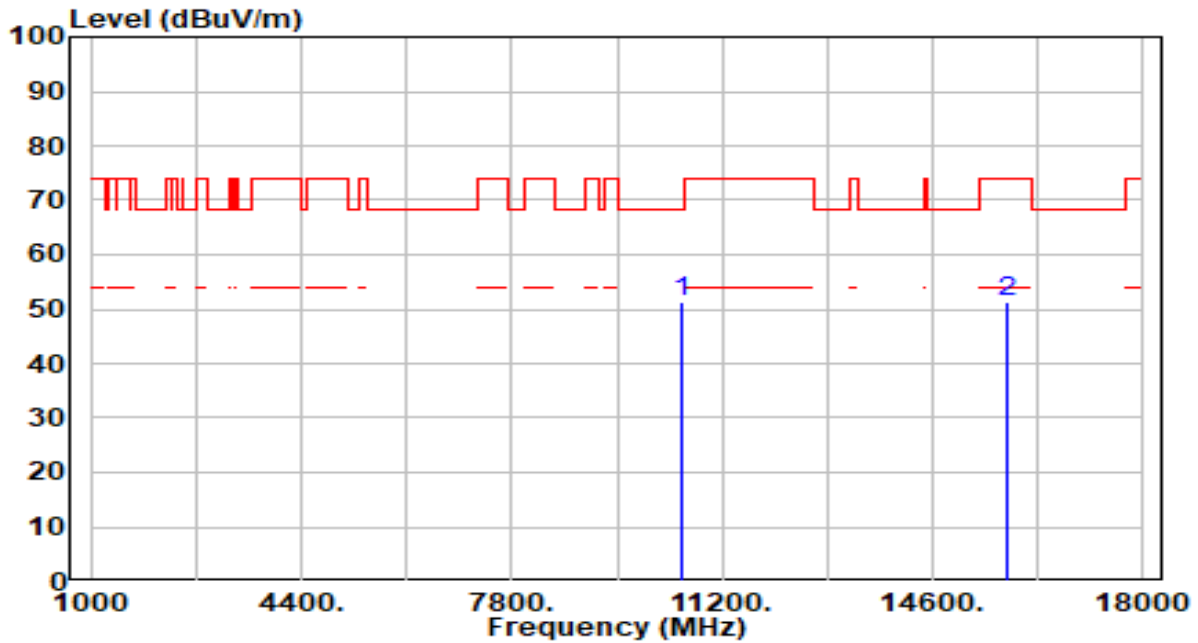

No	Frequency (MHz)	Reading (dBuV)	C.F (dB/m)	Measurement (dBuV/m)	Margin (dB)	Limit (dBuV/m)	Height (cm)	Angle (deg)	Remark (QP/PK/AV)
1	* 10540.000	46.52	4.66	51.18	-17.02	68.20	100	141	Peak
2	15810.000	44.73	6.55	51.28	-22.72	74.00	100	77	Peak

Note:

1. " *", means this data is the worst emission level.
2. C.F (Correction Factor) = Antenna Factor (dB/m)+ Cable Loss (dB) – Pre-amplifier(dB).
3. Measurement (dBuV/m) = Reading(dBuV) + C.F (Correction Factor).
4. The emission levels of other frequencies are very lower than the limit and not show in test report.

EUT	BE3600 Dual-Band Wi-Fi 7 Router	Date of Test	2024-02-06
Factor	DRH18-E	Temp. / Humidity	20°C /65%
Polarity	Horizontal	Site / Test Engineer	AC2 / Marvin
Test Mode	802.11ac-40MHz_TX_Band2_CH 62_ANT 0+1	Test Voltage	AC 120V/60Hz

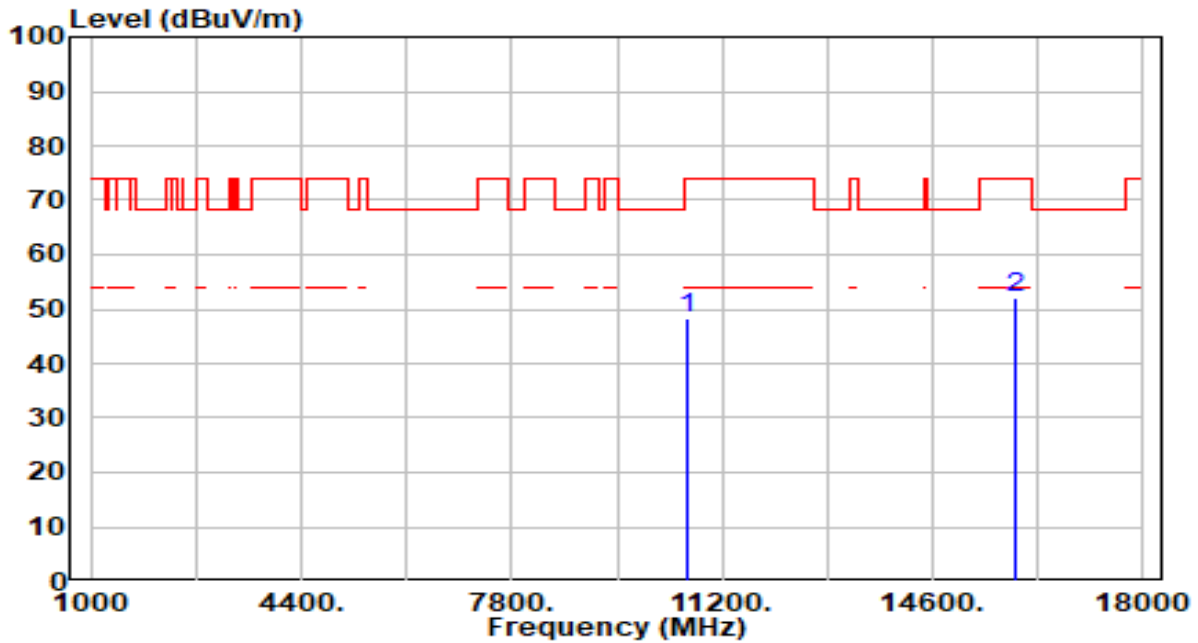

No	Frequency (MHz)	Reading (dBuV)	C.F (dB/m)	Measurement (dBuV/m)	Margin (dB)	Limit (dBuV/m)	Height (cm)	Angle (deg)	Remark (QP/PK/AV)
1	10620.000	43.79	4.62	48.40	-25.60	74.00	100	214	Peak
2	* 15930.000	45.34	6.55	51.89	-22.11	74.00	100	29	Peak

Note:

- "*", means this data is the worst emission level.
- C.F (Correction Factor) = Antenna Factor (dB/m)+ Cable Loss (dB) – Pre-amplifier(dB).
- Measurement (dBuV/m) = Reading(dBuV) + C.F (Correction Factor).
- The emission levels of other frequencies are very lower than the limit and not show in test report.

EUT	BE3600 Dual-Band Wi-Fi 7 Router	Date of Test	2024-02-06
Factor	DRH18-E	Temp. / Humidity	20°C /65%
Polarity	Vertical	Site / Test Engineer	AC2 / Marvin
Test Mode	802.11ac-40MHz_TX_Band2_CH 62_ANT 0+1	Test Voltage	AC 120V/60Hz

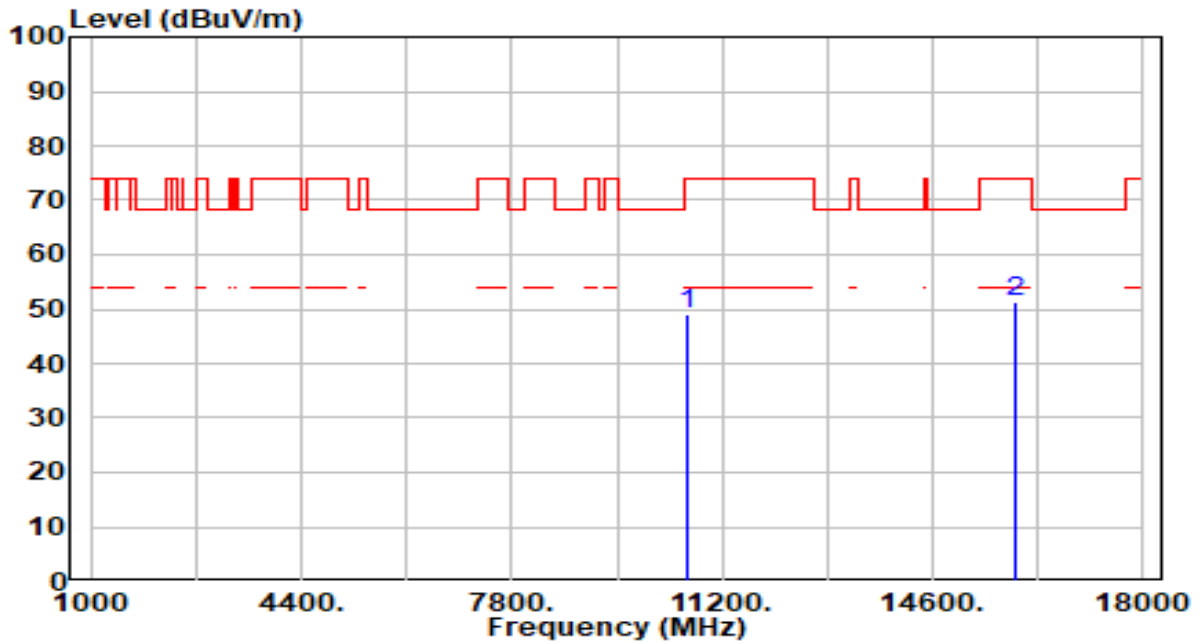

No	Frequency (MHz)	Reading (dBuV)	C.F (dB/m)	Measurement (dBuV/m)	Margin (dB)	Limit (dBuV/m)	Height (cm)	Angle (deg)	Remark (QP/PK/AV)
1	10620.000	44.31	4.62	48.93	-25.07	74.00	100	140	Peak
2	* 15930.000	44.77	6.55	51.31	-22.69	74.00	100	241	Peak

Note:

1. " *", means this data is the worst emission level.
2. C.F (Correction Factor) = Antenna Factor (dB/m)+ Cable Loss (dB) – Pre-amplifier(dB).
3. Measurement (dBuV/m) = Reading(dBuV) + C.F (Correction Factor).
4. The emission levels of other frequencies are very lower than the limit and not show in test report.

EUT	BE3600 Dual-Band Wi-Fi 7 Router	Date of Test	2024-02-06
Factor	DRH18-E	Temp. / Humidity	20°C /65%
Polarity	Horizontal	Site / Test Engineer	AC2 / Marvin
Test Mode	802.11ac-40MHz_TX_Band3_CH 102_ANT 0+1	Test Voltage	AC 120V/60Hz

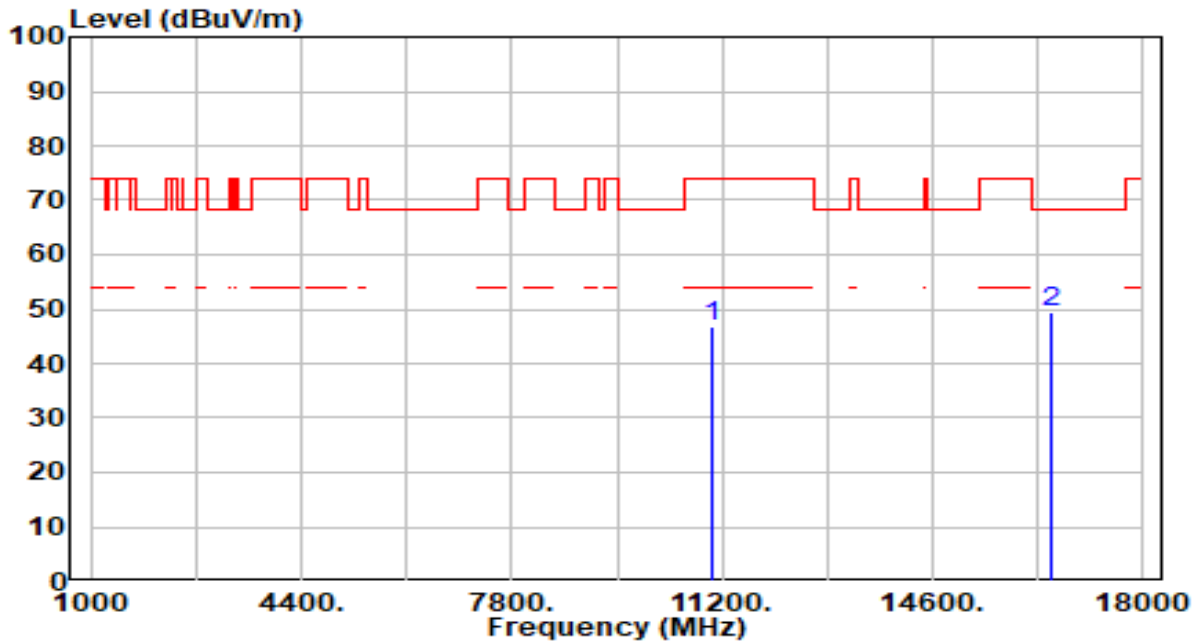

No	Frequency (MHz)	Reading (dBuV)	C.F (dB/m)	Measurement (dBuV/m)	Margin (dB)	Limit (dBuV/m)	Height (cm)	Angle (deg)	Remark (QP/PK/AV)
1	11020.000	42.27	4.57	46.85	-27.15	74.00	100	176	Peak
2	* 16530.000	43.43	6.10	49.53	-18.67	68.20	100	75	Peak

Note:

- "*", means this data is the worst emission level.
- C.F (Correction Factor) = Antenna Factor (dB/m)+ Cable Loss (dB) – Pre-amplifier(dB).
- Measurement (dBuV/m) = Reading(dBuV) + C.F (Correction Factor).
- The emission levels of other frequencies are very lower than the limit and not show in test report.

EUT	BE3600 Dual-Band Wi-Fi 7 Router	Date of Test	2024-02-06
Factor	DRH18-E	Temp. / Humidity	20°C /65%
Polarity	Vertical	Site / Test Engineer	AC2 / Marvin
Test Mode	802.11ac-40MHz_TX_Band3_CH 102_ANT 0+1	Test Voltage	AC 120V/60Hz

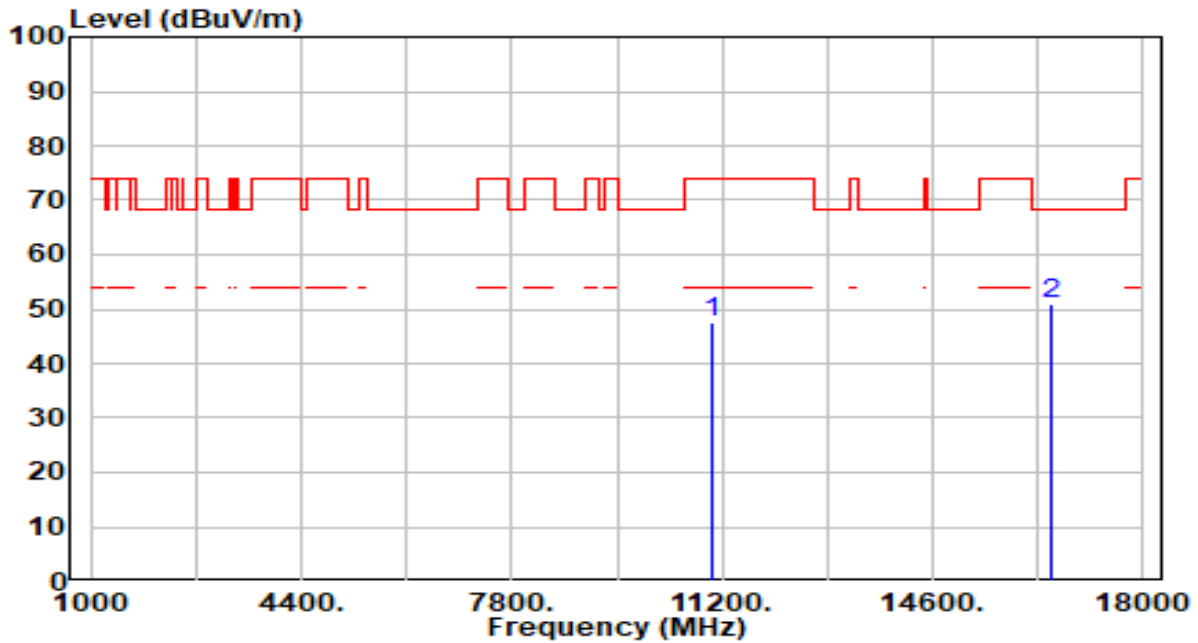

No	Frequency (MHz)	Reading (dBuV)	C.F (dB/m)	Measurement (dBuV/m)	Margin (dB)	Limit (dBuV/m)	Height (cm)	Angle (deg)	Remark (QP/PK/AV)
1	11020.000	43.05	4.57	47.62	-26.38	74.00	100	192	Peak
2	* 16530.000	44.69	6.10	50.79	-17.41	68.20	100	360	Peak

Note:

1. " *", means this data is the worst emission level.
2. C.F (Correction Factor) = Antenna Factor (dB/m)+ Cable Loss (dB) – Pre-amplifier(dB).
3. Measurement (dBuV/m) = Reading(dBuV) + C.F (Correction Factor).
4. The emission levels of other frequencies are very lower than the limit and not show in test report.

EUT	BE3600 Dual-Band Wi-Fi 7 Router	Date of Test	2024-02-06
Factor	DRH18-E	Temp. / Humidity	20°C /65%
Polarity	Horizontal	Site / Test Engineer	AC2 / Marvin
Test Mode	802.11ac-40MHz_TX_Band3_CH 110_ANT 0+1	Test Voltage	AC 120V/60Hz

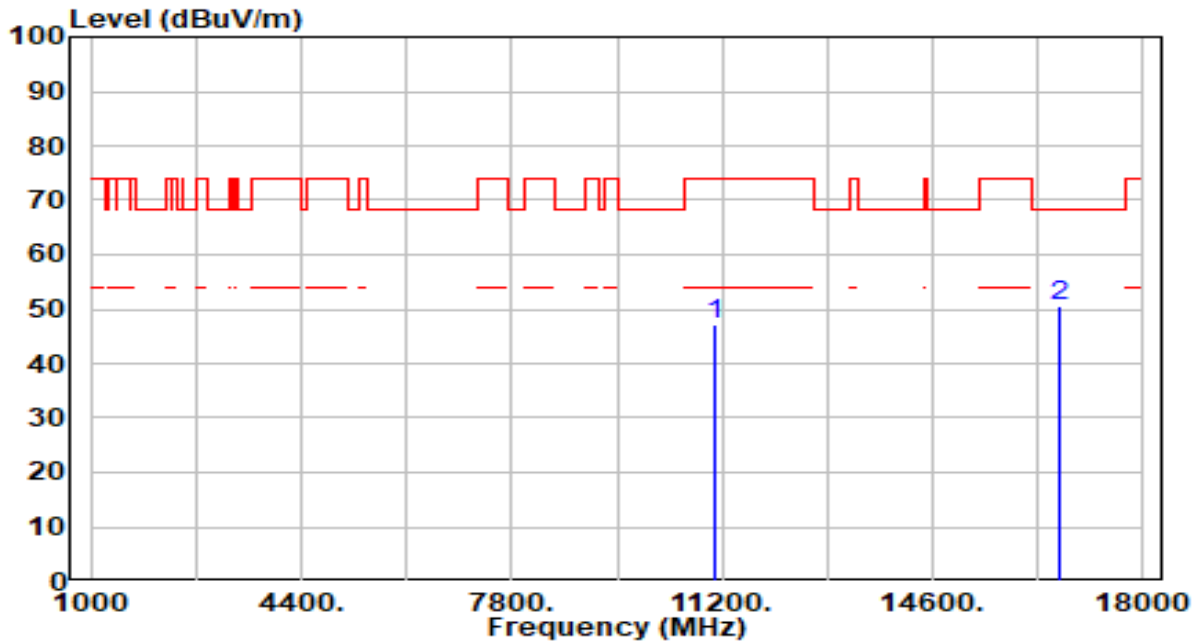

No	Frequency (MHz)	Reading (dBuV)	C.F (dB/m)	Measurement (dBuV/m)	Margin (dB)	Limit (dBuV/m)	Height (cm)	Angle (deg)	Remark (QP/PK/AV)
1	11100.000	42.50	4.78	47.28	-26.72	74.00	100	293	Peak
2	* 16650.000	44.51	6.14	50.65	-17.55	68.20	100	273	Peak

Note:

1. " *", means this data is the worst emission level.
2. C.F (Correction Factor) = Antenna Factor (dB/m)+ Cable Loss (dB) – Pre-amplifier(dB).
3. Measurement (dBuV/m) = Reading(dBuV) + C.F (Correction Factor).
4. The emission levels of other frequencies are very lower than the limit and not show in test report.

EUT	BE3600 Dual-Band Wi-Fi 7 Router	Date of Test	2024-02-06
Factor	DRH18-E	Temp. / Humidity	20°C /65%
Polarity	Vertical	Site / Test Engineer	AC2 / Marvin
Test Mode	802.11ac-40MHz_TX_Band3_CH 110_ANT 0+1	Test Voltage	AC 120V/60Hz

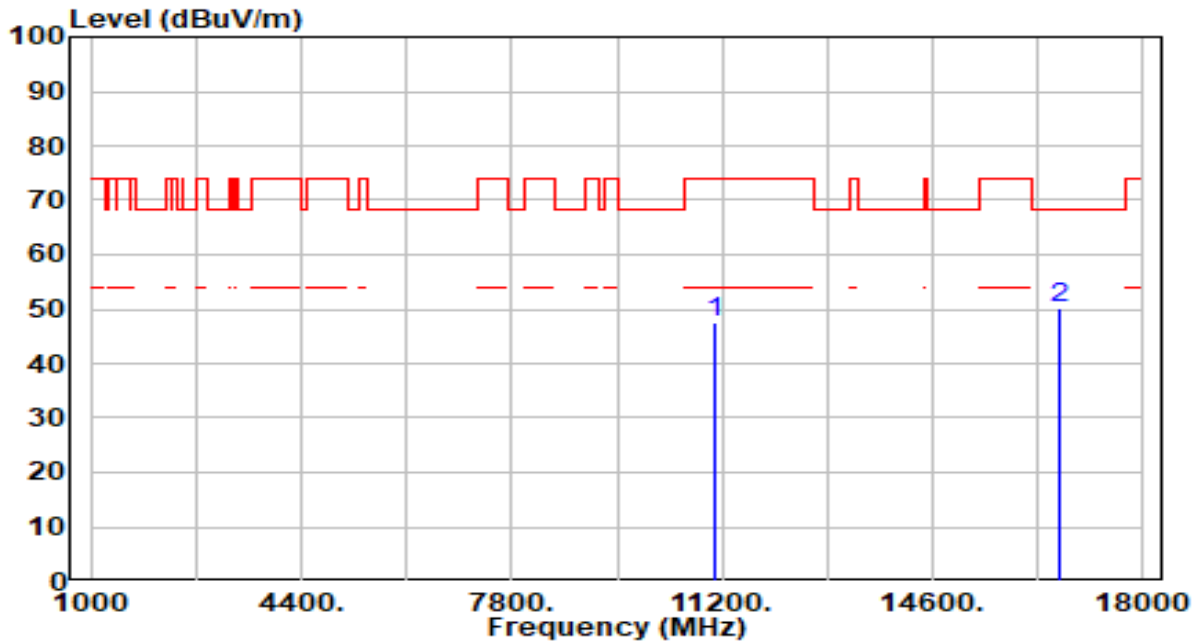

No	Frequency (MHz)	Reading (dBuV)	C.F (dB/m)	Measurement (dBuV/m)	Margin (dB)	Limit (dBuV/m)	Height (cm)	Angle (deg)	Remark (QP/PK/AV)
1	11100.000	42.72	4.78	47.50	-26.50	74.00	100	41	Peak
2	* 16650.000	44.11	6.14	50.24	-17.96	68.20	100	273	Peak

Note:

1. " *", means this data is the worst emission level.
2. C.F (Correction Factor) = Antenna Factor (dB/m)+ Cable Loss (dB) – Pre-amplifier(dB).
3. Measurement (dBuV/m) = Reading(dBuV) + C.F (Correction Factor).
4. The emission levels of other frequencies are very lower than the limit and not show in test report.

EUT	BE3600 Dual-Band Wi-Fi 7 Router	Date of Test	2024-02-06
Factor	DRH18-E	Temp. / Humidity	20°C /65%
Polarity	Horizontal	Site / Test Engineer	AC2 / Marvin
Test Mode	802.11ac-40MHz_TX_Band3_CH 134_ANT 0+1	Test Voltage	AC 120V/60Hz

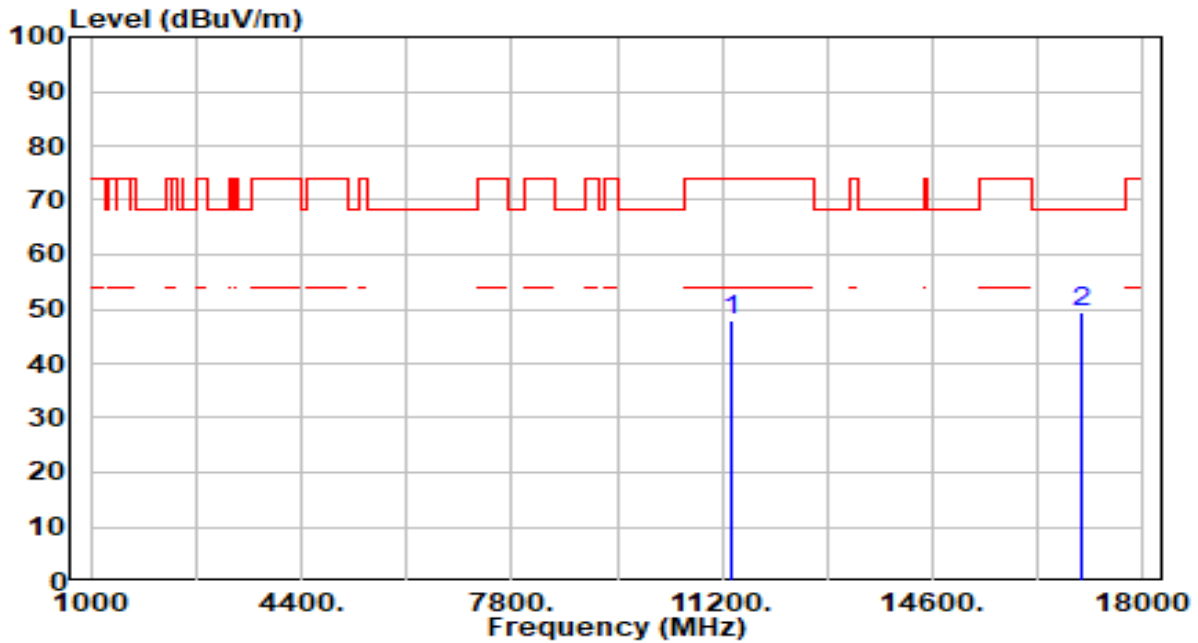

No	Frequency (MHz)	Reading (dBuV)	C.F (dB/m)	Measurement (dBuV/m)	Margin (dB)	Limit (dBuV/m)	Height (cm)	Angle (deg)	Remark (QP/PK/AV)
1	11340.000	42.65	5.20	47.85	-26.15	74.00	100	299	Peak
2	* 17010.000	43.32	6.12	49.45	-18.75	68.20	100	156	Peak

Note:

1. " *", means this data is the worst emission level.
2. C.F (Correction Factor) = Antenna Factor (dB/m)+ Cable Loss (dB) – Pre-amplifier(dB).
3. Measurement (dBuV/m) = Reading(dBuV) + C.F (Correction Factor).
4. The emission levels of other frequencies are very lower than the limit and not show in test report.

EUT	BE3600 Dual-Band Wi-Fi 7 Router	Date of Test	2024-02-06
Factor	DRH18-E	Temp. / Humidity	20°C /65%
Polarity	Vertical	Site / Test Engineer	AC2 / Marvin
Test Mode	802.11ac-40MHz_TX_Band3_CH 134_ANT 0+1	Test Voltage	AC 120V/60Hz

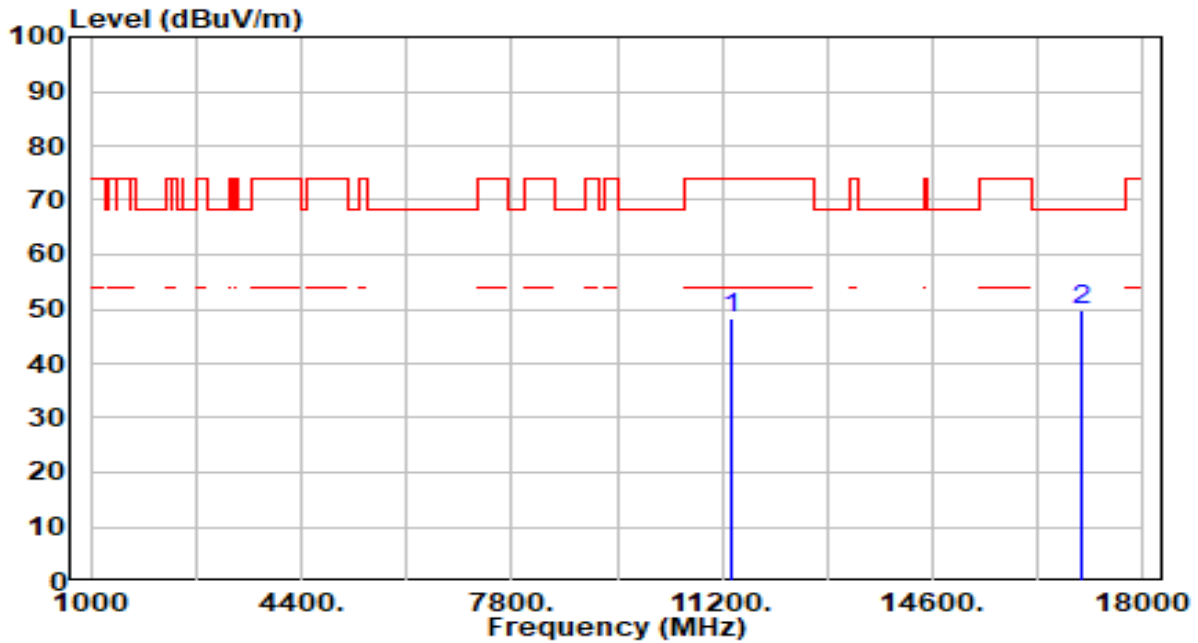

No	Frequency (MHz)	Reading (dBuV)	C.F (dB/m)	Measurement (dBuV/m)	Margin (dB)	Limit (dBuV/m)	Height (cm)	Angle (deg)	Remark (QP/PK/AV)
1	11340.000	43.15	5.20	48.34	-25.66	74.00	100	192	Peak
2	* 17010.000	43.85	6.12	49.97	-18.23	68.20	100	111	Peak

Note:

1. " *", means this data is the worst emission level.
2. C.F (Correction Factor) = Antenna Factor (dB/m)+ Cable Loss (dB) – Pre-amplifier(dB).
3. Measurement (dBuV/m) = Reading(dBuV) + C.F (Correction Factor).
4. The emission levels of other frequencies are very lower than the limit and not show in test report.

EUT	BE3600 Dual-Band Wi-Fi 7 Router	Date of Test	2024-02-06
Factor	DRH18-E	Temp. / Humidity	20°C /65%
Polarity	Horizontal	Site / Test Engineer	AC2 / Marvin
Test Mode	802.11ac-40MHz_TX_Band3_CH 142_ANT 0+1	Test Voltage	AC 120V/60Hz

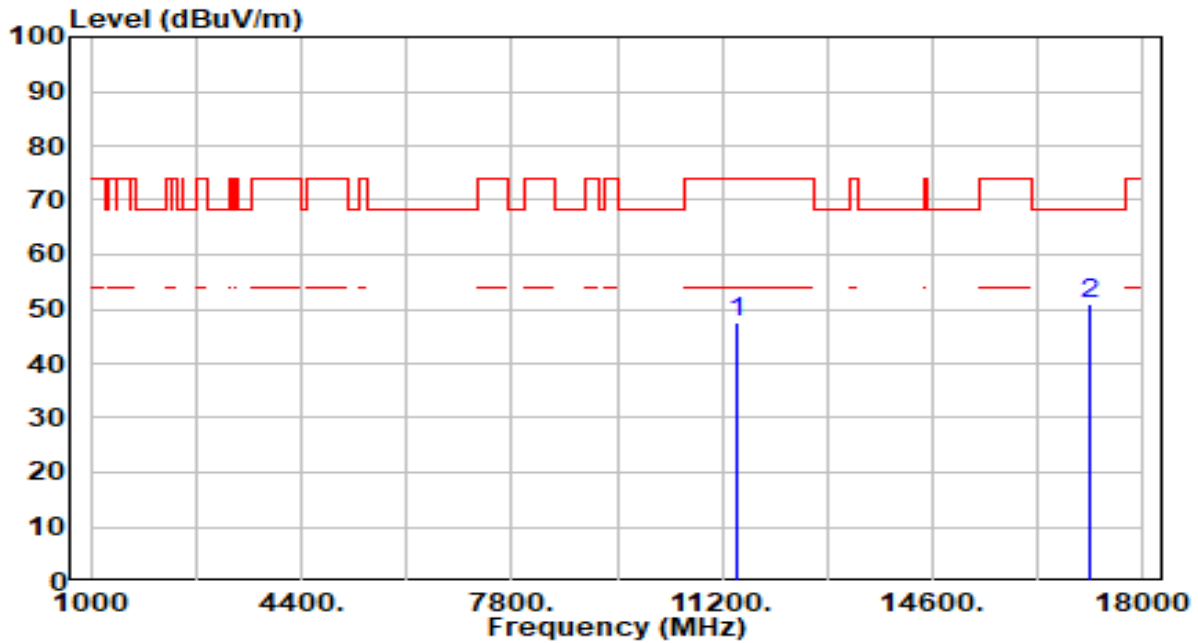

No	Frequency (MHz)	Reading (dBuV)	C.F (dB/m)	Measurement (dBuV/m)	Margin (dB)	Limit (dBuV/m)	Height (cm)	Angle (deg)	Remark (QP/PK/AV)
1	11420.000	42.39	5.28	47.67	-26.33	74.00	100	194	Peak
2	* 17130.000	45.02	5.92	50.94	-17.26	68.20	100	82	Peak

Note:

1. " *", means this data is the worst emission level.
2. C.F (Correction Factor) = Antenna Factor (dB/m)+ Cable Loss (dB) – Pre-amplifier(dB).
3. Measurement (dBuV/m) = Reading(dBuV) + C.F (Correction Factor).
4. The emission levels of other frequencies are very lower than the limit and not show in test report.

EUT	BE3600 Dual-Band Wi-Fi 7 Router	Date of Test	2024-02-06
Factor	DRH18-E	Temp. / Humidity	20°C /65%
Polarity	Vertical	Site / Test Engineer	AC2 / Marvin
Test Mode	802.11ac-40MHz_TX_Band3_CH 142_ANT 0+1	Test Voltage	AC 120V/60Hz

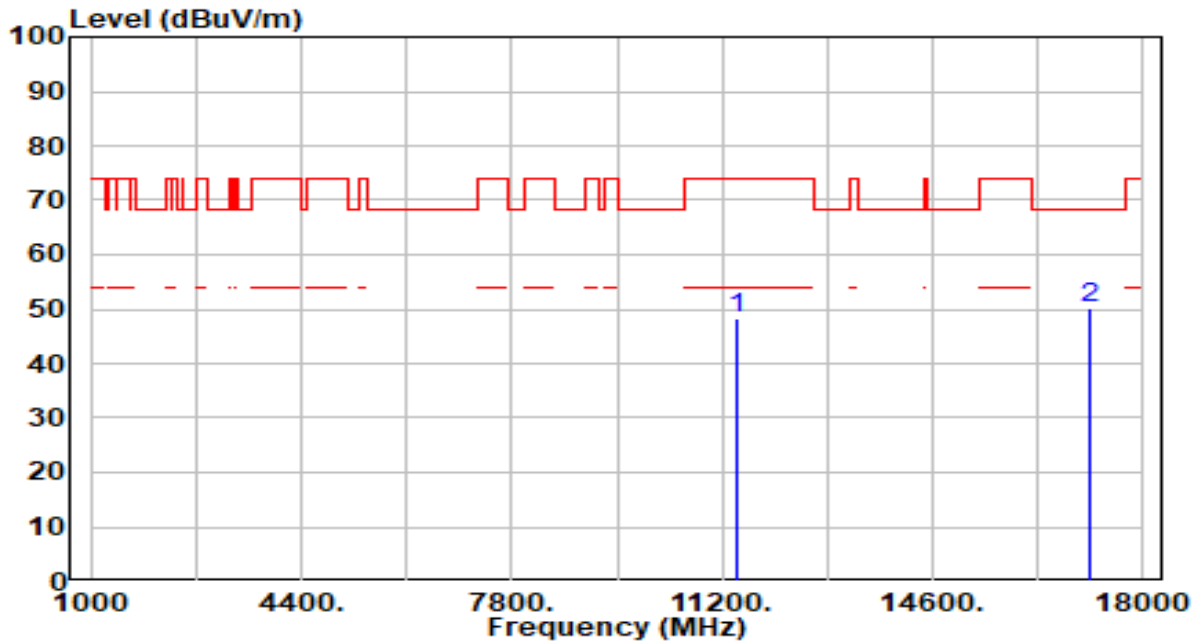

No	Frequency (MHz)	Reading (dBuV)	C.F (dB/m)	Measurement (dBuV/m)	Margin (dB)	Limit (dBuV/m)	Height (cm)	Angle (deg)	Remark (QP/PK/AV)
1	11420.000	42.92	5.28	48.19	-25.81	74.00	100	250	Peak
2	* 17130.000	44.31	5.92	50.24	-17.96	68.20	100	79	Peak

Note:

1. " *", means this data is the worst emission level.
2. C.F (Correction Factor) = Antenna Factor (dB/m)+ Cable Loss (dB) – Pre-amplifier(dB).
3. Measurement (dBuV/m) = Reading(dBuV) + C.F (Correction Factor).
4. The emission levels of other frequencies are very lower than the limit and not show in test report.

EUT	BE3600 Dual-Band Wi-Fi 7 Router	Date of Test	2024-02-06
Factor	DRH18-E	Temp. / Humidity	20°C /65%
Polarity	Horizontal	Site / Test Engineer	AC2 / Marvin
Test Mode	802.11ac-40MHz_TX_Band4_CH 151_ANT 0+1	Test Voltage	AC 120V/60Hz

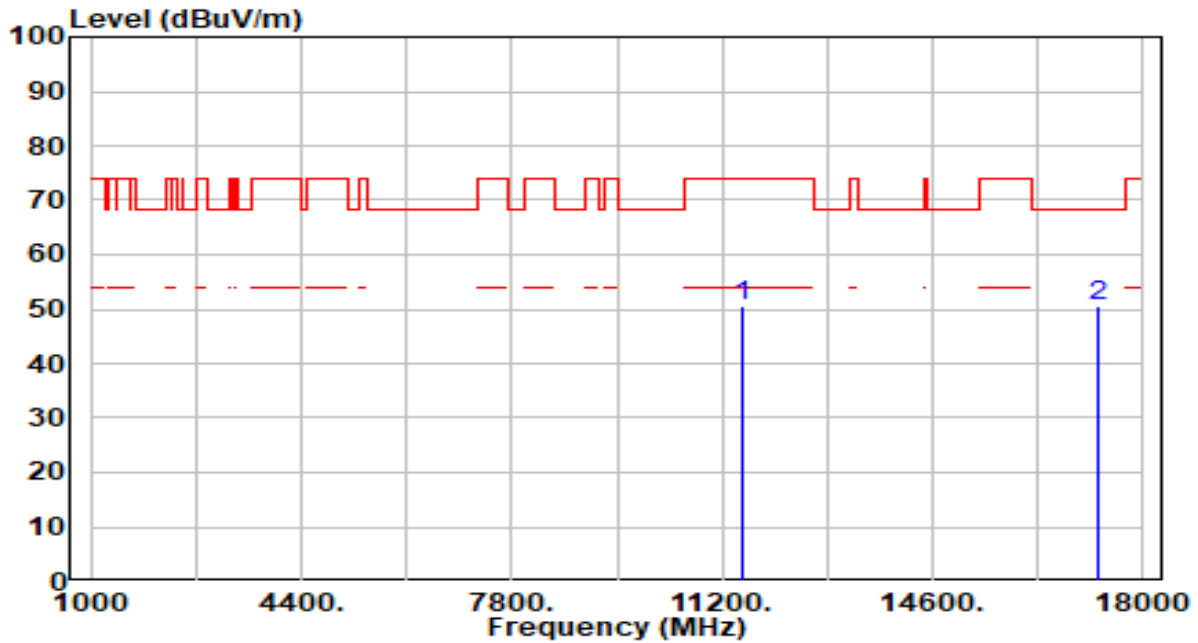

No	Frequency (MHz)	Reading (dBuV)	C.F (dB/m)	Measurement (dBuV/m)	Margin (dB)	Limit (dBuV/m)	Height (cm)	Angle (deg)	Remark (QP/PK/AV)
1	11510.000	45.07	5.33	50.40	-23.60	74.00	100	356	Peak
2	* 17265.000	44.80	5.63	50.43	-17.77	68.20	100	267	Peak

Note:

1. " *", means this data is the worst emission level.
2. C.F (Correction Factor) = Antenna Factor (dB/m)+ Cable Loss (dB) – Pre-amplifier(dB).
3. Measurement (dBuV/m) = Reading(dBuV) + C.F (Correction Factor).
4. The emission levels of other frequencies are very lower than the limit and not show in test report.

EUT	BE3600 Dual-Band Wi-Fi 7 Router	Date of Test	2024-02-06
Factor	DRH18-E	Temp. / Humidity	20°C /65%
Polarity	Vertical	Site / Test Engineer	AC2 / Marvin
Test Mode	802.11ac-40MHz_TX_Band4_CH 151_ANT 0+1	Test Voltage	AC 120V/60Hz

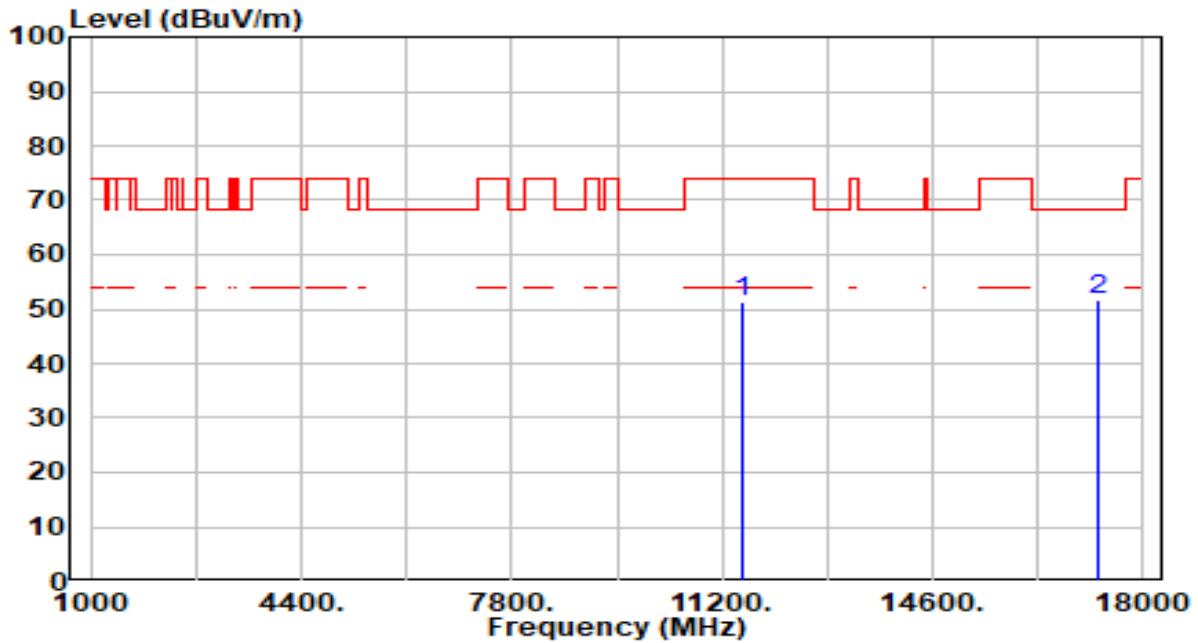

No	Frequency (MHz)	Reading (dBuV)	C.F (dB/m)	Measurement (dBuV/m)	Margin (dB)	Limit (dBuV/m)	Height (cm)	Angle (deg)	Remark (QP/PK/AV)
1	11510.000	46.00	5.33	51.34	-22.66	74.00	100	239	Peak
2	* 17265.000	46.00	5.63	51.63	-16.57	68.20	100	250	Peak

Note:

1. " *", means this data is the worst emission level.
2. C.F (Correction Factor) = Antenna Factor (dB/m)+ Cable Loss (dB) – Pre-amplifier(dB).
3. Measurement (dBuV/m) = Reading(dBuV) + C.F (Correction Factor).
4. The emission levels of other frequencies are very lower than the limit and not show in test report.

EUT	BE3600 Dual-Band Wi-Fi 7 Router	Date of Test	2024-02-06
Factor	DRH18-E	Temp. / Humidity	20°C /65%
Polarity	Horizontal	Site / Test Engineer	AC2 / Marvin
Test Mode	802.11ac-40MHz_TX_Band4_CH 159_ANT 0+1	Test Voltage	AC 120V/60Hz

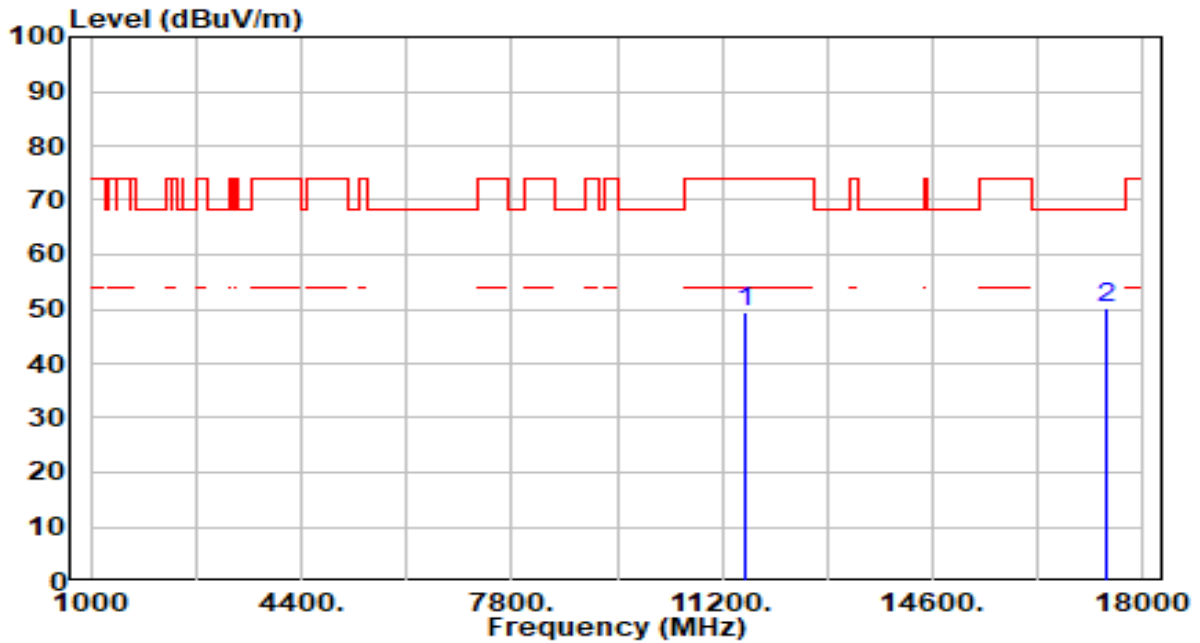

No	Frequency (MHz)	Reading (dBuV)	C.F (dB/m)	Measurement (dBuV/m)	Margin (dB)	Limit (dBuV/m)	Height (cm)	Angle (deg)	Remark (QP/PK/AV)
1	11590.000	43.87	5.39	49.26	-24.74	74.00	100	198	Peak
2	* 17385.000	44.88	5.31	50.19	-18.01	68.20	100	47	Peak

Note:

1. " *", means this data is the worst emission level.
2. C.F (Correction Factor) = Antenna Factor (dB/m)+ Cable Loss (dB) – Pre-amplifier(dB).
3. Measurement (dBuV/m) = Reading(dBuV) + C.F (Correction Factor).
4. The emission levels of other frequencies are very lower than the limit and not show in test report.

EUT	BE3600 Dual-Band Wi-Fi 7 Router	Date of Test	2024-02-06
Factor	DRH18-E	Temp. / Humidity	20°C /65%
Polarity	Vertical	Site / Test Engineer	AC2 / Marvin
Test Mode	802.11ac-40MHz_TX_Band4_CH 159_ANT 0+1	Test Voltage	AC 120V/60Hz

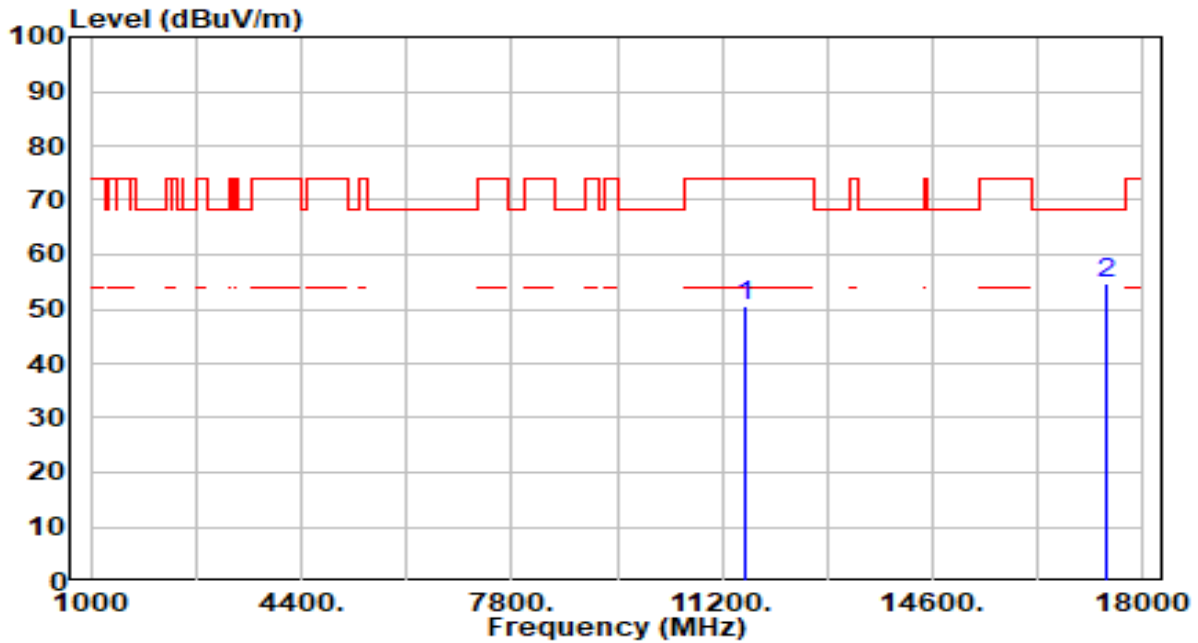

No	Frequency (MHz)	Reading (dBuV)	C.F (dB/m)	Measurement (dBuV/m)	Margin (dB)	Limit (dBuV/m)	Height (cm)	Angle (deg)	Remark (QP/PK/AV)
1	11590.000	45.09	5.39	50.48	-23.52	74.00	100	67	Peak
2	* 17385.000	49.33	5.31	54.64	-13.56	68.20	100	250	Peak

Note:

1. " *", means this data is the worst emission level.
2. C.F (Correction Factor) = Antenna Factor (dB/m)+ Cable Loss (dB) – Pre-amplifier(dB).
3. Measurement (dBuV/m) = Reading(dBuV) + C.F (Correction Factor).
4. The emission levels of other frequencies are very lower than the limit and not show in test report.

EUT	BE3600 Dual-Band Wi-Fi 7 Router	Date of Test	2024-02-06
Factor	DRH18-E	Temp. / Humidity	20°C /65%
Polarity	Horizontal	Site / Test Engineer	AC2 / Marvin
Test Mode	802.11ac-80MHz_TX_Band1_CH 42_ANT 0+1	Test Voltage	AC 120V/60Hz

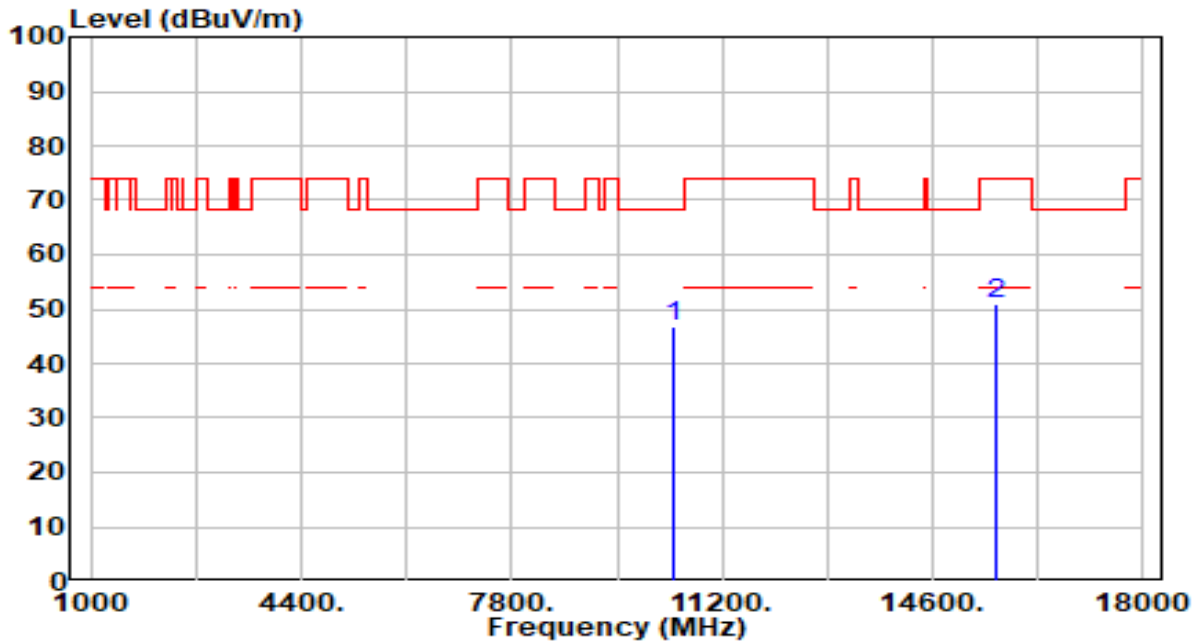

No	Frequency (MHz)	Reading (dBuV)	C.F (dB/m)	Measurement (dBuV/m)	Margin (dB)	Limit (dBuV/m)	Height (cm)	Angle (deg)	Remark (QP/PK/AV)
1	* 10420.000	41.93	4.79	46.72	-21.48	68.20	100	0	Peak
2	15630.000	44.60	6.21	50.81	-23.19	74.00	100	55	Peak

Note:

1. " *", means this data is the worst emission level.
2. C.F (Correction Factor) = Antenna Factor (dB/m)+ Cable Loss (dB) – Pre-amplifier(dB).
3. Measurement (dBuV/m) = Reading(dBuV) + C.F (Correction Factor).
4. The emission levels of other frequencies are very lower than the limit and not show in test report.

EUT	BE3600 Dual-Band Wi-Fi 7 Router	Date of Test	2024-02-06
Factor	DRH18-E	Temp. / Humidity	20°C /65%
Polarity	Vertical	Site / Test Engineer	AC2 / Marvin
Test Mode	802.11ac-80MHz_TX_Band1_CH 42_ANT 0+1	Test Voltage	AC 120V/60Hz

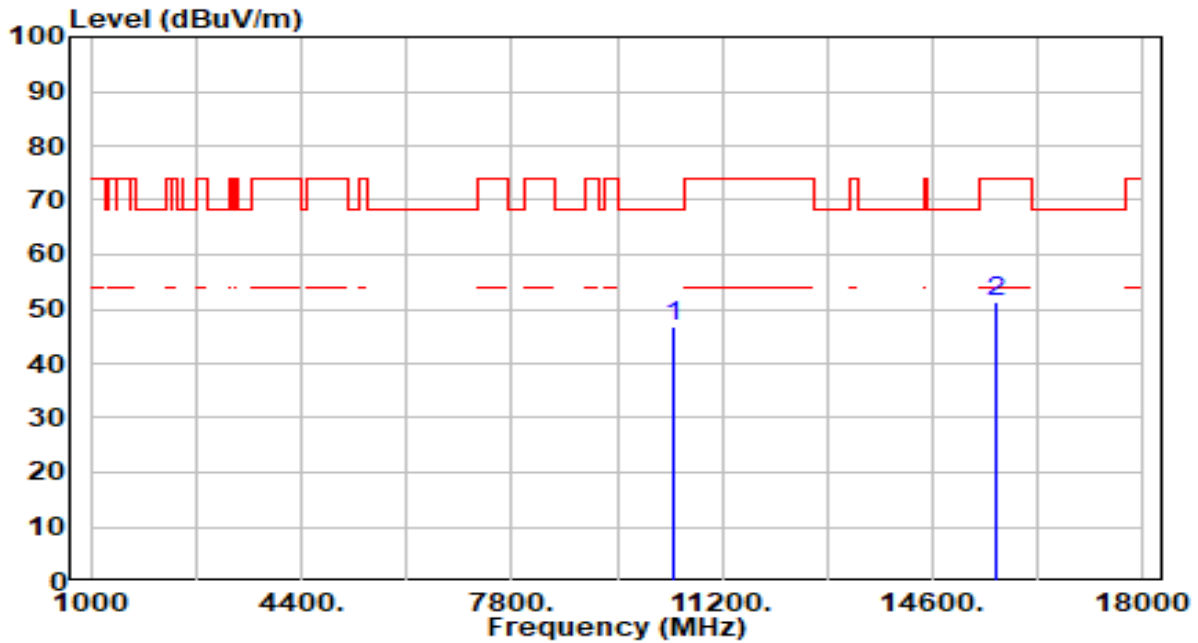

No	Frequency (MHz)	Reading (dBuV)	C.F (dB/m)	Measurement (dBuV/m)	Margin (dB)	Limit (dBuV/m)	Height (cm)	Angle (deg)	Remark (QP/PK/AV)
1	* 10420.000	42.13	4.79	46.92	-21.28	68.20	100	0	Peak
2	15630.000	45.29	6.21	51.50	-22.50	74.00	100	39	Peak

Note:

1. " *", means this data is the worst emission level.
2. C.F (Correction Factor) = Antenna Factor (dB/m)+ Cable Loss (dB) – Pre-amplifier(dB).
3. Measurement (dBuV/m) = Reading(dBuV) + C.F (Correction Factor).
4. The emission levels of other frequencies are very lower than the limit and not show in test report.

EUT	BE3600 Dual-Band Wi-Fi 7 Router	Date of Test	2024-02-06
Factor	DRH18-E	Temp. / Humidity	20°C /65%
Polarity	Horizontal	Site / Test Engineer	AC2 / Marvin
Test Mode	802.11ac-80MHz_TX_Band2_CH 58_ANT 0+1	Test Voltage	AC 120V/60Hz

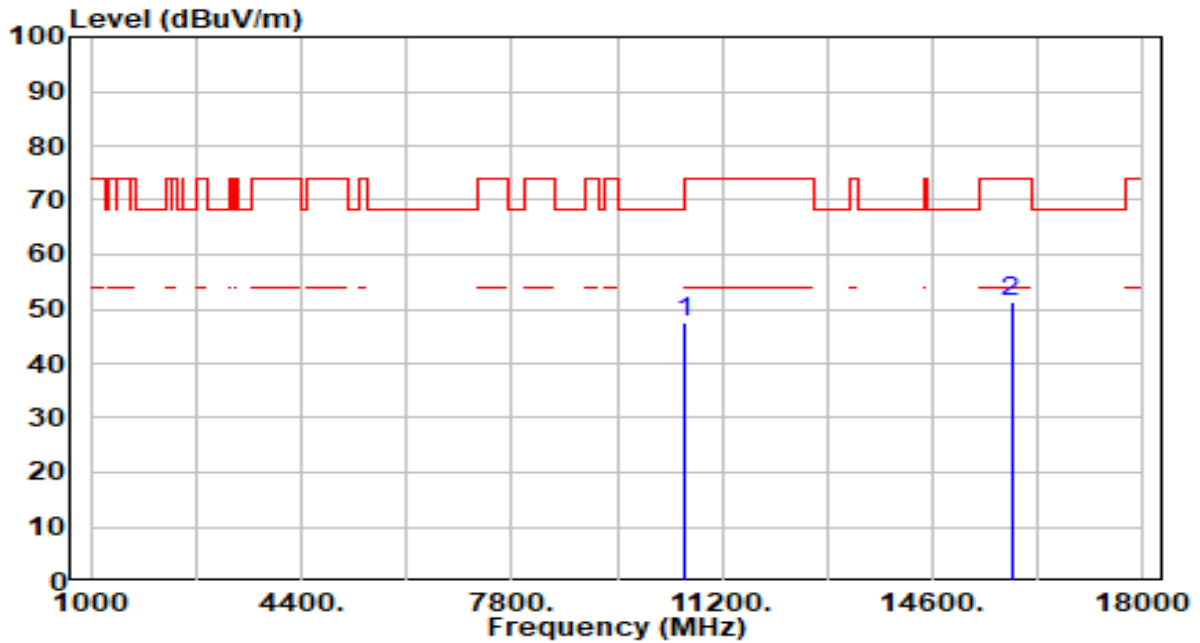

No	Frequency (MHz)	Reading (dBuV)	C.F (dB/m)	Measurement (dBuV/m)	Margin (dB)	Limit (dBuV/m)	Height (cm)	Angle (deg)	Remark (QP/PK/AV)
1	* 10580.000	42.82	4.63	47.44	-20.76	68.20	100	9	Peak
2	15870.000	44.68	6.55	51.22	-22.78	74.00	100	0	Peak

Note:

1. " *", means this data is the worst emission level.
2. C.F (Correction Factor) = Antenna Factor (dB/m)+ Cable Loss (dB) – Pre-amplifier(dB).
3. Measurement (dBuV/m) = Reading(dBuV) + C.F (Correction Factor).
4. The emission levels of other frequencies are very lower than the limit and not show in test report.

EUT	BE3600 Dual-Band Wi-Fi 7 Router	Date of Test	2024-02-06
Factor	DRH18-E	Temp. / Humidity	20°C /65%
Polarity	Vertical	Site / Test Engineer	AC2 / Marvin
Test Mode	802.11ac-80MHz_TX_Band2_CH 58_ANT 0+1	Test Voltage	AC 120V/60Hz

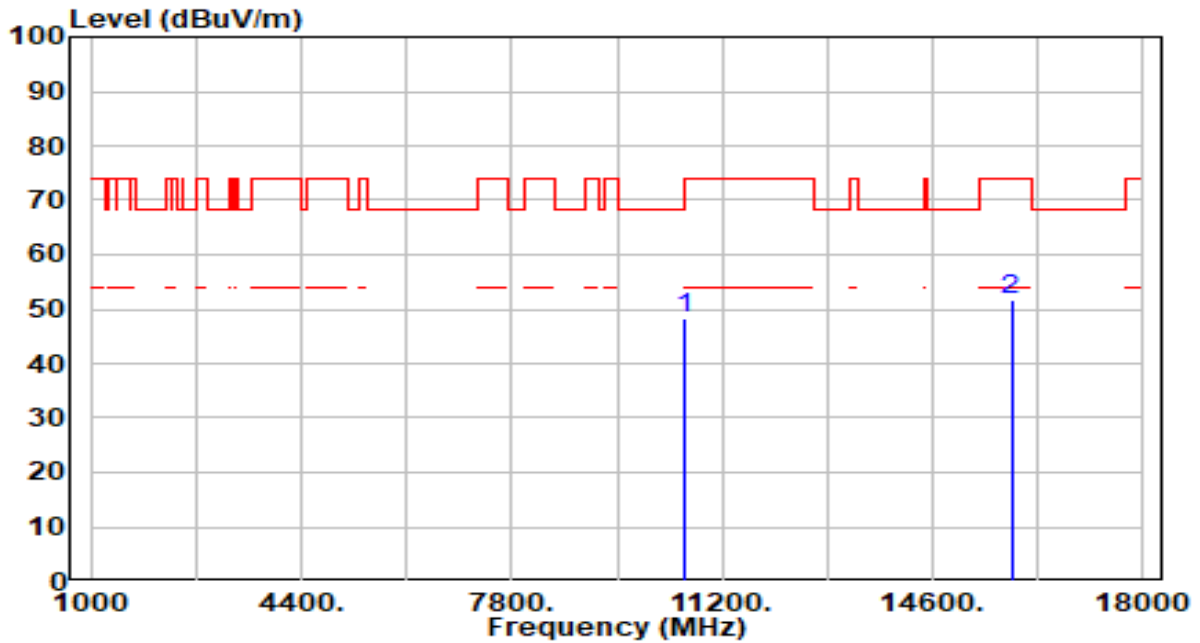

No	Frequency (MHz)	Reading (dBuV)	C.F (dB/m)	Measurement (dBuV/m)	Margin (dB)	Limit (dBuV/m)	Height (cm)	Angle (deg)	Remark (QP/PK/AV)
1	* 10580.000	43.70	4.63	48.33	-19.87	68.20	100	132	Peak
2	15870.000	45.18	6.55	51.73	-22.27	74.00	100	170	Peak

Note:

1. " *", means this data is the worst emission level.
2. C.F (Correction Factor) = Antenna Factor (dB/m)+ Cable Loss (dB) – Pre-amplifier(dB).
3. Measurement (dBuV/m) = Reading(dBuV) + C.F (Correction Factor).
4. The emission levels of other frequencies are very lower than the limit and not show in test report.

EUT	BE3600 Dual-Band Wi-Fi 7 Router	Date of Test	2024-02-06
Factor	DRH18-E	Temp. / Humidity	20°C /65%
Polarity	Horizontal	Site / Test Engineer	AC2 / Marvin
Test Mode	802.11ac-80MHz_TX_Band3_CH 106_ANT 0+1	Test Voltage	AC 120V/60Hz

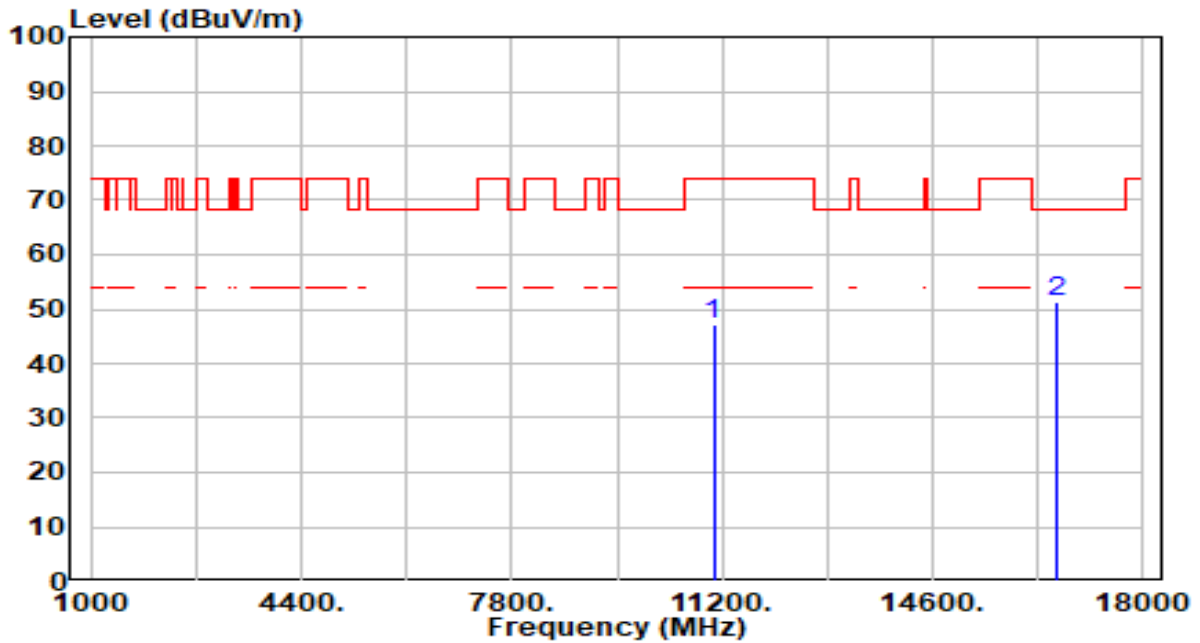

No	Frequency (MHz)	Reading (dBuV)	C.F (dB/m)	Measurement (dBuV/m)	Margin (dB)	Limit (dBuV/m)	Height (cm)	Angle (deg)	Remark (QP/PK/AV)
1	11060.000	42.32	4.68	47.00	-27.00	74.00	100	342	Peak
2	* 16590.000	45.10	6.11	51.21	-16.99	68.20	100	171	Peak

Note:

1. " *", means this data is the worst emission level.
2. C.F (Correction Factor) = Antenna Factor (dB/m)+ Cable Loss (dB) – Pre-amplifier(dB).
3. Measurement (dBuV/m) = Reading(dBuV) + C.F (Correction Factor).
4. The emission levels of other frequencies are very lower than the limit and not show in test report.

EUT	BE3600 Dual-Band Wi-Fi 7 Router	Date of Test	2024-02-06
Factor	DRH18-E	Temp. / Humidity	20°C /65%
Polarity	Vertical	Site / Test Engineer	AC2 / Marvin
Test Mode	802.11ac-80MHz_TX_Band3_CH 106_ANT 0+1	Test Voltage	AC 120V/60Hz

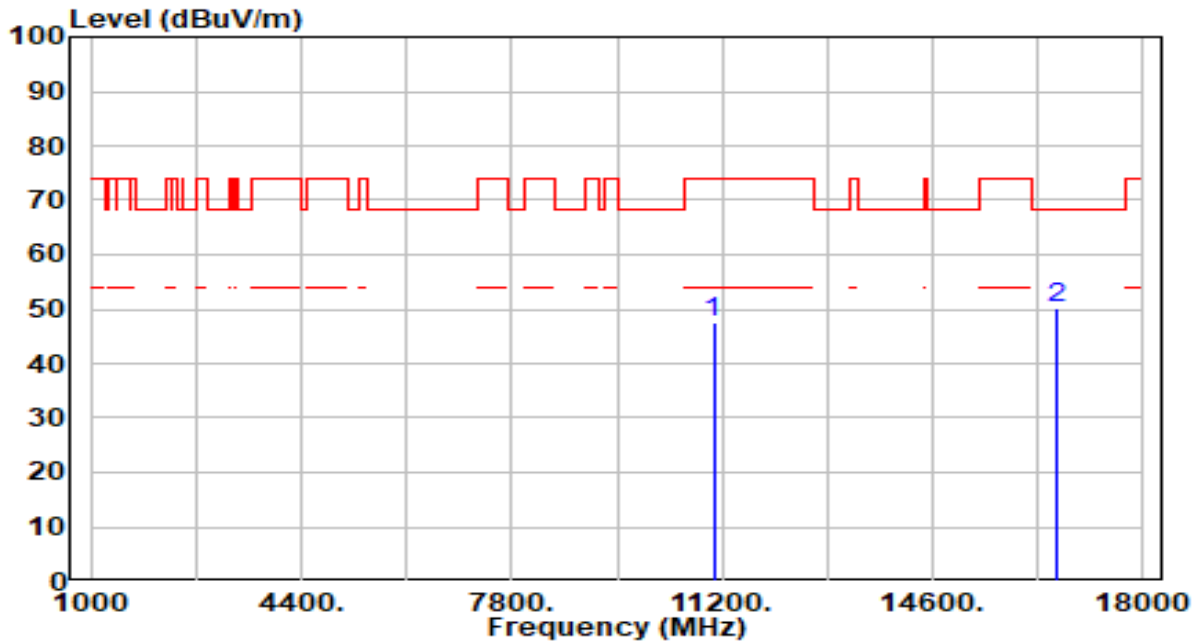

No	Frequency (MHz)	Reading (dBuV)	C.F (dB/m)	Measurement (dBuV/m)	Margin (dB)	Limit (dBuV/m)	Height (cm)	Angle (deg)	Remark (QP/PK/AV)
1	11060.000	42.77	4.68	47.45	-26.55	74.00	100	254	Peak
2	* 16590.000	44.04	6.11	50.14	-18.06	68.20	100	360	Peak

Note:

- "*", means this data is the worst emission level.
- C.F (Correction Factor) = Antenna Factor (dB/m)+ Cable Loss (dB) – Pre-amplifier(dB).
- Measurement (dBuV/m) = Reading(dBuV) + C.F (Correction Factor).
- The emission levels of other frequencies are very lower than the limit and not show in test report.

EUT	BE3600 Dual-Band Wi-Fi 7 Router	Date of Test	2024-02-06
Factor	DRH18-E	Temp. / Humidity	20°C /65%
Polarity	Horizontal	Site / Test Engineer	AC2 / Marvin
Test Mode	802.11ac-80MHz_TX_Band3_CH 122_ANT 0+1	Test Voltage	AC 120V/60Hz

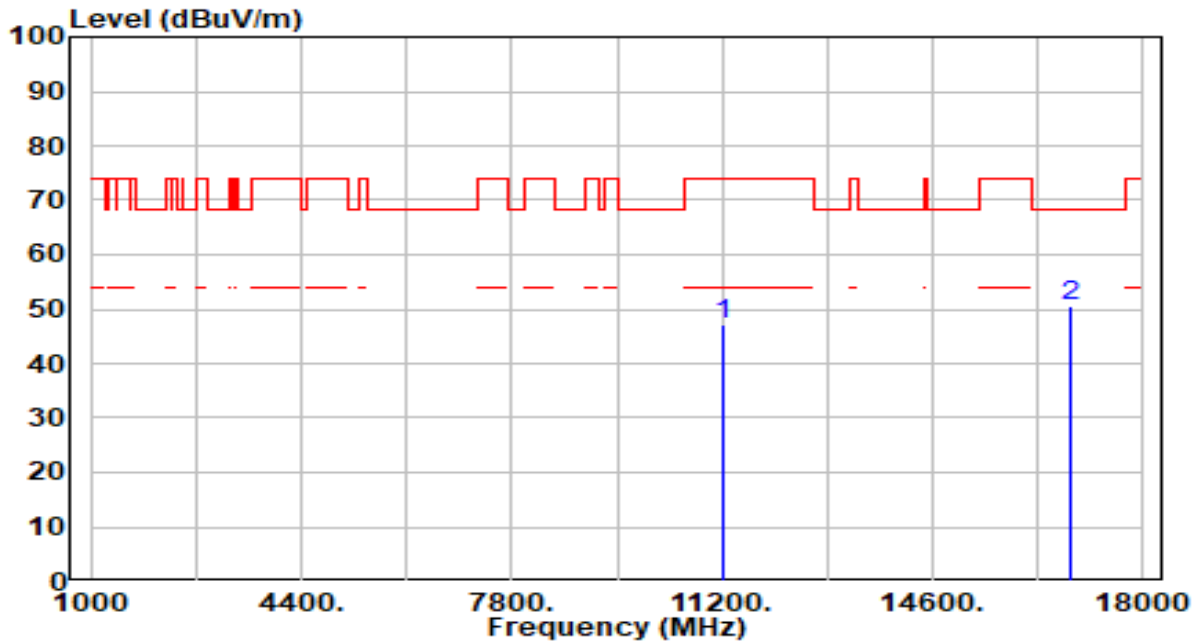

No	Frequency (MHz)	Reading (dBuV)	C.F (dB/m)	Measurement (dBuV/m)	Margin (dB)	Limit (dBuV/m)	Height (cm)	Angle (deg)	Remark (QP/PK/AV)
1	11220.000	42.16	5.06	47.22	-26.78	74.00	100	43	Peak
2	* 16830.000	44.36	6.21	50.57	-17.63	68.20	100	358	Peak

Note:

1. " *", means this data is the worst emission level.
2. C.F (Correction Factor) = Antenna Factor (dB/m)+ Cable Loss (dB) – Pre-amplifier(dB).
3. Measurement (dBuV/m) = Reading(dBuV) + C.F (Correction Factor).
4. The emission levels of other frequencies are very lower than the limit and not show in test report.

EUT	BE3600 Dual-Band Wi-Fi 7 Router	Date of Test	2024-02-06
Factor	DRH18-E	Temp. / Humidity	20°C /65%
Polarity	Vertical	Site / Test Engineer	AC2 / Marvin
Test Mode	802.11ac-80MHz_TX_Band3_CH 122_ANT 0+1	Test Voltage	AC 120V/60Hz

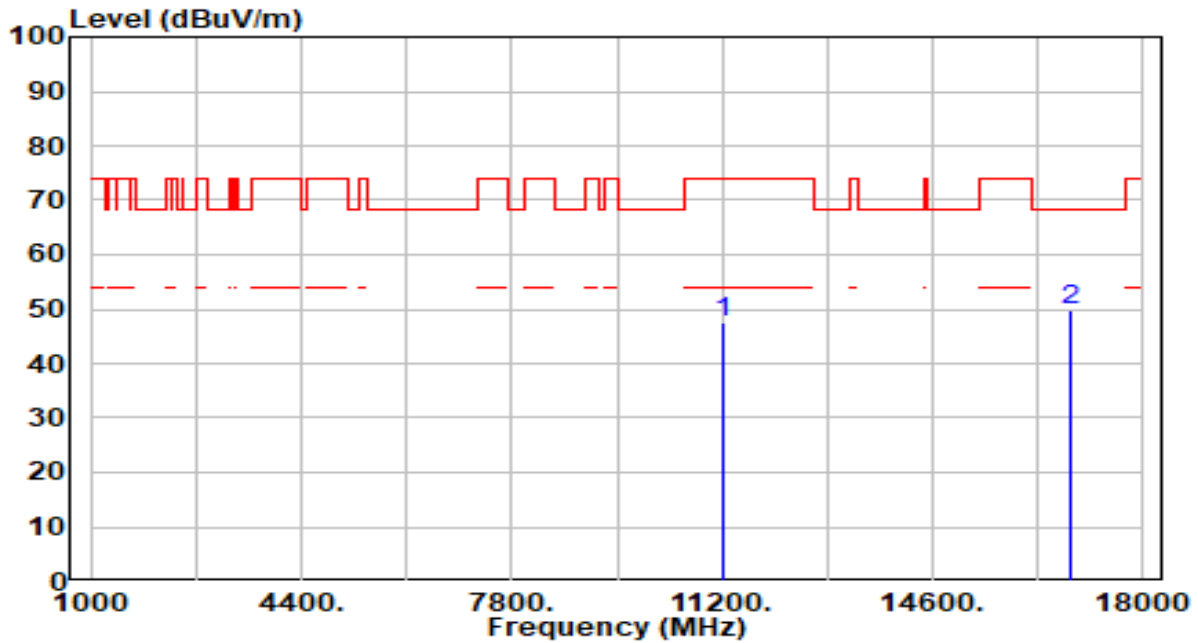

No	Frequency (MHz)	Reading (dBUV)	C.F (dB/m)	Measurement (dBUV/m)	Margin (dB)	Limit (dBUV/m)	Height (cm)	Angle (deg)	Remark (QP/PK/AV)
1	11220.000	42.62	5.06	47.69	-26.31	74.00	100	98	Peak
2	* 16830.000	43.45	6.21	49.66	-18.54	68.20	100	92	Peak

Note:

1. " *", means this data is the worst emission level.
2. C.F (Correction Factor) = Antenna Factor (dB/m)+ Cable Loss (dB) – Pre-amplifier(dB).
3. Measurement (dBUV/m) = Reading(dBUV) + C.F (Correction Factor).
4. The emission levels of other frequencies are very lower than the limit and not show in test report.

EUT	BE3600 Dual-Band Wi-Fi 7 Router	Date of Test	2024-02-06
Factor	DRH18-E	Temp. / Humidity	20°C /65%
Polarity	Horizontal	Site / Test Engineer	AC2 / Marvin
Test Mode	802.11ac-80MHz_TX_Band3_CH 138_ANT 0+1	Test Voltage	AC 120V/60Hz

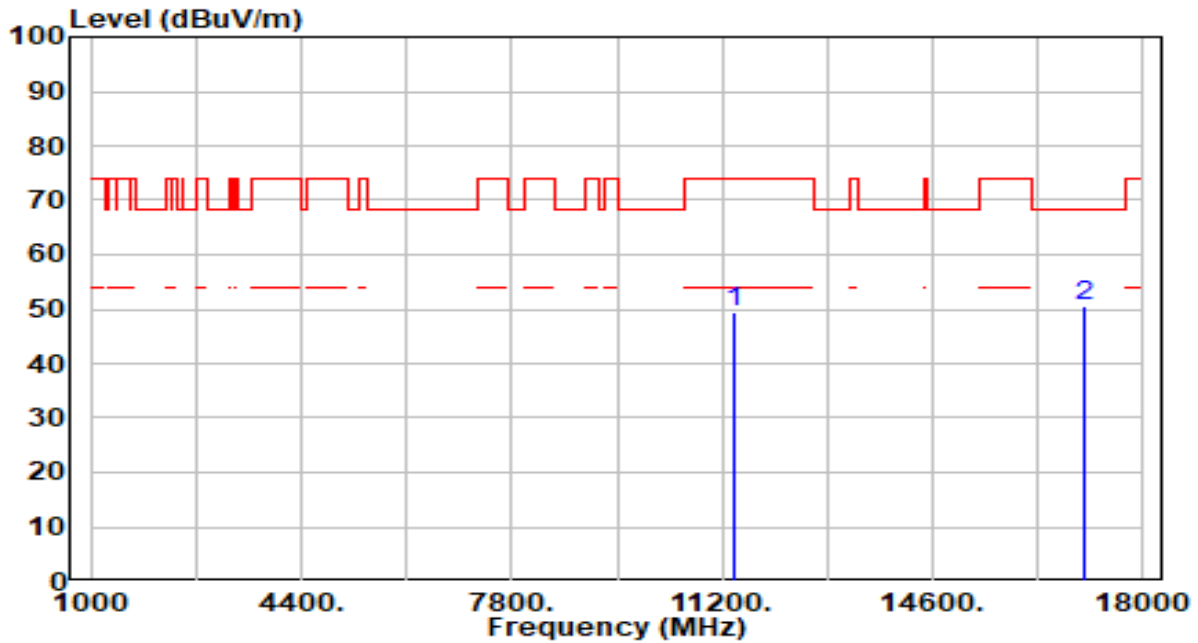

No	Frequency (MHz)	Reading (dBuV)	C.F (dB/m)	Measurement (dBuV/m)	Margin (dB)	Limit (dBuV/m)	Height (cm)	Angle (deg)	Remark (QP/PK/AV)
1	11380.000	44.29	5.24	49.53	-24.47	74.00	100	360	Peak
2	* 17070.000	44.65	6.02	50.67	-17.53	68.20	100	356	Peak

Note:

1. " *", means this data is the worst emission level.
2. C.F (Correction Factor) = Antenna Factor (dB/m)+ Cable Loss (dB) – Pre-amplifier(dB).
3. Measurement (dBuV/m) = Reading(dBuV) + C.F (Correction Factor).
4. The emission levels of other frequencies are very lower than the limit and not show in test report.

EUT	BE3600 Dual-Band Wi-Fi 7 Router	Date of Test	2024-02-06
Factor	DRH18-E	Temp. / Humidity	20°C /65%
Polarity	Vertical	Site / Test Engineer	AC2 / Marvin
Test Mode	802.11ac-80MHz_TX_Band3_CH 138_ANT 0+1	Test Voltage	AC 120V/60Hz

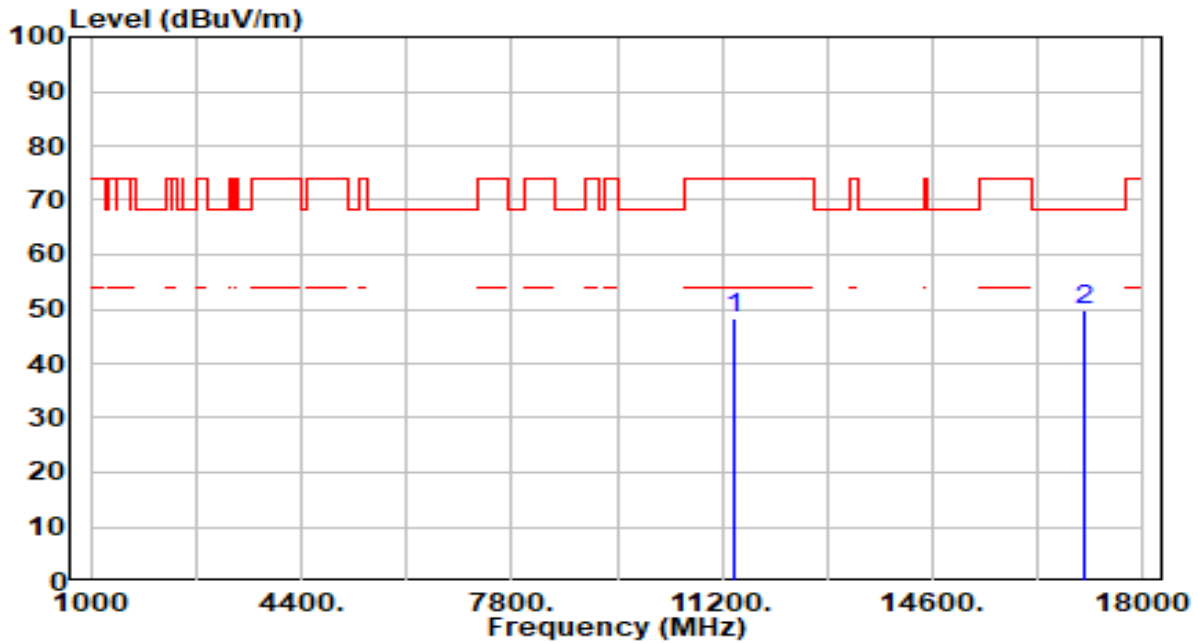

No	Frequency (MHz)	Reading (dBuV)	C.F (dB/m)	Measurement (dBuV/m)	Margin (dB)	Limit (dBuV/m)	Height (cm)	Angle (deg)	Remark (QP/PK/AV)
1	11380.000	43.04	5.24	48.28	-25.72	74.00	100	28	Peak
2	* 17070.000	43.83	6.02	49.86	-18.34	68.20	100	109	Peak

Note:

1. " *", means this data is the worst emission level.
2. C.F (Correction Factor) = Antenna Factor (dB/m)+ Cable Loss (dB) – Pre-amplifier(dB).
3. Measurement (dBuV/m) = Reading(dBuV) + C.F (Correction Factor).
4. The emission levels of other frequencies are very lower than the limit and not show in test report.

EUT	BE3600 Dual-Band Wi-Fi 7 Router	Date of Test	2024-02-06
Factor	DRH18-E	Temp. / Humidity	20°C /65%
Polarity	Horizontal	Site / Test Engineer	AC2 / Marvin
Test Mode	802.11ac-80MHz_TX_Band4_CH 155_ANT 0+1	Test Voltage	AC 120V/60Hz

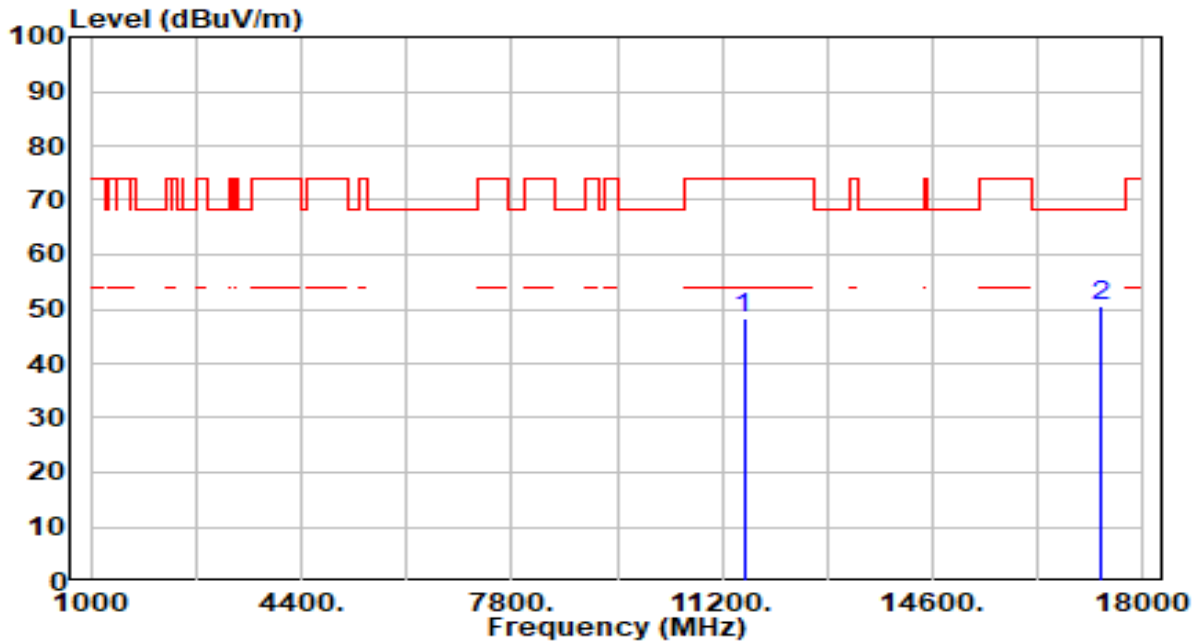

No	Frequency (MHz)	Reading (dBuV)	C.F (dB/m)	Measurement (dBuV/m)	Margin (dB)	Limit (dBuV/m)	Height (cm)	Angle (deg)	Remark (QP/PK/AV)
1	11550.000	42.82	5.36	48.18	-25.82	74.00	100	243	Peak
2	* 17325.000	44.92	5.47	50.38	-17.82	68.20	100	67	Peak

Note:

1. " *", means this data is the worst emission level.
2. C.F (Correction Factor) = Antenna Factor (dB/m)+ Cable Loss (dB) – Pre-amplifier(dB).
3. Measurement (dBuV/m) = Reading(dBuV) + C.F (Correction Factor).
4. The emission levels of other frequencies are very lower than the limit and not show in test report.

EUT	BE3600 Dual-Band Wi-Fi 7 Router	Date of Test	2024-02-06
Factor	DRH18-E	Temp. / Humidity	20°C /65%
Polarity	Vertical	Site / Test Engineer	AC2 / Marvin
Test Mode	802.11ac-80MHz_TX_Band4_CH 155_ANT 0+1	Test Voltage	AC 120V/60Hz

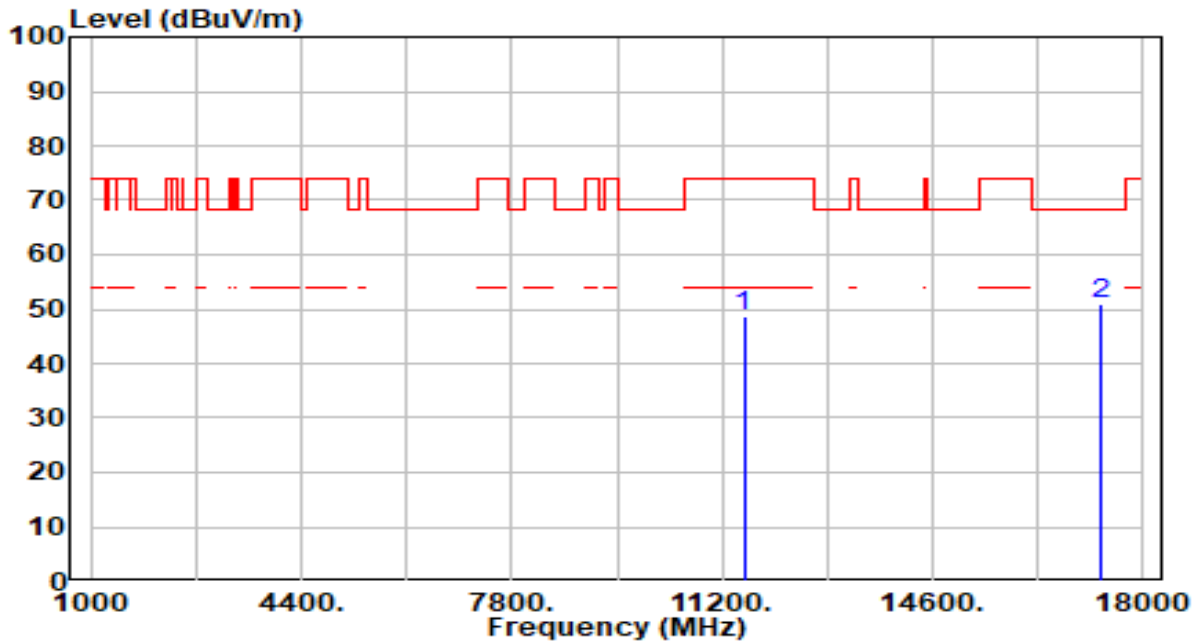

No	Frequency (MHz)	Reading (dBuV)	C.F (dB/m)	Measurement (dBuV/m)	Margin (dB)	Limit (dBuV/m)	Height (cm)	Angle (deg)	Remark (QP/PK/AV)
1	11550.000	43.20	5.36	48.56	-25.44	74.00	100	143	Peak
2	* 17325.000	45.57	5.47	51.04	-17.16	68.20	100	103	Peak

Note:

- "*", means this data is the worst emission level.
- C.F (Correction Factor) = Antenna Factor (dB/m)+ Cable Loss (dB) – Pre-amplifier(dB).
- Measurement (dBuV/m) = Reading(dBuV) + C.F (Correction Factor).
- The emission levels of other frequencies are very lower than the limit and not show in test report.

EUT	BE3600 Dual-Band Wi-Fi 7 Router	Date of Test	2024-02-06
Factor	DRH18-E	Temp. / Humidity	20°C /65%
Polarity	Horizontal	Site / Test Engineer	AC2 / Marvin
Test Mode	802.11ac-160MHz_TX_Band1,2_CH 50_ANT 0+1	Test Voltage	AC 120V/60Hz

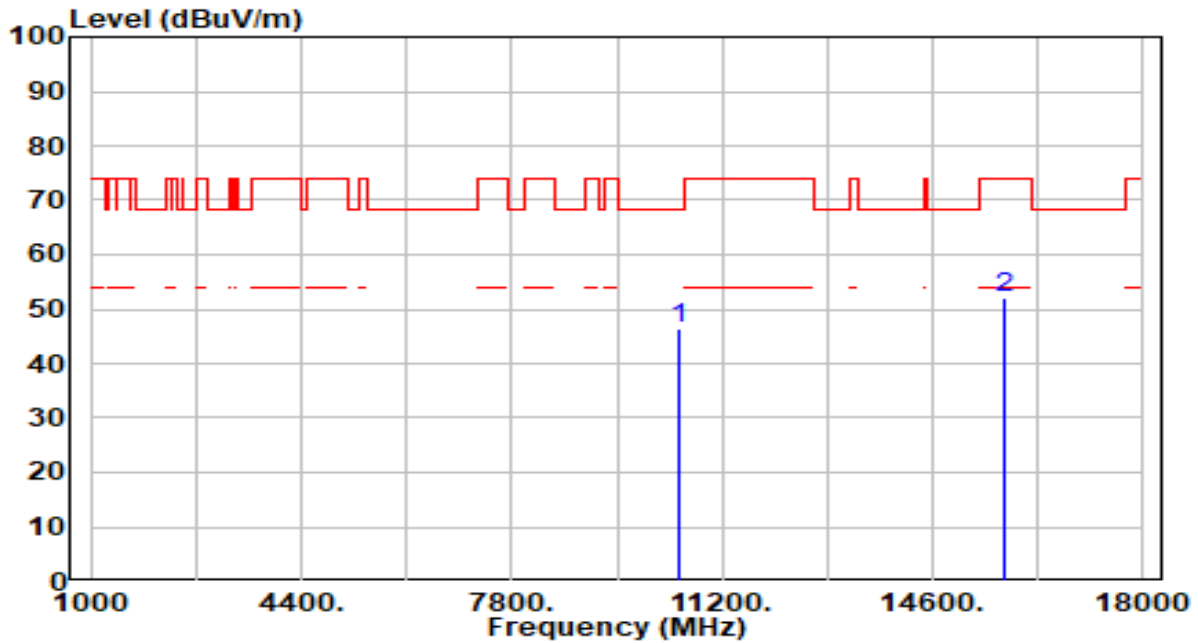

No	Frequency (MHz)	Reading (dBuV)	C.F (dB/m)	Measurement (dBuV/m)	Margin (dB)	Limit (dBuV/m)	Height (cm)	Angle (deg)	Remark (QP/PK/AV)
1	* 10500.000	41.81	4.68	46.49	-21.71	68.20	100	340	Peak
2	15750.000	45.80	6.45	52.24	-21.76	74.00	100	109	Peak

Note:

1. " *", means this data is the worst emission level.
2. C.F (Correction Factor) = Antenna Factor (dB/m)+ Cable Loss (dB) – Pre-amplifier(dB).
3. Measurement (dBuV/m) = Reading(dBuV) + C.F (Correction Factor).
4. The emission levels of other frequencies are very lower than the limit and not show in test report.

EUT	BE3600 Dual-Band Wi-Fi 7 Router	Date of Test	2024-02-06
Factor	DRH18-E	Temp. / Humidity	20°C /65%
Polarity	Vertical	Site / Test Engineer	AC2 / Marvin
Test Mode	802.11ac-160MHz_TX_Band1,2_CH 50_ANT 0+1	Test Voltage	AC 120V/60Hz

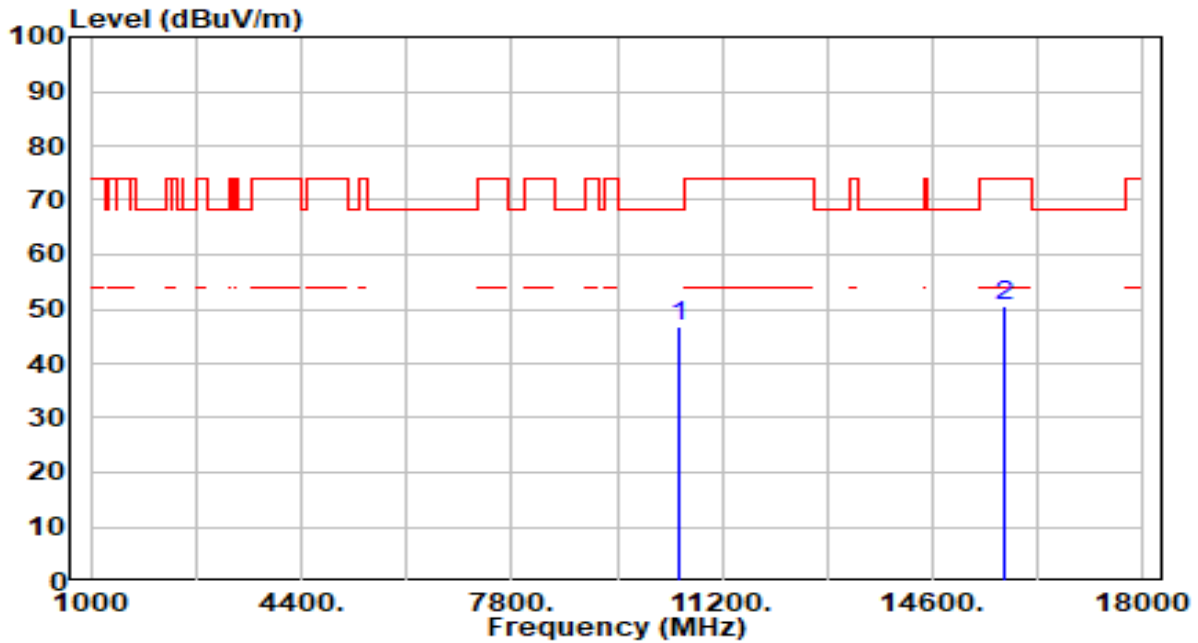

No	Frequency (MHz)	Reading (dBuV)	C.F (dB/m)	Measurement (dBuV/m)	Margin (dB)	Limit (dBuV/m)	Height (cm)	Angle (deg)	Remark (QP/PK/AV)
1	* 10500.000	42.19	4.68	46.87	-21.33	68.20	100	134	Peak
2	15750.000	44.19	6.45	50.64	-23.36	74.00	100	36	Peak

Note:

1. " *", means this data is the worst emission level.
2. C.F (Correction Factor) = Antenna Factor (dB/m)+ Cable Loss (dB) – Pre-amplifier(dB).
3. Measurement (dBuV/m) = Reading(dBuV) + C.F (Correction Factor).
4. The emission levels of other frequencies are very lower than the limit and not show in test report.

EUT	BE3600 Dual-Band Wi-Fi 7 Router	Date of Test	2024-02-06
Factor	DRH18-E	Temp. / Humidity	20°C /65%
Polarity	Horizontal	Site / Test Engineer	AC2 / Marvin
Test Mode	802.11ac-160MHz_TX_Band3_CH 114_ANT 0+1	Test Voltage	AC 120V/60Hz

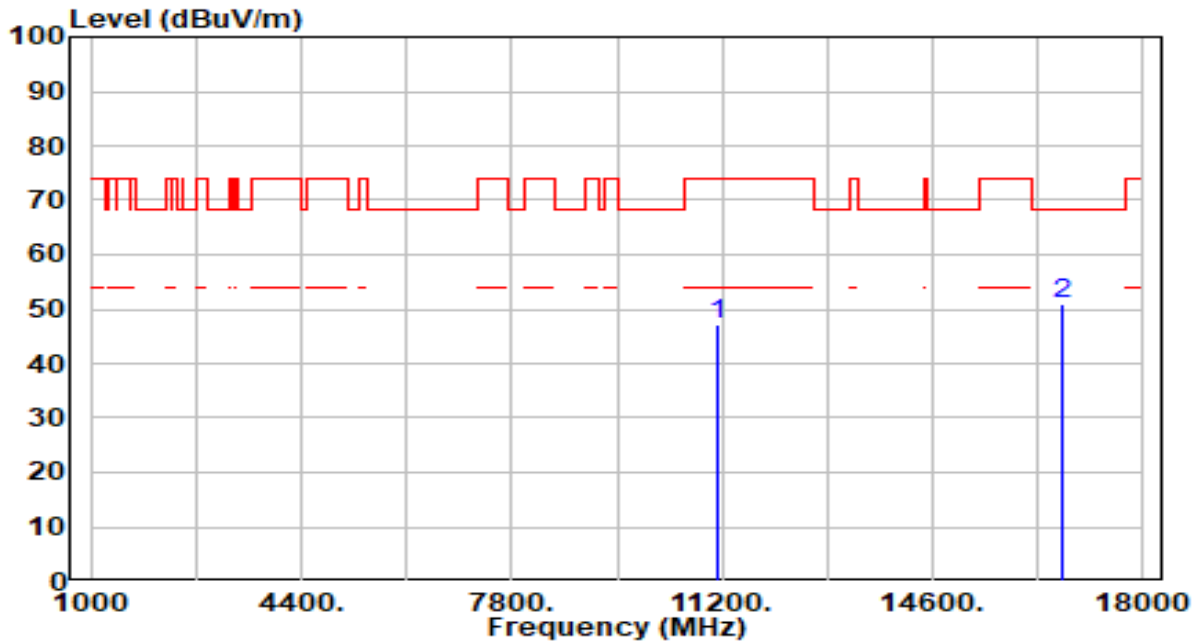

No	Frequency (MHz)	Reading (dBuV)	C.F (dB/m)	Measurement (dBuV/m)	Margin (dB)	Limit (dBuV/m)	Height (cm)	Angle (deg)	Remark (QP/PK/AV)
1	11140.000	42.18	4.89	47.06	-26.94	74.00	100	292	Peak
2	* 16710.000	44.95	6.17	51.12	-17.08	68.20	100	356	Peak

Note:

1. " *", means this data is the worst emission level.
2. C.F (Correction Factor) = Antenna Factor (dB/m)+ Cable Loss (dB) – Pre-amplifier(dB).
3. Measurement (dBuV/m) = Reading(dBuV) + C.F (Correction Factor).
4. The emission levels of other frequencies are very lower than the limit and not show in test report.

EUT	BE3600 Dual-Band Wi-Fi 7 Router	Date of Test	2024-02-06
Factor	DRH18-E	Temp. / Humidity	20°C /65%
Polarity	Vertical	Site / Test Engineer	AC2 / Marvin
Test Mode	802.11ac-160MHz_TX_Band3_CH 114_ANT 0+1	Test Voltage	AC 120V/60Hz

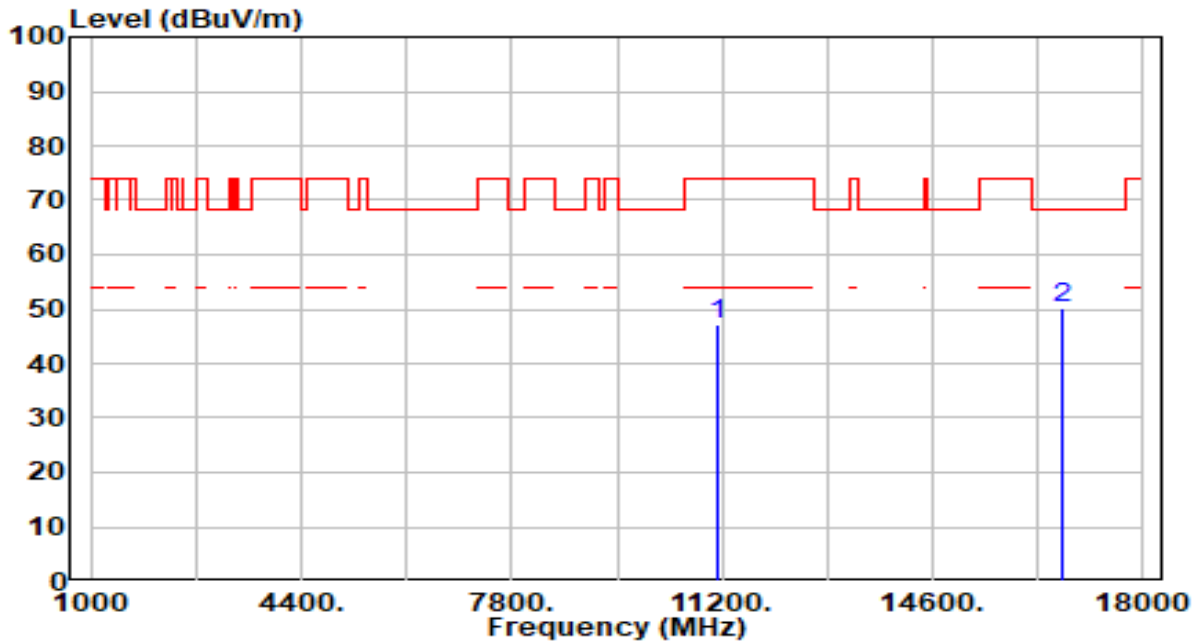

No	Frequency (MHz)	Reading (dBuV)	C.F (dB/m)	Measurement (dBuV/m)	Margin (dB)	Limit (dBuV/m)	Height (cm)	Angle (deg)	Remark (QP/PK/AV)
1	11140.000	42.10	4.89	46.99	-27.01	74.00	100	253	Peak
2	* 16710.000	43.85	6.17	50.02	-18.18	68.20	100	314	Peak

Note:

1. " *", means this data is the worst emission level.
2. C.F (Correction Factor) = Antenna Factor (dB/m)+ Cable Loss (dB) – Pre-amplifier(dB).
3. Measurement (dBuV/m) = Reading(dBuV) + C.F (Correction Factor).
4. The emission levels of other frequencies are very lower than the limit and not show in test report.

EUT	BE3600 Dual-Band Wi-Fi 7 Router	Date of Test	2024-02-06
Factor	DRH18-E	Temp. / Humidity	20°C /65%
Polarity	Horizontal	Site / Test Engineer	AC2 / Marvin
Test Mode	802.11ax-20MHz_TX_Band1_CH 36_ANT 0+1	Test Voltage	AC 120V/60Hz

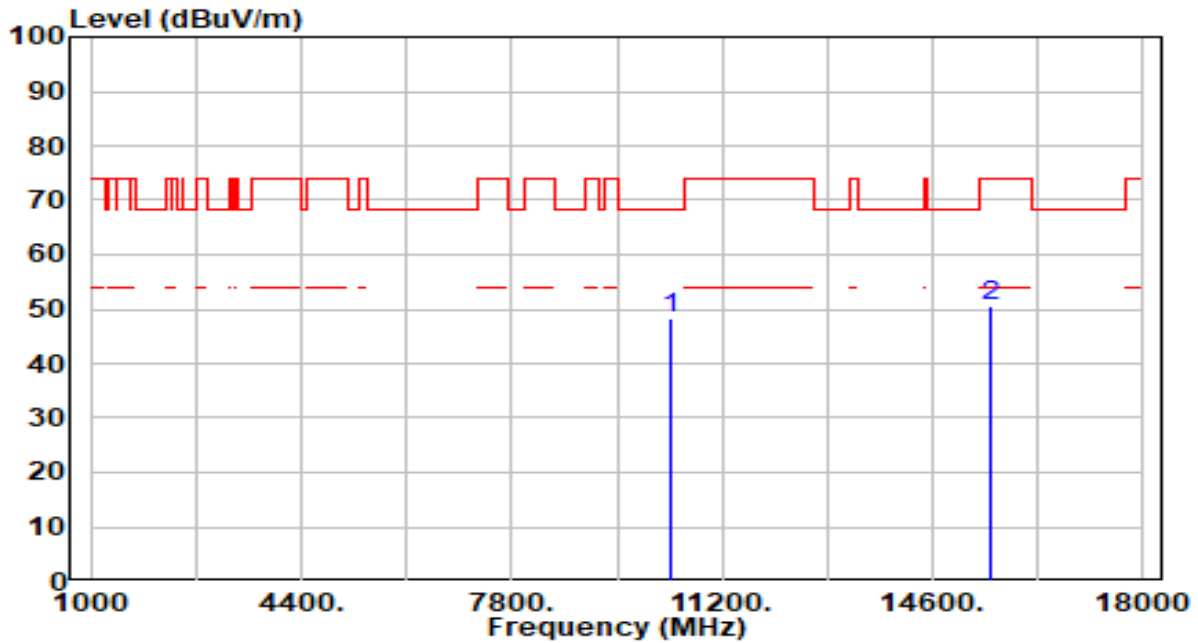

No	Frequency (MHz)	Reading (dBuV)	C.F (dB/m)	Measurement (dBuV/m)	Margin (dB)	Limit (dBuV/m)	Height (cm)	Angle (deg)	Remark (QP/PK/AV)
1	* 10360.000	43.59	4.87	48.46	-19.74	68.20	100	204	Peak
2	15540.000	44.52	6.21	50.73	-23.27	74.00	100	184	Peak

Note:

1. " *", means this data is the worst emission level.
2. C.F (Correction Factor) = Antenna Factor (dB/m)+ Cable Loss (dB) – Pre-amplifier(dB).
3. Measurement (dBuV/m) = Reading(dBuV) + C.F (Correction Factor).
4. The emission levels of other frequencies are very lower than the limit and not show in test report.

EUT	BE3600 Dual-Band Wi-Fi 7 Router	Date of Test	2024-02-06
Factor	DRH18-E	Temp. / Humidity	20°C /65%
Polarity	Vertical	Site / Test Engineer	AC2 / Marvin
Test Mode	802.11ax-20MHz_TX_Band1_CH 36_ANT 0+1	Test Voltage	AC 120V/60Hz

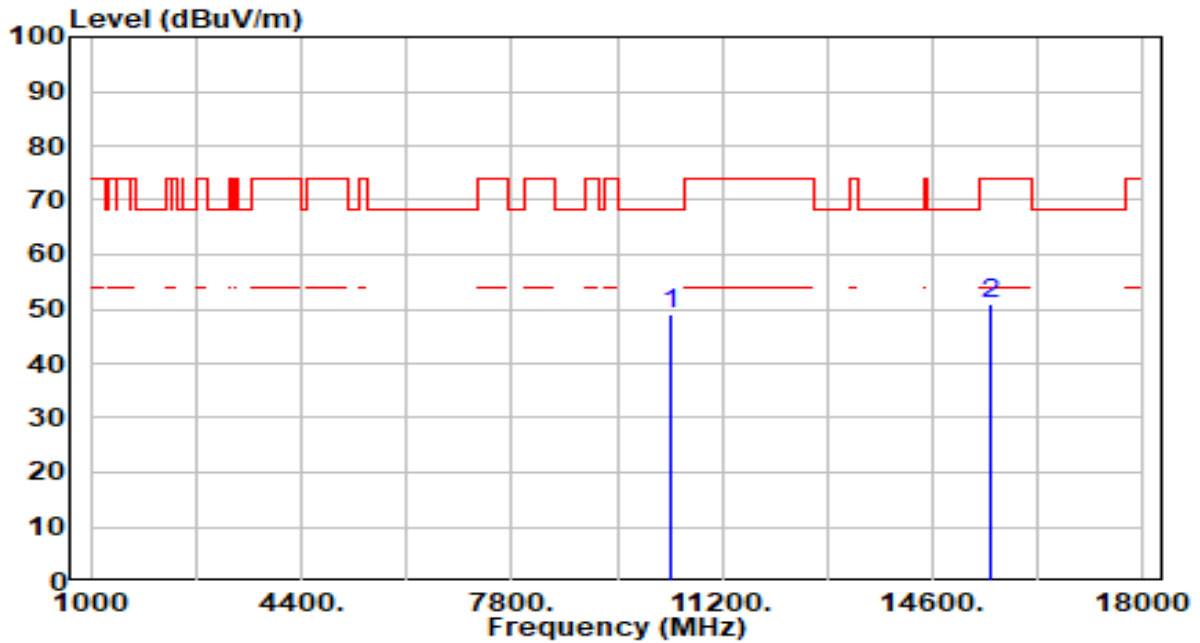

No	Frequency (MHz)	Reading (dBuV)	C.F (dB/m)	Measurement (dBuV/m)	Margin (dB)	Limit (dBuV/m)	Height (cm)	Angle (deg)	Remark (QP/PK/AV)
1	* 10360.000	44.12	4.87	48.99	-19.21	68.20	100	217	Peak
2	15540.000	44.79	6.21	50.99	-23.01	74.00	100	189	Peak

Note:

1. " *", means this data is the worst emission level.
2. C.F (Correction Factor) = Antenna Factor (dB/m)+ Cable Loss (dB) – Pre-amplifier(dB).
3. Measurement (dBuV/m) = Reading(dBuV) + C.F (Correction Factor).
4. The emission levels of other frequencies are very lower than the limit and not show in test report.

EUT	BE3600 Dual-Band Wi-Fi 7 Router	Date of Test	2024-02-06
Factor	DRH18-E	Temp. / Humidity	20°C /65%
Polarity	Horizontal	Site / Test Engineer	AC2 / Marvin
Test Mode	802.11ax-20MHz_TX_Band1_CH 44_ANT 0+1	Test Voltage	AC 120V/60Hz

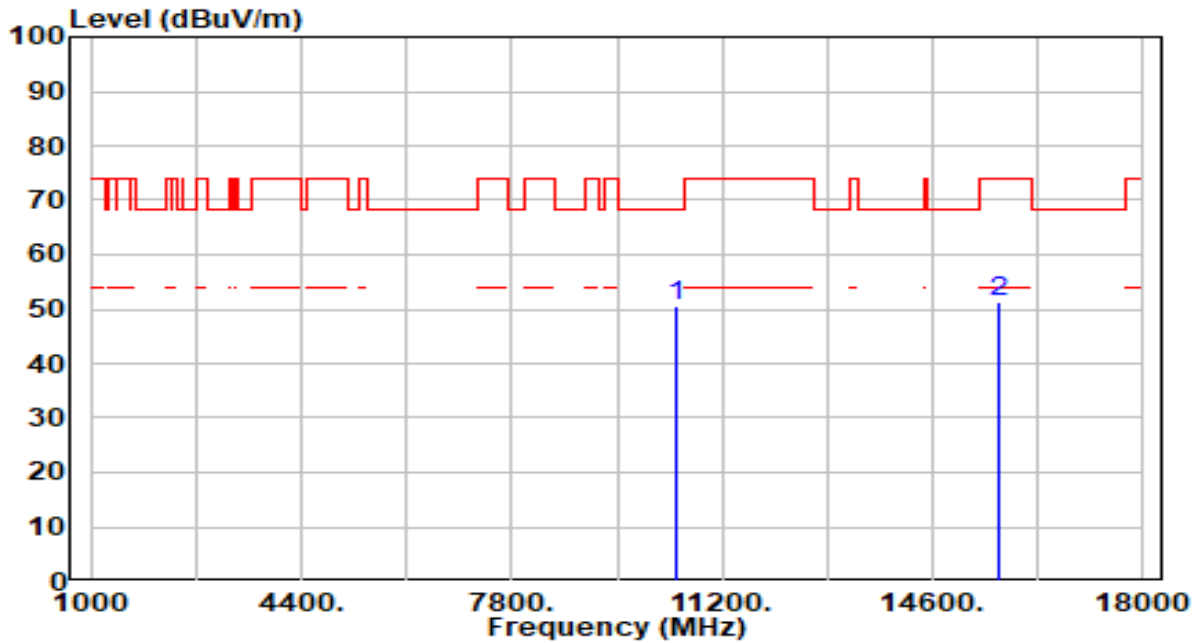

No	Frequency (MHz)	Reading (dBuV)	C.F (dB/m)	Measurement (dBuV/m)	Margin (dB)	Limit (dBuV/m)	Height (cm)	Angle (deg)	Remark (QP/PK/AV)
1	* 10440.000	45.97	4.76	50.74	-17.46	68.20	100	204	Peak
2	15660.000	45.12	6.27	51.39	-22.61	74.00	100	14	Peak

Note:

- "*", means this data is the worst emission level.
- C.F (Correction Factor) = Antenna Factor (dB/m)+ Cable Loss (dB) – Pre-amplifier(dB).
- Measurement (dBuV/m) = Reading(dBuV) + C.F (Correction Factor).
- The emission levels of other frequencies are very lower than the limit and not show in test report.

EUT	BE3600 Dual-Band Wi-Fi 7 Router	Date of Test	2024-02-06
Factor	DRH18-E	Temp. / Humidity	20°C /65%
Polarity	Vertical	Site / Test Engineer	AC2 / Marvin
Test Mode	802.11ax-20MHz_TX_Band1_CH 44_ANT 0+1	Test Voltage	AC 120V/60Hz

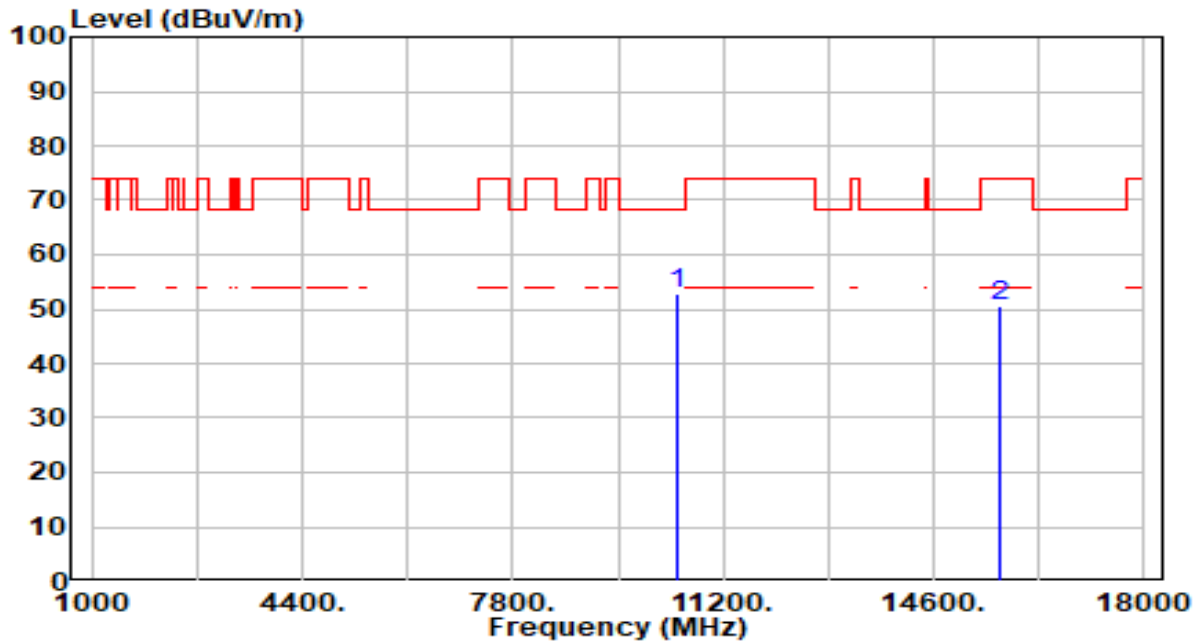

No	Frequency (MHz)	Reading (dBuV)	C.F (dB/m)	Measurement (dBuV/m)	Margin (dB)	Limit (dBuV/m)	Height (cm)	Angle (deg)	Remark (QP/PK/AV)
1	* 10440.000	47.90	4.76	52.66	-15.54	68.20	100	216	Peak
2	15660.000	44.47	6.27	50.74	-23.26	74.00	100	93	Peak

Note:

1. " *", means this data is the worst emission level.
2. C.F (Correction Factor) = Antenna Factor (dB/m)+ Cable Loss (dB) – Pre-amplifier(dB).
3. Measurement (dBuV/m) = Reading(dBuV) + C.F (Correction Factor).
4. The emission levels of other frequencies are very lower than the limit and not show in test report.

EUT	BE3600 Dual-Band Wi-Fi 7 Router	Date of Test	2024-02-06
Factor	DRH18-E	Temp. / Humidity	20°C /65%
Polarity	Horizontal	Site / Test Engineer	AC2 / Marvin
Test Mode	802.11ax-20MHz_TX_Band1_CH 48_ANT 0+1	Test Voltage	AC 120V/60Hz

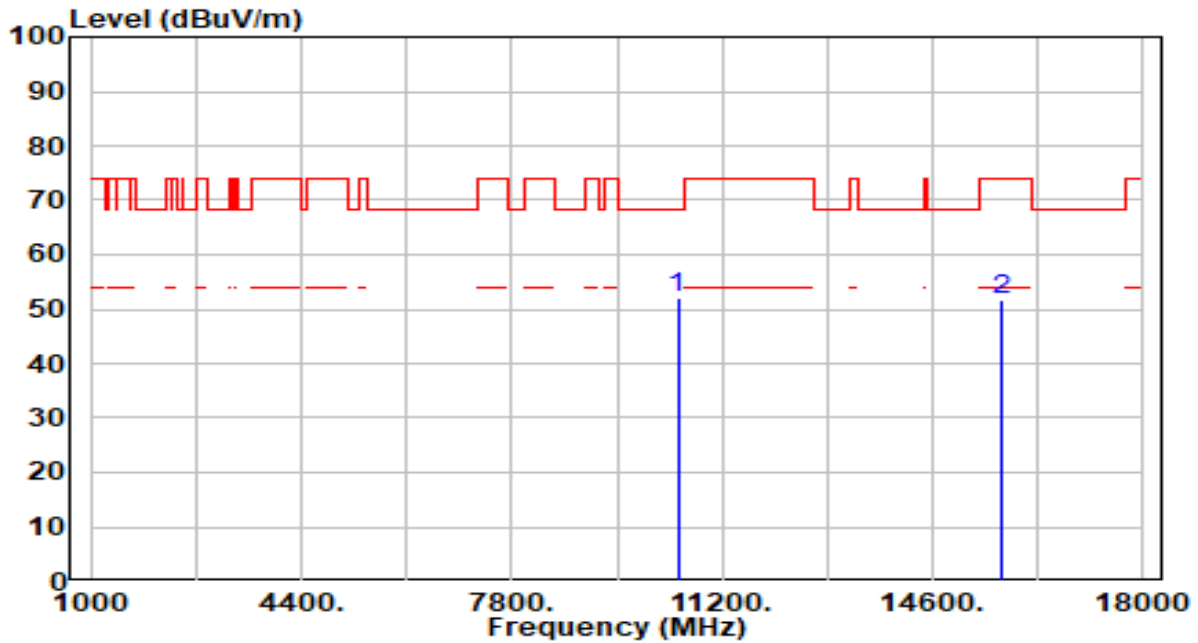

No	Frequency (MHz)	Reading (dBuV)	C.F (dB/m)	Measurement (dBuV/m)	Margin (dB)	Limit (dBuV/m)	Height (cm)	Angle (deg)	Remark (QP/PK/AV)
1	* 10480.000	47.46	4.71	52.18	-16.02	68.20	100	201	Peak
2	15720.000	45.12	6.39	51.51	-22.49	74.00	100	181	Peak

Note:

1. " *", means this data is the worst emission level.
2. C.F (Correction Factor) = Antenna Factor (dB/m)+ Cable Loss (dB) – Pre-amplifier(dB).
3. Measurement (dBuV/m) = Reading(dBuV) + C.F (Correction Factor).
4. The emission levels of other frequencies are very lower than the limit and not show in test report.

EUT	BE3600 Dual-Band Wi-Fi 7 Router	Date of Test	2024-02-06
Factor	DRH18-E	Temp. / Humidity	20°C /65%
Polarity	Vertical	Site / Test Engineer	AC2 / Marvin
Test Mode	802.11ax-20MHz_TX_Band1_CH 48_ANT 0+1	Test Voltage	AC 120V/60Hz

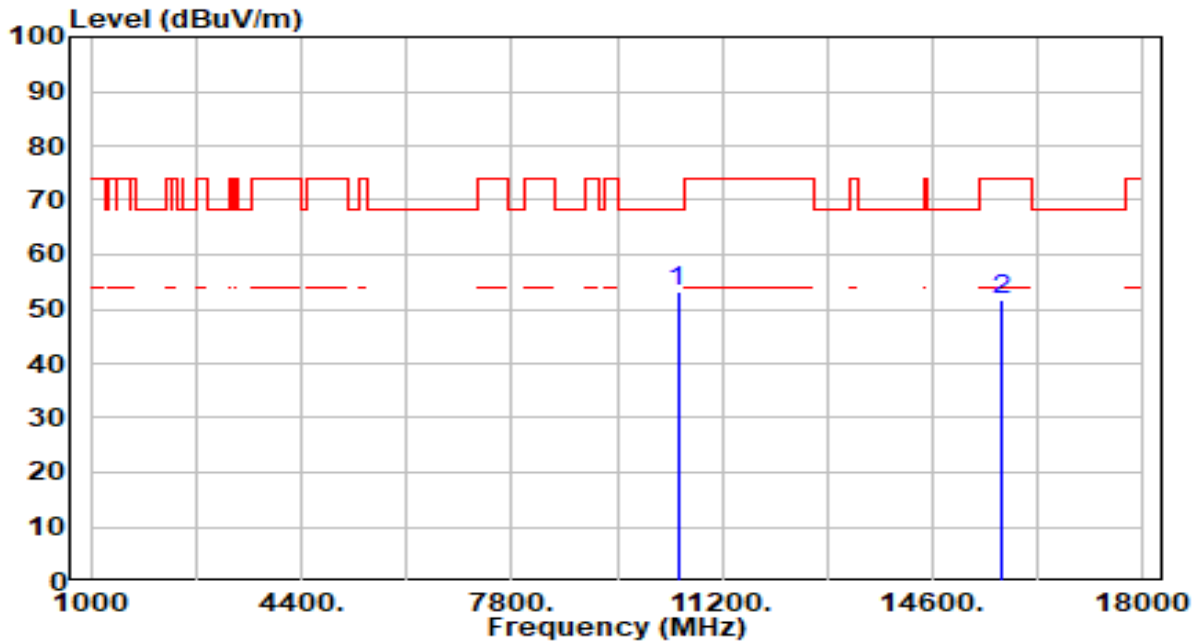

No	Frequency (MHz)	Reading (dBuV)	C.F (dB/m)	Measurement (dBuV/m)	Margin (dB)	Limit (dBuV/m)	Height (cm)	Angle (deg)	Remark (QP/PK/AV)
1	* 10480.000	48.37	4.71	53.08	-15.12	68.20	100	145	Peak
2	15720.000	45.39	6.39	51.77	-22.23	74.00	100	205	Peak

Note:

1. " *", means this data is the worst emission level.
2. C.F (Correction Factor) = Antenna Factor (dB/m)+ Cable Loss (dB) – Pre-amplifier(dB).
3. Measurement (dBuV/m) = Reading(dBuV) + C.F (Correction Factor).
4. The emission levels of other frequencies are very lower than the limit and not show in test report.

EUT	BE3600 Dual-Band Wi-Fi 7 Router	Date of Test	2024-02-06
Factor	DRH18-E	Temp. / Humidity	20°C /65%
Polarity	Horizontal	Site / Test Engineer	AC2 / Marvin
Test Mode	802.11ax-20MHz_TX_Band2_CH 52_ANT 0+1	Test Voltage	AC 120V/60Hz

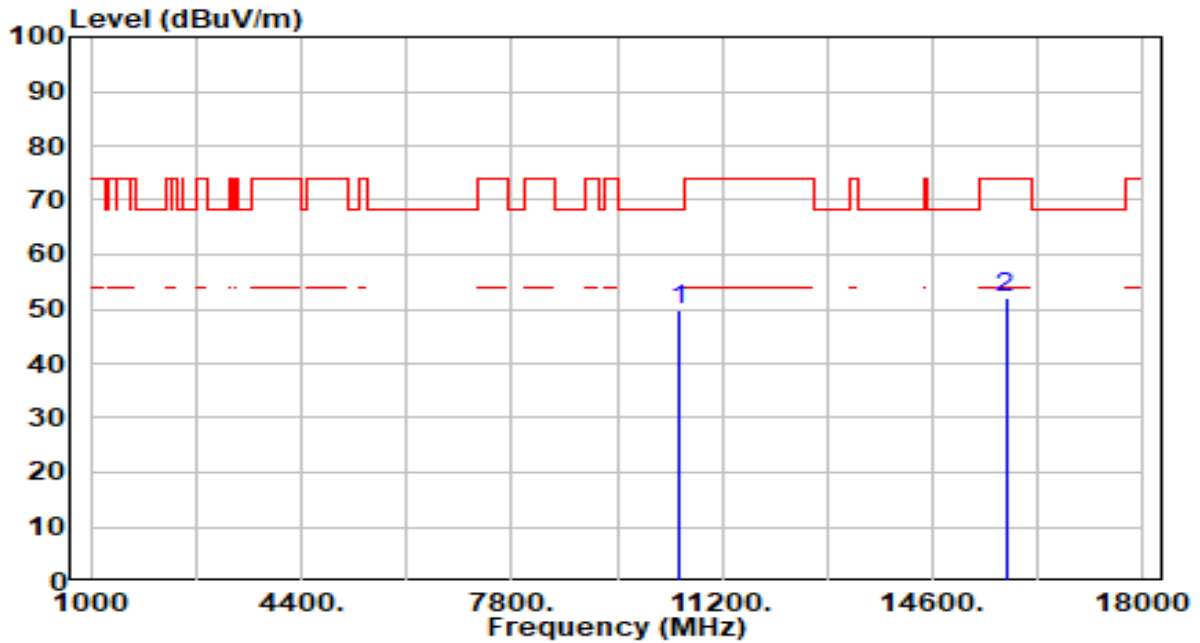

No	Frequency (MHz)	Reading (dBuV)	C.F (dB/m)	Measurement (dBuV/m)	Margin (dB)	Limit (dBuV/m)	Height (cm)	Angle (deg)	Remark (QP/PK/AV)
1	* 10520.000	44.95	4.67	49.62	-18.58	68.20	100	225	Peak
2	15780.000	45.47	6.51	51.98	-22.02	74.00	100	225	Peak

Note:

1. " *", means this data is the worst emission level.
2. C.F (Correction Factor) = Antenna Factor (dB/m)+ Cable Loss (dB) – Pre-amplifier(dB).
3. Measurement (dBuV/m) = Reading(dBuV) + C.F (Correction Factor).
4. The emission levels of other frequencies are very lower than the limit and not show in test report.

EUT	BE3600 Dual-Band Wi-Fi 7 Router	Date of Test	2024-02-06
Factor	DRH18-E	Temp. / Humidity	20°C /65%
Polarity	Vertical	Site / Test Engineer	AC2 / Marvin
Test Mode	802.11ax-20MHz_TX_Band2_CH 52_ANT 0+1	Test Voltage	AC 120V/60Hz

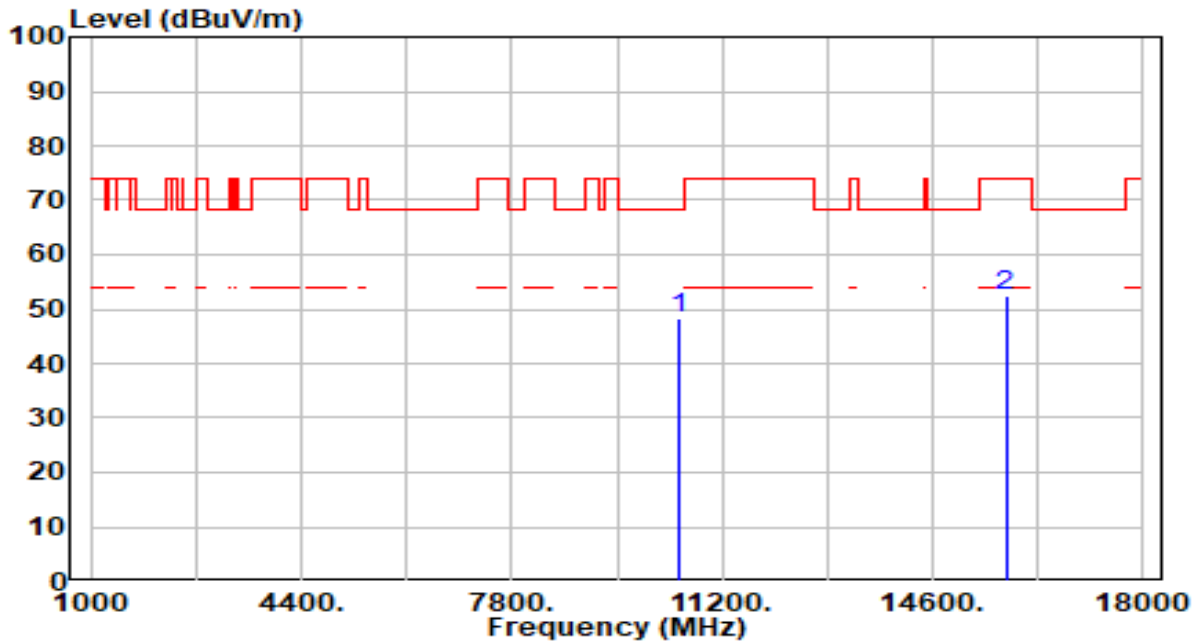

No	Frequency (MHz)	Reading (dBuV)	C.F (dB/m)	Measurement (dBuV/m)	Margin (dB)	Limit (dBuV/m)	Height (cm)	Angle (deg)	Remark (QP/PK/AV)
1	* 10520.000	43.57	4.67	48.24	-19.96	68.20	100	14	Peak
2	15780.000	45.86	6.51	52.36	-21.64	74.00	100	134	Peak

Note:

1. " *", means this data is the worst emission level.
2. C.F (Correction Factor) = Antenna Factor (dB/m)+ Cable Loss (dB) – Pre-amplifier(dB).
3. Measurement (dBuV/m) = Reading(dBuV) + C.F (Correction Factor).
4. The emission levels of other frequencies are very lower than the limit and not show in test report.

EUT	BE3600 Dual-Band Wi-Fi 7 Router	Date of Test	2024-02-06
Factor	DRH18-E	Temp. / Humidity	20°C /65%
Polarity	Horizontal	Site / Test Engineer	AC2 / Marvin
Test Mode	802.11ax-20MHz_TX_Band2_CH 60_ANT 0+1	Test Voltage	AC 120V/60Hz

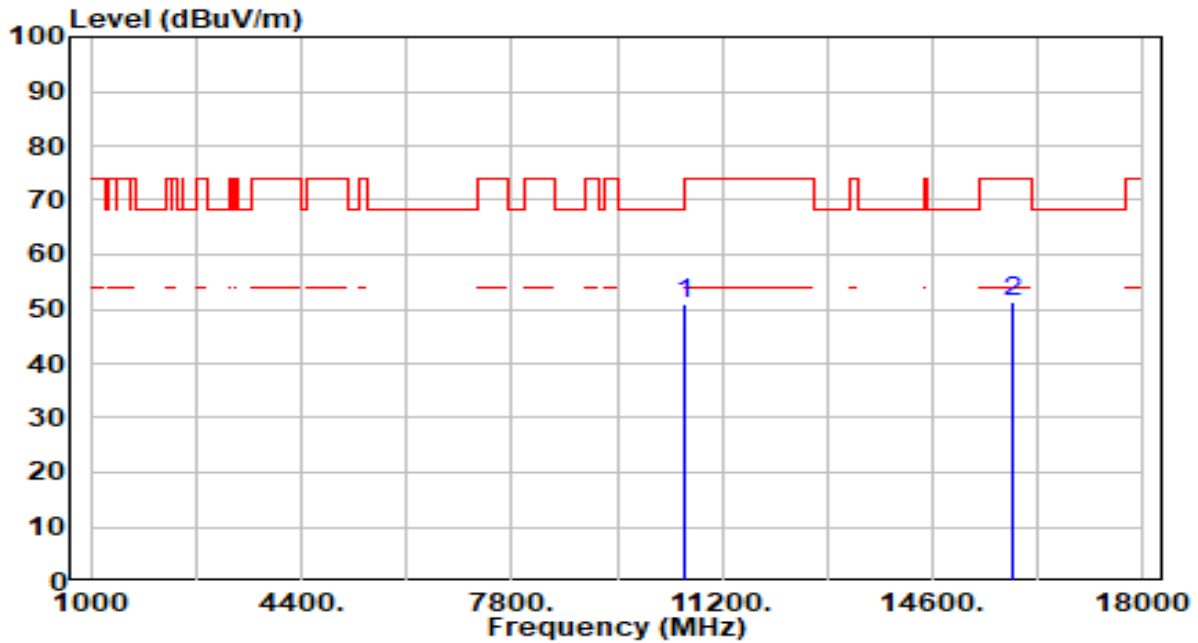

No	Frequency (MHz)	Reading (dBuV)	C.F (dB/m)	Measurement (dBuV/m)	Margin (dB)	Limit (dBuV/m)	Height (cm)	Angle (deg)	Remark (QP/PK/AV)
1	* 10600.000	46.25	4.61	50.86	-17.34	68.20	100	212	Peak
2	15900.000	44.61	6.55	51.16	-22.84	74.00	100	144	Peak

Note:

1. " *", means this data is the worst emission level.
2. C.F (Correction Factor) = Antenna Factor (dB/m)+ Cable Loss (dB) – Pre-amplifier(dB).
3. Measurement (dBuV/m) = Reading(dBuV) + C.F (Correction Factor).
4. The emission levels of other frequencies are very lower than the limit and not show in test report.

EUT	BE3600 Dual-Band Wi-Fi 7 Router	Date of Test	2024-02-06
Factor	DRH18-E	Temp. / Humidity	20°C /65%
Polarity	Vertical	Site / Test Engineer	AC2 / Marvin
Test Mode	802.11ax-20MHz_TX_Band2_CH 60_ANT 0+1	Test Voltage	AC 120V/60Hz

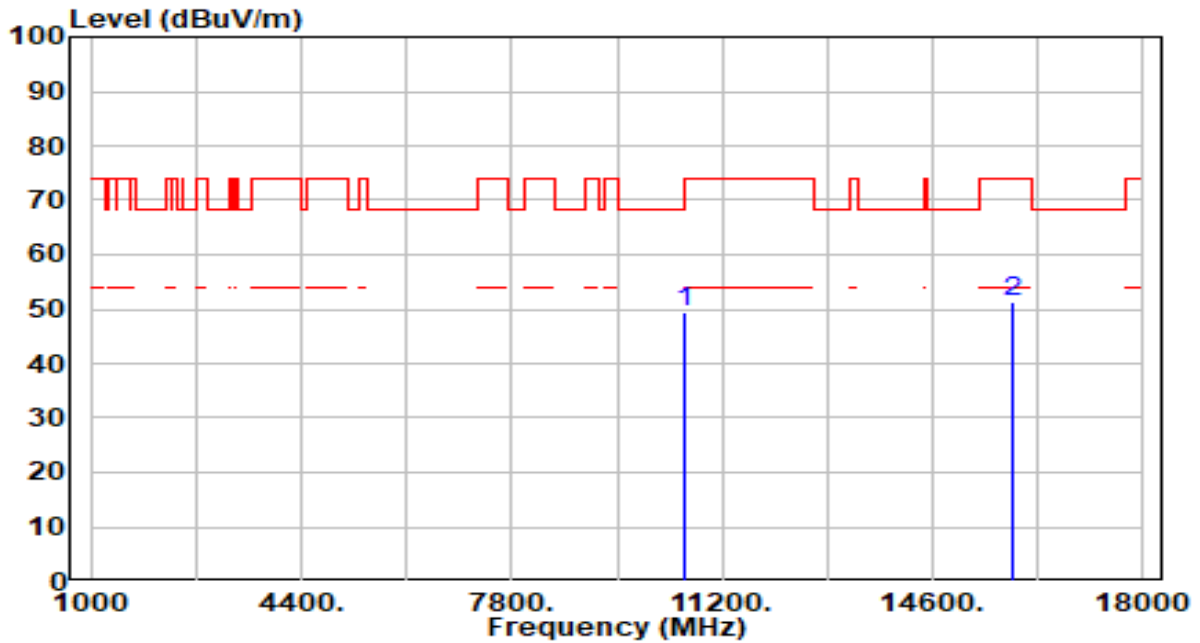

No	Frequency (MHz)	Reading (dBuV)	C.F (dB/m)	Measurement (dBuV/m)	Margin (dB)	Limit (dBuV/m)	Height (cm)	Angle (deg)	Remark (QP/PK/AV)
1	* 10600.000	44.85	4.61	49.46	-18.74	68.20	100	144	Peak
2	15900.000	44.68	6.55	51.23	-22.77	74.00	100	177	Peak

Note:

1. " *", means this data is the worst emission level.
2. C.F (Correction Factor) = Antenna Factor (dB/m)+ Cable Loss (dB) – Pre-amplifier(dB).
3. Measurement (dBuV/m) = Reading(dBuV) + C.F (Correction Factor).
4. The emission levels of other frequencies are very lower than the limit and not show in test report.

EUT	BE3600 Dual-Band Wi-Fi 7 Router	Date of Test	2024-02-06
Factor	DRH18-E	Temp. / Humidity	20°C /65%
Polarity	Horizontal	Site / Test Engineer	AC2 / Marvin
Test Mode	802.11ax-20MHz_TX_Band2_CH 64_ANT 0+1	Test Voltage	AC 120V/60Hz

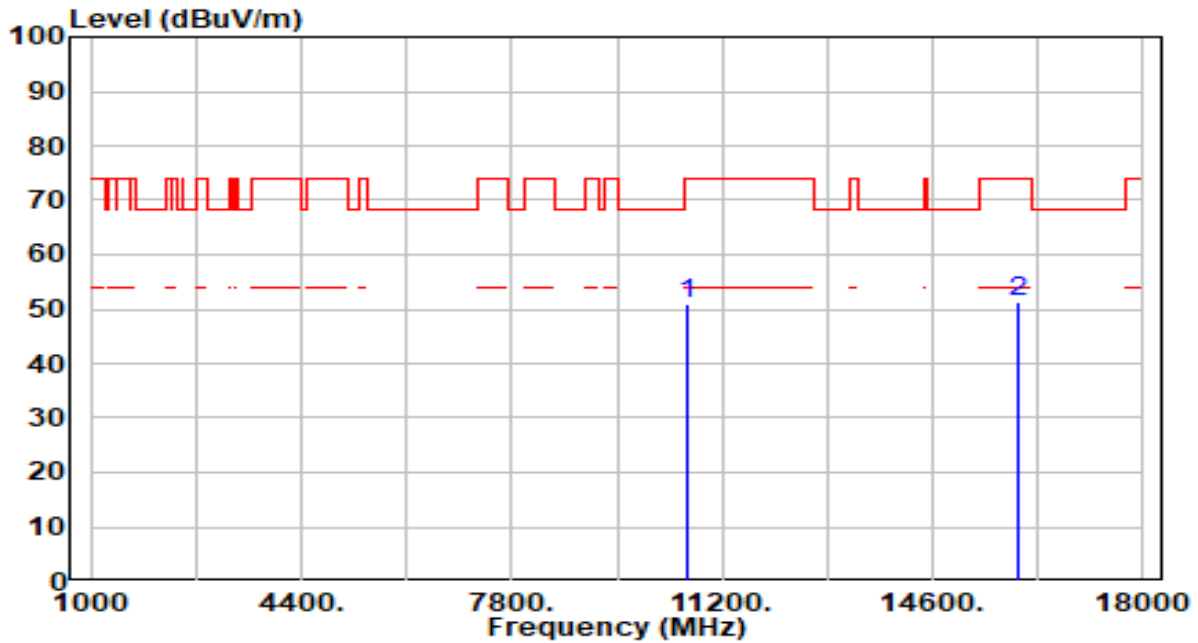

No	Frequency (MHz)	Reading (dBuV)	C.F (dB/m)	Measurement (dBuV/m)	Margin (dB)	Limit (dBuV/m)	Height (cm)	Angle (deg)	Remark (QP/PK/AV)
1	10640.000	46.28	4.62	50.90	-23.10	74.00	100	212	Peak
2	* 15960.000	44.78	6.55	51.33	-22.67	74.00	100	274	Peak

Note:

1. " *", means this data is the worst emission level.
2. C.F (Correction Factor) = Antenna Factor (dB/m)+ Cable Loss (dB) – Pre-amplifier(dB).
3. Measurement (dBuV/m) = Reading(dBuV) + C.F (Correction Factor).
4. The emission levels of other frequencies are very lower than the limit and not show in test report.

EUT	BE3600 Dual-Band Wi-Fi 7 Router	Date of Test	2024-02-06
Factor	DRH18-E	Temp. / Humidity	20°C /65%
Polarity	Vertical	Site / Test Engineer	AC2 / Marvin
Test Mode	802.11ax-20MHz_TX_Band2_CH 64_ANT 0+1	Test Voltage	AC 120V/60Hz

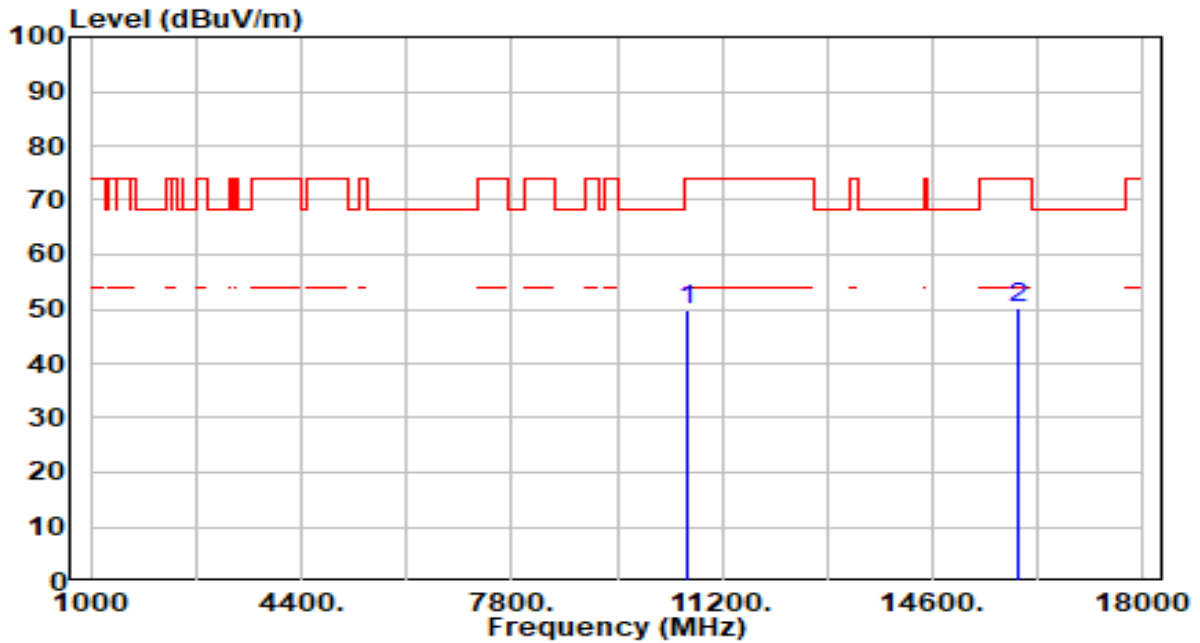

No	Frequency (MHz)	Reading (dBuV)	C.F (dB/m)	Measurement (dBuV/m)	Margin (dB)	Limit (dBuV/m)	Height (cm)	Angle (deg)	Remark (QP/PK/AV)
1	10640.000	45.14	4.62	49.76	-24.24	74.00	100	213	Peak
2	* 15960.000	43.77	6.55	50.32	-23.68	74.00	100	174	Peak

Note:

- "*", means this data is the worst emission level.
- C.F (Correction Factor) = Antenna Factor (dB/m)+ Cable Loss (dB) – Pre-amplifier(dB).
- Measurement (dBuV/m) = Reading(dBuV) + C.F (Correction Factor).
- The emission levels of other frequencies are very lower than the limit and not show in test report.

EUT	BE3600 Dual-Band Wi-Fi 7 Router	Date of Test	2024-02-06
Factor	DRH18-E	Temp. / Humidity	20°C /65%
Polarity	Horizontal	Site / Test Engineer	AC2 / Marvin
Test Mode	802.11ax-20MHz_TX_Band3_CH 100_ANT 0+1	Test Voltage	AC 120V/60Hz

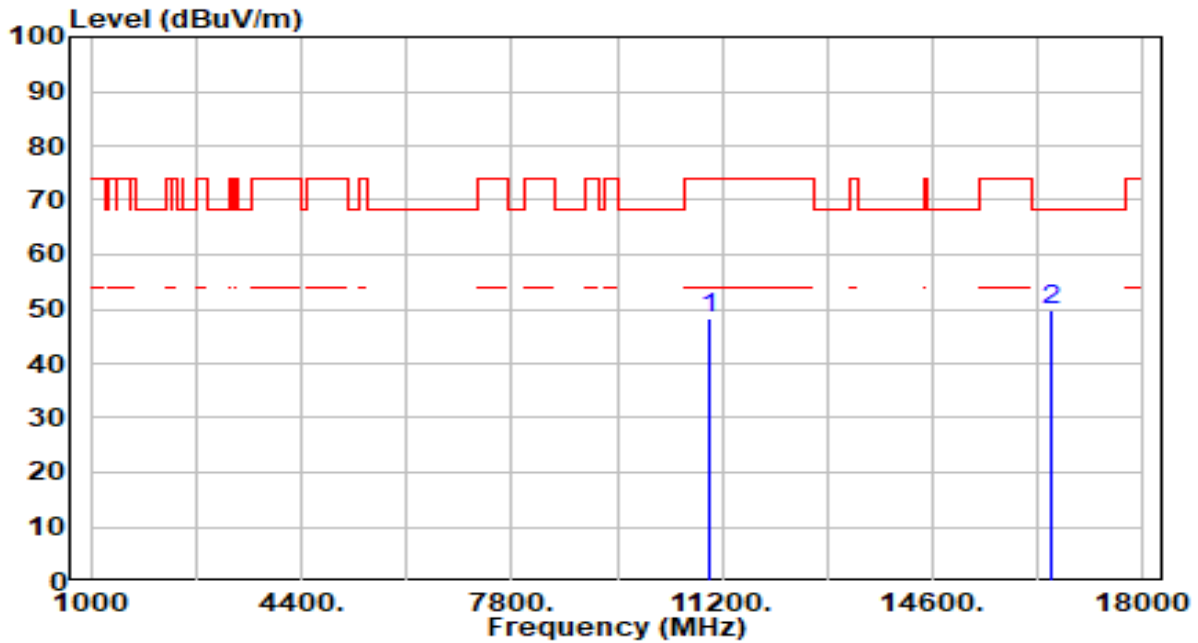

No	Frequency (MHz)	Reading (dBuV)	C.F (dB/m)	Measurement (dBuV/m)	Margin (dB)	Limit (dBuV/m)	Height (cm)	Angle (deg)	Remark (QP/PK/AV)
1	11000.000	43.76	4.52	48.28	-25.72	74.00	100	139	Peak
2	* 16500.000	43.78	6.10	49.88	-18.32	68.20	100	20	Peak

Note:

1. " *", means this data is the worst emission level.
2. C.F (Correction Factor) = Antenna Factor (dB/m)+ Cable Loss (dB) – Pre-amplifier(dB).
3. Measurement (dBuV/m) = Reading(dBuV) + C.F (Correction Factor).
4. The emission levels of other frequencies are very lower than the limit and not show in test report.

EUT	BE3600 Dual-Band Wi-Fi 7 Router	Date of Test	2024-02-06
Factor	DRH18-E	Temp. / Humidity	20°C /65%
Polarity	Vertical	Site / Test Engineer	AC2 / Marvin
Test Mode	802.11ax-20MHz_TX_Band3_CH 100_ANT 0+1	Test Voltage	AC 120V/60Hz

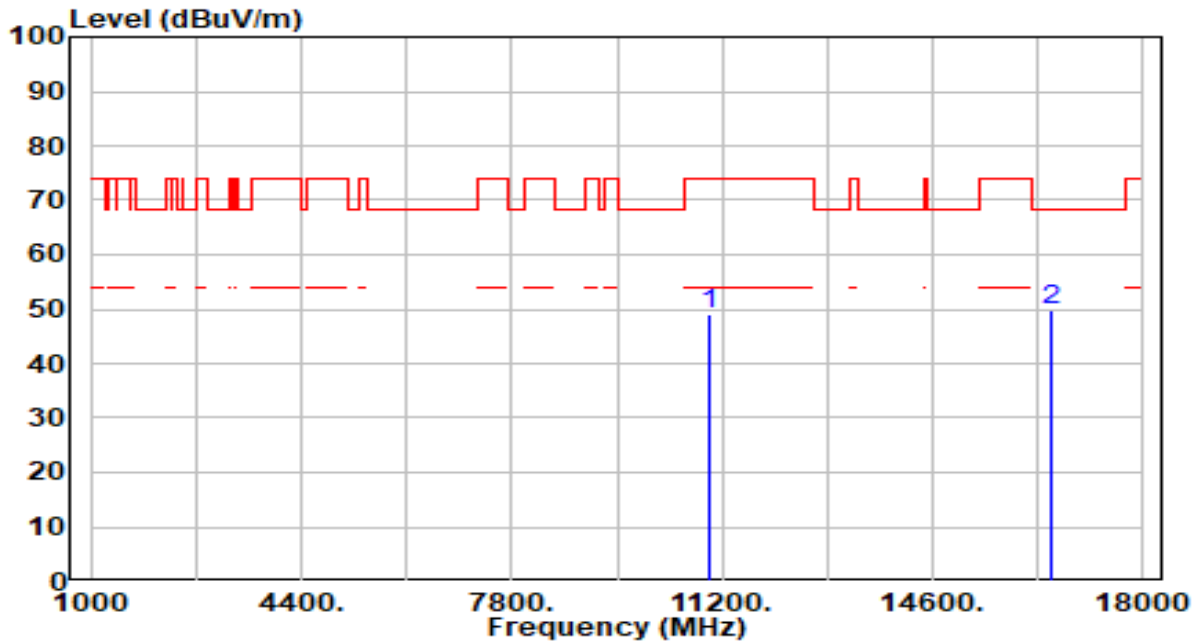

No	Frequency (MHz)	Reading (dBuV)	C.F (dB/m)	Measurement (dBuV/m)	Margin (dB)	Limit (dBuV/m)	Height (cm)	Angle (deg)	Remark (QP/PK/AV)
1	11000.000	44.65	4.52	49.17	-24.83	74.00	100	253	Peak
2	* 16500.000	43.69	6.10	49.79	-18.41	68.20	100	324	Peak

Note:

1. " *", means this data is the worst emission level.
2. C.F (Correction Factor) = Antenna Factor (dB/m)+ Cable Loss (dB) – Pre-amplifier(dB).
3. Measurement (dBuV/m) = Reading(dBuV) + C.F (Correction Factor).
4. The emission levels of other frequencies are very lower than the limit and not show in test report.

EUT	BE3600 Dual-Band Wi-Fi 7 Router	Date of Test	2024-02-06
Factor	DRH18-E	Temp. / Humidity	20°C /65%
Polarity	Horizontal	Site / Test Engineer	AC2 / Marvin
Test Mode	802.11ax-20MHz_TX_Band3_CH 116_ANT 0+1	Test Voltage	AC 120V/60Hz

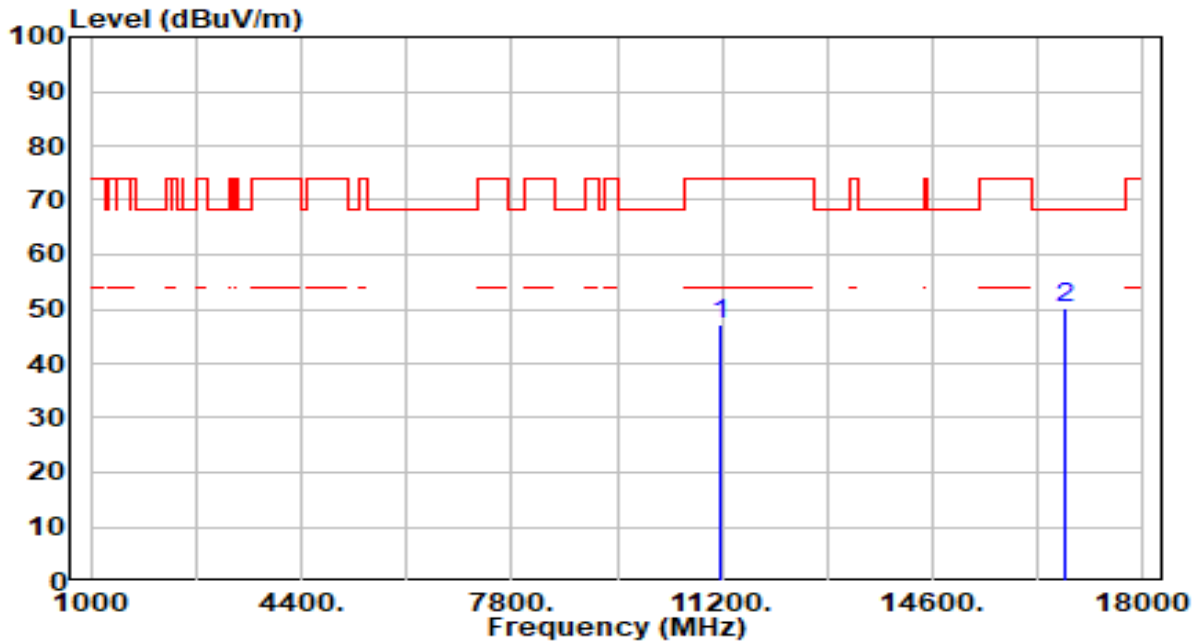

No	Frequency (MHz)	Reading (dBuV)	C.F (dB/m)	Measurement (dBuV/m)	Margin (dB)	Limit (dBuV/m)	Height (cm)	Angle (deg)	Remark (QP/PK/AV)
1	11160.000	42.25	4.94	47.19	-26.81	74.00	100	320	Peak
2	* 16740.000	43.87	6.19	50.06	-18.14	68.20	100	224	Peak

Note:

1. " *", means this data is the worst emission level.
2. C.F (Correction Factor) = Antenna Factor (dB/m)+ Cable Loss (dB) – Pre-amplifier(dB).
3. Measurement (dBuV/m) = Reading(dBuV) + C.F (Correction Factor).
4. The emission levels of other frequencies are very lower than the limit and not show in test report.

EUT	BE3600 Dual-Band Wi-Fi 7 Router	Date of Test	2024-02-06
Factor	DRH18-E	Temp. / Humidity	20°C /65%
Polarity	Vertical	Site / Test Engineer	AC2 / Marvin
Test Mode	802.11ax-20MHz_TX_Band3_CH 116_ANT 0+1	Test Voltage	AC 120V/60Hz

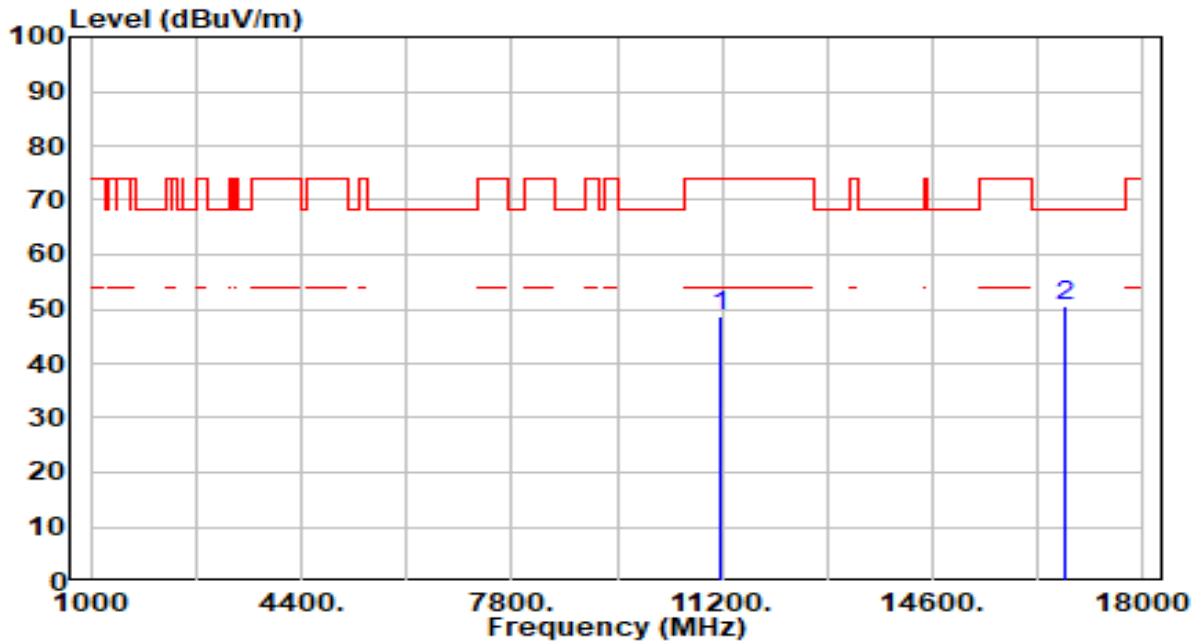

No	Frequency (MHz)	Reading (dBuV)	C.F (dB/m)	Measurement (dBuV/m)	Margin (dB)	Limit (dBuV/m)	Height (cm)	Angle (deg)	Remark (QP/PK/AV)
1	11160.000	43.93	4.94	48.87	-25.13	74.00	100	252	Peak
2	* 16740.000	44.53	6.19	50.72	-17.48	68.20	100	59	Peak

Note:

1. " *", means this data is the worst emission level.
2. C.F (Correction Factor) = Antenna Factor (dB/m)+ Cable Loss (dB) – Pre-amplifier(dB).
3. Measurement (dBuV/m) = Reading(dBuV) + C.F (Correction Factor).
4. The emission levels of other frequencies are very lower than the limit and not show in test report.

EUT	BE3600 Dual-Band Wi-Fi 7 Router	Date of Test	2024-02-06
Factor	DRH18-E	Temp. / Humidity	20°C /65%
Polarity	Horizontal	Site / Test Engineer	AC2 / Marvin
Test Mode	802.11ax-20MHz_TX_Band3_CH 140_ANT 0+1	Test Voltage	AC 120V/60Hz

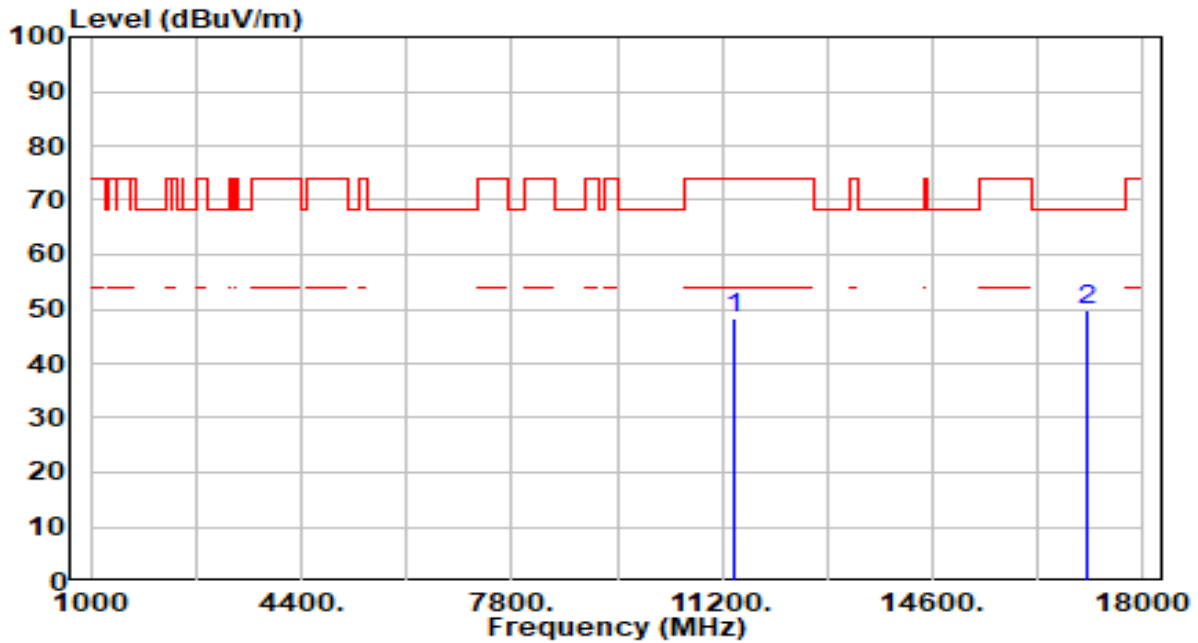

No	Frequency (MHz)	Reading (dBuV)	C.F (dB/m)	Measurement (dBuV/m)	Margin (dB)	Limit (dBuV/m)	Height (cm)	Angle (deg)	Remark (QP/PK/AV)
1	11400.000	42.92	5.26	48.18	-25.82	74.00	100	12	Peak
2	* 17100.000	43.95	5.97	49.92	-18.28	68.20	100	138	Peak

Note:

1. " *", means this data is the worst emission level.
2. C.F (Correction Factor) = Antenna Factor (dB/m)+ Cable Loss (dB) – Pre-amplifier(dB).
3. Measurement (dBuV/m) = Reading(dBuV) + C.F (Correction Factor).
4. The emission levels of other frequencies are very lower than the limit and not show in test report.

EUT	BE3600 Dual-Band Wi-Fi 7 Router	Date of Test	2024-02-06
Factor	DRH18-E	Temp. / Humidity	20°C /65%
Polarity	Vertical	Site / Test Engineer	AC2 / Marvin
Test Mode	802.11ax-20MHz_TX_Band3_CH 140_ANT 0+1	Test Voltage	AC 120V/60Hz

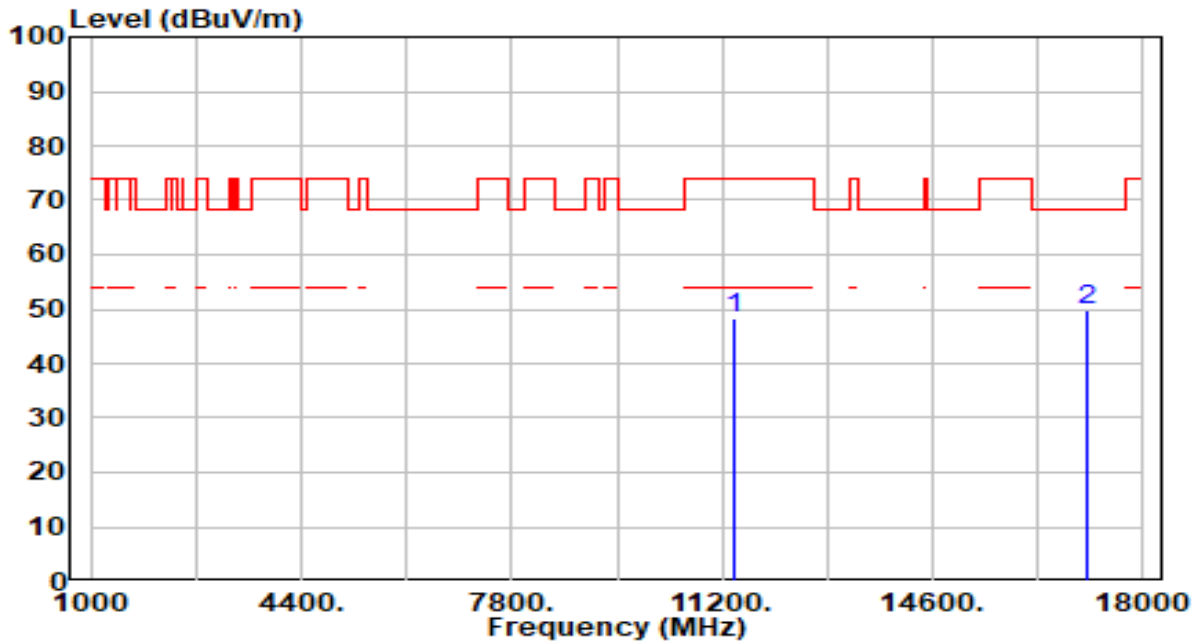

No	Frequency (MHz)	Reading (dBuV)	C.F (dB/m)	Measurement (dBuV/m)	Margin (dB)	Limit (dBuV/m)	Height (cm)	Angle (deg)	Remark (QP/PK/AV)
1	11400.000	43.14	5.26	48.40	-25.60	74.00	100	253	Peak
2	* 17100.000	43.91	5.97	49.89	-18.31	68.20	100	250	Peak

Note:

1. " *", means this data is the worst emission level.
2. C.F (Correction Factor) = Antenna Factor (dB/m)+ Cable Loss (dB) – Pre-amplifier(dB).
3. Measurement (dBuV/m) = Reading(dBuV) + C.F (Correction Factor).
4. The emission levels of other frequencies are very lower than the limit and not show in test report.

EUT	BE3600 Dual-Band Wi-Fi 7 Router	Date of Test	2024-02-06
Factor	DRH18-E	Temp. / Humidity	20°C /65%
Polarity	Horizontal	Site / Test Engineer	AC2 / Marvin
Test Mode	802.11ax-20MHz_TX_Band3_CH 144_ANT 0+1	Test Voltage	AC 120V/60Hz

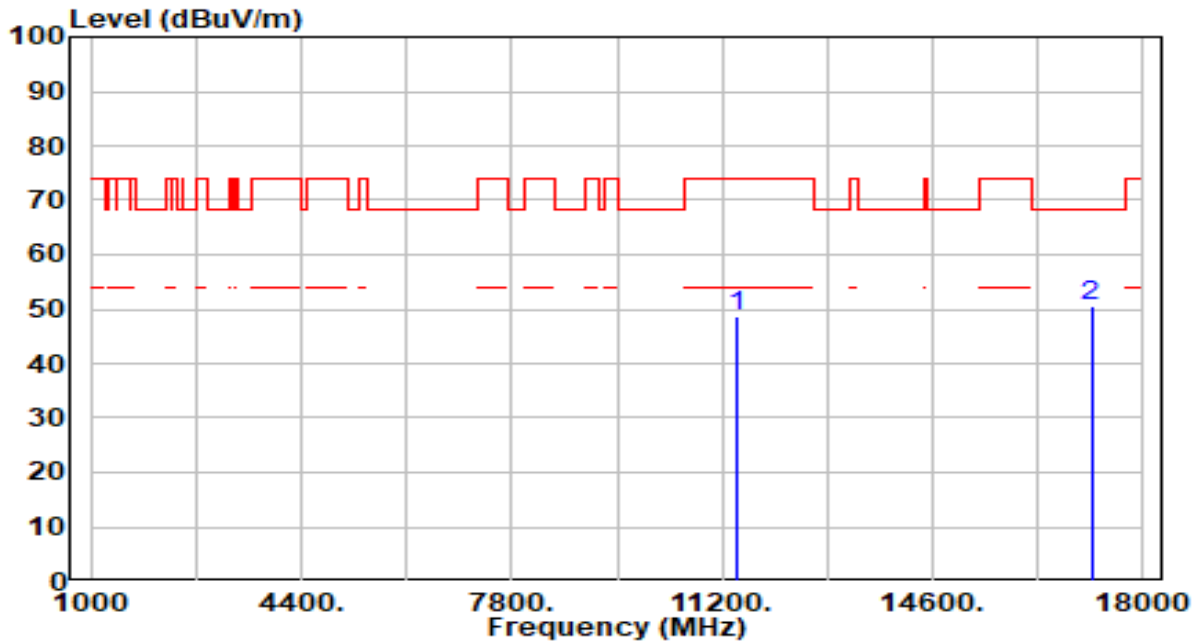

No	Frequency (MHz)	Reading (dBuV)	C.F (dB/m)	Measurement (dBuV/m)	Margin (dB)	Limit (dBuV/m)	Height (cm)	Angle (deg)	Remark (QP/PK/AV)
1	11440.000	43.29	5.29	48.58	-25.42	74.00	100	35	Peak
2	* 17160.000	44.52	5.87	50.39	-17.81	68.20	100	91	Peak

Note:

1. " *", means this data is the worst emission level.
2. C.F (Correction Factor) = Antenna Factor (dB/m)+ Cable Loss (dB) – Pre-amplifier(dB).
3. Measurement (dBuV/m) = Reading(dBuV) + C.F (Correction Factor).
4. The emission levels of other frequencies are very lower than the limit and not show in test report.

EUT	BE3600 Dual-Band Wi-Fi 7 Router	Date of Test	2024-02-06
Factor	DRH18-E	Temp. / Humidity	20°C /65%
Polarity	Vertical	Site / Test Engineer	AC2 / Marvin
Test Mode	802.11ax-20MHz_TX_Band3_CH 144_ANT 0+1	Test Voltage	AC 120V/60Hz

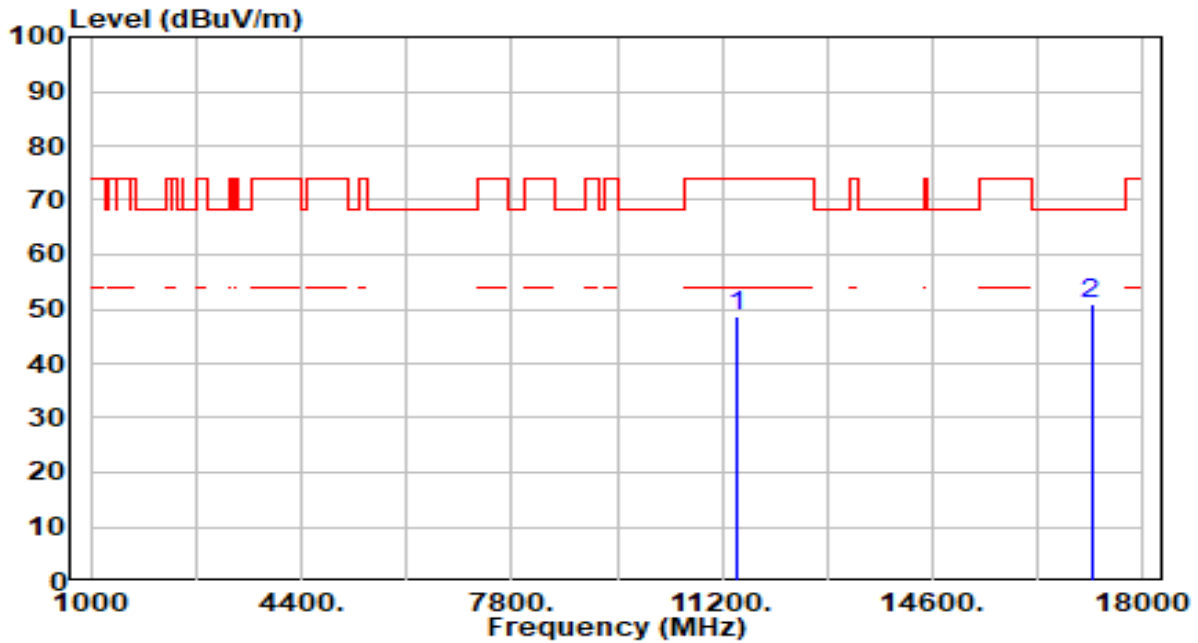

No	Frequency (MHz)	Reading (dBuV)	C.F (dB/m)	Measurement (dBuV/m)	Margin (dB)	Limit (dBuV/m)	Height (cm)	Angle (deg)	Remark (QP/PK/AV)
1	11440.000	43.31	5.29	48.60	-25.40	74.00	100	0	Peak
2	* 17160.000	45.14	5.87	51.01	-17.19	68.20	100	210	Peak

Note:

1. " *", means this data is the worst emission level.
2. C.F (Correction Factor) = Antenna Factor (dB/m)+ Cable Loss (dB) – Pre-amplifier(dB).
3. Measurement (dBuV/m) = Reading(dBuV) + C.F (Correction Factor).
4. The emission levels of other frequencies are very lower than the limit and not show in test report.

EUT	BE3600 Dual-Band Wi-Fi 7 Router	Date of Test	2024-02-06
Factor	DRH18-E	Temp. / Humidity	20°C /65%
Polarity	Horizontal	Site / Test Engineer	AC2 / Marvin
Test Mode	802.11ax-20MHz_TX_Band4_CH 149_ANT 0+1	Test Voltage	AC 120V/60Hz

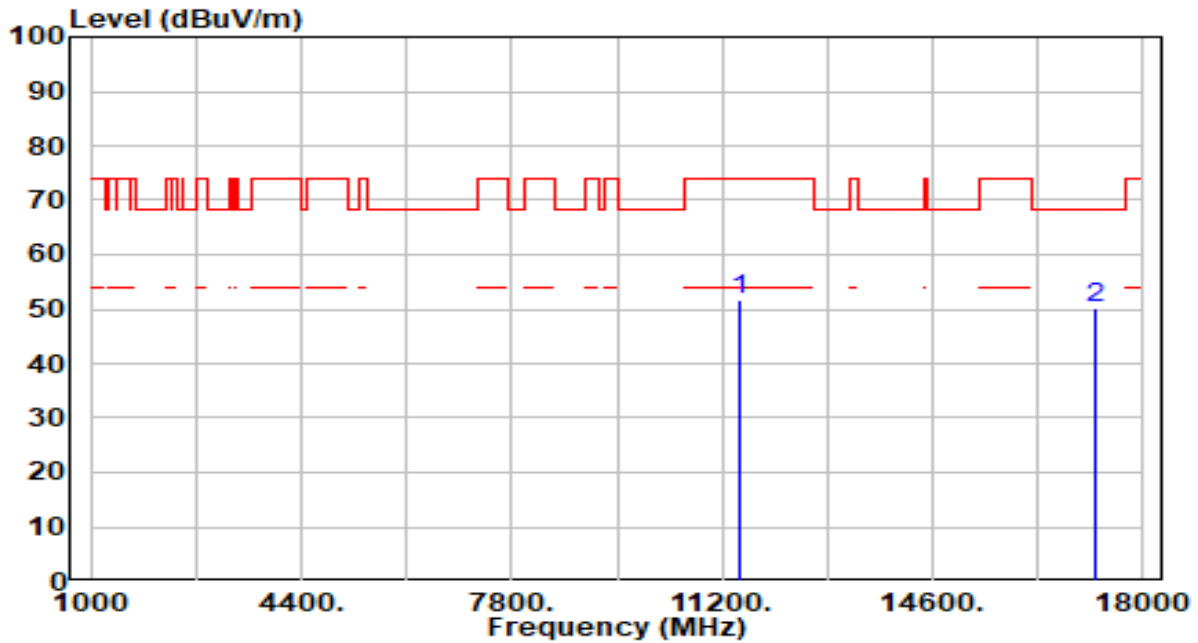

No	Frequency (MHz)	Reading (dBuV)	C.F (dB/m)	Measurement (dBuV/m)	Margin (dB)	Limit (dBuV/m)	Height (cm)	Angle (deg)	Remark (QP/PK/AV)
1	11490.000	46.50	5.32	51.81	-22.19	74.00	100	329	Peak
2	* 17235.000	44.58	5.71	50.29	-17.91	68.20	100	131	Peak

Note:

1. " *", means this data is the worst emission level.
2. C.F (Correction Factor) = Antenna Factor (dB/m)+ Cable Loss (dB) – Pre-amplifier(dB).
3. Measurement (dBuV/m) = Reading(dBuV) + C.F (Correction Factor).
4. The emission levels of other frequencies are very lower than the limit and not show in test report.

EUT	BE3600 Dual-Band Wi-Fi 7 Router	Date of Test	2024-02-06
Factor	DRH18-E	Temp. / Humidity	20°C /65%
Polarity	Vertical	Site / Test Engineer	AC2 / Marvin
Test Mode	802.11ax-20MHz_TX_Band4_CH 149_ANT 0+1	Test Voltage	AC 120V/60Hz

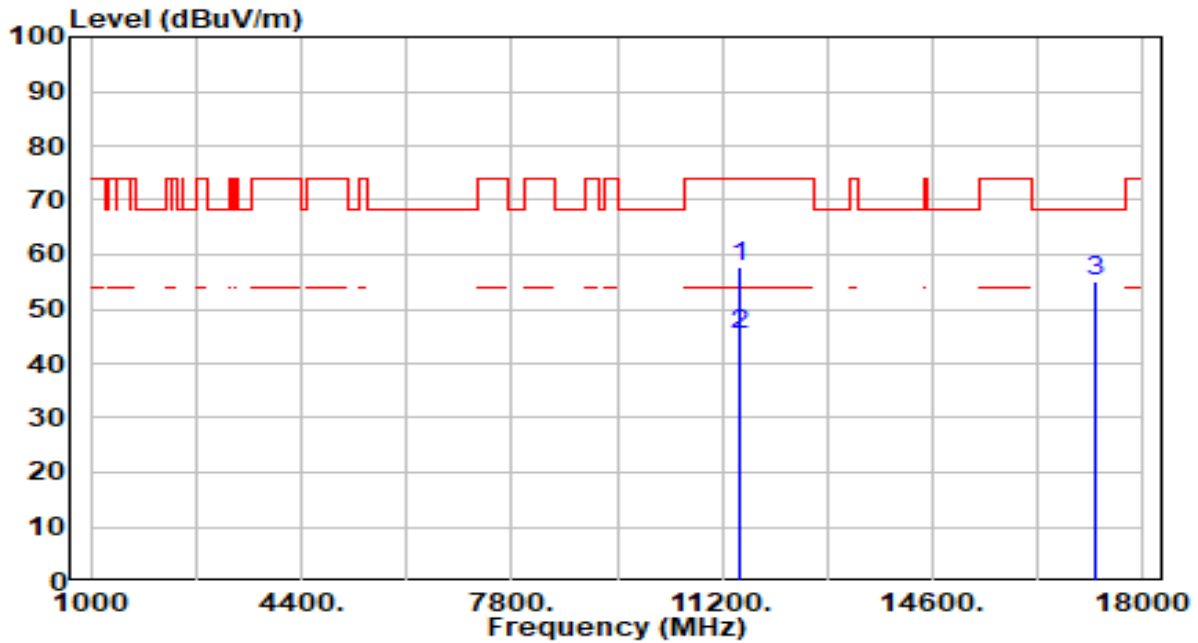

No	Frequency (MHz)	Reading (dBuV)	C.F (dB/m)	Measurement (dBuV/m)	Margin (dB)	Limit (dBuV/m)	Height (cm)	Angle (deg)	Remark (QP/PK/AV)
1	11490.000	52.33	5.32	57.65	-16.35	74.00	100	238	Peak
2	* 11490.000	40.00	5.32	45.32	-8.68	54.00	100	238	Average
3	* 17235.000	49.55	5.71	55.26	-12.94	68.20	100	256	Peak

Note:

1. " *", means this data is the worst emission level.
2. C.F (Correction Factor) = Antenna Factor (dB/m)+ Cable Loss (dB) – Preamplifier(dB).
3. Measurement (dBuV/m) = Reading(dBuV) + C.F (Correction Factor).
4. The emission levels of other frequencies are very lower than the limit and not show in test report.

EUT	BE3600 Dual-Band Wi-Fi 7 Router	Date of Test	2024-02-06
Factor	DRH18-E	Temp. / Humidity	20°C /65%
Polarity	Horizontal	Site / Test Engineer	AC2 / Marvin
Test Mode	802.11ax-20MHz_TX_Band4_CH 157_ANT 0+1	Test Voltage	AC 120V/60Hz

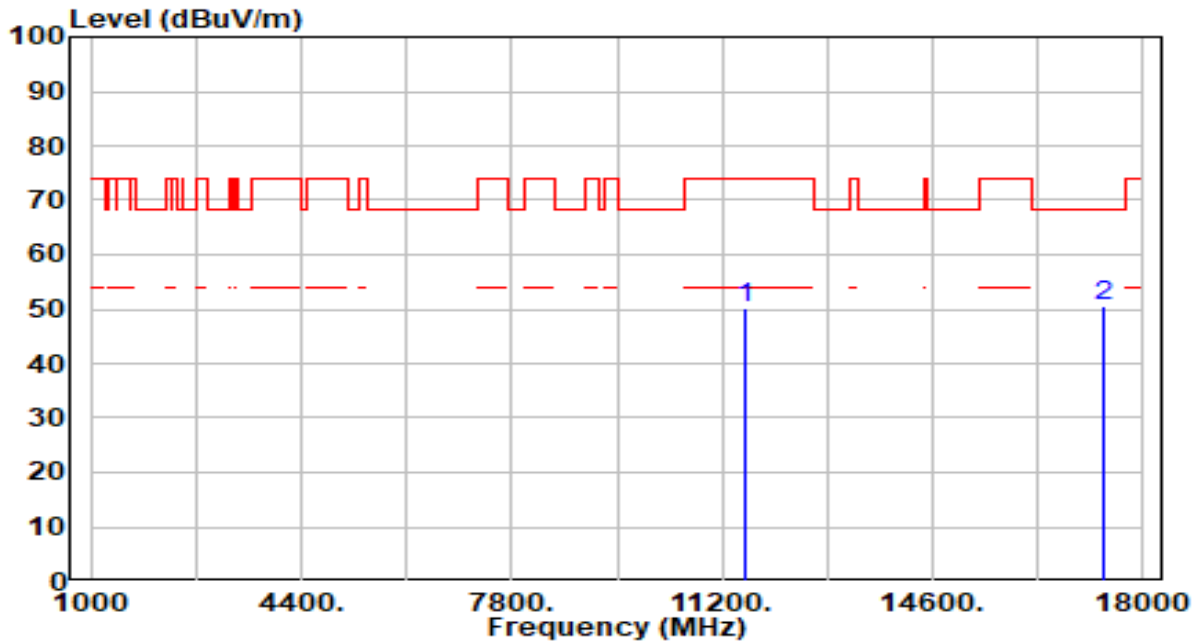

No	Frequency (MHz)	Reading (dBuV)	C.F (dB/m)	Measurement (dBuV/m)	Margin (dB)	Limit (dBuV/m)	Height (cm)	Angle (deg)	Remark (QP/PK/AV)
1	11570.000	44.64	5.38	50.02	-23.98	74.00	100	35	Peak
2	* 17355.000	45.05	5.39	50.43	-17.77	68.20	100	140	Peak

Note:

1. " *", means this data is the worst emission level.
2. C.F (Correction Factor) = Antenna Factor (dB/m)+ Cable Loss (dB) – Pre-amplifier(dB).
3. Measurement (dBuV/m) = Reading(dBuV) + C.F (Correction Factor).
4. The emission levels of other frequencies are very lower than the limit and not show in test report.

EUT	BE3600 Dual-Band Wi-Fi 7 Router	Date of Test	2024-02-06
Factor	DRH18-E	Temp. / Humidity	20°C /65%
Polarity	Vertical	Site / Test Engineer	AC2 / Marvin
Test Mode	802.11ax-20MHz_TX_Band4_CH 157_ANT 0+1	Test Voltage	AC 120V/60Hz

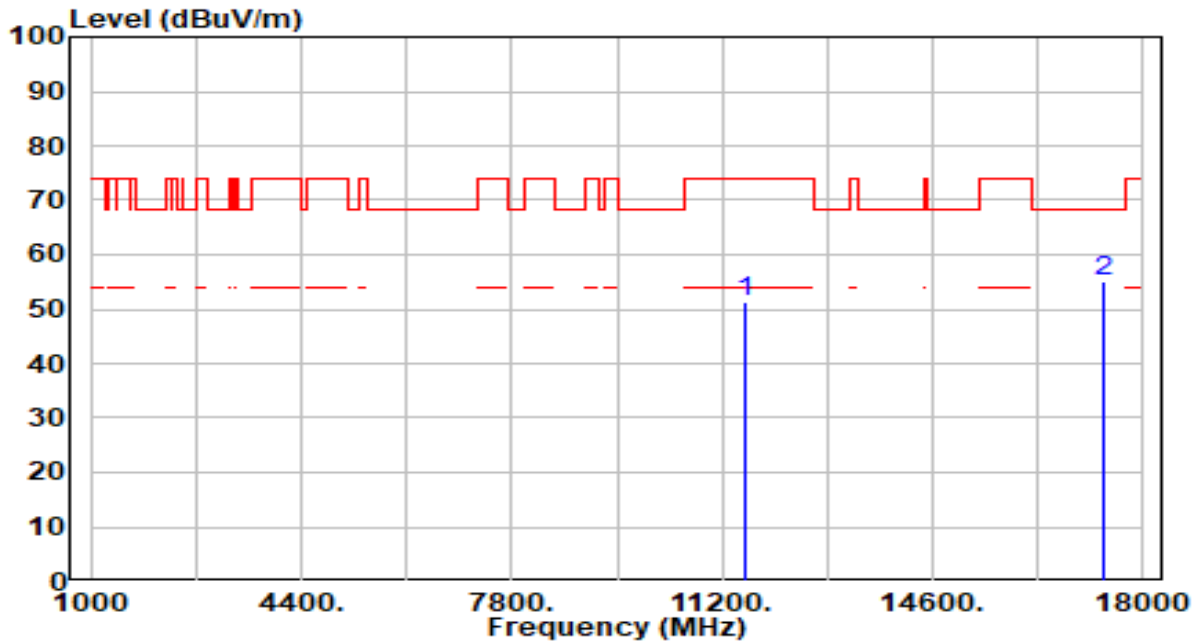

No	Frequency (MHz)	Reading (dBuV)	C.F (dB/m)	Measurement (dBuV/m)	Margin (dB)	Limit (dBuV/m)	Height (cm)	Angle (deg)	Remark (QP/PK/AV)
1	11570.000	45.81	5.38	51.19	-22.81	74.00	100	216	Peak
2	* 17355.000	49.82	5.39	55.21	-12.99	68.20	100	250	Peak

Note:

1. " *", means this data is the worst emission level.
2. C.F (Correction Factor) = Antenna Factor (dB/m)+ Cable Loss (dB) – Pre-amplifier(dB).
3. Measurement (dBuV/m) = Reading(dBuV) + C.F (Correction Factor).
4. The emission levels of other frequencies are very lower than the limit and not show in test report.

EUT	BE3600 Dual-Band Wi-Fi 7 Router	Date of Test	2024-02-06
Factor	DRH18-E	Temp. / Humidity	20°C /65%
Polarity	Horizontal	Site / Test Engineer	AC2 / Marvin
Test Mode	802.11ax-20MHz_TX_Band4_CH 165_ANT 0+1	Test Voltage	AC 120V/60Hz

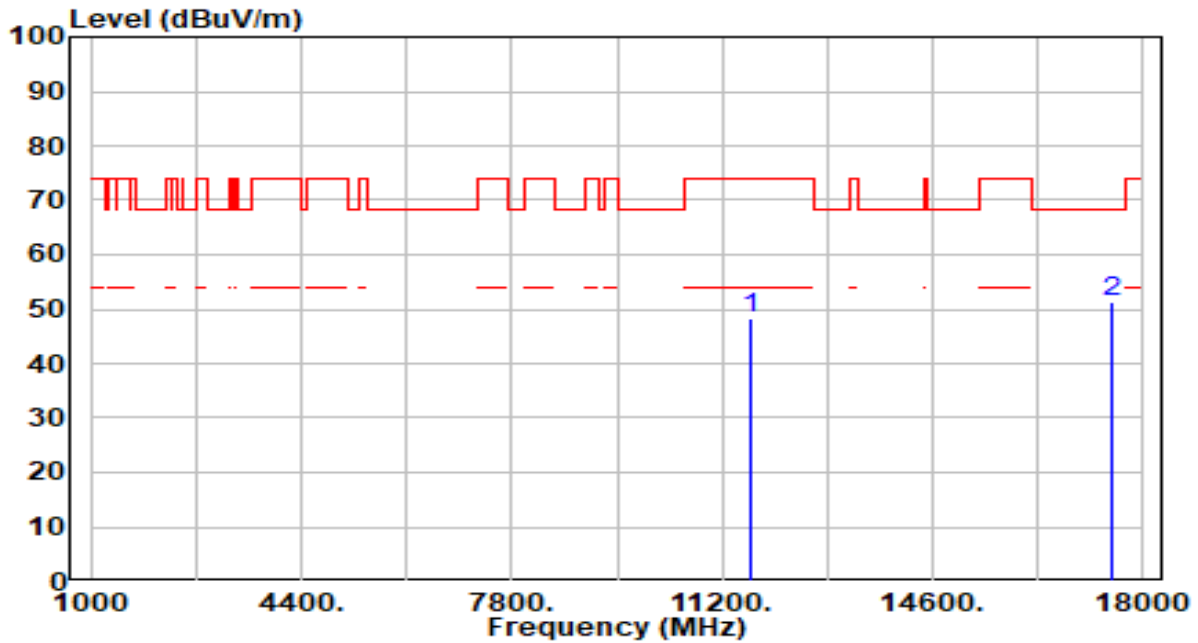

No	Frequency (MHz)	Reading (dBuV)	C.F (dB/m)	Measurement (dBuV/m)	Margin (dB)	Limit (dBuV/m)	Height (cm)	Angle (deg)	Remark (QP/PK/AV)
1	11650.000	43.04	5.36	48.41	-25.59	74.00	100	68	Peak
2	* 17475.000	45.87	5.29	51.16	-17.04	68.20	100	28	Peak

Note:

1. " *", means this data is the worst emission level.
2. C.F (Correction Factor) = Antenna Factor (dB/m)+ Cable Loss (dB) – Pre-amplifier(dB).
3. Measurement (dBuV/m) = Reading(dBuV) + C.F (Correction Factor).
4. The emission levels of other frequencies are very lower than the limit and not show in test report.

EUT	BE3600 Dual-Band Wi-Fi 7 Router	Date of Test	2024-02-06
Factor	DRH18-E	Temp. / Humidity	20°C /65%
Polarity	Vertical	Site / Test Engineer	AC2 / Marvin
Test Mode	802.11ax-20MHz_TX_Band4_CH 165_ANT 0+1	Test Voltage	AC 120V/60Hz

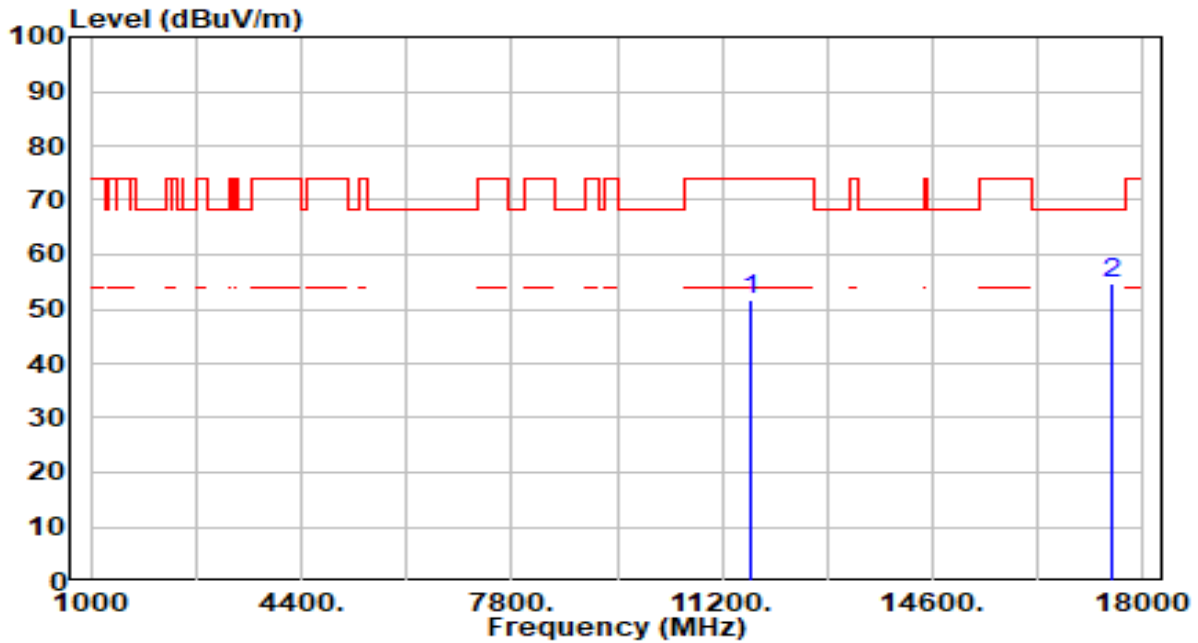

No	Frequency (MHz)	Reading (dBuV)	C.F (dB/m)	Measurement (dBuV/m)	Margin (dB)	Limit (dBuV/m)	Height (cm)	Angle (deg)	Remark (QP/PK/AV)
1	11650.000	46.19	5.36	51.55	-22.45	74.00	100	256	Peak
2	* 17475.000	49.41	5.29	54.70	-13.50	68.20	100	251	Peak

Note:

1. " *", means this data is the worst emission level.
2. C.F (Correction Factor) = Antenna Factor (dB/m)+ Cable Loss (dB) – Pre-amplifier(dB).
3. Measurement (dBuV/m) = Reading(dBuV) + C.F (Correction Factor).
4. The emission levels of other frequencies are very lower than the limit and not show in test report.

EUT	BE3600 Dual-Band Wi-Fi 7 Router	Date of Test	2024-02-06
Factor	DRH18-E	Temp. / Humidity	20°C /65%
Polarity	Horizontal	Site / Test Engineer	AC2 / Marvin
Test Mode	802.11ax-40MHz_TX_Band1_CH 38_ANT 0+1	Test Voltage	AC 120V/60Hz

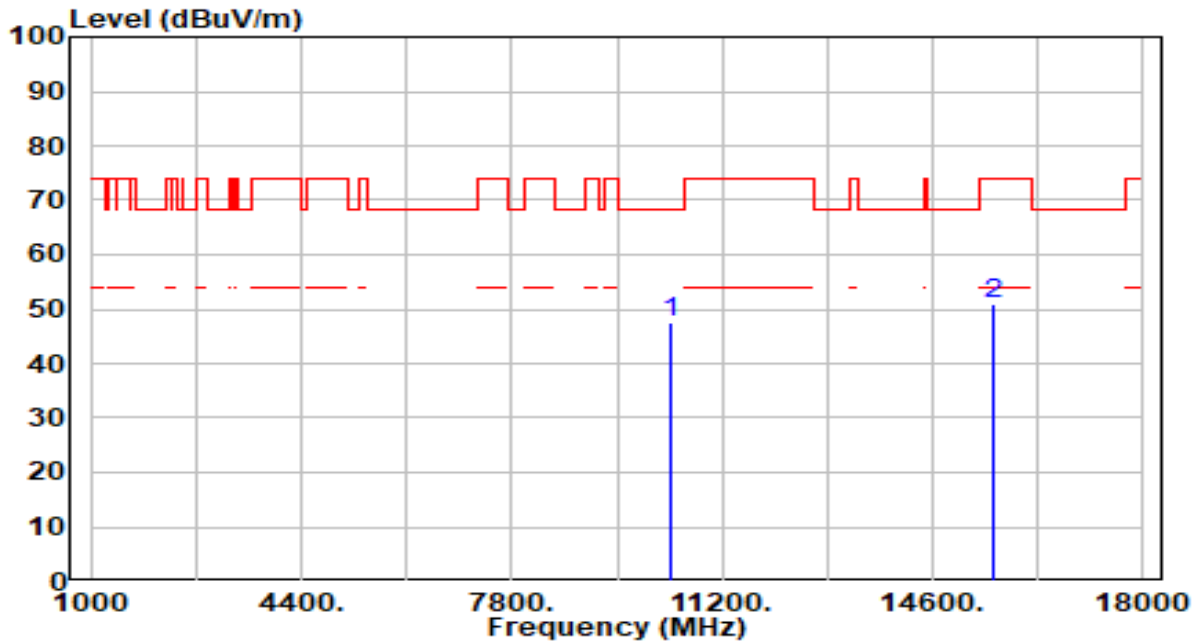

No	Frequency (MHz)	Reading (dBuV)	C.F (dB/m)	Measurement (dBuV/m)	Margin (dB)	Limit (dBuV/m)	Height (cm)	Angle (deg)	Remark (QP/PK/AV)
1	* 10380.000	42.63	4.84	47.48	-20.72	68.20	100	1	Peak
2	15570.000	44.68	6.18	50.86	-23.14	74.00	100	226	Peak

Note:

- "*", means this data is the worst emission level.
- C.F (Correction Factor) = Antenna Factor (dB/m)+ Cable Loss (dB) – Pre-amplifier(dB).
- Measurement (dBuV/m) = Reading(dBuV) + C.F (Correction Factor).
- The emission levels of other frequencies are very lower than the limit and not show in test report.

EUT	BE3600 Dual-Band Wi-Fi 7 Router	Date of Test	2024-02-06
Factor	DRH18-E	Temp. / Humidity	20°C /65%
Polarity	Vertical	Site / Test Engineer	AC2 / Marvin
Test Mode	802.11ax-40MHz_TX_Band1_CH 38_ANT 0+1	Test Voltage	AC 120V/60Hz

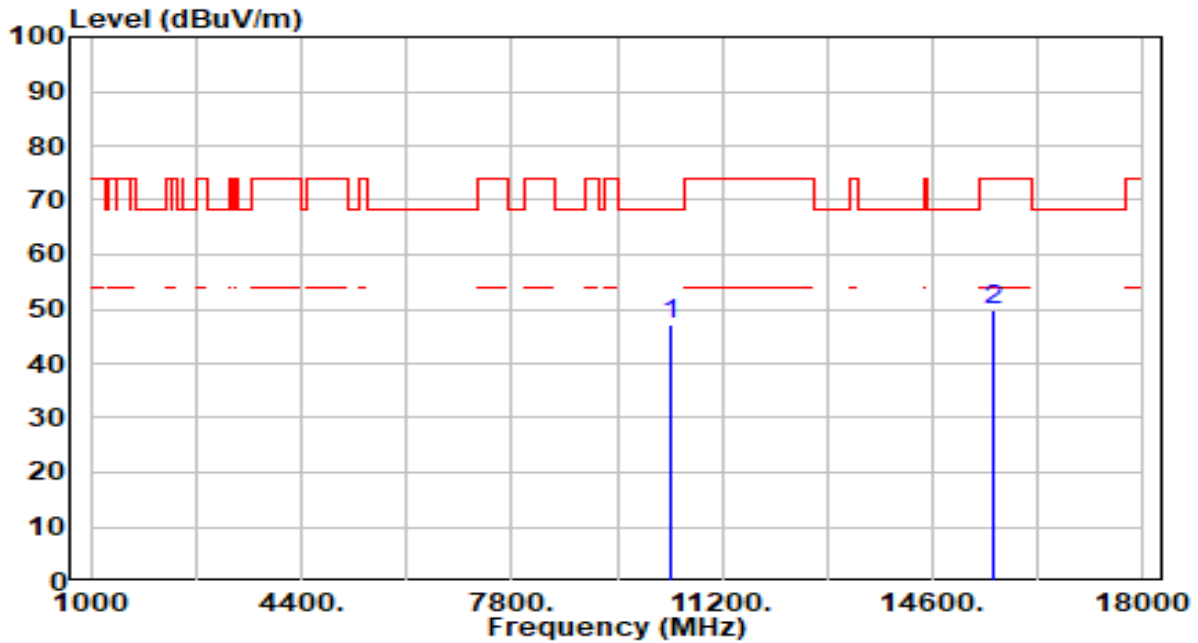

No	Frequency (MHz)	Reading (dBuV)	C.F (dB/m)	Measurement (dBuV/m)	Margin (dB)	Limit (dBuV/m)	Height (cm)	Angle (deg)	Remark (QP/PK/AV)
1	* 10380.000	42.50	4.84	47.34	-20.86	68.20	100	261	Peak
2	15570.000	43.78	6.18	49.96	-24.04	74.00	100	42	Peak

Note:

- "*", means this data is the worst emission level.
- C.F (Correction Factor) = Antenna Factor (dB/m)+ Cable Loss (dB) – Pre-amplifier(dB).
- Measurement (dBuV/m) = Reading(dBuV) + C.F (Correction Factor).
- The emission levels of other frequencies are very lower than the limit and not show in test report.

EUT	BE3600 Dual-Band Wi-Fi 7 Router	Date of Test	2024-02-06
Factor	DRH18-E	Temp. / Humidity	20°C /65%
Polarity	Horizontal	Site / Test Engineer	AC2 / Marvin
Test Mode	802.11ax-40MHz_TX_Band1_CH 46_ANT 0+1	Test Voltage	AC 120V/60Hz

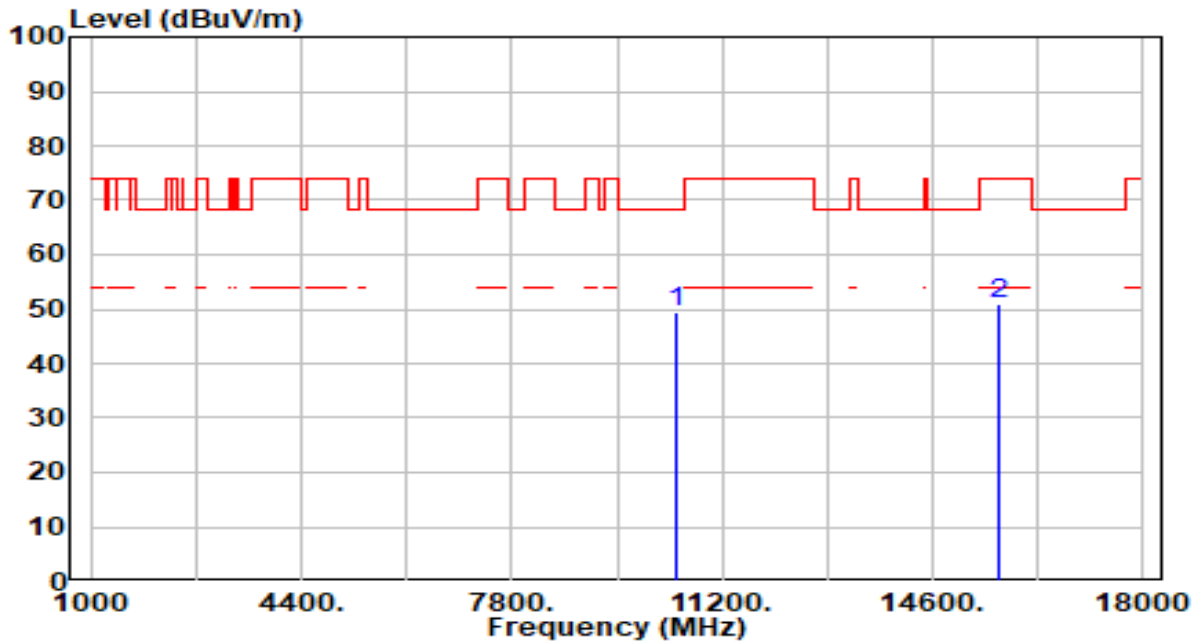

No	Frequency (MHz)	Reading (dBuV)	C.F (dB/m)	Measurement (dBuV/m)	Margin (dB)	Limit (dBuV/m)	Height (cm)	Angle (deg)	Remark (QP/PK/AV)
1	* 10460.000	44.84	4.74	49.58	-18.62	68.20	100	183	Peak
2	15690.000	44.71	6.33	51.04	-22.96	74.00	100	280	Peak

Note:

1. " *", means this data is the worst emission level.
2. C.F (Correction Factor) = Antenna Factor (dB/m)+ Cable Loss (dB) – Pre-amplifier(dB).
3. Measurement (dBuV/m) = Reading(dBuV) + C.F (Correction Factor).
4. The emission levels of other frequencies are very lower than the limit and not show in test report.

EUT	BE3600 Dual-Band Wi-Fi 7 Router	Date of Test	2024-02-06
Factor	DRH18-E	Temp. / Humidity	20°C /65%
Polarity	Vertical	Site / Test Engineer	AC2 / Marvin
Test Mode	802.11ax-40MHz_TX_Band1_CH 46_ANT 0+1	Test Voltage	AC 120V/60Hz

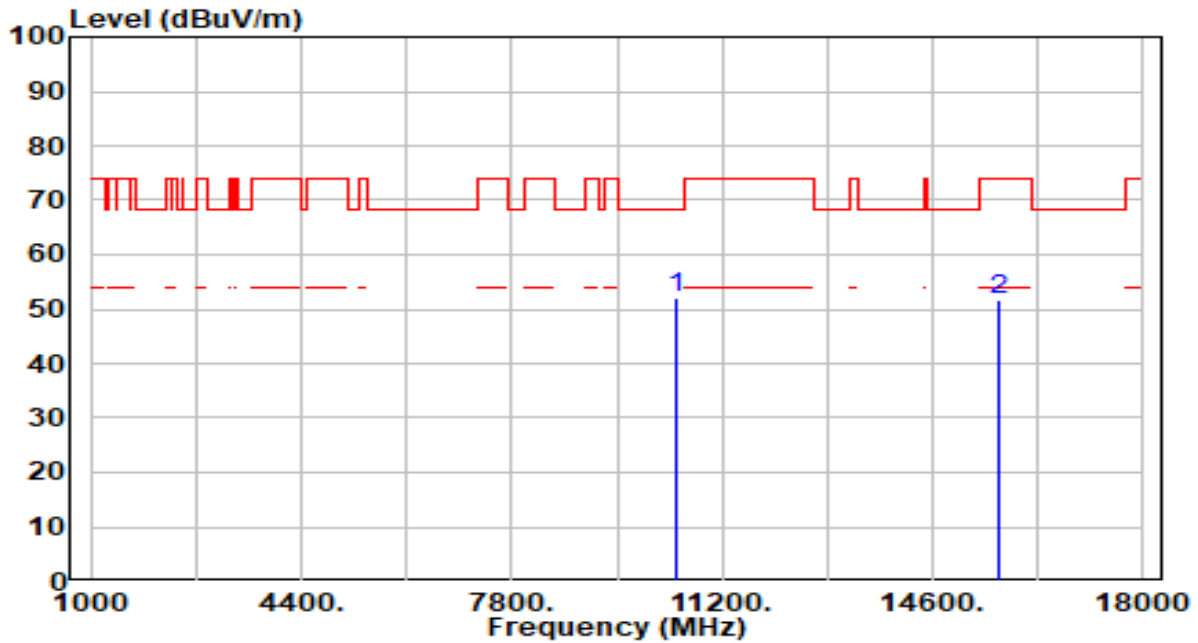

No	Frequency (MHz)	Reading (dBuV)	C.F (dB/m)	Measurement (dBuV/m)	Margin (dB)	Limit (dBuV/m)	Height (cm)	Angle (deg)	Remark (QP/PK/AV)
1	* 10460.000	47.36	4.74	52.10	-16.10	68.20	100	144	Peak
2	15690.000	45.51	6.33	51.84	-22.16	74.00	100	258	Peak

Note:

1. " *", means this data is the worst emission level.
2. C.F (Correction Factor) = Antenna Factor (dB/m)+ Cable Loss (dB) – Pre-amplifier(dB).
3. Measurement (dBuV/m) = Reading(dBuV) + C.F (Correction Factor).
4. The emission levels of other frequencies are very lower than the limit and not show in test report.

EUT	BE3600 Dual-Band Wi-Fi 7 Router	Date of Test	2024-02-06
Factor	DRH18-E	Temp. / Humidity	20°C /65%
Polarity	Horizontal	Site / Test Engineer	AC2 / Marvin
Test Mode	802.11ax-40MHz_TX_Band2_CH 54_ANT 0+1	Test Voltage	AC 120V/60Hz

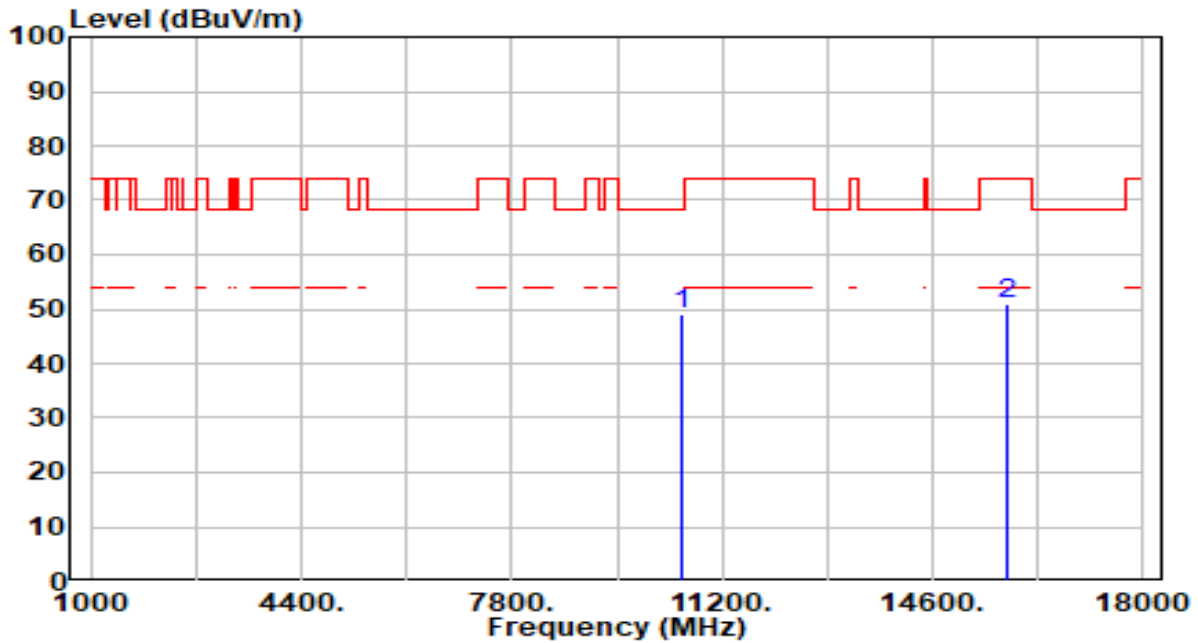

No	Frequency (MHz)	Reading (dBuV)	C.F (dB/m)	Measurement (dBuV/m)	Margin (dB)	Limit (dBuV/m)	Height (cm)	Angle (deg)	Remark (QP/PK/AV)
1	* 10540.000	44.25	4.66	48.91	-19.29	68.20	100	213	Peak
2	15810.000	44.54	6.55	51.09	-22.91	74.00	100	128	Peak

Note:

1. " *", means this data is the worst emission level.
2. C.F (Correction Factor) = Antenna Factor (dB/m)+ Cable Loss (dB) – Pre-amplifier(dB).
3. Measurement (dBuV/m) = Reading(dBuV) + C.F (Correction Factor).
4. The emission levels of other frequencies are very lower than the limit and not show in test report.

EUT	BE3600 Dual-Band Wi-Fi 7 Router	Date of Test	2024-02-06
Factor	DRH18-E	Temp. / Humidity	20°C /65%
Polarity	Vertical	Site / Test Engineer	AC2 / Marvin
Test Mode	802.11ax-40MHz_TX_Band2_CH 54_ANT 0+1	Test Voltage	AC 120V/60Hz

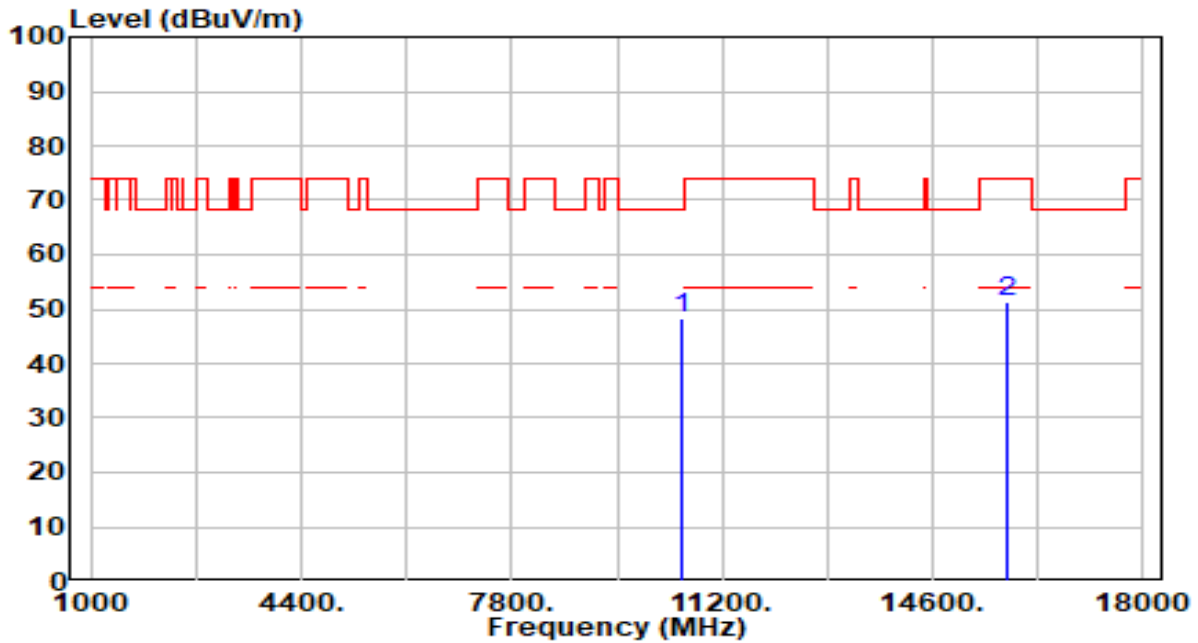

No	Frequency (MHz)	Reading (dBuV)	C.F (dB/m)	Measurement (dBuV/m)	Margin (dB)	Limit (dBuV/m)	Height (cm)	Angle (deg)	Remark (QP/PK/AV)
1	* 10540.000	43.72	4.66	48.38	-19.82	68.20	100	310	Peak
2	15810.000	44.92	6.55	51.46	-22.54	74.00	100	48	Peak

Note:

1. " *", means this data is the worst emission level.
2. C.F (Correction Factor) = Antenna Factor (dB/m)+ Cable Loss (dB) – Pre-amplifier(dB).
3. Measurement (dBuV/m) = Reading(dBuV) + C.F (Correction Factor).
4. The emission levels of other frequencies are very lower than the limit and not show in test report.

EUT	BE3600 Dual-Band Wi-Fi 7 Router	Date of Test	2024-02-06
Factor	DRH18-E	Temp. / Humidity	20°C /65%
Polarity	Horizontal	Site / Test Engineer	AC2 / Marvin
Test Mode	802.11ax-40MHz_TX_Band2_CH 62_ANT 0+1	Test Voltage	AC 120V/60Hz

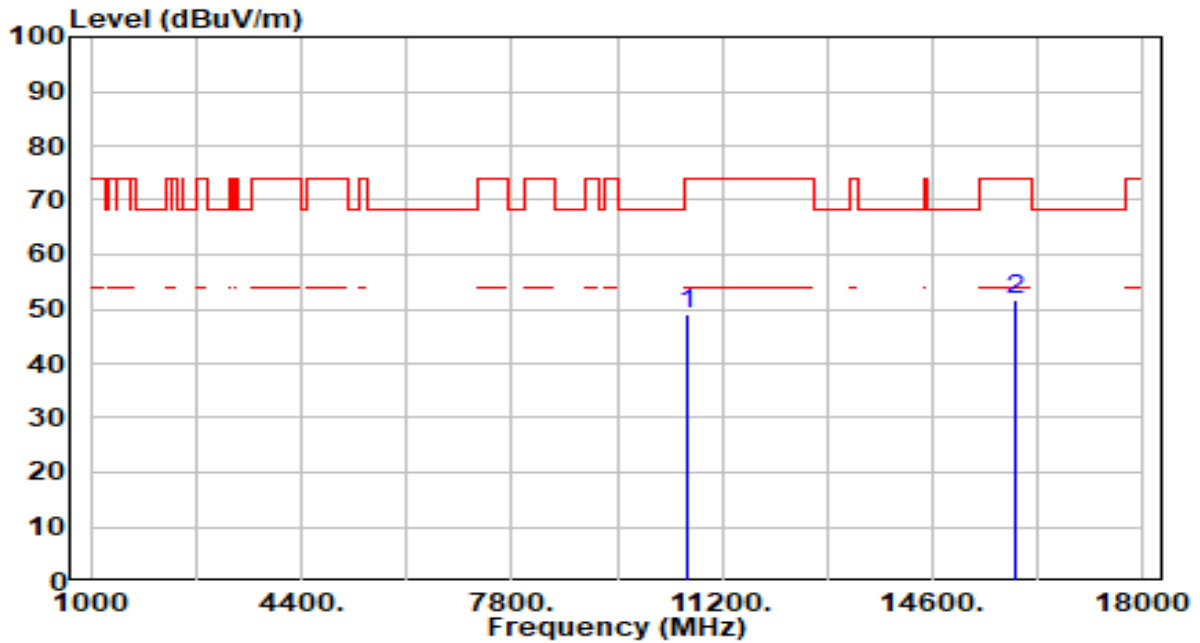

No	Frequency (MHz)	Reading (dBuV)	C.F (dB/m)	Measurement (dBuV/m)	Margin (dB)	Limit (dBuV/m)	Height (cm)	Angle (deg)	Remark (QP/PK/AV)
1	10620.000	44.28	4.62	48.90	-25.10	74.00	100	209	Peak
2	* 15930.000	45.16	6.55	51.71	-22.29	74.00	100	127	Peak

Note:

1. " *", means this data is the worst emission level.
2. C.F (Correction Factor) = Antenna Factor (dB/m)+ Cable Loss (dB) – Pre-amplifier(dB).
3. Measurement (dBuV/m) = Reading(dBuV) + C.F (Correction Factor).
4. The emission levels of other frequencies are very lower than the limit and not show in test report.

EUT	BE3600 Dual-Band Wi-Fi 7 Router	Date of Test	2024-02-06
Factor	DRH18-E	Temp. / Humidity	20°C /65%
Polarity	Vertical	Site / Test Engineer	AC2 / Marvin
Test Mode	802.11ax-40MHz_TX_Band2_CH 62_ANT 0+1	Test Voltage	AC 120V/60Hz

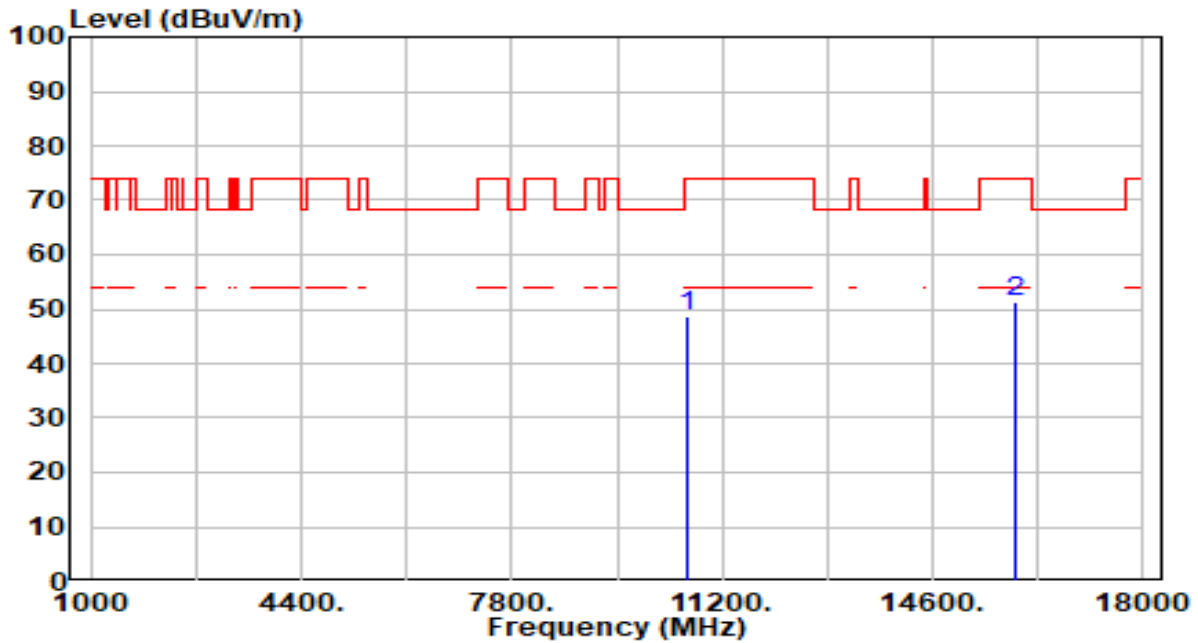

No	Frequency (MHz)	Reading (dBuV)	C.F (dB/m)	Measurement (dBuV/m)	Margin (dB)	Limit (dBuV/m)	Height (cm)	Angle (deg)	Remark (QP/PK/AV)
1	10620.000	43.97	4.62	48.58	-25.42	74.00	100	59	Peak
2	* 15930.000	44.60	6.55	51.15	-22.85	74.00	100	234	Peak

Note:

1. " *", means this data is the worst emission level.
2. C.F (Correction Factor) = Antenna Factor (dB/m)+ Cable Loss (dB) – Pre-amplifier(dB).
3. Measurement (dBuV/m) = Reading(dBuV) + C.F (Correction Factor).
4. The emission levels of other frequencies are very lower than the limit and not show in test report.

EUT	BE3600 Dual-Band Wi-Fi 7 Router	Date of Test	2024-02-06
Factor	DRH18-E	Temp. / Humidity	20°C /65%
Polarity	Horizontal	Site / Test Engineer	AC2 / Marvin
Test Mode	802.11ax-40MHz_TX_Band3_CH 102_ANT 0+1	Test Voltage	AC 120V/60Hz

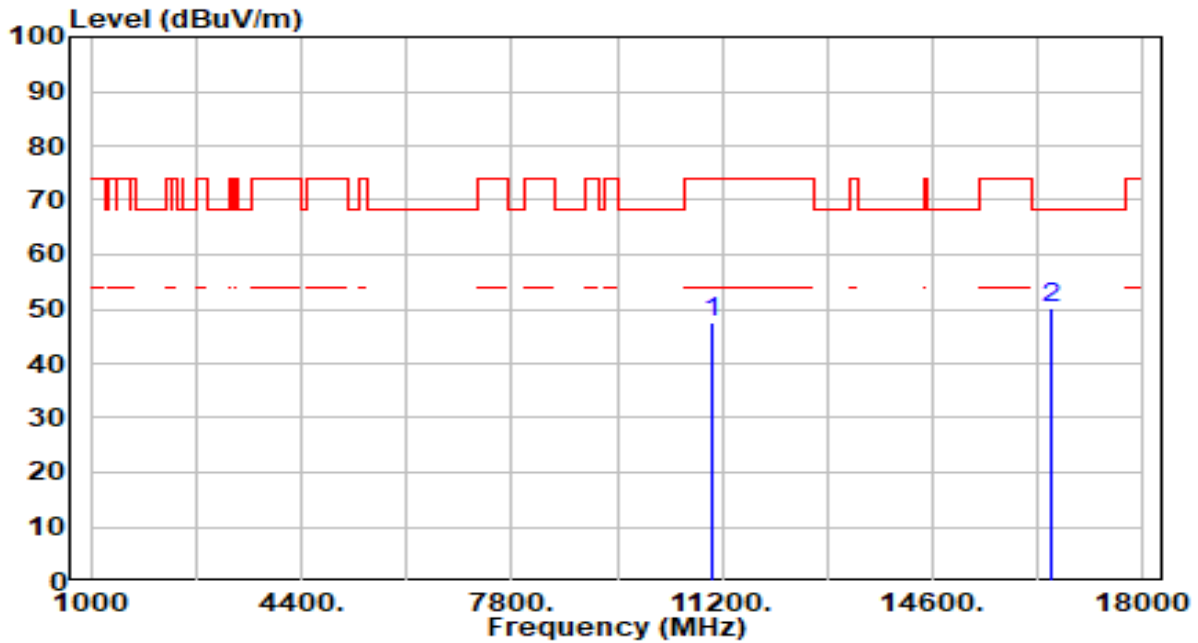

No	Frequency (MHz)	Reading (dBuV)	C.F (dB/m)	Measurement (dBuV/m)	Margin (dB)	Limit (dBuV/m)	Height (cm)	Angle (deg)	Remark (QP/PK/AV)
1	11020.000	42.84	4.57	47.41	-26.59	74.00	100	212	Peak
2	* 16530.000	44.14	6.10	50.25	-17.95	68.20	100	1	Peak

Note:

1. " *", means this data is the worst emission level.
2. C.F (Correction Factor) = Antenna Factor (dB/m)+ Cable Loss (dB) – Pre-amplifier(dB).
3. Measurement (dBuV/m) = Reading(dBuV) + C.F (Correction Factor).
4. The emission levels of other frequencies are very lower than the limit and not show in test report.

EUT	BE3600 Dual-Band Wi-Fi 7 Router	Date of Test	2024-02-06
Factor	DRH18-E	Temp. / Humidity	20°C /65%
Polarity	Vertical	Site / Test Engineer	AC2 / Marvin
Test Mode	802.11ax-40MHz_TX_Band3_CH 102_ANT 0+1	Test Voltage	AC 120V/60Hz

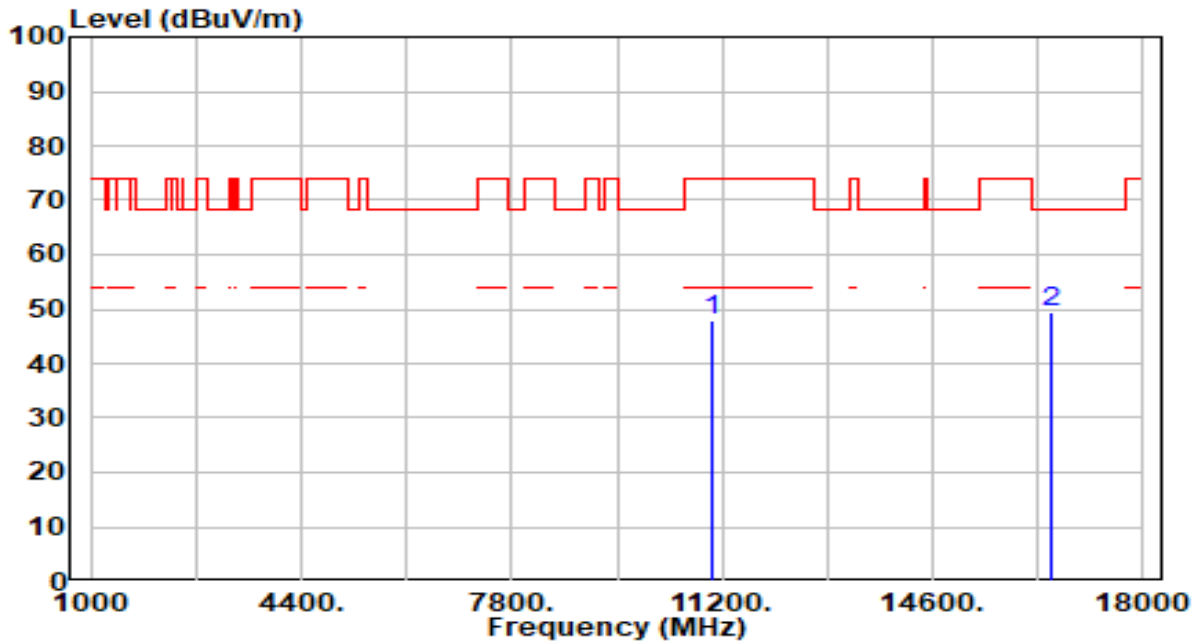

No	Frequency (MHz)	Reading (dBuV)	C.F (dB/m)	Measurement (dBuV/m)	Margin (dB)	Limit (dBuV/m)	Height (cm)	Angle (deg)	Remark (QP/PK/AV)
1	11020.000	43.23	4.57	47.81	-26.19	74.00	100	191	Peak
2	* 16530.000	43.51	6.10	49.62	-18.58	68.20	100	254	Peak

Note:

- "*", means this data is the worst emission level.
- C.F (Correction Factor) = Antenna Factor (dB/m)+ Cable Loss (dB) – Pre-amplifier(dB).
- Measurement (dBuV/m) = Reading(dBuV) + C.F (Correction Factor).
- The emission levels of other frequencies are very lower than the limit and not show in test report.

EUT	BE3600 Dual-Band Wi-Fi 7 Router	Date of Test	2024-02-06
Factor	DRH18-E	Temp. / Humidity	20°C /65%
Polarity	Horizontal	Site / Test Engineer	AC2 / Marvin
Test Mode	802.11ax-40MHz_TX_Band3_CH 110_ANT 0+1	Test Voltage	AC 120V/60Hz

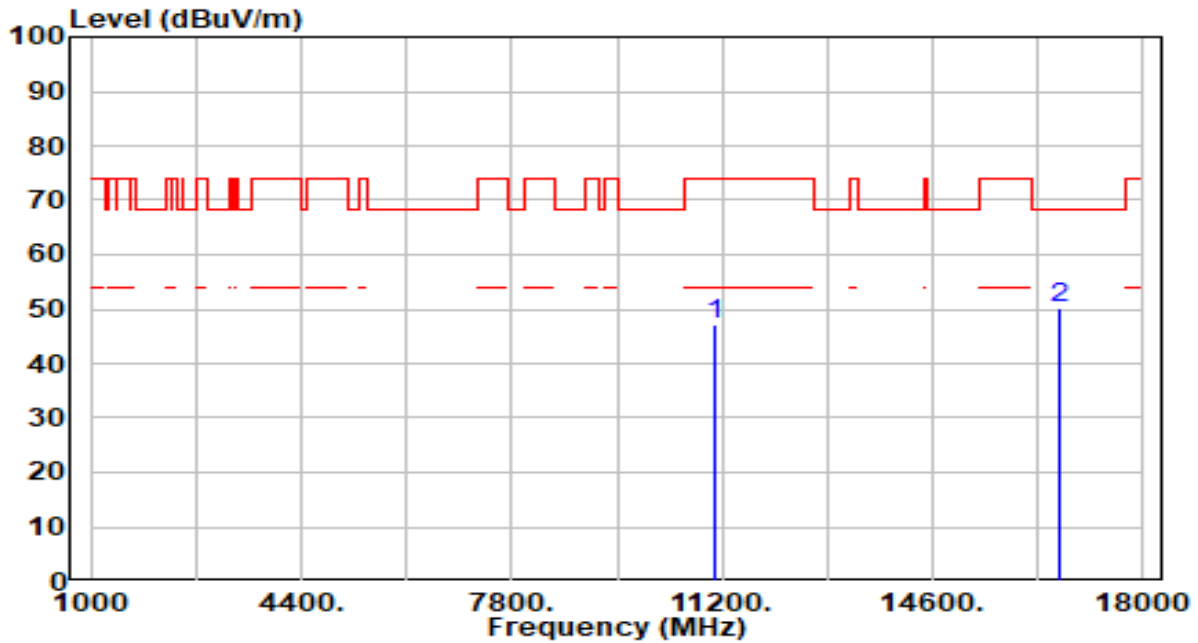

No	Frequency (MHz)	Reading (dBuV)	C.F (dB/m)	Measurement (dBuV/m)	Margin (dB)	Limit (dBuV/m)	Height (cm)	Angle (deg)	Remark (QP/PK/AV)
1	11100.000	42.35	4.78	47.13	-26.87	74.00	100	12	Peak
2	* 16650.000	44.12	6.14	50.25	-17.95	68.20	100	232	Peak

Note:

1. " *", means this data is the worst emission level.
2. C.F (Correction Factor) = Antenna Factor (dB/m)+ Cable Loss (dB) – Pre-amplifier(dB).
3. Measurement (dBuV/m) = Reading(dBuV) + C.F (Correction Factor).
4. The emission levels of other frequencies are very lower than the limit and not show in test report.

EUT	BE3600 Dual-Band Wi-Fi 7 Router	Date of Test	2024-02-06
Factor	DRH18-E	Temp. / Humidity	20°C /65%
Polarity	Vertical	Site / Test Engineer	AC2 / Marvin
Test Mode	802.11ax-40MHz_TX_Band3_CH 110_ANT 0+1	Test Voltage	AC 120V/60Hz

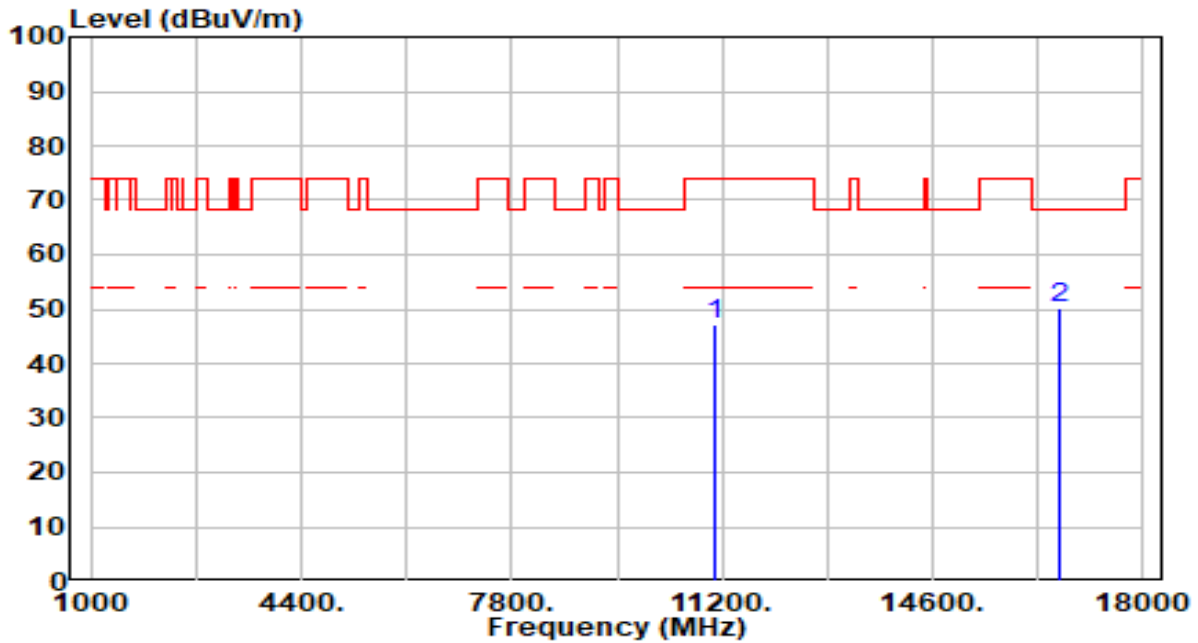

No	Frequency (MHz)	Reading (dBuV)	C.F (dB/m)	Measurement (dBuV/m)	Margin (dB)	Limit (dBuV/m)	Height (cm)	Angle (deg)	Remark (QP/PK/AV)
1	11100.000	42.57	4.78	47.35	-26.65	74.00	100	141	Peak
2	* 16650.000	44.14	6.14	50.27	-17.93	68.20	100	329	Peak

Note:

1. " *", means this data is the worst emission level.
2. C.F (Correction Factor) = Antenna Factor (dB/m)+ Cable Loss (dB) – Pre-amplifier(dB).
3. Measurement (dBuV/m) = Reading(dBuV) + C.F (Correction Factor).
4. The emission levels of other frequencies are very lower than the limit and not show in test report.

EUT	BE3600 Dual-Band Wi-Fi 7 Router	Date of Test	2024-02-06
Factor	DRH18-E	Temp. / Humidity	20°C /65%
Polarity	Horizontal	Site / Test Engineer	AC2 / Marvin
Test Mode	802.11ax-40MHz_TX_Band3_CH 134_ANT 0+1	Test Voltage	AC 120V/60Hz

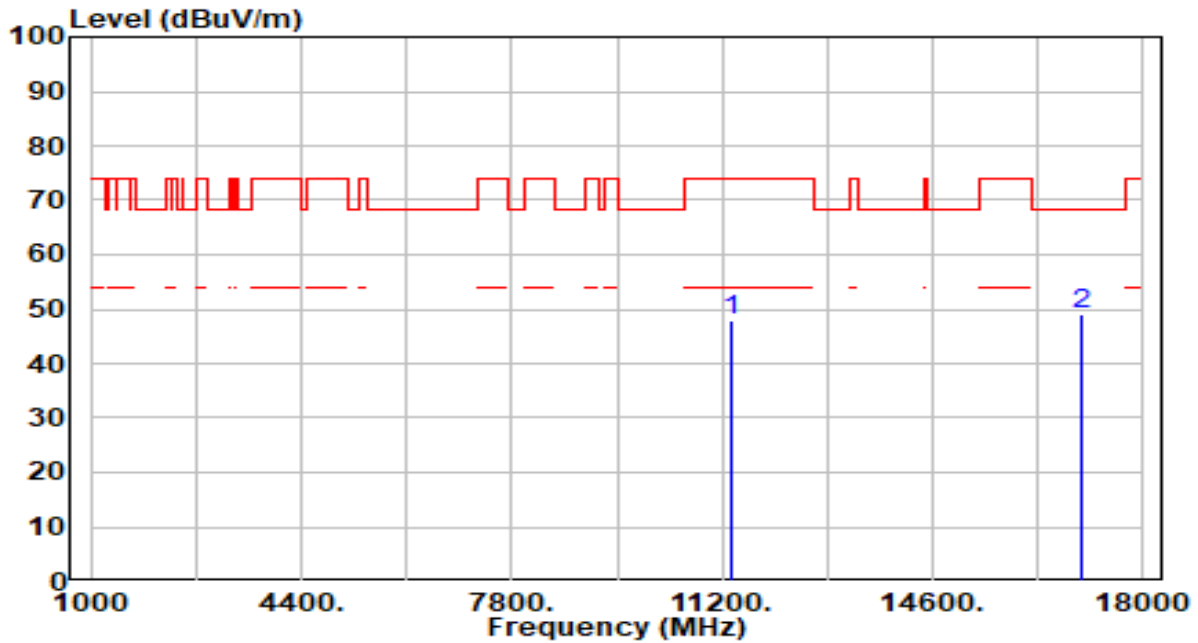

No	Frequency (MHz)	Reading (dBuV)	C.F (dB/m)	Measurement (dBuV/m)	Margin (dB)	Limit (dBuV/m)	Height (cm)	Angle (deg)	Remark (QP/PK/AV)
1	11340.000	42.54	5.20	47.74	-26.26	74.00	100	189	Peak
2	* 17010.000	43.04	6.12	49.17	-19.03	68.20	100	309	Peak

Note:

1. " *", means this data is the worst emission level.
2. C.F (Correction Factor) = Antenna Factor (dB/m)+ Cable Loss (dB) – Pre-amplifier(dB).
3. Measurement (dBuV/m) = Reading(dBuV) + C.F (Correction Factor).
4. The emission levels of other frequencies are very lower than the limit and not show in test report.

EUT	BE3600 Dual-Band Wi-Fi 7 Router	Date of Test	2024-02-06
Factor	DRH18-E	Temp. / Humidity	20°C /65%
Polarity	Vertical	Site / Test Engineer	AC2 / Marvin
Test Mode	802.11ax-40MHz_TX_Band3_CH 134_ANT 0+1	Test Voltage	AC 120V/60Hz

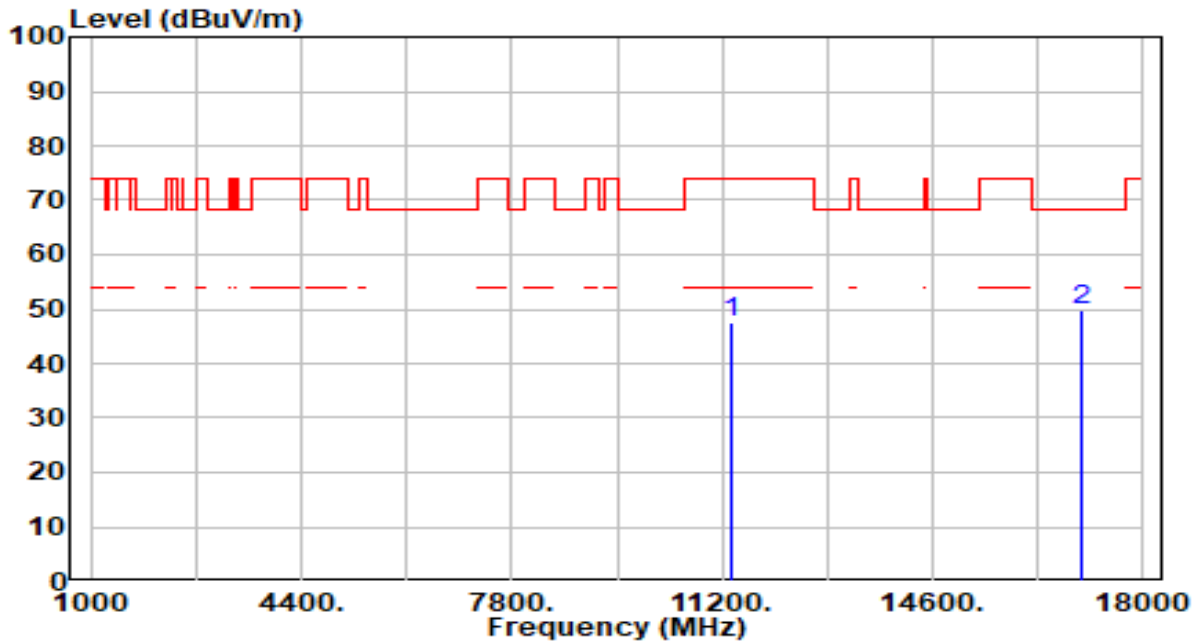

No	Frequency (MHz)	Reading (dBuV)	C.F (dB/m)	Measurement (dBuV/m)	Margin (dB)	Limit (dBuV/m)	Height (cm)	Angle (deg)	Remark (QP/PK/AV)
1	11340.000	42.27	5.20	47.47	-26.53	74.00	100	8	Peak
2	* 17010.000	43.65	6.12	49.77	-18.43	68.20	100	360	Peak

Note:

1. " *", means this data is the worst emission level.
2. C.F (Correction Factor) = Antenna Factor (dB/m)+ Cable Loss (dB) – Preamplifier(dB).
3. Measurement (dBuV/m) = Reading(dBuV) + C.F (Correction Factor).
4. The emission levels of other frequencies are very lower than the limit and not show in test report.

EUT	BE3600 Dual-Band Wi-Fi 7 Router	Date of Test	2024-02-06
Factor	DRH18-E	Temp. / Humidity	20°C /65%
Polarity	Horizontal	Site / Test Engineer	AC2 / Marvin
Test Mode	802.11ax-40MHz_TX_Band3_CH 142_ANT 0+1	Test Voltage	AC 120V/60Hz

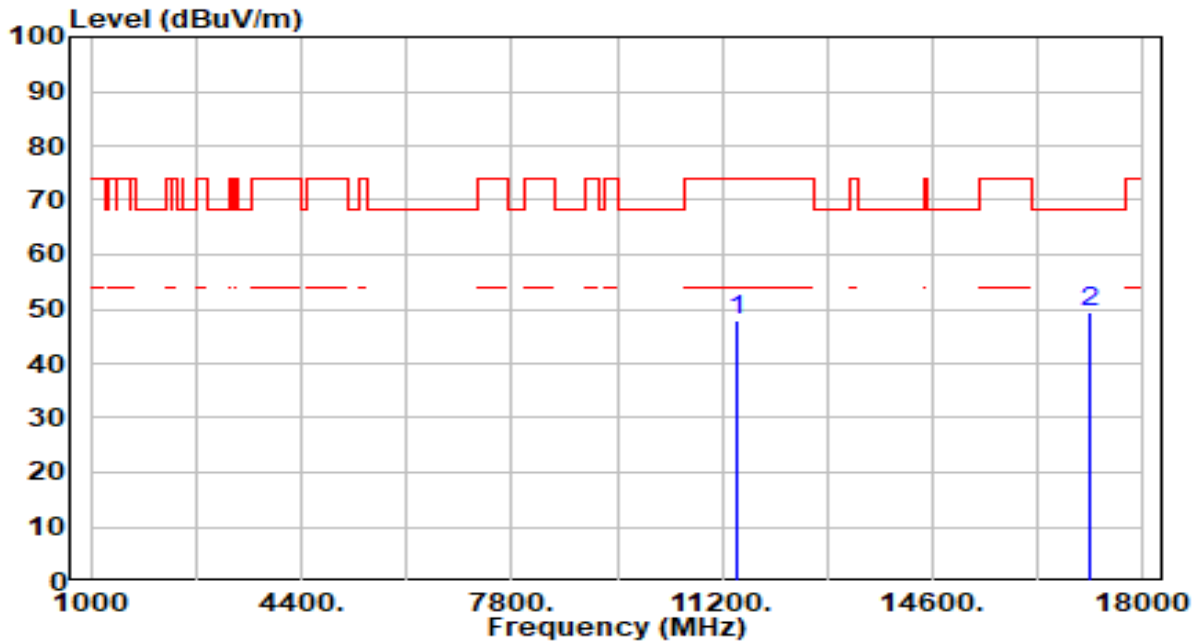

No	Frequency (MHz)	Reading (dBuV)	C.F (dB/m)	Measurement (dBuV/m)	Margin (dB)	Limit (dBuV/m)	Height (cm)	Angle (deg)	Remark (QP/PK/AV)
1	11420.000	42.82	5.28	48.10	-25.90	74.00	100	60	Peak
2	* 17130.000	43.53	5.92	49.45	-18.75	68.20	100	172	Peak

Note:

1. " *", means this data is the worst emission level.
2. C.F (Correction Factor) = Antenna Factor (dB/m)+ Cable Loss (dB) – Pre-amplifier(dB).
3. Measurement (dBuV/m) = Reading(dBuV) + C.F (Correction Factor).
4. The emission levels of other frequencies are very lower than the limit and not show in test report.

EUT	BE3600 Dual-Band Wi-Fi 7 Router	Date of Test	2024-02-06
Factor	DRH18-E	Temp. / Humidity	20°C /65%
Polarity	Vertical	Site / Test Engineer	AC2 / Marvin
Test Mode	802.11ax-40MHz_TX_Band3_CH 142_ANT 0+1	Test Voltage	AC 120V/60Hz

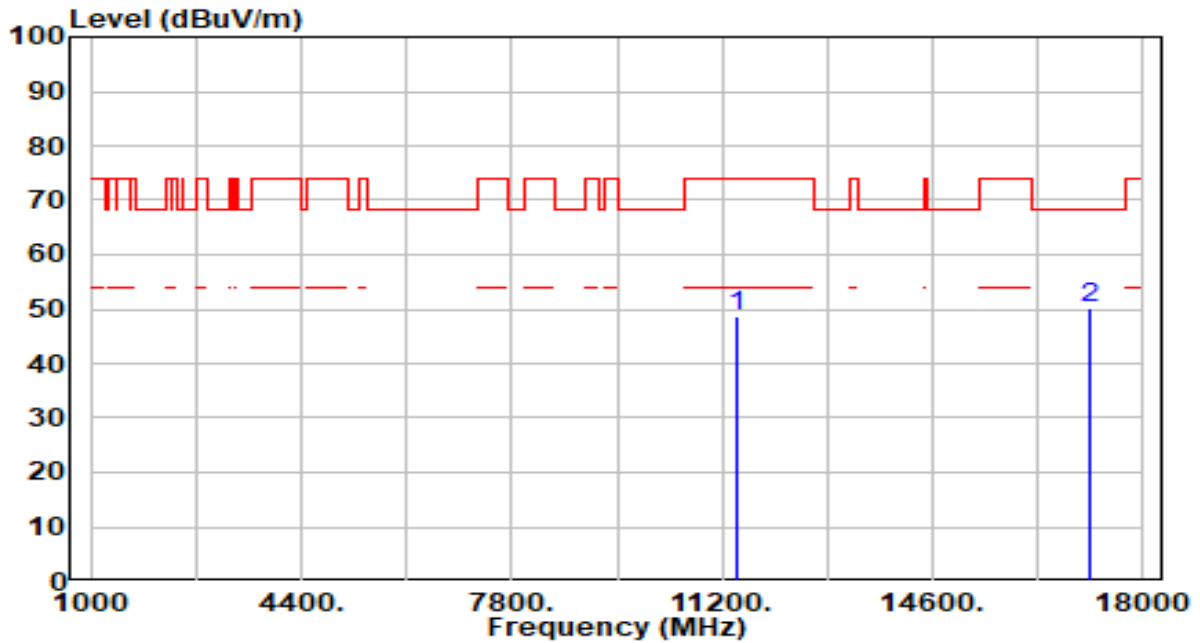

No	Frequency (MHz)	Reading (dBuV)	C.F (dB/m)	Measurement (dBuV/m)	Margin (dB)	Limit (dBuV/m)	Height (cm)	Angle (deg)	Remark (QP/PK/AV)
1	11420.000	43.53	5.28	48.81	-25.19	74.00	100	210	Peak
2	* 17130.000	44.42	5.92	50.34	-17.86	68.20	100	280	Peak

Note:

- "*", means this data is the worst emission level.
- C.F (Correction Factor) = Antenna Factor (dB/m)+ Cable Loss (dB) – Pre-amplifier(dB).
- Measurement (dBuV/m) = Reading(dBuV) + C.F (Correction Factor).
- The emission levels of other frequencies are very lower than the limit and not show in test report.

EUT	BE3600 Dual-Band Wi-Fi 7 Router	Date of Test	2024-02-06
Factor	DRH18-E	Temp. / Humidity	20°C /65%
Polarity	Horizontal	Site / Test Engineer	AC2 / Marvin
Test Mode	802.11ax-40MHz_TX_Band4_CH 151_ANT 0+1	Test Voltage	AC 120V/60Hz

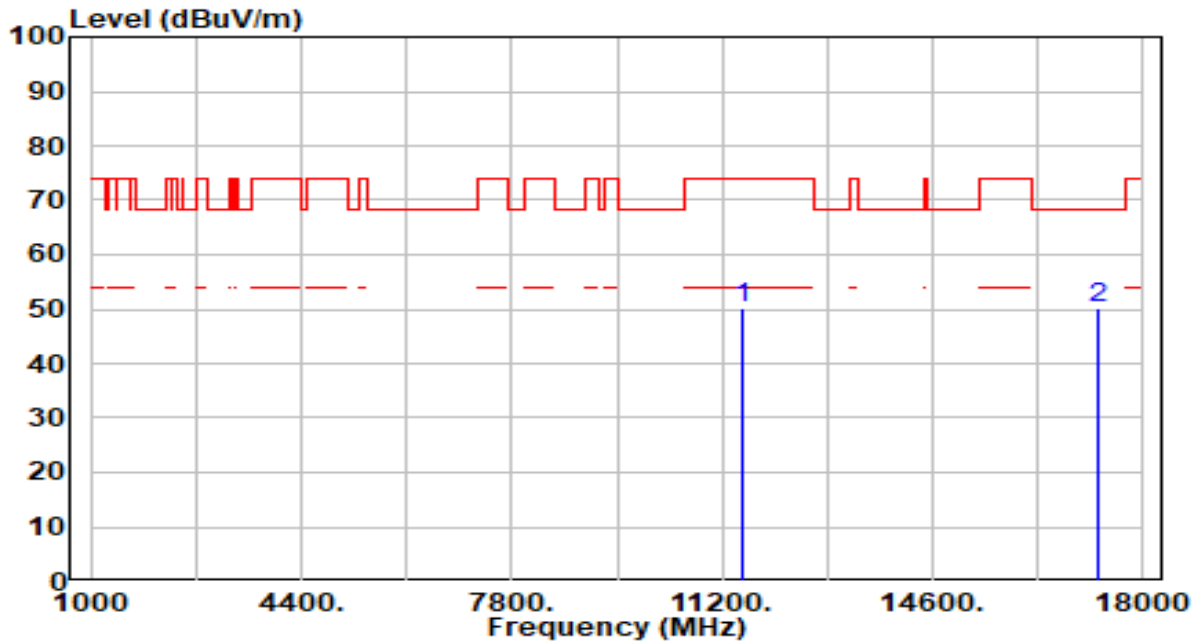

No	Frequency (MHz)	Reading (dBuV)	C.F (dB/m)	Measurement (dBuV/m)	Margin (dB)	Limit (dBuV/m)	Height (cm)	Angle (deg)	Remark (QP/PK/AV)
1	11510.000	44.71	5.33	50.05	-23.95	74.00	100	180	Peak
2	* 17265.000	44.37	5.63	50.00	-18.20	68.20	100	130	Peak

Note:

1. " *", means this data is the worst emission level.
2. C.F (Correction Factor) = Antenna Factor (dB/m)+ Cable Loss (dB) – Pre-amplifier(dB).
3. Measurement (dBuV/m) = Reading(dBuV) + C.F (Correction Factor).
4. The emission levels of other frequencies are very lower than the limit and not show in test report.

EUT	BE3600 Dual-Band Wi-Fi 7 Router	Date of Test	2024-02-06
Factor	DRH18-E	Temp. / Humidity	20°C /65%
Polarity	Vertical	Site / Test Engineer	AC2 / Marvin
Test Mode	802.11ax-40MHz_TX_Band4_CH 151_ANT 0+1	Test Voltage	AC 120V/60Hz

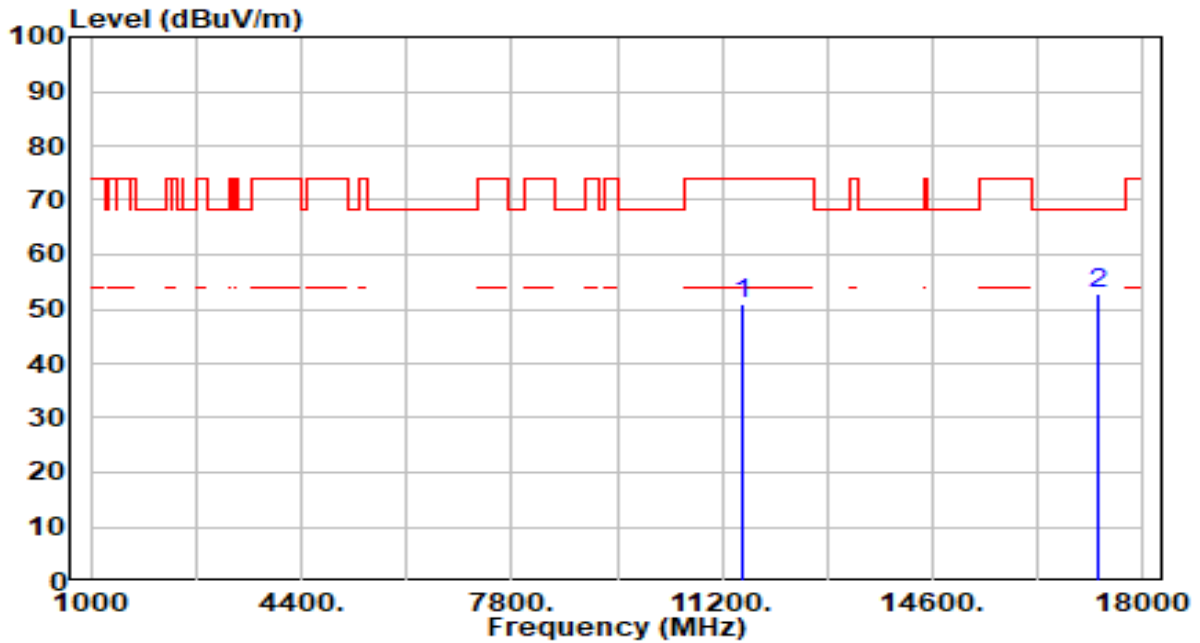

No	Frequency (MHz)	Reading (dBuV)	C.F (dB/m)	Measurement (dBuV/m)	Margin (dB)	Limit (dBuV/m)	Height (cm)	Angle (deg)	Remark (QP/PK/AV)
1	11510.000	45.46	5.33	50.80	-23.20	74.00	100	240	Peak
2	* 17265.000	47.24	5.63	52.87	-15.33	68.20	100	228	Peak

Note:

- "*", means this data is the worst emission level.
- C.F (Correction Factor) = Antenna Factor (dB/m)+ Cable Loss (dB) – Pre-amplifier(dB).
- Measurement (dBuV/m) = Reading(dBuV) + C.F (Correction Factor).
- The emission levels of other frequencies are very lower than the limit and not show in test report.

EUT	BE3600 Dual-Band Wi-Fi 7 Router	Date of Test	2024-02-06
Factor	DRH18-E	Temp. / Humidity	20°C /65%
Polarity	Horizontal	Site / Test Engineer	AC2 / Marvin
Test Mode	802.11ax-40MHz_TX_Band4_CH 159_ANT 0+1	Test Voltage	AC 120V/60Hz

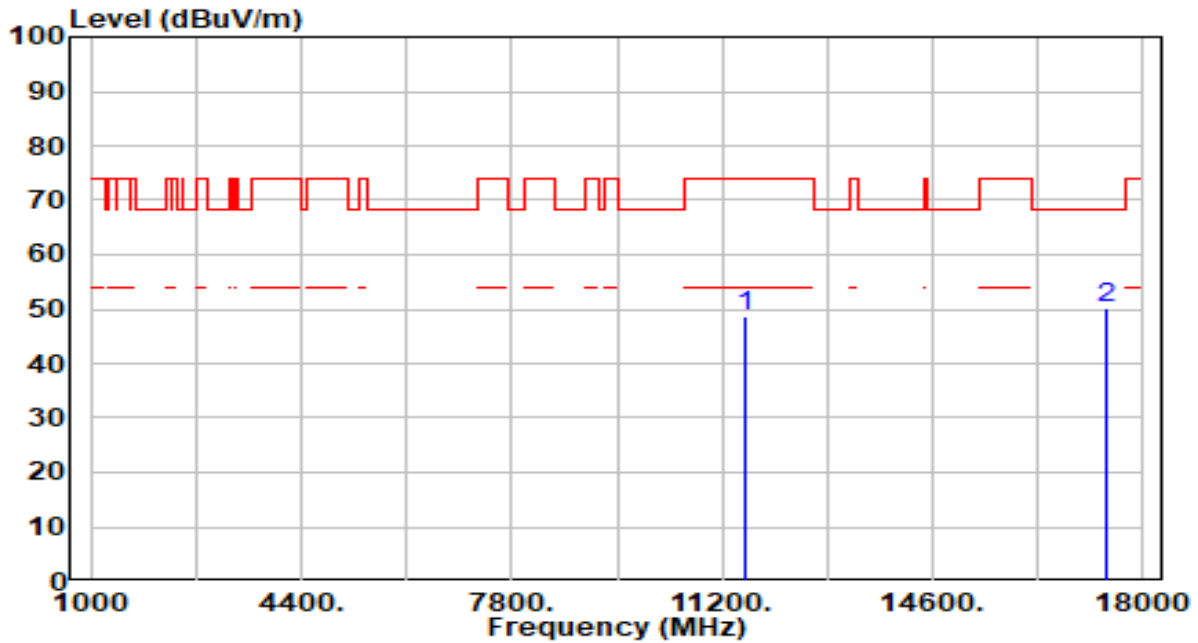

No	Frequency (MHz)	Reading (dBuV)	C.F (dB/m)	Measurement (dBuV/m)	Margin (dB)	Limit (dBuV/m)	Height (cm)	Angle (deg)	Remark (QP/PK/AV)
1	11590.000	43.14	5.39	48.53	-25.47	74.00	100	288	Peak
2	* 17385.000	44.94	5.31	50.24	-17.96	68.20	100	222	Peak

Note:

1. " *", means this data is the worst emission level.
2. C.F (Correction Factor) = Antenna Factor (dB/m)+ Cable Loss (dB) – Pre-amplifier(dB).
3. Measurement (dBuV/m) = Reading(dBuV) + C.F (Correction Factor).
4. The emission levels of other frequencies are very lower than the limit and not show in test report.

EUT	BE3600 Dual-Band Wi-Fi 7 Router	Date of Test	2024-02-06
Factor	DRH18-E	Temp. / Humidity	20°C /65%
Polarity	Vertical	Site / Test Engineer	AC2 / Marvin
Test Mode	802.11ax-40MHz_TX_Band4_CH 159_ANT 0+1	Test Voltage	AC 120V/60Hz

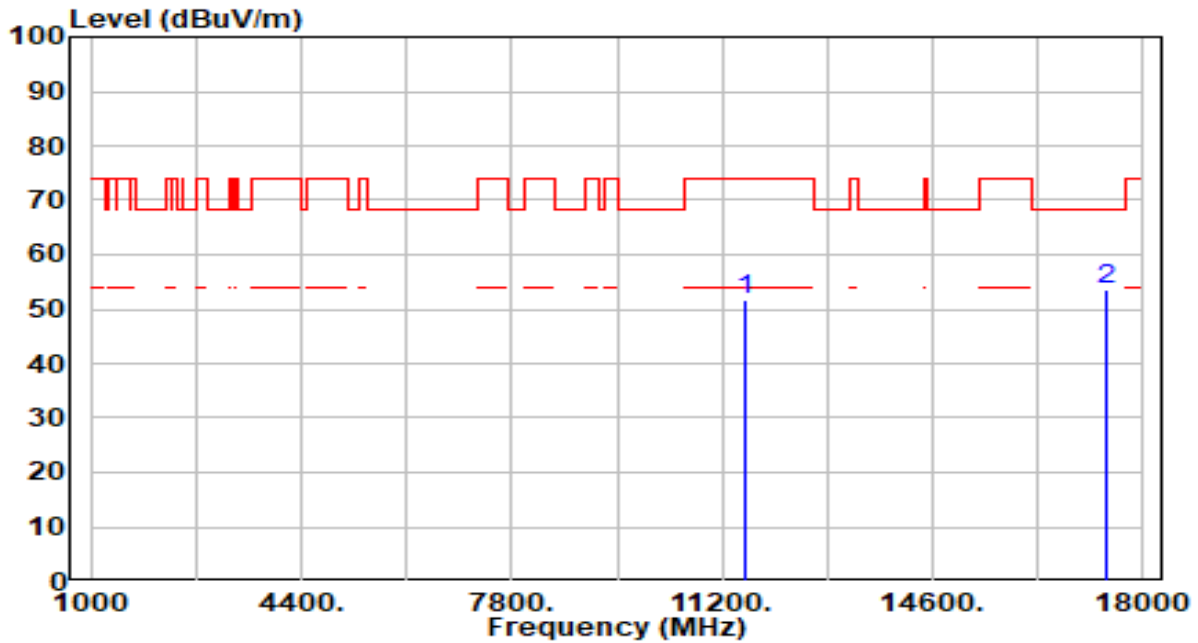

No	Frequency (MHz)	Reading (dBuV)	C.F (dB/m)	Measurement (dBuV/m)	Margin (dB)	Limit (dBuV/m)	Height (cm)	Angle (deg)	Remark (QP/PK/AV)
1	11590.000	46.17	5.39	51.56	-22.44	74.00	100	243	Peak
2	* 17385.000	48.22	5.31	53.53	-14.67	68.20	100	251	Peak

Note:

- "*", means this data is the worst emission level.
- C.F (Correction Factor) = Antenna Factor (dB/m)+ Cable Loss (dB) – Pre-amplifier(dB).
- Measurement (dBuV/m) = Reading(dBuV) + C.F (Correction Factor).
- The emission levels of other frequencies are very lower than the limit and not show in test report.

EUT	BE3600 Dual-Band Wi-Fi 7 Router	Date of Test	2024-02-06
Factor	DRH18-E	Temp. / Humidity	20°C /65%
Polarity	Horizontal	Site / Test Engineer	AC2 / Marvin
Test Mode	802.11ax-80MHz_TX_Band1_CH 42_ANT 0+1	Test Voltage	AC 120V/60Hz

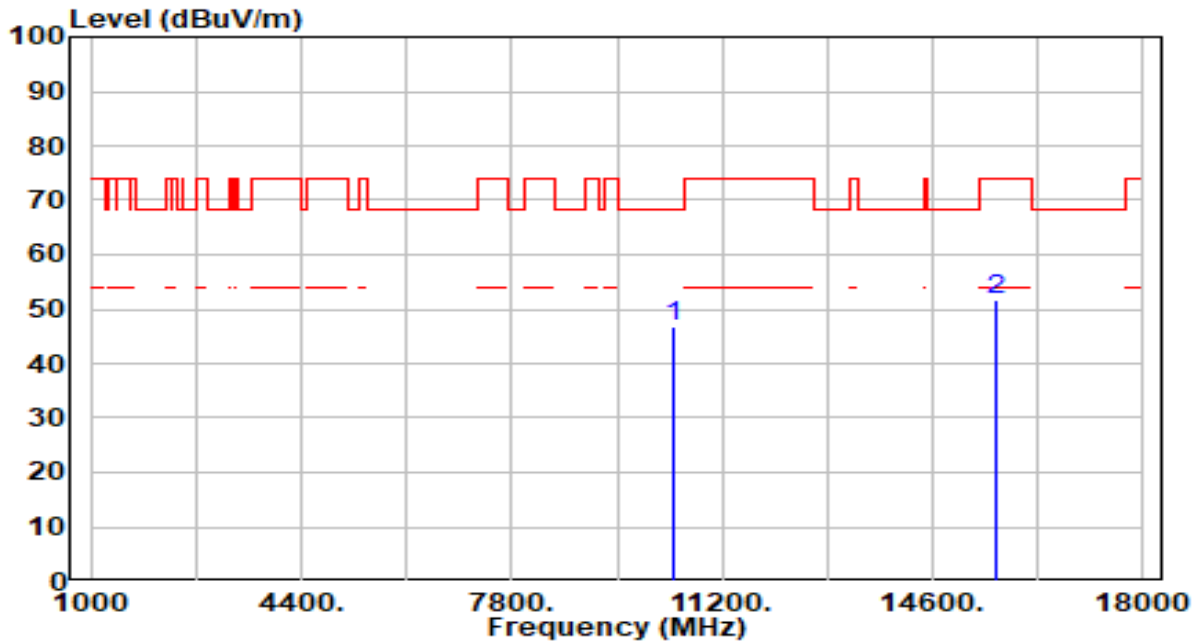

No	Frequency (MHz)	Reading (dBuV)	C.F (dB/m)	Measurement (dBuV/m)	Margin (dB)	Limit (dBuV/m)	Height (cm)	Angle (deg)	Remark (QP/PK/AV)
1	*	42.09	4.79	46.88	-21.32	68.20	100	173	Peak
2		45.60	6.21	51.80	-22.20	74.00	100	307	Peak

Note:

1. " *", means this data is the worst emission level.
2. C.F (Correction Factor) = Antenna Factor (dB/m)+ Cable Loss (dB) – Pre-amplifier(dB).
3. Measurement (dBuV/m) = Reading(dBuV) + C.F (Correction Factor).
4. The emission levels of other frequencies are very lower than the limit and not show in test report.

EUT	BE3600 Dual-Band Wi-Fi 7 Router	Date of Test	2024-02-06
Factor	DRH18-E	Temp. / Humidity	20°C /65%
Polarity	Vertical	Site / Test Engineer	AC2 / Marvin
Test Mode	802.11ax-80MHz_TX_Band1_CH 42_ANT 0+1	Test Voltage	AC 120V/60Hz

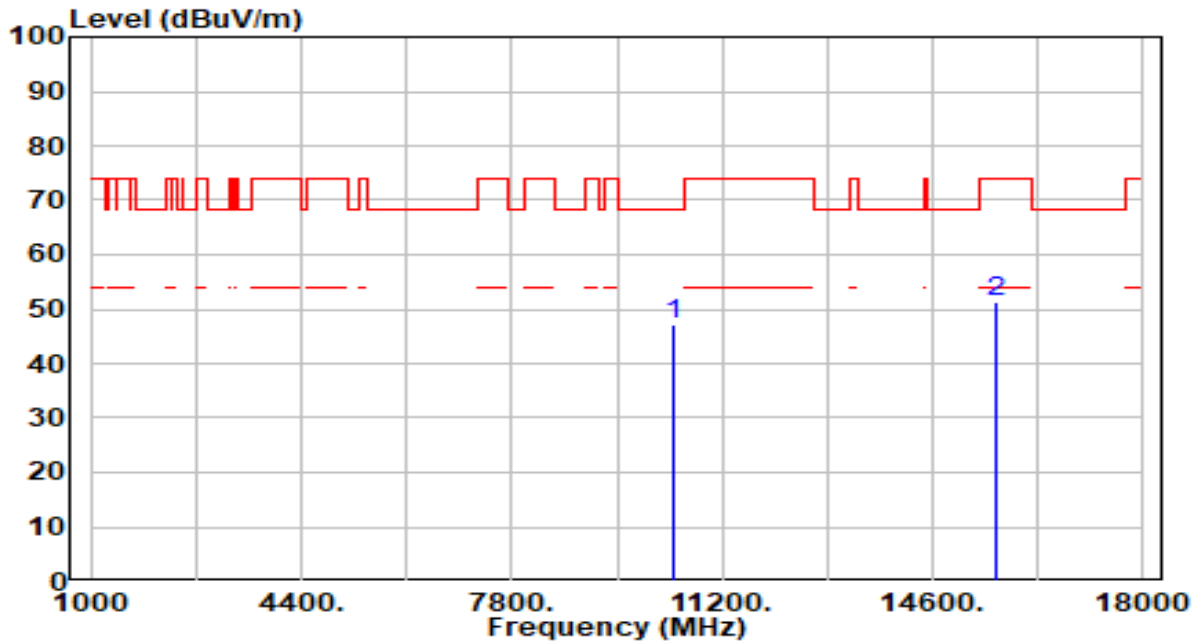

No	Frequency (MHz)	Reading (dBuV)	C.F (dB/m)	Measurement (dBuV/m)	Margin (dB)	Limit (dBuV/m)	Height (cm)	Angle (deg)	Remark (QP/PK/AV)
1	* 10420.000	42.34	4.79	47.13	-21.07	68.20	100	302	Peak
2	15630.000	44.94	6.21	51.14	-22.86	74.00	100	34	Peak

Note:

1. " *", means this data is the worst emission level.
2. C.F (Correction Factor) = Antenna Factor (dB/m)+ Cable Loss (dB) – Pre-amplifier(dB).
3. Measurement (dBuV/m) = Reading(dBuV) + C.F (Correction Factor).
4. The emission levels of other frequencies are very lower than the limit and not show in test report.

EUT	BE3600 Dual-Band Wi-Fi 7 Router	Date of Test	2024-02-06
Factor	DRH18-E	Temp. / Humidity	20°C /65%
Polarity	Horizontal	Site / Test Engineer	AC2 / Marvin
Test Mode	802.11ax-80MHz_TX_Band2_CH 58_ANT 0+1	Test Voltage	AC 120V/60Hz

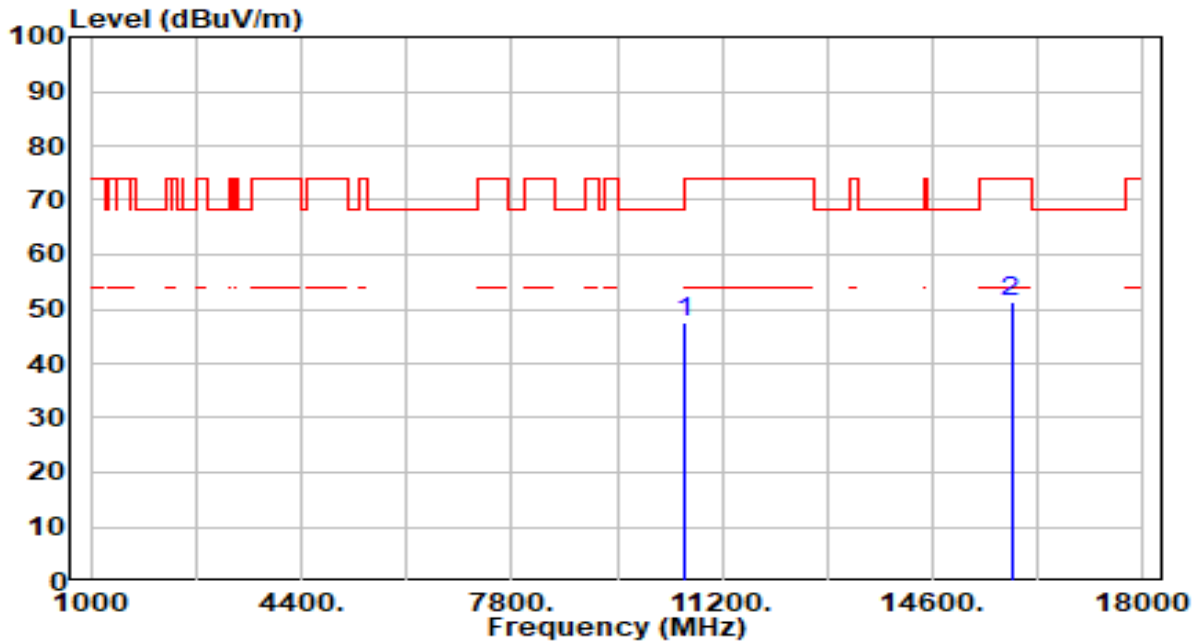

No	Frequency (MHz)	Reading (dBuV)	C.F (dB/m)	Measurement (dBuV/m)	Margin (dB)	Limit (dBuV/m)	Height (cm)	Angle (deg)	Remark (QP/PK/AV)
1	* 10580.000	42.93	4.63	47.55	-20.65	68.20	100	190	Peak
2	15870.000	44.83	6.55	51.38	-22.62	74.00	100	132	Peak

Note:

1. " *", means this data is the worst emission level.
2. C.F (Correction Factor) = Antenna Factor (dB/m)+ Cable Loss (dB) – Pre-amplifier(dB).
3. Measurement (dBuV/m) = Reading(dBuV) + C.F (Correction Factor).
4. The emission levels of other frequencies are very lower than the limit and not show in test report.

EUT	BE3600 Dual-Band Wi-Fi 7 Router	Date of Test	2024-02-06
Factor	DRH18-E	Temp. / Humidity	20°C /65%
Polarity	Vertical	Site / Test Engineer	AC2 / Marvin
Test Mode	802.11ax-80MHz_TX_Band2_CH 58_ANT 0+1	Test Voltage	AC 120V/60Hz

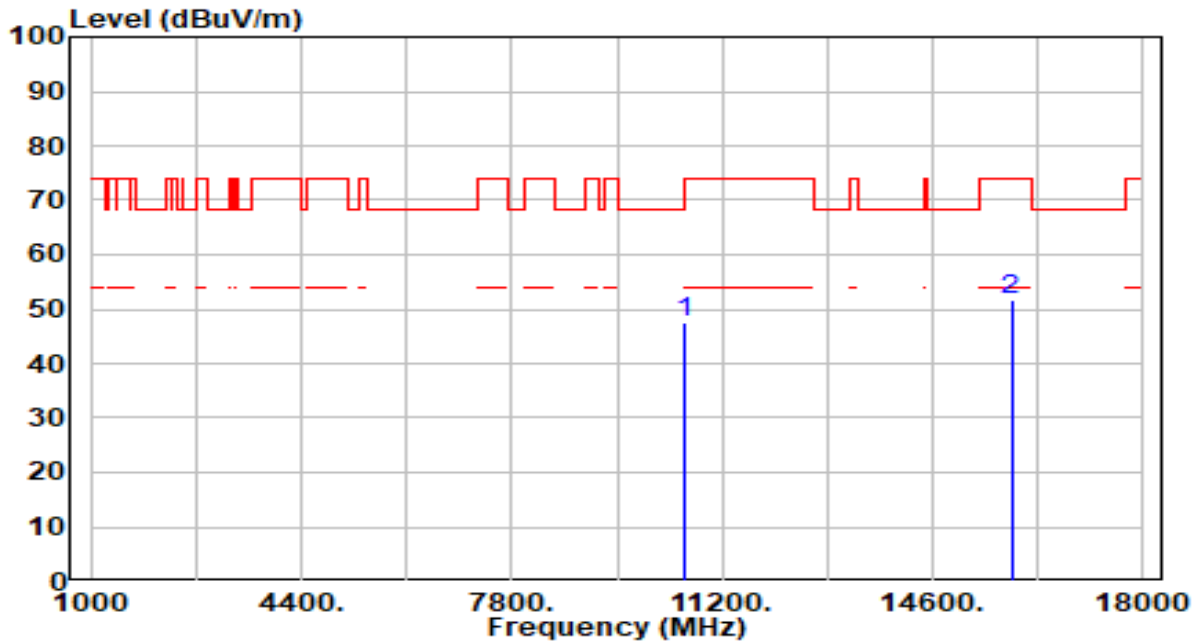

No	Frequency (MHz)	Reading (dBuV)	C.F (dB/m)	Measurement (dBuV/m)	Margin (dB)	Limit (dBuV/m)	Height (cm)	Angle (deg)	Remark (QP/PK/AV)
1	* 10580.000	43.02	4.63	47.65	-20.55	68.20	100	158	Peak
2	15870.000	45.32	6.55	51.87	-22.13	74.00	100	198	Peak

Note:

1. " *", means this data is the worst emission level.
2. C.F (Correction Factor) = Antenna Factor (dB/m)+ Cable Loss (dB) – Pre-amplifier(dB).
3. Measurement (dBuV/m) = Reading(dBuV) + C.F (Correction Factor).
4. The emission levels of other frequencies are very lower than the limit and not show in test report.

EUT	BE3600 Dual-Band Wi-Fi 7 Router	Date of Test	2024-02-06
Factor	DRH18-E	Temp. / Humidity	20°C /65%
Polarity	Horizontal	Site / Test Engineer	AC2 / Marvin
Test Mode	802.11ax-80MHz_TX_Band3_CH 106_ANT 0+1	Test Voltage	AC 120V/60Hz

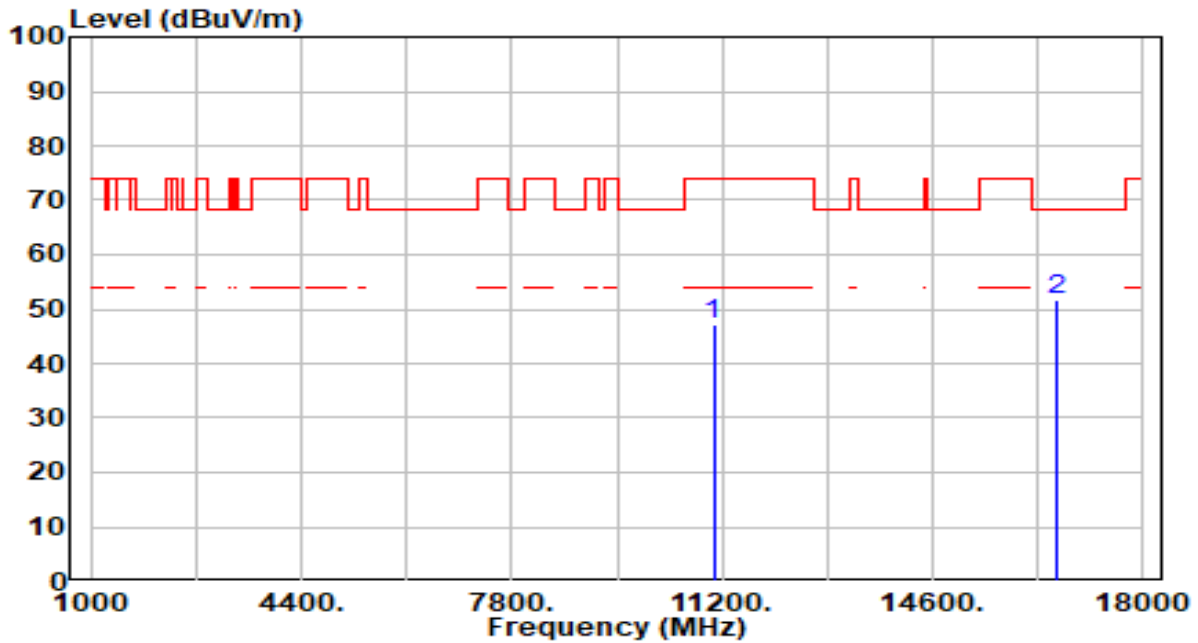

No	Frequency (MHz)	Reading (dBuV)	C.F (dB/m)	Measurement (dBuV/m)	Margin (dB)	Limit (dBuV/m)	Height (cm)	Angle (deg)	Remark (QP/PK/AV)
1	11060.000	42.58	4.68	47.26	-26.74	74.00	100	339	Peak
2	* 16590.000	45.60	6.11	51.71	-16.49	68.20	100	272	Peak

Note:

1. " *", means this data is the worst emission level.
2. C.F (Correction Factor) = Antenna Factor (dB/m)+ Cable Loss (dB) – Pre-amplifier(dB).
3. Measurement (dBuV/m) = Reading(dBuV) + C.F (Correction Factor).
4. The emission levels of other frequencies are very lower than the limit and not show in test report.

EUT	BE3600 Dual-Band Wi-Fi 7 Router	Date of Test	2024-02-06
Factor	DRH18-E	Temp. / Humidity	20°C /65%
Polarity	Vertical	Site / Test Engineer	AC2 / Marvin
Test Mode	802.11ax-80MHz_TX_Band3_CH 106_ANT 0+1	Test Voltage	AC 120V/60Hz

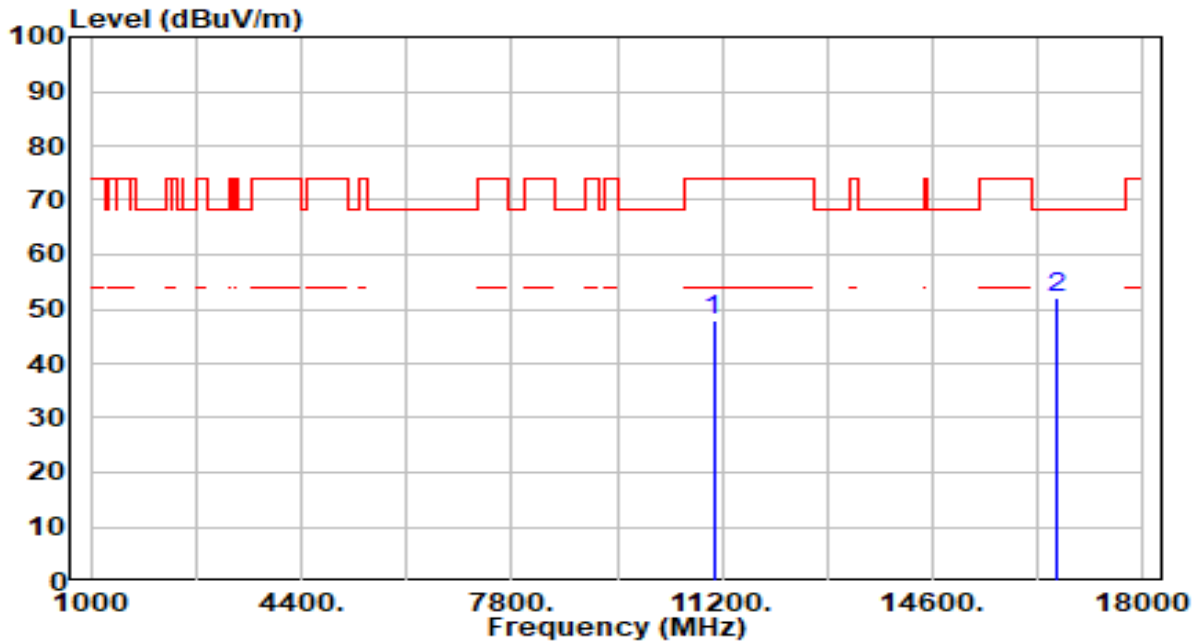

No	Frequency (MHz)	Reading (dBuV)	C.F (dB/m)	Measurement (dBuV/m)	Margin (dB)	Limit (dBuV/m)	Height (cm)	Angle (deg)	Remark (QP/PK/AV)
1	11060.000	43.42	4.68	48.10	-25.90	74.00	100	74	Peak
2	* 16590.000	45.85	6.11	51.96	-16.24	68.20	100	218	Peak

Note:

- "*", means this data is the worst emission level.
- C.F (Correction Factor) = Antenna Factor (dB/m)+ Cable Loss (dB) – Pre-amplifier(dB).
- Measurement (dBuV/m) = Reading(dBuV) + C.F (Correction Factor).
- The emission levels of other frequencies are very lower than the limit and not show in test report.

EUT	BE3600 Dual-Band Wi-Fi 7 Router	Date of Test	2024-02-06
Factor	DRH18-E	Temp. / Humidity	20°C /65%
Polarity	Horizontal	Site / Test Engineer	AC2 / Marvin
Test Mode	802.11ax-80MHz_TX_Band3_CH 122_ANT 0+1	Test Voltage	AC 120V/60Hz

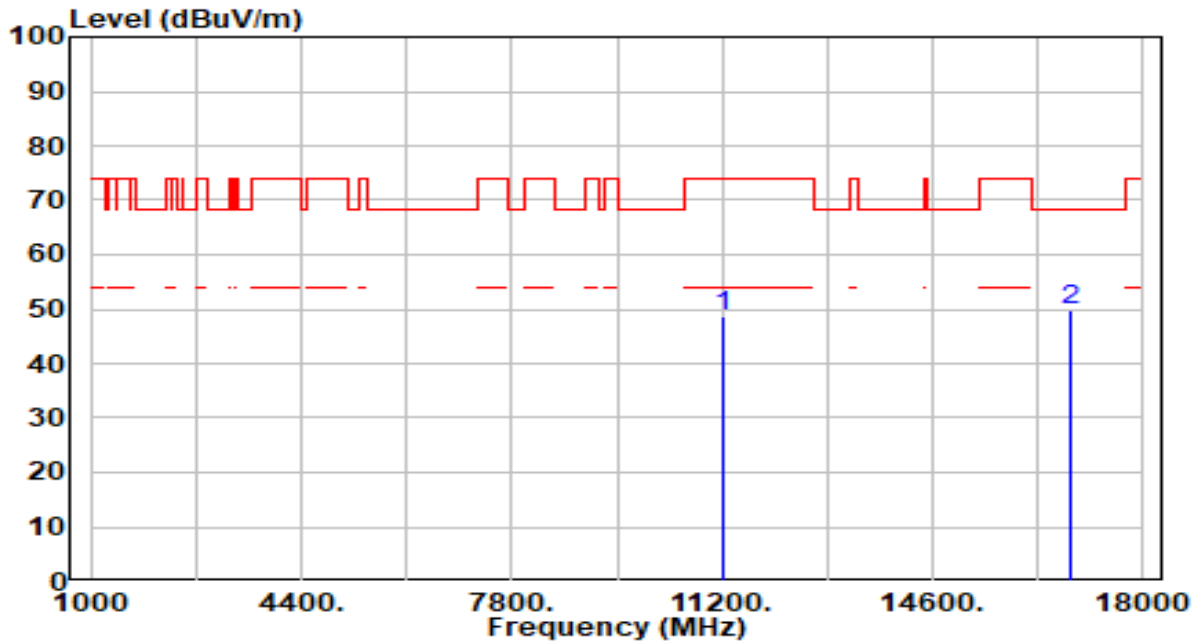

No	Frequency (MHz)	Reading (dBuV)	C.F (dB/m)	Measurement (dBuV/m)	Margin (dB)	Limit (dBuV/m)	Height (cm)	Angle (deg)	Remark (QP/PK/AV)
1	11220.000	43.58	5.06	48.65	-25.35	74.00	100	81	Peak
2	* 16830.000	43.65	6.21	49.86	-18.34	68.20	100	360	Peak

Note:

1. " *", means this data is the worst emission level.
2. C.F (Correction Factor) = Antenna Factor (dB/m)+ Cable Loss (dB) – Pre-amplifier(dB).
3. Measurement (dBuV/m) = Reading(dBuV) + C.F (Correction Factor).
4. The emission levels of other frequencies are very lower than the limit and not show in test report.

EUT	BE3600 Dual-Band Wi-Fi 7 Router	Date of Test	2024-02-06
Factor	DRH18-E	Temp. / Humidity	20°C /65%
Polarity	Vertical	Site / Test Engineer	AC2 / Marvin
Test Mode	802.11ax-80MHz_TX_Band3_CH 122_ANT 0+1	Test Voltage	AC 120V/60Hz

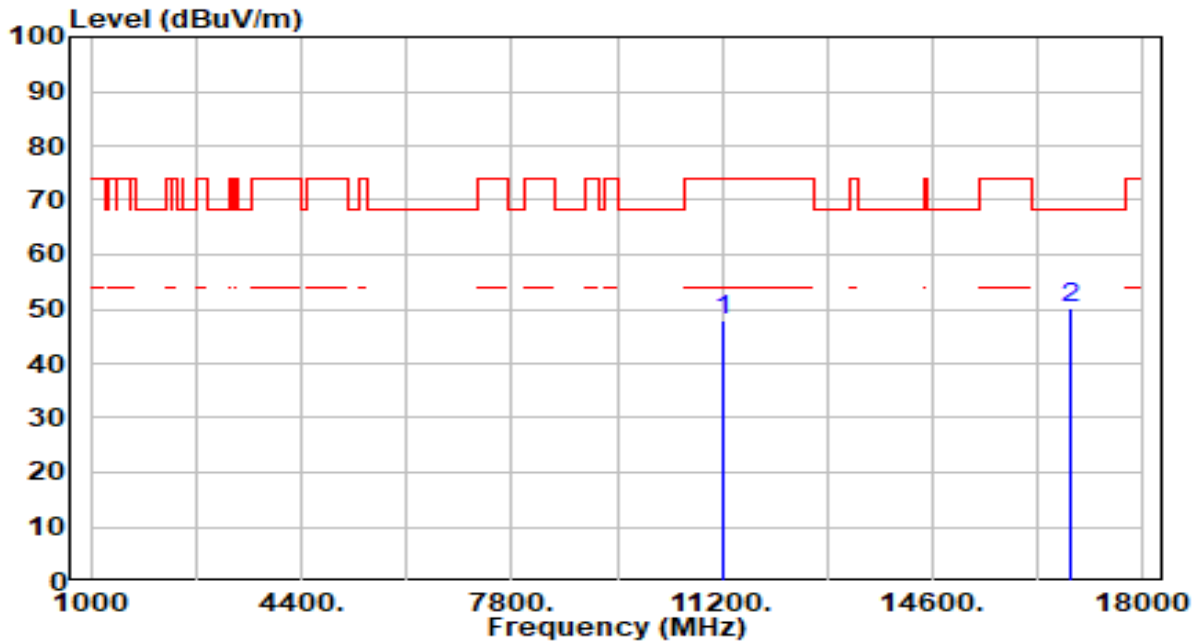

No	Frequency (MHz)	Reading (dBuV)	C.F (dB/m)	Measurement (dBuV/m)	Margin (dB)	Limit (dBuV/m)	Height (cm)	Angle (deg)	Remark (QP/PK/AV)
1	11220.000	42.68	5.06	47.74	-26.26	74.00	100	200	Peak
2	* 16830.000	43.82	6.21	50.03	-18.17	68.20	100	67	Peak

Note:

1. " *", means this data is the worst emission level.
2. C.F (Correction Factor) = Antenna Factor (dB/m)+ Cable Loss (dB) – Pre-amplifier(dB).
3. Measurement (dBuV/m) = Reading(dBuV) + C.F (Correction Factor).
4. The emission levels of other frequencies are very lower than the limit and not show in test report.

EUT	BE3600 Dual-Band Wi-Fi 7 Router	Date of Test	2024-02-06
Factor	DRH18-E	Temp. / Humidity	20°C /65%
Polarity	Horizontal	Site / Test Engineer	AC2 / Marvin
Test Mode	802.11ax-80MHz_TX_Band3_CH 138_ANT 0+1	Test Voltage	AC 120V/60Hz

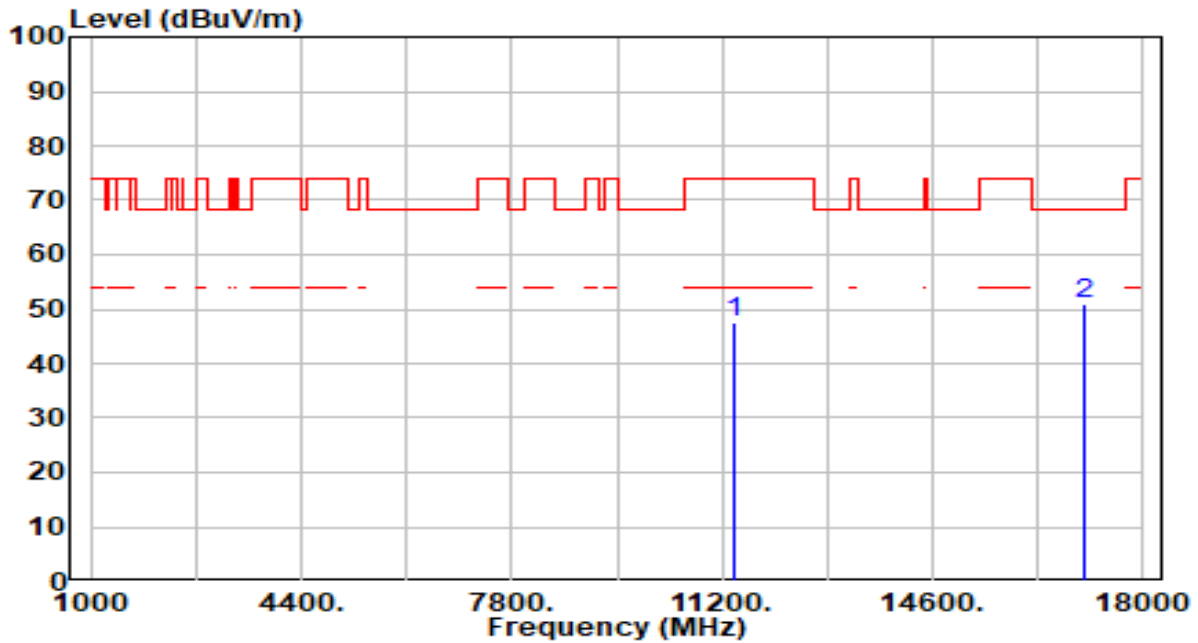

No	Frequency (MHz)	Reading (dBuV)	C.F (dB/m)	Measurement (dBuV/m)	Margin (dB)	Limit (dBuV/m)	Height (cm)	Angle (deg)	Remark (QP/PK/AV)
1	11380.000	42.39	5.24	47.63	-26.37	74.00	100	336	Peak
2	* 17070.000	45.04	6.02	51.06	-17.14	68.20	100	322	Peak

Note:

1. " *", means this data is the worst emission level.
2. C.F (Correction Factor) = Antenna Factor (dB/m)+ Cable Loss (dB) – Pre-amplifier(dB).
3. Measurement (dBuV/m) = Reading(dBuV) + C.F (Correction Factor).
4. The emission levels of other frequencies are very lower than the limit and not show in test report.

EUT	BE3600 Dual-Band Wi-Fi 7 Router	Date of Test	2024-02-06
Factor	DRH18-E	Temp. / Humidity	20°C /65%
Polarity	Vertical	Site / Test Engineer	AC2 / Marvin
Test Mode	802.11ax-80MHz_TX_Band3_CH 138_ANT 0+1	Test Voltage	AC 120V/60Hz

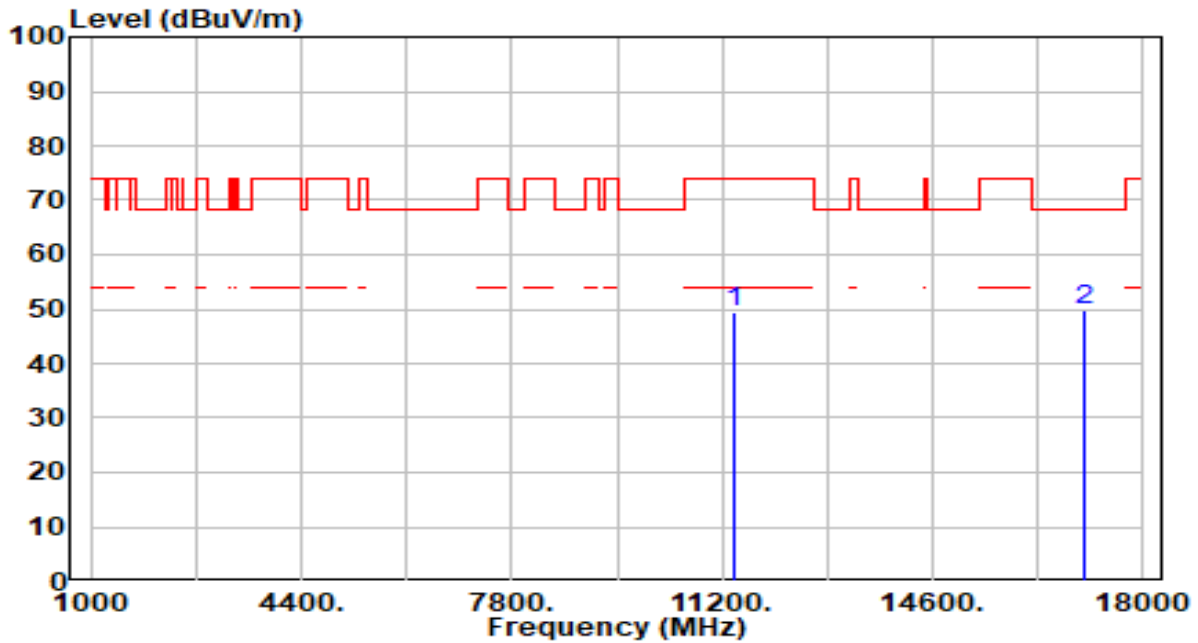

No	Frequency (MHz)	Reading (dBuV)	C.F (dB/m)	Measurement (dBuV/m)	Margin (dB)	Limit (dBuV/m)	Height (cm)	Angle (deg)	Remark (QP/PK/AV)
1	11380.000	44.18	5.24	49.42	-24.58	74.00	100	250	Peak
2	* 17070.000	43.95	6.02	49.97	-18.23	68.20	100	314	Peak

Note:

1. " *", means this data is the worst emission level.
2. C.F (Correction Factor) = Antenna Factor (dB/m)+ Cable Loss (dB) – Pre-amplifier(dB).
3. Measurement (dBuV/m) = Reading(dBuV) + C.F (Correction Factor).
4. The emission levels of other frequencies are very lower than the limit and not show in test report.

EUT	BE3600 Dual-Band Wi-Fi 7 Router	Date of Test	2024-02-06
Factor	DRH18-E	Temp. / Humidity	20°C /65%
Polarity	Horizontal	Site / Test Engineer	AC2 / Marvin
Test Mode	802.11ax-80MHz_TX_Band4_CH 155_ANT 0+1	Test Voltage	AC 120V/60Hz

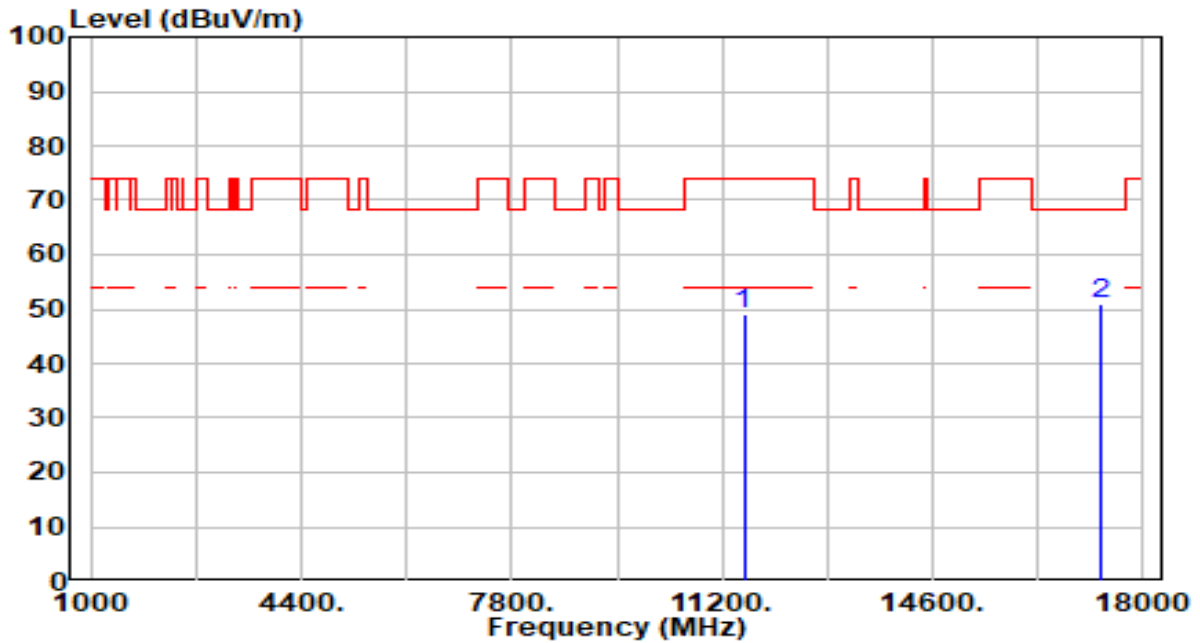

No	Frequency (MHz)	Reading (dBuV)	C.F (dB/m)	Measurement (dBuV/m)	Margin (dB)	Limit (dBuV/m)	Height (cm)	Angle (deg)	Remark (QP/PK/AV)
1	11550.000	43.63	5.36	49.00	-25.00	74.00	100	260	Peak
2	* 17325.000	45.48	5.47	50.94	-17.26	68.20	100	286	Peak

Note:

1. " *", means this data is the worst emission level.
2. C.F (Correction Factor) = Antenna Factor (dB/m)+ Cable Loss (dB) – Pre-amplifier(dB).
3. Measurement (dBuV/m) = Reading(dBuV) + C.F (Correction Factor).
4. The emission levels of other frequencies are very lower than the limit and not show in test report.

EUT	BE3600 Dual-Band Wi-Fi 7 Router	Date of Test	2024-02-06
Factor	DRH18-E	Temp. / Humidity	20°C /65%
Polarity	Vertical	Site / Test Engineer	AC2 / Marvin
Test Mode	802.11ax-80MHz_TX_Band4_CH 155_ANT 0+1	Test Voltage	AC 120V/60Hz

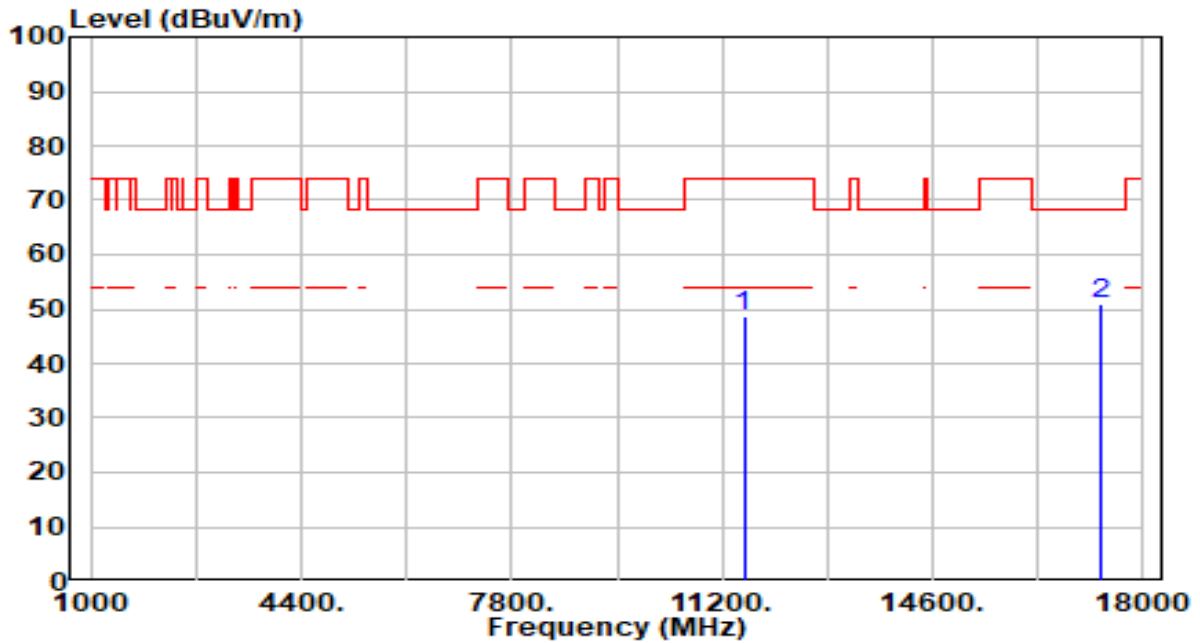

No	Frequency (MHz)	Reading (dBuV)	C.F (dB/m)	Measurement (dBuV/m)	Margin (dB)	Limit (dBuV/m)	Height (cm)	Angle (deg)	Remark (QP/PK/AV)
1	11550.000	43.38	5.36	48.74	-25.26	74.00	100	238	Peak
2	* 17325.000	45.42	5.47	50.89	-17.31	68.20	100	253	Peak

Note:

1. " *", means this data is the worst emission level.
2. C.F (Correction Factor) = Antenna Factor (dB/m)+ Cable Loss (dB) – Pre-amplifier(dB).
3. Measurement (dBuV/m) = Reading(dBuV) + C.F (Correction Factor).
4. The emission levels of other frequencies are very lower than the limit and not show in test report.

EUT	BE3600 Dual-Band Wi-Fi 7 Router	Date of Test	2024-02-06
Factor	DRH18-E	Temp. / Humidity	20°C /65%
Polarity	Horizontal	Site / Test Engineer	AC2 / Marvin
Test Mode	802.11ax-160MHz_TX_Band1,2_CH 50_ANT 0+1	Test Voltage	AC 120V/60Hz

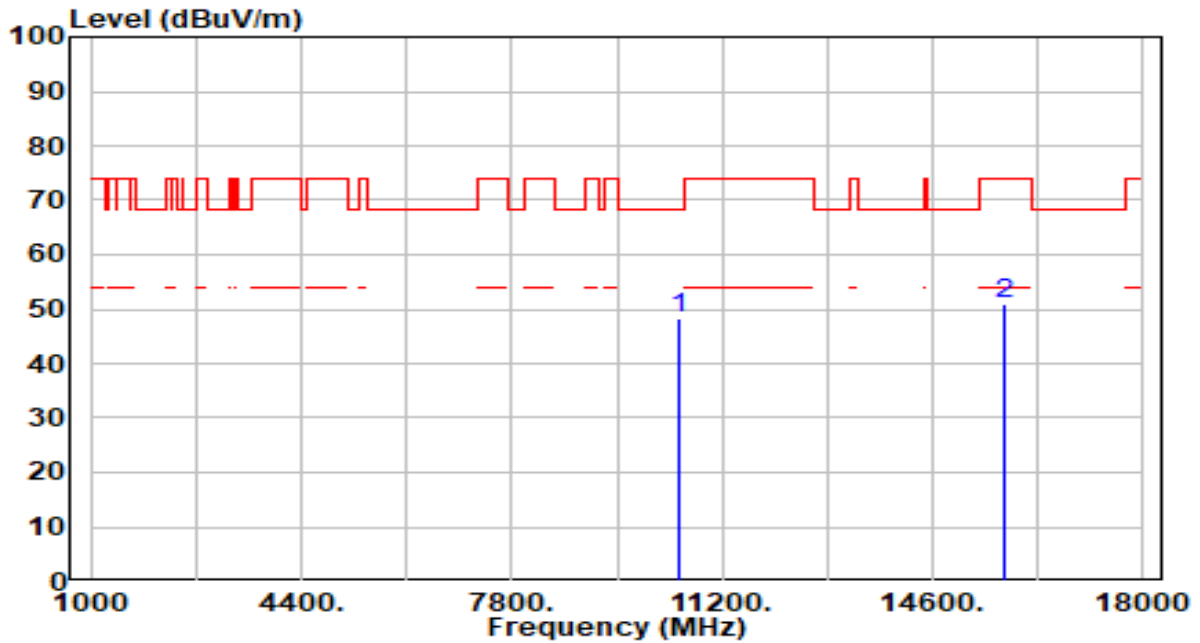

No	Frequency (MHz)	Reading (dBuV)	C.F (dB/m)	Measurement (dBuV/m)	Margin (dB)	Limit (dBuV/m)	Height (cm)	Angle (deg)	Remark (QP/PK/AV)
1	* 10500.000	43.56	4.68	48.25	-19.95	68.20	100	319	Peak
2	15750.000	44.32	6.45	50.76	-23.24	74.00	100	41	Peak

Note:

1. " *", means this data is the worst emission level.
2. C.F (Correction Factor) = Antenna Factor (dB/m)+ Cable Loss (dB) – Pre-amplifier(dB).
3. Measurement (dBuV/m) = Reading(dBuV) + C.F (Correction Factor).
4. The emission levels of other frequencies are very lower than the limit and not show in test report.

EUT	BE3600 Dual-Band Wi-Fi 7 Router	Date of Test	2024-02-06
Factor	DRH18-E	Temp. / Humidity	20°C /65%
Polarity	Vertical	Site / Test Engineer	AC2 / Marvin
Test Mode	802.11ax-160MHz_TX_Band1,2_CH 50_ANT 0+1	Test Voltage	AC 120V/60Hz

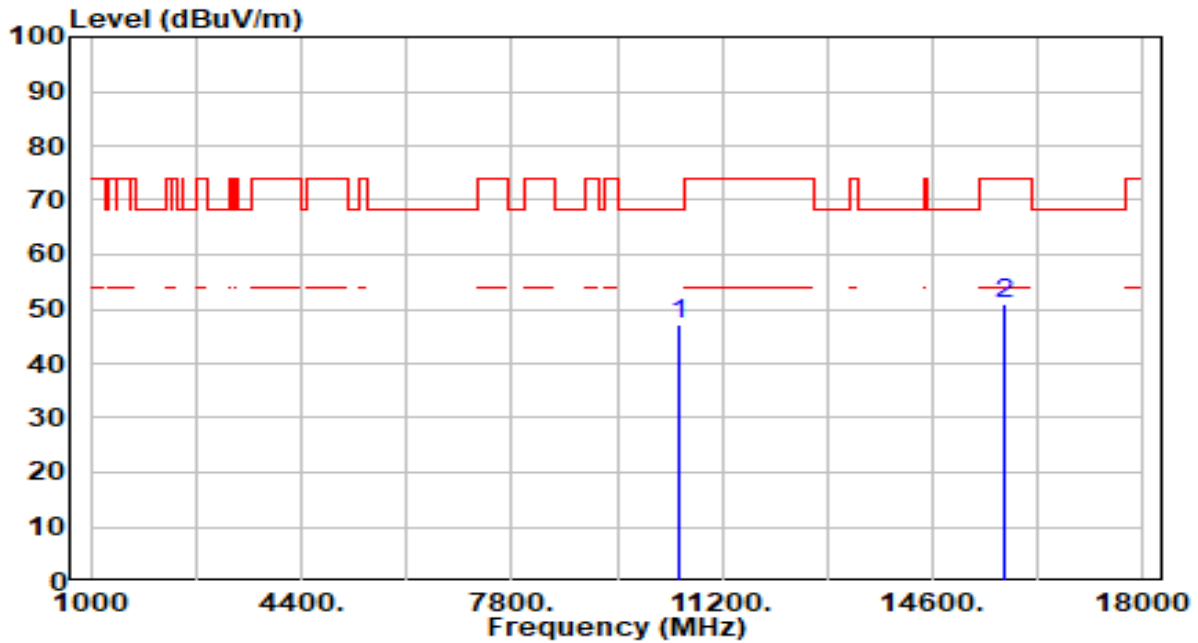

No	Frequency (MHz)	Reading (dBuV)	C.F (dB/m)	Measurement (dBuV/m)	Margin (dB)	Limit (dBuV/m)	Height (cm)	Angle (deg)	Remark (QP/PK/AV)
1	* 10500.000	42.66	4.68	47.34	-20.86	68.20	100	30	Peak
2	15750.000	44.63	6.45	51.07	-22.93	74.00	100	27	Peak

Note:

1. " *", means this data is the worst emission level.
2. C.F (Correction Factor) = Antenna Factor (dB/m)+ Cable Loss (dB) – Pre-amplifier(dB).
3. Measurement (dBuV/m) = Reading(dBuV) + C.F (Correction Factor).
4. The emission levels of other frequencies are very lower than the limit and not show in test report.

EUT	BE3600 Dual-Band Wi-Fi 7 Router	Date of Test	2024-02-06
Factor	DRH18-E	Temp. / Humidity	20°C /65%
Polarity	Horizontal	Site / Test Engineer	AC2 / Marvin
Test Mode	802.11ax-160MHz_TX_Band3_CH 114_ANT 0+1	Test Voltage	AC 120V/60Hz

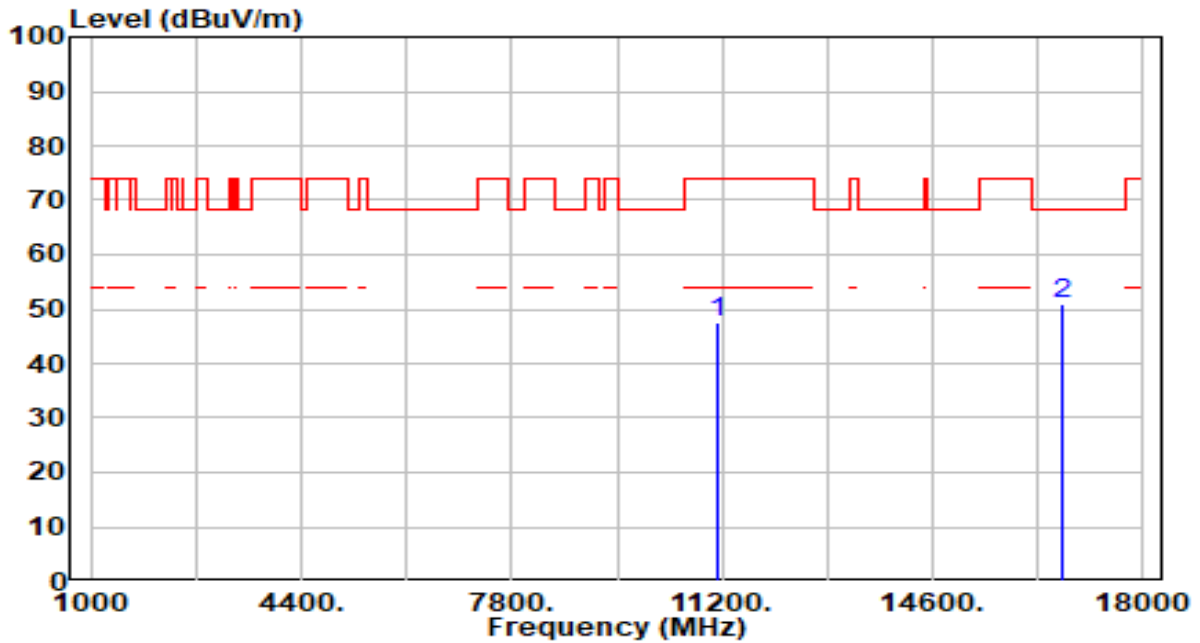

No	Frequency (MHz)	Reading (dBuV)	C.F (dB/m)	Measurement (dBuV/m)	Margin (dB)	Limit (dBuV/m)	Height (cm)	Angle (deg)	Remark (QP/PK/AV)
1	11140.000	42.62	4.89	47.51	-26.49	74.00	100	157	Peak
2	* 16710.000	44.59	6.17	50.76	-17.44	68.20	100	24	Peak

Note:

1. " *", means this data is the worst emission level.
2. C.F (Correction Factor) = Antenna Factor (dB/m)+ Cable Loss (dB) – Pre-amplifier(dB).
3. Measurement (dBuV/m) = Reading(dBuV) + C.F (Correction Factor).
4. The emission levels of other frequencies are very lower than the limit and not show in test report.

EUT	BE3600 Dual-Band Wi-Fi 7 Router	Date of Test	2024-02-06
Factor	DRH18-E	Temp. / Humidity	20°C /65%
Polarity	Vertical	Site / Test Engineer	AC2 / Marvin
Test Mode	802.11ax-160MHz_TX_Band3_CH 114_ANT 0+1	Test Voltage	AC 120V/60Hz

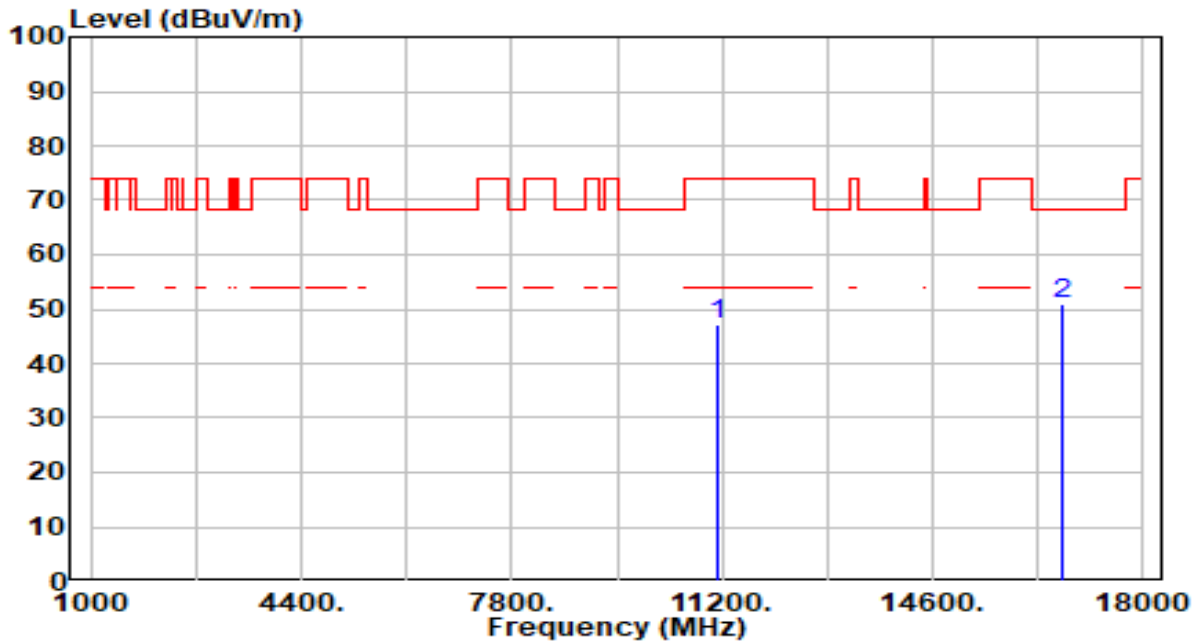

No	Frequency (MHz)	Reading (dBuV)	C.F (dB/m)	Measurement (dBuV/m)	Margin (dB)	Limit (dBuV/m)	Height (cm)	Angle (deg)	Remark (QP/PK/AV)
1	11140.000	42.27	4.89	47.15	-26.85	74.00	100	251	Peak
2	* 16710.000	44.62	6.17	50.79	-17.41	68.20	100	271	Peak

Note:

1. " *", means this data is the worst emission level.
2. C.F (Correction Factor) = Antenna Factor (dB/m)+ Cable Loss (dB) – Pre-amplifier(dB).
3. Measurement (dBuV/m) = Reading(dBuV) + C.F (Correction Factor).
4. The emission levels of other frequencies are very lower than the limit and not show in test report.

EUT	BE3600 Dual-Band Wi-Fi 7 Router	Date of Test	2024-02-06
Factor	DRH18-E	Temp. / Humidity	20°C /65%
Polarity	Horizontal	Site / Test Engineer	AC2 / Marvin
Test Mode	802.11be-20MHz_TX_Band1_CH 36_ANT 0+1	Test Voltage	AC 120V/60Hz

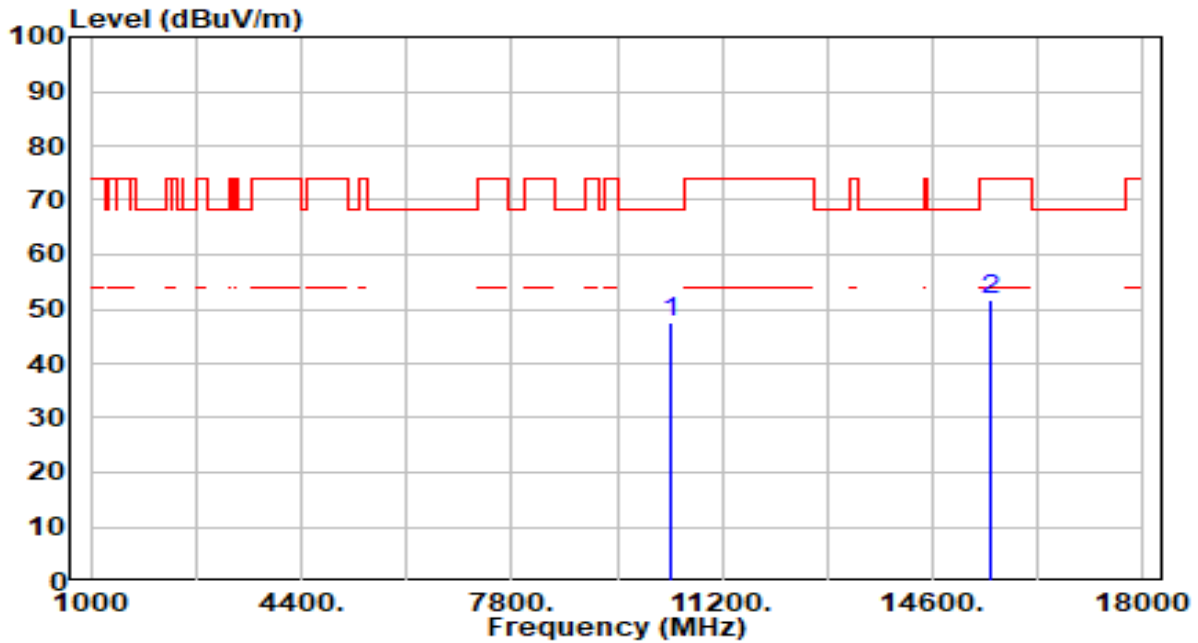

No	Frequency (MHz)	Reading (dBuV)	C.F (dB/m)	Measurement (dBuV/m)	Margin (dB)	Limit (dBuV/m)	Height (cm)	Angle (deg)	Remark (QP/PK/AV)
1	* 10360.000	42.57	4.87	47.44	-20.76	68.20	100	2	Peak
2	15540.000	45.42	6.21	51.62	-22.38	74.00	100	8	Peak

Note:

- "*", means this data is the worst emission level.
- C.F (Correction Factor) = Antenna Factor (dB/m)+ Cable Loss (dB) – Pre-amplifier(dB).
- Measurement (dBuV/m) = Reading(dBuV) + C.F (Correction Factor).
- The emission levels of other frequencies are very lower than the limit and not show in test report.

EUT	BE3600 Dual-Band Wi-Fi 7 Router	Date of Test	2024-02-06
Factor	DRH18-E	Temp. / Humidity	20°C /65%
Polarity	Vertical	Site / Test Engineer	AC2 / Marvin
Test Mode	802.11be-20MHz_TX_Band1_CH 36_ANT 0+1	Test Voltage	AC 120V/60Hz

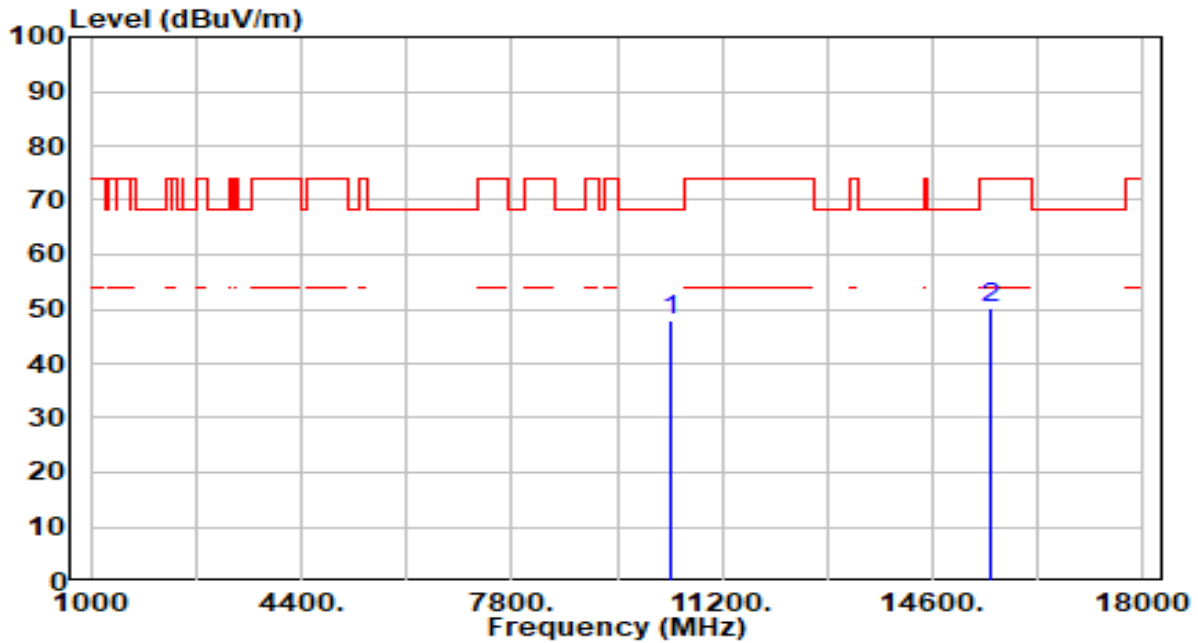

No	Frequency (MHz)	Reading (dBuV)	C.F (dB/m)	Measurement (dBuV/m)	Margin (dB)	Limit (dBuV/m)	Height (cm)	Angle (deg)	Remark (QP/PK/AV)
1	* 10360.000	43.18	4.87	48.05	-20.15	68.20	100	146	Peak
2	15540.000	44.09	6.21	50.29	-23.71	74.00	100	197	Peak

Note:

1. " *", means this data is the worst emission level.
2. C.F (Correction Factor) = Antenna Factor (dB/m)+ Cable Loss (dB) – Pre-amplifier(dB).
3. Measurement (dBuV/m) = Reading(dBuV) + C.F (Correction Factor).
4. The emission levels of other frequencies are very lower than the limit and not show in test report.

EUT	BE3600 Dual-Band Wi-Fi 7 Router	Date of Test	2024-02-06
Factor	DRH18-E	Temp. / Humidity	20°C /65%
Polarity	Horizontal	Site / Test Engineer	AC2 / Marvin
Test Mode	802.11be-20MHz_TX_Band1_CH 44_ANT 0+1	Test Voltage	AC 120V/60Hz

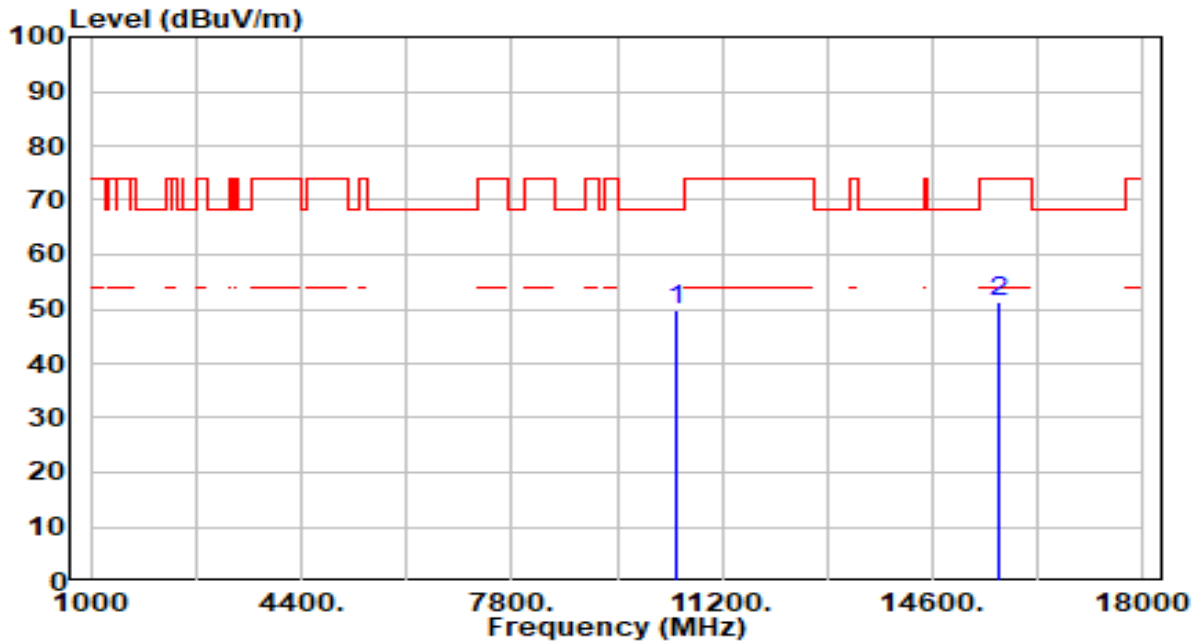

No	Frequency (MHz)	Reading (dBuV)	C.F (dB/m)	Measurement (dBuV/m)	Margin (dB)	Limit (dBuV/m)	Height (cm)	Angle (deg)	Remark (QP/PK/AV)
1	* 10440.000	45.18	4.76	49.95	-18.25	68.20	100	205	Peak
2	15660.000	45.16	6.27	51.43	-22.57	74.00	100	42	Peak

Note:

1. " *", means this data is the worst emission level.
2. C.F (Correction Factor) = Antenna Factor (dB/m)+ Cable Loss (dB) – Pre-amplifier(dB).
3. Measurement (dBuV/m) = Reading(dBuV) + C.F (Correction Factor).
4. The emission levels of other frequencies are very lower than the limit and not show in test report.

EUT	BE3600 Dual-Band Wi-Fi 7 Router	Date of Test	2024-02-06
Factor	DRH18-E	Temp. / Humidity	20°C /65%
Polarity	Vertical	Site / Test Engineer	AC2 / Marvin
Test Mode	802.11be-20MHz_TX_Band1_CH 44_ANT 0+1	Test Voltage	AC 120V/60Hz

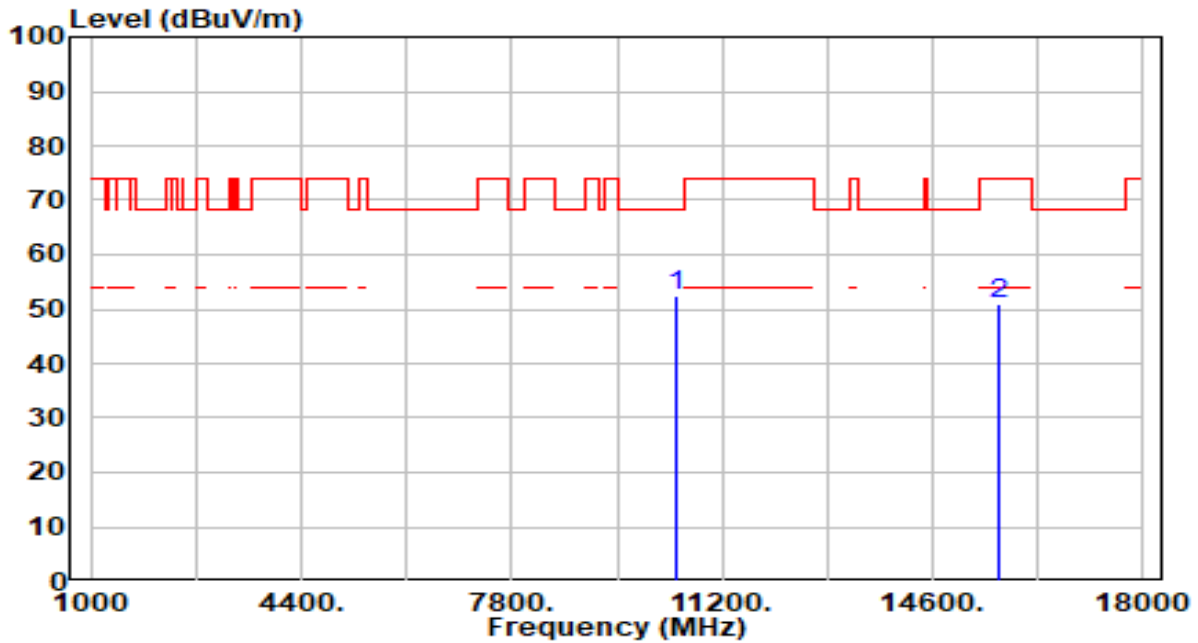

No	Frequency (MHz)	Reading (dBuV)	C.F (dB/m)	Measurement (dBuV/m)	Margin (dB)	Limit (dBuV/m)	Height (cm)	Angle (deg)	Remark (QP/PK/AV)
1	* 10440.000	47.61	4.76	52.37	-15.83	68.20	100	146	Peak
2	15660.000	44.50	6.27	50.77	-23.23	74.00	100	160	Peak

Note:

1. " *", means this data is the worst emission level.
2. C.F (Correction Factor) = Antenna Factor (dB/m)+ Cable Loss (dB) – Pre-amplifier(dB).
3. Measurement (dBuV/m) = Reading(dBuV) + C.F (Correction Factor).
4. The emission levels of other frequencies are very lower than the limit and not show in test report.

EUT	BE3600 Dual-Band Wi-Fi 7 Router	Date of Test	2024-02-06
Factor	DRH18-E	Temp. / Humidity	20°C /65%
Polarity	Horizontal	Site / Test Engineer	AC2 / Marvin
Test Mode	802.11be-20MHz_TX_Band1_CH 48_ANT 0+1	Test Voltage	AC 120V/60Hz

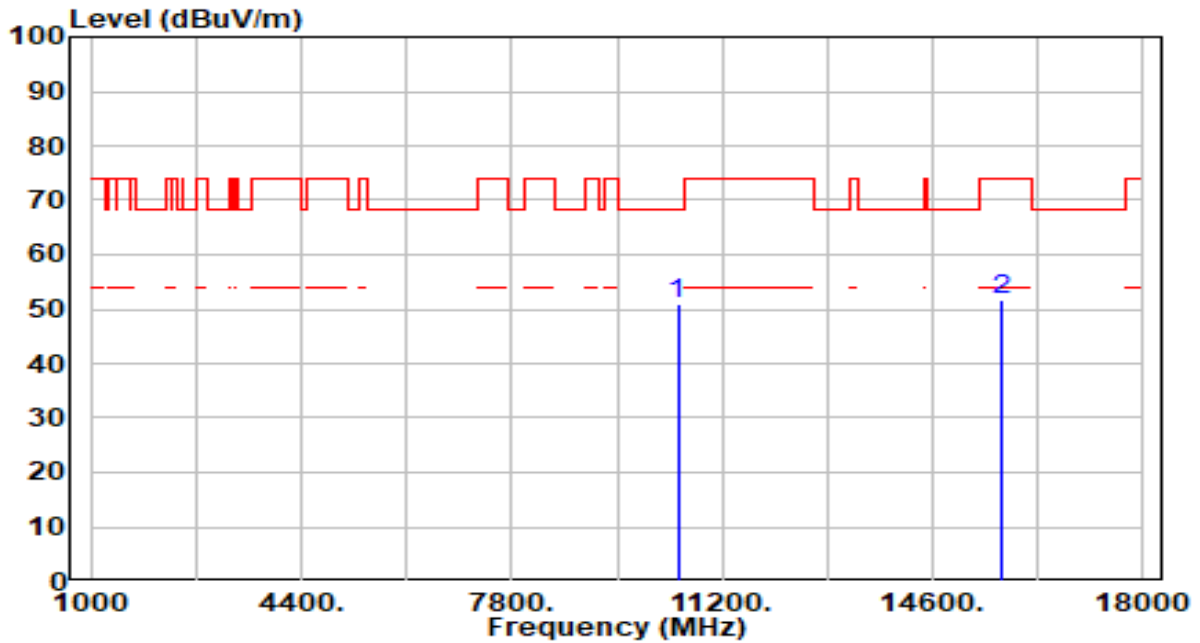

No	Frequency (MHz)	Reading (dBuV)	C.F (dB/m)	Measurement (dBuV/m)	Margin (dB)	Limit (dBuV/m)	Height (cm)	Angle (deg)	Remark (QP/PK/AV)
1	* 10480.000	46.30	4.71	51.02	-17.18	68.20	100	207	Peak
2	15720.000	45.30	6.39	51.69	-22.31	74.00	100	97	Peak

Note:

1. " *", means this data is the worst emission level.
2. C.F (Correction Factor) = Antenna Factor (dB/m)+ Cable Loss (dB) – Pre-amplifier(dB).
3. Measurement (dBuV/m) = Reading(dBuV) + C.F (Correction Factor).
4. The emission levels of other frequencies are very lower than the limit and not show in test report.

EUT	BE3600 Dual-Band Wi-Fi 7 Router	Date of Test	2024-02-06
Factor	DRH18-E	Temp. / Humidity	20°C /65%
Polarity	Vertical	Site / Test Engineer	AC2 / Marvin
Test Mode	802.11be-20MHz_TX_Band1_CH 48_ANT 0+1	Test Voltage	AC 120V/60Hz

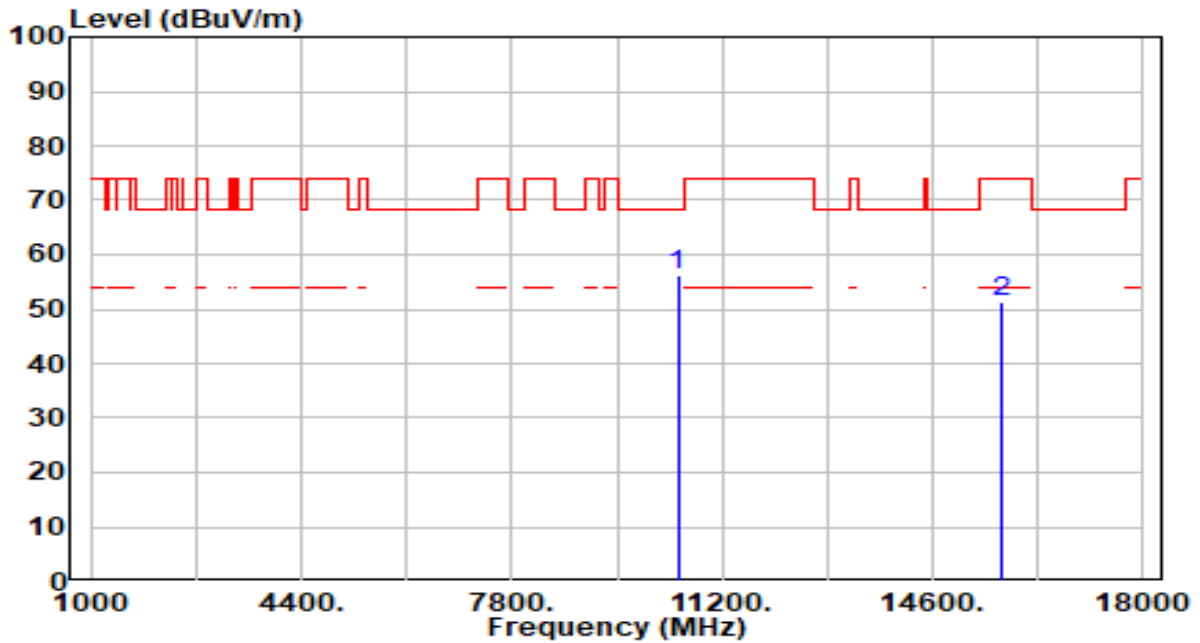

No	Frequency (MHz)	Reading (dBuV)	C.F (dB/m)	Measurement (dBuV/m)	Margin (dB)	Limit (dBuV/m)	Height (cm)	Angle (deg)	Remark (QP/PK/AV)
1	* 10480.000	51.49	4.71	56.21	-11.99	68.20	100	256	Peak
2	15720.000	44.99	6.39	51.38	-22.62	74.00	100	0	Peak

Note:

1. " *", means this data is the worst emission level.
2. C.F (Correction Factor) = Antenna Factor (dB/m)+ Cable Loss (dB) – Pre-amplifier(dB).
3. Measurement (dBuV/m) = Reading(dBuV) + C.F (Correction Factor).
4. The emission levels of other frequencies are very lower than the limit and not show in test report.

EUT	BE3600 Dual-Band Wi-Fi 7 Router	Date of Test	2024-02-06
Factor	DRH18-E	Temp. / Humidity	20°C /65%
Polarity	Horizontal	Site / Test Engineer	AC2 / Marvin
Test Mode	802.11be-20MHz_TX_Band2_CH 52_ANT 0+1	Test Voltage	AC 120V/60Hz

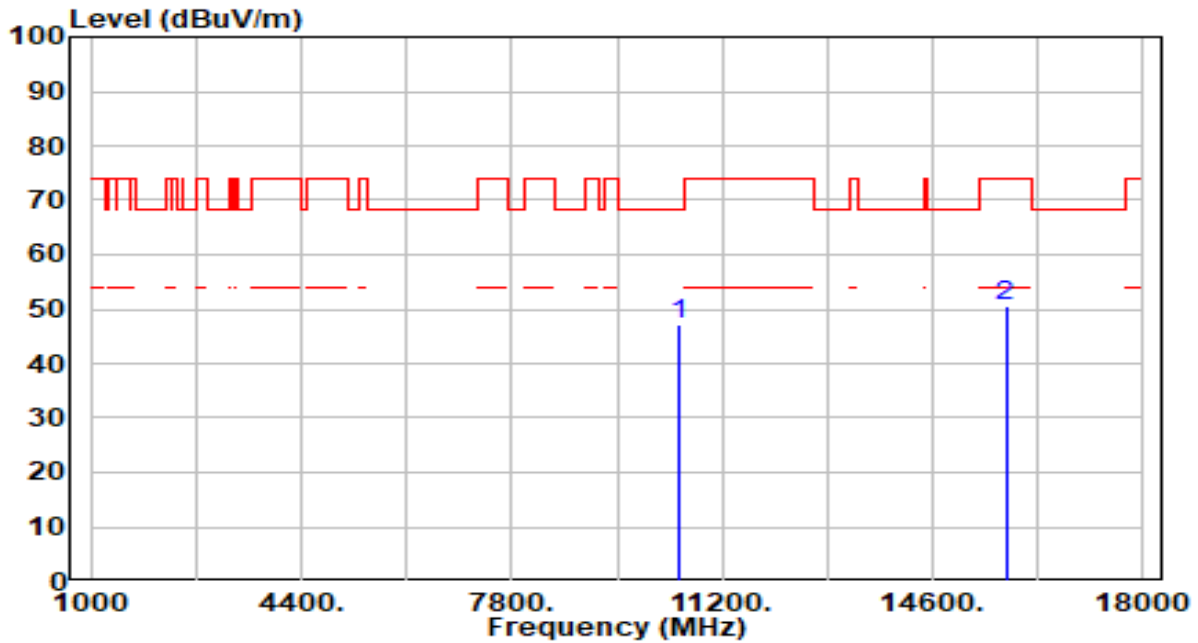

No	Frequency (MHz)	Reading (dBuV)	C.F (dB/m)	Measurement (dBuV/m)	Margin (dB)	Limit (dBuV/m)	Height (cm)	Angle (deg)	Remark (QP/PK/AV)
1	* 10520.000	42.39	4.67	47.06	-21.14	68.20	100	115	Peak
2	15780.000	44.23	6.51	50.74	-23.26	74.00	100	13	Peak

Note:

1. " *", means this data is the worst emission level.
2. C.F (Correction Factor) = Antenna Factor (dB/m)+ Cable Loss (dB) – Pre-amplifier(dB).
3. Measurement (dBuV/m) = Reading(dBuV) + C.F (Correction Factor).
4. The emission levels of other frequencies are very lower than the limit and not show in test report.

EUT	BE3600 Dual-Band Wi-Fi 7 Router	Date of Test	2024-02-06
Factor	DRH18-E	Temp. / Humidity	20°C /65%
Polarity	Vertical	Site / Test Engineer	AC2 / Marvin
Test Mode	802.11be-20MHz_TX_Band2_CH 52_ANT 0+1	Test Voltage	AC 120V/60Hz

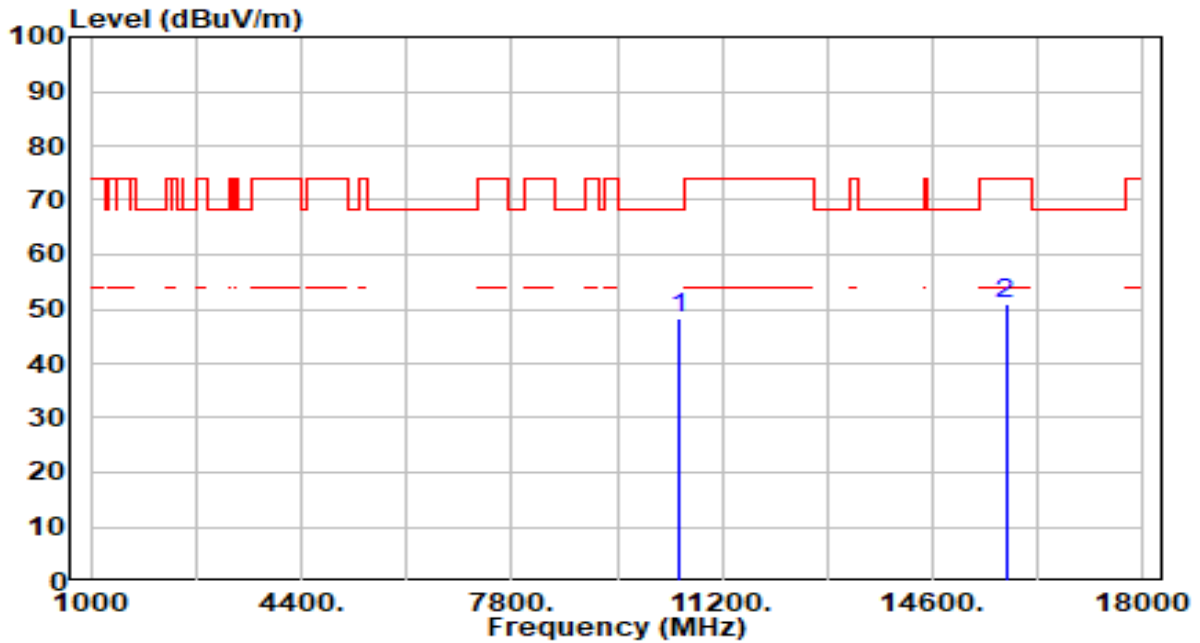

No	Frequency (MHz)	Reading (dBuV)	C.F (dB/m)	Measurement (dBuV/m)	Margin (dB)	Limit (dBuV/m)	Height (cm)	Angle (deg)	Remark (QP/PK/AV)
1	* 10520.000	43.67	4.67	48.34	-19.86	68.20	100	8	Peak
2	15780.000	44.28	6.51	50.79	-23.21	74.00	100	339	Peak

Note:

- "*", means this data is the worst emission level.
- C.F (Correction Factor) = Antenna Factor (dB/m)+ Cable Loss (dB) – Pre-amplifier(dB).
- Measurement (dBuV/m) = Reading(dBuV) + C.F (Correction Factor).
- The emission levels of other frequencies are very lower than the limit and not show in test report.

EUT	BE3600 Dual-Band Wi-Fi 7 Router	Date of Test	2024-02-06
Factor	DRH18-E	Temp. / Humidity	20°C /65%
Polarity	Horizontal	Site / Test Engineer	AC2 / Marvin
Test Mode	802.11be-20MHz_TX_Band2_CH 60_ANT 0+1	Test Voltage	AC 120V/60Hz

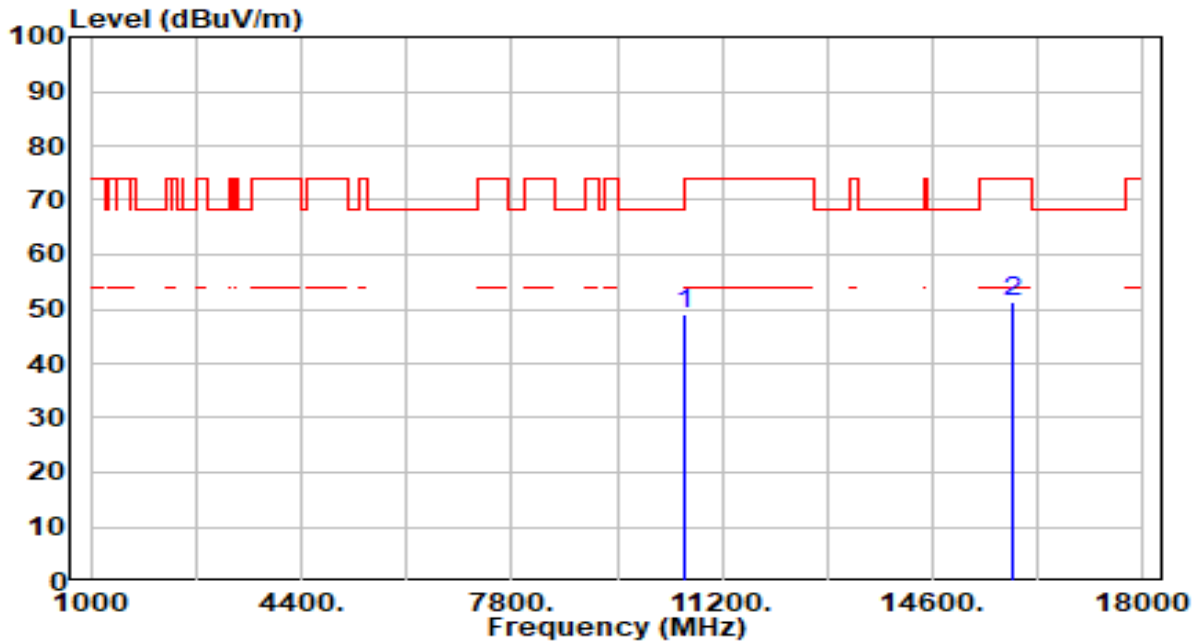

No	Frequency (MHz)	Reading (dBuV)	C.F (dB/m)	Measurement (dBuV/m)	Margin (dB)	Limit (dBuV/m)	Height (cm)	Angle (deg)	Remark (QP/PK/AV)
1	* 10600.000	44.57	4.61	49.18	-19.02	68.20	100	208	Peak
2	15900.000	44.93	6.55	51.48	-22.52	74.00	100	219	Peak

Note:

1. " *", means this data is the worst emission level.
2. C.F (Correction Factor) = Antenna Factor (dB/m)+ Cable Loss (dB) – Pre-amplifier(dB).
3. Measurement (dBuV/m) = Reading(dBuV) + C.F (Correction Factor).
4. The emission levels of other frequencies are very lower than the limit and not show in test report.

EUT	BE3600 Dual-Band Wi-Fi 7 Router	Date of Test	2024-02-06
Factor	DRH18-E	Temp. / Humidity	20°C /65%
Polarity	Vertical	Site / Test Engineer	AC2 / Marvin
Test Mode	802.11be-20MHz_TX_Band2_CH 60_ANT 0+1	Test Voltage	AC 120V/60Hz

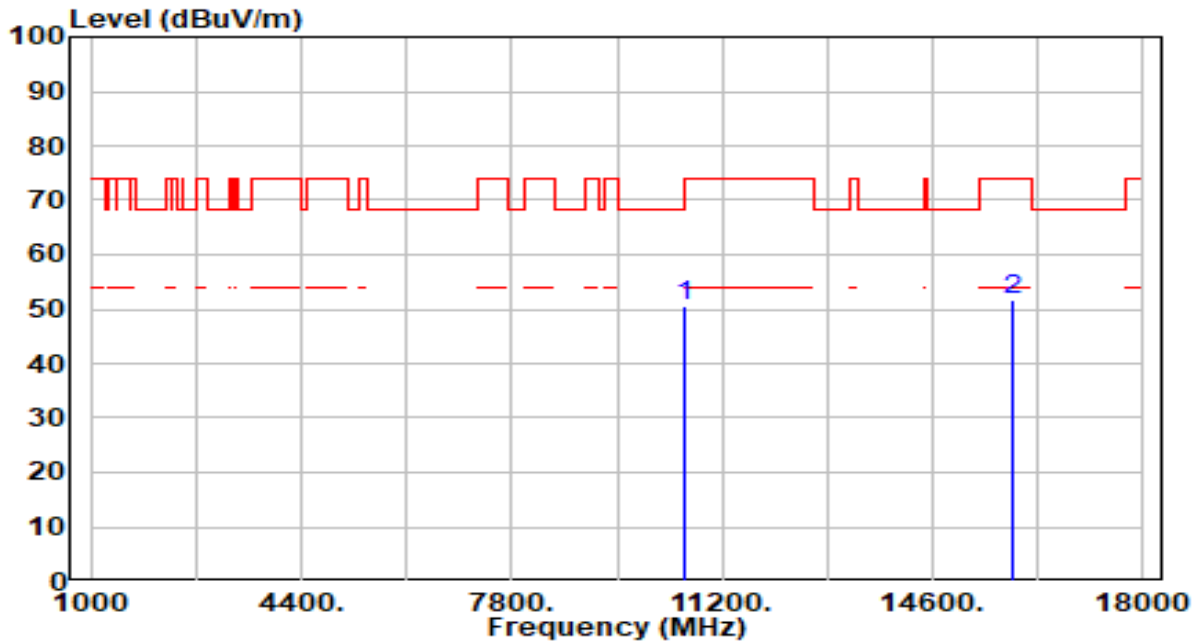

No	Frequency (MHz)	Reading (dBuV)	C.F (dB/m)	Measurement (dBuV/m)	Margin (dB)	Limit (dBuV/m)	Height (cm)	Angle (deg)	Remark (QP/PK/AV)
1	* 10600.000	45.86	4.61	50.48	-17.72	68.20	100	145	Peak
2	15900.000	45.08	6.55	51.63	-22.37	74.00	100	0	Peak

Note:

1. " *", means this data is the worst emission level.
2. C.F (Correction Factor) = Antenna Factor (dB/m)+ Cable Loss (dB) – Pre-amplifier(dB).
3. Measurement (dBuV/m) = Reading(dBuV) + C.F (Correction Factor).
4. The emission levels of other frequencies are very lower than the limit and not show in test report.

EUT	BE3600 Dual-Band Wi-Fi 7 Router	Date of Test	2024-02-06
Factor	DRH18-E	Temp. / Humidity	20°C /65%
Polarity	Horizontal	Site / Test Engineer	AC2 / Marvin
Test Mode	802.11be-20MHz_TX_Band2_CH 64_ANT 0+1	Test Voltage	AC 120V/60Hz

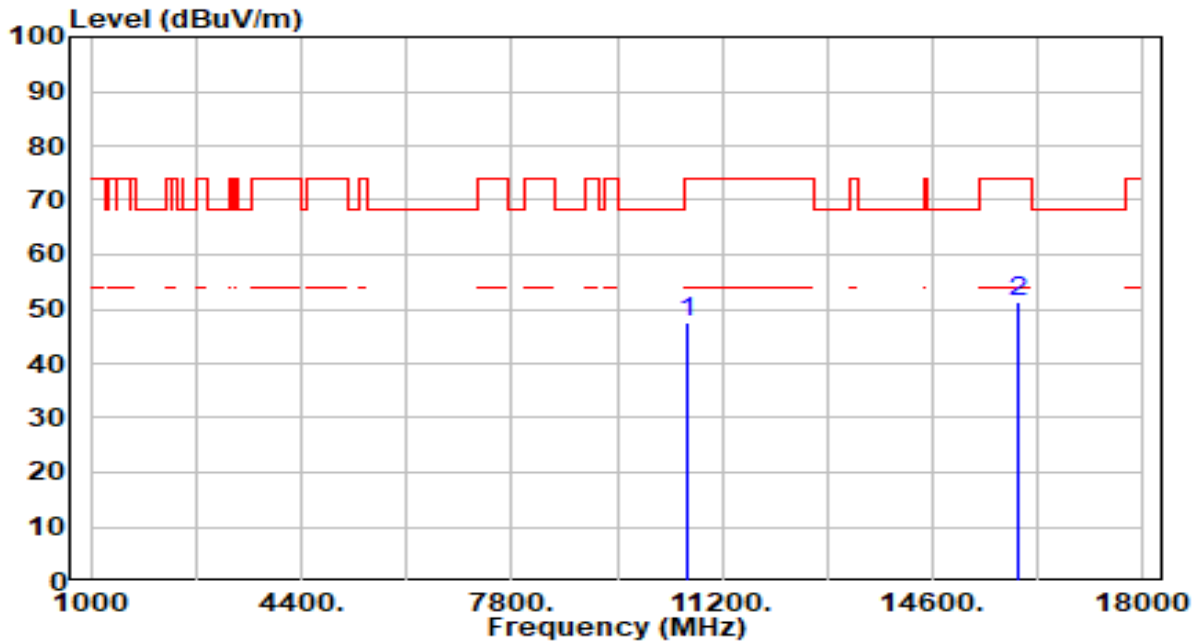

No	Frequency (MHz)	Reading (dBuV)	C.F (dB/m)	Measurement (dBuV/m)	Margin (dB)	Limit (dBuV/m)	Height (cm)	Angle (deg)	Remark (QP/PK/AV)
1	10640.000	42.86	4.62	47.48	-26.52	74.00	100	205	Peak
2	* 15960.000	44.89	6.55	51.44	-22.56	74.00	100	120	Peak

Note:

1. " *", means this data is the worst emission level.
2. C.F (Correction Factor) = Antenna Factor (dB/m)+ Cable Loss (dB) – Preamplifier(dB).
3. Measurement (dBuV/m) = Reading(dBuV) + C.F (Correction Factor).
4. The emission levels of other frequencies are very lower than the limit and not show in test report.

EUT	BE3600 Dual-Band Wi-Fi 7 Router	Date of Test	2024-02-06
Factor	DRH18-E	Temp. / Humidity	20°C /65%
Polarity	Vertical	Site / Test Engineer	AC2 / Marvin
Test Mode	802.11be-20MHz_TX_Band2_CH 64_ANT 0+1	Test Voltage	AC 120V/60Hz

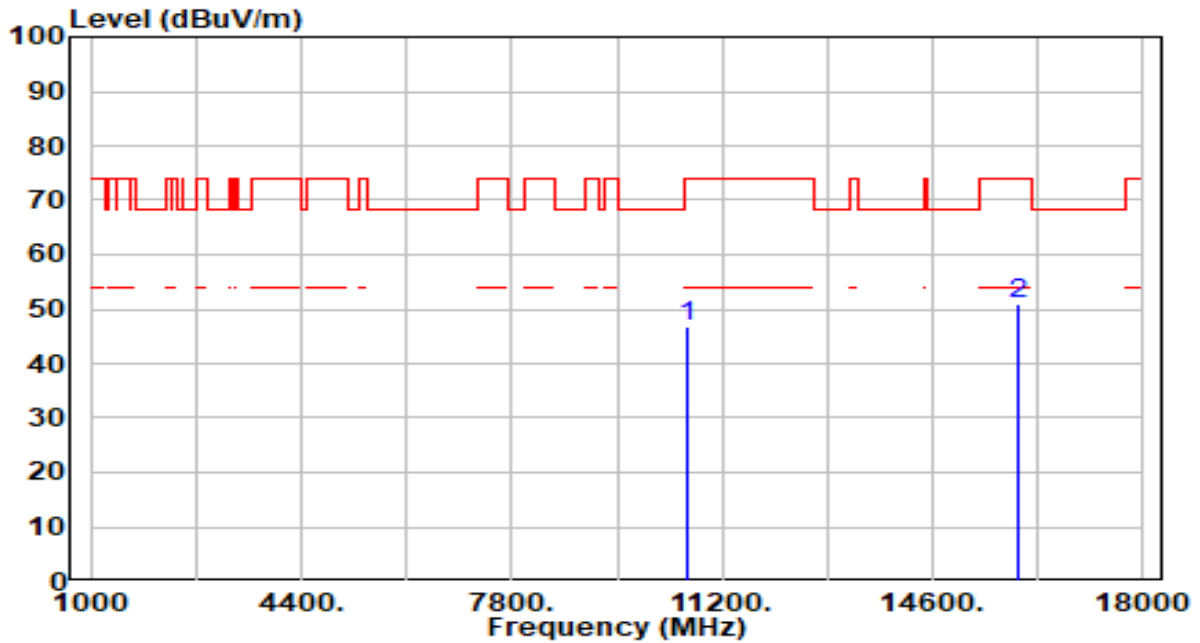

No	Frequency (MHz)	Reading (dBuV)	C.F (dB/m)	Measurement (dBuV/m)	Margin (dB)	Limit (dBuV/m)	Height (cm)	Angle (deg)	Remark (QP/PK/AV)
1	10640.000	42.00	4.62	46.62	-27.38	74.00	100	359	Peak
2	* 15960.000	44.28	6.55	50.83	-23.17	74.00	100	0	Peak

Note:

1. " *", means this data is the worst emission level.
2. C.F (Correction Factor) = Antenna Factor (dB/m)+ Cable Loss (dB) – Pre-amplifier(dB).
3. Measurement (dBuV/m) = Reading(dBuV) + C.F (Correction Factor).
4. The emission levels of other frequencies are very lower than the limit and not show in test report.

EUT	BE3600 Dual-Band Wi-Fi 7 Router	Date of Test	2024-02-06
Factor	DRH18-E	Temp. / Humidity	20°C /65%
Polarity	Horizontal	Site / Test Engineer	AC2 / Marvin
Test Mode	802.11be-20MHz_TX_Band3_CH 100_ANT 0+1	Test Voltage	AC 120V/60Hz

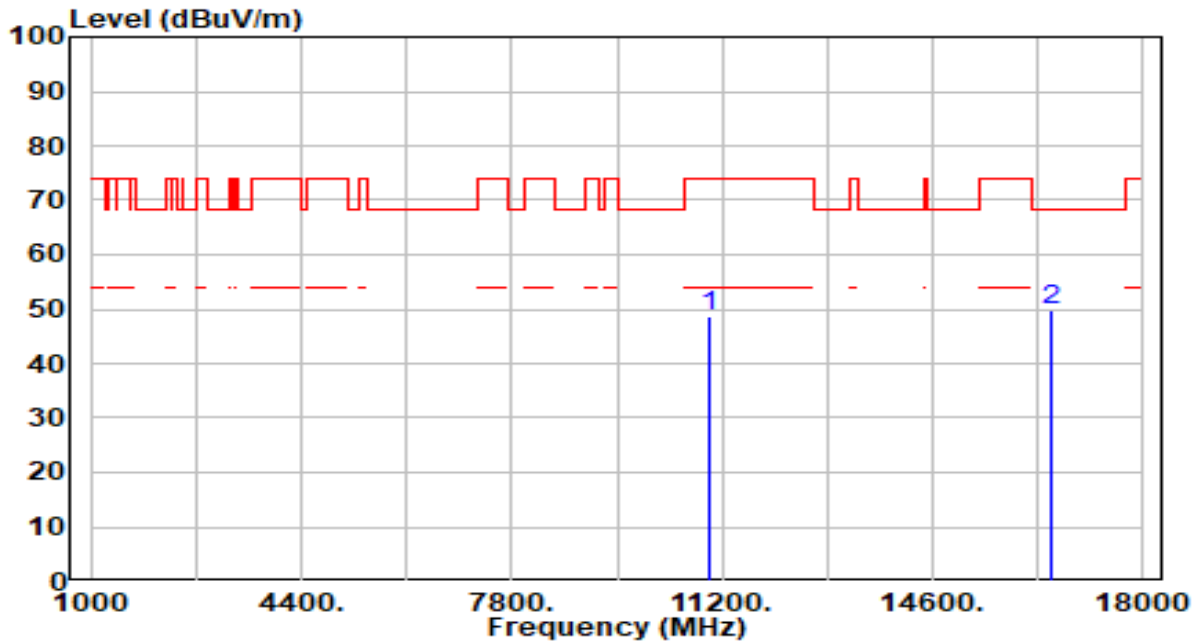

No	Frequency (MHz)	Reading (dBuV)	C.F (dB/m)	Measurement (dBuV/m)	Margin (dB)	Limit (dBuV/m)	Height (cm)	Angle (deg)	Remark (QP/PK/AV)
1	11000.000	44.14	4.52	48.66	-25.34	74.00	100	151	Peak
2	* 16500.000	43.58	6.10	49.68	-18.52	68.20	100	1	Peak

Note:

1. " *", means this data is the worst emission level.
2. C.F (Correction Factor) = Antenna Factor (dB/m)+ Cable Loss (dB) – Pre-amplifier(dB).
3. Measurement (dBuV/m) = Reading(dBuV) + C.F (Correction Factor).
4. The emission levels of other frequencies are very lower than the limit and not show in test report.

EUT	BE3600 Dual-Band Wi-Fi 7 Router	Date of Test	2024-02-06
Factor	DRH18-E	Temp. / Humidity	20°C /65%
Polarity	Vertical	Site / Test Engineer	AC2 / Marvin
Test Mode	802.11be-20MHz_TX_Band3_CH 100_ANT 0+1	Test Voltage	AC 120V/60Hz

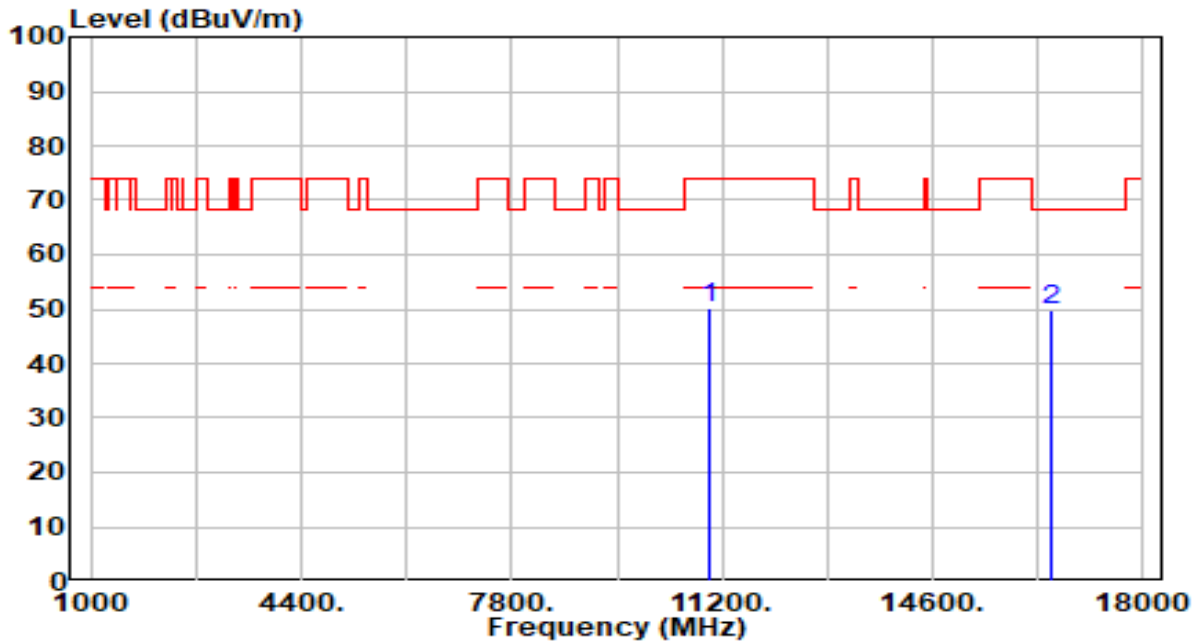

No	Frequency (MHz)	Reading (dBuV)	C.F (dB/m)	Measurement (dBuV/m)	Margin (dB)	Limit (dBuV/m)	Height (cm)	Angle (deg)	Remark (QP/PK/AV)
1	11000.000	45.67	4.52	50.19	-23.81	74.00	100	250	Peak
2	* 16500.000	43.80	6.10	49.90	-18.30	68.20	100	82	Peak

Note:

- "*", means this data is the worst emission level.
- C.F (Correction Factor) = Antenna Factor (dB/m)+ Cable Loss (dB) – Pre-amplifier(dB).
- Measurement (dBuV/m) = Reading(dBuV) + C.F (Correction Factor).
- The emission levels of other frequencies are very lower than the limit and not show in test report.

EUT	BE3600 Dual-Band Wi-Fi 7 Router	Date of Test	2024-02-06
Factor	DRH18-E	Temp. / Humidity	20°C /65%
Polarity	Horizontal	Site / Test Engineer	AC2 / Marvin
Test Mode	802.11be-20MHz_TX_Band3_CH 116_ANT 0+1	Test Voltage	AC 120V/60Hz

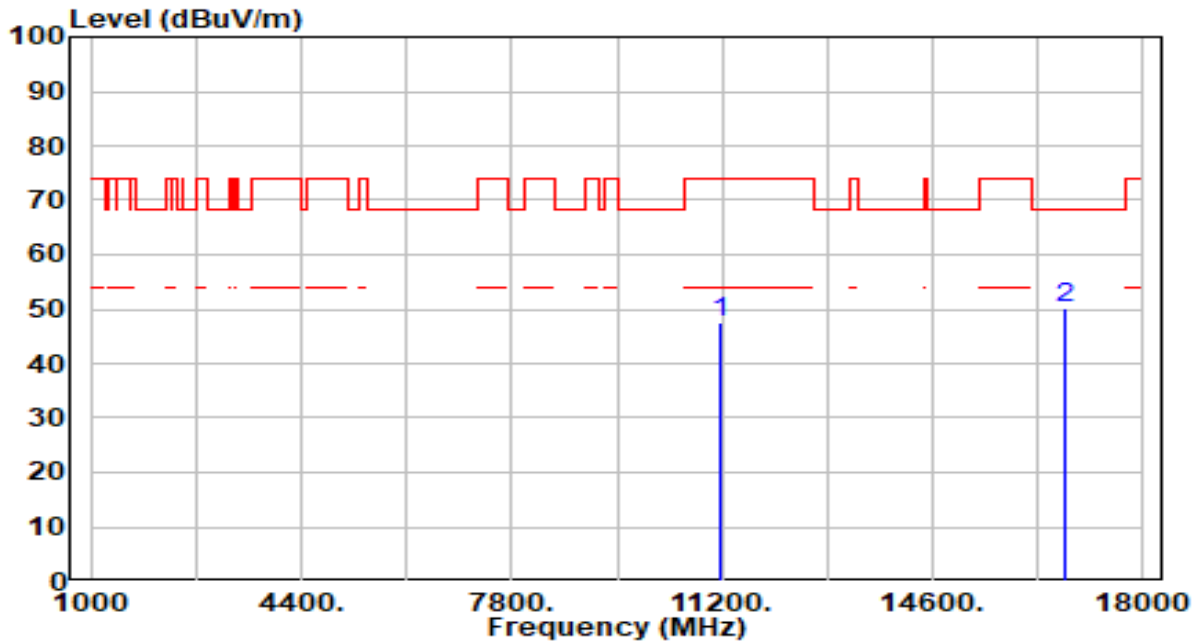

No	Frequency (MHz)	Reading (dBuV)	C.F (dB/m)	Measurement (dBuV/m)	Margin (dB)	Limit (dBuV/m)	Height (cm)	Angle (deg)	Remark (QP/PK/AV)
1	11160.000	42.76	4.94	47.70	-26.30	74.00	100	152	Peak
2	* 16740.000	44.11	6.19	50.30	-17.90	68.20	100	332	Peak

Note:

1. " *", means this data is the worst emission level.
2. C.F (Correction Factor) = Antenna Factor (dB/m)+ Cable Loss (dB) – Pre-amplifier(dB).
3. Measurement (dBuV/m) = Reading(dBuV) + C.F (Correction Factor).
4. The emission levels of other frequencies are very lower than the limit and not show in test report.

EUT	BE3600 Dual-Band Wi-Fi 7 Router	Date of Test	2024-02-06
Factor	DRH18-E	Temp. / Humidity	20°C /65%
Polarity	Vertical	Site / Test Engineer	AC2 / Marvin
Test Mode	802.11be-20MHz_TX_Band3_CH 116_ANT 0+1	Test Voltage	AC 120V/60Hz

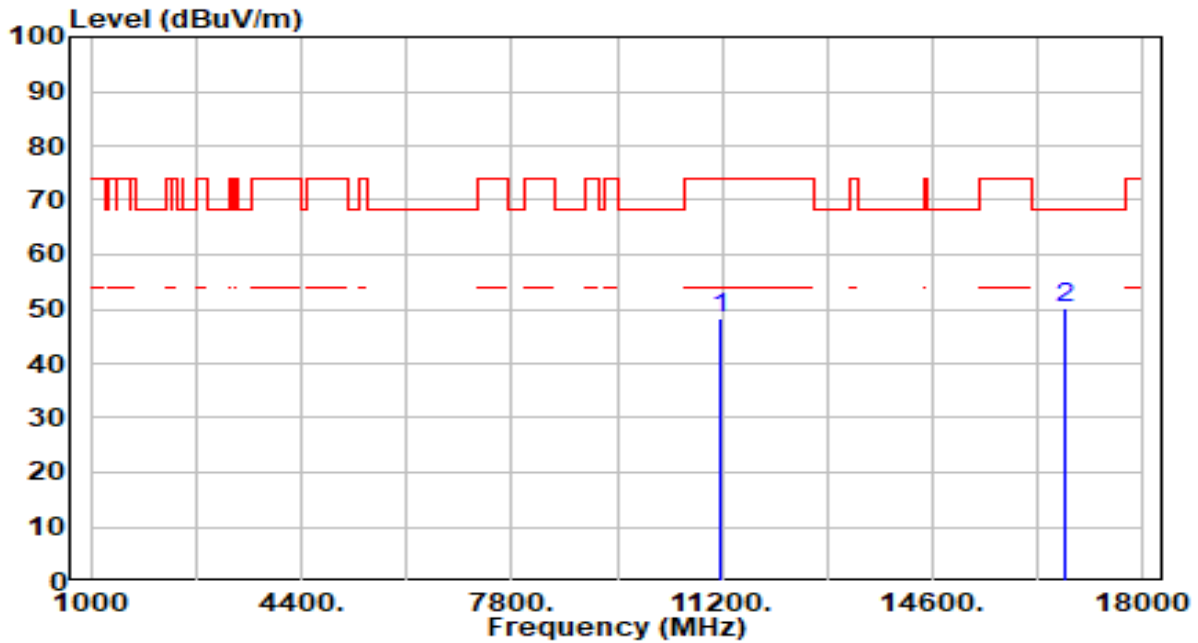

No	Frequency (MHz)	Reading (dBuV)	C.F (dB/m)	Measurement (dBuV/m)	Margin (dB)	Limit (dBuV/m)	Height (cm)	Angle (deg)	Remark (QP/PK/AV)
1	11160.000	43.30	4.94	48.24	-25.76	74.00	100	249	Peak
2	* 16740.000	44.10	6.19	50.29	-17.91	68.20	100	325	Peak

Note:

- "*", means this data is the worst emission level.
- C.F (Correction Factor) = Antenna Factor (dB/m)+ Cable Loss (dB) – Pre-amplifier(dB).
- Measurement (dBuV/m) = Reading(dBuV) + C.F (Correction Factor).
- The emission levels of other frequencies are very lower than the limit and not show in test report.

EUT	BE3600 Dual-Band Wi-Fi 7 Router	Date of Test	2024-02-06
Factor	DRH18-E	Temp. / Humidity	20°C /65%
Polarity	Horizontal	Site / Test Engineer	AC2 / Marvin
Test Mode	802.11be-20MHz_TX_Band3_CH 140_ANT 0+1	Test Voltage	AC 120V/60Hz

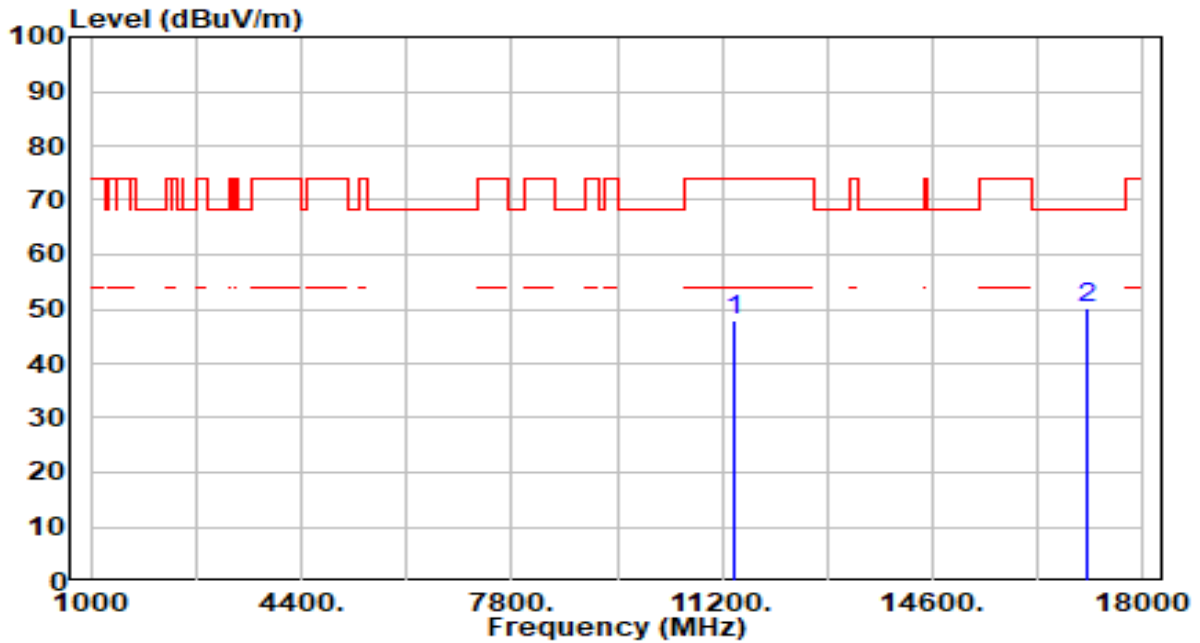

No	Frequency (MHz)	Reading (dBuV)	C.F (dB/m)	Measurement (dBuV/m)	Margin (dB)	Limit (dBuV/m)	Height (cm)	Angle (deg)	Remark (QP/PK/AV)
1	11400.000	42.65	5.26	47.91	-26.09	74.00	100	360	Peak
2	* 17100.000	44.37	5.97	50.34	-17.86	68.20	100	213	Peak

Note:

1. " *", means this data is the worst emission level.
2. C.F (Correction Factor) = Antenna Factor (dB/m)+ Cable Loss (dB) – Pre-amplifier(dB).
3. Measurement (dBuV/m) = Reading(dBuV) + C.F (Correction Factor).
4. The emission levels of other frequencies are very lower than the limit and not show in test report.

EUT	BE3600 Dual-Band Wi-Fi 7 Router	Date of Test	2024-02-06
Factor	DRH18-E	Temp. / Humidity	20°C /65%
Polarity	Vertical	Site / Test Engineer	AC2 / Marvin
Test Mode	802.11be-20MHz_TX_Band3_CH 140_ANT 0+1	Test Voltage	AC 120V/60Hz

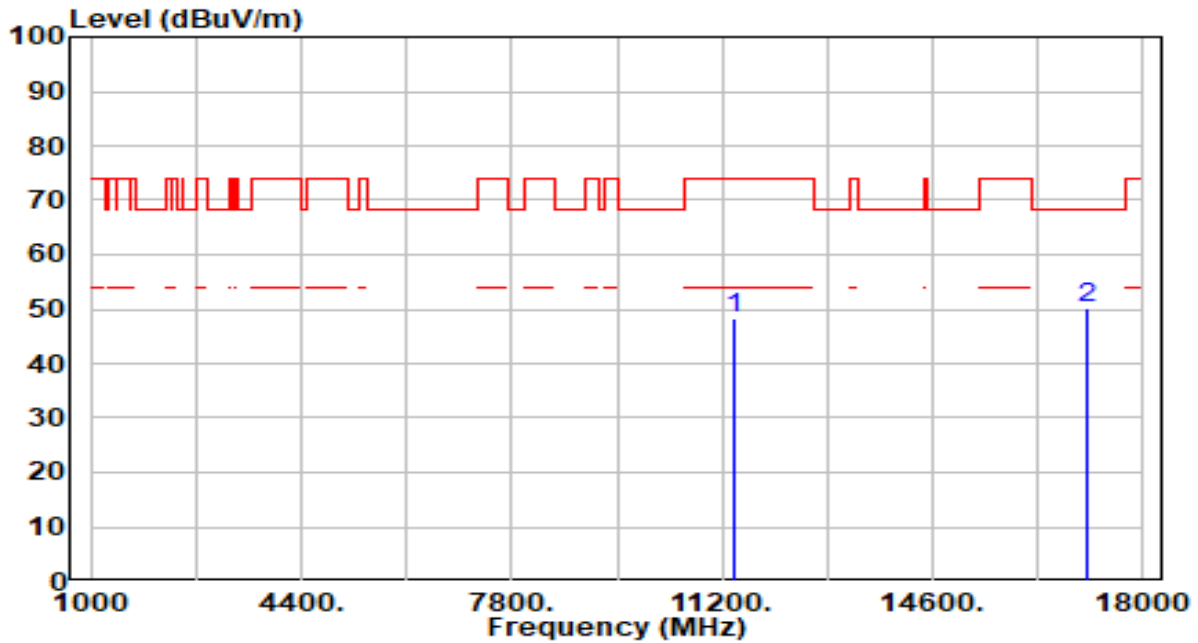

No	Frequency (MHz)	Reading (dBuV)	C.F (dB/m)	Measurement (dBuV/m)	Margin (dB)	Limit (dBuV/m)	Height (cm)	Angle (deg)	Remark (QP/PK/AV)
1	11400.000	43.22	5.26	48.48	-25.52	74.00	100	254	Peak
2	* 17100.000	44.04	5.97	50.02	-18.18	68.20	100	325	Peak

Note:

1. " *", means this data is the worst emission level.
2. C.F (Correction Factor) = Antenna Factor (dB/m)+ Cable Loss (dB) – Pre-amplifier(dB).
3. Measurement (dBuV/m) = Reading(dBuV) + C.F (Correction Factor).
4. The emission levels of other frequencies are very lower than the limit and not show in test report.

EUT	BE3600 Dual-Band Wi-Fi 7 Router	Date of Test	2024-02-06
Factor	DRH18-E	Temp. / Humidity	20°C /65%
Polarity	Horizontal	Site / Test Engineer	AC2 / Marvin
Test Mode	802.11be-20MHz_TX_Band3_CH 144_ANT 0+1	Test Voltage	AC 120V/60Hz

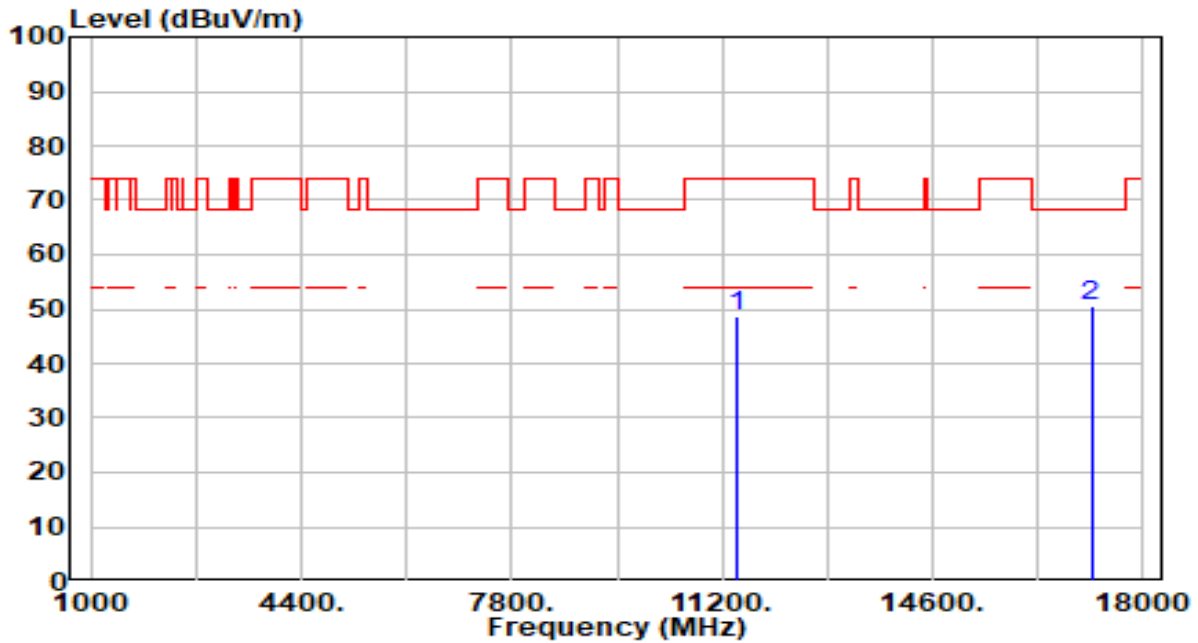

No	Frequency (MHz)	Reading (dBuV)	C.F (dB/m)	Measurement (dBuV/m)	Margin (dB)	Limit (dBuV/m)	Height (cm)	Angle (deg)	Remark (QP/PK/AV)
1	11440.000	43.35	5.29	48.64	-25.36	74.00	100	312	Peak
2	* 17160.000	44.73	5.87	50.60	-17.60	68.20	100	295	Peak

Note:

- " *", means this data is the worst emission level.
- C.F (Correction Factor) = Antenna Factor (dB/m)+ Cable Loss (dB) – Pre-amplifier(dB).
- Measurement (dBuV/m) = Reading(dBuV) + C.F (Correction Factor).
- The emission levels of other frequencies are very lower than the limit and not show in test report.

EUT	BE3600 Dual-Band Wi-Fi 7 Router	Date of Test	2024-02-06
Factor	DRH18-E	Temp. / Humidity	20°C /65%
Polarity	Vertical	Site / Test Engineer	AC2 / Marvin
Test Mode	802.11be-20MHz_TX_Band3_CH 144_ANT 0+1	Test Voltage	AC 120V/60Hz

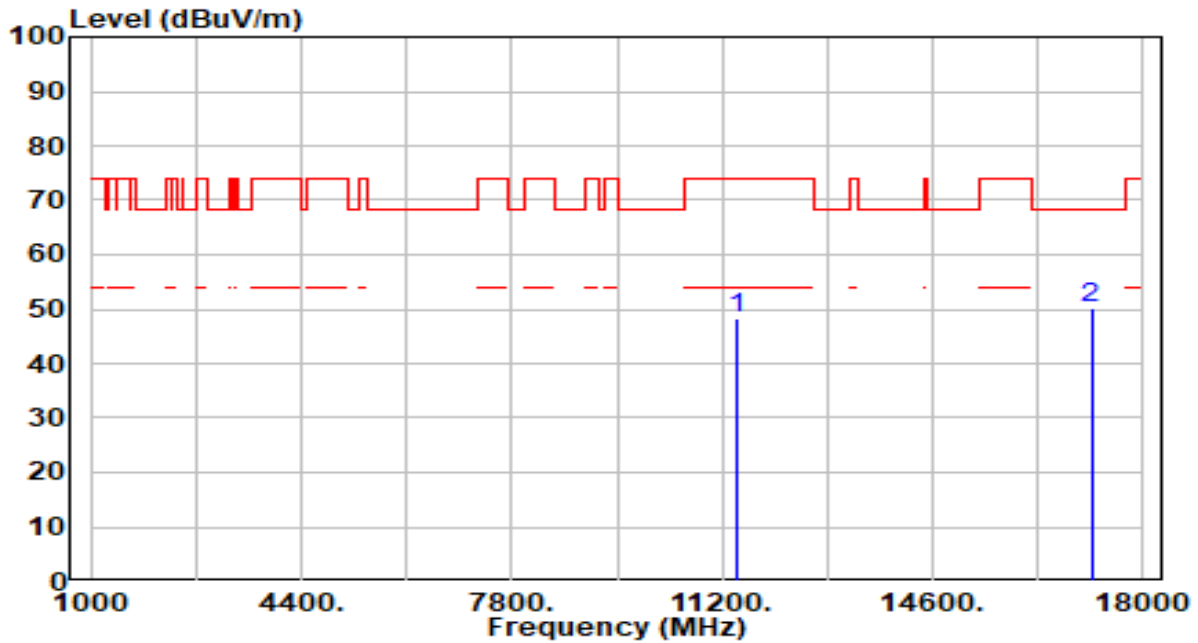

No	Frequency (MHz)	Reading (dBuV)	C.F (dB/m)	Measurement (dBuV/m)	Margin (dB)	Limit (dBuV/m)	Height (cm)	Angle (deg)	Remark (QP/PK/AV)
1	11440.000	43.15	5.29	48.44	-25.56	74.00	100	295	Peak
2	* 17160.000	44.39	5.87	50.26	-17.94	68.20	100	184	Peak

Note:

1. " *", means this data is the worst emission level.
2. C.F (Correction Factor) = Antenna Factor (dB/m)+ Cable Loss (dB) – Pre-amplifier(dB).
3. Measurement (dBuV/m) = Reading(dBuV) + C.F (Correction Factor).
4. The emission levels of other frequencies are very lower than the limit and not show in test report.

EUT	BE3600 Dual-Band Wi-Fi 7 Router	Date of Test	2024-02-06
Factor	DRH18-E	Temp. / Humidity	20°C /65%
Polarity	Horizontal	Site / Test Engineer	AC2 / Marvin
Test Mode	802.11be-20MHz_TX_Band4_CH 149_ANT 0+1	Test Voltage	AC 120V/60Hz

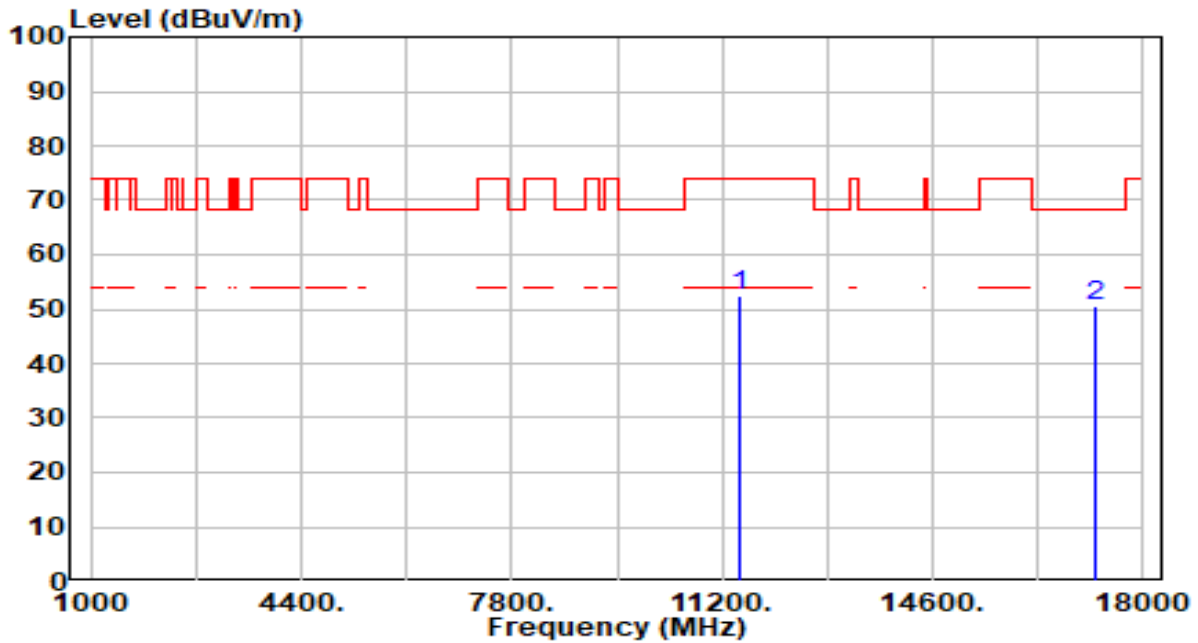

No	Frequency (MHz)	Reading (dBuV)	C.F (dB/m)	Measurement (dBuV/m)	Margin (dB)	Limit (dBuV/m)	Height (cm)	Angle (deg)	Remark (QP/PK/AV)
1	11490.000	46.95	5.32	52.27	-21.73	74.00	100	189	Peak
2	* 17235.000	45.00	5.71	50.71	-17.49	68.20	100	245	Peak

Note:

1. " *", means this data is the worst emission level.
2. C.F (Correction Factor) = Antenna Factor (dB/m)+ Cable Loss (dB) – Pre-amplifier(dB).
3. Measurement (dBuV/m) = Reading(dBuV) + C.F (Correction Factor).
4. The emission levels of other frequencies are very lower than the limit and not show in test report.

EUT	BE3600 Dual-Band Wi-Fi 7 Router	Date of Test	2024-02-06
Factor	DRH18-E	Temp. / Humidity	20°C /65%
Polarity	Vertical	Site / Test Engineer	AC2 / Marvin
Test Mode	802.11be-20MHz_TX_Band4_CH 149_ANT 0+1	Test Voltage	AC 120V/60Hz

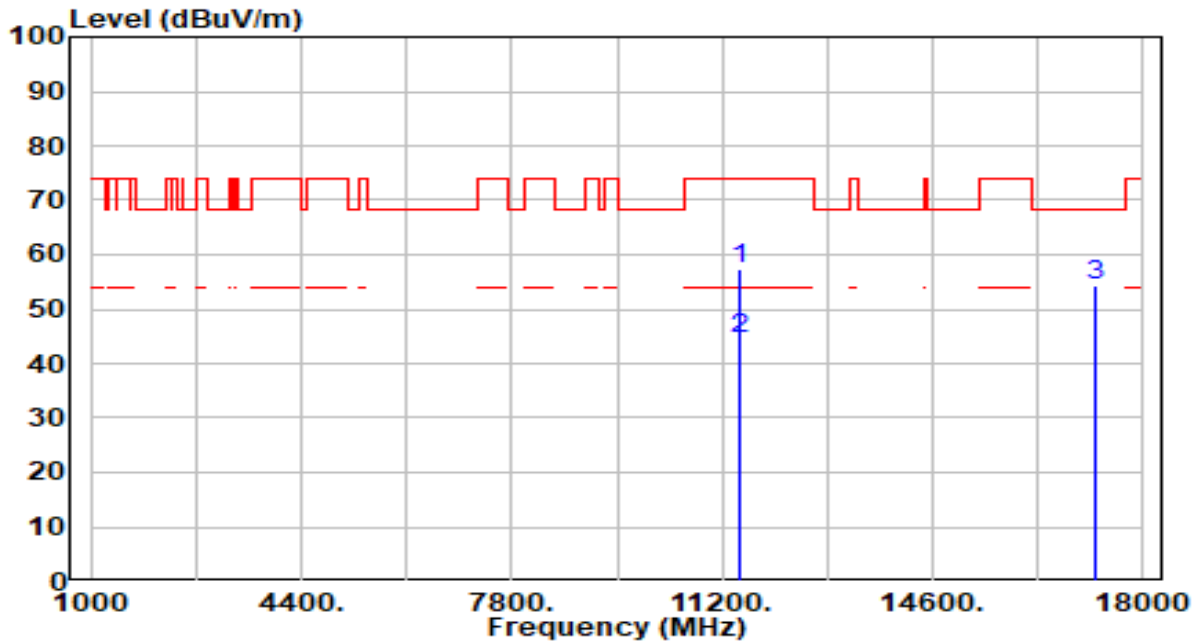

No	Frequency (MHz)	Reading (dBuV)	C.F (dB/m)	Measurement (dBuV/m)	Margin (dB)	Limit (dBuV/m)	Height (cm)	Angle (deg)	Remark (QP/PK/AV)
1	11490.000	52.01	5.32	57.33	-16.67	74.00	100	238	Peak
2	* 11490.000	39.29	5.32	44.61	-9.39	54.00	100	238	Average
3	* 17235.000	48.62	5.71	54.33	-13.87	68.20	100	260	Peak

Note:

1. " *", means this data is the worst emission level.
2. C.F (Correction Factor) = Antenna Factor (dB/m)+ Cable Loss (dB) – Preamplifier(dB).
3. Measurement (dBuV/m) = Reading(dBuV) + C.F (Correction Factor).
4. The emission levels of other frequencies are very lower than the limit and not show in test report.

EUT	BE3600 Dual-Band Wi-Fi 7 Router	Date of Test	2024-02-06
Factor	DRH18-E	Temp. / Humidity	20°C /65%
Polarity	Horizontal	Site / Test Engineer	AC2 / Marvin
Test Mode	802.11be-20MHz_TX_Band4_CH 157_ANT 0+1	Test Voltage	AC 120V/60Hz

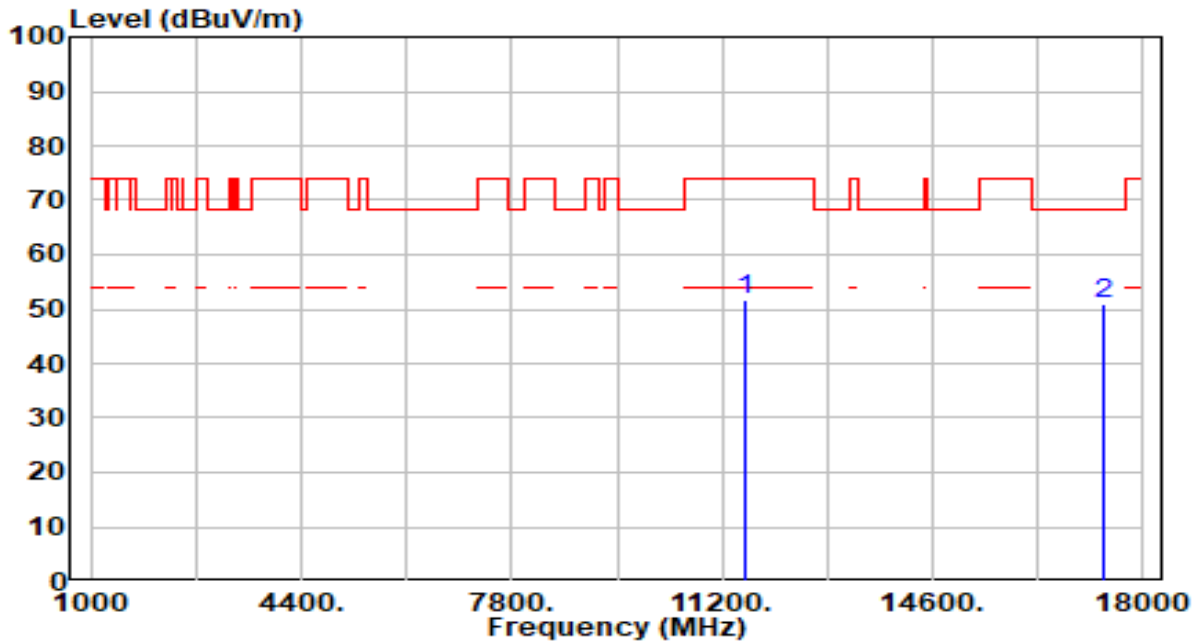

No	Frequency (MHz)	Reading (dBuV)	C.F (dB/m)	Measurement (dBuV/m)	Margin (dB)	Limit (dBuV/m)	Height (cm)	Angle (deg)	Remark (QP/PK/AV)
1	11570.000	46.27	5.38	51.65	-22.35	74.00	100	194	Peak
2	* 17355.000	45.42	5.39	50.81	-17.39	68.20	100	34	Peak

Note:

1. " *", means this data is the worst emission level.
2. C.F (Correction Factor) = Antenna Factor (dB/m)+ Cable Loss (dB) – Pre-amplifier(dB).
3. Measurement (dBuV/m) = Reading(dBuV) + C.F (Correction Factor).
4. The emission levels of other frequencies are very lower than the limit and not show in test report.

EUT	BE3600 Dual-Band Wi-Fi 7 Router	Date of Test	2024-02-06
Factor	DRH18-E	Temp. / Humidity	20°C /65%
Polarity	Vertical	Site / Test Engineer	AC2 / Marvin
Test Mode	802.11be-20MHz_TX_Band4_CH 157_ANT 0+1	Test Voltage	AC 120V/60Hz

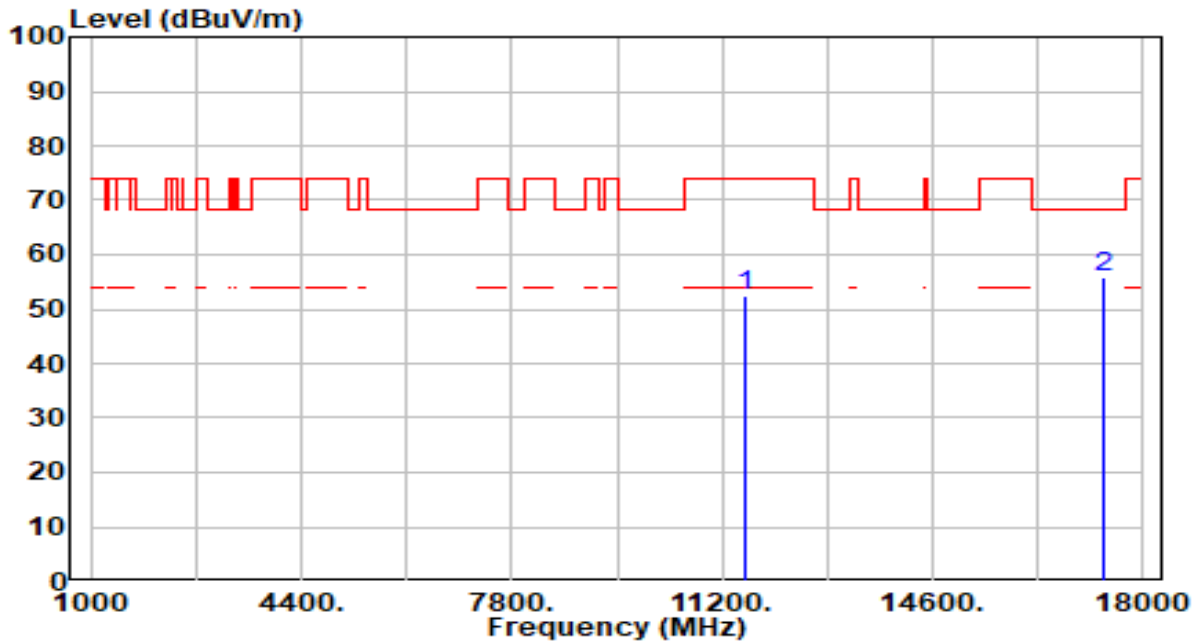

No	Frequency (MHz)	Reading (dBuV)	C.F (dB/m)	Measurement (dBuV/m)	Margin (dB)	Limit (dBuV/m)	Height (cm)	Angle (deg)	Remark (QP/PK/AV)
1	11570.000	47.04	5.38	52.41	-21.59	74.00	100	245	Peak
2	* 17355.000	50.54	5.39	55.93	-12.27	68.20	100	254	Peak

Note:

1. " *", means this data is the worst emission level.
2. C.F (Correction Factor) = Antenna Factor (dB/m)+ Cable Loss (dB) – Pre-amplifier(dB).
3. Measurement (dBuV/m) = Reading(dBuV) + C.F (Correction Factor).
4. The emission levels of other frequencies are very lower than the limit and not show in test report.

EUT	BE3600 Dual-Band Wi-Fi 7 Router	Date of Test	2024-02-06
Factor	DRH18-E	Temp. / Humidity	20°C /65%
Polarity	Horizontal	Site / Test Engineer	AC2 / Marvin
Test Mode	802.11be-20MHz_TX_Band4_CH 165_ANT 0+1	Test Voltage	AC 120V/60Hz

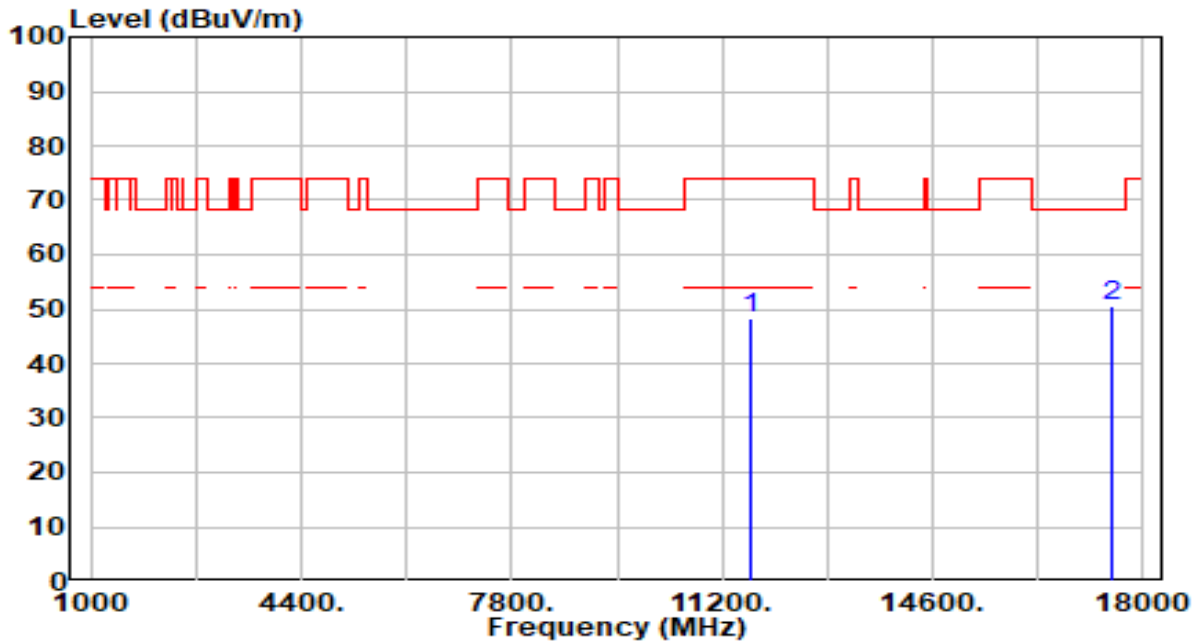

No	Frequency (MHz)	Reading (dBuV)	C.F (dB/m)	Measurement (dBuV/m)	Margin (dB)	Limit (dBuV/m)	Height (cm)	Angle (deg)	Remark (QP/PK/AV)
1	11650.000	43.03	5.36	48.40	-25.60	74.00	100	13	Peak
2	* 17475.000	45.28	5.29	50.57	-17.63	68.20	100	326	Peak

Note:

1. " *", means this data is the worst emission level.
2. C.F (Correction Factor) = Antenna Factor (dB/m)+ Cable Loss (dB) – Pre-amplifier(dB).
3. Measurement (dBuV/m) = Reading(dBuV) + C.F (Correction Factor).
4. The emission levels of other frequencies are very lower than the limit and not show in test report.

EUT	BE3600 Dual-Band Wi-Fi 7 Router	Date of Test	2024-02-06
Factor	DRH18-E	Temp. / Humidity	20°C /65%
Polarity	Vertical	Site / Test Engineer	AC2 / Marvin
Test Mode	802.11be-20MHz_TX_Band4_CH 165_ANT 0+1	Test Voltage	AC 120V/60Hz

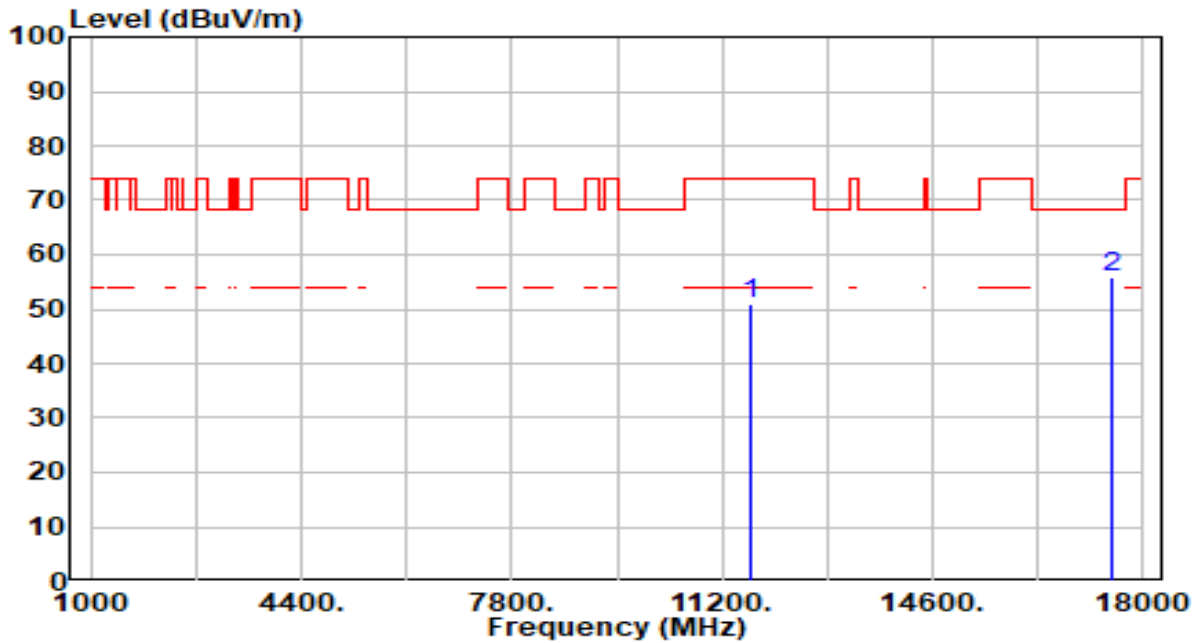

No	Frequency (MHz)	Reading (dBuV)	C.F (dB/m)	Measurement (dBuV/m)	Margin (dB)	Limit (dBuV/m)	Height (cm)	Angle (deg)	Remark (QP/PK/AV)
1	11650.000	45.40	5.36	50.77	-23.23	74.00	100	257	Peak
2	* 17475.000	50.55	5.29	55.84	-12.36	68.20	100	237	Peak

Note:

1. " *", means this data is the worst emission level.
2. C.F (Correction Factor) = Antenna Factor (dB/m)+ Cable Loss (dB) – Pre-amplifier(dB).
3. Measurement (dBuV/m) = Reading(dBuV) + C.F (Correction Factor).
4. The emission levels of other frequencies are very lower than the limit and not show in test report.

EUT	BE3600 Dual-Band Wi-Fi 7 Router	Date of Test	2024-02-06
Factor	DRH18-E	Temp. / Humidity	20°C /65%
Polarity	Horizontal	Site / Test Engineer	AC2 / Marvin
Test Mode	802.11be-40MHz_TX_Band1_CH 38_ANT 0+1	Test Voltage	AC 120V/60Hz

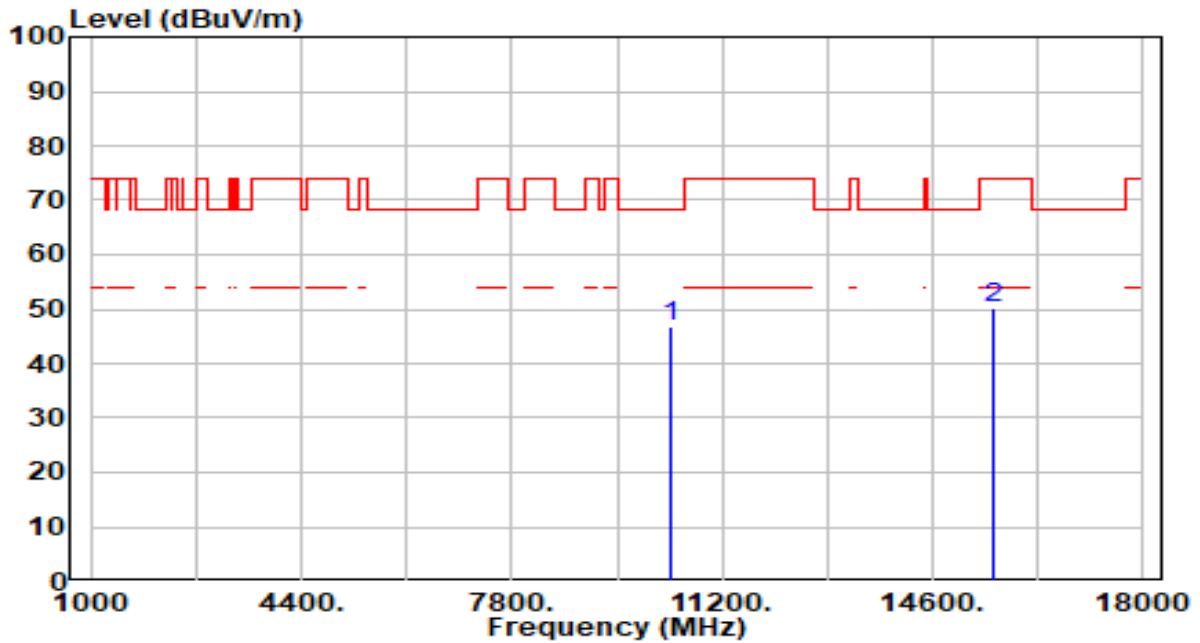

No	Frequency (MHz)	Reading (dBuV)	C.F (dB/m)	Measurement (dBuV/m)	Margin (dB)	Limit (dBuV/m)	Height (cm)	Angle (deg)	Remark (QP/PK/AV)
1	* 10380.000	42.11	4.84	46.95	-21.25	68.20	100	321	Peak
2	15570.000	44.10	6.18	50.28	-23.72	74.00	100	18	Peak

Note:

- "*", means this data is the worst emission level.
- C.F (Correction Factor) = Antenna Factor (dB/m)+ Cable Loss (dB) – Pre-amplifier(dB).
- Measurement (dBuV/m) = Reading(dBuV) + C.F (Correction Factor).
- The emission levels of other frequencies are very lower than the limit and not show in test report.

EUT	BE3600 Dual-Band Wi-Fi 7 Router	Date of Test	2024-02-06
Factor	DRH18-E	Temp. / Humidity	20°C /65%
Polarity	Vertical	Site / Test Engineer	AC2 / Marvin
Test Mode	802.11be-40MHz_TX_Band1_CH 38_ANT 0+1	Test Voltage	AC 120V/60Hz

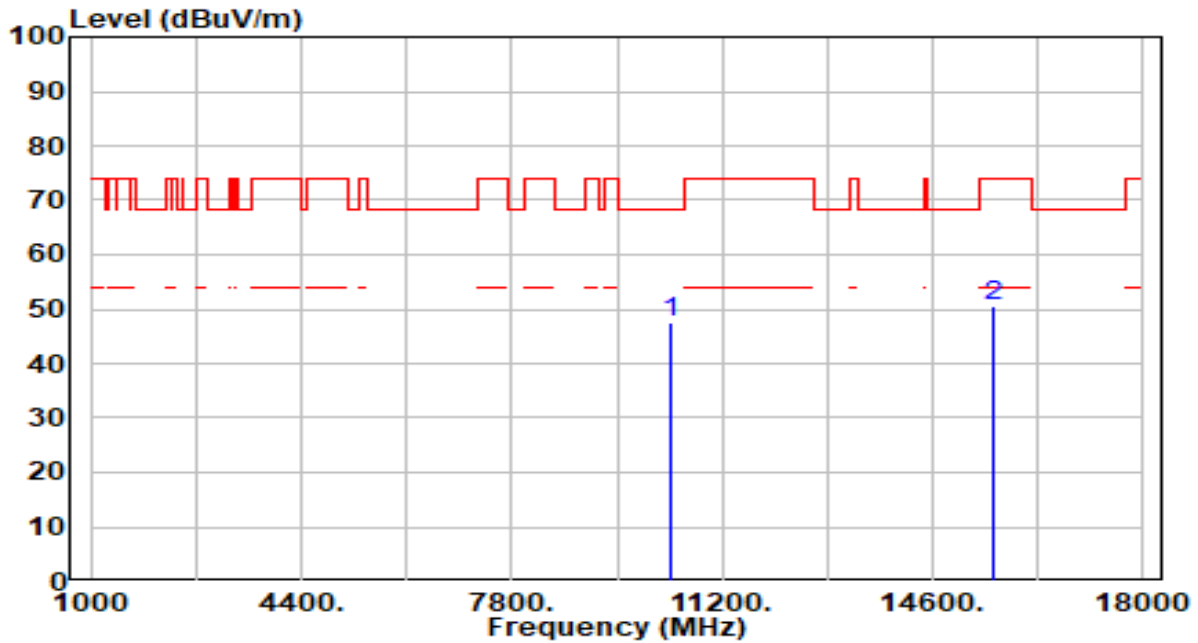

No	Frequency (MHz)	Reading (dBuV)	C.F (dB/m)	Measurement (dBuV/m)	Margin (dB)	Limit (dBuV/m)	Height (cm)	Angle (deg)	Remark (QP/PK/AV)
1	* 10380.000	42.58	4.84	47.43	-20.77	68.20	100	147	Peak
2	15570.000	44.22	6.18	50.40	-23.60	74.00	100	0	Peak

Note:

- "*", means this data is the worst emission level.
- C.F (Correction Factor) = Antenna Factor (dB/m)+ Cable Loss (dB) – Pre-amplifier(dB).
- Measurement (dBuV/m) = Reading(dBuV) + C.F (Correction Factor).
- The emission levels of other frequencies are very lower than the limit and not show in test report.

EUT	BE3600 Dual-Band Wi-Fi 7 Router	Date of Test	2024-02-06
Factor	DRH18-E	Temp. / Humidity	20°C /65%
Polarity	Horizontal	Site / Test Engineer	AC2 / Marvin
Test Mode	802.11be-40MHz_TX_Band1_CH 46_ANT 0+1	Test Voltage	AC 120V/60Hz

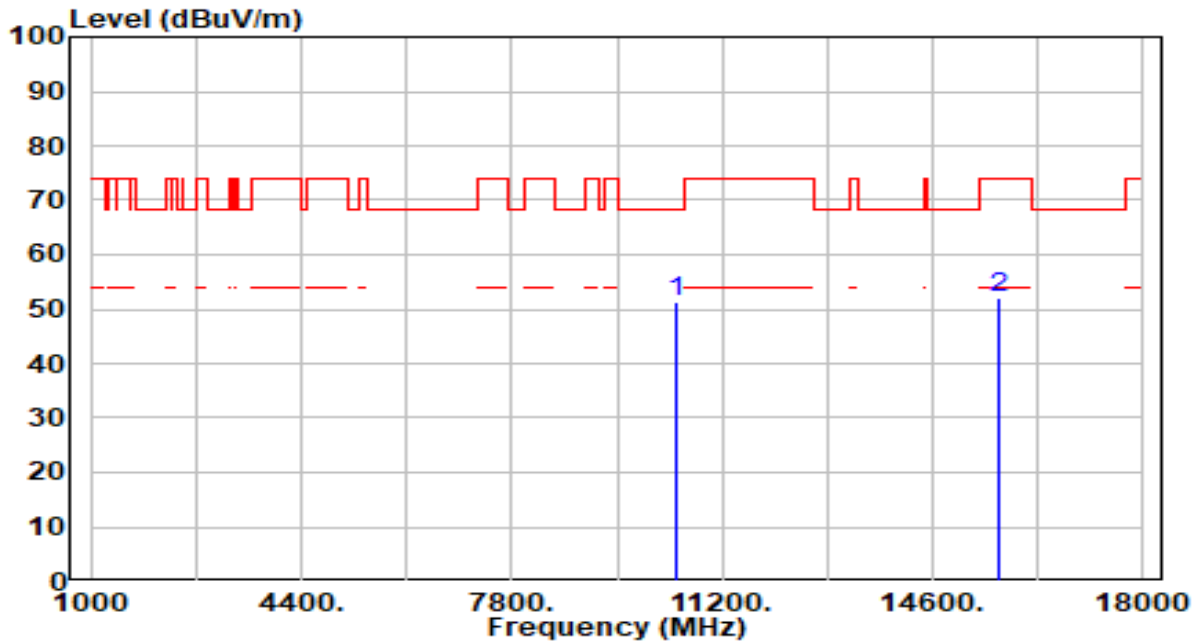

No	Frequency (MHz)	Reading (dBuV)	C.F (dB/m)	Measurement (dBuV/m)	Margin (dB)	Limit (dBuV/m)	Height (cm)	Angle (deg)	Remark (QP/PK/AV)
1	*	46.60	4.74	51.34	-16.86	68.20	100	214	Peak
2		45.67	6.33	51.99	-22.01	74.00	100	287	Peak

Note:

1. " *", means this data is the worst emission level.
2. C.F (Correction Factor) = Antenna Factor (dB/m)+ Cable Loss (dB) – Pre-amplifier(dB).
3. Measurement (dBuV/m) = Reading(dBuV) + C.F (Correction Factor).
4. The emission levels of other frequencies are very lower than the limit and not show in test report.

EUT	BE3600 Dual-Band Wi-Fi 7 Router	Date of Test	2024-02-06
Factor	DRH18-E	Temp. / Humidity	20°C /65%
Polarity	Vertical	Site / Test Engineer	AC2 / Marvin
Test Mode	802.11be-40MHz_TX_Band1_CH 46_ANT 0+1	Test Voltage	AC 120V/60Hz

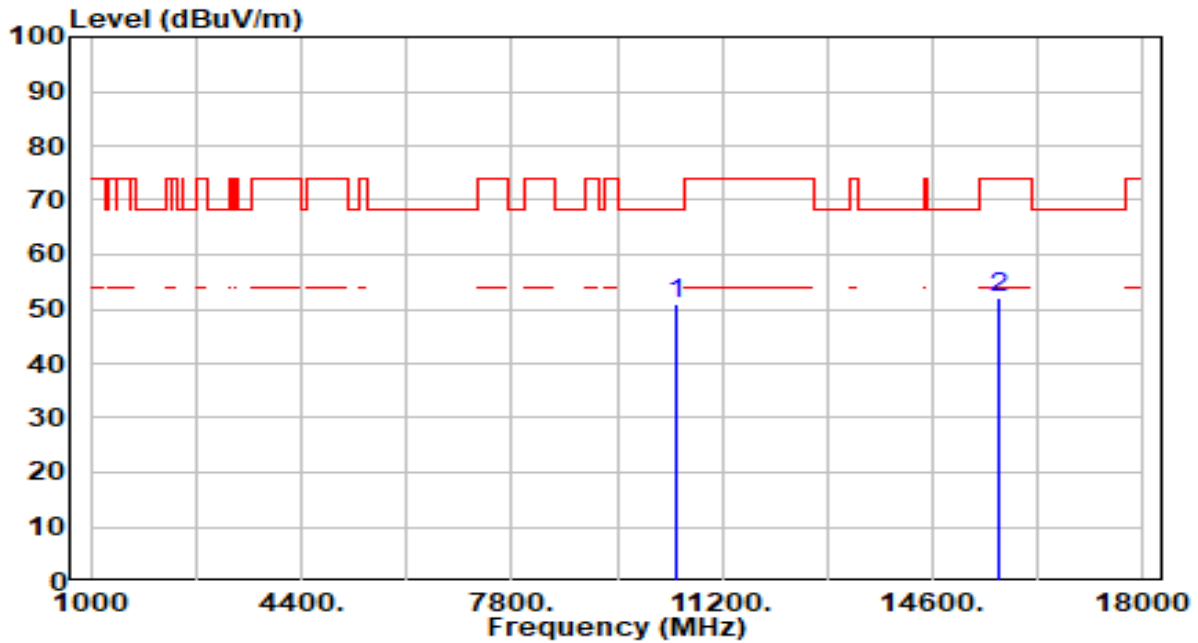

No	Frequency (MHz)	Reading (dBuV)	C.F (dB/m)	Measurement (dBuV/m)	Margin (dB)	Limit (dBuV/m)	Height (cm)	Angle (deg)	Remark (QP/PK/AV)
1	* 10460.000	46.12	4.74	50.86	-17.34	68.20	100	147	Peak
2	15690.000	45.70	6.33	52.03	-21.97	74.00	100	121	Peak

Note:

1. " *", means this data is the worst emission level.
2. C.F (Correction Factor) = Antenna Factor (dB/m)+ Cable Loss (dB) – Pre-amplifier(dB).
3. Measurement (dBuV/m) = Reading(dBuV) + C.F (Correction Factor).
4. The emission levels of other frequencies are very lower than the limit and not show in test report.

EUT	BE3600 Dual-Band Wi-Fi 7 Router	Date of Test	2024-02-06
Factor	DRH18-E	Temp. / Humidity	20°C /65%
Polarity	Horizontal	Site / Test Engineer	AC2 / Marvin
Test Mode	802.11be-40MHz_TX_Band2_CH 54_ANT 0+1	Test Voltage	AC 120V/60Hz

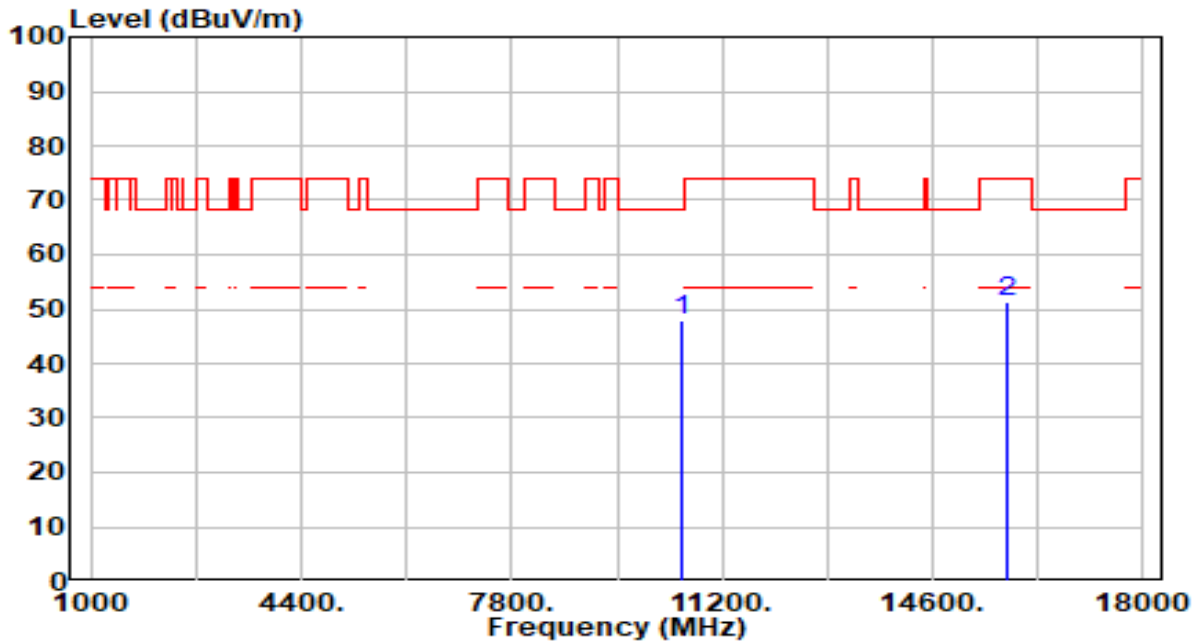

No	Frequency (MHz)	Reading (dBuV)	C.F (dB/m)	Measurement (dBuV/m)	Margin (dB)	Limit (dBuV/m)	Height (cm)	Angle (deg)	Remark (QP/PK/AV)
1	* 10540.000	43.09	4.66	47.74	-20.46	68.20	100	206	Peak
2	15810.000	44.69	6.55	51.24	-22.76	74.00	100	184	Peak

Note:

1. " *", means this data is the worst emission level.
2. C.F (Correction Factor) = Antenna Factor (dB/m)+ Cable Loss (dB) – Pre-amplifier(dB).
3. Measurement (dBuV/m) = Reading(dBuV) + C.F (Correction Factor).
4. The emission levels of other frequencies are very lower than the limit and not show in test report.

EUT	BE3600 Dual-Band Wi-Fi 7 Router	Date of Test	2024-02-06
Factor	DRH18-E	Temp. / Humidity	20°C /65%
Polarity	Vertical	Site / Test Engineer	AC2 / Marvin
Test Mode	802.11be-40MHz_TX_Band2_CH 54_ANT 0+1	Test Voltage	AC 120V/60Hz

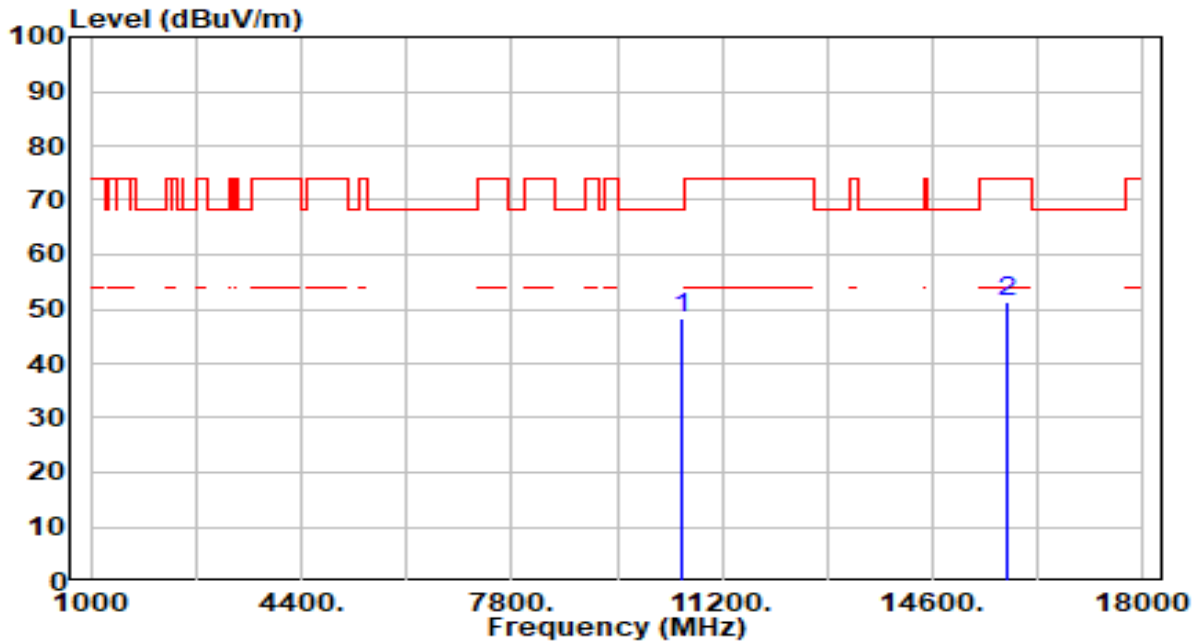

No	Frequency (MHz)	Reading (dBuV)	C.F (dB/m)	Measurement (dBuV/m)	Margin (dB)	Limit (dBuV/m)	Height (cm)	Angle (deg)	Remark (QP/PK/AV)
1	* 10540.000	43.71	4.66	48.37	-19.83	68.20	100	215	Peak
2	15810.000	44.77	6.55	51.32	-22.68	74.00	100	339	Peak

Note:

1. " *", means this data is the worst emission level.
2. C.F (Correction Factor) = Antenna Factor (dB/m)+ Cable Loss (dB) – Pre-amplifier(dB).
3. Measurement (dBuV/m) = Reading(dBuV) + C.F (Correction Factor).
4. The emission levels of other frequencies are very lower than the limit and not show in test report.

EUT	BE3600 Dual-Band Wi-Fi 7 Router	Date of Test	2024-02-06
Factor	DRH18-E	Temp. / Humidity	20°C /65%
Polarity	Horizontal	Site / Test Engineer	AC2 / Marvin
Test Mode	802.11be-40MHz_TX_Band2_CH 62_ANT 0+1	Test Voltage	AC 120V/60Hz

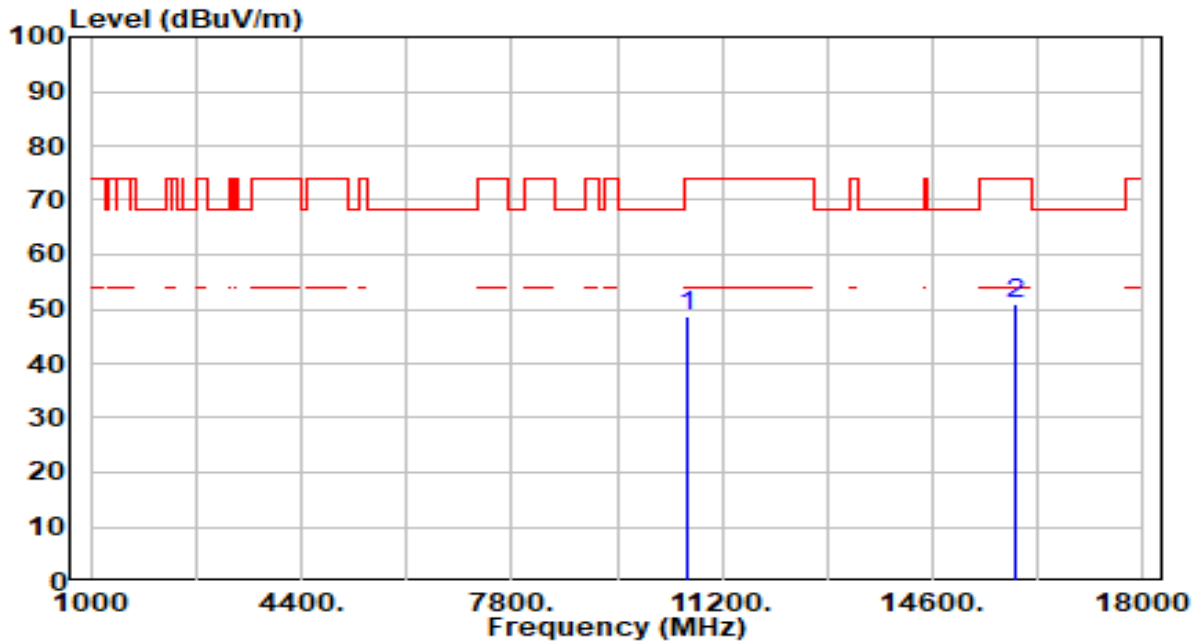

No	Frequency (MHz)	Reading (dBuV)	C.F (dB/m)	Measurement (dBuV/m)	Margin (dB)	Limit (dBuV/m)	Height (cm)	Angle (deg)	Remark (QP/PK/AV)
1	10620.000	44.04	4.62	48.65	-25.35	74.00	100	221	Peak
2	* 15930.000	44.57	6.55	51.12	-22.88	74.00	100	361	Peak

Note:

- "*", means this data is the worst emission level.
- C.F (Correction Factor) = Antenna Factor (dB/m)+ Cable Loss (dB) – Pre-amplifier(dB).
- Measurement (dBuV/m) = Reading(dBuV) + C.F (Correction Factor).
- The emission levels of other frequencies are very lower than the limit and not show in test report.

EUT	BE3600 Dual-Band Wi-Fi 7 Router	Date of Test	2024-02-06
Factor	DRH18-E	Temp. / Humidity	20°C /65%
Polarity	Vertical	Site / Test Engineer	AC2 / Marvin
Test Mode	802.11be-40MHz_TX_Band2_CH 62_ANT 0+1	Test Voltage	AC 120V/60Hz

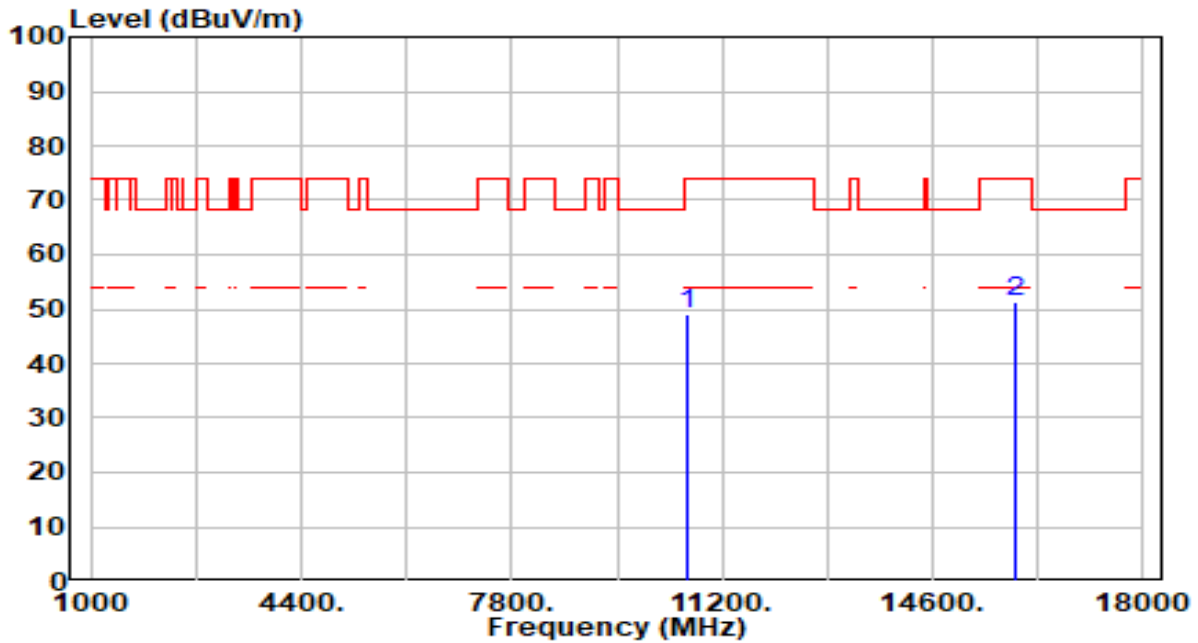

No	Frequency (MHz)	Reading (dBuV)	C.F (dB/m)	Measurement (dBuV/m)	Margin (dB)	Limit (dBuV/m)	Height (cm)	Angle (deg)	Remark (QP/PK/AV)
1	10620.000	44.30	4.62	48.92	-25.08	74.00	100	246	Peak
2	* 15930.000	44.59	6.55	51.14	-22.86	74.00	100	297	Peak

Note:

1. " *", means this data is the worst emission level.
2. C.F (Correction Factor) = Antenna Factor (dB/m)+ Cable Loss (dB) – Pre-amplifier(dB).
3. Measurement (dBuV/m) = Reading(dBuV) + C.F (Correction Factor).
4. The emission levels of other frequencies are very lower than the limit and not show in test report.

EUT	BE3600 Dual-Band Wi-Fi 7 Router	Date of Test	2024-02-06
Factor	DRH18-E	Temp. / Humidity	20°C /65%
Polarity	Horizontal	Site / Test Engineer	AC2 / Marvin
Test Mode	802.11be-40MHz_TX_Band3_CH 102_ANT 0+1	Test Voltage	AC 120V/60Hz

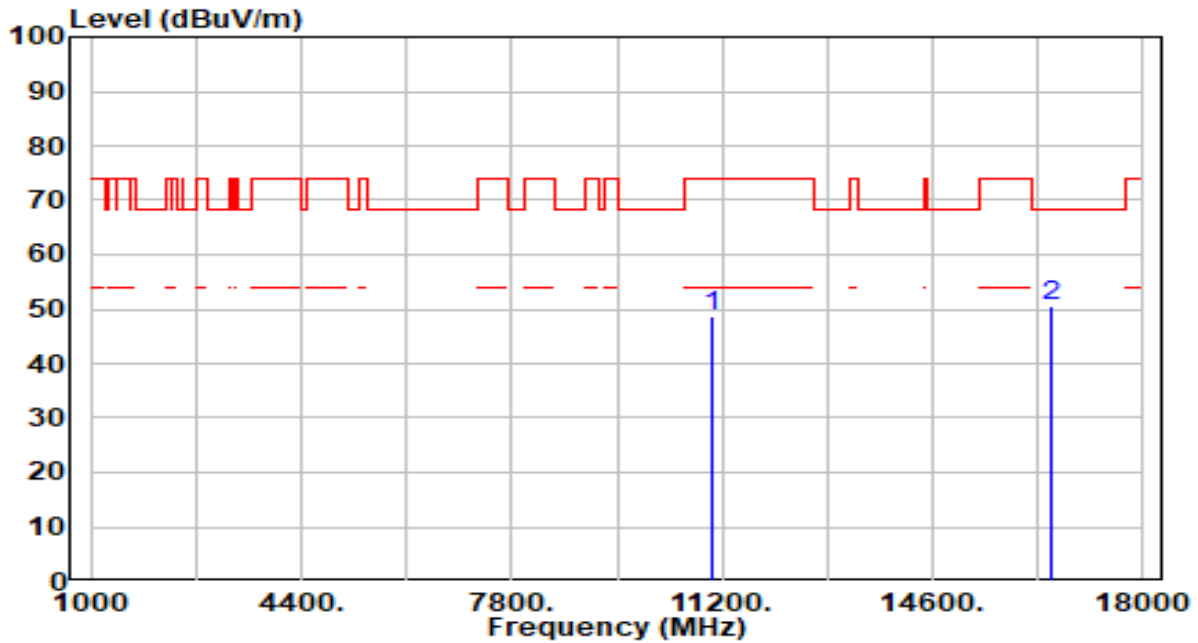

No	Frequency (MHz)	Reading (dBuV)	C.F (dB/m)	Measurement (dBuV/m)	Margin (dB)	Limit (dBuV/m)	Height (cm)	Angle (deg)	Remark (QP/PK/AV)
1	11020.000	44.02	4.57	48.59	-25.41	74.00	100	323	Peak
2	* 16530.000	44.31	6.10	50.42	-17.78	68.20	100	145	Peak

Note:

1. " *", means this data is the worst emission level.
2. C.F (Correction Factor) = Antenna Factor (dB/m)+ Cable Loss (dB) – Pre-amplifier(dB).
3. Measurement (dBuV/m) = Reading(dBuV) + C.F (Correction Factor).
4. The emission levels of other frequencies are very lower than the limit and not show in test report.

EUT	BE3600 Dual-Band Wi-Fi 7 Router	Date of Test	2024-02-06
Factor	DRH18-E	Temp. / Humidity	20°C /65%
Polarity	Vertical	Site / Test Engineer	AC2 / Marvin
Test Mode	802.11be-40MHz_TX_Band3_CH 102_ANT 0+1	Test Voltage	AC 120V/60Hz

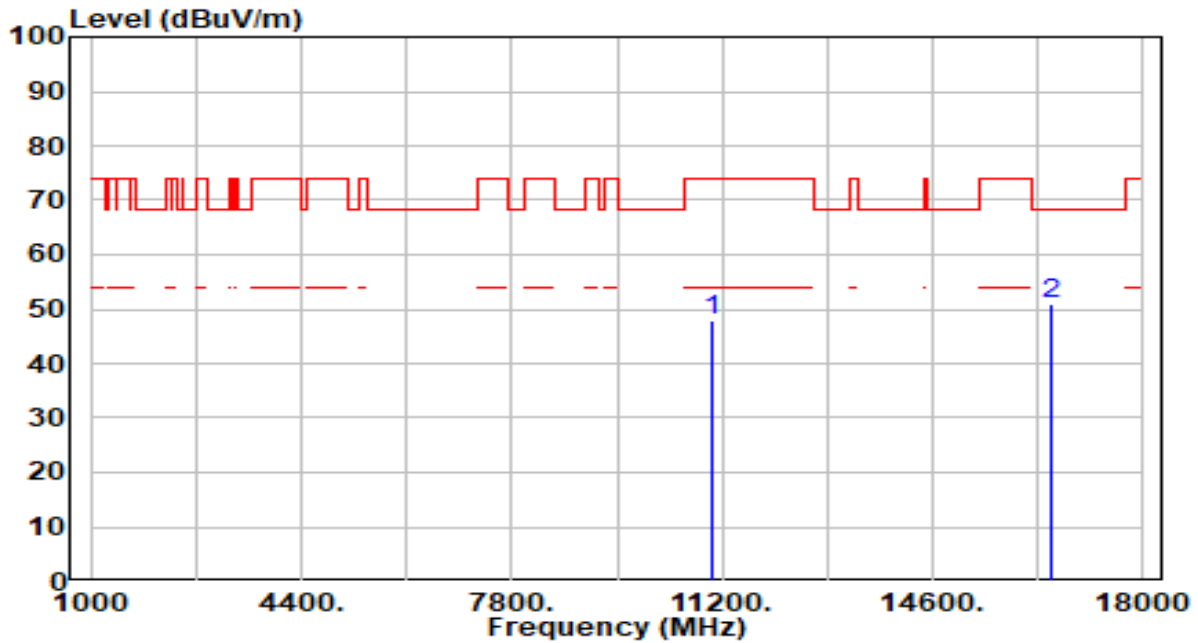

No	Frequency (MHz)	Reading (dBuV)	C.F (dB/m)	Measurement (dBuV/m)	Margin (dB)	Limit (dBuV/m)	Height (cm)	Angle (deg)	Remark (QP/PK/AV)
1	11020.000	43.24	4.57	47.81	-26.19	74.00	100	132	Peak
2	* 16530.000	44.86	6.10	50.96	-17.24	68.20	100	180	Peak

Note:

- "*", means this data is the worst emission level.
- C.F (Correction Factor) = Antenna Factor (dB/m)+ Cable Loss (dB) – Pre-amplifier(dB).
- Measurement (dBuV/m) = Reading(dBuV) + C.F (Correction Factor).
- The emission levels of other frequencies are very lower than the limit and not show in test report.

EUT	BE3600 Dual-Band Wi-Fi 7 Router	Date of Test	2024-02-06
Factor	DRH18-E	Temp. / Humidity	20°C /65%
Polarity	Horizontal	Site / Test Engineer	AC2 / Marvin
Test Mode	802.11be-40MHz_TX_Band3_CH 110_ANT 0+1	Test Voltage	AC 120V/60Hz

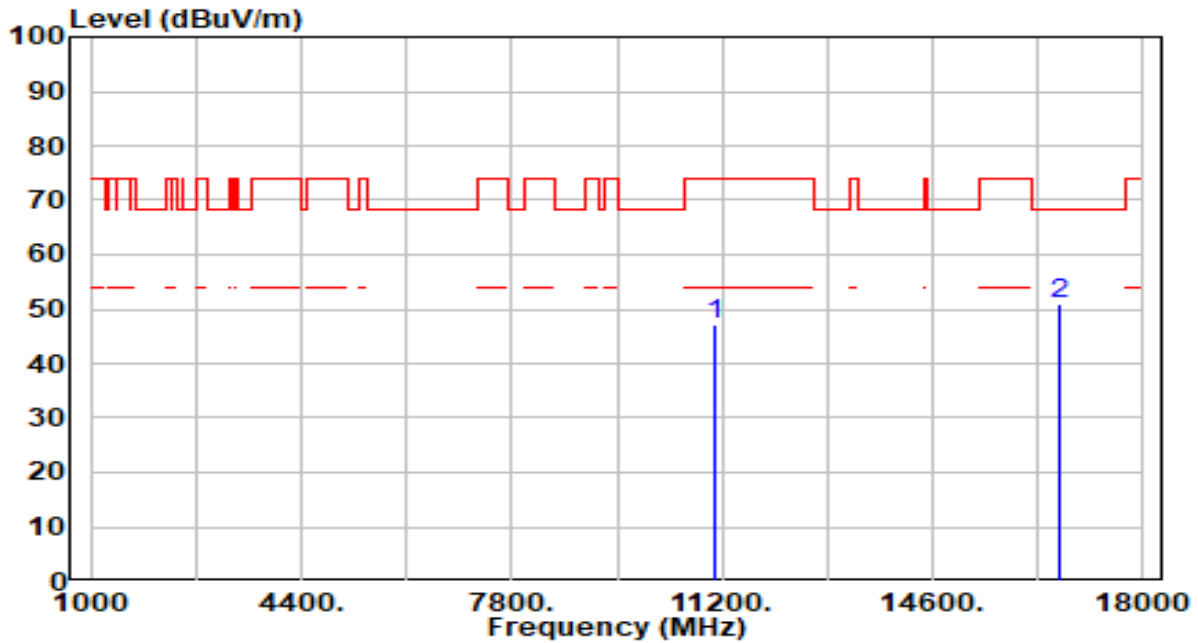

No	Frequency (MHz)	Reading (dBuV)	C.F (dB/m)	Measurement (dBuV/m)	Margin (dB)	Limit (dBuV/m)	Height (cm)	Angle (deg)	Remark (QP/PK/AV)
1	11100.000	42.28	4.78	47.06	-26.94	74.00	100	198	Peak
2	* 16650.000	44.65	6.14	50.78	-17.42	68.20	100	286	Peak

Note:

1. " *", means this data is the worst emission level.
2. C.F (Correction Factor) = Antenna Factor (dB/m)+ Cable Loss (dB) – Pre-amplifier(dB).
3. Measurement (dBuV/m) = Reading(dBuV) + C.F (Correction Factor).
4. The emission levels of other frequencies are very lower than the limit and not show in test report.

EUT	BE3600 Dual-Band Wi-Fi 7 Router	Date of Test	2024-02-06
Factor	DRH18-E	Temp. / Humidity	20°C /65%
Polarity	Vertical	Site / Test Engineer	AC2 / Marvin
Test Mode	802.11be-40MHz_TX_Band3_CH 110_ANT 0+1	Test Voltage	AC 120V/60Hz

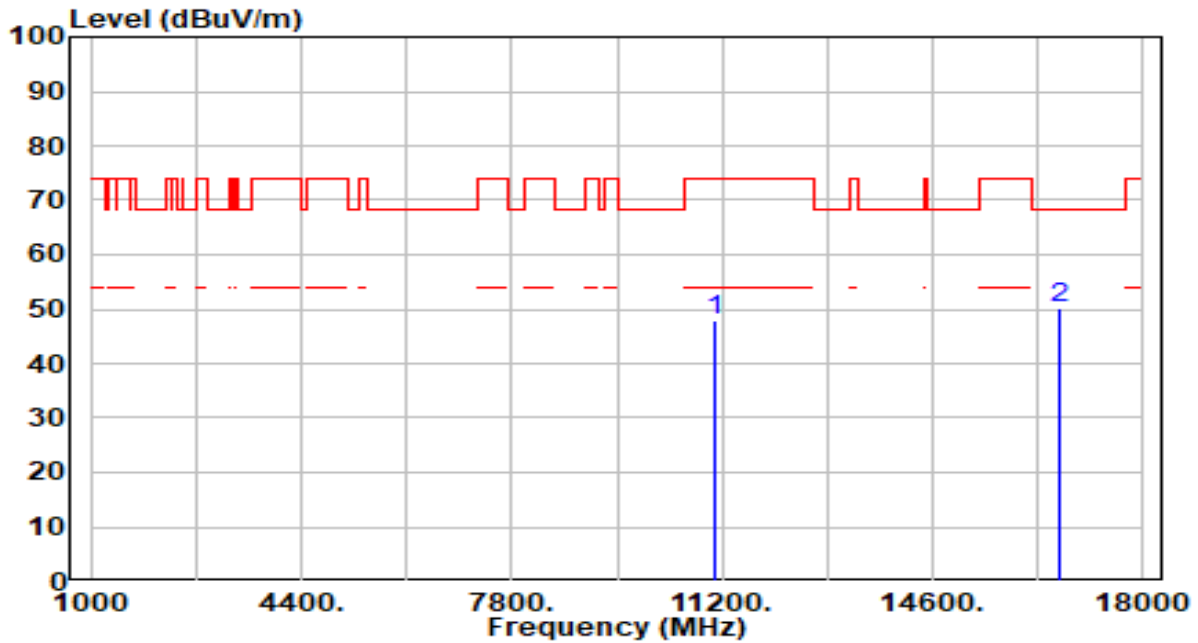

No	Frequency (MHz)	Reading (dBuV)	C.F (dB/m)	Measurement (dBuV/m)	Margin (dB)	Limit (dBuV/m)	Height (cm)	Angle (deg)	Remark (QP/PK/AV)
1	11100.000	43.09	4.78	47.87	-26.13	74.00	100	63	Peak
2	* 16650.000	44.23	6.14	50.36	-17.84	68.20	100	142	Peak

Note:

1. " *", means this data is the worst emission level.
2. C.F (Correction Factor) = Antenna Factor (dB/m)+ Cable Loss (dB) – Pre-amplifier(dB).
3. Measurement (dBuV/m) = Reading(dBuV) + C.F (Correction Factor).
4. The emission levels of other frequencies are very lower than the limit and not show in test report.

EUT	BE3600 Dual-Band Wi-Fi 7 Router	Date of Test	2024-02-06
Factor	DRH18-E	Temp. / Humidity	20°C /65%
Polarity	Horizontal	Site / Test Engineer	AC2 / Marvin
Test Mode	802.11be-40MHz_TX_Band3_CH 134_ANT 0+1	Test Voltage	AC 120V/60Hz

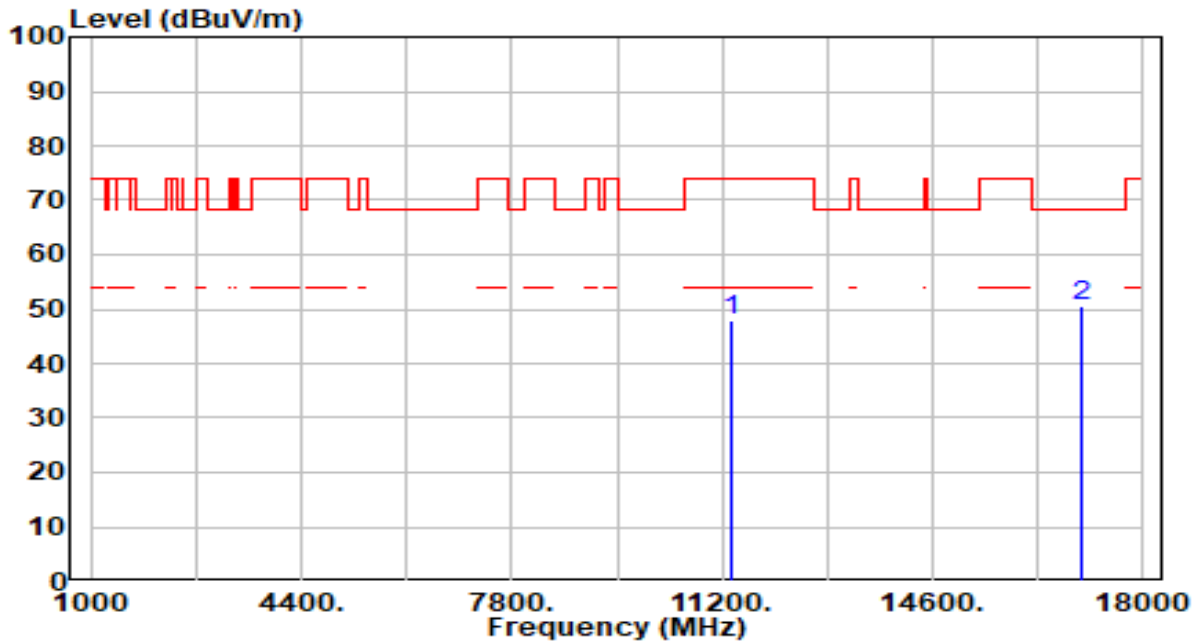

No	Frequency (MHz)	Reading (dBuV)	C.F (dB/m)	Measurement (dBuV/m)	Margin (dB)	Limit (dBuV/m)	Height (cm)	Angle (deg)	Remark (QP/PK/AV)
1	11340.000	42.74	5.20	47.93	-26.07	74.00	100	351	Peak
2	* 17010.000	44.31	6.12	50.44	-17.76	68.20	100	95	Peak

Note:

1. " *", means this data is the worst emission level.
2. C.F (Correction Factor) = Antenna Factor (dB/m)+ Cable Loss (dB) – Pre-amplifier(dB).
3. Measurement (dBuV/m) = Reading(dBuV) + C.F (Correction Factor).
4. The emission levels of other frequencies are very lower than the limit and not show in test report.

EUT	BE3600 Dual-Band Wi-Fi 7 Router	Date of Test	2024-02-06
Factor	DRH18-E	Temp. / Humidity	20°C /65%
Polarity	Vertical	Site / Test Engineer	AC2 / Marvin
Test Mode	802.11be-40MHz_TX_Band3_CH 134_ANT 0+1	Test Voltage	AC 120V/60Hz

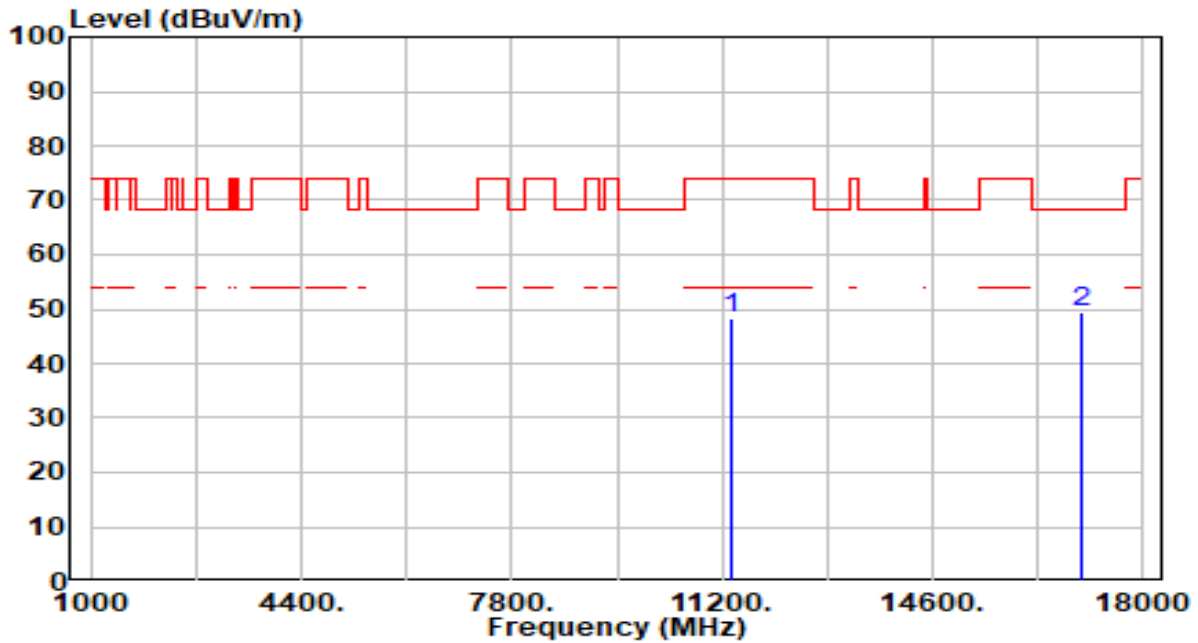

No	Frequency (MHz)	Reading (dBuV)	C.F (dB/m)	Measurement (dBuV/m)	Margin (dB)	Limit (dBuV/m)	Height (cm)	Angle (deg)	Remark (QP/PK/AV)
1	11340.000	43.27	5.20	48.46	-25.54	74.00	100	259	Peak
2	* 17010.000	43.23	6.12	49.35	-18.85	68.20	100	0	Peak

Note:

1. " *", means this data is the worst emission level.
2. C.F (Correction Factor) = Antenna Factor (dB/m)+ Cable Loss (dB) – Pre-amplifier(dB).
3. Measurement (dBuV/m) = Reading(dBuV) + C.F (Correction Factor).
4. The emission levels of other frequencies are very lower than the limit and not show in test report.

EUT	BE3600 Dual-Band Wi-Fi 7 Router	Date of Test	2024-02-06
Factor	DRH18-E	Temp. / Humidity	20°C /65%
Polarity	Horizontal	Site / Test Engineer	AC2 / Marvin
Test Mode	802.11be-40MHz_TX_Band3_CH 142_ANT 0+1	Test Voltage	AC 120V/60Hz

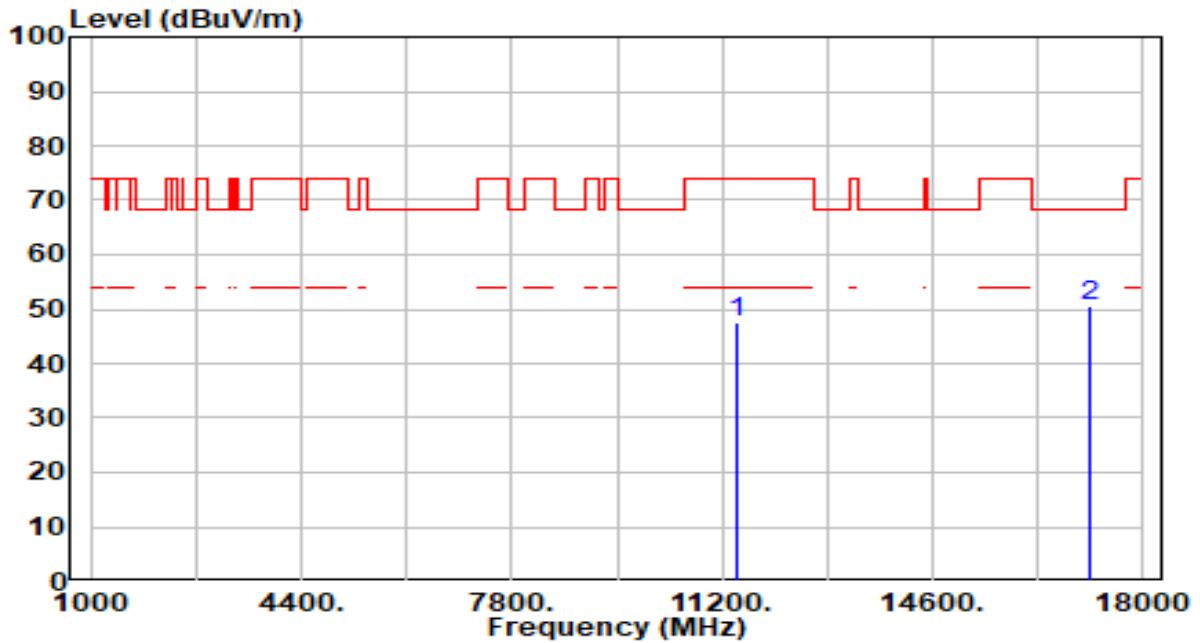

No	Frequency (MHz)	Reading (dBuV)	C.F (dB/m)	Measurement (dBuV/m)	Margin (dB)	Limit (dBuV/m)	Height (cm)	Angle (deg)	Remark (QP/PK/AV)
1	11420.000	42.18	5.28	47.46	-26.54	74.00	100	194	Peak
2	* 17130.000	44.81	5.92	50.73	-17.47	68.20	100	53	Peak

Note:

1. " *", means this data is the worst emission level.
2. C.F (Correction Factor) = Antenna Factor (dB/m)+ Cable Loss (dB) – Pre-amplifier(dB).
3. Measurement (dBuV/m) = Reading(dBuV) + C.F (Correction Factor).
4. The emission levels of other frequencies are very lower than the limit and not show in test report.

EUT	BE3600 Dual-Band Wi-Fi 7 Router	Date of Test	2024-02-06
Factor	DRH18-E	Temp. / Humidity	20°C /65%
Polarity	Vertical	Site / Test Engineer	AC2 / Marvin
Test Mode	802.11be-40MHz_TX_Band3_CH 142_ANT 0+1	Test Voltage	AC 120V/60Hz

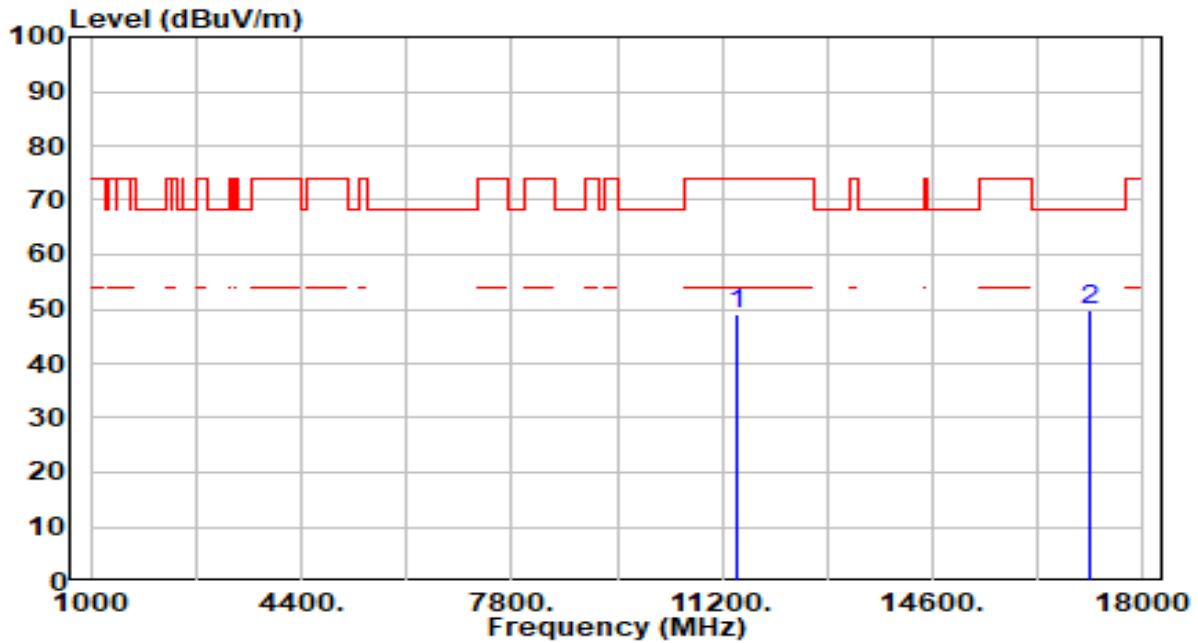

No	Frequency (MHz)	Reading (dBUV)	C.F (dB/m)	Measurement (dBUV/m)	Margin (dB)	Limit (dBUV/m)	Height (cm)	Angle (deg)	Remark (QP/PK/AV)
1	11420.000	43.60	5.28	48.88	-25.12	74.00	100	239	Peak
2	* 17130.000	43.82	5.92	49.74	-18.46	68.20	100	14	Peak

Note:

1. " *", means this data is the worst emission level.
2. C.F (Correction Factor) = Antenna Factor (dB/m)+ Cable Loss (dB) – Pre-amplifier(dB).
3. Measurement (dBUV/m) = Reading(dBUV) + C.F (Correction Factor).
4. The emission levels of other frequencies are very lower than the limit and not show in test report.

EUT	BE3600 Dual-Band Wi-Fi 7 Router	Date of Test	2024-02-06
Factor	DRH18-E	Temp. / Humidity	20°C /65%
Polarity	Horizontal	Site / Test Engineer	AC2 / Marvin
Test Mode	802.11be-40MHz_TX_Band4_CH 151_ANT 0+1	Test Voltage	AC 120V/60Hz

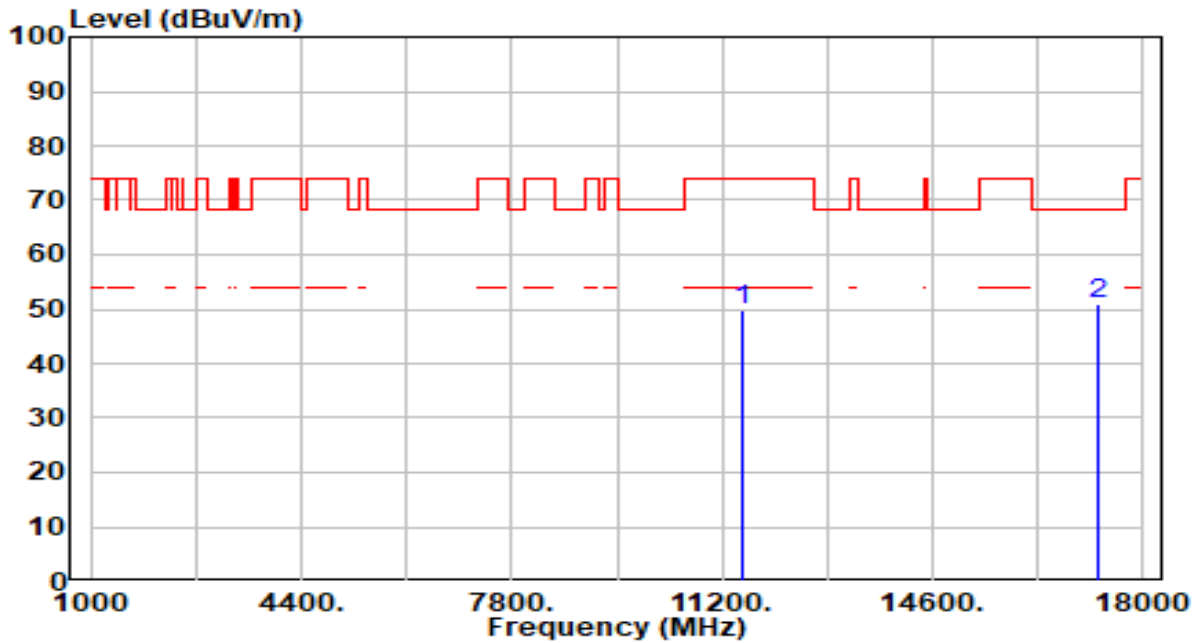

No	Frequency (MHz)	Reading (dBuV)	C.F (dB/m)	Measurement (dBuV/m)	Margin (dB)	Limit (dBuV/m)	Height (cm)	Angle (deg)	Remark (QP/PK/AV)
1	11510.000	44.67	5.33	50.00	-24.00	74.00	100	172	Peak
2	* 17265.000	45.47	5.63	51.10	-17.10	68.20	100	360	Peak

Note:

1. " *", means this data is the worst emission level.
2. C.F (Correction Factor) = Antenna Factor (dB/m)+ Cable Loss (dB) – Pre-amplifier(dB).
3. Measurement (dBuV/m) = Reading(dBuV) + C.F (Correction Factor).
4. The emission levels of other frequencies are very lower than the limit and not show in test report.

EUT	BE3600 Dual-Band Wi-Fi 7 Router	Date of Test	2024-02-06
Factor	DRH18-E	Temp. / Humidity	20°C /65%
Polarity	Vertical	Site / Test Engineer	AC2 / Marvin
Test Mode	802.11be-40MHz_TX_Band4_CH 151_ANT 0+1	Test Voltage	AC 120V/60Hz

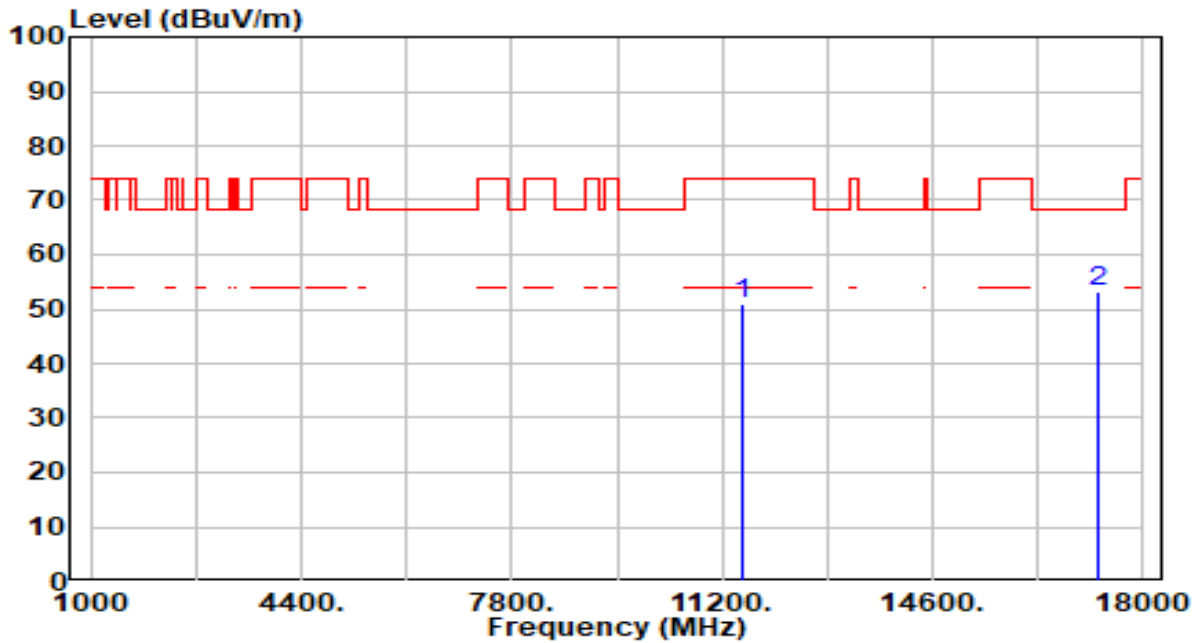

No	Frequency (MHz)	Reading (dBuV)	C.F (dB/m)	Measurement (dBuV/m)	Margin (dB)	Limit (dBuV/m)	Height (cm)	Angle (deg)	Remark (QP/PK/AV)
1	11510.000	45.79	5.33	51.12	-22.88	74.00	100	239	Peak
2	* 17265.000	47.76	5.63	53.39	-14.81	68.20	100	256	Peak

Note:

1. " *", means this data is the worst emission level.
2. C.F (Correction Factor) = Antenna Factor (dB/m)+ Cable Loss (dB) – Pre-amplifier(dB).
3. Measurement (dBuV/m) = Reading(dBuV) + C.F (Correction Factor).
4. The emission levels of other frequencies are very lower than the limit and not show in test report.

EUT	BE3600 Dual-Band Wi-Fi 7 Router	Date of Test	2024-02-06
Factor	DRH18-E	Temp. / Humidity	20°C /65%
Polarity	Horizontal	Site / Test Engineer	AC2 / Marvin
Test Mode	802.11be-40MHz_TX_Band4_CH 159_ANT 0+1	Test Voltage	AC 120V/60Hz

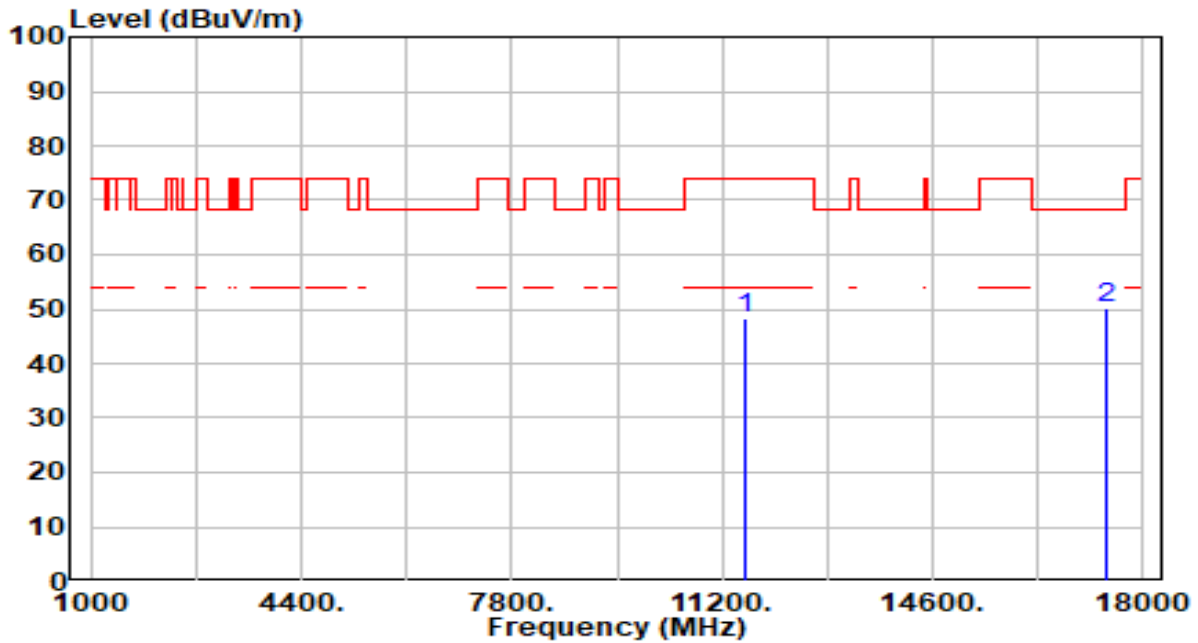

No	Frequency (MHz)	Reading (dBuV)	C.F (dB/m)	Measurement (dBuV/m)	Margin (dB)	Limit (dBuV/m)	Height (cm)	Angle (deg)	Remark (QP/PK/AV)
1	11590.000	43.01	5.39	48.40	-25.60	74.00	100	229	Peak
2	* 17385.000	44.88	5.31	50.18	-18.02	68.20	100	53	Peak

Note:

1. " *", means this data is the worst emission level.
2. C.F (Correction Factor) = Antenna Factor (dB/m)+ Cable Loss (dB) – Pre-amplifier(dB).
3. Measurement (dBuV/m) = Reading(dBuV) + C.F (Correction Factor).
4. The emission levels of other frequencies are very lower than the limit and not show in test report.

EUT	BE3600 Dual-Band Wi-Fi 7 Router	Date of Test	2024-02-06
Factor	DRH18-E	Temp. / Humidity	20°C /65%
Polarity	Vertical	Site / Test Engineer	AC2 / Marvin
Test Mode	802.11be-40MHz_TX_Band4_CH 159_ANT 0+1	Test Voltage	AC 120V/60Hz

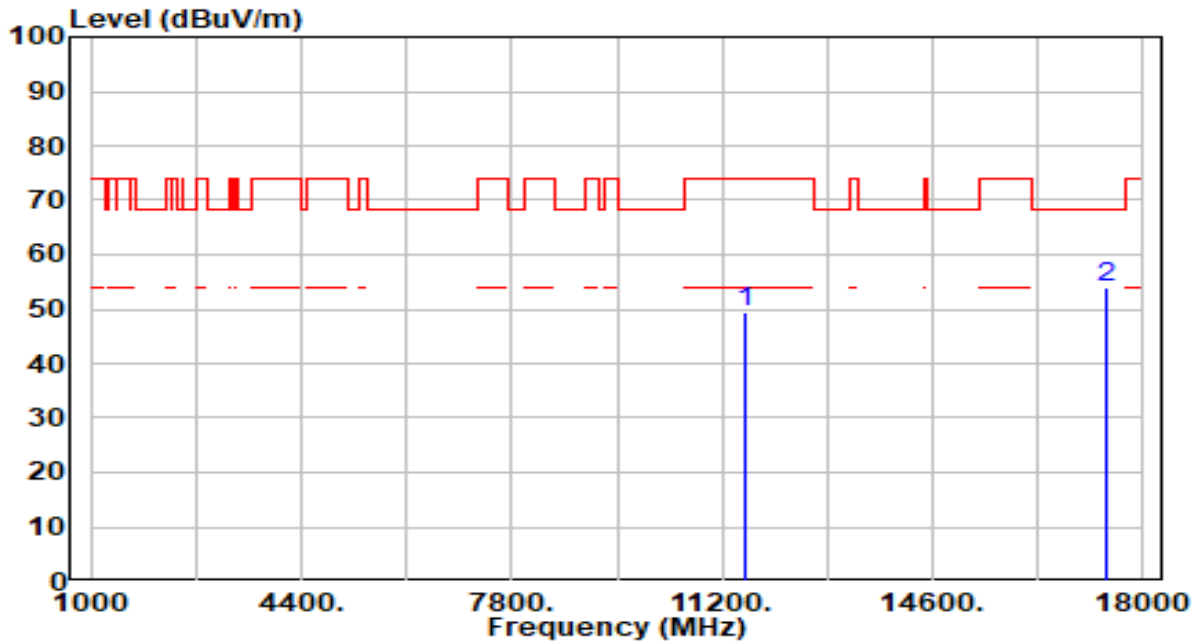

No	Frequency (MHz)	Reading (dBuV)	C.F (dB/m)	Measurement (dBuV/m)	Margin (dB)	Limit (dBuV/m)	Height (cm)	Angle (deg)	Remark (QP/PK/AV)
1	11590.000	44.20	5.39	49.59	-24.41	74.00	100	244	Peak
2	* 17385.000	48.52	5.31	53.83	-14.37	68.20	100	258	Peak

Note:

1. " *", means this data is the worst emission level.
2. C.F (Correction Factor) = Antenna Factor (dB/m)+ Cable Loss (dB) – Pre-amplifier(dB).
3. Measurement (dBuV/m) = Reading(dBuV) + C.F (Correction Factor).
4. The emission levels of other frequencies are very lower than the limit and not show in test report.

EUT	BE3600 Dual-Band Wi-Fi 7 Router	Date of Test	2024-02-06
Factor	DRH18-E	Temp. / Humidity	20°C /65%
Polarity	Horizontal	Site / Test Engineer	AC2 / Marvin
Test Mode	802.11be-80MHz_TX_Band1_CH 42_ANT 0+1	Test Voltage	AC 120V/60Hz

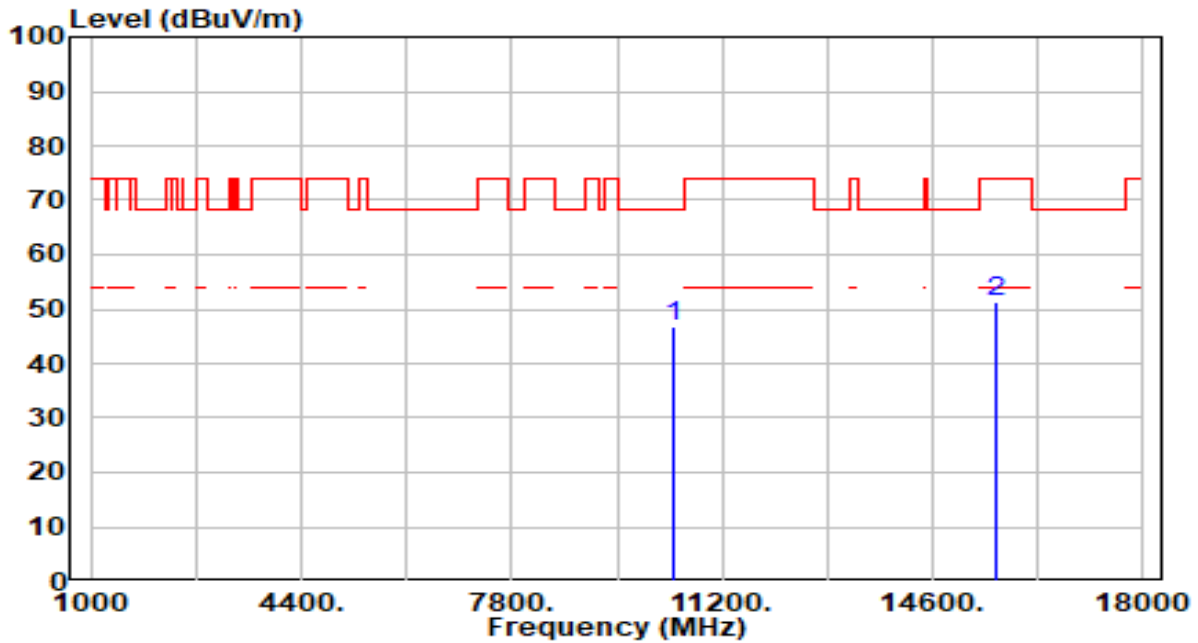

No	Frequency (MHz)	Reading (dBuV)	C.F (dB/m)	Measurement (dBuV/m)	Margin (dB)	Limit (dBuV/m)	Height (cm)	Angle (deg)	Remark (QP/PK/AV)
1	* 10420.000	42.19	4.79	46.98	-21.22	68.20	100	107	Peak
2	15630.000	44.99	6.21	51.20	-22.80	74.00	100	238	Peak

Note:

1. " *", means this data is the worst emission level.
2. C.F (Correction Factor) = Antenna Factor (dB/m)+ Cable Loss (dB) – Pre-amplifier(dB).
3. Measurement (dBuV/m) = Reading(dBuV) + C.F (Correction Factor).
4. The emission levels of other frequencies are very lower than the limit and not show in test report.

EUT	BE3600 Dual-Band Wi-Fi 7 Router	Date of Test	2024-02-06
Factor	DRH18-E	Temp. / Humidity	20°C /65%
Polarity	Vertical	Site / Test Engineer	AC2 / Marvin
Test Mode	802.11be-80MHz_TX_Band1_CH 42_ANT 0+1	Test Voltage	AC 120V/60Hz

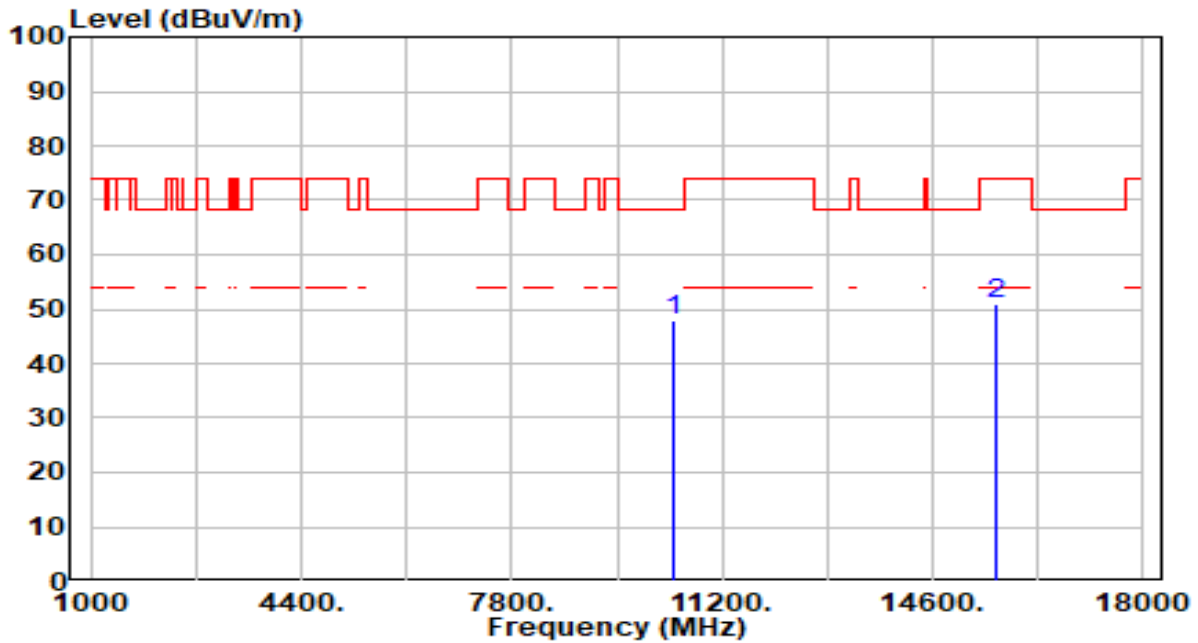

No	Frequency (MHz)	Reading (dBuV)	C.F (dB/m)	Measurement (dBuV/m)	Margin (dB)	Limit (dBuV/m)	Height (cm)	Angle (deg)	Remark (QP/PK/AV)
1	* 10420.000	43.18	4.79	47.98	-20.22	68.20	100	26	Peak
2	15630.000	44.59	6.21	50.79	-23.21	74.00	100	131	Peak

Note:

- "*", means this data is the worst emission level.
- C.F (Correction Factor) = Antenna Factor (dB/m)+ Cable Loss (dB) – Pre-amplifier(dB).
- Measurement (dBuV/m) = Reading(dBuV) + C.F (Correction Factor).
- The emission levels of other frequencies are very lower than the limit and not show in test report.

EUT	BE3600 Dual-Band Wi-Fi 7 Router	Date of Test	2024-02-06
Factor	DRH18-E	Temp. / Humidity	20°C /65%
Polarity	Horizontal	Site / Test Engineer	AC2 / Marvin
Test Mode	802.11be-80MHz_TX_Band2_CH 58_ANT 0+1	Test Voltage	AC 120V/60Hz

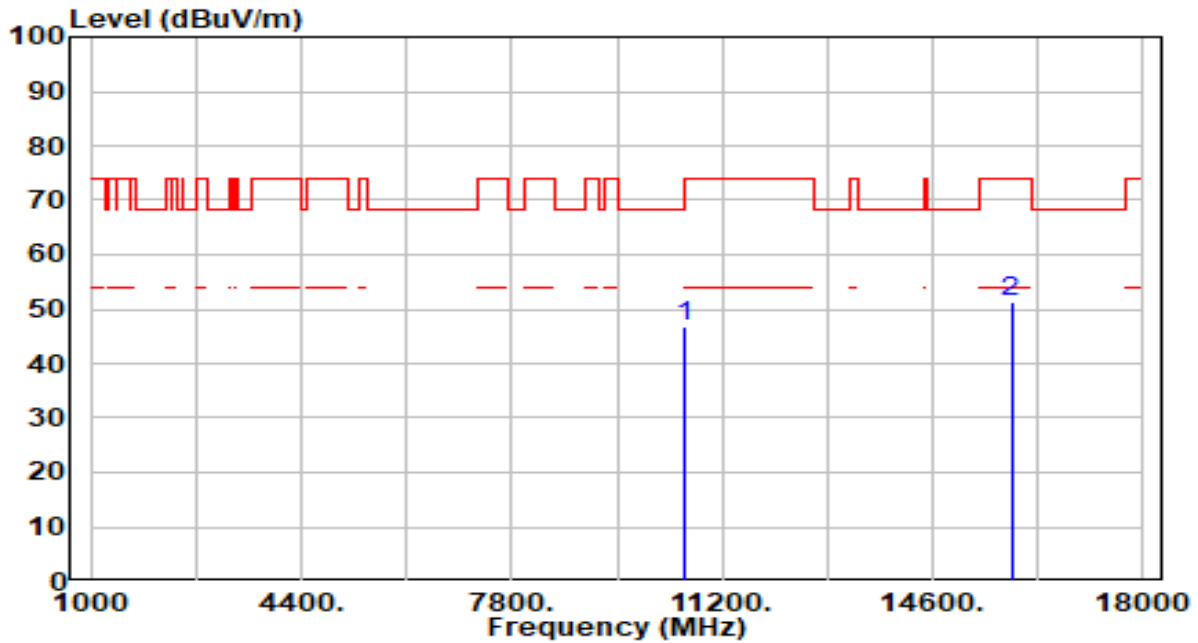

No	Frequency (MHz)	Reading (dBuV)	C.F (dB/m)	Measurement (dBuV/m)	Margin (dB)	Limit (dBuV/m)	Height (cm)	Angle (deg)	Remark (QP/PK/AV)
1	* 10580.000	42.24	4.63	46.87	-21.33	68.20	100	0	Peak
2	15870.000	44.92	6.55	51.46	-22.54	74.00	100	310	Peak

Note:

1. " *", means this data is the worst emission level.
2. C.F (Correction Factor) = Antenna Factor (dB/m)+ Cable Loss (dB) – Pre-amplifier(dB).
3. Measurement (dBuV/m) = Reading(dBuV) + C.F (Correction Factor).
4. The emission levels of other frequencies are very lower than the limit and not show in test report.

EUT	BE3600 Dual-Band Wi-Fi 7 Router	Date of Test	2024-02-06
Factor	DRH18-E	Temp. / Humidity	20°C /65%
Polarity	Vertical	Site / Test Engineer	AC2 / Marvin
Test Mode	802.11be-80MHz_TX_Band2_CH 58_ANT 0+1	Test Voltage	AC 120V/60Hz

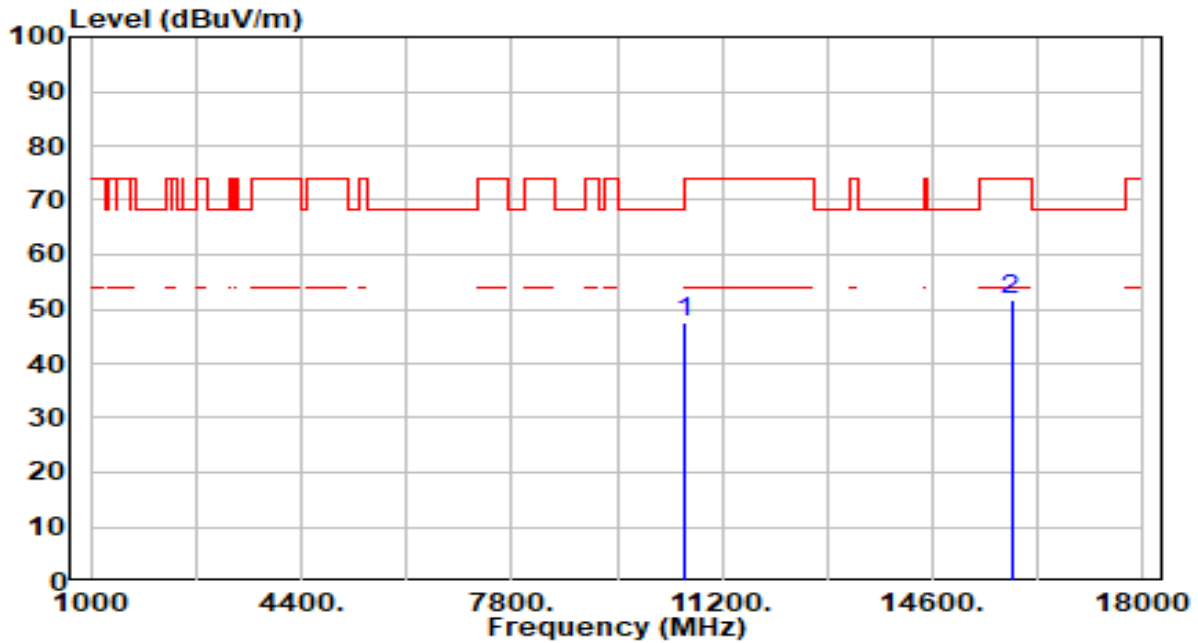

No	Frequency (MHz)	Reading (dBuV)	C.F (dB/m)	Measurement (dBuV/m)	Margin (dB)	Limit (dBuV/m)	Height (cm)	Angle (deg)	Remark (QP/PK/AV)
1	* 10580.000	42.80	4.63	47.42	-20.78	68.20	100	142	Peak
2	15870.000	44.98	6.55	51.53	-22.47	74.00	100	142	Peak

Note:

1. " *", means this data is the worst emission level.
2. C.F (Correction Factor) = Antenna Factor (dB/m)+ Cable Loss (dB) – Pre-amplifier(dB).
3. Measurement (dBuV/m) = Reading(dBuV) + C.F (Correction Factor).
4. The emission levels of other frequencies are very lower than the limit and not show in test report.

EUT	BE3600 Dual-Band Wi-Fi 7 Router	Date of Test	2024-02-06
Factor	DRH18-E	Temp. / Humidity	20°C /65%
Polarity	Horizontal	Site / Test Engineer	AC2 / Marvin
Test Mode	802.11be-80MHz_TX_Band3_CH 106_ANT 0+1	Test Voltage	AC 120V/60Hz

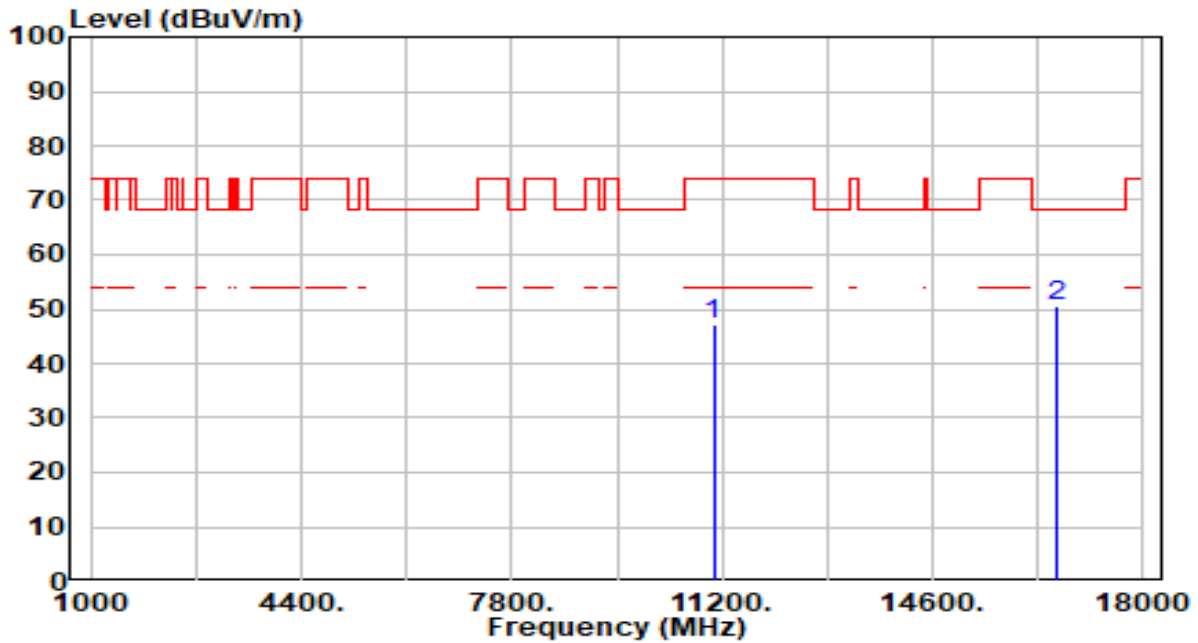

No	Frequency (MHz)	Reading (dBuV)	C.F (dB/m)	Measurement (dBuV/m)	Margin (dB)	Limit (dBuV/m)	Height (cm)	Angle (deg)	Remark (QP/PK/AV)
1	11060.000	42.65	4.68	47.33	-26.67	74.00	100	87	Peak
2	* 16590.000	44.51	6.11	50.61	-17.59	68.20	100	50	Peak

Note:

1. " *", means this data is the worst emission level.
2. C.F (Correction Factor) = Antenna Factor (dB/m)+ Cable Loss (dB) – Pre-amplifier(dB).
3. Measurement (dBuV/m) = Reading(dBuV) + C.F (Correction Factor).
4. The emission levels of other frequencies are very lower than the limit and not show in test report.

EUT	BE3600 Dual-Band Wi-Fi 7 Router	Date of Test	2024-02-06
Factor	DRH18-E	Temp. / Humidity	20°C /65%
Polarity	Vertical	Site / Test Engineer	AC2 / Marvin
Test Mode	802.11be-80MHz_TX_Band3_CH 106_ANT 0+1	Test Voltage	AC 120V/60Hz

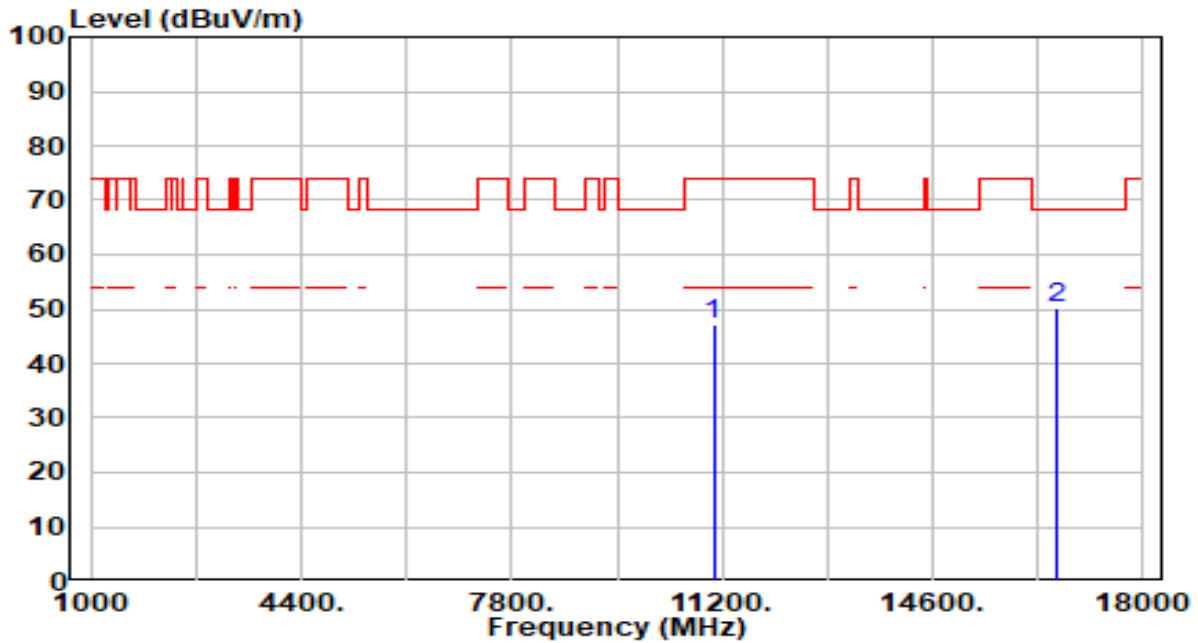

No	Frequency (MHz)	Reading (dBuV)	C.F (dB/m)	Measurement (dBuV/m)	Margin (dB)	Limit (dBuV/m)	Height (cm)	Angle (deg)	Remark (QP/PK/AV)
1	11060.000	42.51	4.68	47.19	-26.81	74.00	100	285	Peak
2	* 16590.000	44.18	6.11	50.28	-17.92	68.20	100	262	Peak

Note:

1. " *", means this data is the worst emission level.
2. C.F (Correction Factor) = Antenna Factor (dB/m)+ Cable Loss (dB) – Pre-amplifier(dB).
3. Measurement (dBuV/m) = Reading(dBuV) + C.F (Correction Factor).
4. The emission levels of other frequencies are very lower than the limit and not show in test report.

EUT	BE3600 Dual-Band Wi-Fi 7 Router	Date of Test	2024-02-06
Factor	DRH18-E	Temp. / Humidity	20°C /65%
Polarity	Horizontal	Site / Test Engineer	AC2 / Marvin
Test Mode	802.11be-80MHz_TX_Band3_CH 122_ANT 0+1	Test Voltage	AC 120V/60Hz

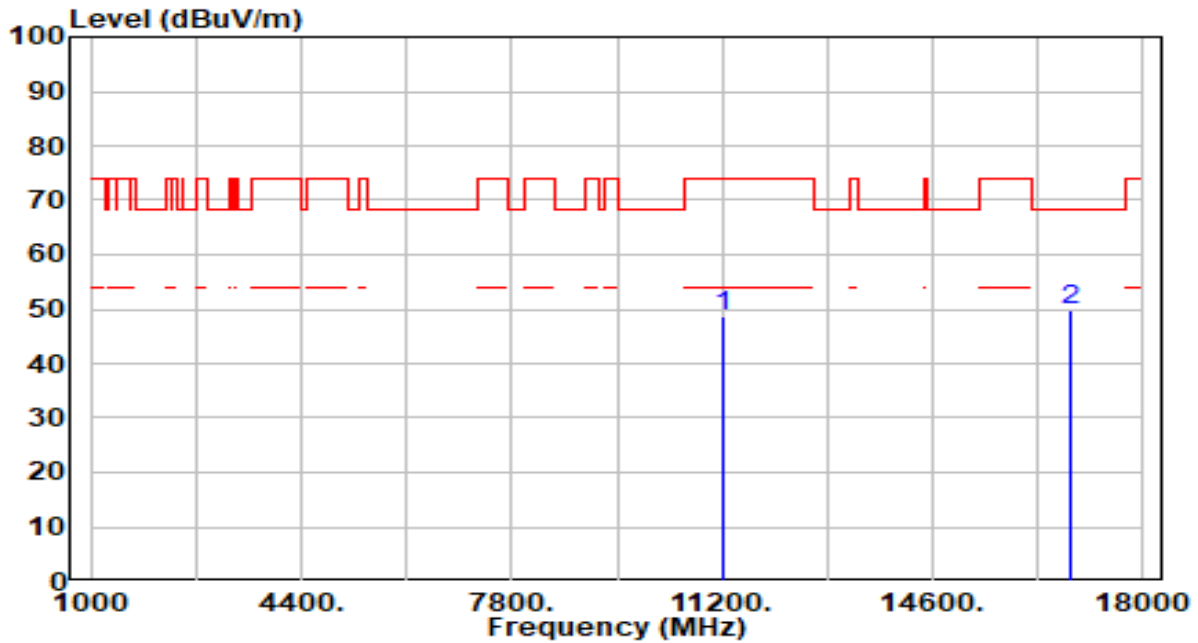

No	Frequency (MHz)	Reading (dBUV)	C.F (dB/m)	Measurement (dBUV/m)	Margin (dB)	Limit (dBUV/m)	Height (cm)	Angle (deg)	Remark (QP/PK/AV)
1	11220.000	43.47	5.06	48.54	-25.46	74.00	100	246	Peak
2	* 16830.000	43.65	6.21	49.86	-18.34	68.20	100	341	Peak

Note:

- "*", means this data is the worst emission level.
- C.F (Correction Factor) = Antenna Factor (dB/m)+ Cable Loss (dB) – Pre-amplifier(dB).
- Measurement (dBUV/m) = Reading(dBUV) + C.F (Correction Factor).
- The emission levels of other frequencies are very lower than the limit and not show in test report.

EUT	BE3600 Dual-Band Wi-Fi 7 Router	Date of Test	2024-02-06
Factor	DRH18-E	Temp. / Humidity	20°C /65%
Polarity	Vertical	Site / Test Engineer	AC2 / Marvin
Test Mode	802.11be-80MHz_TX_Band3_CH 122_ANT 0+1	Test Voltage	AC 120V/60Hz

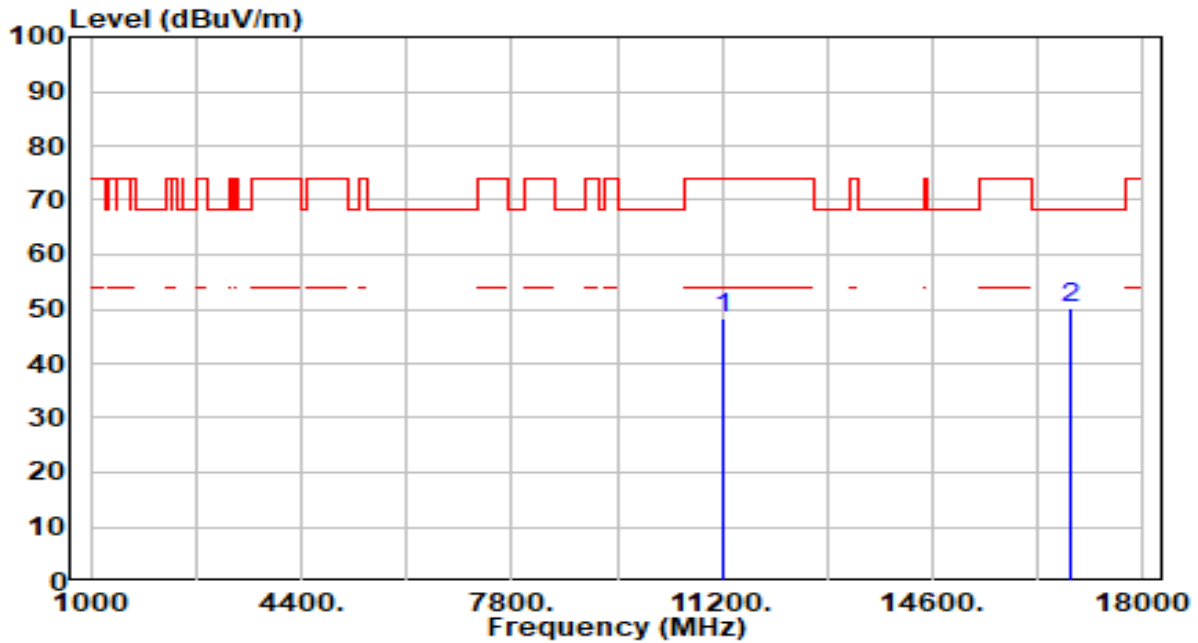

No	Frequency (MHz)	Reading (dBuV)	C.F (dB/m)	Measurement (dBuV/m)	Margin (dB)	Limit (dBuV/m)	Height (cm)	Angle (deg)	Remark (QP/PK/AV)
1	11220.000	43.24	5.06	48.30	-25.70	74.00	100	170	Peak
2	* 16830.000	44.00	6.21	50.21	-17.99	68.20	100	323	Peak

Note:

1. " *", means this data is the worst emission level.
2. C.F (Correction Factor) = Antenna Factor (dB/m)+ Cable Loss (dB) – Pre-amplifier(dB).
3. Measurement (dBuV/m) = Reading(dBuV) + C.F (Correction Factor).
4. The emission levels of other frequencies are very lower than the limit and not show in test report.

EUT	BE3600 Dual-Band Wi-Fi 7 Router	Date of Test	2024-02-06
Factor	DRH18-E	Temp. / Humidity	20°C /65%
Polarity	Horizontal	Site / Test Engineer	AC2 / Marvin
Test Mode	802.11be-80MHz_TX_Band3_CH 138_ANT 0+1	Test Voltage	AC 120V/60Hz

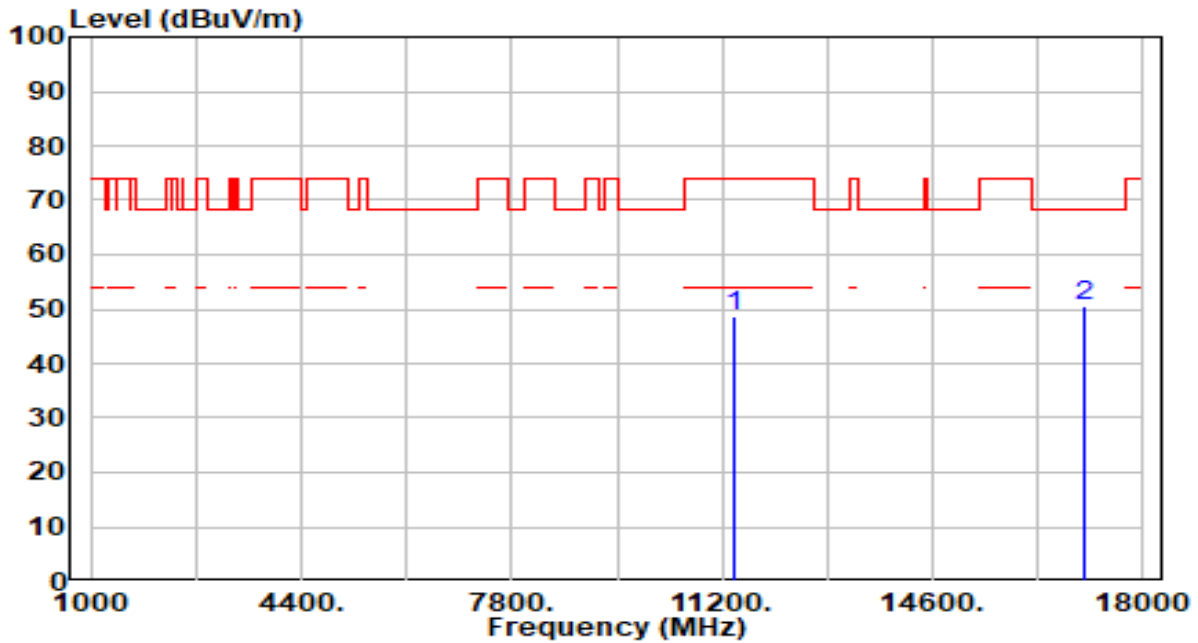

No	Frequency (MHz)	Reading (dBuV)	C.F (dB/m)	Measurement (dBuV/m)	Margin (dB)	Limit (dBuV/m)	Height (cm)	Angle (deg)	Remark (QP/PK/AV)
1	11380.000	43.42	5.24	48.66	-25.34	74.00	100	84	Peak
2	* 17070.000	44.40	6.02	50.42	-17.78	68.20	100	318	Peak

Note:

1. " *", means this data is the worst emission level.
2. C.F (Correction Factor) = Antenna Factor (dB/m)+ Cable Loss (dB) – Pre-amplifier(dB).
3. Measurement (dBuV/m) = Reading(dBuV) + C.F (Correction Factor).
4. The emission levels of other frequencies are very lower than the limit and not show in test report.

EUT	BE3600 Dual-Band Wi-Fi 7 Router	Date of Test	2024-02-06
Factor	DRH18-E	Temp. / Humidity	20°C /65%
Polarity	Vertical	Site / Test Engineer	AC2 / Marvin
Test Mode	802.11be-80MHz_TX_Band3_CH 138_ANT 0+1	Test Voltage	AC 120V/60Hz

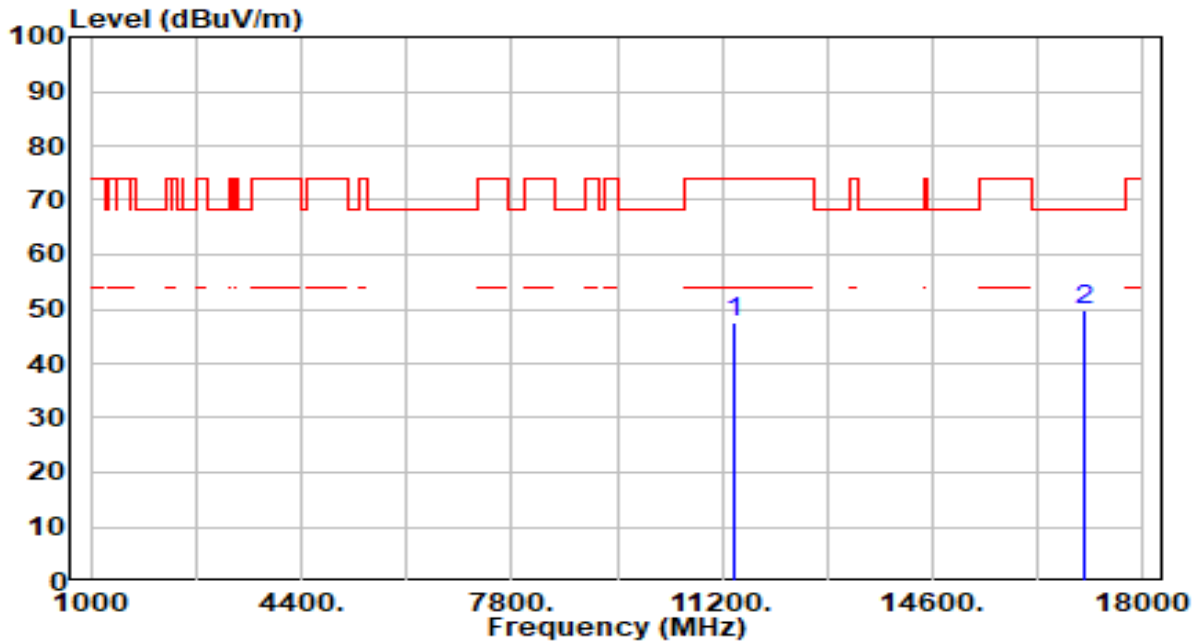

No	Frequency (MHz)	Reading (dBuV)	C.F (dB/m)	Measurement (dBuV/m)	Margin (dB)	Limit (dBuV/m)	Height (cm)	Angle (deg)	Remark (QP/PK/AV)
1	11380.000	42.12	5.24	47.36	-26.64	74.00	100	360	Peak
2	* 17070.000	43.83	6.02	49.85	-18.35	68.20	100	60	Peak

Note:

- "*", means this data is the worst emission level.
- C.F (Correction Factor) = Antenna Factor (dB/m)+ Cable Loss (dB) – Pre-amplifier(dB).
- Measurement (dBuV/m) = Reading(dBuV) + C.F (Correction Factor).
- The emission levels of other frequencies are very lower than the limit and not show in test report.

EUT	BE3600 Dual-Band Wi-Fi 7 Router	Date of Test	2024-02-06
Factor	DRH18-E	Temp. / Humidity	20°C /65%
Polarity	Horizontal	Site / Test Engineer	AC2 / Marvin
Test Mode	802.11be-80MHz_TX_Band4_CH 155_ANT 0+1	Test Voltage	AC 120V/60Hz

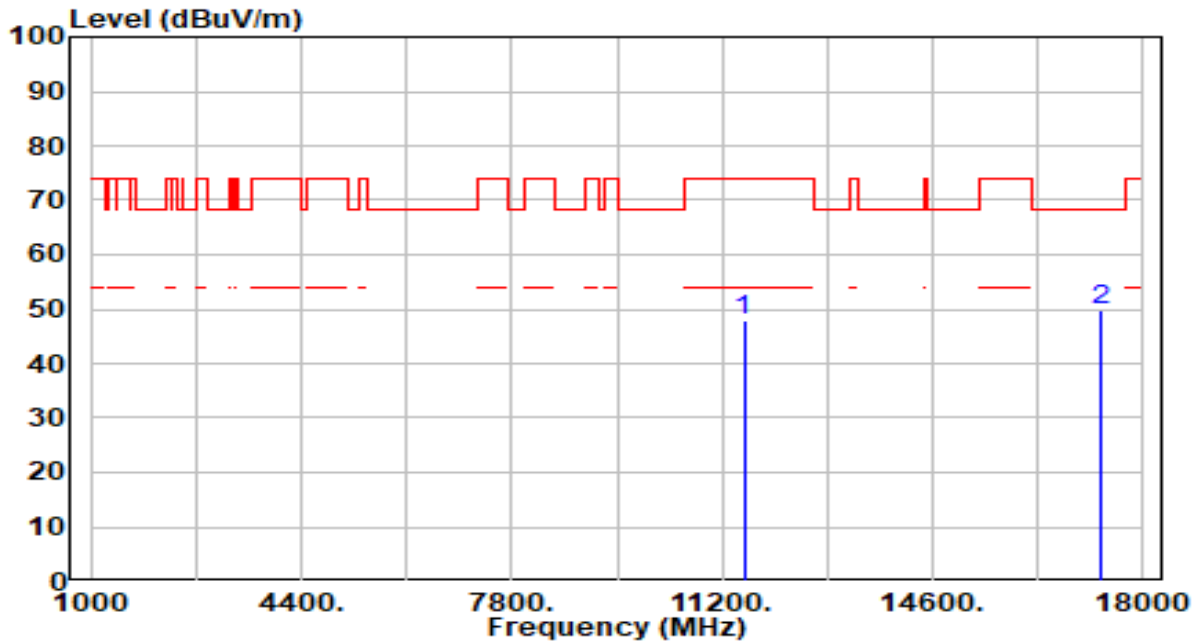

No	Frequency (MHz)	Reading (dBuV)	C.F (dB/m)	Measurement (dBuV/m)	Margin (dB)	Limit (dBuV/m)	Height (cm)	Angle (deg)	Remark (QP/PK/AV)
1	11550.000	42.42	5.36	47.78	-26.22	74.00	100	350	Peak
2	* 17325.000	44.29	5.47	49.76	-18.44	68.20	100	124	Peak

Note:

1. " *", means this data is the worst emission level.
2. C.F (Correction Factor) = Antenna Factor (dB/m)+ Cable Loss (dB) – Pre-amplifier(dB).
3. Measurement (dBuV/m) = Reading(dBuV) + C.F (Correction Factor).
4. The emission levels of other frequencies are very lower than the limit and not show in test report.

EUT	BE3600 Dual-Band Wi-Fi 7 Router	Date of Test	2024-02-06
Factor	DRH18-E	Temp. / Humidity	20°C /65%
Polarity	Vertical	Site / Test Engineer	AC2 / Marvin
Test Mode	802.11be-80MHz_TX_Band4_CH 155_ANT 0+1	Test Voltage	AC 120V/60Hz

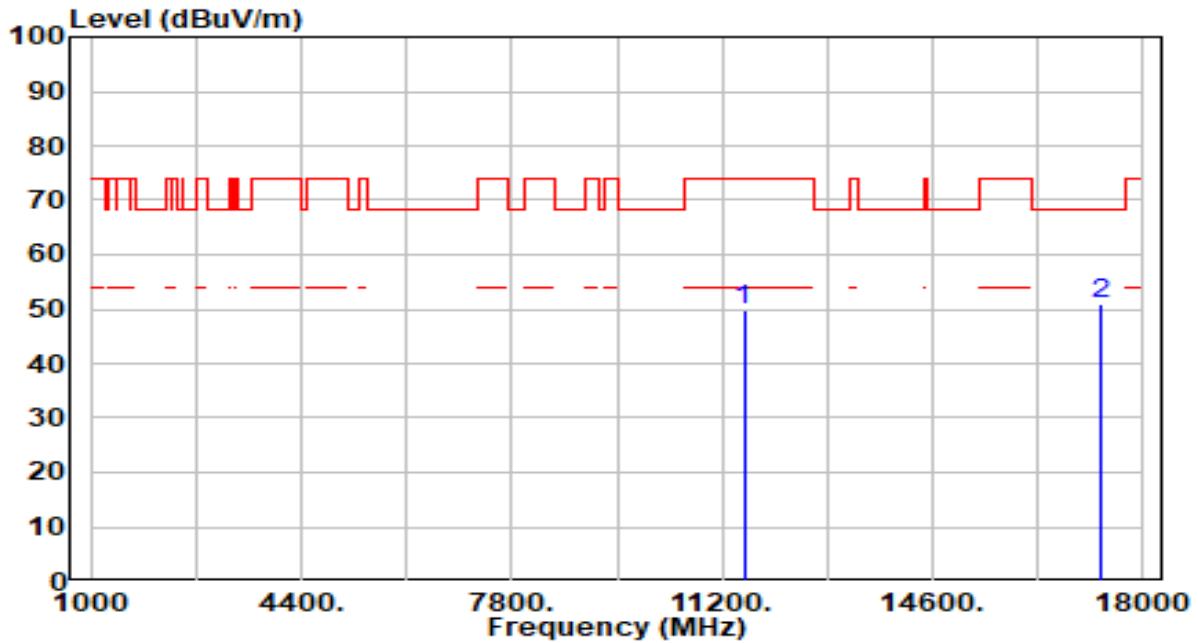

No	Frequency (MHz)	Reading (dBuV)	C.F (dB/m)	Measurement (dBuV/m)	Margin (dB)	Limit (dBuV/m)	Height (cm)	Angle (deg)	Remark (QP/PK/AV)
1	11550.000	44.45	5.36	49.81	-24.19	74.00	100	191	Peak
2	* 17325.000	45.34	5.47	50.81	-17.39	68.20	100	214	Peak

Note:

1. " *", means this data is the worst emission level.
2. C.F (Correction Factor) = Antenna Factor (dB/m)+ Cable Loss (dB) – Pre-amplifier(dB).
3. Measurement (dBuV/m) = Reading(dBuV) + C.F (Correction Factor).
4. The emission levels of other frequencies are very lower than the limit and not show in test report.

EUT	BE3600 Dual-Band Wi-Fi 7 Router	Date of Test	2024-02-06
Factor	DRH18-E	Temp. / Humidity	20°C /65%
Polarity	Horizontal	Site / Test Engineer	AC2 / Marvin
Test Mode	802.11be-160MHz_TX_Band1,2_CH 50_ANT 0+1	Test Voltage	AC 120V/60Hz

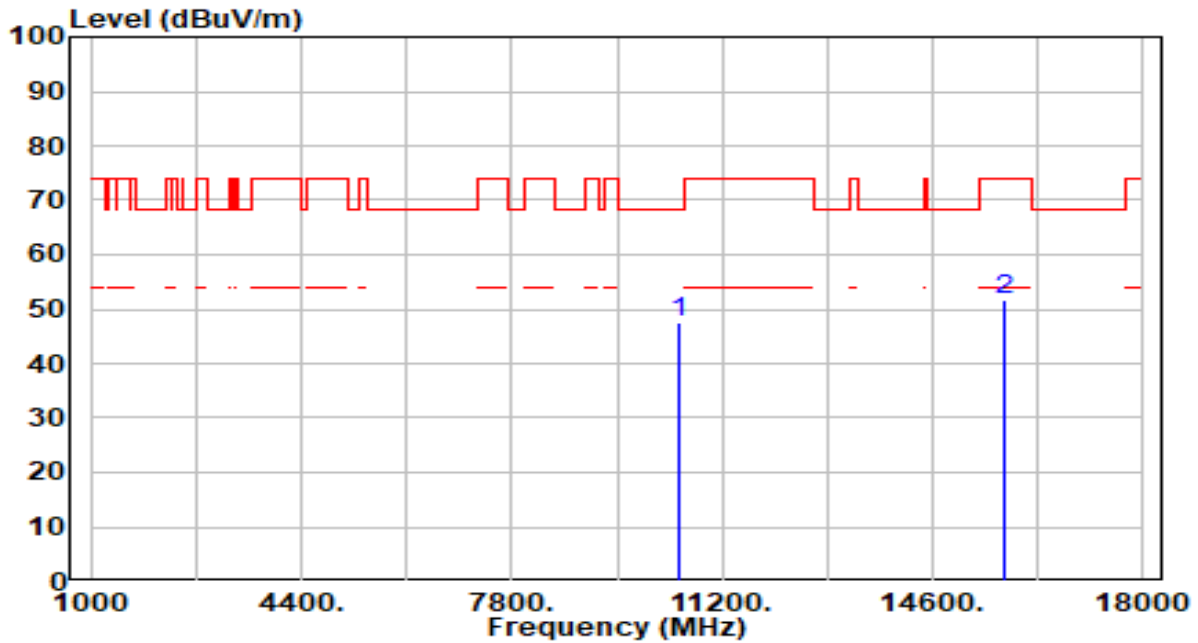

No	Frequency (MHz)	Reading (dBuV)	C.F (dB/m)	Measurement (dBuV/m)	Margin (dB)	Limit (dBuV/m)	Height (cm)	Angle (deg)	Remark (QP/PK/AV)
1	* 10500.000	42.72	4.68	47.41	-20.79	68.20	100	204	Peak
2	15750.000	45.08	6.45	51.53	-22.47	74.00	100	328	Peak

Note:

1. " *", means this data is the worst emission level.
2. C.F (Correction Factor) = Antenna Factor (dB/m)+ Cable Loss (dB) – Pre-amplifier(dB).
3. Measurement (dBuV/m) = Reading(dBuV) + C.F (Correction Factor).
4. The emission levels of other frequencies are very lower than the limit and not show in test report.

EUT	BE3600 Dual-Band Wi-Fi 7 Router	Date of Test	2024-02-06
Factor	DRH18-E	Temp. / Humidity	20°C /65%
Polarity	Vertical	Site / Test Engineer	AC2 / Marvin
Test Mode	802.11be-160MHz_TX_Band1,2_CH 50_ANT 0+1	Test Voltage	AC 120V/60Hz

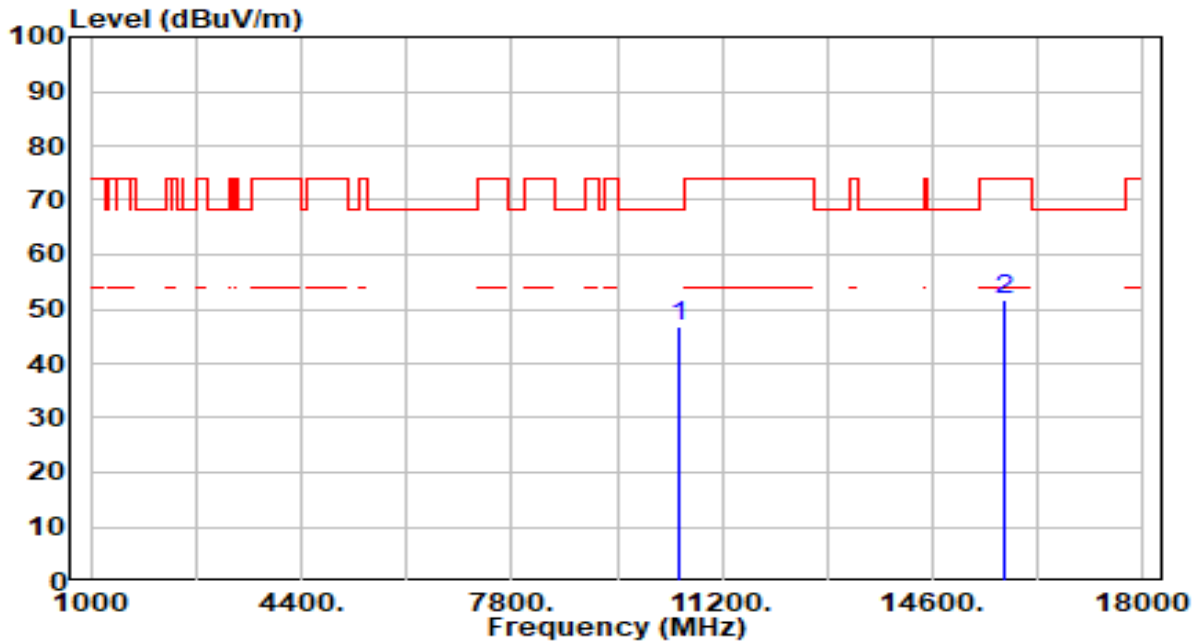

No	Frequency (MHz)	Reading (dBuV)	C.F (dB/m)	Measurement (dBuV/m)	Margin (dB)	Limit (dBuV/m)	Height (cm)	Angle (deg)	Remark (QP/PK/AV)
1	* 10500.000	41.97	4.68	46.65	-21.55	68.20	100	193	Peak
2	15750.000	45.11	6.45	51.55	-22.45	74.00	100	287	Peak

Note:

1. " *", means this data is the worst emission level.
2. C.F (Correction Factor) = Antenna Factor (dB/m)+ Cable Loss (dB) – Pre-amplifier(dB).
3. Measurement (dBuV/m) = Reading(dBuV) + C.F (Correction Factor).
4. The emission levels of other frequencies are very lower than the limit and not show in test report.

EUT	BE3600 Dual-Band Wi-Fi 7 Router	Date of Test	2024-02-06
Factor	DRH18-E	Temp. / Humidity	20°C /65%
Polarity	Horizontal	Site / Test Engineer	AC2 / Marvin
Test Mode	802.11be-160MHz_TX_Band3_CH 114_ANT 0+1	Test Voltage	AC 120V/60Hz

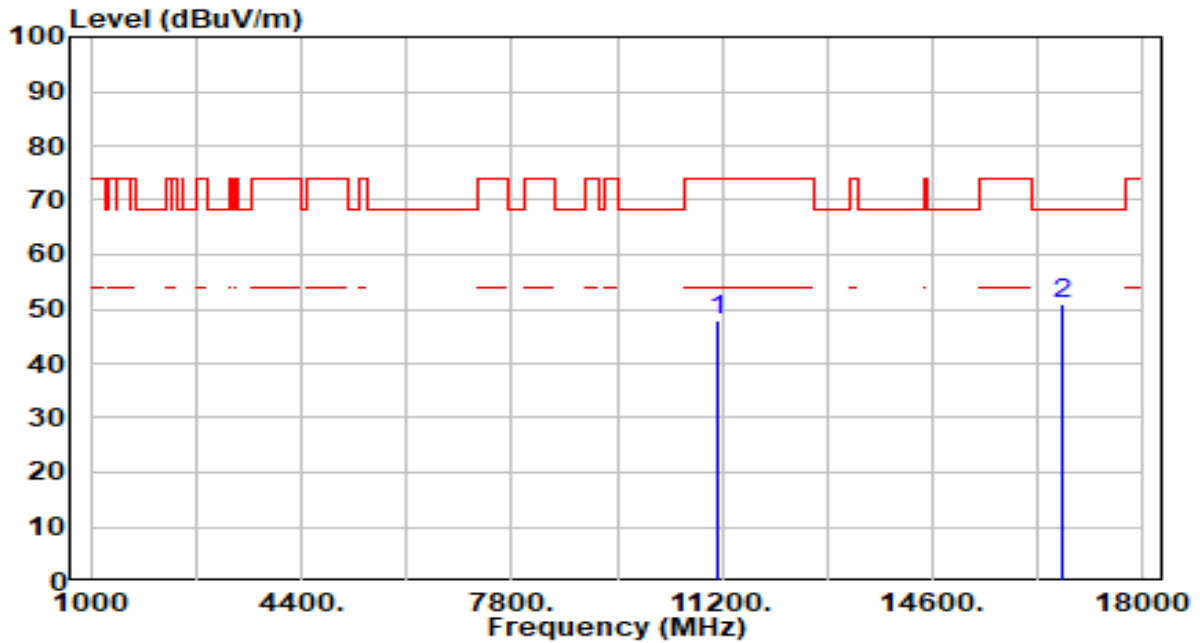

No	Frequency (MHz)	Reading (dBuV)	C.F (dB/m)	Measurement (dBuV/m)	Margin (dB)	Limit (dBuV/m)	Height (cm)	Angle (deg)	Remark (QP/PK/AV)
1	11140.000	42.88	4.89	47.76	-26.24	74.00	100	189	Peak
2	* 16710.000	44.68	6.17	50.86	-17.34	68.20	100	114	Peak

Note:

1. " *", means this data is the worst emission level.
2. C.F (Correction Factor) = Antenna Factor (dB/m)+ Cable Loss (dB) – Pre-amplifier(dB).
3. Measurement (dBuV/m) = Reading(dBuV) + C.F (Correction Factor).
4. The emission levels of other frequencies are very lower than the limit and not show in test report.

EUT	BE3600 Dual-Band Wi-Fi 7 Router	Date of Test	2024-02-06
Factor	DRH18-E	Temp. / Humidity	20°C /65%
Polarity	Vertical	Site / Test Engineer	AC2 / Marvin
Test Mode	802.11be-160MHz_TX_Band3_CH 114_ANT 0+1	Test Voltage	AC 120V/60Hz

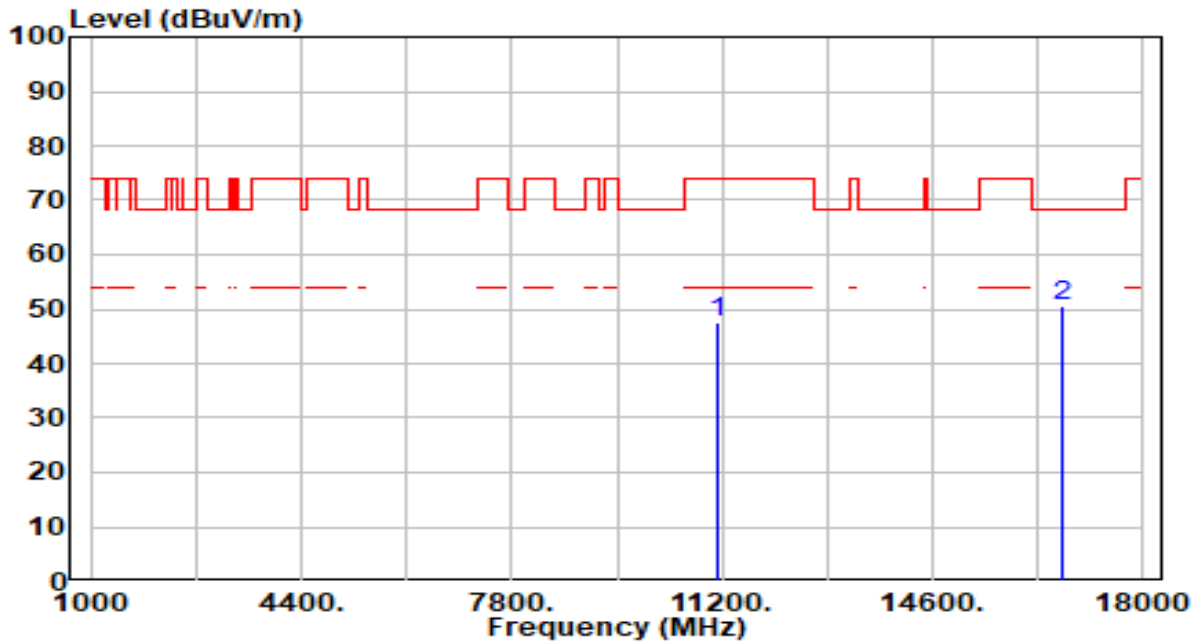

No	Frequency (MHz)	Reading (dBuV)	C.F (dB/m)	Measurement (dBuV/m)	Margin (dB)	Limit (dBuV/m)	Height (cm)	Angle (deg)	Remark (QP/PK/AV)
1	11140.000	42.83	4.89	47.72	-26.28	74.00	100	131	Peak
2	* 16710.000	44.42	6.17	50.59	-17.61	68.20	100	328	Peak

Note:

1. " *", means this data is the worst emission level.
2. C.F (Correction Factor) = Antenna Factor (dB/m)+ Cable Loss (dB) – Pre-amplifier(dB).
3. Measurement (dBuV/m) = Reading(dBuV) + C.F (Correction Factor).
4. The emission levels of other frequencies are very lower than the limit and not show in test report.

EUT	BE3600 Dual-Band Wi-Fi 7 Router	Date of Test	2024-02-22
Factor	BBHA 9170	Temp. / Humidity	20°C /65%
Polarity	Horizontal	Site / Test Engineer	AC2 / Stanley
Test Mode	802.11ac-20MHz_TX_Band1_CH 44_ANT 0+1	Test Voltage	AC 120V/60Hz

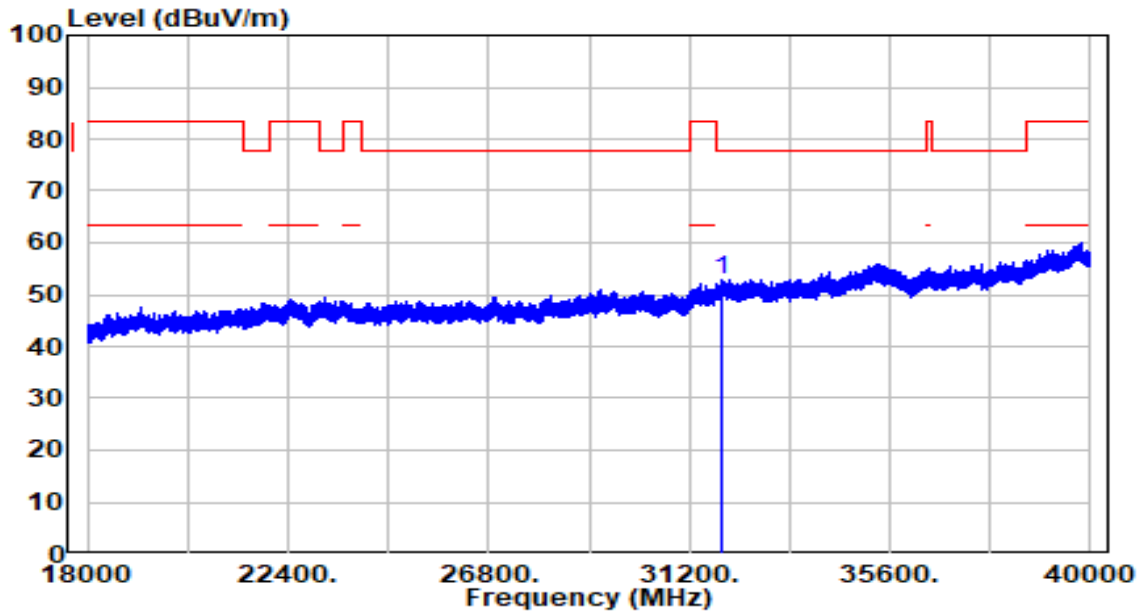

No	Frequency (MHz)	Reading (dBuV)	C.F (dB/m)	Measurement (dBuV/m)	Margin (dB)	Limit (dBuV/m)	Height (cm)	Angle (deg)	Remark (QP/PK/AV)
1	*	34.53	18.42	52.95	-24.75	77.70	150	0	Peak

Note:

1. "*", means this data is the worst emission level.
2. C.F (Correction Factor) = Antenna Factor (dB/m) + Cable Loss (dB) – Preamplifier(dB).
3. Measurement (dBuV/m) = Reading(dBuV) + C.F (Correction Factor).
4. The emission levels of other frequencies are very lower than the limit and not show in test report.

EUT	BE3600 Dual-Band Wi-Fi 7 Router	Date of Test	2024-02-22
Factor	BBHA 9170	Temp. / Humidity	20°C /65%
Polarity	Vertical	Site / Test Engineer	AC2 / Stanley
Test Mode	802.11ac-20MHz_TX_Band1_CH 44_ANT 0+1	Test Voltage	AC 120V/60Hz

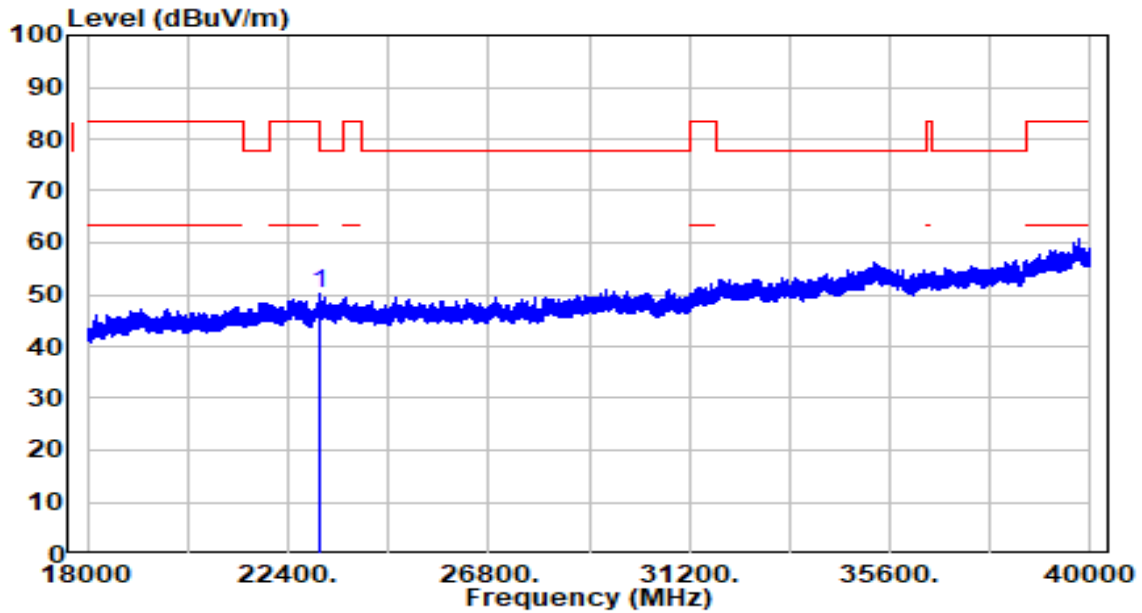

No	Frequency (MHz)	Reading (dBuV)	C.F (dB/m)	Measurement (dBuV/m)	Margin (dB)	Limit (dBuV/m)	Height (cm)	Angle (deg)	Remark (QP/PK/AV)	
1	*	23112.940	37.88	12.38	50.26	-33.24	83.50	150	360	Peak

Note:

1. "*", means this data is the worst emission level.
2. C.F (Correction Factor) = Antenna Factor (dB/m) + Cable Loss (dB) – Preamplifier(dB).
3. Measurement (dBuV/m) = Reading(dBuV) + C.F (Correction Factor).
4. The emission levels of other frequencies are very lower than the limit and not show in test report.

7.9. Radiated Restricted Band Edge Measurement

7.9.1. Test Limit

For 15.205 requirement:

Radiated emissions which fall in the restricted bands, as defined in Section 15.205(a) of FCC part 15, must also comply with the radiated emission limits specified in Section 15.209(a).

Frequency (MHz)	Frequency (MHz)	Frequency (MHz)	Frequency (GHz)
0.090 - 0.110	16.42-16.423	399.9 - 410	4.5-5.15
¹ 0.495 - 0.505	16.69475-16.69525	608 - 614	5.35-5.46
2.1735-2.1905	16.80425-16.80475	960 - 1240	7.25-7.75
4.125-4.128	25.5 -25.67	1300 - 1427	8.025 - 8.5
4.17725-4.17775	37.5-38.25	1435-1626.5	9.0-9.2
4.20725-4.20775	73-74.6	1645.5-1646.5	9.3-9.5
6.215-6.218	74.8-75.2	1660 - 1710	10.6-12.7
6.26775-6.26825	108-121.94	1718.8-1722.2	13.25-13.4
6.31175-6.31225	123 - 138	2200 - 2300	14.47-14.5
8.291-8.294	149.9-150.05	2310 - 2390	15.35-16.2
8.362-8.366	156.52475-156.525	2483.5 - 2500	17.7-21.4
8.37625-8.38675	156.7-156.9	2690 - 2900	22.01-23.12
8.41425-8.41475	162.0125-167.17	3260 - 3267	23.6-24.0
12.29-12.293	167.72-173.2	3332 - 3339	31.2-31.8
12.51975-12.52025	240 - 285	3345.8 - 3358	36.43-36.5
12.57675-12.57725	322-335.4	3600 - 4400	(²)
13.36-13.41	--	--	--

For 15.407(b) requirement:

For transmitters operating in the 5.15-5.25 GHz band: All emissions outside of the 5.15-5.35 GHz band shall not exceed an e.i.r.p. of -27 dBm/MHz.

For transmitters operating in the 5.25-5.35 GHz band: All emissions outside of the 5.15-5.35 GHz band shall not exceed an e.i.r.p. of -27 dBm/MHz.

For transmitters operating in the 5.47-5.725 GHz band: All emissions outside of the 5.47-5.725 GHz band shall not exceed an e.i.r.p. of -27 dBm/MHz.

For transmitters operating in the 5.725-5.85 GHz band: All emissions shall be limited to a level of -27 dBm/MHz at 75 MHz or more above or below the band edge increasing linearly to 10 dBm/MHz at 25 MHz above or below the band edge, and from 25 MHz above or below the band edge

increasing linearly to a level of 15.6 dBm/MHz at 5 MHz above or below the band edge, and from 5 MHz above or below the band edge increasing linearly to a level of 27 dBm/MHz at the band edge.

Refer to KDB 789033 D02v02r01 G)2)c), as specified in § 15.407(b), emissions above 1000 MHz that are outside of the restricted bands are subject to a maximum emission limit of -27 dBm/MHz (or -17 dBm/MHz as specified in § 15.407(b)(4)). However, an out-of-band emission that complies with both the peak and average limits of § 15.209 is not required to satisfy the -27 dBm/MHz or -17 dBm/MHz maximum emission limit.

All out of band emissions appearing in a restricted band as specified in Section 15.205 of the Title 47CFR must not exceed the limits shown in Table per Section 15.209.

FCC Part 15 Subpart C Paragraph 15.209		
Frequency [MHz]	Field Strength [uV/m]	Measured Distance [Meters]
0.009 - 0.490	2400/F (kHz)	300
0.490 - 1.705	24000/F (kHz)	30
1.705 - 30	30	30
30 - 88	100	3
88 - 216	150	3
216 - 960	200	3
Above 960	500	3

7.9.2. Test Procedure Used

KDB 789033 D02v02r01- Section G

7.9.3. Test Setting

Peak Measurements above 1GHz

1. Analyzer center frequency was set to the frequency of the radiated spurious emission of interest
2. RBW = 1MHz
3. VBW = 3MHz
4. Detector = peak
5. Sweep time = auto couple
6. Trace mode = max hold
7. Trace was allowed to stabilize

Average Measurements above 1GHz (Method VB)

1. Analyzer center frequency was set to the frequency of the radiated spurious emission of interest
2. RBW = 1MHz
3. VBW If the EUT is configured to transmit with duty cycle $\geq 98\%$, set VBW \leq RBW/100 (i.e., 10 kHz) but not less than 10 Hz. If the EUT duty cycle is $< 98\%$, set VBW $\geq 1/T$.
4. Detector = Peak
5. Sweep time = auto
6. Allow max hold to run for at least 50 traces if the transmitted signal is continuous or has at least 98% duty cycle. For lower duty cycles, increase the minimum number of traces by a factor of $1/x$, where x is the duty cycle.

7.9.4. Test Setup

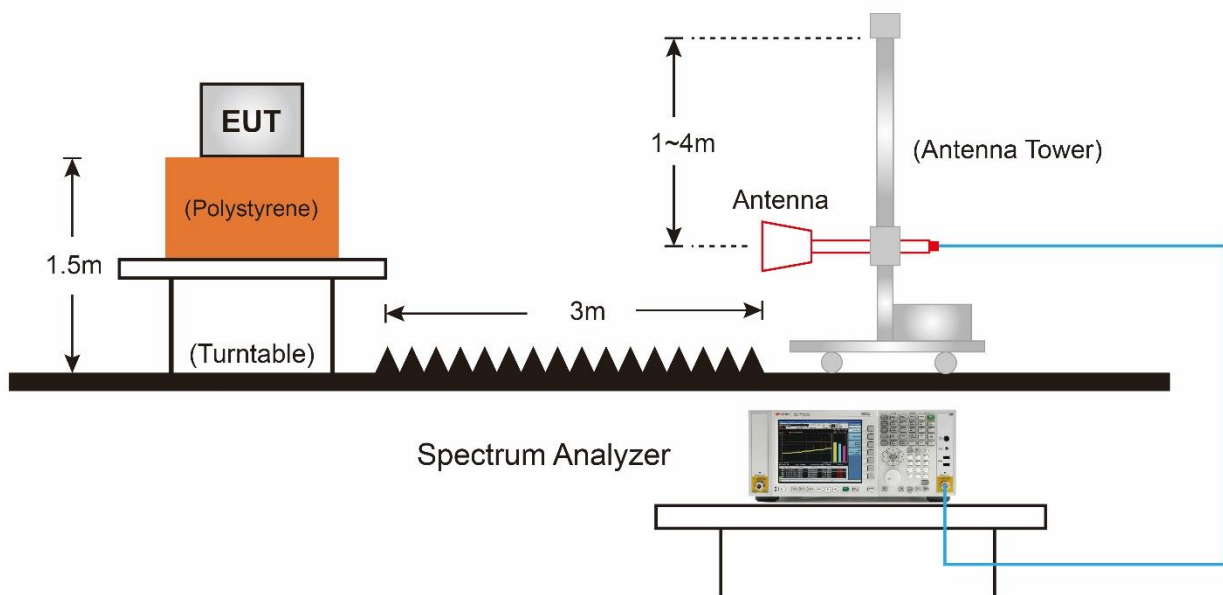

7.9.5. Test Result

EUT	BE3600 Dual-Band Wi-Fi 7 Router	Date of Test	2024-02-06
Factor	DRH18-E	Temp. / Humidity	20°C /65%
Polarity	Horizontal	Site / Test Engineer	AC2 / Stanley
Test Mode	802.11a_TX_Band1_CH 36_ANT 0+1	Test Voltage	AC 120V/60Hz

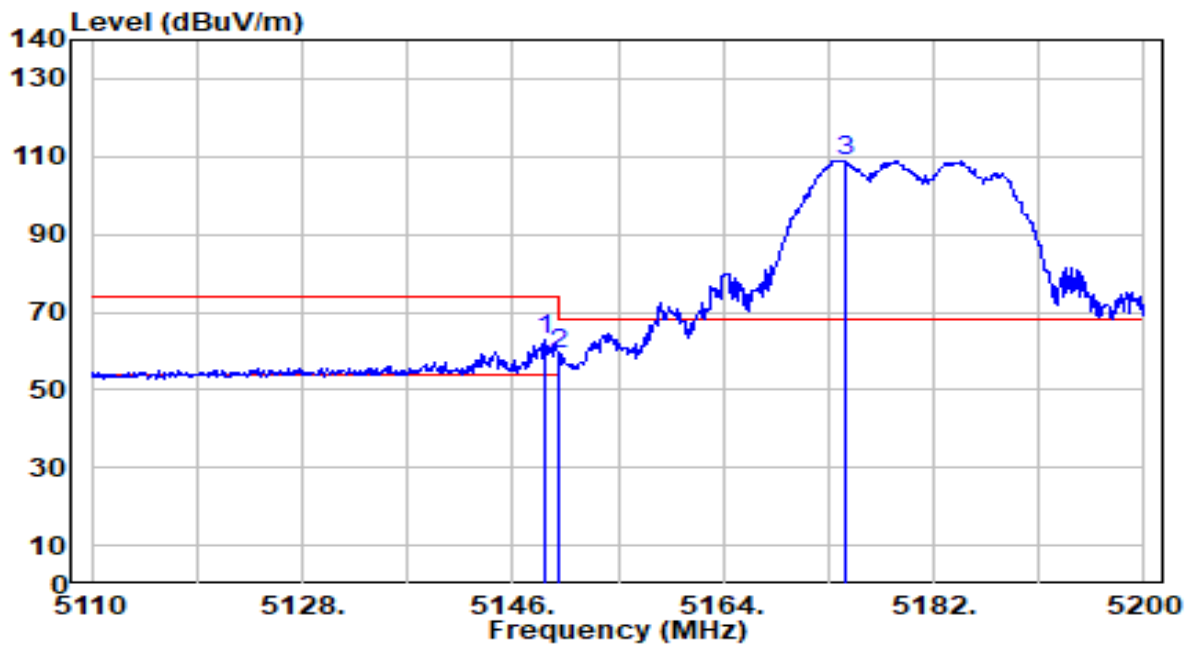

No	Frequency (MHz)	Reading (dBuV)	C.F (dB/m)	Measurement (dBuV/m)	Margin (dB)	Limit (dBuV/m)	Height (cm)	Angle (deg)	Remark (QP/PK/AV)	
1	*	5148.700	62.22	0.68	62.90	-11.10	74.00	273	145	Peak
2		5150.000	58.35	0.68	59.02	-14.98	74.00	273	145	Peak
3		5174.530	108.42	0.67	109.09	N/A	N/A	273	145	Peak

Note:

1. " *", means this data is the worst emission level.
2. C.F (Correction Factor) = Antenna Factor (dB/m)+ Cable Loss (dB) – Preamplifier(dB) + 10dB Attenuation.
3. Measurement (dBuV/m) = Reading(dBuV) + C.F (Correction Factor).
4. The emission levels of other frequencies are very lower than the limit and not show in test report.

EUT	BE3600 Dual-Band Wi-Fi 7 Router	Date of Test	2024-02-06
Factor	DRH18-E	Temp. / Humidity	20°C /65%
Polarity	Horizontal	Site / Test Engineer	AC2 / Stanley
Test Mode	802.11a_TX_Band1_CH 36_ANT 0+1	Test Voltage	AC 120V/60Hz

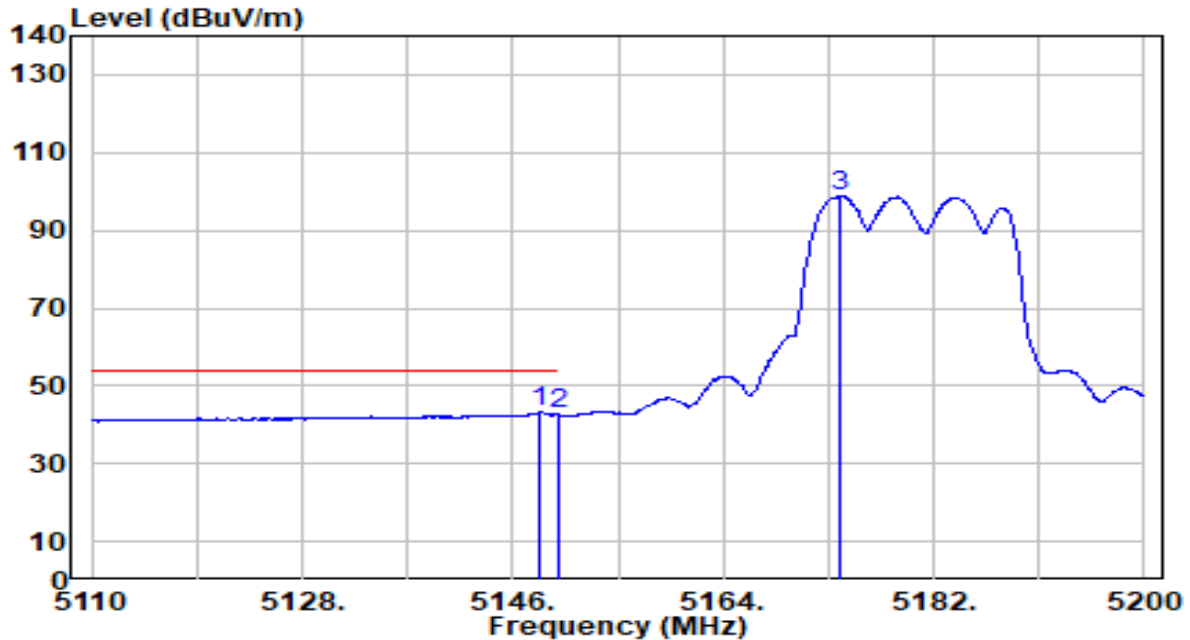

No	Frequency (MHz)	Reading (dBUV)	C.F (dB/m)	Measurement (dBUV/m)	Margin (dB)	Limit (dBUV/m)	Height (cm)	Angle (deg)	Remark (QP/PK/AV)
1	* 5148.340	42.61	0.68	43.29	-10.71	54.00	273	145	Average
2	5150.000	41.98	0.68	42.65	-11.35	54.00	273	145	Average
3	5173.990	98.24	0.67	98.92	N/A	N/A	273	145	Average

Note:

1. " *", means this data is the worst emission level.
2. C.F (Correction Factor) = Antenna Factor (dB/m)+ Cable Loss (dB) – Preamplifier(dB) + 10dB Attenuation.
3. Measurement (dBUV/m) = Reading(dBUV) + C.F (Correction Factor).
4. The emission levels of other frequencies are very lower than the limit and not show in test report.

EUT	BE3600 Dual-Band Wi-Fi 7 Router	Date of Test	2024-02-06
Factor	DRH18-E	Temp. / Humidity	20°C /65%
Polarity	Vertical	Site / Test Engineer	AC2 / Stanley
Test Mode	802.11a_TX_Band1_CH 36_ANT 0+1	Test Voltage	AC 120V/60Hz

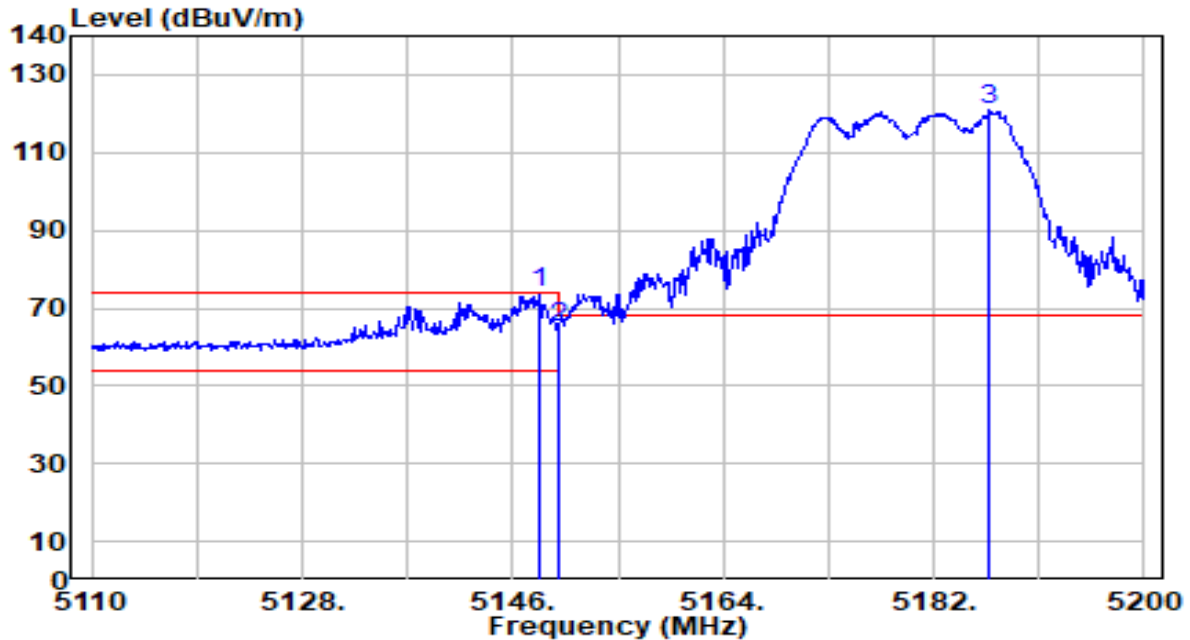

No	Frequency (MHz)	Reading (dBuV)	C.F (dB/m)	Measurement (dBuV/m)	Margin (dB)	Limit (dBuV/m)	Height (cm)	Angle (deg)	Remark (QP/PK/AV)
1	* 5148.250	73.19	0.68	73.86	-0.14	74.00	139	72	Peak
2	5150.000	64.47	0.68	65.15	-8.85	74.00	139	72	Peak
3	5186.770	120.38	0.67	121.06	N/A	N/A	139	72	Peak

Note:

1. " *", means this data is the worst emission level.
2. C.F (Correction Factor) = Antenna Factor (dB/m)+ Cable Loss (dB) – Preamplifier(dB) + 10dB Attenuation.
3. Measurement (dBuV/m) = Reading(dBuV) + C.F (Correction Factor).
4. The emission levels of other frequencies are very lower than the limit and not show in test report.

EUT	BE3600 Dual-Band Wi-Fi 7 Router	Date of Test	2024-02-06
Factor	DRH18-E	Temp. / Humidity	20°C /65%
Polarity	Vertical	Site / Test Engineer	AC2 / Stanley
Test Mode	802.11a_TX_Band1_CH 36_ANT 0+1	Test Voltage	AC 120V/60Hz

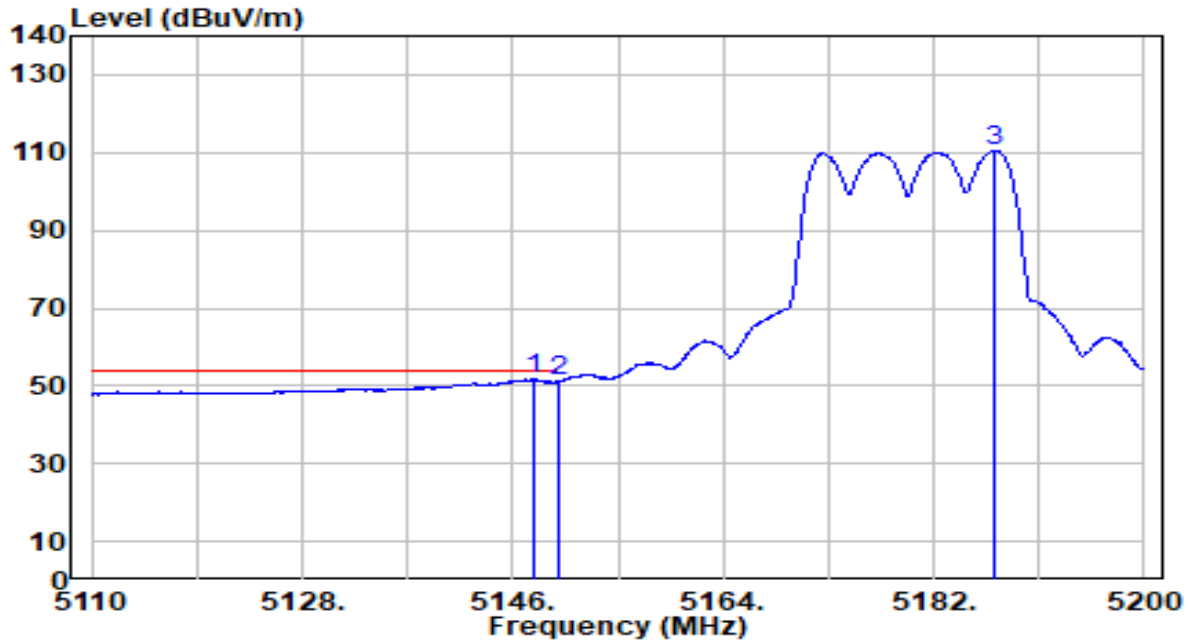

No	Frequency (MHz)	Reading (dBUV)	C.F (dB/m)	Measurement (dBUV/m)	Margin (dB)	Limit (dBUV/m)	Height (cm)	Angle (deg)	Remark (QP/PK/AV)
1	* 5147.800	50.96	0.68	51.64	-2.36	54.00	139	72	Average
2	5150.000	50.47	0.68	51.14	-2.86	54.00	139	72	Average
3	5187.130	109.79	0.67	110.46	N/A	N/A	139	72	Average

Note:

1. " *", means this data is the worst emission level.
2. C.F (Correction Factor) = Antenna Factor (dB/m)+ Cable Loss (dB) – Pre-amplifier(dB) + 10dB Attenuation.
3. Measurement (dBUV/m) = Reading(dBUV) + C.F (Correction Factor).
4. The emission levels of other frequencies are very lower than the limit and not show in test report.

EUT	BE3600 Dual-Band Wi-Fi 7 Router	Date of Test	2024-02-06
Factor	DRH18-E	Temp. / Humidity	20°C /65%
Polarity	Horizontal	Site / Test Engineer	AC2 / Stanley
Test Mode	802.11a_TX_Band2_CH 64_ANT 0+1	Test Voltage	AC 120V/60Hz

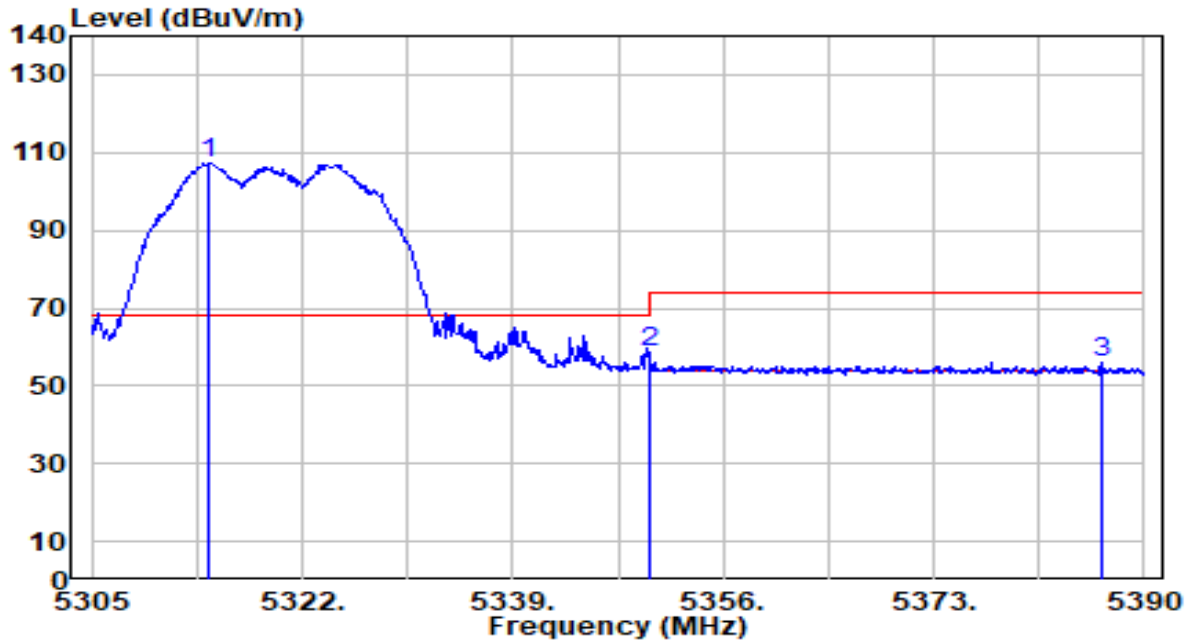

No	Frequency (MHz)	Reading (dBuV)	C.F (dB/m)	Measurement (dBuV/m)	Margin (dB)	Limit (dBuV/m)	Height (cm)	Angle (deg)	Remark (QP/PK/AV)
1	5314.350	106.87	0.54	107.41	N/A	N/A	296	147	Peak
2	* 5350.000	58.36	0.51	58.87	-15.13	74.00	296	147	Peak
3	5386.515	55.34	0.46	55.81	-18.19	74.00	296	147	Peak

Note:

1. " *", means this data is the worst emission level.
2. C.F (Correction Factor) = Antenna Factor (dB/m)+ Cable Loss (dB) – Preamplifier(dB) + 10dB Attenuation.
3. Measurement (dBuV/m) = Reading(dBuV) + C.F (Correction Factor).
4. The emission levels of other frequencies are very lower than the limit and not show in test report.

EUT	BE3600 Dual-Band Wi-Fi 7 Router	Date of Test	2024-02-06
Factor	DRH18-E	Temp. / Humidity	20°C /65%
Polarity	Horizontal	Site / Test Engineer	AC2 / Stanley
Test Mode	802.11a_TX_Band2_CH 64_ANT 0+1	Test Voltage	AC 120V/60Hz

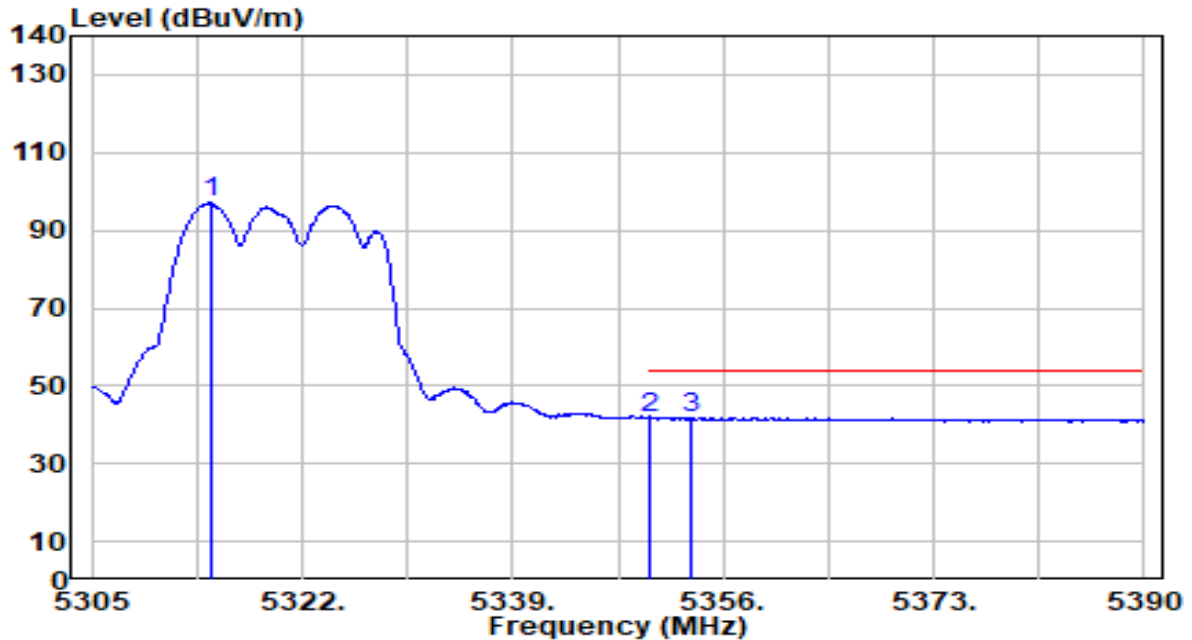

No	Frequency (MHz)	Reading (dBUV)	C.F (dB/m)	Measurement (dBUV/m)	Margin (dB)	Limit (dBUV/m)	Height (cm)	Angle (deg)	Remark (QP/PK/AV)
1	5314.605	96.49	0.54	97.03	N/A	N/A	296	147	Average
2	* 5350.000	41.34	0.51	41.84	-12.16	54.00	296	147	Average
3	5353.365	41.33	0.50	41.83	-12.17	54.00	296	147	Average

Note:

- "*", means this data is the worst emission level.
- C.F (Correction Factor) = Antenna Factor (dB/m)+ Cable Loss (dB) – Preamplifier(dB) + 10dB Attenuation.
- Measurement (dBUV/m) = Reading(dBUV) + C.F (Correction Factor).
- The emission levels of other frequencies are very lower than the limit and not show in test report.

EUT	BE3600 Dual-Band Wi-Fi 7 Router	Date of Test	2024-02-06
Factor	DRH18-E	Temp. / Humidity	20°C /65%
Polarity	Vertical	Site / Test Engineer	AC2 / Stanley
Test Mode	802.11a_TX_Band2_CH 64_ANT 0+1	Test Voltage	AC 120V/60Hz

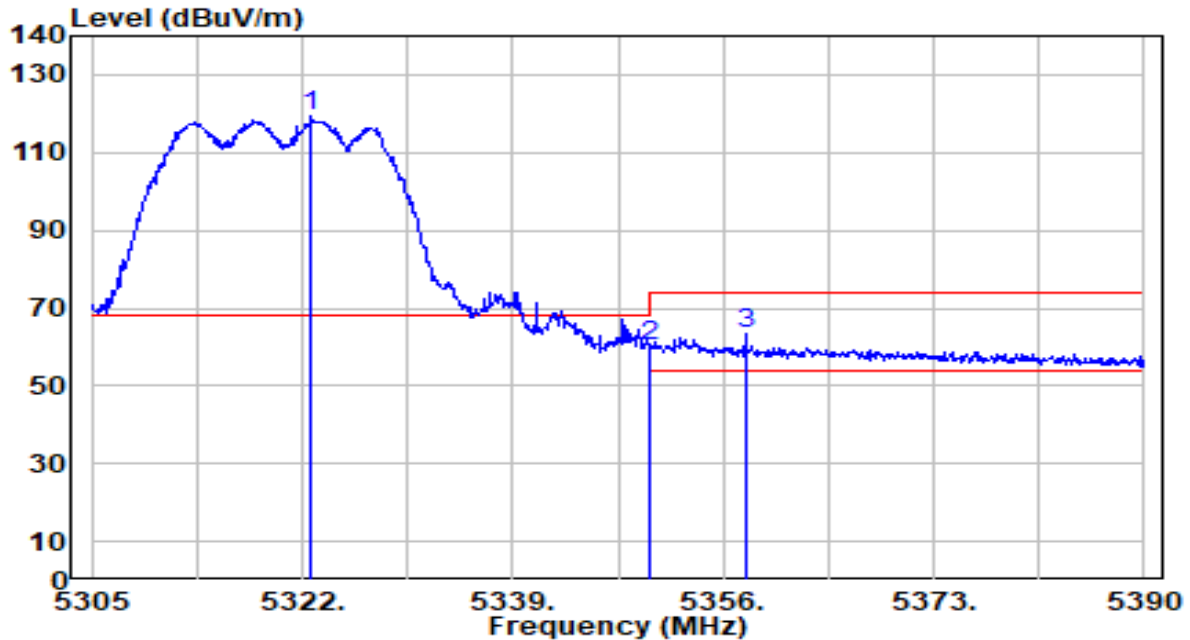

No	Frequency (MHz)	Reading (dBuV)	C.F (dB/m)	Measurement (dBuV/m)	Margin (dB)	Limit (dBuV/m)	Height (cm)	Angle (deg)	Remark (QP/PK/AV)
1	5322.765	118.83	0.53	119.36	N/A	N/A	122	38	Peak
2	5350.000	59.70	0.51	60.20	-13.80	74.00	122	38	Peak
3	* 5357.785	62.76	0.50	63.25	-10.75	74.00	122	38	Peak

Note:

1. " *", means this data is the worst emission level.
2. C.F (Correction Factor) = Antenna Factor (dB/m)+ Cable Loss (dB) – Preamplifier(dB) + 10dB Attenuation.
3. Measurement (dBuV/m) = Reading(dBuV) + C.F (Correction Factor).
4. The emission levels of other frequencies are very lower than the limit and not show in test report.

EUT	BE3600 Dual-Band Wi-Fi 7 Router	Date of Test	2024-02-06
Factor	DRH18-E	Temp. / Humidity	20°C /65%
Polarity	Vertical	Site / Test Engineer	AC2 / Stanley
Test Mode	802.11a_TX_Band2_CH 64_ANT 0+1	Test Voltage	AC 120V/60Hz

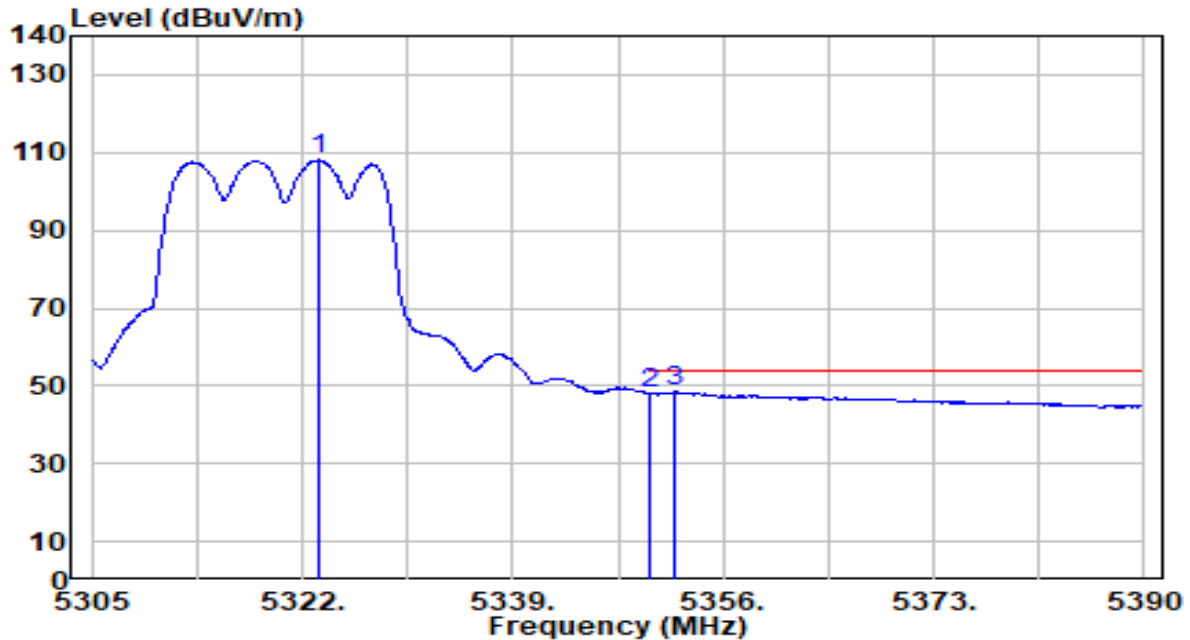

No	Frequency (MHz)	Reading (dBUV)	C.F (dB/m)	Measurement (dBUV/m)	Margin (dB)	Limit (dBUV/m)	Height (cm)	Angle (deg)	Remark (QP/PK/AV)
1	5323.360	107.62	0.53	108.15	N/A	N/A	122	38	Average
2	5350.000	47.59	0.51	48.10	-5.90	54.00	122	38	Average
3	* 5352.090	47.90	0.50	48.40	-5.60	54.00	122	38	Average

Note:

- "*", means this data is the worst emission level.
- C.F (Correction Factor) = Antenna Factor (dB/m)+ Cable Loss (dB) – Preamplifier(dB) + 10dB Attenuation.
- Measurement (dBUV/m) = Reading(dBUV) + C.F (Correction Factor).
- The emission levels of other frequencies are very lower than the limit and not show in test report.

EUT	BE3600 Dual-Band Wi-Fi 7 Router	Date of Test	2024-02-06
Factor	DRH18-E	Temp. / Humidity	20°C /65%
Polarity	Horizontal	Site / Test Engineer	AC2 / Stanley
Test Mode	802.11a_TX_Band3_CH 100_ANT 0+1	Test Voltage	AC 120V/60Hz

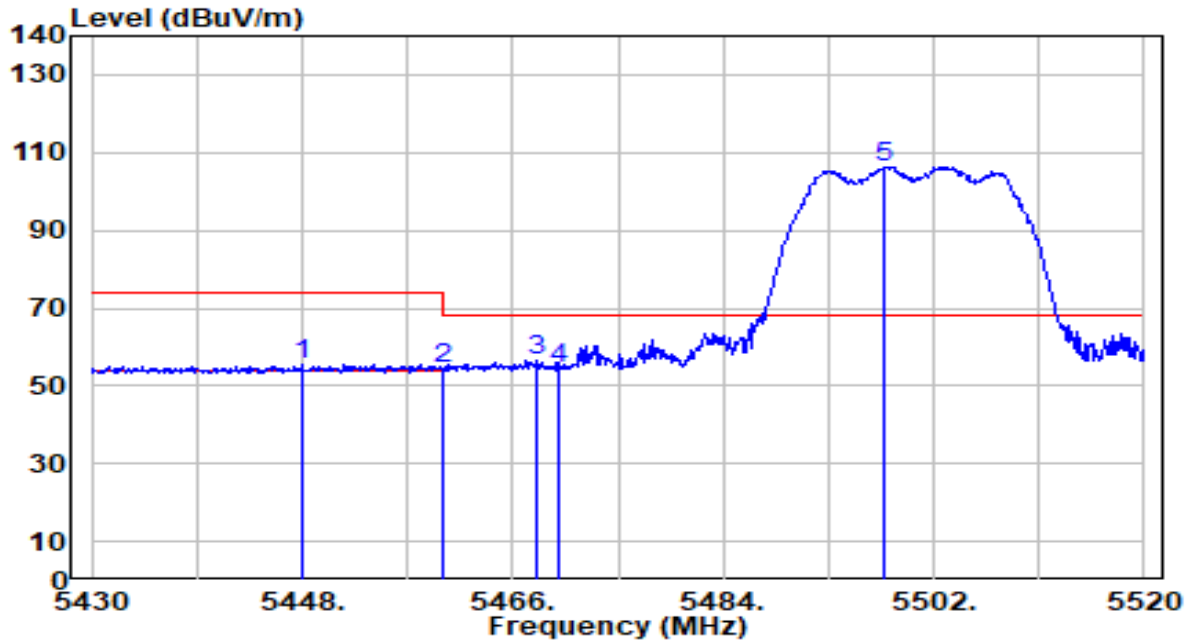

No	Frequency (MHz)	Reading (dBUV)	C.F (dB/m)	Measurement (dBUV/m)	Margin (dB)	Limit (dBUV/m)	Height (cm)	Angle (deg)	Remark (QP/PK/AV)
1	5447.910	55.04	0.61	55.65	-18.35	74.00	230	226	Peak
2	5460.000	53.62	0.65	54.28	-19.72	74.00	230	226	Peak
3	* 5468.160	55.81	0.68	56.49	-11.71	68.20	230	226	Peak
4	5470.000	53.49	0.69	54.18	-14.02	68.20	230	226	Peak
5	5497.770	105.63	0.78	106.41	N/A	N/A	230	226	Peak

Note:

1. " *", means this data is the worst emission level.
2. C.F (Correction Factor) = Antenna Factor (dB/m)+ Cable Loss (dB) – Preamplifier(dB) + 10dB Attenuation.
3. Measurement (dBUV/m) = Reading(dBUV) + C.F (Correction Factor).
4. The emission levels of other frequencies are very lower than the limit and not show in test report.

EUT	BE3600 Dual-Band Wi-Fi 7 Router	Date of Test	2024-02-06
Factor	DRH18-E	Temp. / Humidity	20°C /65%
Polarity	Horizontal	Site / Test Engineer	AC2 / Stanley
Test Mode	802.11a_TX_Band3_CH 100_ANT 0+1	Test Voltage	AC 120V/60Hz

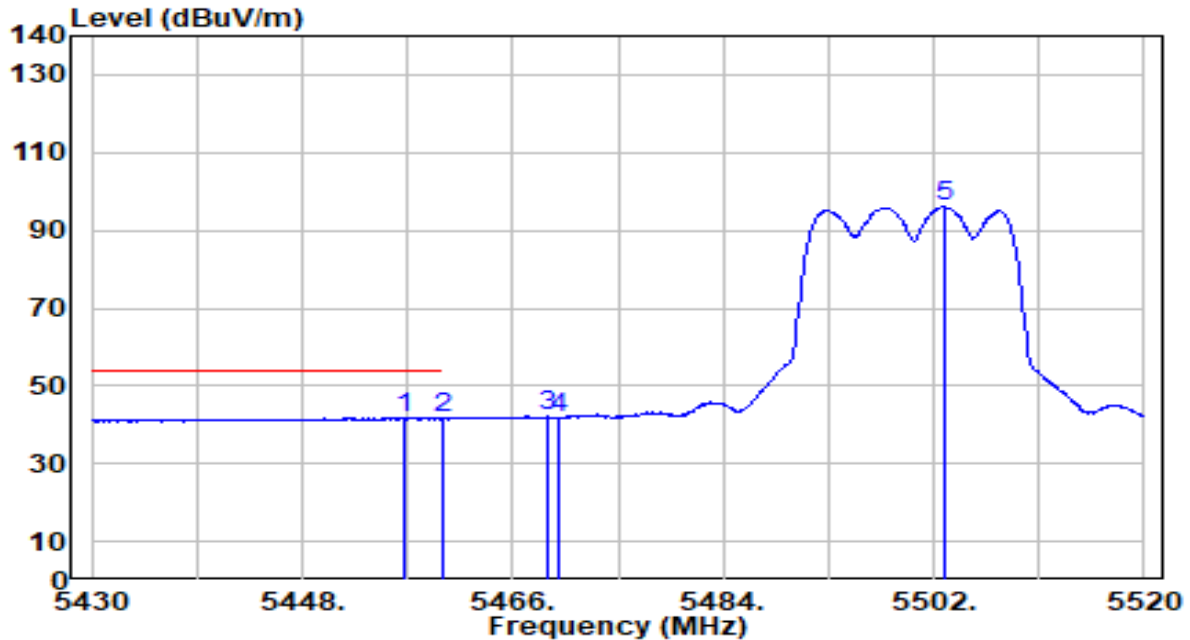

No	Frequency (MHz)	Reading (dBUV)	C.F (dB/m)	Measurement (dBUV/m)	Margin (dB)	Limit (dBUV/m)	Height (cm)	Angle (deg)	Remark (QP/PK/AV)
1	* 5456.820	41.25	0.64	41.90	-12.10	54.00	230	226	Average
2	5460.000	40.91	0.65	41.57	-12.43	54.00	230	226	Average
3	5468.970	41.37	0.68	42.06	N/A	N/A	230	226	Average
4	5470.000	41.28	0.69	41.96	N/A	N/A	230	226	Average
5	5502.990	95.22	0.80	96.02	N/A	N/A	230	226	Average

Note:

1. " *", means this data is the worst emission level.
2. C.F (Correction Factor) = Antenna Factor (dB/m)+ Cable Loss (dB) – Preamplifier(dB) + 10dB Attenuation.
3. Measurement (dBUV/m) = Reading(dBUV) + C.F (Correction Factor).
4. The emission levels of other frequencies are very lower than the limit and not show in test report.

EUT	BE3600 Dual-Band Wi-Fi 7 Router	Date of Test	2024-02-06
Factor	DRH18-E	Temp. / Humidity	20°C /65%
Polarity	Vertical	Site / Test Engineer	AC2 / Stanley
Test Mode	802.11a_TX_Band3_CH 100_ANT 0+1	Test Voltage	AC 120V/60Hz

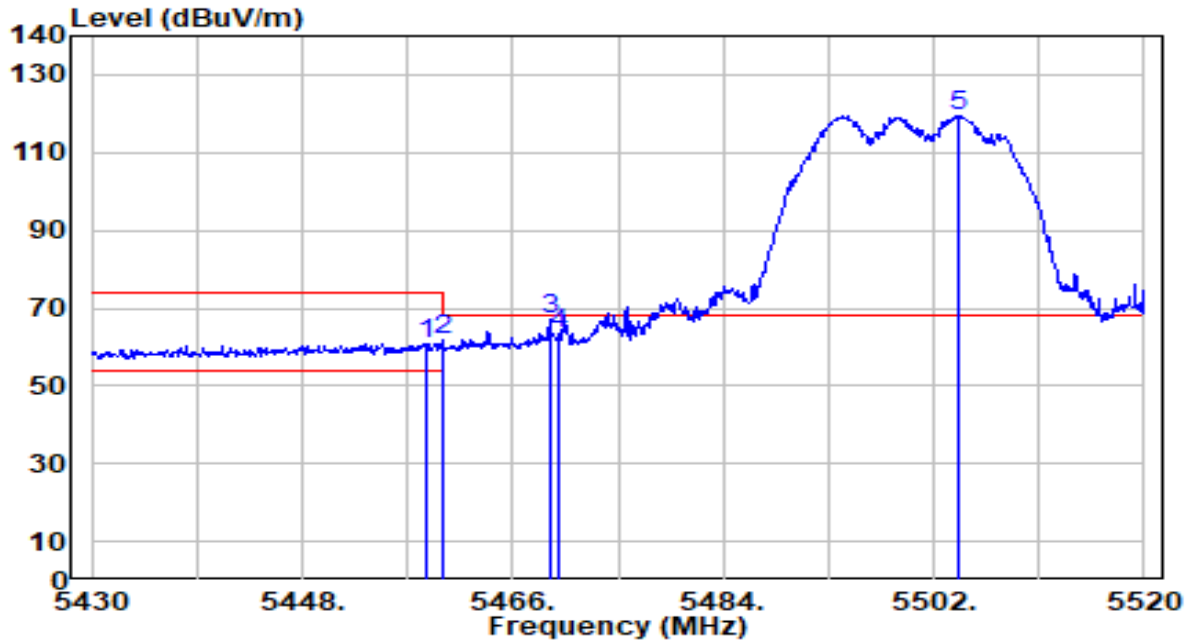

No	Frequency (MHz)	Reading (dBUV)	C.F (dB/m)	Measurement (dBUV/m)	Margin (dB)	Limit (dBUV/m)	Height (cm)	Angle (deg)	Remark (QP/PK/AV)
1	5458.620	60.31	0.65	60.96	-13.04	74.00	136	36	Peak
2	5460.000	60.96	0.65	61.61	-12.39	74.00	136	36	Peak
3 *	5469.240	66.44	0.69	67.13	-1.07	68.20	136	36	Peak
4	5470.000	62.60	0.69	63.29	-4.91	68.20	136	36	Peak
5	5504.160	118.81	0.81	119.62	N/A	N/A	136	36	Peak

Note:

1. " *", means this data is the worst emission level.
2. C.F (Correction Factor) = Antenna Factor (dB/m)+ Cable Loss (dB) – Preamplifier(dB) + 10dB Attenuation.
3. Measurement (dBUV/m) = Reading(dBUV) + C.F (Correction Factor).
4. The emission levels of other frequencies are very lower than the limit and not show in test report.

EUT	BE3600 Dual-Band Wi-Fi 7 Router	Date of Test	2024-02-06
Factor	DRH18-E	Temp. / Humidity	20°C /65%
Polarity	Vertical	Site / Test Engineer	AC2 / Stanley
Test Mode	802.11a_TX_Band3_CH 100_ANT 0+1	Test Voltage	AC 120V/60Hz

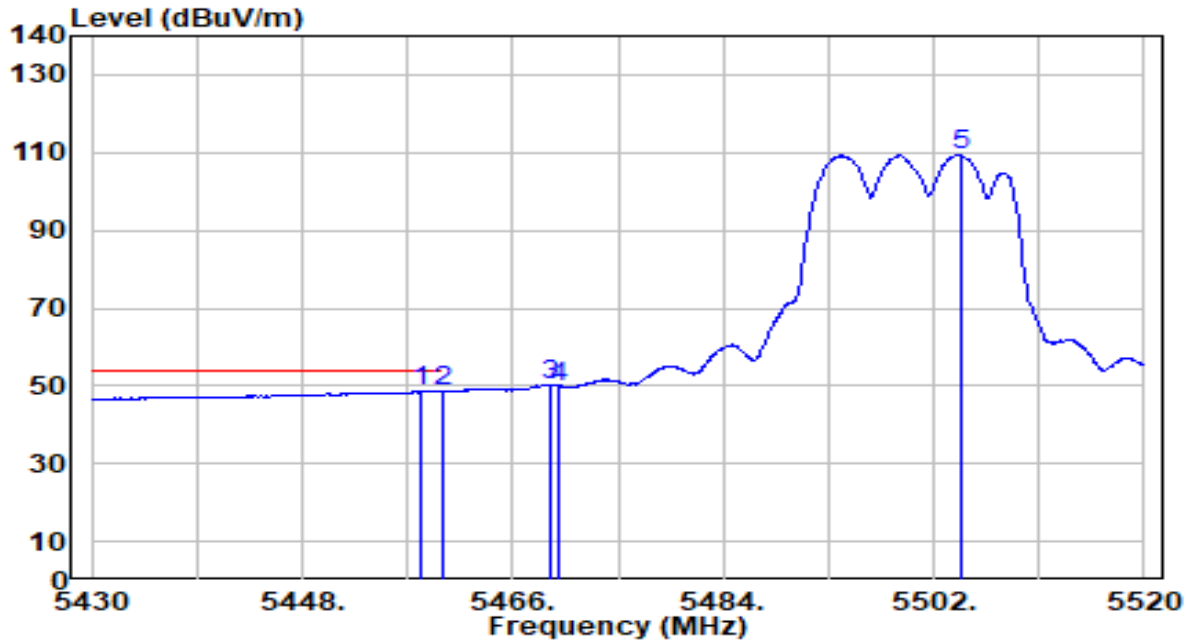

No	Frequency (MHz)	Reading (dBUV)	C.F (dB/m)	Measurement (dBUV/m)	Margin (dB)	Limit (dBUV/m)	Height (cm)	Angle (deg)	Remark (QP/PK/AV)
1	5458.260	48.03	0.65	48.68	-5.32	54.00	136	36	Average
2	* 5460.000	48.05	0.65	48.70	-5.30	54.00	136	36	Average
3	5469.240	49.45	0.69	50.14	N/A	N/A	136	36	Average
4	5470.000	49.18	0.69	49.87	N/A	N/A	136	36	Average
5	5504.250	108.54	0.81	109.34	N/A	N/A	136	36	Average

Note:

1. " *", means this data is the worst emission level.
2. C.F (Correction Factor) = Antenna Factor (dB/m)+ Cable Loss (dB) – Preamplifier(dB) + 10dB Attenuation.
3. Measurement (dBUV/m) = Reading(dBUV) + C.F (Correction Factor).
4. The emission levels of other frequencies are very lower than the limit and not show in test report.

EUT	BE3600 Dual-Band Wi-Fi 7 Router	Date of Test	2024-02-06
Factor	DRH18-E	Temp. / Humidity	20°C /65%
Polarity	Horizontal	Site / Test Engineer	AC2 / Stanley
Test Mode	802.11a_TX_Band3_CH 140_ANT 0+1	Test Voltage	AC 120V/60Hz

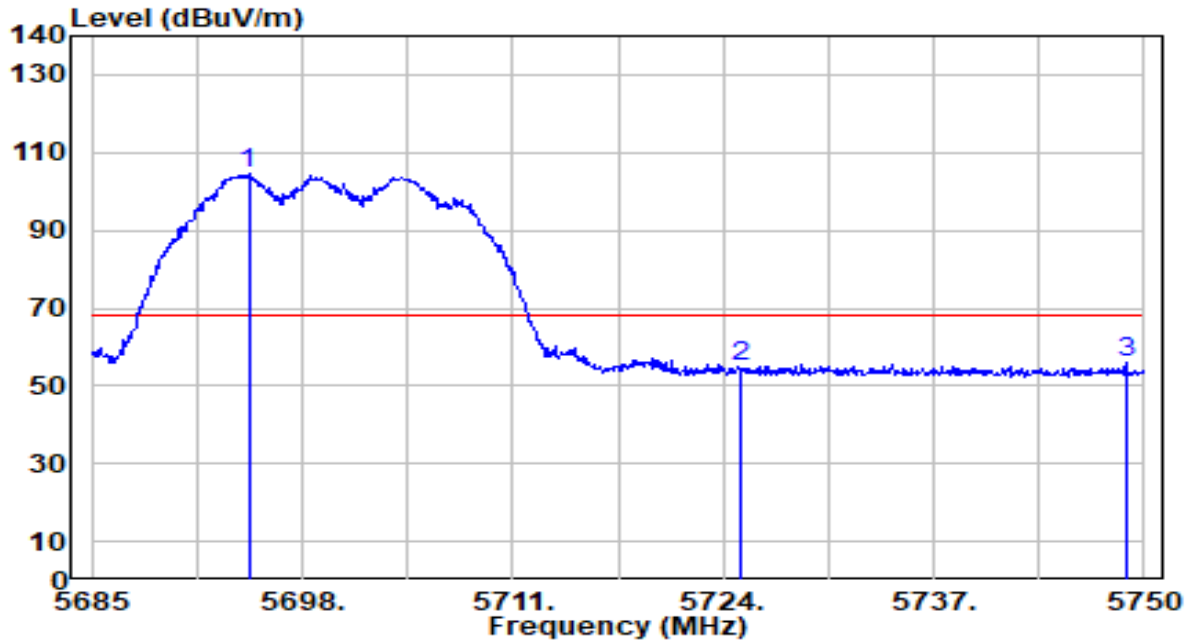

No	Frequency (MHz)	Reading (dBUV)	C.F (dB/m)	Measurement (dBUV/m)	Margin (dB)	Limit (dBUV/m)	Height (cm)	Angle (deg)	Remark (QP/PK/AV)
1	5694.685	102.75	1.69	104.44	N/A	N/A	173	144	Peak
2	5725.000	52.87	1.86	54.74	-13.46	68.20	173	144	Peak
3	* 5748.895	54.11	2.00	56.11	-12.09	68.20	173	144	Peak

Note:

1. " *", means this data is the worst emission level.
2. C.F (Correction Factor) = Antenna Factor (dB/m)+ Cable Loss (dB) – Preamplifier(dB) + 10dB Attenuation.
3. Measurement (dBUV/m) = Reading(dBUV) + C.F (Correction Factor).
4. The emission levels of other frequencies are very lower than the limit and not show in test report.

EUT	BE3600 Dual-Band Wi-Fi 7 Router	Date of Test	2024-02-06
Factor	DRH18-E	Temp. / Humidity	20°C /65%
Polarity	Vertical	Site / Test Engineer	AC2 / Stanley
Test Mode	802.11a_TX_Band3_CH 140_ANT 0+1	Test Voltage	AC 120V/60Hz

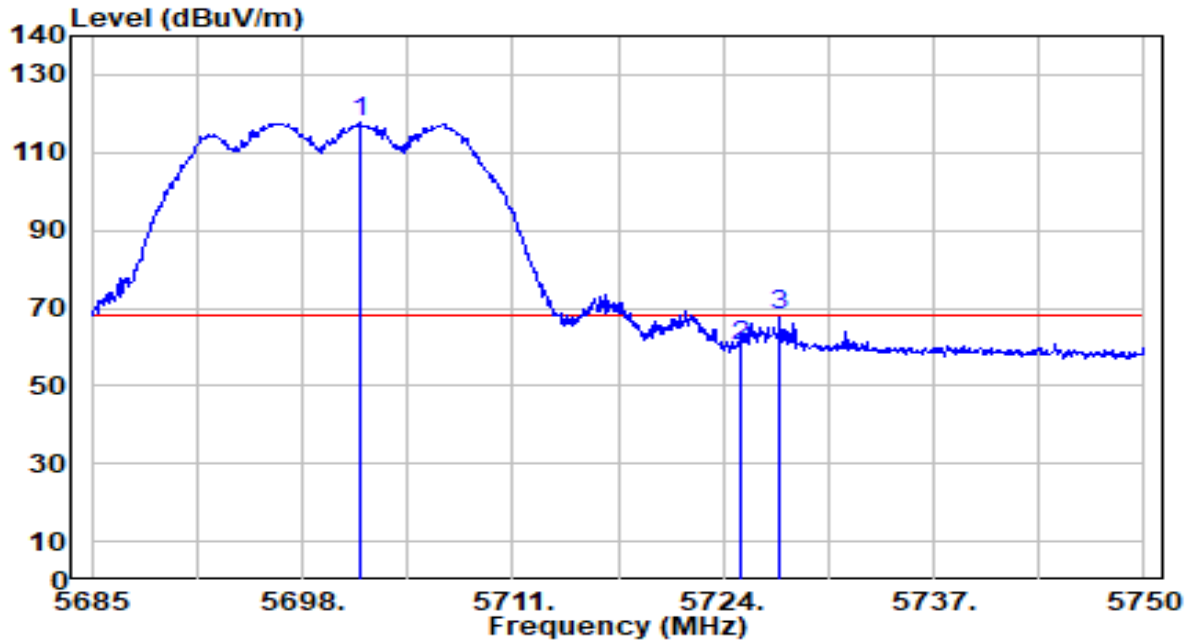

No	Frequency (MHz)	Reading (dBUV)	C.F (dB/m)	Measurement (dBUV/m)	Margin (dB)	Limit (dBUV/m)	Height (cm)	Angle (deg)	Remark (QP/PK/AV)
1	5701.510	115.99	1.73	117.72	N/A	N/A	201	184	Peak
2	5725.000	58.31	1.86	60.18	-8.02	68.20	201	184	Peak
3	* 5727.445	66.15	1.88	68.03	-0.17	68.20	201	184	Peak

Note:

1. " *", means this data is the worst emission level.
2. C.F (Correction Factor) = Antenna Factor (dB/m)+ Cable Loss (dB) – Preamplifier(dB) + 10dB Attenuation.
3. Measurement (dBUV/m) = Reading(dBUV) + C.F (Correction Factor).
4. The emission levels of other frequencies are very lower than the limit and not show in test report.

EUT	BE3600 Dual-Band Wi-Fi 7 Router	Date of Test	2024-02-06
Factor	DRH18-E	Temp. / Humidity	20°C /65%
Polarity	Horizontal	Site / Test Engineer	AC2 / Stanley
Test Mode	802.11a_TX_Band4_CH 149_ANT 0+1	Test Voltage	AC 120V/60Hz

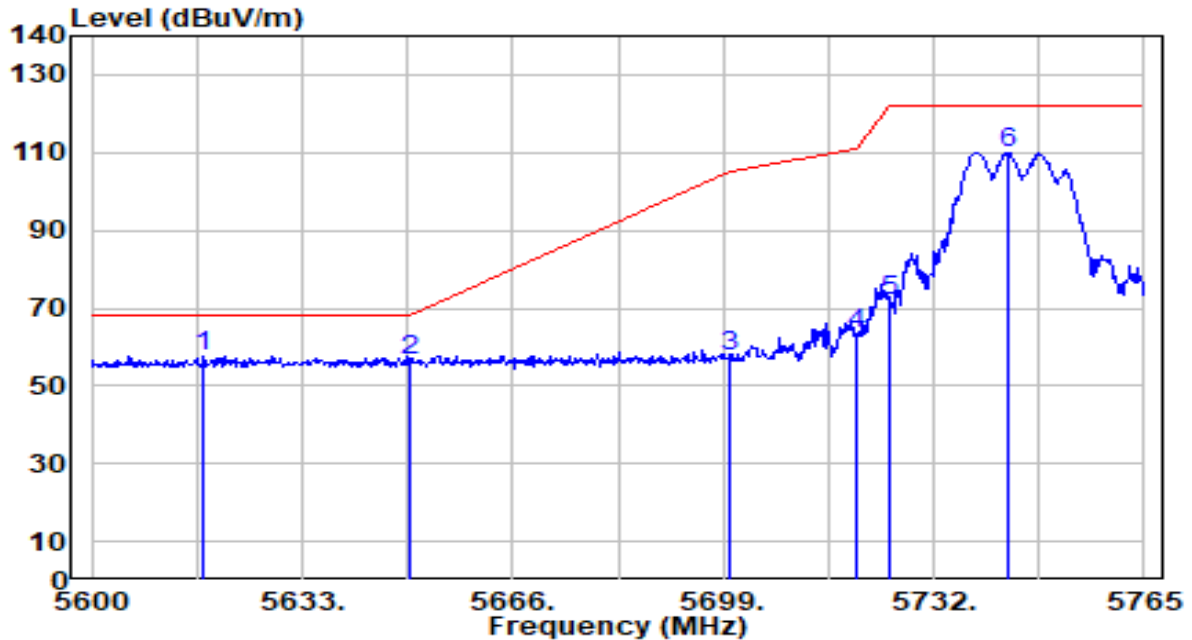

No	Frequency (MHz)	Reading (dBUV)	C.F (dB/m)	Measurement (dBUV/m)	Margin (dB)	Limit (dBUV/m)	Height (cm)	Angle (deg)	Remark (QP/PK/AV)
1	* 5617.490	56.54	1.25	57.80	-10.40	68.20	100	140	Peak
2	5650.000	55.15	1.44	56.59	-11.61	68.20	100	140	Peak
3	5700.000	55.69	1.72	57.42	-47.78	105.20	100	140	Peak
4	5720.000	61.40	1.84	63.24	-47.56	110.80	100	140	Peak
5	5725.000	70.22	1.86	72.08	-50.12	122.20	100	140	Peak
6	5743.715	108.17	1.97	110.14	N/A	N/A	100	140	Peak

Note:

- " *", means this data is the worst emission level.
- C.F (Correction Factor) = Antenna Factor (dB/m)+ Cable Loss (dB) – Preamplifier(dB) + 10dB Attenuation.
- Measurement (dBUV/m) = Reading(dBUV) + C.F (Correction Factor).
- The emission levels of other frequencies are very lower than the limit and not show in test report.

EUT	BE3600 Dual-Band Wi-Fi 7 Router	Date of Test	2024-02-06
Factor	DRH18-E	Temp. / Humidity	20°C /65%
Polarity	Vertical	Site / Test Engineer	AC2 / Stanley
Test Mode	802.11a_TX_Band4_CH 149_ANT 0+1	Test Voltage	AC 120V/60Hz

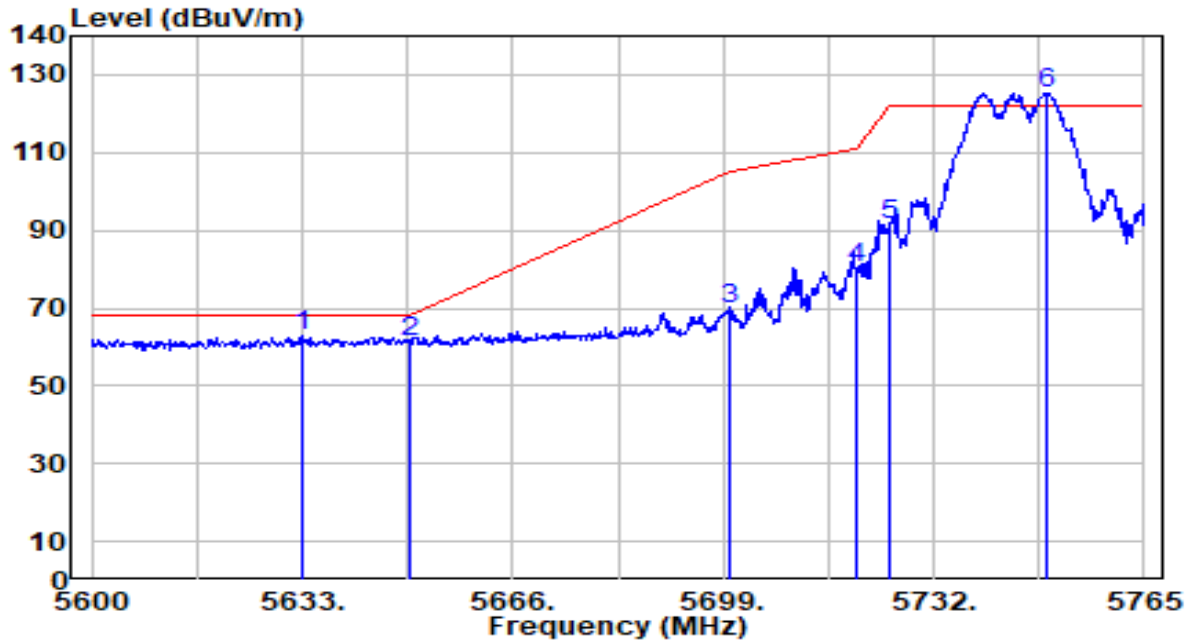

No	Frequency (MHz)	Reading (dBUV)	C.F (dB/m)	Measurement (dBUV/m)	Margin (dB)	Limit (dBUV/m)	Height (cm)	Angle (deg)	Remark (QP/PK/AV)
1	* 5633.000	61.30	1.34	62.64	-5.56	68.20	137	35	Peak
2	5650.000	60.06	1.44	61.49	-6.71	68.20	137	35	Peak
3	5700.000	68.09	1.72	69.81	-35.39	105.20	137	35	Peak
4	5720.000	78.34	1.84	80.18	-30.62	110.80	137	35	Peak
5	5725.000	89.63	1.86	91.49	-30.71	122.20	137	35	Peak
6	5749.655	123.06	2.00	125.07	N/A	N/A	137	35	Peak

Note:

- "*" means this data is the worst emission level.
- C.F (Correction Factor) = Antenna Factor (dB/m)+ Cable Loss (dB) – Preamplifier(dB) + 10dB Attenuation.
- Measurement (dBUV/m) = Reading(dBUV) + C.F (Correction Factor).
- The emission levels of other frequencies are very lower than the limit and not show in test report.

EUT	BE3600 Dual-Band Wi-Fi 7 Router	Date of Test	2024-02-06
Factor	DRH18-E	Temp. / Humidity	20°C /65%
Polarity	Horizontal	Site / Test Engineer	AC2 / Stanley
Test Mode	802.11a_TX_Band4_CH 165_ANT 0+1	Test Voltage	AC 120V/60Hz

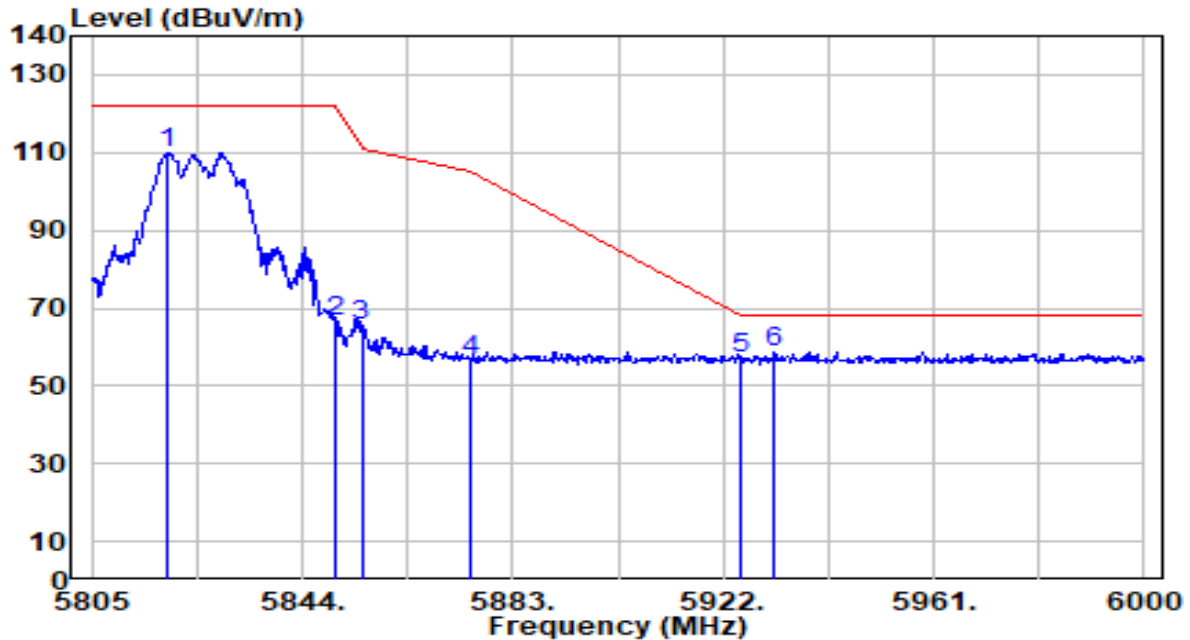

No	Frequency (MHz)	Reading (dBUV)	C.F (dB/m)	Measurement (dBUV/m)	Margin (dB)	Limit (dBUV/m)	Height (cm)	Angle (deg)	Remark (QP/PK/AV)
1	5819.040	107.72	2.28	110.01	N/A	N/A	100	142	Peak
2	5850.000	64.34	2.27	66.61	-55.59	122.20	100	142	Peak
3	5855.000	63.07	2.27	65.34	-45.46	110.80	100	142	Peak
4	5875.000	54.22	2.26	56.49	-48.71	105.20	100	142	Peak
5	5925.000	55.07	2.25	57.31	-10.89	68.20	100	142	Peak
6	* 5931.555	56.35	2.24	58.60	-9.60	68.20	100	142	Peak

Note:

1. " *", means this data is the worst emission level.
2. C.F (Correction Factor) = Antenna Factor (dB/m)+ Cable Loss (dB) – Preamplifier(dB) + 10dB Attenuation.
3. Measurement (dBUV/m) = Reading(dBUV) + C.F (Correction Factor).
4. The emission levels of other frequencies are very lower than the limit and not show in test report.

EUT	BE3600 Dual-Band Wi-Fi 7 Router	Date of Test	2024-02-06
Factor	DRH18-E	Temp. / Humidity	20°C /65%
Polarity	Vertical	Site / Test Engineer	AC2 / Stanley
Test Mode	802.11a_TX_Band4_CH 165_ANT 0+1	Test Voltage	AC 120V/60Hz

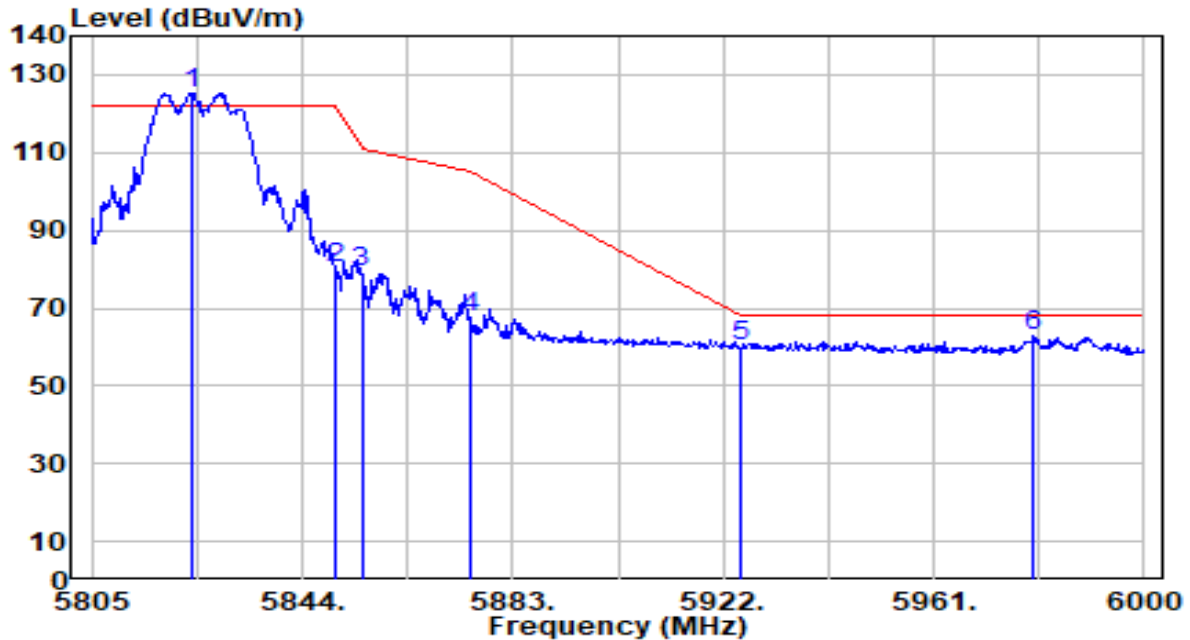

No	Frequency (MHz)	Reading (dBUV)	C.F (dB/m)	Measurement (dBUV/m)	Margin (dB)	Limit (dBUV/m)	Height (cm)	Angle (deg)	Remark (QP/PK/AV)
1	5823.525	122.93	2.28	125.21	N/A	N/A	154	320	Peak
2	5850.000	77.87	2.27	80.14	-42.06	122.20	154	320	Peak
3	5855.000	77.07	2.27	79.34	-31.46	110.80	154	320	Peak
4	5875.000	65.34	2.26	67.60	-37.60	105.20	154	320	Peak
5	5925.000	57.83	2.25	60.08	-8.12	68.20	154	320	Peak
6	* 5979.330	60.40	2.23	62.63	-5.57	68.20	154	320	Peak

Note:

1. " *", means this data is the worst emission level.
2. C.F (Correction Factor) = Antenna Factor (dB/m)+ Cable Loss (dB) – Preamplifier(dB) + 10dB Attenuation.
3. Measurement (dBUV/m) = Reading(dBUV) + C.F (Correction Factor).
4. The emission levels of other frequencies are very lower than the limit and not show in test report.

EUT	BE3600 Dual-Band Wi-Fi 7 Router	Date of Test	2024-02-06
Factor	DRH18-E	Temp. / Humidity	20°C /65%
Polarity	Horizontal	Site / Test Engineer	AC2 / Stanley
Test Mode	802.11ac-20MHz_TX_Band1_CH 36_ANT 0+1	Test Voltage	AC 120V/60Hz

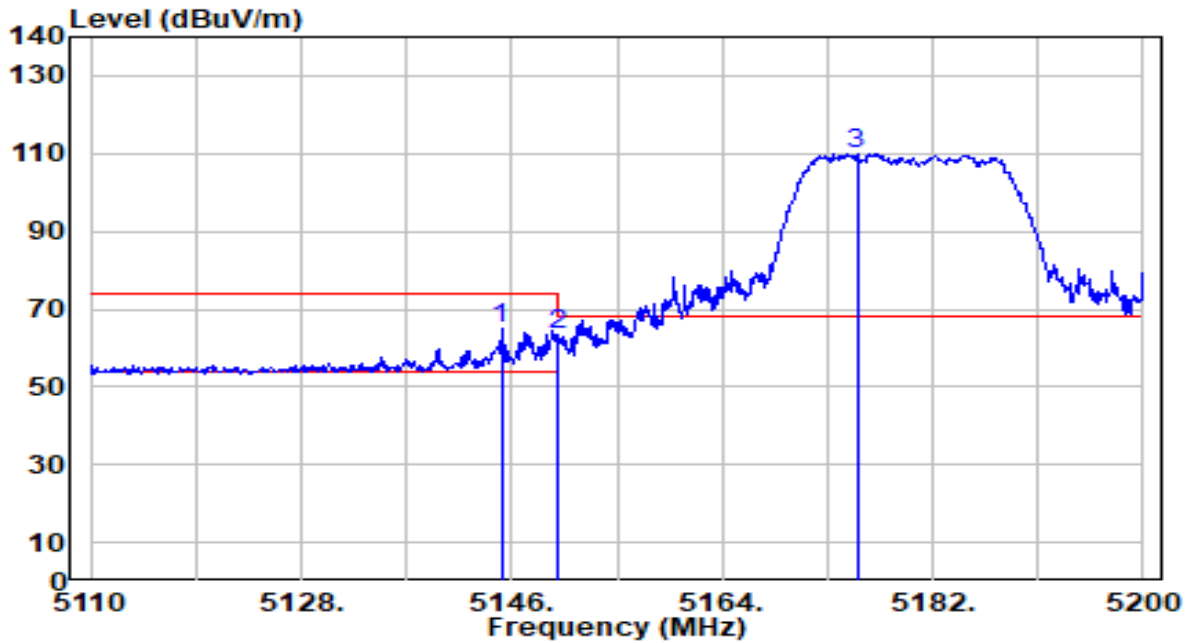

No	Frequency (MHz)	Reading (dBuV)	C.F (dB/m)	Measurement (dBuV/m)	Margin (dB)	Limit (dBuV/m)	Height (cm)	Angle (deg)	Remark (QP/PK/AV)	
1	*	5145.100	64.52	0.68	65.20	-8.80	74.00	273	145	Peak
2		5150.000	62.87	0.68	63.55	-10.45	74.00	273	145	Peak
3		5175.520	109.14	0.67	109.81	N/A	N/A	273	145	Peak

Note:

1. " *", means this data is the worst emission level.
2. C.F (Correction Factor) = Antenna Factor (dB/m)+ Cable Loss (dB) – Preamplifier(dB) + 10dB Attenuation.
3. Measurement (dBuV/m) = Reading(dBuV) + C.F (Correction Factor).
4. The emission levels of other frequencies are very lower than the limit and not show in test report.

EUT	BE3600 Dual-Band Wi-Fi 7 Router	Date of Test	2024-02-06
Factor	DRH18-E	Temp. / Humidity	20°C /65%
Polarity	Horizontal	Site / Test Engineer	AC2 / Stanley
Test Mode	802.11ac-20MHz_TX_Band1_CH 36_ANT 0+1	Test Voltage	AC 120V/60Hz

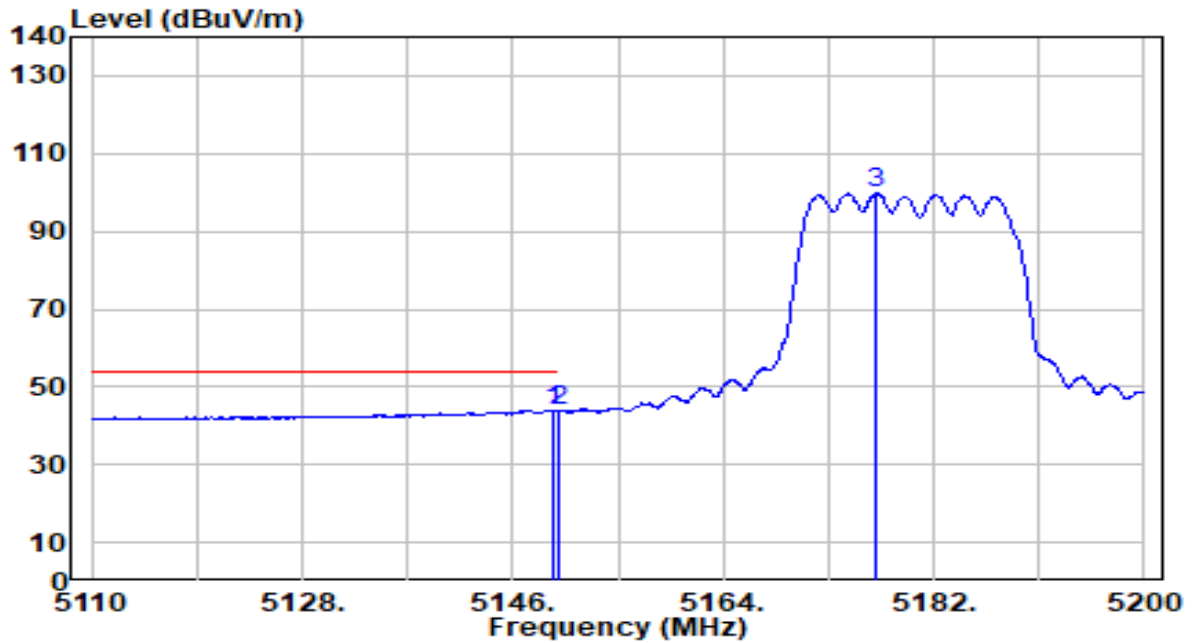

No	Frequency (MHz)	Reading (dBuV)	C.F (dB/m)	Measurement (dBuV/m)	Margin (dB)	Limit (dBuV/m)	Height (cm)	Angle (deg)	Remark (QP/PK/AV)	
1	*	5149.420	43.41	0.68	44.09	-9.91	54.00	273	145	Average
2		5150.000	43.22	0.68	43.89	-10.11	54.00	273	145	Average
3		5177.140	99.13	0.67	99.80	N/A	N/A	273	145	Average

Note:

1. " *", means this data is the worst emission level.
2. C.F (Correction Factor) = Antenna Factor (dB/m)+ Cable Loss (dB) – Preamplifier(dB) + 10dB Attenuation.
3. Measurement (dBuV/m) = Reading(dBuV) + C.F (Correction Factor).
4. The emission levels of other frequencies are very lower than the limit and not show in test report.

EUT	BE3600 Dual-Band Wi-Fi 7 Router	Date of Test	2024-02-06
Factor	DRH18-E	Temp. / Humidity	20°C /65%
Polarity	Vertical	Site / Test Engineer	AC2 / Stanley
Test Mode	802.11ac-20MHz_TX_Band1_CH 36_ANT 0+1	Test Voltage	AC 120V/60Hz

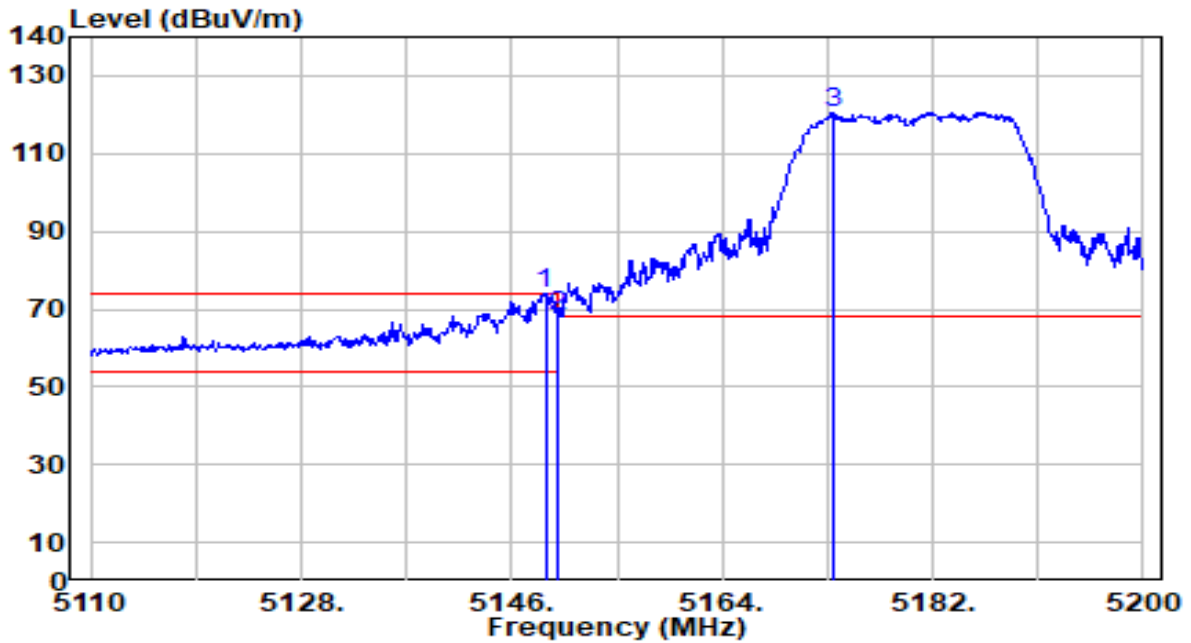

No	Frequency (MHz)	Reading (dBuV)	C.F (dB/m)	Measurement (dBuV/m)	Margin (dB)	Limit (dBuV/m)	Height (cm)	Angle (deg)	Remark (QP/PK/AV)
1	* 5148.880	73.18	0.68	73.85	-0.15	74.00	139	72	Peak
2	5150.000	67.50	0.68	68.17	-5.83	74.00	139	72	Peak
3	5173.540	120.01	0.67	120.68	N/A	N/A	139	72	Peak

Note:

1. " *", means this data is the worst emission level.
2. C.F (Correction Factor) = Antenna Factor (dB/m)+ Cable Loss (dB) – Preamplifier(dB) + 10dB Attenuation.
3. Measurement (dBuV/m) = Reading(dBuV) + C.F (Correction Factor).
4. The emission levels of other frequencies are very lower than the limit and not show in test report.

EUT	BE3600 Dual-Band Wi-Fi 7 Router	Date of Test	2024-02-06
Factor	DRH18-E	Temp. / Humidity	20°C /65%
Polarity	Vertical	Site / Test Engineer	AC2 / Stanley
Test Mode	802.11ac-20MHz_TX_Band1_CH 36_ANT 0+1	Test Voltage	AC 120V/60Hz

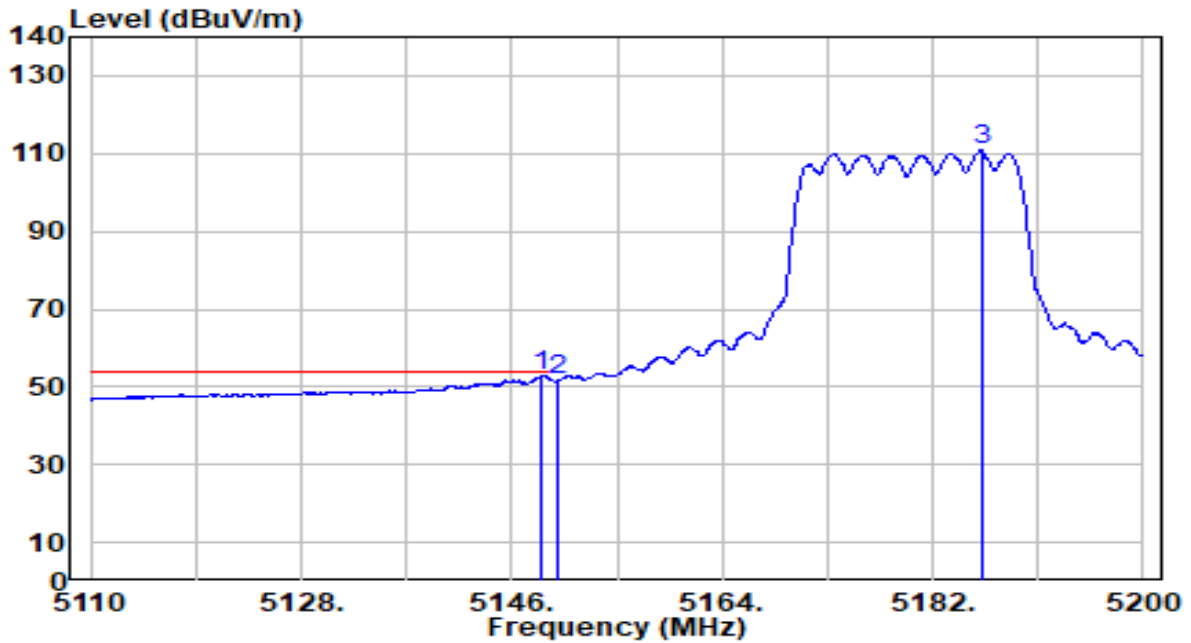

No	Frequency (MHz)	Reading (dBuV)	C.F (dB/m)	Measurement (dBuV/m)	Margin (dB)	Limit (dBuV/m)	Height (cm)	Angle (deg)	Remark (QP/PK/AV)
1	*	52.23	0.68	52.90	-1.10	54.00	139	72	Average
2		50.87	0.68	51.54	-2.46	54.00	139	72	Average
3		110.05	0.67	110.72	N/A	N/A	139	72	Average

Note:

1. " *", means this data is the worst emission level.
2. C.F (Correction Factor) = Antenna Factor (dB/m)+ Cable Loss (dB) – Preamplifier(dB) + 10dB Attenuation.
3. Measurement (dBuV/m) = Reading(dBuV) + C.F (Correction Factor).
4. The emission levels of other frequencies are very lower than the limit and not show in test report.

EUT	BE3600 Dual-Band Wi-Fi 7 Router	Date of Test	2024-02-06
Factor	DRH18-E	Temp. / Humidity	20°C /65%
Polarity	Horizontal	Site / Test Engineer	AC2 / Stanley
Test Mode	802.11ac-20MHz_TX_Band2_CH 64_ANT 0+1	Test Voltage	AC 120V/60Hz

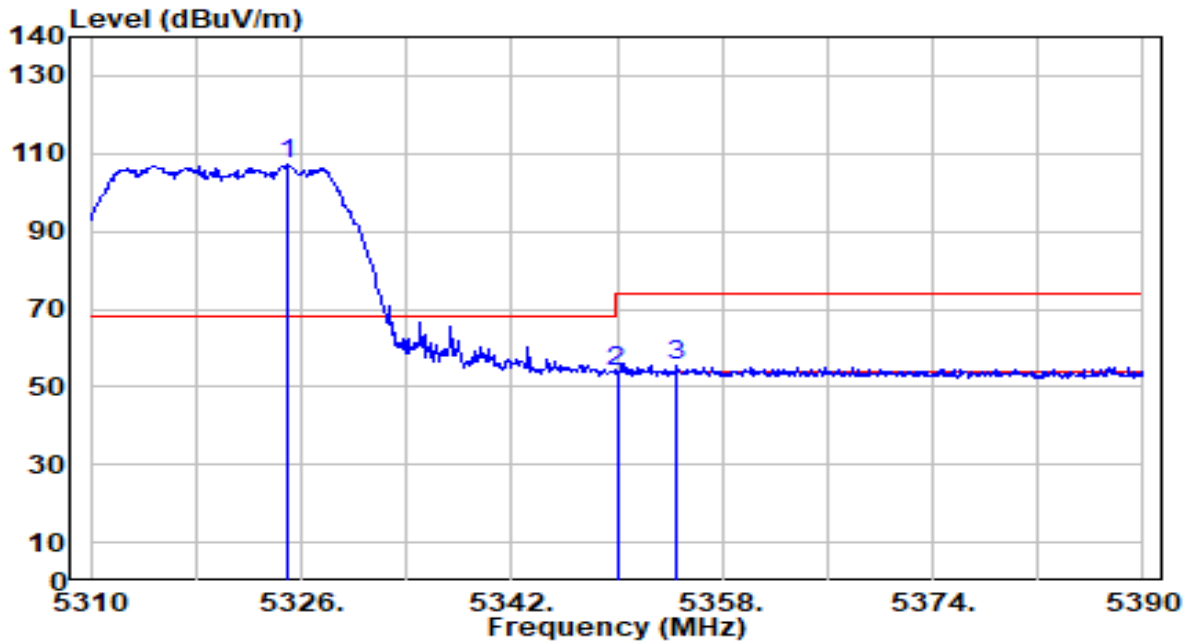

No	Frequency (MHz)	Reading (dBuV)	C.F (dB/m)	Measurement (dBuV/m)	Margin (dB)	Limit (dBuV/m)	Height (cm)	Angle (deg)	Remark (QP/PK/AV)
1	5324.880	106.51	0.53	107.04	N/A	N/A	296	147	Peak
2	5350.000	53.48	0.51	53.99	-20.01	74.00	296	147	Peak
3	* 5354.560	54.91	0.50	55.41	-18.59	74.00	296	147	Peak

Note:

1. " *", means this data is the worst emission level.
2. C.F (Correction Factor) = Antenna Factor (dB/m)+ Cable Loss (dB) – Preamplifier(dB) + 10dB Attenuation.
3. Measurement (dBuV/m) = Reading(dBuV) + C.F (Correction Factor).
4. The emission levels of other frequencies are very lower than the limit and not show in test report.

EUT	BE3600 Dual-Band Wi-Fi 7 Router	Date of Test	2024-02-06
Factor	DRH18-E	Temp. / Humidity	20°C /65%
Polarity	Horizontal	Site / Test Engineer	AC2 / Stanley
Test Mode	802.11ac-20MHz_TX_Band2_CH 64_ANT 0+1	Test Voltage	AC 120V/60Hz

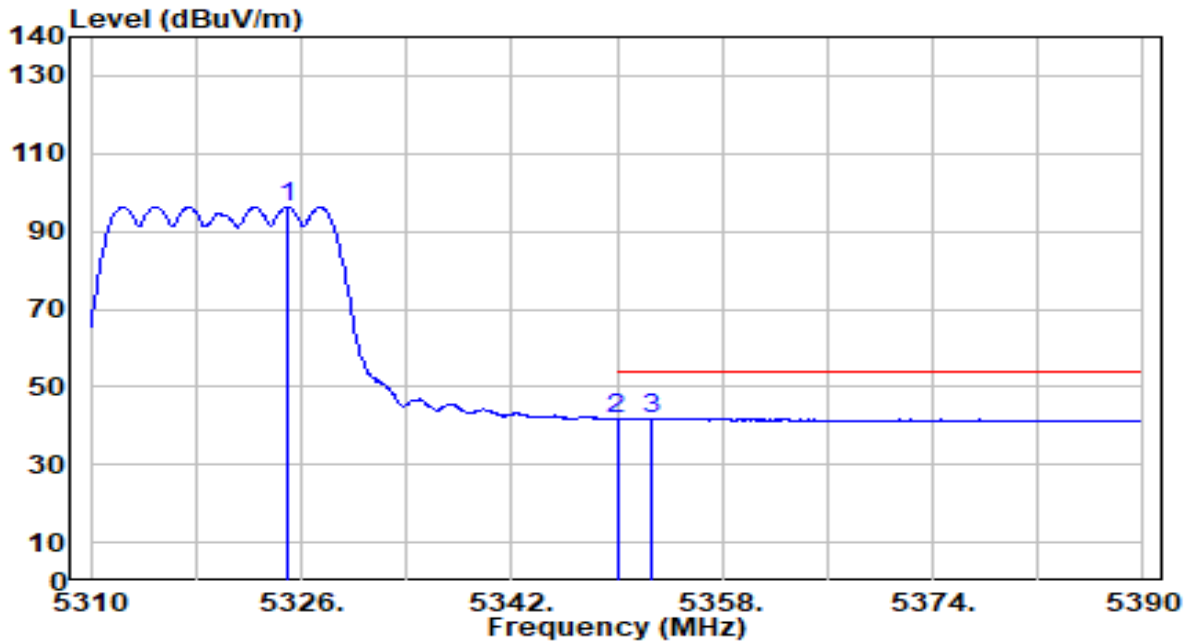

No	Frequency (MHz)	Reading (dBuV)	C.F (dB/m)	Measurement (dBuV/m)	Margin (dB)	Limit (dBuV/m)	Height (cm)	Angle (deg)	Remark (QP/PK/AV)
1	5325.040	95.83	0.53	96.36	N/A	N/A	296	147	Average
2	* 5350.000	41.45	0.51	41.95	-12.05	54.00	296	147	Average
3	5352.640	41.44	0.50	41.94	-12.06	54.00	296	147	Average

Note:

1. " *", means this data is the worst emission level.
2. C.F (Correction Factor) = Antenna Factor (dB/m)+ Cable Loss (dB) – Preamplifier(dB) + 10dB Attenuation.
3. Measurement (dBuV/m) = Reading(dBuV) + C.F (Correction Factor).
4. The emission levels of other frequencies are very lower than the limit and not show in test report.

EUT	BE3600 Dual-Band Wi-Fi 7 Router	Date of Test	2024-02-06
Factor	DRH18-E	Temp. / Humidity	20°C /65%
Polarity	Vertical	Site / Test Engineer	AC2 / Stanley
Test Mode	802.11ac-20MHz_TX_Band2_CH 64_ANT 0+1	Test Voltage	AC 120V/60Hz

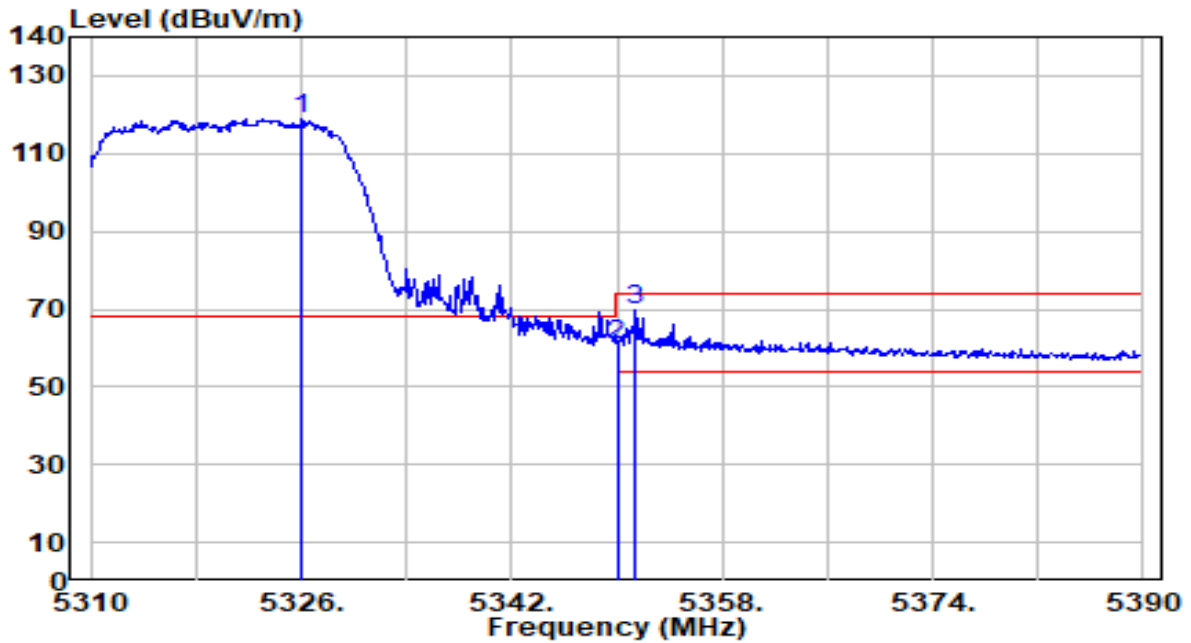

No	Frequency (MHz)	Reading (dBuV)	C.F (dB/m)	Measurement (dBuV/m)	Margin (dB)	Limit (dBuV/m)	Height (cm)	Angle (deg)	Remark (QP/PK/AV)
1	5326.080	118.40	0.53	118.93	N/A	N/A	122	38	Peak
2	5350.000	60.38	0.51	60.88	-13.12	74.00	122	38	Peak
3	* 5351.440	69.11	0.50	69.61	-4.39	74.00	122	38	Peak

Note:

1. " *", means this data is the worst emission level.
2. C.F (Correction Factor) = Antenna Factor (dB/m)+ Cable Loss (dB) – Preamplifier(dB) + 10dB Attenuation.
3. Measurement (dBuV/m) = Reading(dBuV) + C.F (Correction Factor).
4. The emission levels of other frequencies are very lower than the limit and not show in test report.

EUT	BE3600 Dual-Band Wi-Fi 7 Router	Date of Test	2024-02-06
Factor	DRH18-E	Temp. / Humidity	20°C /65%
Polarity	Vertical	Site / Test Engineer	AC2 / Stanley
Test Mode	802.11ac-20MHz_TX_Band2_CH 64_ANT 0+1	Test Voltage	AC 120V/60Hz

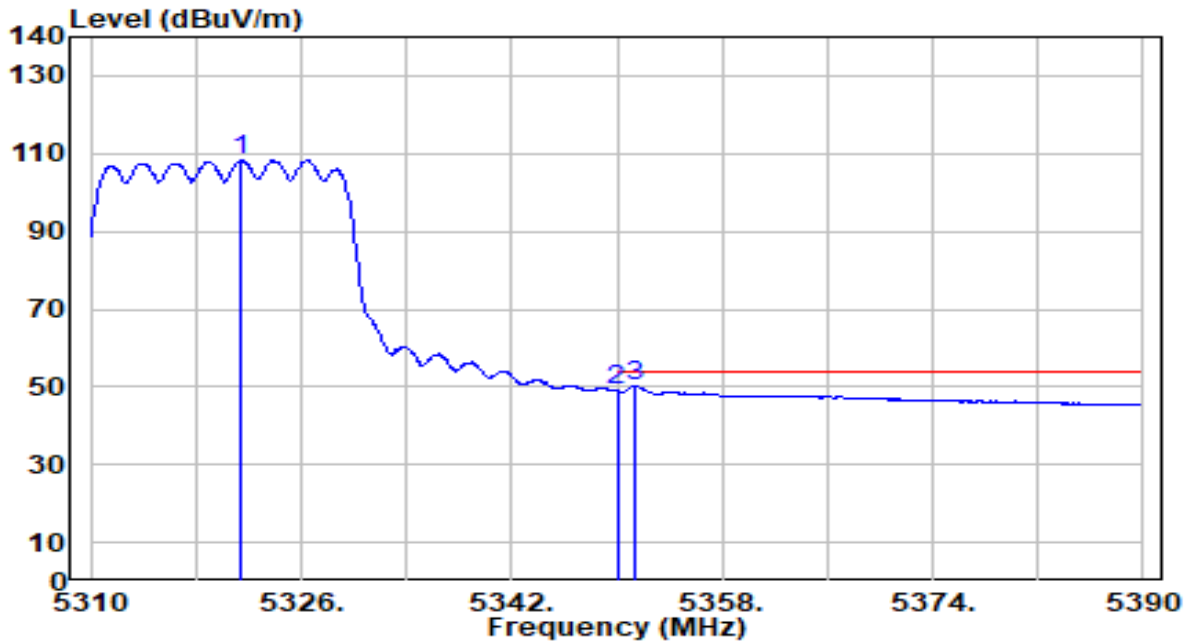

No	Frequency (MHz)	Reading (dBuV)	C.F (dB/m)	Measurement (dBuV/m)	Margin (dB)	Limit (dBuV/m)	Height (cm)	Angle (deg)	Remark (QP/PK/AV)
1	5321.360	107.62	0.54	108.16	N/A	N/A	122	38	Average
2	5350.000	48.58	0.51	49.09	-4.91	54.00	122	38	Average
3	* 5351.360	49.59	0.50	50.10	-3.90	54.00	122	38	Average

Note:

1. " *", means this data is the worst emission level.
2. C.F (Correction Factor) = Antenna Factor (dB/m)+ Cable Loss (dB) – Preamplifier(dB) + 10dB Attenuation.
3. Measurement (dBuV/m) = Reading(dBuV) + C.F (Correction Factor).
4. The emission levels of other frequencies are very lower than the limit and not show in test report.

EUT	BE3600 Dual-Band Wi-Fi 7 Router	Date of Test	2024-02-06
Factor	DRH18-E	Temp. / Humidity	20°C /65%
Polarity	Horizontal	Site / Test Engineer	AC2 / Stanley
Test Mode	802.11ac-20MHz_TX_Band3_CH 100_ANT 0+1	Test Voltage	AC 120V/60Hz

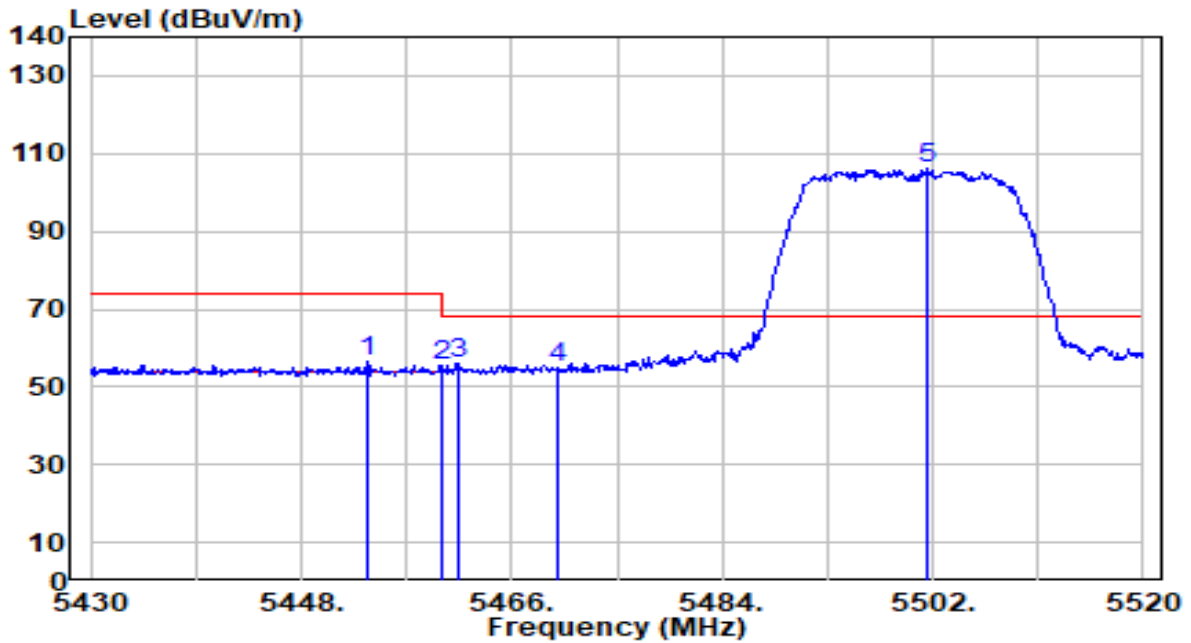

No	Frequency (MHz)	Reading (dBuV)	C.F (dB/m)	Measurement (dBuV/m)	Margin (dB)	Limit (dBuV/m)	Height (cm)	Angle (deg)	Remark (QP/PK/AV)
1	5453.670	55.71	0.63	56.34	-17.66	74.00	102	224	Peak
2	5460.000	54.92	0.65	55.57	-18.43	74.00	102	224	Peak
3	* 5461.410	55.17	0.66	55.83	-12.37	68.20	102	224	Peak
4	5470.000	54.01	0.69	54.70	-13.50	68.20	102	224	Peak
5	5501.640	105.23	0.80	106.03	N/A	N/A	102	224	Peak

Note:

1. " *", means this data is the worst emission level.
2. C.F (Correction Factor) = Antenna Factor (dB/m)+ Cable Loss (dB) – Preamplifier(dB) + 10dB Attenuation.
3. Measurement (dBuV/m) = Reading(dBuV) + C.F (Correction Factor).
4. The emission levels of other frequencies are very lower than the limit and not show in test report.

EUT	BE3600 Dual-Band Wi-Fi 7 Router	Date of Test	2024-02-06
Factor	DRH18-E	Temp. / Humidity	20°C /65%
Polarity	Horizontal	Site / Test Engineer	AC2 / Stanley
Test Mode	802.11ac-20MHz_TX_Band3_CH 100_ANT 0+1	Test Voltage	AC 120V/60Hz

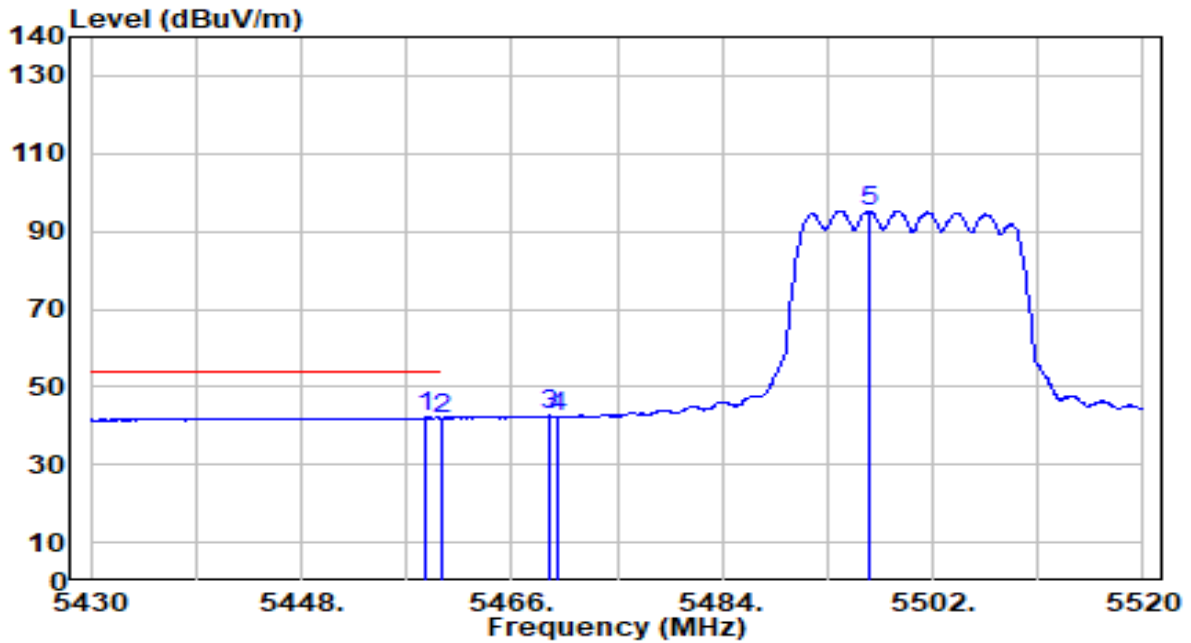

No	Frequency (MHz)	Reading (dBuV)	C.F (dB/m)	Measurement (dBuV/m)	Margin (dB)	Limit (dBuV/m)	Height (cm)	Angle (deg)	Remark (QP/PK/AV)
1	* 5458.710	41.53	0.65	42.18	-11.82	54.00	102	224	Average
2	5460.000	41.32	0.65	41.98	-12.02	54.00	102	224	Average
3	5469.150	41.95	0.69	42.63	N/A	N/A	102	224	Average
4	5470.000	41.51	0.69	42.20	N/A	N/A	102	224	Average
5	5496.510	94.58	0.78	95.35	N/A	N/A	102	224	Average

Note:

1. " *", means this data is the worst emission level.
2. C.F (Correction Factor) = Antenna Factor (dB/m)+ Cable Loss (dB) – Preamplifier(dB) + 10dB Attenuation.
3. Measurement (dBuV/m) = Reading(dBuV) + C.F (Correction Factor).
4. The emission levels of other frequencies are very lower than the limit and not show in test report.

EUT	BE3600 Dual-Band Wi-Fi 7 Router	Date of Test	2024-02-06
Factor	DRH18-E	Temp. / Humidity	20°C /65%
Polarity	Vertical	Site / Test Engineer	AC2 / Stanley
Test Mode	802.11ac-20MHz_TX_Band3_CH 100_ANT 0+1	Test Voltage	AC 120V/60Hz

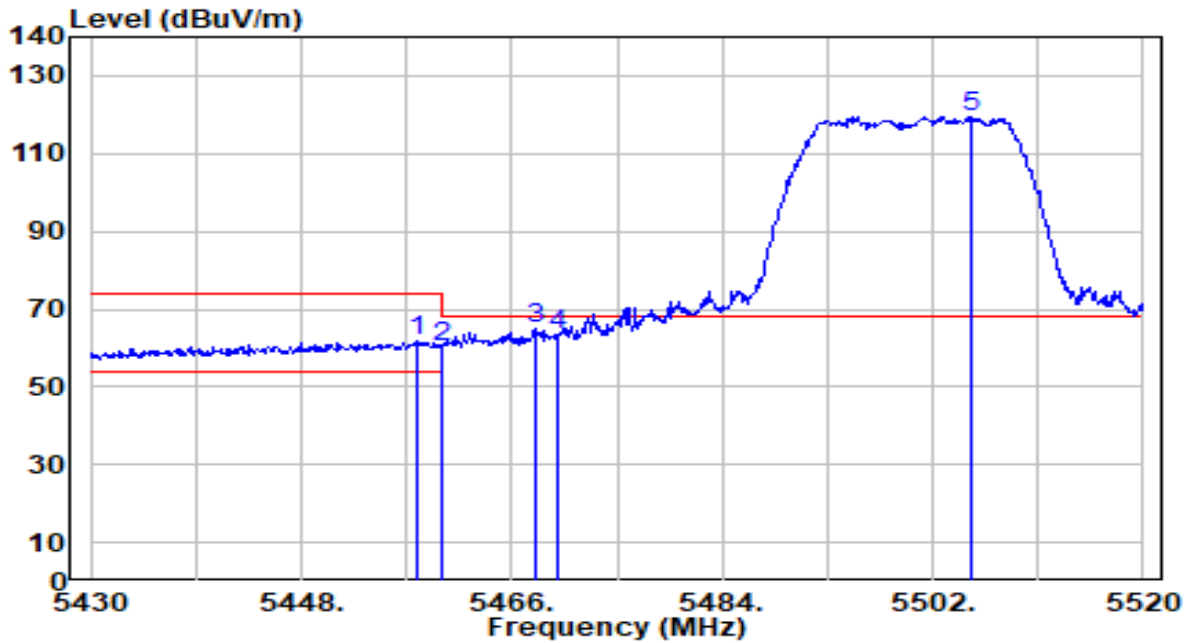

No	Frequency (MHz)	Reading (dBuV)	C.F (dB/m)	Measurement (dBuV/m)	Margin (dB)	Limit (dBuV/m)	Height (cm)	Angle (deg)	Remark (QP/PK/AV)
1	5457.990	60.92	0.65	61.57	-12.43	74.00	140	28	Peak
2	5460.000	59.78	0.65	60.43	-13.57	74.00	140	28	Peak
3	* 5467.980	64.33	0.68	65.01	-3.19	68.20	140	28	Peak
4	5470.000	62.49	0.69	63.18	-5.02	68.20	140	28	Peak
5	5505.330	118.61	0.81	119.42	N/A	N/A	140	28	Peak

Note:

1. " *", means this data is the worst emission level.
2. C.F (Correction Factor) = Antenna Factor (dB/m)+ Cable Loss (dB) – Preamplifier(dB) + 10dB Attenuation.
3. Measurement (dBuV/m) = Reading(dBuV) + C.F (Correction Factor).
4. The emission levels of other frequencies are very lower than the limit and not show in test report.

EUT	BE3600 Dual-Band Wi-Fi 7 Router	Date of Test	2024-02-06
Factor	DRH18-E	Temp. / Humidity	20°C /65%
Polarity	Vertical	Site / Test Engineer	AC2 / Stanley
Test Mode	802.11ac-20MHz_TX_Band3_CH 100_ANT 0+1	Test Voltage	AC 120V/60Hz

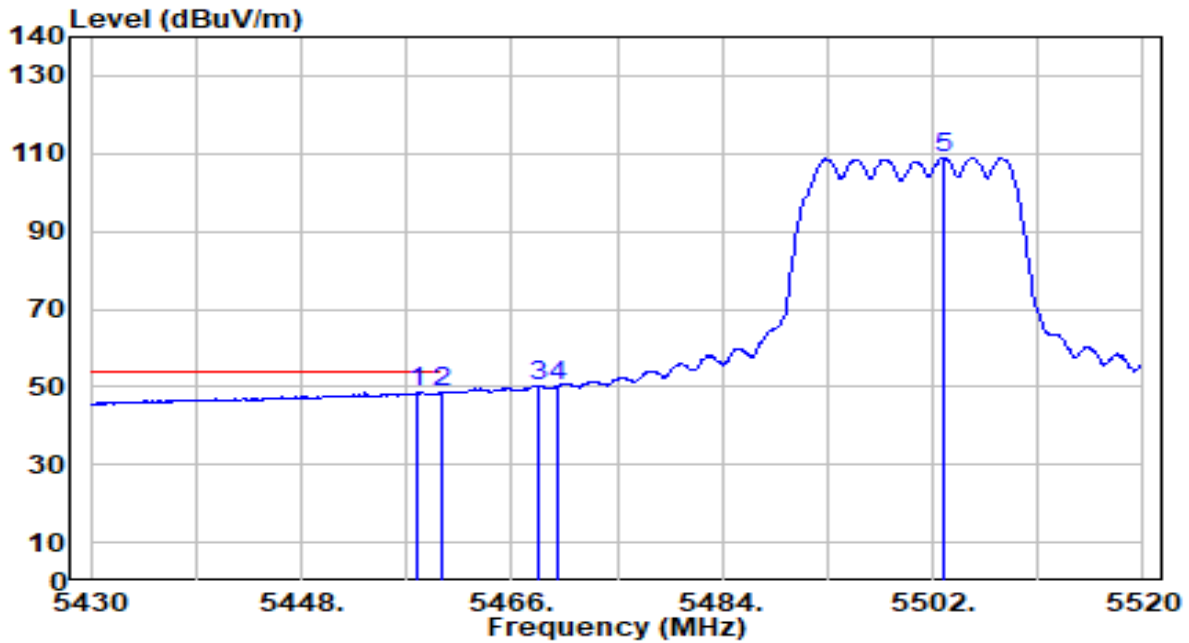

No	Frequency (MHz)	Reading (dBuV)	C.F (dB/m)	Measurement (dBuV/m)	Margin (dB)	Limit (dBuV/m)	Height (cm)	Angle (deg)	Remark (QP/PK/AV)
1	5457.900	47.78	0.65	48.42	-5.58	54.00	140	28	Average
2	* 5460.000	47.77	0.65	48.43	-5.57	54.00	140	28	Average
3	5468.250	49.64	0.68	50.32	N/A	N/A	140	28	Average
4	5470.000	49.47	0.69	50.16	N/A	N/A	140	28	Average
5	5502.990	108.23	0.80	109.03	N/A	N/A	140	28	Average

Note:

1. " *", means this data is the worst emission level.
2. C.F (Correction Factor) = Antenna Factor (dB/m)+ Cable Loss (dB) – Preamplifier(dB) + 10dB Attenuation.
3. Measurement (dBuV/m) = Reading(dBuV) + C.F (Correction Factor).
4. The emission levels of other frequencies are very lower than the limit and not show in test report.

EUT	BE3600 Dual-Band Wi-Fi 7 Router	Date of Test	2024-02-06
Factor	DRH18-E	Temp. / Humidity	20°C /65%
Polarity	Horizontal	Site / Test Engineer	AC2 / Stanley
Test Mode	802.11ac-20MHz_TX_Band3_CH 140_ANT 0+1	Test Voltage	AC 120V/60Hz

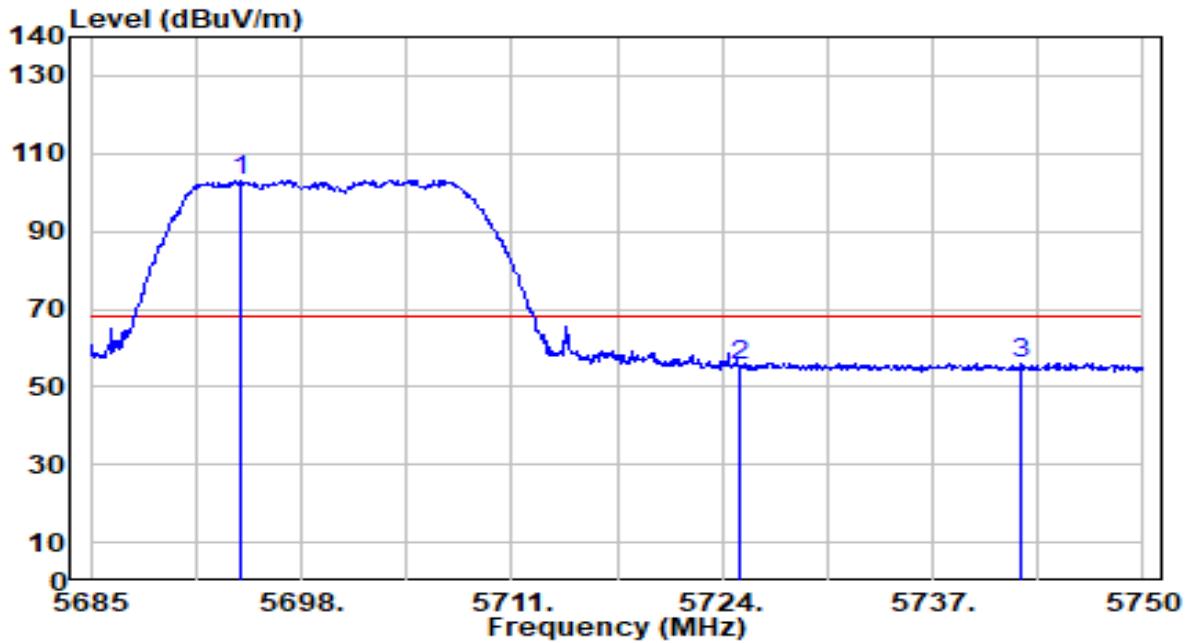

No	Frequency (MHz)	Reading (dBuV)	C.F (dB/m)	Measurement (dBuV/m)	Margin (dB)	Limit (dBuV/m)	Height (cm)	Angle (deg)	Remark (QP/PK/AV)
1	5694.295	101.49	1.69	103.18	N/A	N/A	102	223	Peak
2	5725.000	53.46	1.86	55.32	-12.88	68.20	102	223	Peak
3	* 5742.395	54.24	1.96	56.20	-12.00	68.20	102	223	Peak

Note:

1. " *", means this data is the worst emission level.
2. C.F (Correction Factor) = Antenna Factor (dB/m)+ Cable Loss (dB) – Preamplifier(dB) + 10dB Attenuation.
3. Measurement (dBuV/m) = Reading(dBuV) + C.F (Correction Factor).
4. The emission levels of other frequencies are very lower than the limit and not show in test report.

EUT	BE3600 Dual-Band Wi-Fi 7 Router	Date of Test	2024-02-06
Factor	DRH18-E	Temp. / Humidity	20°C /65%
Polarity	Vertical	Site / Test Engineer	AC2 / Stanley
Test Mode	802.11ac-20MHz_TX_Band3_CH 140_ANT 0+1	Test Voltage	AC 120V/60Hz

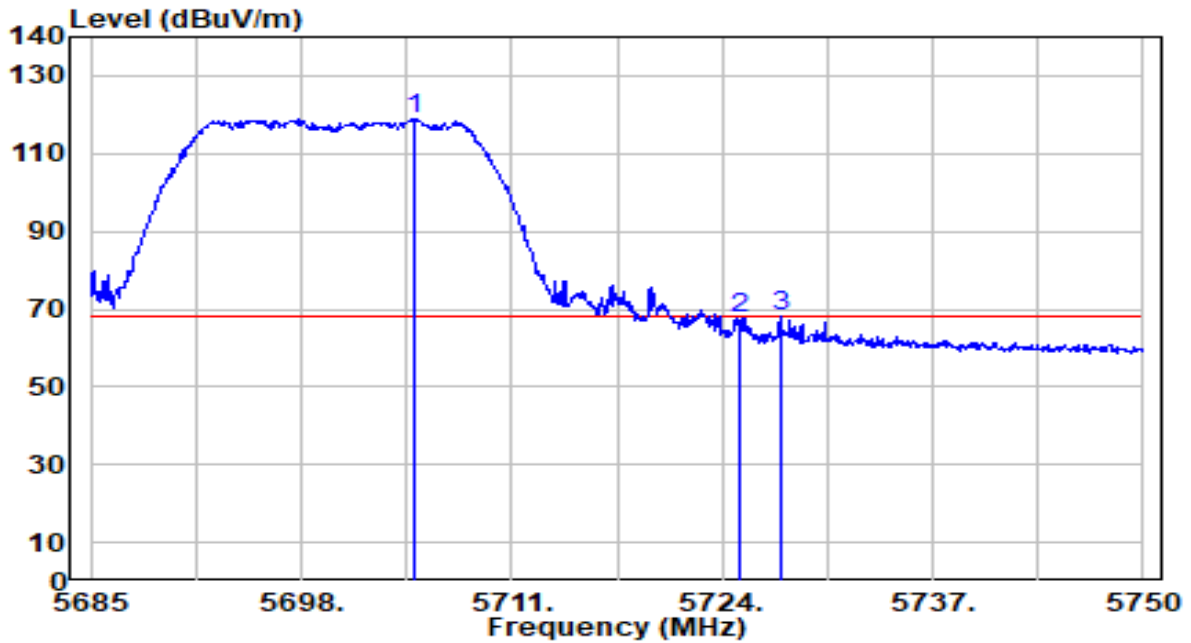

No	Frequency (MHz)	Reading (dBuV)	C.F (dB/m)	Measurement (dBuV/m)	Margin (dB)	Limit (dBuV/m)	Height (cm)	Angle (deg)	Remark (QP/PK/AV)
1	5705.020	117.10	1.75	118.85	N/A	N/A	136	31	Peak
2	5725.000	65.79	1.86	67.65	-0.55	68.20	136	31	Peak
3	* 5727.640	66.11	1.88	67.99	-0.21	68.20	136	31	Peak

Note:

1. " *", means this data is the worst emission level.
2. C.F (Correction Factor) = Antenna Factor (dB/m)+ Cable Loss (dB) – Preamplifier(dB) + 10dB Attenuation.
3. Measurement (dBuV/m) = Reading(dBuV) + C.F (Correction Factor).
4. The emission levels of other frequencies are very lower than the limit and not show in test report.

EUT	BE3600 Dual-Band Wi-Fi 7 Router	Date of Test	2024-02-06
Factor	DRH18-E	Temp. / Humidity	20°C /65%
Polarity	Horizontal	Site / Test Engineer	AC2 / Stanley
Test Mode	802.11ac-20MHz_TX_Band4_CH 149_ANT 0+1	Test Voltage	AC 120V/60Hz

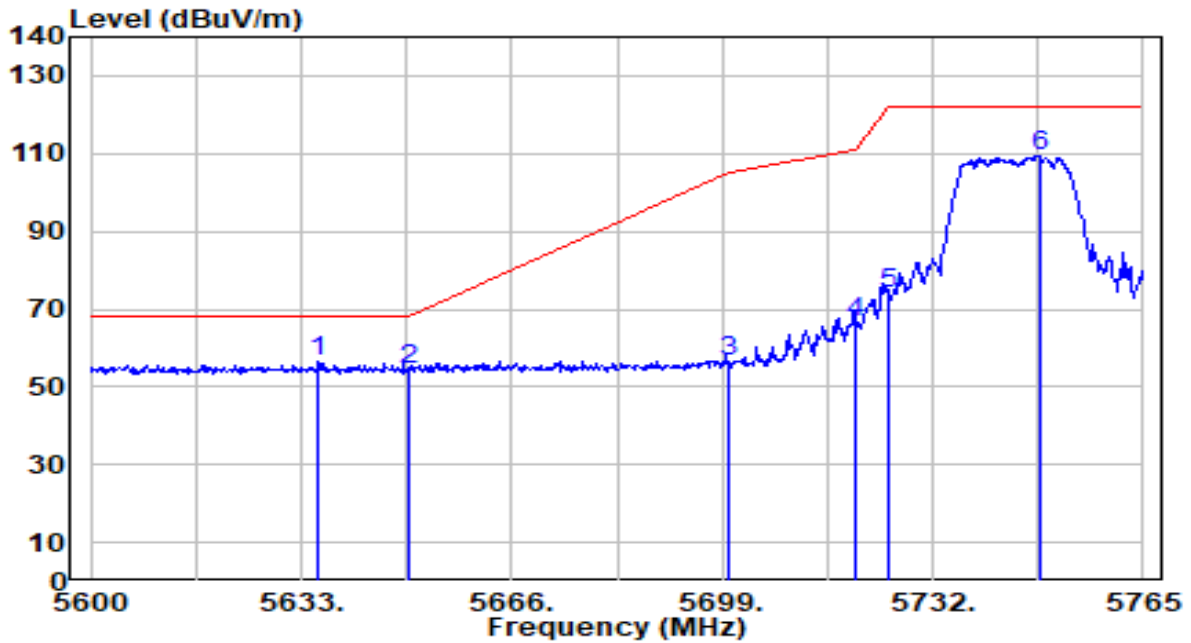

No	Frequency (MHz)	Reading (dBuV)	C.F (dB/m)	Measurement (dBuV/m)	Margin (dB)	Limit (dBuV/m)	Height (cm)	Angle (deg)	Remark (QP/PK/AV)
1	* 5635.805	54.98	1.36	56.34	-11.86	68.20	100	140	Peak
2	5650.000	52.92	1.44	54.36	-13.84	68.20	100	140	Peak
3	5700.000	54.61	1.72	56.33	-48.87	105.20	100	140	Peak
4	5720.000	64.80	1.84	66.64	-44.16	110.80	100	140	Peak
5	5725.000	72.28	1.86	74.14	-48.06	122.20	100	140	Peak
6	5748.665	107.38	2.00	109.38	N/A	N/A	100	140	Peak

Note:

1. " *", means this data is the worst emission level.
2. C.F (Correction Factor) = Antenna Factor (dB/m)+ Cable Loss (dB) – Preamplifier(dB) + 10dB Attenuation.
3. Measurement (dBuV/m) = Reading(dBuV) + C.F (Correction Factor).
4. The emission levels of other frequencies are very lower than the limit and not show in test report.

EUT	BE3600 Dual-Band Wi-Fi 7 Router	Date of Test	2024-02-06
Factor	DRH18-E	Temp. / Humidity	20°C /65%
Polarity	Vertical	Site / Test Engineer	AC2 / Stanley
Test Mode	802.11ac-20MHz_TX_Band4_CH 149_ANT 0+1	Test Voltage	AC 120V/60Hz

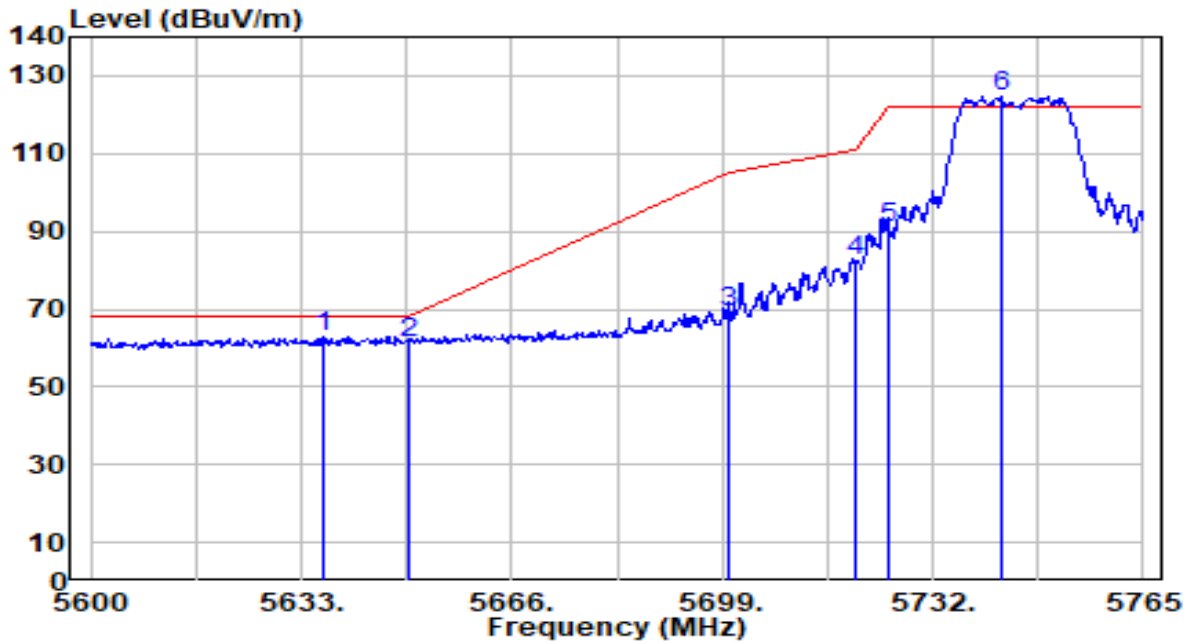

No	Frequency (MHz)	Reading (dBuV)	C.F (dB/m)	Measurement (dBuV/m)	Margin (dB)	Limit (dBuV/m)	Height (cm)	Angle (deg)	Remark (QP/PK/AV)
1	* 5636.300	61.64	1.36	63.00	-5.20	68.20	137	35	Peak
2	5650.000	60.08	1.44	61.51	-6.69	68.20	137	35	Peak
3	5700.000	67.54	1.72	69.26	-35.94	105.20	137	35	Peak
4	5720.000	80.36	1.84	82.19	-28.61	110.80	137	35	Peak
5	5725.000	89.06	1.86	90.92	-31.28	122.20	137	35	Peak
6	5742.725	122.60	1.96	124.56	N/A	N/A	137	35	Peak

Note:

1. " *", means this data is the worst emission level.
2. C.F (Correction Factor) = Antenna Factor (dB/m)+ Cable Loss (dB) – Preamplifier(dB) + 10dB Attenuation.
3. Measurement (dBuV/m) = Reading(dBuV) + C.F (Correction Factor).
4. The emission levels of other frequencies are very lower than the limit and not show in test report.

EUT	BE3600 Dual-Band Wi-Fi 7 Router	Date of Test	2024-02-06
Factor	DRH18-E	Temp. / Humidity	20°C /65%
Polarity	Horizontal	Site / Test Engineer	AC2 / Stanley
Test Mode	802.11ac-20MHz_TX_Band4_CH 165_ANT 0+1	Test Voltage	AC 120V/60Hz

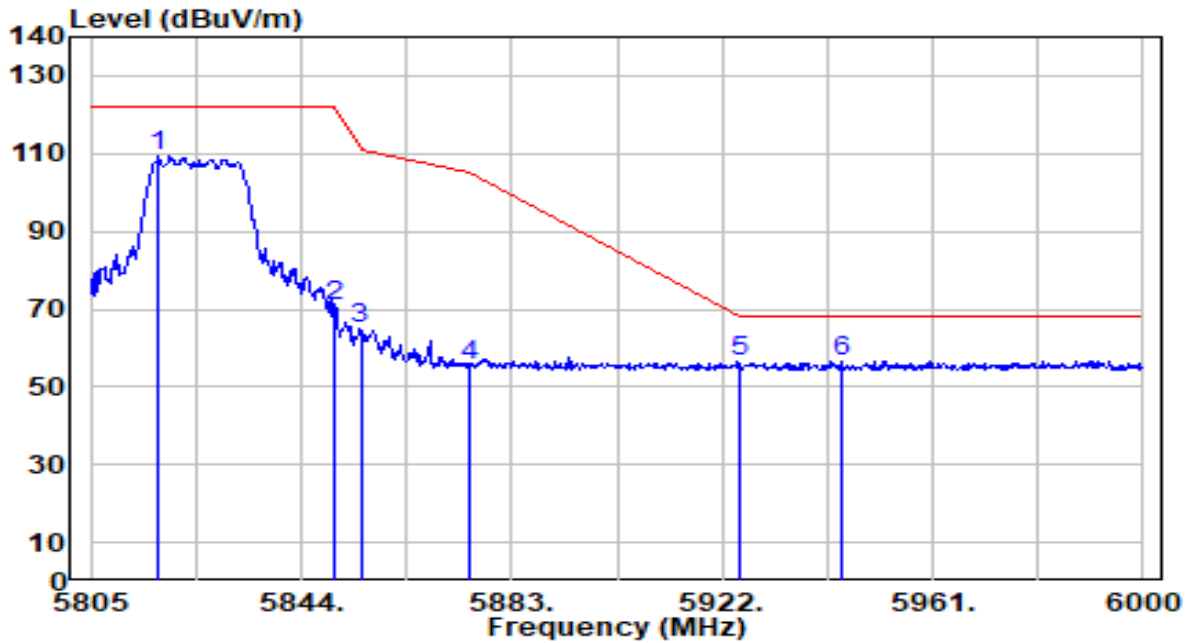

No	Frequency (MHz)	Reading (dBUV)	C.F (dB/m)	Measurement (dBUV/m)	Margin (dB)	Limit (dBUV/m)	Height (cm)	Angle (deg)	Remark (QP/PK/AV)
1	5817.675	106.83	2.28	109.11	N/A	N/A	100	142	Peak
2	5850.000	68.63	2.27	70.90	-51.30	122.20	100	142	Peak
3	5855.000	62.80	2.27	65.07	-45.73	110.80	100	142	Peak
4	5875.000	53.00	2.26	55.27	-49.93	105.20	100	142	Peak
5	5925.000	54.19	2.25	56.43	-11.77	68.20	100	142	Peak
6	* 5944.230	54.44	2.24	56.68	-11.52	68.20	100	142	Peak

Note:

1. " *", means this data is the worst emission level.
2. C.F (Correction Factor) = Antenna Factor (dB/m)+ Cable Loss (dB) – Preamplifier(dB) + 10dB Attenuation.
3. Measurement (dBUV/m) = Reading(dBUV) + C.F (Correction Factor).
4. The emission levels of other frequencies are very lower than the limit and not show in test report.

EUT	BE3600 Dual-Band Wi-Fi 7 Router	Date of Test	2024-02-06
Factor	DRH18-E	Temp. / Humidity	20°C /65%
Polarity	Vertical	Site / Test Engineer	AC2 / Stanley
Test Mode	802.11ac-20MHz_TX_Band4_CH 165_ANT 0+1	Test Voltage	AC 120V/60Hz

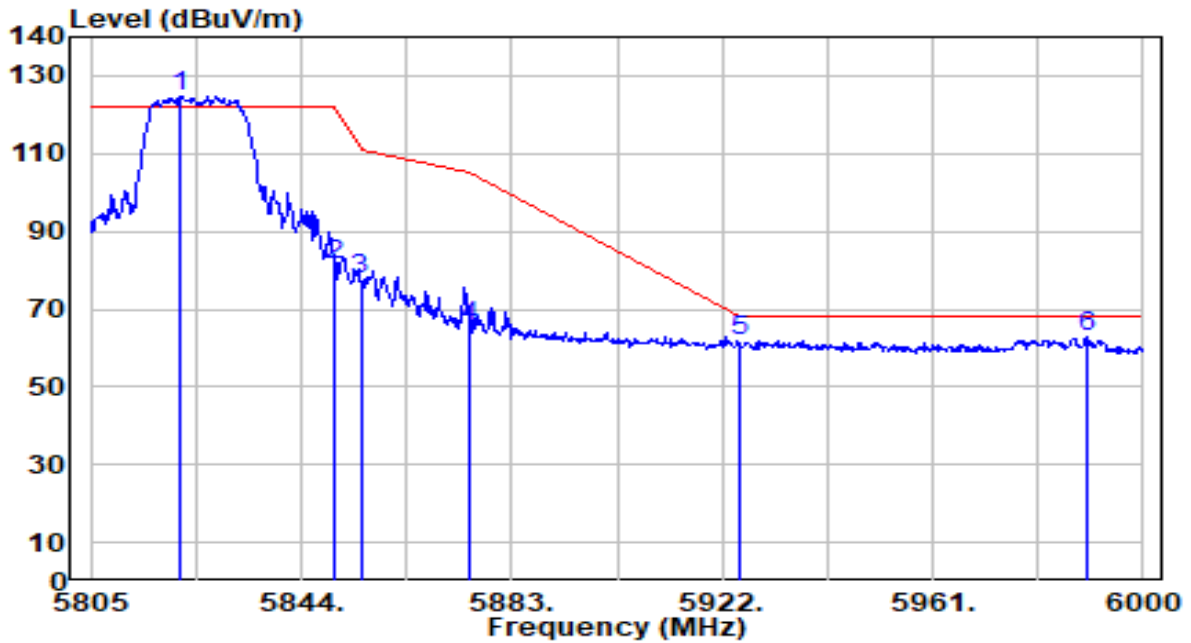

No	Frequency (MHz)	Reading (dBuV)	C.F (dB/m)	Measurement (dBuV/m)	Margin (dB)	Limit (dBuV/m)	Height (cm)	Angle (deg)	Remark (QP/PK/AV)
1	5821.770	122.49	2.28	124.77	N/A	N/A	154	320	Peak
2	5850.000	79.18	2.27	81.45	-40.75	122.20	154	320	Peak
3	5855.000	75.43	2.27	77.70	-33.10	110.80	154	320	Peak
4	5875.000	63.18	2.26	65.44	-39.76	105.20	154	320	Peak
5	5925.000	59.57	2.25	61.81	-6.39	68.20	154	320	Peak
6	* 5989.470	60.64	2.22	62.87	-5.33	68.20	154	320	Peak

Note:

1. " *", means this data is the worst emission level.
2. C.F (Correction Factor) = Antenna Factor (dB/m)+ Cable Loss (dB) – Preamplifier(dB) + 10dB Attenuation.
3. Measurement (dBuV/m) = Reading(dBuV) + C.F (Correction Factor).
4. The emission levels of other frequencies are very lower than the limit and not show in test report.

EUT	BE3600 Dual-Band Wi-Fi 7 Router	Date of Test	2024-02-06
Factor	DRH18-E	Temp. / Humidity	20°C /65%
Polarity	Horizontal	Site / Test Engineer	AC2 / Stanley
Test Mode	802.11ac-40MHz_TX_Band1_CH 38_ANT 0+1	Test Voltage	AC 120V/60Hz

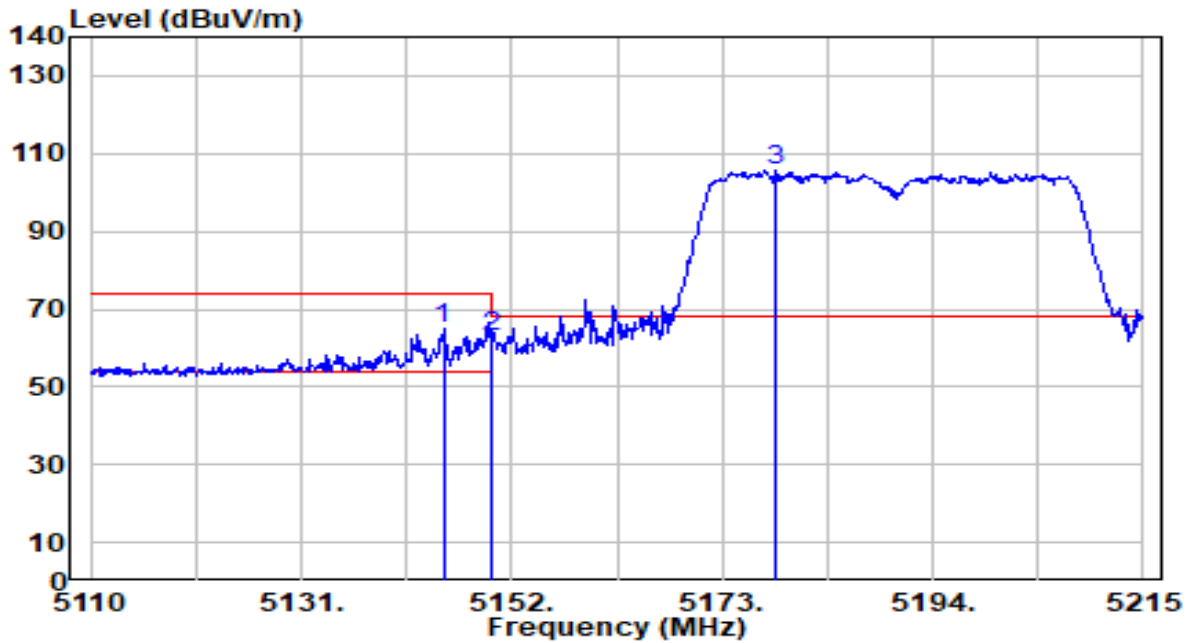

No	Frequency (MHz)	Reading (dBuV)	C.F (dB/m)	Measurement (dBuV/m)	Margin (dB)	Limit (dBuV/m)	Height (cm)	Angle (deg)	Remark (QP/PK/AV)	
1	*	5145.175	64.44	0.68	65.11	-8.89	74.00	273	145	Peak
2		5150.000	62.38	0.68	63.05	-10.95	74.00	273	145	Peak
3		5178.250	105.23	0.67	105.91	N/A	N/A	273	145	Peak

Note:

1. " *", means this data is the worst emission level.
2. C.F (Correction Factor) = Antenna Factor (dB/m)+ Cable Loss (dB) – Preamplifier(dB) + 10dB Attenuation.
3. Measurement (dBuV/m) = Reading(dBuV) + C.F (Correction Factor).
4. The emission levels of other frequencies are very lower than the limit and not show in test report.

EUT	BE3600 Dual-Band Wi-Fi 7 Router	Date of Test	2024-02-06
Factor	DRH18-E	Temp. / Humidity	20°C /65%
Polarity	Horizontal	Site / Test Engineer	AC2 / Stanley
Test Mode	802.11ac-40MHz_TX_Band1_CH 38_ANT 0+1	Test Voltage	AC 120V/60Hz

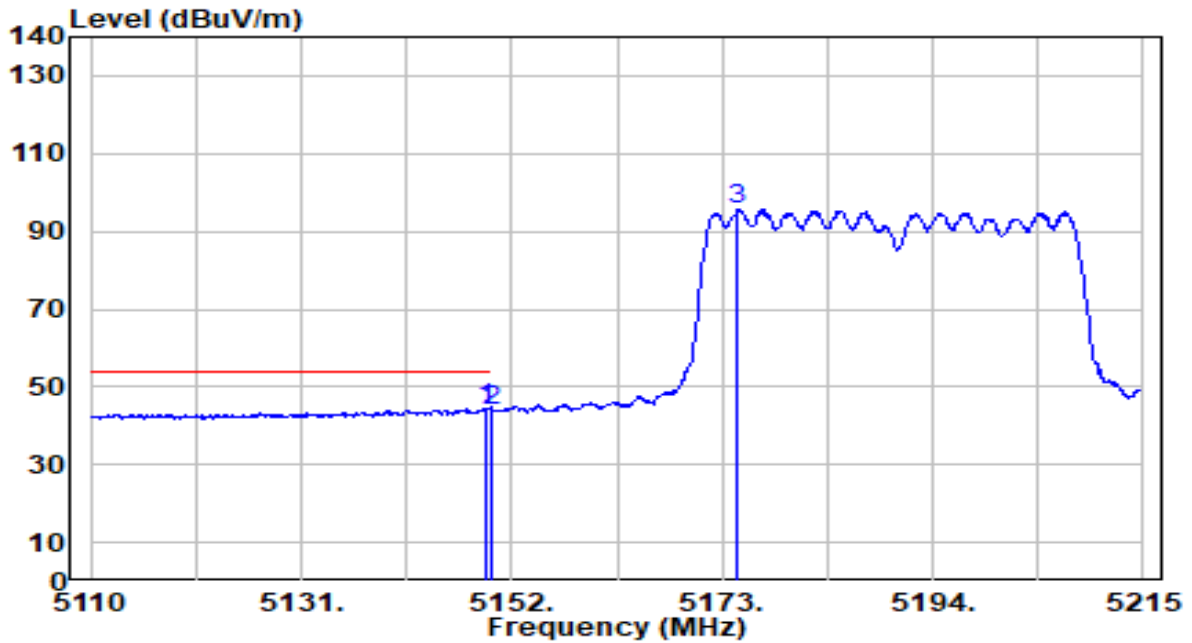

No	Frequency (MHz)	Reading (dBuV)	C.F (dB/m)	Measurement (dBuV/m)	Margin (dB)	Limit (dBuV/m)	Height (cm)	Angle (deg)	Remark (QP/PK/AV)
1	* 5149.480	43.54	0.68	44.21	-9.79	54.00	273	145	Average
2	5150.000	43.33	0.68	44.00	-10.00	54.00	273	145	Average
3	5174.575	95.11	0.67	95.78	N/A	N/A	273	145	Average

Note:

1. " *", means this data is the worst emission level.
2. C.F (Correction Factor) = Antenna Factor (dB/m)+ Cable Loss (dB) – Preamplifier(dB) + 10dB Attenuation.
3. Measurement (dBuV/m) = Reading(dBuV) + C.F (Correction Factor).
4. The emission levels of other frequencies are very lower than the limit and not show in test report.

EUT	BE3600 Dual-Band Wi-Fi 7 Router	Date of Test	2024-02-06
Factor	DRH18-E	Temp. / Humidity	20°C /65%
Polarity	Vertical	Site / Test Engineer	AC2 / Stanley
Test Mode	802.11ac-40MHz_TX_Band1_CH 38_ANT 0+1	Test Voltage	AC 120V/60Hz

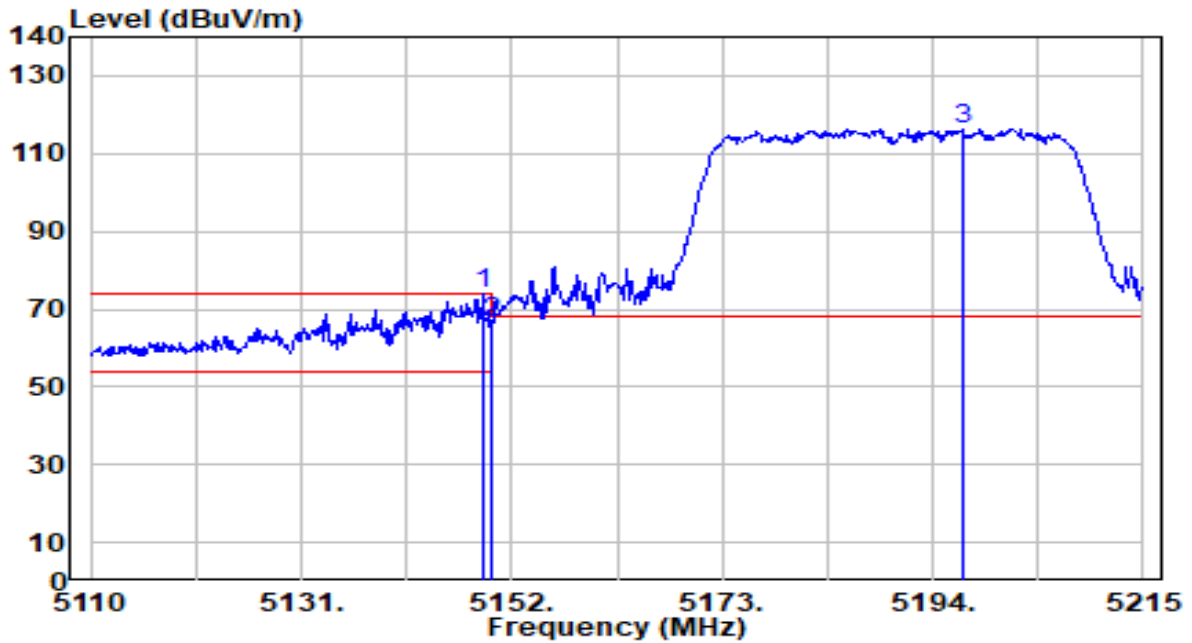

No	Frequency (MHz)	Reading (dBuV)	C.F (dB/m)	Measurement (dBuV/m)	Margin (dB)	Limit (dBuV/m)	Height (cm)	Angle (deg)	Remark (QP/PK/AV)
1	* 5149.165	73.22	0.68	73.90	-0.10	74.00	139	72	Peak
2	5150.000	65.95	0.68	66.62	-7.38	74.00	139	72	Peak
3	5197.045	115.77	0.67	116.44	N/A	N/A	139	72	Peak

Note:

1. " *", means this data is the worst emission level.
2. C.F (Correction Factor) = Antenna Factor (dB/m)+ Cable Loss (dB) – Preamplifier(dB) + 10dB Attenuation.
3. Measurement (dBuV/m) = Reading(dBuV) + C.F (Correction Factor).
4. The emission levels of other frequencies are very lower than the limit and not show in test report.

EUT	BE3600 Dual-Band Wi-Fi 7 Router	Date of Test	2024-02-06
Factor	DRH18-E	Temp. / Humidity	20°C /65%
Polarity	Vertical	Site / Test Engineer	AC2 / Stanley
Test Mode	802.11ac-40MHz_TX_Band1_CH 38_ANT 0+1	Test Voltage	AC 120V/60Hz

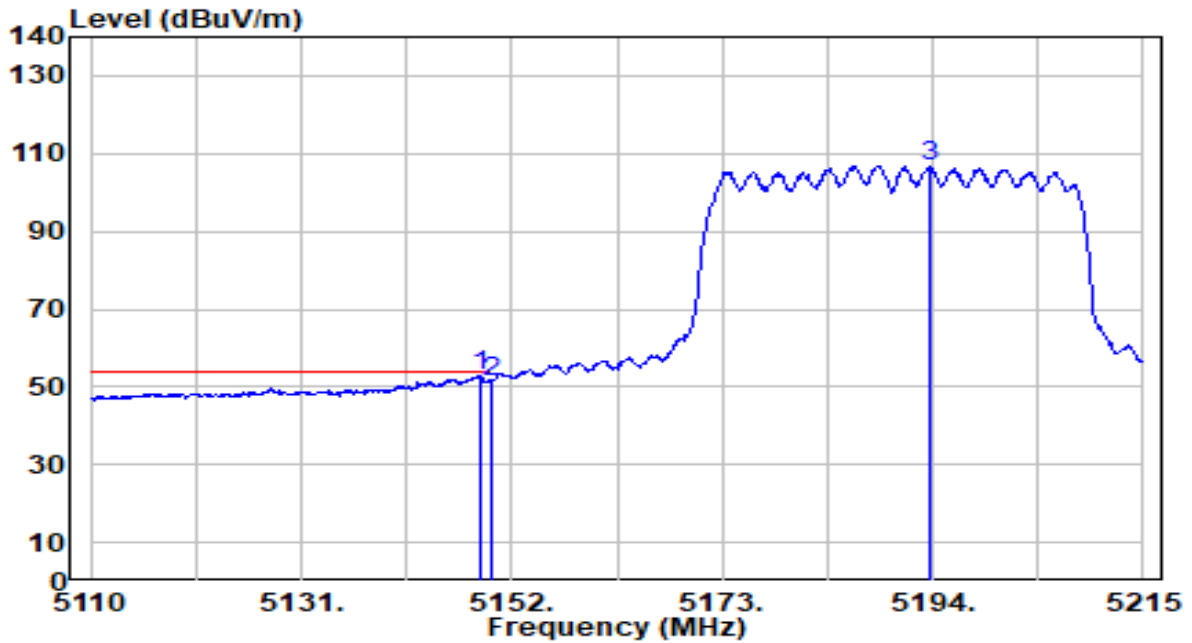

No	Frequency (MHz)	Reading (dBuV)	C.F (dB/m)	Measurement (dBuV/m)	Margin (dB)	Limit (dBuV/m)	Height (cm)	Angle (deg)	Remark (QP/PK/AV)
1	* 5148.850	51.98	0.68	52.65	-1.35	54.00	139	72	Average
2	5150.000	50.82	0.68	51.49	-2.51	54.00	139	72	Average
3	5193.685	106.25	0.67	106.92	N/A	N/A	139	72	Average

Note:

1. " *", means this data is the worst emission level.
2. C.F (Correction Factor) = Antenna Factor (dB/m)+ Cable Loss (dB) – Preamplifier(dB) + 10dB Attenuation.
3. Measurement (dBuV/m) = Reading(dBuV) + C.F (Correction Factor).
4. The emission levels of other frequencies are very lower than the limit and not show in test report.

EUT	BE3600 Dual-Band Wi-Fi 7 Router	Date of Test	2024-02-06
Factor	DRH18-E	Temp. / Humidity	20°C /65%
Polarity	Horizontal	Site / Test Engineer	AC2 / Stanley
Test Mode	802.11ac-40MHz_TX_Band2_CH 62_ANT 0+1	Test Voltage	AC 120V/60Hz

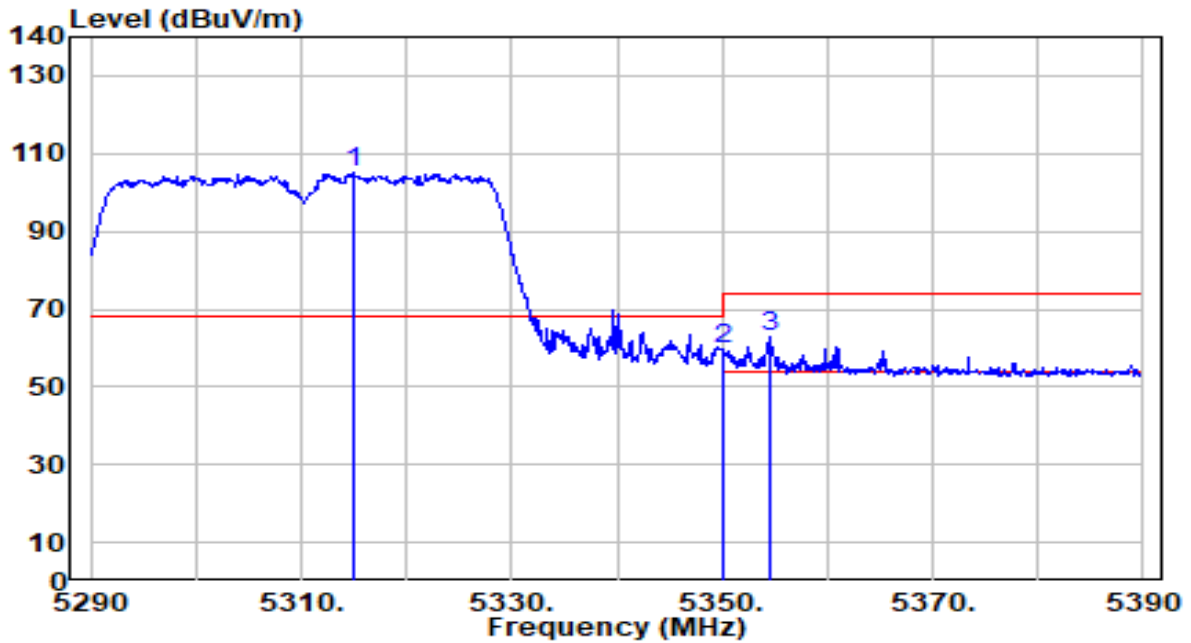

No	Frequency (MHz)	Reading (dBuV)	C.F (dB/m)	Measurement (dBuV/m)	Margin (dB)	Limit (dBuV/m)	Height (cm)	Angle (deg)	Remark (QP/PK/AV)
1	5315.100	104.59	0.54	105.13	N/A	N/A	296	147	Peak
2	5350.000	59.17	0.51	59.68	-14.32	74.00	296	147	Peak
3	* 5354.500	62.20	0.50	62.70	-11.30	74.00	296	147	Peak

Note:

1. " *", means this data is the worst emission level.
2. C.F (Correction Factor) = Antenna Factor (dB/m)+ Cable Loss (dB) – Preamplifier(dB) + 10dB Attenuation.
3. Measurement (dBuV/m) = Reading(dBuV) + C.F (Correction Factor).
4. The emission levels of other frequencies are very lower than the limit and not show in test report.

EUT	BE3600 Dual-Band Wi-Fi 7 Router	Date of Test	2024-02-06
Factor	DRH18-E	Temp. / Humidity	20°C /65%
Polarity	Horizontal	Site / Test Engineer	AC2 / Stanley
Test Mode	802.11ac-40MHz_TX_Band2_CH 62_ANT 0+1	Test Voltage	AC 120V/60Hz

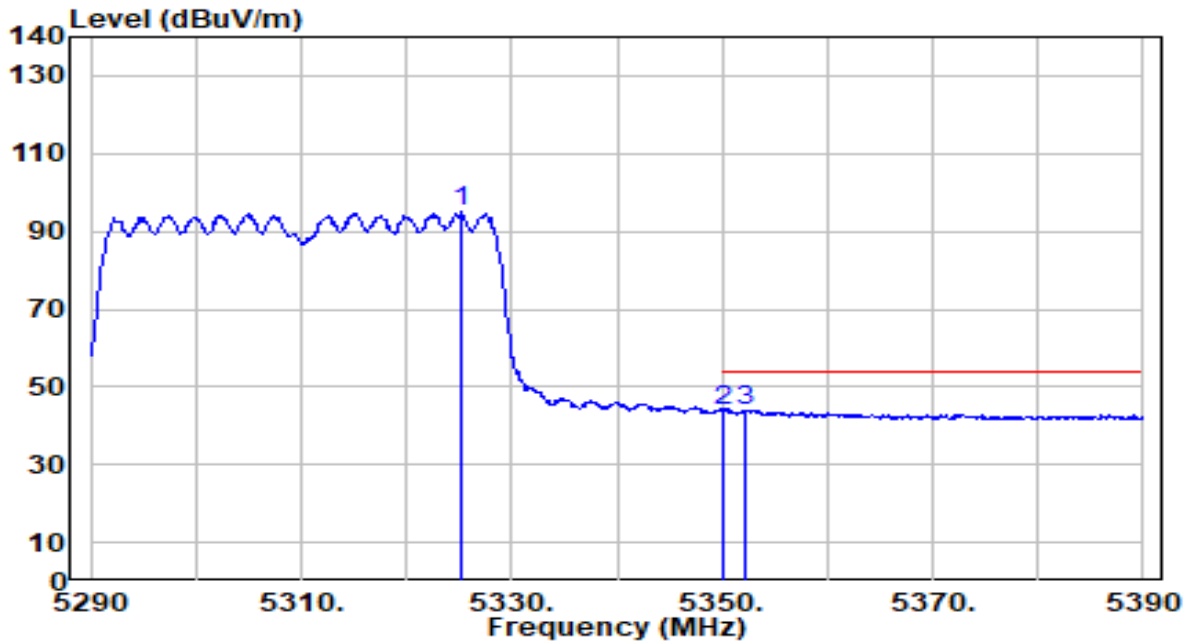

No	Frequency (MHz)	Reading (dBuV)	C.F (dB/m)	Measurement (dBuV/m)	Margin (dB)	Limit (dBuV/m)	Height (cm)	Angle (deg)	Remark (QP/PK/AV)
1	5325.200	94.59	0.53	95.13	N/A	N/A	296	147	Average
2	5350.000	43.48	0.51	43.98	-10.02	54.00	296	147	Average
3	* 5352.200	43.50	0.50	44.01	-9.99	54.00	296	147	Average

Note:

1. " *", means this data is the worst emission level.
2. C.F (Correction Factor) = Antenna Factor (dB/m)+ Cable Loss (dB) – Preamplifier(dB) + 10dB Attenuation.
3. Measurement (dBuV/m) = Reading(dBuV) + C.F (Correction Factor).
4. The emission levels of other frequencies are very lower than the limit and not show in test report.

EUT	BE3600 Dual-Band Wi-Fi 7 Router	Date of Test	2024-02-06
Factor	DRH18-E	Temp. / Humidity	20°C /65%
Polarity	Vertical	Site / Test Engineer	AC2 / Stanley
Test Mode	802.11ac-40MHz_TX_Band2_CH 62_ANT 0+1	Test Voltage	AC 120V/60Hz

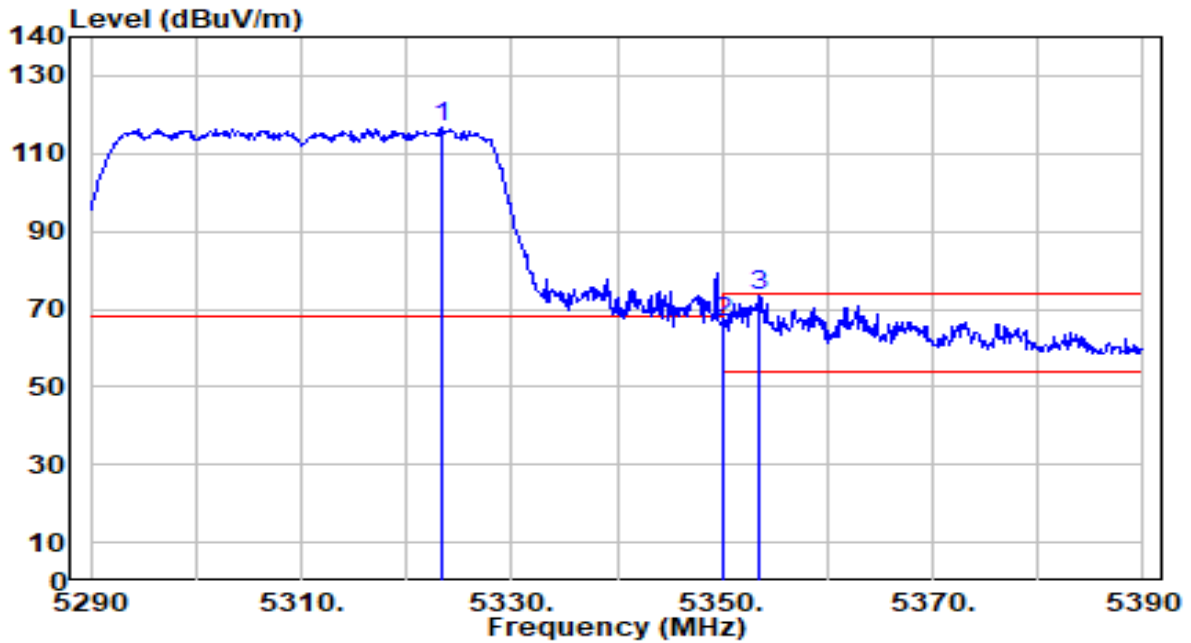

No	Frequency (MHz)	Reading (dBuV)	C.F (dB/m)	Measurement (dBuV/m)	Margin (dB)	Limit (dBuV/m)	Height (cm)	Angle (deg)	Remark (QP/PK/AV)
1	5323.400	116.30	0.53	116.84	N/A	N/A	122	38	Peak
2	5350.000	65.97	0.51	66.48	-7.52	74.00	122	38	Peak
3	* 5353.400	72.85	0.50	73.35	-0.65	74.00	122	38	Peak

Note:

1. " *", means this data is the worst emission level.
2. C.F (Correction Factor) = Antenna Factor (dB/m)+ Cable Loss (dB) – Preamplifier(dB) + 10dB Attenuation.
3. Measurement (dBuV/m) = Reading(dBuV) + C.F (Correction Factor).
4. The emission levels of other frequencies are very lower than the limit and not show in test report.

EUT	BE3600 Dual-Band Wi-Fi 7 Router	Date of Test	2024-02-06
Factor	DRH18-E	Temp. / Humidity	20°C /65%
Polarity	Vertical	Site / Test Engineer	AC2 / Stanley
Test Mode	802.11ac-40MHz_TX_Band2_CH 62_ANT 0+1	Test Voltage	AC 120V/60Hz

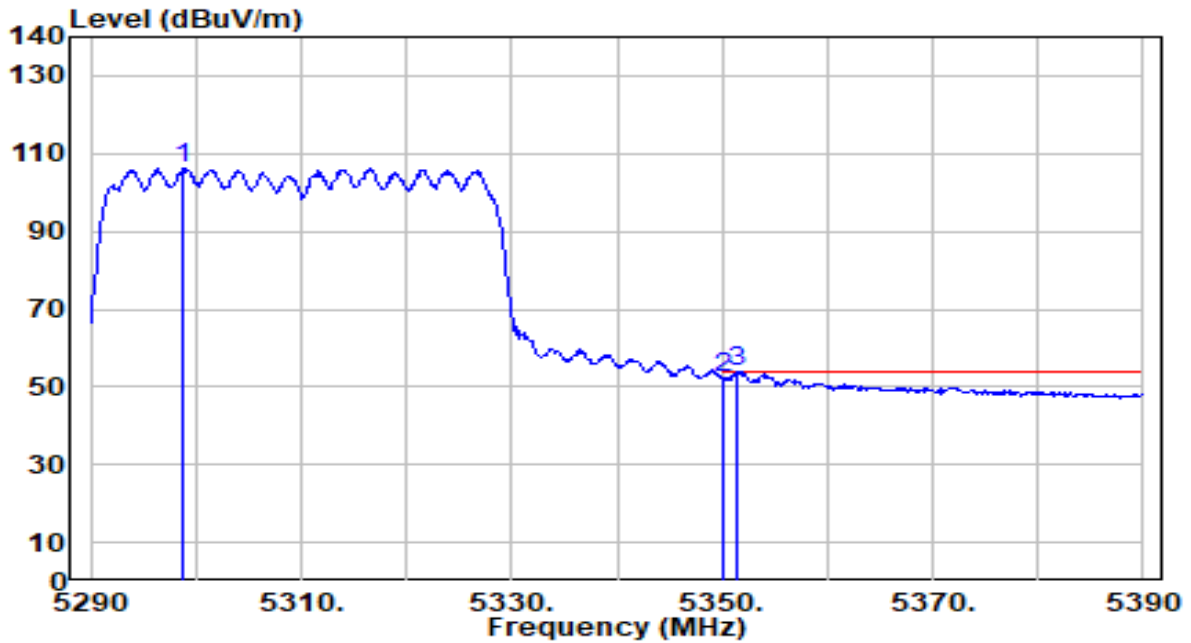

No	Frequency (MHz)	Reading (dBuV)	C.F (dB/m)	Measurement (dBuV/m)	Margin (dB)	Limit (dBuV/m)	Height (cm)	Angle (deg)	Remark (QP/PK/AV)
1	5298.800	105.79	0.56	106.36	N/A	N/A	122	38	Average
2	5350.000	51.61	0.51	52.11	-1.89	54.00	122	38	Average
3	* 5351.400	53.39	0.50	53.89	-0.11	54.00	122	38	Average

Note:

1. " *", means this data is the worst emission level.
2. C.F (Correction Factor) = Antenna Factor (dB/m)+ Cable Loss (dB) – Preamplifier(dB) + 10dB Attenuation.
3. Measurement (dBuV/m) = Reading(dBuV) + C.F (Correction Factor).
4. The emission levels of other frequencies are very lower than the limit and not show in test report.

EUT	BE3600 Dual-Band Wi-Fi 7 Router	Date of Test	2024-02-06
Factor	DRH18-E	Temp. / Humidity	20°C /65%
Polarity	Horizontal	Site / Test Engineer	AC2 / Stanley
Test Mode	802.11ac-40MHz_TX_Band3_CH 102_ANT 0+1	Test Voltage	AC 120V/60Hz

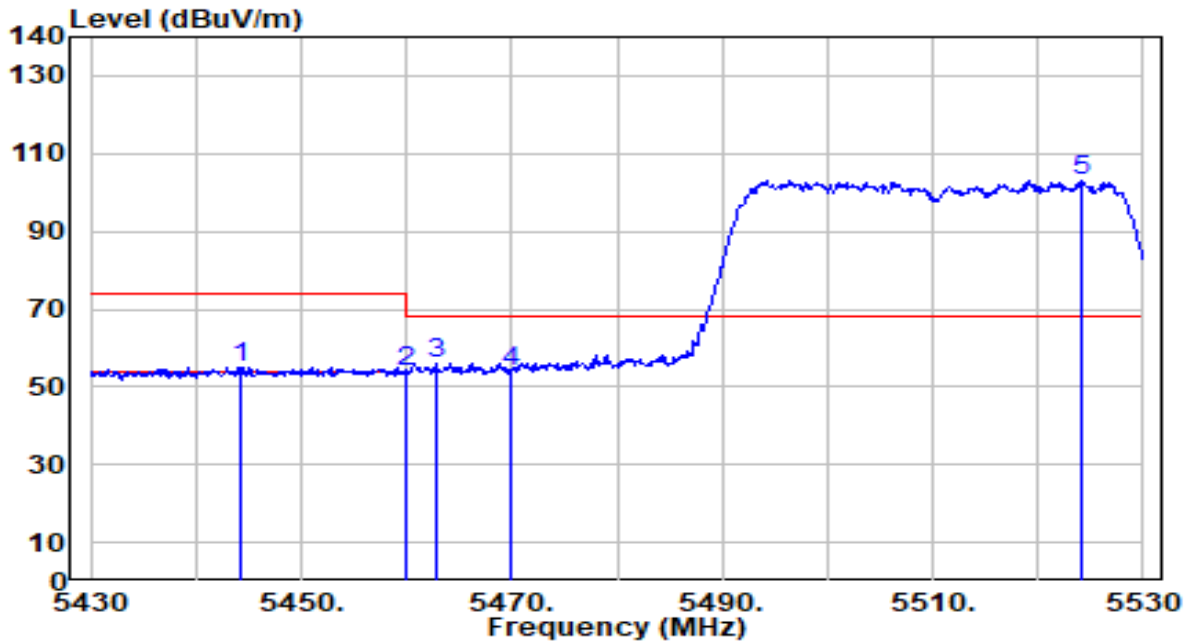

No	Frequency (MHz)	Reading (dBuV)	C.F (dB/m)	Measurement (dBuV/m)	Margin (dB)	Limit (dBuV/m)	Height (cm)	Angle (deg)	Remark (QP/PK/AV)
1	5444.200	54.47	0.60	55.07	-18.93	74.00	102	224	Peak
2	5460.000	52.97	0.65	53.62	-20.38	74.00	102	224	Peak
3	* 5462.900	55.22	0.66	55.88	-12.32	68.20	102	224	Peak
4	5470.000	53.40	0.69	54.09	-14.11	68.20	102	224	Peak
5	5524.200	102.12	0.88	103.00	N/A	N/A	102	224	Peak

Note:

- " *", means this data is the worst emission level.
- C.F (Correction Factor) = Antenna Factor (dB/m)+ Cable Loss (dB) – Preamplifier(dB) + 10dB Attenuation.
- Measurement (dBuV/m) = Reading(dBuV) + C.F (Correction Factor).
- The emission levels of other frequencies are very lower than the limit and not show in test report.

EUT	BE3600 Dual-Band Wi-Fi 7 Router	Date of Test	2024-02-06
Factor	DRH18-E	Temp. / Humidity	20°C /65%
Polarity	Horizontal	Site / Test Engineer	AC2 / Stanley
Test Mode	802.11ac-40MHz_TX_Band3_CH 102_ANT 0+1	Test Voltage	AC 120V/60Hz

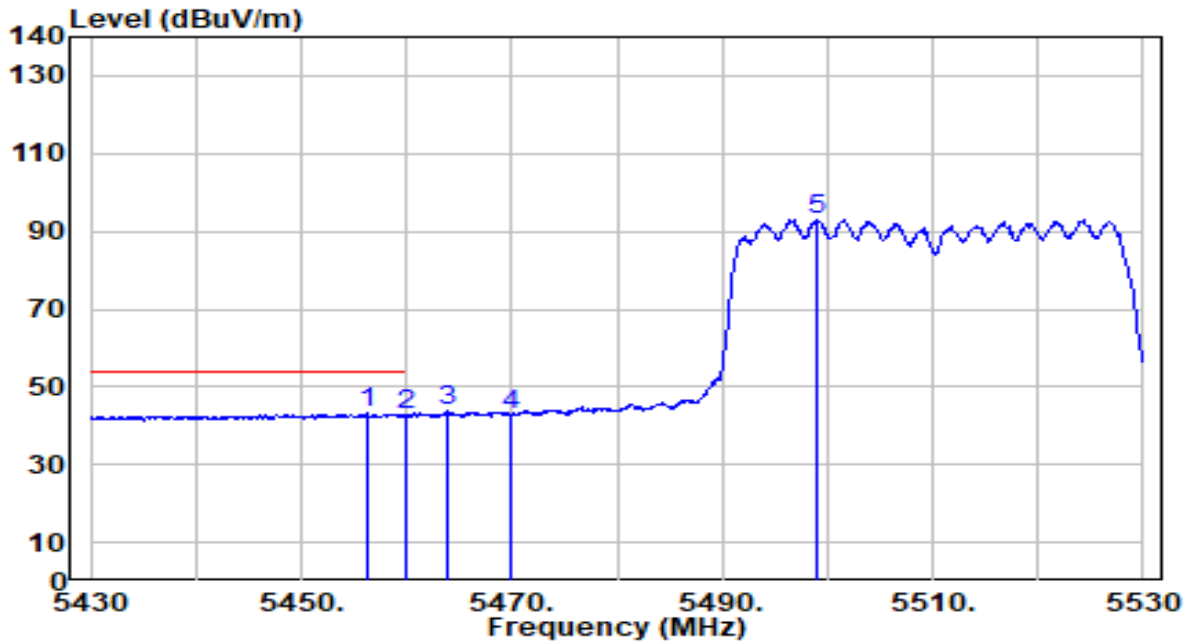

No	Frequency (MHz)	Reading (dBuV)	C.F (dB/m)	Measurement (dBuV/m)	Margin (dB)	Limit (dBuV/m)	Height (cm)	Angle (deg)	Remark (QP/PK/AV)	
1	*	5456.300	42.49	0.64	43.14	-10.86	54.00	102	224	Average
2		5460.000	41.90	0.65	42.55	-11.45	54.00	102	224	Average
3		5463.900	42.94	0.67	43.60	N/A	N/A	102	224	Average
4		5470.000	42.14	0.69	42.83	N/A	N/A	102	224	Average
5		5499.000	92.18	0.79	92.96	N/A	N/A	102	224	Average

Note:

- " *", means this data is the worst emission level.
- C.F (Correction Factor) = Antenna Factor (dB/m)+ Cable Loss (dB) – Preamplifier(dB) + 10dB Attenuation.
- Measurement (dBuV/m) = Reading(dBuV) + C.F (Correction Factor).
- The emission levels of other frequencies are very lower than the limit and not show in test report.

EUT	BE3600 Dual-Band Wi-Fi 7 Router	Date of Test	2024-02-06
Factor	DRH18-E	Temp. / Humidity	20°C /65%
Polarity	Vertical	Site / Test Engineer	AC2 / Stanley
Test Mode	802.11ac-40MHz_TX_Band3_CH 102_ANT 0+1	Test Voltage	AC 120V/60Hz

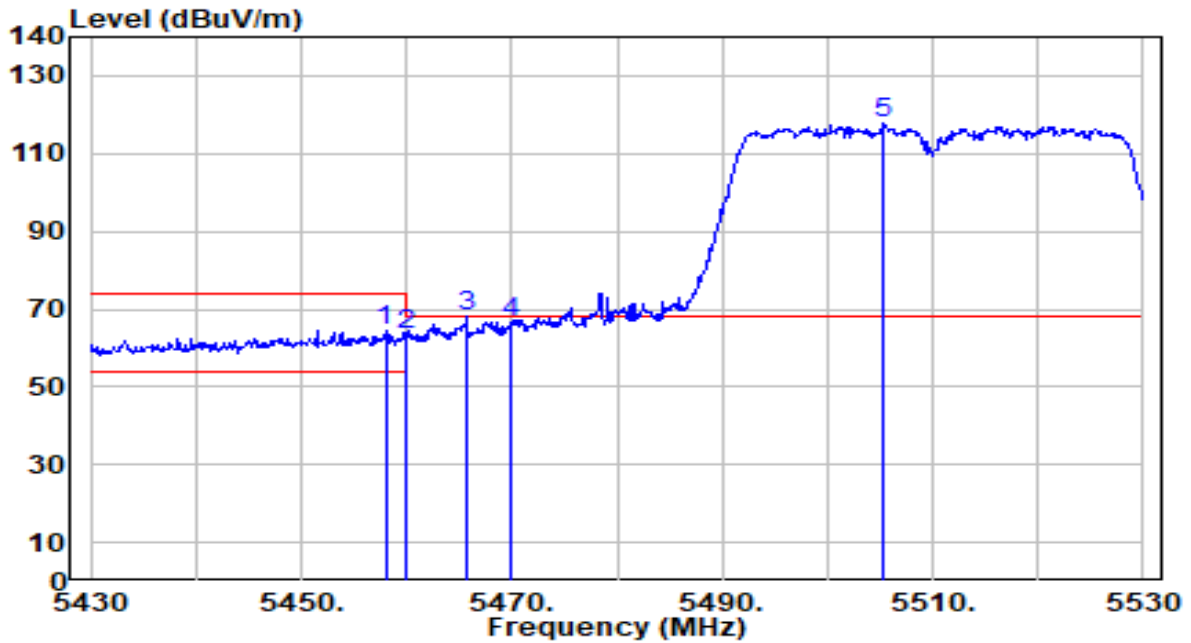

No	Frequency (MHz)	Reading (dBuV)	C.F (dB/m)	Measurement (dBuV/m)	Margin (dB)	Limit (dBuV/m)	Height (cm)	Angle (deg)	Remark (QP/PK/AV)
1	5458.000	63.71	0.65	64.36	-9.64	74.00	140	28	Peak
2	5460.000	62.57	0.65	63.23	-10.77	74.00	140	28	Peak
3	* 5465.700	67.39	0.67	68.07	-0.13	68.20	140	28	Peak
4	5470.000	65.70	0.69	66.39	-1.81	68.20	140	28	Peak
5	5505.300	116.83	0.81	117.64	N/A	N/A	140	28	Peak

Note:

1. " *", means this data is the worst emission level.
2. C.F (Correction Factor) = Antenna Factor (dB/m)+ Cable Loss (dB) – Preamplifier(dB) + 10dB Attenuation.
3. Measurement (dBuV/m) = Reading(dBuV) + C.F (Correction Factor).
4. The emission levels of other frequencies are very lower than the limit and not show in test report.

EUT	BE3600 Dual-Band Wi-Fi 7 Router	Date of Test	2024-02-06
Factor	DRH18-E	Temp. / Humidity	20°C /65%
Polarity	Vertical	Site / Test Engineer	AC2 / Stanley
Test Mode	802.11ac-40MHz_TX_Band3_CH 102_ANT 0+1	Test Voltage	AC 120V/60Hz

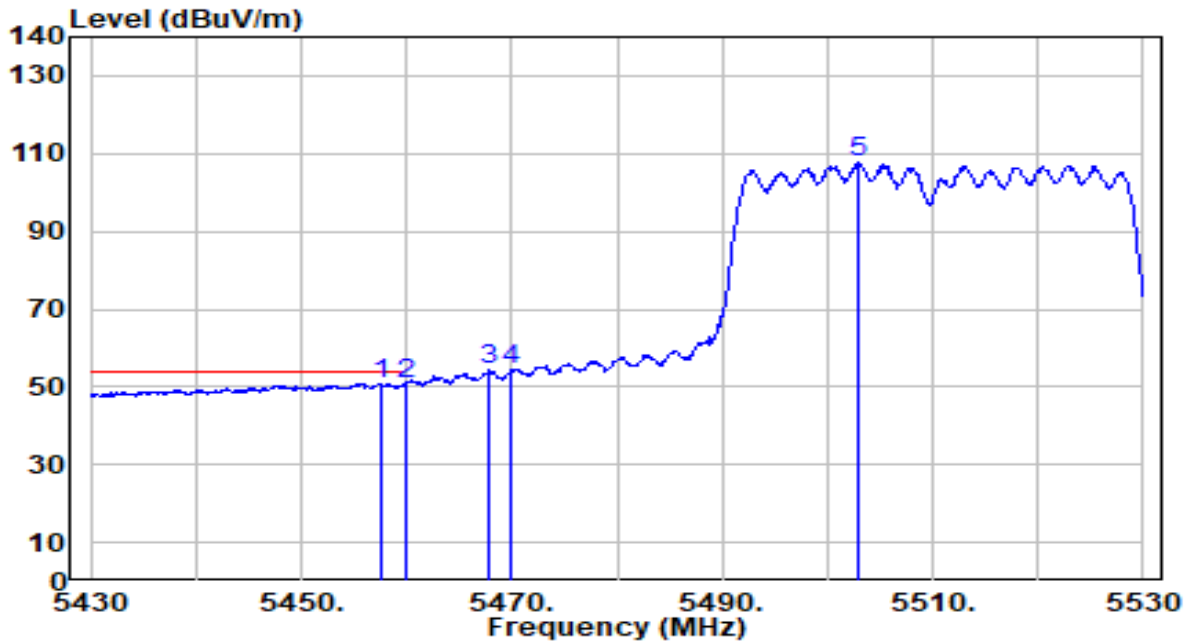

No	Frequency (MHz)	Reading (dBuV)	C.F (dB/m)	Measurement (dBuV/m)	Margin (dB)	Limit (dBuV/m)	Height (cm)	Angle (deg)	Remark (QP/PK/AV)
1	* 5457.600	50.29	0.65	50.94	-3.06	54.00	140	28	Average
2	5460.000	50.05	0.65	50.70	-3.30	54.00	140	28	Average
3	5467.800	53.50	0.68	54.18	N/A	N/A	140	28	Average
4	5470.000	53.84	0.69	54.53	N/A	N/A	140	28	Average
5	5503.000	106.91	0.80	107.71	N/A	N/A	140	28	Average

Note:

1. " *", means this data is the worst emission level.
2. C.F (Correction Factor) = Antenna Factor (dB/m)+ Cable Loss (dB) – Preamplifier(dB) + 10dB Attenuation.
3. Measurement (dBuV/m) = Reading(dBuV) + C.F (Correction Factor).
4. The emission levels of other frequencies are very lower than the limit and not show in test report.

EUT	BE3600 Dual-Band Wi-Fi 7 Router	Date of Test	2024-02-06
Factor	DRH18-E	Temp. / Humidity	20°C /65%
Polarity	Horizontal	Site / Test Engineer	AC2 / Marvin
Test Mode	802.11ac-40MHz_TX_Band3_CH 134_ANT 0+1	Test Voltage	AC 120V/60Hz

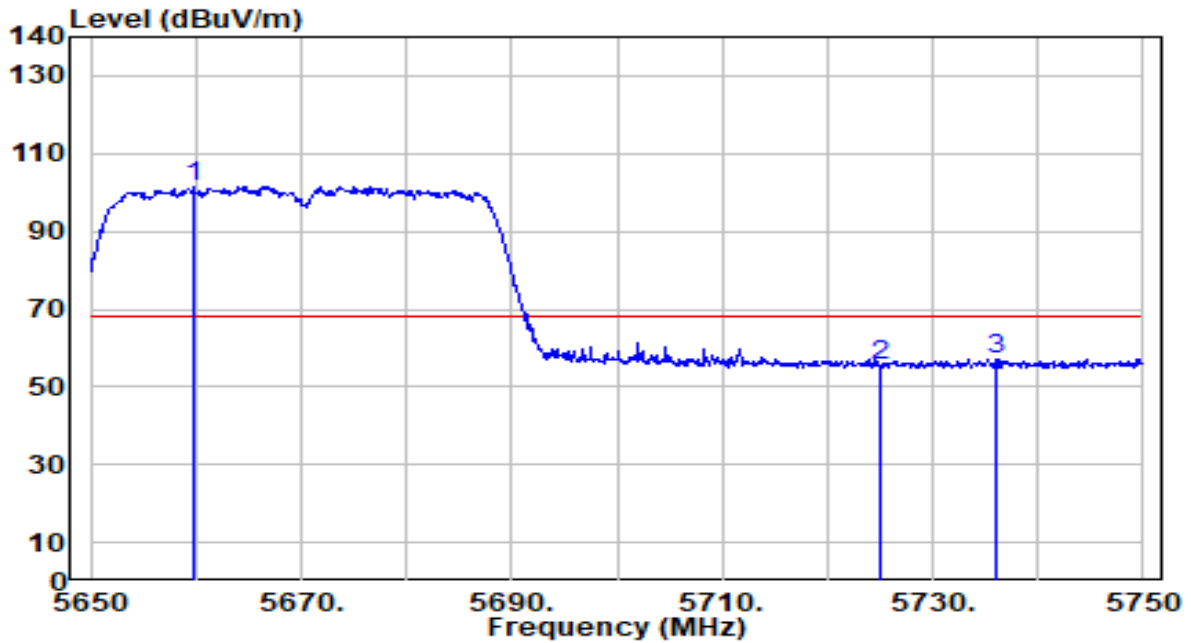

No	Frequency (MHz)	Reading (dBuV)	C.F (dB/m)	Measurement (dBuV/m)	Margin (dB)	Limit (dBuV/m)	Height (cm)	Angle (deg)	Remark (QP/PK/AV)
1	5659.700	100.06	1.49	101.56	N/A	N/A	102	223	Peak
2	5725.000	53.83	1.86	55.69	-12.51	68.20	102	223	Peak
3	* 5736.100	55.21	1.93	57.14	-11.06	68.20	102	223	Peak

Note:

1. " *", means this data is the worst emission level.
2. C.F (Correction Factor) = Antenna Factor (dB/m)+ Cable Loss (dB) – Preamplifier(dB) + 10dB Attenuation.
3. Measurement (dBuV/m) = Reading(dBuV) + C.F (Correction Factor).
4. The emission levels of other frequencies are very lower than the limit and not show in test report.

EUT	BE3600 Dual-Band Wi-Fi 7 Router	Date of Test	2024-02-06
Factor	DRH18-E	Temp. / Humidity	20°C /65%
Polarity	Vertical	Site / Test Engineer	AC2 / Marvin
Test Mode	802.11ac-40MHz_TX_Band3_CH 134_ANT 0+1	Test Voltage	AC 120V/60Hz

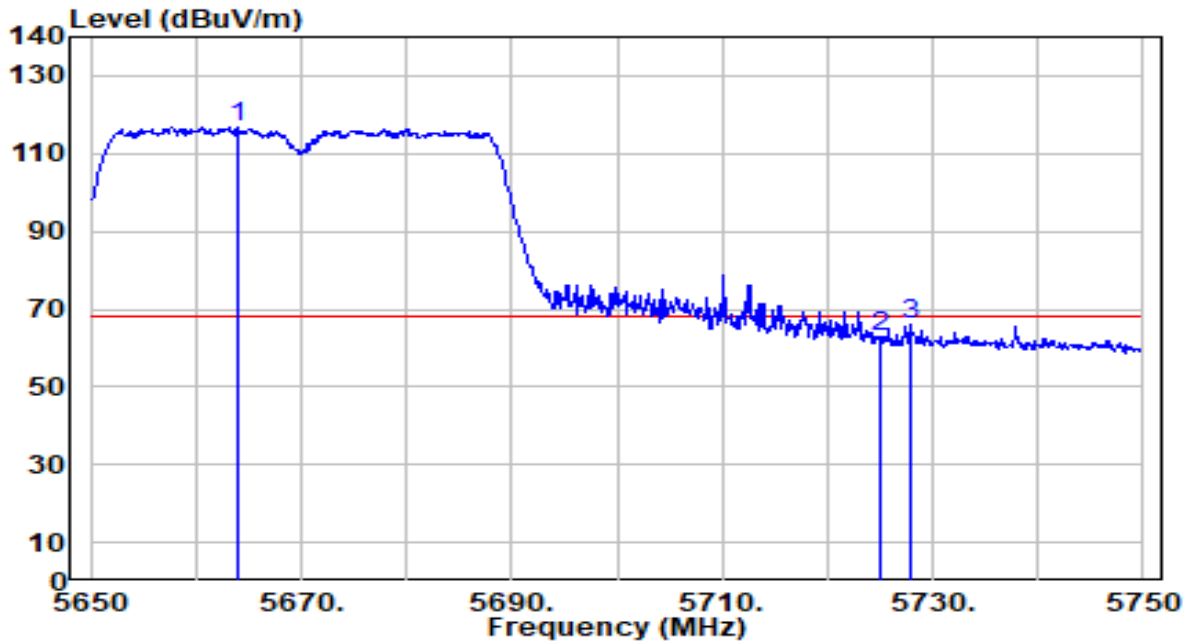

No	Frequency (MHz)	Reading (dBuV)	C.F (dB/m)	Measurement (dBuV/m)	Margin (dB)	Limit (dBuV/m)	Height (cm)	Angle (deg)	Remark (QP/PK/AV)
1	5664.100	115.44	1.52	116.96	N/A	N/A	136	31	Peak
2	5725.000	61.14	1.86	63.00	-5.20	68.20	136	31	Peak
3	* 5727.800	64.33	1.88	66.21	-1.99	68.20	136	31	Peak

Note:

1. " *", means this data is the worst emission level.
2. C.F (Correction Factor) = Antenna Factor (dB/m)+ Cable Loss (dB) – Preamplifier(dB) + 10dB Attenuation.
3. Measurement (dBuV/m) = Reading(dBuV) + C.F (Correction Factor).
4. The emission levels of other frequencies are very lower than the limit and not show in test report.

EUT	BE3600 Dual-Band Wi-Fi 7 Router	Date of Test	2024-02-06
Factor	DRH18-E	Temp. / Humidity	20°C /65%
Polarity	Horizontal	Site / Test Engineer	AC2 / Marvin
Test Mode	802.11ac-40MHz_TX_Band4_CH 151_ANT 0+1	Test Voltage	AC 120V/60Hz

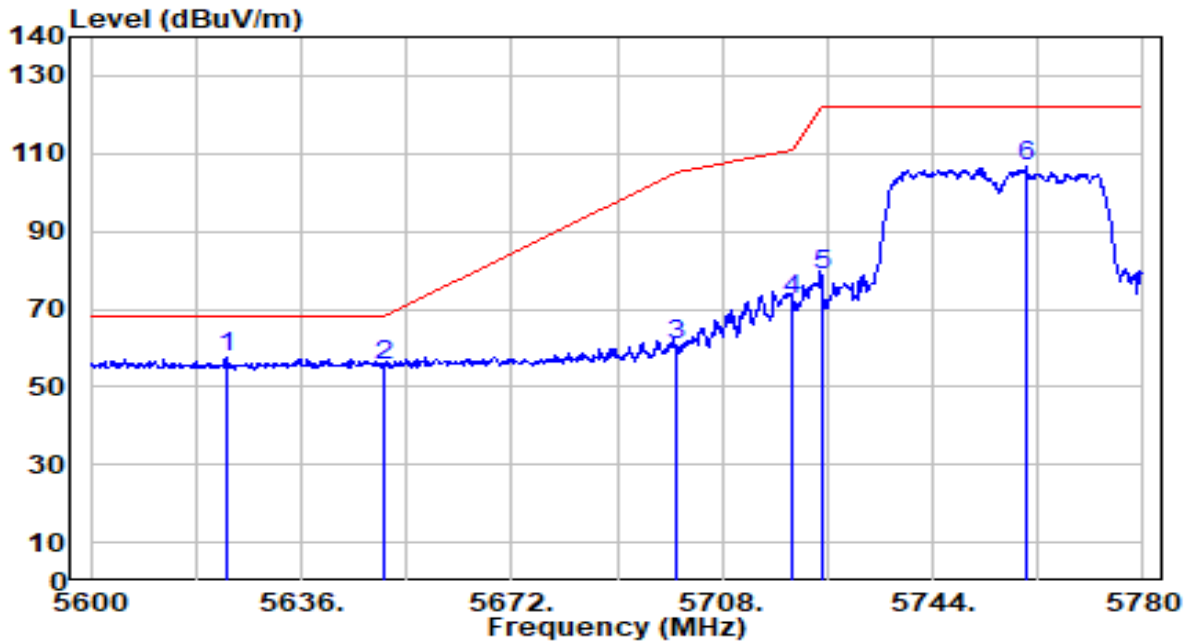

No	Frequency (MHz)	Reading (dBuV)	C.F (dB/m)	Measurement (dBuV/m)	Margin (dB)	Limit (dBuV/m)	Height (cm)	Angle (deg)	Remark (QP/PK/AV)
1	*	56.17	1.29	57.45	-10.75	68.20	100	140	Peak
2		54.07	1.44	55.51	-12.69	68.20	100	140	Peak
3		59.09	1.72	60.82	-44.38	105.20	100	140	Peak
4		70.59	1.84	72.42	-38.38	110.80	100	140	Peak
5		77.09	1.86	78.96	-43.24	122.20	100	140	Peak
6		104.43	2.06	106.49	N/A	N/A	100	140	Peak

Note:

1. " *", means this data is the worst emission level.
2. C.F (Correction Factor) = Antenna Factor (dB/m)+ Cable Loss (dB) – Preamplifier(dB) + 10dB Attenuation.
3. Measurement (dBuV/m) = Reading(dBuV) + C.F (Correction Factor).
4. The emission levels of other frequencies are very lower than the limit and not show in test report.

EUT	BE3600 Dual-Band Wi-Fi 7 Router	Date of Test	2024-02-06
Factor	DRH18-E	Temp. / Humidity	20°C /65%
Polarity	Vertical	Site / Test Engineer	AC2 / Marvin
Test Mode	802.11ac-40MHz_TX_Band4_CH 151_ANT 0+1	Test Voltage	AC 120V/60Hz

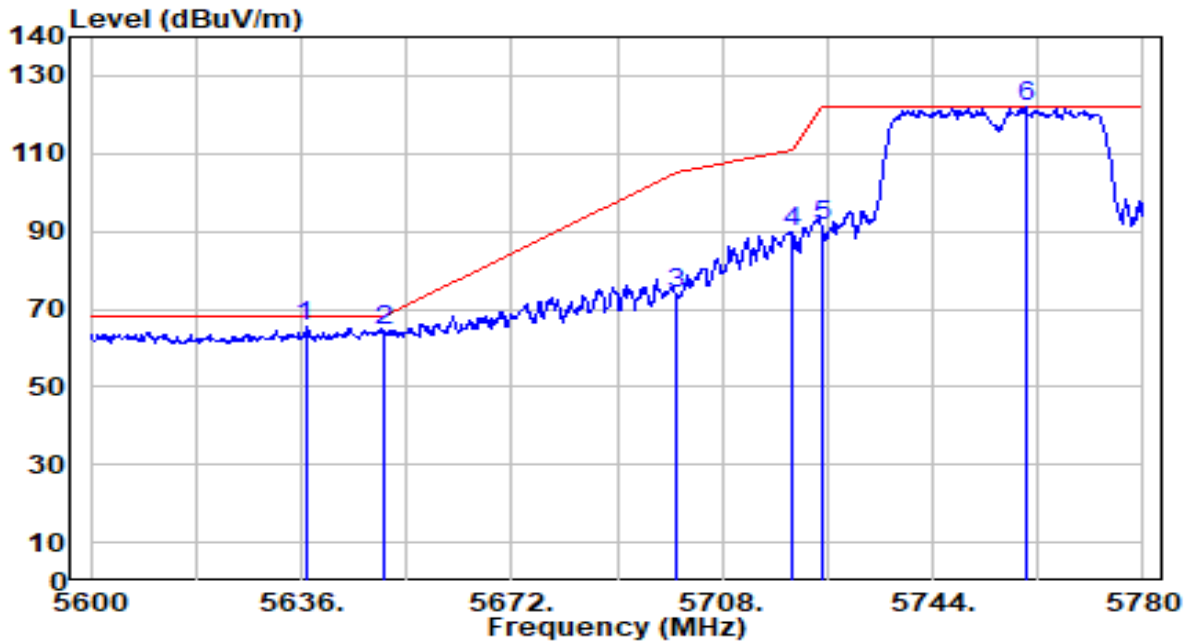

No	Frequency (MHz)	Reading (dBUV)	C.F (dB/m)	Measurement (dBUV/m)	Margin (dB)	Limit (dBUV/m)	Height (cm)	Angle (deg)	Remark (QP/PK/AV)
1	* 5636.720	64.04	1.36	65.41	-2.79	68.20	137	35	Peak
2	5650.000	63.05	1.44	64.49	-3.71	68.20	137	35	Peak
3	5700.000	72.42	1.72	74.15	-31.05	105.20	137	35	Peak
4	5720.000	87.79	1.84	89.63	-21.17	110.80	137	35	Peak
5	5725.000	89.38	1.86	91.25	-30.95	122.20	137	35	Peak
6	5759.840	120.13	2.06	122.19	N/A	N/A	137	35	Peak

Note:

1. " *", means this data is the worst emission level.
2. C.F (Correction Factor) = Antenna Factor (dB/m)+ Cable Loss (dB) – Preamplifier(dB) + 10dB Attenuation.
3. Measurement (dBUV/m) = Reading(dBUV) + C.F (Correction Factor).
4. The emission levels of other frequencies are very lower than the limit and not show in test report.