



# FCC Radio Test Report

## FCC ID: 2BCGWAX10

This report concerns: Original Grant

**Project No.** : 2311G085  
**Equipment** : AX1500 Wi-Fi 6 Router  
**Brand Name** : tp-link  
**Test Model** : Archer AX10  
**Series Model** : Archer AX1500  
**Applicant** : TP-LINK CORPORATION PTE. LTD.  
**Address** : 7 Temasek Boulevard #29-03 Suntec Tower One, Singapore 038987  
**Manufacturer** : TP-LINK CORPORATION PTE. LTD.  
**Address** : 7 Temasek Boulevard #29-03 Suntec Tower One, Singapore 038987  
**Date of Receipt** : Nov. 17, 2023  
**Date of Test** : Dec. 13, 2023 ~ Feb. 05, 2024  
**Issued Date** : Feb. 27, 2024  
**Report Version** : R00  
**Test Sample** : Engineering Sample No.: SSL202311163 for conducted,  
SSL202311164 for radiated.  
**Standard(s)** : FCC CFR Title 47, Part 15, Subpart E

The above equipment has been tested and found compliance with the requirement of the relative standards by BTL Inc.

**Prepared by** : Grani Zhou  
Grani Zhou

**Approved by** : Steven Lu  
Steven Lu

Room 108, Building 2, No. 1, Yile Road, Songshan Lake Zone, Dongguan City, Guangdong  
523000 China

Tel: +86-769-8318-3000    Web: www.newbtl.com    Service mail: btl\_qa@newbtl.com

**Declaration**

**BTL** represents to the client that testing is done in accordance with standard procedures as applicable and that test instruments used has been calibrated with standards traceable to international standard(s) and/or national standard(s).

**BTL's** reports apply only to the specific samples tested under conditions. It is manufacture's responsibility to ensure that additional production units of this model are manufactured with the identical electrical and mechanical components. **BTL** shall have no liability for any declarations, inferences or generalizations drawn by the client or others from **BTL** issued reports.

The report must not be used by the client to claim product certification, approval, or endorsement by NVLAP, NIST, or any agency of the U.S. Government.

This report is the confidential property of the client. As a mutual protection to the clients, the public and ourselves, the test report shall not be reproduced, except in full, without our written approval.

**BTL's** laboratory quality assurance procedures are in compliance with the ISO/IEC 17025: 2017 requirements, and accredited by the conformity assessment authorities listed in this test report.

**BTL** is not responsible for the sampling stage, so the results only apply to the sample as received.

The information, data and test plan are provided by manufacturer which may affect the validity of results, so it is manufacturer's responsibility to ensure that the apparatus meets the essential requirements of applied standards and in all the possible configurations as representative of its intended use.

**Limitation**

For the use of the authority's logo is limited unless the Test Standard(s)/Scope(s)/Item(s) mentioned in this test report is (are) included in the conformity assessment authorities acceptance respective.

Please note that the measurement uncertainty is provided for informational purpose only and are not use in determining the Pass/Fail results.

<b>Table of Contents</b>	<b>Page</b>
<b>REPORT ISSUED HISTORY</b>	<b>6</b>
<b>1 . APPLICABLE STANDARDS</b>	<b>7</b>
<b>2 . SUMMARY OF TEST RESULTS</b>	<b>7</b>
2.1 TEST FACILITY	8
2.2 MEASUREMENT UNCERTAINTY	8
2.3 TEST ENVIRONMENT CONDITIONS	9
<b>3 . GENERAL INFORMATION</b>	<b>10</b>
3.1 GENERAL DESCRIPTION OF EUT	10
3.2 TEST MODES	13
3.3 PARAMETERS OF TEST SOFTWARE	16
3.4 DUTY CYCLE	18
3.5 BLOCK DIAGRAM SHOWING THE CONFIGURATION OF SYSTEM TESTED	21
3.6 SUPPORT UNITS	21
3.7 CUSTOMER INFORMATION DESCRIPTION	21
<b>4 . AC POWER LINE CONDUCTED EMISSIONS</b>	<b>22</b>
4.1 LIMIT	22
4.2 TEST PROCEDURE	22
4.3 DEVIATION FROM TEST STANDARD	22
4.4 TEST SETUP	23
4.5 EUT OPERATION CONDITIONS	23
4.6 TEST RESULTS	23
<b>5 . RADIATED EMISSIONS</b>	<b>24</b>
5.1 LIMIT	24
5.2 TEST PROCEDURE	25
5.3 DEVIATION FROM TEST STANDARD	26
5.4 TEST SETUP	26
5.5 EUT OPERATION CONDITIONS	27
5.6 TEST RESULTS - 9 KHZ TO 30 MHZ	27
5.7 TEST RESULTS - 30 MHZ TO 1000 MHZ	27
5.8 TEST RESULTS - ABOVE 1000 MHZ	27
<b>6 . BANDWIDTH</b>	<b>28</b>
6.1 LIMIT	28
6.2 TEST PROCEDURE	28

<b>Table of Contents</b>	<b>Page</b>
6.3 DEVIATION FROM STANDARD	28
6.4 TEST SETUP	29
6.5 EUT OPERATION CONDITIONS	29
6.6 TEST RESULTS	29
<b>7 . MAXIMUM OUTPUT POWER</b>	<b>30</b>
7.1 LIMIT	30
7.2 TEST PROCEDURE	30
7.3 DEVIATION FROM STANDARD	30
7.4 TEST SETUP	30
7.5 EUT OPERATION CONDITIONS	30
7.6 TEST RESULTS	30
<b>8 . POWER SPECTRAL DENSITY</b>	<b>31</b>
8.1 LIMIT	31
8.2 TEST PROCEDURE	31
8.3 DEVIATION FROM STANDARD	31
8.4 TEST SETUP	32
8.5 EUT OPERATION CONDITIONS	32
8.6 TEST RESULTS	32
<b>9 . FREQUENCY STABILITY</b>	<b>33</b>
9.1 LIMIT	33
9.2 TEST PROCEDURE	33
9.3 DEVIATION FROM STANDARD	33
9.4 TEST SETUP	33
9.5 EUT OPERATION CONDITIONS	33
9.6 TEST RESULTS	33
<b>10 . MEASUREMENT INSTRUMENTS LIST</b>	<b>34</b>
<b>11 . EUT TEST PHOTOS</b>	<b>37</b>
<b>APPENDIX A - AC POWER LINE CONDUCTED EMISSIONS</b>	<b>42</b>
<b>APPENDIX B - RADIATED EMISSION - 9 KHZ TO 30 MHZ</b>	<b>45</b>
<b>APPENDIX C - RADIATED EMISSION - 30 MHZ TO 1000 MHZ</b>	<b>50</b>
<b>APPENDIX D - RADIATED EMISSION - ABOVE 1000 MHZ</b>	<b>53</b>
<b>APPENDIX E - BANDWIDTH</b>	<b>108</b>
<b>APPENDIX F - MAXIMUM OUTPUT POWER</b>	<b>123</b>

<b>Table of Contents</b>	<b>Page</b>
<b>APPENDIX G - POWER SPECTRAL DENSITY</b>	<b>150</b>
<b>APPENDIX H - FREQUENCY STABILITY</b>	<b>165</b>

**REPORT ISSUED HISTORY**

Report No.	Version	Description	Issued Date	Note
BTL-FCCP-2-2311G085	R00	Original Report.	Feb. 27, 2024	Valid

## 1. APPLICABLE STANDARDS

According to the specifications of the manufacturer, the EUT must comply with the requirements of the following standards:

ANSI C63.10-2013

The following reference test guidance is not within the scope of accreditation of NVLAP:

KDB 789033 D02 General UNII Test Procedures New Rules v02r01

KDB 662911 D01 Multiple Transmitter Output v02r01

## 2. SUMMARY OF TEST RESULTS

Test procedures according to the technical standard(s):

FCC CFR Title 47, Part 15, Subpart E				
Standard(s) Section	Test Item	Test Result	Judgment	Remark
15.207 15.407(b)	AC Power Line Conducted Emissions	APPENDIX A	PASS	-----
15.407(b) 15.205(a) 15.209(a)	Radiated Emissions	APPENDIX B APPENDIX C APPENDIX D	PASS	-----
15.407(a) 15.407(e)	Bandwidth	APPENDIX E	PASS	-----
15.407(a)	Maximum Output Power	APPENDIX F	PASS	-----
15.407(a)	Power Spectral Density	APPENDIX G	PASS	-----
15.407(g)	Frequency Stability	APPENDIX H	PASS	-----
15.203	Antenna Requirements	-----	PASS	NOTE (2)
15.407(c)	Automatically Discontinue Transmission	-----	PASS	NOTE (3)

Note:

- (1) "N/A" denotes test is not applicable in this test report.
- (2) The device what use a permanently attached antenna were considered sufficient to comply with the provisions of 15.203.
- (3) During no any information transmission, the EUT can automatically discontinue transmission and become standby mode for power saving. the EUT can detect the controlling signal of ACK message transmitting from remote device and verify whether it shall resend or discontinue transmission.
- (4) For UNII-1 this device was functioned as a
  - Outdoor access point device
  - Indoor access point device
  - Fixed point-to-point access points device
  - Client device

## 2.1 TEST FACILITY

The test facilities used to collect the test data in this report is at the location of No. 3 Jinshagang 1st Rd. Shixia, Dalang Town, Dongguan City, Guangdong 523792.

BTL's Registration Number for FCC: 162128

BTL's Designation Number for FCC: CN5042

## 2.2 MEASUREMENT UNCERTAINTY

ISO/IEC 17025 requires that an estimate of the measurement uncertainties associated with the emissions test results be included in the report. The measurement uncertainties given below are based on a 95% confidence level (based on a coverage factor (k=2))

The BTL measurement uncertainty as below table:

### A. AC power line conducted emissions test:

Test Site	Method	Measurement Frequency Range	U,(dB)
DG-C02	CISPR	150kHz ~ 30MHz	2.60

### B. Radiated emissions test:

Test Site	Method	Measurement Frequency Range	U,(dB)
DG-CB01	CISPR	9kHz ~ 30MHz	2.36

Test Site	Method	Measurement Frequency Range	Ant. H / V	U,(dB)
DG-CB03 (3m)	CISPR	30MHz ~ 200MHz	V	4.40
		30MHz ~ 200MHz	H	3.62
		200MHz ~ 1,000MHz	V	4.58
		200MHz ~ 1,000MHz	H	3.98

Test Site	Method	Measurement Frequency Range	U,(dB)
DG-CB03 (3m)	CISPR	1GHz ~ 6GHz	4.08
		6GHz ~ 18GHz	4.62

Test Site	Method	Measurement Frequency Range	U,(dB)
DG-CB03 (1m)	CISPR	18 ~ 26.5 GHz	3.36
		26.5 ~ 40 GHz	3.58



## C. Other Measurement test:

Test Item	Uncertainty
Bandwidth	0.90 %
Maximum Output Power	1.3 dB
Power Spectral Density	1.4 dB
Frequency Stability	2.7 ppm
Temperature	0.8 °C
Humidity	2.2 %

Note: Unless specifically mentioned, the uncertainty of measurement has not been taken into account to declare the compliance or non-compliance to the specification.

**2.3 TEST ENVIRONMENT CONDITIONS**

Test Item	Temperature	Humidity	Test Voltage	Tested By
AC Power Line Conducted Emissions	24°C	58%	AC 120V/60Hz	Hayden Chen
Radiated Emissions-9kHz to 30MHz	22°C	48%	AC 120V/60Hz	Hayden Chen
Radiated Emissions-30MHz to 1000MHz	24°C	46%	AC 120V/60Hz	Max Wang
Radiated Emissions-Above 1000 MHz	24°C	46%	AC 120V/60Hz	Berton Luo
Bandwidth	25°C	49-52%	DC 12V	Steve Zhou
Maximum Output Power	23-24°C	51%	DC 12V	Gene Yang Oliver Wang
Power Spectral Density	25°C	49-52%	DC 12V	Steve Zhou
Frequency Stability	Normal & Extreme	49-52%	Normal & Extreme	Steve Zhou

### 3. GENERAL INFORMATION

#### 3.1 GENERAL DESCRIPTION OF EUT

Equipment	AX1500 Wi-Fi 6 Router
Brand Name	tp-link
Test Model	Archer AX10
Series Model	Archer AX1500
Model Difference(s)	Only differ in model name.
Hardware Version	3.0
Software Version	ax10v3-flash-us-ver1-0-0-P1[20230825-rel33060]-ecc
Power Source	DC Voltage supplied from AC adapter. Model: T120100-2B1
Power Rating	I/P: 100-240V~ 50-60Hz 0.3A O/P: 12.0V --- 1.0A
Operation Frequency Band(s)	UNII-1: 5150 MHz ~ 5250 MHz UNII-3: 5725 MHz ~ 5850 MHz
Modulation Type	IEEE 802.11a/n/ac: OFDM IEEE 802.11ax: OFDMA
Bit Rate of Transmitter	IEEE 802.11a: 54/48/36/24/18/12/9/6 Mbps IEEE 802.11n: up to 300 Mbps IEEE 802.11ac: up to 866.7 Mbps IEEE 802.11ax: up to 1201 Mbps
Maximum Output Power _UNII-1 Non Beamforming	IEEE 802.11a: 26.03 dBm (0.4009 W)
Maximum Output Power _UNII-3 Non Beamforming	IEEE 802.11ax(HE40): 25.81 dBm (0.3811 W)
Maximum Output Power _UNII-1 Beamforming	IEEE 802.11a: 26.03 dBm (0.4009 W)
Maximum Output Power _UNII-3 Beamforming	IEEE 802.11ax(HE40): 25.70 dBm (0.3715 W)

Note:

1. For a more detailed features description, please refer to the manufacturer's specifications or the user's manual.

## 2. Channel List:

IEEE 802.11a IEEE 802.11n(HT20) IEEE 802.11ac(VHT20) IEEE 802.11ax(HE20)		IEEE 802.11n(HT40) IEEE 802.11ac(VHT40) IEEE 802.11ax(HE40)		IEEE 802.11ac(VHT80) IEEE 802.11ax(HE80)	
UNII-1		UNII-1		UNII-1	
Channel	Frequency (MHz)	Channel	Frequency (MHz)	Channel	Frequency (MHz)
36	5180	38	5190	42	5210
40	5200	46	5230		
44	5220				
48	5240				

IEEE 802.11a IEEE 802.11n(HT20) IEEE 802.11ac(VHT20) IEEE 802.11ax(HE20)		IEEE 802.11n(HT40) IEEE 802.11ac(VHT40) IEEE 802.11ax(HE40)		IEEE 802.11ac(VHT80) IEEE 802.11ax(HE80)	
UNII-3		UNII-3		UNII-3	
Channel	Frequency (MHz)	Channel	Frequency (MHz)	Channel	Frequency (MHz)
149	5745	151	5755	155	5775
153	5765	159	5795		
157	5785				
161	5805				
165	5825				

## 3. Antenna Specification:

Ant.	Manufacturer	P/N	Antenna Type	Connector	Gain (dBi)
1	BIG FIELD GLOBAL PTE. LTD.	3101506685	Dipole	N/A	3
2	BIG FIELD GLOBAL PTE. LTD.	3101506301	Dipole	N/A	3

Note:

- This EUT supports CDD, and all antennas have the same gain, Directional gain =  $G_{ANT} + \text{Array Gain}$ . For power measurements, Array Gain=0dB ( $N_{ANT} \leq 4$ ), so the Directional gain=3. For power spectral density measurements,  $N_{ANT}=2$ ,  $N_{SS} = 1$ . So the Directional gain= $G_{ANT} + \text{Array Gain} = G_{ANT} + 10\log(N_{ANT}/N_{SS})\text{dBi} = 3 + 10\log(2/1)\text{dBi} = 6.01$ . Then, the UNII-1 power spectral density limit is  $17 - (6.01 - 6) = 16.99$ , the UNII-3 power spectral density limit is  $30 - (6.01 - 6) = 29.99$ .
- Beamforming gain is 3dB. So Directional gain=3+3=6.

## 4. Table for Antenna Configuration:

For Non Beamforming:

Operating Mode	TX Mode	2TX
IEEE 802.11a		V (Ant. 1 + Ant. 2)
IEEE 802.11n(HT20)		V (Ant. 1 + Ant. 2)
IEEE 802.11n(HT40)		V (Ant. 1 + Ant. 2)
IEEE 802.11ac(VHT20)		V (Ant. 1 + Ant. 2)
IEEE 802.11ac(VHT40)		V (Ant. 1 + Ant. 2)
IEEE 802.11ac(VHT80)		V (Ant. 1 + Ant. 2)
IEEE 802.11ax(HE20)		V (Ant. 1 + Ant. 2)
IEEE 802.11ax(HE40)		V (Ant. 1 + Ant. 2)
IEEE 802.11ax(HE80)		V (Ant. 1 + Ant. 2)

For Beamforming:

Operating Mode	TX Mode	2TX
IEEE 802.11n(HT20)		V (Ant. 1 + Ant. 2)
IEEE 802.11n(HT40)		V (Ant. 1 + Ant. 2)
IEEE 802.11ac(VHT20)		V (Ant. 1 + Ant. 2)
IEEE 802.11ac(VHT40)		V (Ant. 1 + Ant. 2)
IEEE 802.11ac(VHT80)		V (Ant. 1 + Ant. 2)
IEEE 802.11ax(HE20)		V (Ant. 1 + Ant. 2)
IEEE 802.11ax(HE40)		V (Ant. 1 + Ant. 2)
IEEE 802.11ax(HE80)		V (Ant. 1 + Ant. 2)

### 3.2 TEST MODES

The test system was pre-tested based on the consideration of all possible combinations of EUT operation mode.

Pretest Mode	Description
Mode 1	TX A Mode Channel 36/40/48 (UNII-1)
Mode 2	TX AC(VHT20) Mode Channel 36/40/48 (UNII-1)
Mode 3	TX AC(VHT40) Mode Channel 38/46 (UNII-1)
Mode 4	TX AC(VHT80) Mode Channel 42 (UNII-1)
Mode 5	TX AX(HE20) Mode Channel 36/40/48 (UNII-1)
Mode 6	TX AX(HE40) Mode Channel 38/46 (UNII-1)
Mode 7	TX AX(HE80) Mode Channel 42 (UNII-1)
Mode 8	TX A Mode Channel 149/157/165 (UNII-3)
Mode 9	TX AC(VHT20) Mode Channel 149/157/165 (UNII-3)
Mode 10	TX AC(VHT40) Mode Channel 151/159 (UNII-3)
Mode 11	TX AC(VHT80) Mode Channel 155 (UNII-3)
Mode 12	TX AX(HE20) Mode Channel 149/157/165 (UNII-3)
Mode 13	TX AX(HE40) Mode Channel 151/159 (UNII-3)
Mode 14	TX AX(HE80) Mode Channel 155 (UNII-3)
Mode 15	TX A Mode Channel 48 (UNII-1)

Following mode(s) was (were) found to be the worst case(s) and selected for the final test.

<b>AC power line conducted emissions test</b>	
Final Test Mode	Description
Mode 15	TX A Mode Channel 48 (UNII-1)

<b>Radiated Emissions Test - Below 1GHz</b>	
Final Test Mode	Description
Mode 15	TX A Mode Channel 48 (UNII-1)

Radiated Emissions Test - Above 1GHz	
Final Test Mode	Description
Mode 1	TX A Mode Channel 36/40/48 (UNII-1)
Mode 2	TX AC(VHT20) Mode Channel 36/40/48 (UNII-1)
Mode 3	TX AC(VHT40) Mode Channel 38/46 (UNII-1)
Mode 4	TX AC(VHT80) Mode Channel 42 (UNII-1)
Mode 5	TX AX(HE20) Mode Channel 36/40/48 (UNII-1)
Mode 6	TX AX(HE40) Mode Channel 38/46 (UNII-1)
Mode 7	TX AX(HE80) Mode Channel 42 (UNII-1)
Mode 8	TX A Mode Channel 149/157/165 (UNII-3)
Mode 9	TX AC(VHT20) Mode Channel 149/157/165 (UNII-3)
Mode 10	TX AC(VHT40) Mode Channel 151/159 (UNII-3)
Mode 11	TX AC(VHT80) Mode Channel 155 (UNII-3)
Mode 12	TX AX(HE20) Mode Channel 149/157/165 (UNII-3)
Mode 13	TX AX(HE40) Mode Channel 151/159 (UNII-3)
Mode 14	TX AX(HE80) Mode Channel 155 (UNII-3)

Maximum Output Power_ Beamforming & Other Conducted Test	
Final Test Mode	Description
Mode 2	TX AC(VHT20) Mode Channel 36/40/48 (UNII-1)
Mode 3	TX AC(VHT40) Mode Channel 38/46 (UNII-1)
Mode 4	TX AC(VHT80) Mode Channel 42 (UNII-1)
Mode 5	TX AX(HE20) Mode Channel 36/40/48 (UNII-1)
Mode 6	TX AX(HE40) Mode Channel 38/46 (UNII-1)
Mode 7	TX AX(HE80) Mode Channel 42 (UNII-1)
Mode 9	TX AC(VHT20) Mode Channel 149/157/165 (UNII-3)
Mode 10	TX AC(VHT40) Mode Channel 151/159 (UNII-3)
Mode 11	TX AC(VHT80) Mode Channel 155 (UNII-3)
Mode 12	TX AX(HE20) Mode Channel 149/157/165 (UNII-3)
Mode 13	TX AX(HE40) Mode Channel 151/159 (UNII-3)
Mode 14	TX AX(HE80) Mode Channel 155 (UNII-3)

Maximum Output Power_Non Beamforming & Other Conducted Test	
Final Test Mode	Description
Mode 1	TX A Mode Channel 36/40/48 (UNII-1)
Mode 2	TX AC(VHT20) Mode Channel 36/40/48 (UNII-1)
Mode 3	TX AC(VHT40) Mode Channel 38/46 (UNII-1)
Mode 4	TX AC(VHT80) Mode Channel 42 (UNII-1)
Mode 5	TX AX(HE20) Mode Channel 36/40/48 (UNII-1)
Mode 6	TX AX(HE40) Mode Channel 38/46 (UNII-1)
Mode 7	TX AX(HE80) Mode Channel 42 (UNII-1)
Mode 8	TX A Mode Channel 149/157/165 (UNII-3)
Mode 9	TX AC(VHT20) Mode Channel 149/157/165 (UNII-3)
Mode 10	TX AC(VHT40) Mode Channel 151/159 (UNII-3)
Mode 11	TX AC(VHT80) Mode Channel 155 (UNII-3)
Mode 12	TX AX(HE20) Mode Channel 149/157/165 (UNII-3)
Mode 13	TX AX(HE40) Mode Channel 151/159 (UNII-3)
Mode 14	TX AX(HE80) Mode Channel 155 (UNII-3)

Note:

- (1) For AC power line conducted emissions and radiated emission below 1 GHz test, the TX A Mode Channel 48 (UNII-1) is found to be the worst case and recorded.
- (2) For radiated emission above 1 GHz test, the spurious points of 1GHz~26.5GHz and 26.5GHz~40GHz have been pre-tested and in this report only recorded the worst case. The remaining spurious points are all below the limit value of 20dB.
- (3) All the bit rate of transmitter have been tested and found the lowest rate is found to be the worst case and recorded.
- (4) VHT20/VHT40 covers HT20/HT40, due to same modulation. The power setting for 802.11n HT20 and HT40 are the same or lower than 802.11ac VHT20 and VHT40.
- (5) The measurements for Output Power are tested, the Non Beamforming and Beamforming are recorded in the report. The worst case is Non Beamforming and only the worst case is documented for other test items.
- (6) IEEE 802.11ax mode only supports full RU, so only the full RU is evaluated and measured inside report.
- (7) For radiated emission above 1 GHz test, the polarization of Vertical and Horizontal are evaluated, the worst case is Vertical and recorded.
- (8) The chip of the product with or without a shield cover, so radiated emission and power were evaluated. It found that chip of the product without a shield cover was worst case and record.

### 3.3 PARAMETERS OF TEST SOFTWARE

#### Non Beamforming

UNII-1			
Test Software Version	IPOP V4.0		
Frequency (MHz)	5180	5200	5240
IEEE 802.11a	1800	2230	2300
IEEE 802.11ac(VHT20)	1850	2100	2100
IEEE 802.11ax(HE20)	1800	2100	2100
Frequency (MHz)	5190	5230	
IEEE 802.11ac(VHT40)	1700	2100	
IEEE 802.11ax(HE40)	1700	2100	
Frequency (MHz)	5210		
IEEE 802.11ac(VHT80)	1650		
IEEE 802.11ax(HE80)	1650		

UNII-3			
Test Software Version	IPOP V4.0		
Frequency (MHz)	5745	5785	5825
IEEE 802.11a	2150	2000	2050
IEEE 802.11ac(VHT20)	2100	2100	2100
IEEE 802.11ax(HE20)	2100	2100	2100
Frequency (MHz)	5755	5795	
IEEE 802.11ac(VHT40)	2100	2100	
IEEE 802.11ax(HE40)	2100	2100	
Frequency (MHz)	5775		
IEEE 802.11ac(VHT80)	2000		
IEEE 802.11ax(HE80)	2000		



### Beamforming

UNII-1			
Test Software Version	IPOP V4.0		
Frequency (MHz)	5180	5200	5240
IEEE 802.11ac(VHT20)	1800	2050	2050
IEEE 802.11ax(HE20)	1750	2050	2050
Frequency (MHz)	5190	5230	/
IEEE 802.11ac(VHT40)	1650	2050	/
IEEE 802.11ax(HE40)	1650	2050	/
Frequency (MHz)	5210	/	/
IEEE 802.11ac(VHT80)	1600	/	/
IEEE 802.11ax(HE80)	1600	/	/

UNII-3			
Test Software Version	IPOP V4.0		
Frequency (MHz)	5745	5785	5825
IEEE 802.11ac(VHT20)	2050	2050	2050
IEEE 802.11ax(HE20)	2050	2050	2050
Frequency (MHz)	5755	5795	/
IEEE 802.11ac(VHT40)	2050	2050	/
IEEE 802.11ax(HE40)	2050	2050	/
Frequency (MHz)	5775	/	/
IEEE 802.11ac(VHT80)	1950	/	/
IEEE 802.11ax(HE80)	1950	/	/

### 3.4 DUTY CYCLE

If duty cycle is  $\geq 98\%$ , duty factor is not required.  
 If duty cycle is  $< 98\%$ , duty factor shall be considered.  
 The output power = measured power + duty factor.  
 The power spectral density = measured power spectral density + duty factor.

**IEEE 802.11a**

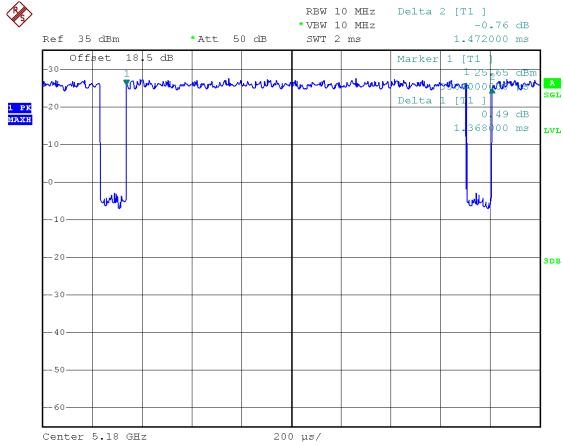

Date: 14.DEC.2023 15:33:27

Duty cycle =  $1.368 \text{ ms} / 1.472 \text{ ms} = 92.93\%$   
 Duty Factor =  $10 \log(1 / \text{Duty cycle}) = 0.32$

**IEEE 802.11ac(VHT20)**

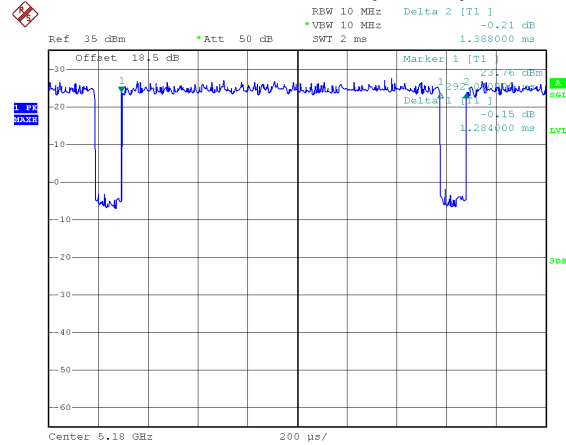

Date: 14.DEC.2023 15:37:07

Duty cycle =  $1.284 \text{ ms} / 1.388 \text{ ms} = 92.51\%$   
 Duty Factor =  $10 \log(1 / \text{Duty cycle}) = 0.34$

**IEEE 802.11ac(VHT40)**

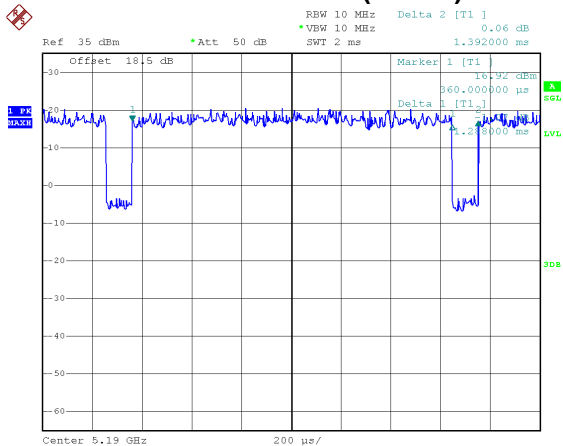

Date: 14.DEC.2023 15:40:38

Duty cycle =  $1.288 \text{ ms} / 1.392 \text{ ms} = 92.53\%$   
 Duty Factor =  $10 \log(1 / \text{Duty cycle}) = 0.34$

**IEEE 802.11ac(VHT80)**

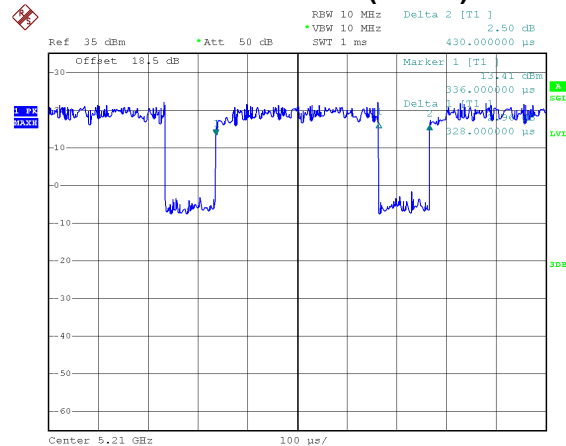

Date: 14.DEC.2023 16:45:34

Duty cycle =  $0.328 \text{ ms} / 0.430 \text{ ms} = 76.28\%$   
 Duty Factor =  $10 \log(1 / \text{Duty cycle}) = 1.18$

### IEEE 802.11ax(HE20)

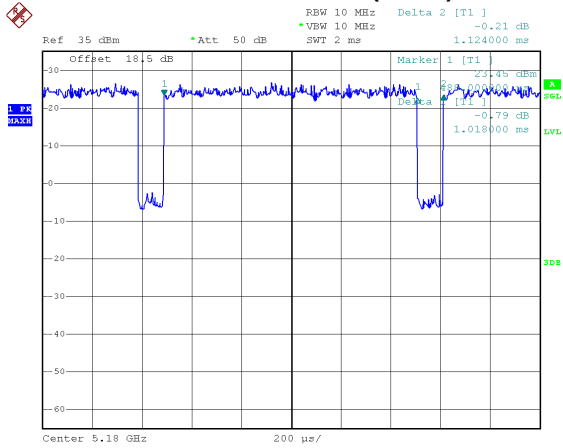

Date: 14.DEC.2023 16:29:21

Duty cycle = 1.018 ms / 1.124 ms = 90.57%  
 Duty Factor = 10 log(1 / Duty cycle) = 0.43

### IEEE 802.11ax(HE40)

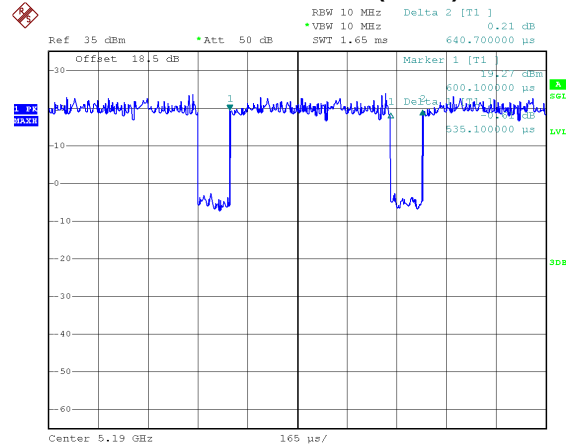

Date: 14.DEC.2023 16:34:03

Duty cycle = 0.535 ms / 0.641 ms = 83.52%  
 Duty Factor = 10 log(1 / Duty cycle) = 0.78

### IEEE 802.11ax(HE80)

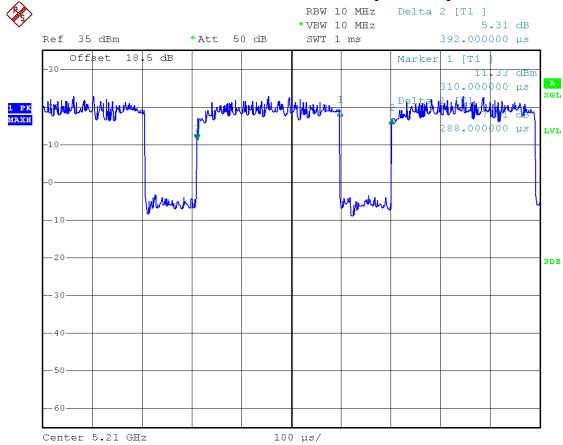

Date: 14.DEC.2023 16:36:24

Duty cycle = 0.288 ms / 0.392 ms = 73.47%  
 Duty Factor = 10 log(1 / Duty cycle) = 1.34

**NOTE:**

For IEEE 802.11a:

For radiated emissions frequency above 1 GHz, the resolution bandwidth of test receiver/spectrum analyzer is 1 MHz and the video bandwidth is 731 Hz (Duty cycle < 98%).

For IEEE 802.11ac(VHT20):

For radiated emissions frequency above 1 GHz, the resolution bandwidth of test receiver/spectrum analyzer is 1 MHz and the video bandwidth is 779 Hz (Duty cycle < 98%).

For IEEE 802.11ac(VHT40):

For radiated emissions frequency above 1 GHz, the resolution bandwidth of test receiver/spectrum analyzer is 1 MHz and the video bandwidth is 776 Hz (Duty cycle < 98%).

For IEEE 802.11ac(VHT80):

For radiated emissions frequency above 1 GHz, the resolution bandwidth of test receiver/spectrum analyzer is 1 MHz and the video bandwidth is 3049 Hz (Duty cycle < 98%).

For IEEE 802.11ax(HE20):

For radiated emissions frequency above 1 GHz, the resolution bandwidth of test receiver/spectrum analyzer is 1 MHz and the video bandwidth is 982 Hz (Duty cycle < 98%).

For IEEE 802.11ax(HE40):

For radiated emissions frequency above 1 GHz, the resolution bandwidth of test receiver/spectrum analyzer is 1 MHz and the video bandwidth is 1869 Hz (Duty cycle < 98%).

For IEEE 802.11ax(HE80):

For radiated emissions frequency above 1 GHz, the resolution bandwidth of test receiver/spectrum analyzer is 1 MHz and the video bandwidth is 3472 Hz (Duty cycle < 98%).

### 3.5 BLOCK DIAGRAM SHOWING THE CONFIGURATION OF SYSTEM TESTED

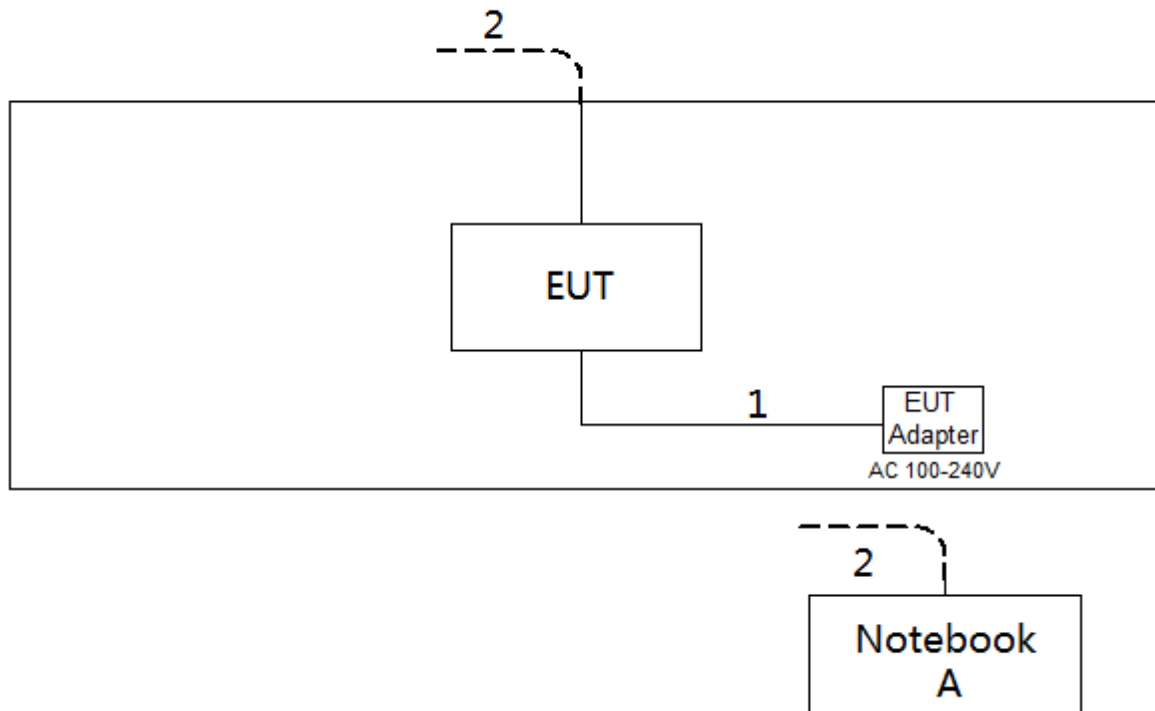

### 3.6 SUPPORT UNITS

Item	Equipment	Brand	Model No.	Series No.
A	Notebook	Dell	Inspiron 15-7559	N/A

Item	Cable Type	Shielded Type	Ferrite Core	Length
1	DC Cable	NO	NO	1.5m
2	RJ45 Cable	NO	NO	10m

### 3.7 CUSTOMER INFORMATION DESCRIPTION

- 1) The antenna gain and beamforming gain are provided by the manufacturer.
- 2) Except for AC power line conducted emissions and radiated emissions, the results of all test items include cable losses. All cable losses are provided by the testing laboratory.

## 4. AC POWER LINE CONDUCTED EMISSIONS

### 4.1 LIMIT

Frequency (MHz)	Limit (dB $\mu$ V)	
	Quasi-peak	Average
0.15 - 0.5	66 to 56*	56 to 46*
0.5 - 5.0	56	46
5.0 - 30.0	60	50

**NOTE:**

- (1) The tighter limit applies at the band edges.
- (2) The limit of " \* " marked band means the limitation decreases linearly with the logarithm of the frequency in the range.

### 4.2 TEST PROCEDURE

- a. The EUT was placed 0.8 meters from the horizontal ground plane with EUT being connected to the power mains through a line impedance stabilization network (LISN). All other support equipment powered from additional LISN(s). The LISN provide 50 Ohm/ 50uH of coupling impedance for the measuring instrument.
- b. Interconnecting cables that hang closer than 40 cm to the ground plane shall be folded back and forth in the center forming a bundle 30 to 40 cm long.
- c. I/O cables that are not connected to a peripheral shall be bundled in the center. The end of the cable may be terminated, if required, using the correct terminating impedance. The overall length shall not exceed 1 m.
- d. LISN at least 80 cm from nearest part of EUT chassis.
- e. For the actual test configuration, please refer to the related Item -EUT Test Photos.

The following table is the setting of the receiver:

Receiver Parameter	Setting
Start Frequency	0.15 MHz
Stop Frequency	30 MHz
IF Bandwidth	9 kHz

### 4.3 DEVIATION FROM TEST STANDARD

No deviation

#### 4.4 TEST SETUP

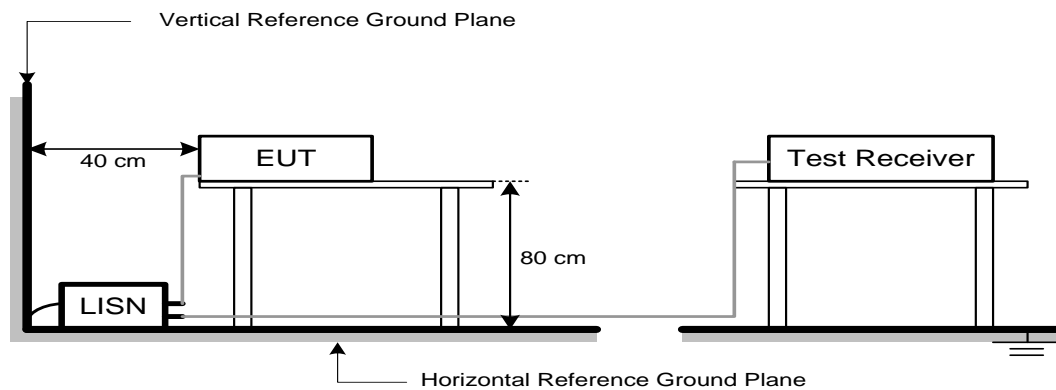

#### 4.5 EUT OPERATION CONDITIONS

The EUT was configured for testing in a typical fashion (as a customer would normally use it). The EUT has been programmed to continuously transmit during test. This operating condition was tested and used to collect the included data.

The EUT was programmed to be in continuously transmitting/TX mode.

#### 4.6 TEST RESULTS

Please refer to the APPENDIX A.

## 5. RADIATED EMISSIONS

### 5.1 LIMIT

In case the emission fall within the restricted band specified on 15.205(a), then the 15.209(a) limit in the table below has to be followed.

#### LIMITS OF RADIATED EMISSIONS MEASUREMENT (9 kHz to 1000 MHz)

Frequency (MHz)	Field Strength (microvolts/meter)	Measurement Distance (meters)
0.009-0.490	2400/F(kHz)	300
0.490-1.705	24000/F(kHz)	30
1.705-30.0	30	30
30-88	100	3
88-216	150	3
216-960	200	3
Above 960	500	3

#### LIMITS OF UNWANTED EMISSION OUT OF THE RESTRICTED BANDS (Above 1000 MHz)

Frequency (MHz)	EIRP Limit (dBm/MHz)	Equivalent Field Strength at 3m (dB $\mu$ V/m)
5150-5250	-27	68.2
5725-5850 NOTE (2)	-27	68.2
	10	105.2
	15.6	110.8
	27	122.2

#### NOTE:

- (1) The following formula is used to convert the equipment isotropic radiated power (eirp) to field strength:

$$E = \frac{1000000\sqrt{30P}}{3} \mu\text{V/m, where P is the eirp (Watts)}$$

- (2) According to 15.407(b)(4)(i), all emissions shall be limited to a level of -27 dBm/MHz at 75 MHz or more above or below the band edge increasing linearly to 10 dBm/MHz at 25 MHz above or below the band edge, and from 25 MHz above or below the band edge increasing linearly to a level of 15.6 dBm/MHz at 5 MHz above or below the band edge, and from 5 MHz above or below the band edge increasing linearly to a level of 27 dBm/MHz at the band edge.



## 5.2 TEST PROCEDURE

- a. The measuring distance of 3 m shall be used for measurements. The EUT was placed on the top of a rotating table 0.8 meter above the ground at a 3 meter semi-anechoic chamber. The table was rotated 360 degrees to determine the position of the highest radiation.(below 1GHz)
- b. The measuring distance of 3 m shall be used for measurements. The EUT was placed on the top of a rotating table 1.5 meter above the ground at a 3 meter semi-anechoic chamber. The table was rotated 360 degrees to determine the position of the highest radiation.(above 1GHz)
- c. The height of the equipment or of the substitution antenna shall be 0.8m or 1.5m; the height of the test antenna shall vary between 1 m to 4 m. Both horizontal and vertical polarizations of the antenna are set to make the measurement.
- d. For each suspected emission, the EUT was arranged to its worst case and then the antenna was tuned to heights find the maximum reading (used Bore sight function).
- e. The receiver system was set to peak and average detect function and specified bandwidth with maximum hold mode when the test frequency is above 1 GHz.
- f. The initial step in collecting radiated emission data is a receiver peak detector mode pre-scanning the measurement frequency range. Significant peaks are then marked and then Quasi Peak detector mode re-measured.
- g. All readings are Peak unless otherwise stated QP in column of Note. Peak denotes that the Peak reading compliance with the QP Limits and then QP Mode measurement didn't perform. (below 1 GHz)
- h. All readings are Peak Mode value unless otherwise stated AVG in column of Note. If the Peak Mode Measured value compliance with the Peak Limits and lower than AVG Limits, the EUT shall be deemed to meet both Peak & AVG Limits and then only Peak Mode was measured, but AVG Mode didn't perform. (above 1 GHz)
- i. For the actual test configuration, please refer to the related Item –EUT Test Photos.

The following table is the setting of the receiver:

Spectrum Parameters	Setting
Start ~ Stop Frequency	9 kHz~150 kHz for RBW 200 Hz
Start ~ Stop Frequency	0.15 MHz~30 MHz for RBW 9 kHz
Start ~ Stop Frequency	30 MHz~1000 MHz for RBW 100 kHz

Spectrum Parameters	Setting
Start Frequency	1000 MHz
Stop Frequency	10th carrier harmonic or 40 GHz, whichever is lower
RBW / VBW (Emission in restricted band)	1 MHz / 3 MHz for PK value 1 MHz / 1/T Hz for AVG value

Receiver Parameters	Setting
Start ~ Stop Frequency	9 kHz~90 kHz for PK/AVG detector
Start ~ Stop Frequency	90 kHz~110 kHz for QP detector
Start ~ Stop Frequency	110 kHz~490 kHz for PK/AVG detector
Start ~ Stop Frequency	490 kHz~30 MHz for QP detector
Start ~ Stop Frequency	30 MHz~1000 MHz for QP detector
Start ~ Stop Frequency	1 GHz~40 GHz for PK/AVG detector

### 5.3 DEVIATION FROM TEST STANDARD

No deviation.

### 5.4 TEST SETUP

#### 9 kHz to 30 MHz

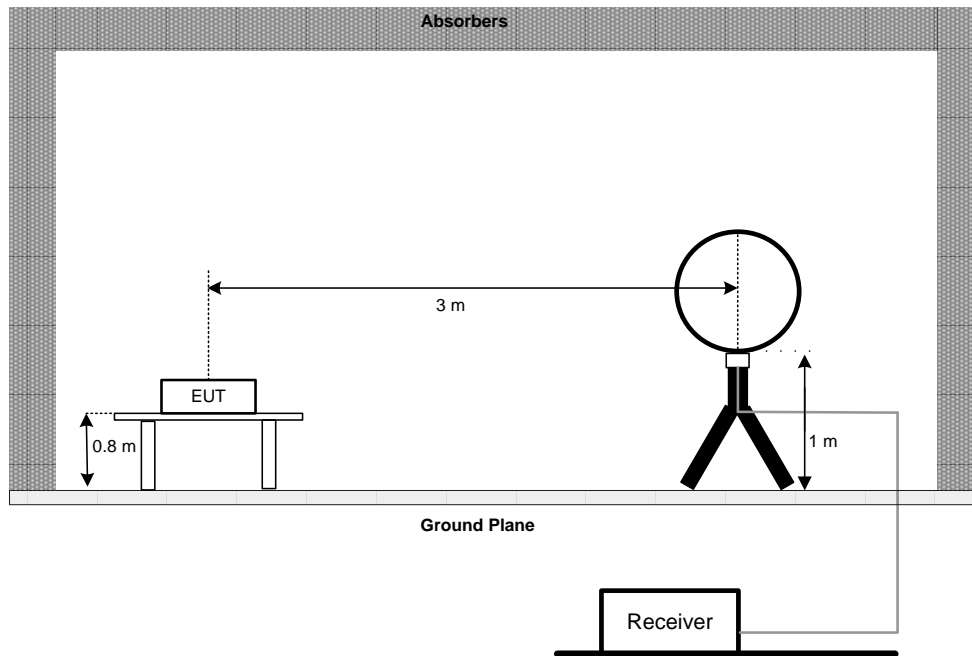

#### 30 MHz to 1 GHz

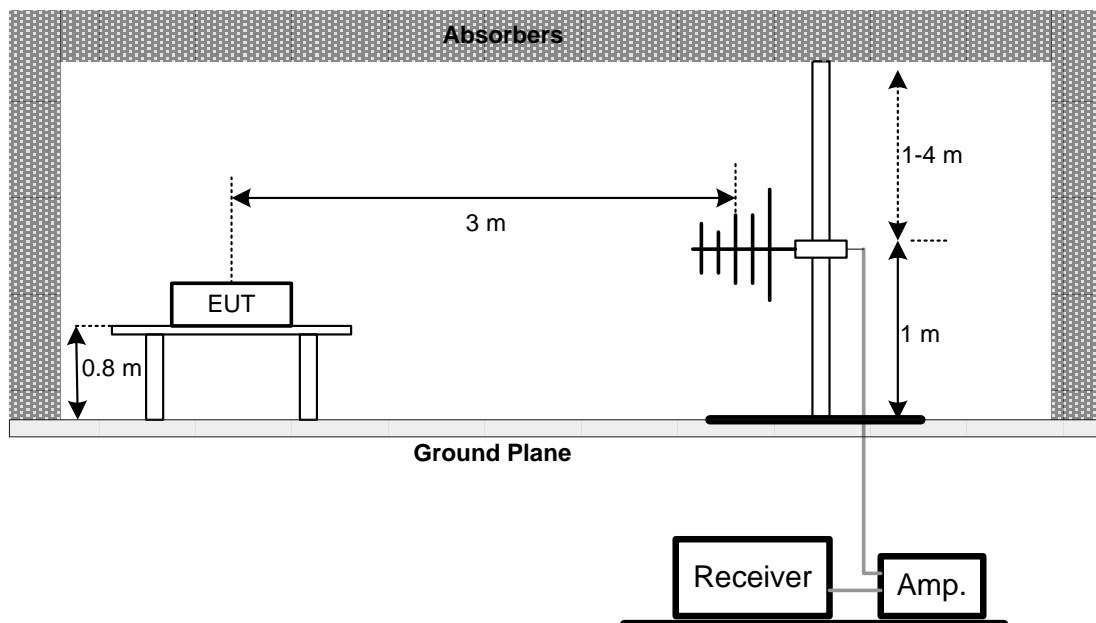

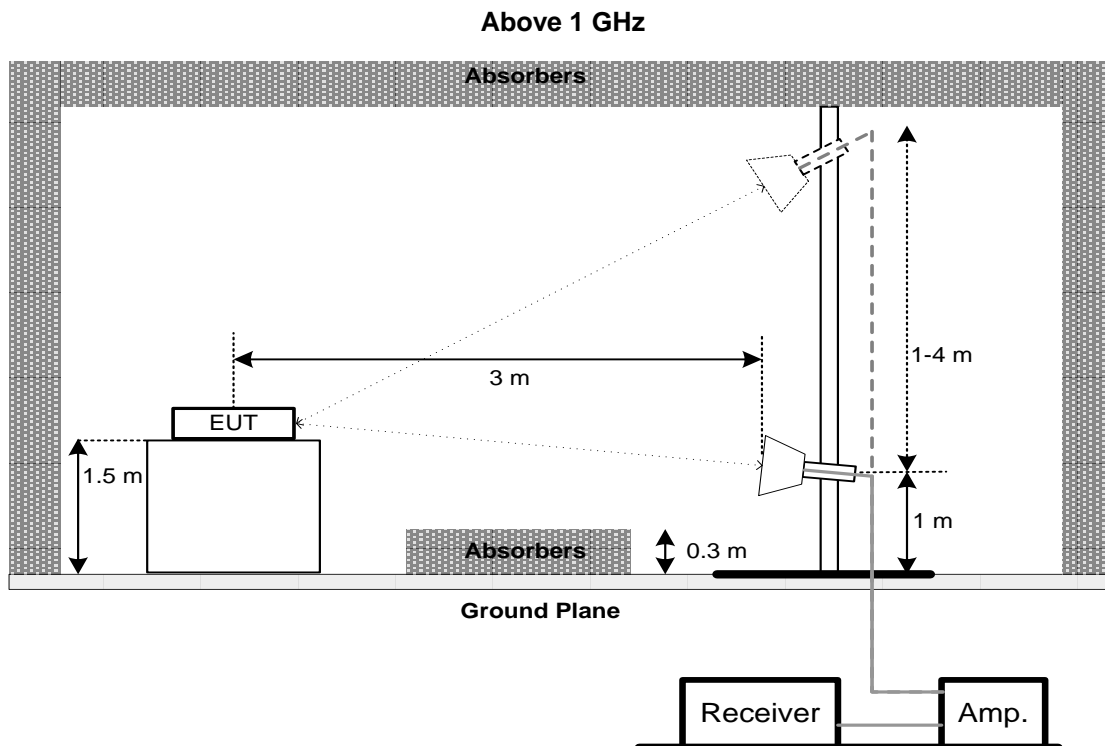

### 5.5 EUT OPERATION CONDITIONS

The EUT tested system was configured as the statements of 3.5 unless otherwise a special operating condition is specified in the follows during the testing.

### 5.6 TEST RESULTS - 9 KHZ TO 30 MHZ

Please refer to the APPENDIX B.

Remark:

- (1) Distance extrapolation factor =  $40 \log (\text{specific distance} / \text{test distance})$  (dB).
- (2) Limit line = specific limits (dBuV) + distance extrapolation factor.

### 5.7 TEST RESULTS - 30 MHZ TO 1000 MHZ

Please refer to the APPENDIX C.

### 5.8 TEST RESULTS - ABOVE 1000 MHZ

Please refer to the APPENDIX D.

Remark:

- (1) No limit: This is fundamental signal, the judgment is not applicable.  
For fundamental signal judgment was referred to Peak output test.

## 6. BANDWIDTH

### 6.1 LIMIT

Section	Test Item	Limit	Frequency Range (MHz)
FCC 15.407(a)	26 dB Bandwidth	-	5150-5250
FCC 15.407(e)	6 dB Bandwidth	Minimum 500 kHz	5725-5850

### 6.2 TEST PROCEDURE

a. The EUT was directly connected to the spectrum analyzer and antenna output port as show in the block diagram below

b. Spectrum Setting:

For UNII-1:

Spectrum Parameter	Setting
Span Frequency	> 26 dB Bandwidth
RBW	Appromiximately 1% of the emission bandwidth
VBW	> RBW
Detector	Peak
Trace	Max Hold
Sweep Time	Auto

For UNII-3:

Spectrum Parameter	Setting
Span Frequency	> 6 dB Bandwidth
RBW	100 kHz
VBW	300 kHz
Detector	Peak
Trace	Max Hold
Sweep Time	Auto

For 99% Occupied Bandwidth:

Spectrum Parameter	Setting
Span Frequency	1.5 times to 5 times the OBW
RBW	1% to 5% of the OBW
VBW	$\geq 3 \cdot \text{RBW}$
Detector	Peak
Trace	Max Hold
Sweep Time	Auto

c. Measured the spectrum width with power higher than 26 dB / 6 dB below carrier.

### 6.3 DEVIATION FROM STANDARD

No deviation.

**6.4 TEST SETUP****6.5 EUT OPERATION CONDITIONS**

The EUT was programmed to be in continuously transmitting mode.

**6.6 TEST RESULTS**

Please refer to the APPENDIX E.

## 7. MAXIMUM OUTPUT POWER

### 7.1 LIMIT

Section	Test Item	Limit	Frequency Range (MHz)
FCC 15.407(a)	Maximum Output Power	AP device: 1 Watt (30 dBm) Client device: 250 mW (23.98 dBm)	5150-5250
		1 Watt (30dBm)	5725-5850

Note:

- a. For an indoor access point operating in the band 5.15-5.25 GHz, the maximum conducted output power over the frequency band of operation shall not exceed 1 W provided the maximum antenna gain does not exceed 6 dBi. In addition, the maximum power spectral density shall not exceed 17 dBm in any 1 megahertz band. If transmitting antennas of directional gain greater than 6 dBi are used, both the maximum conducted output power and the maximum power spectral density shall be reduced by the amount in dB that the directional gain of the antenna exceeds 6 dBi.
- b. For an indoor access point operating in the band 5.15-5.25 GHz, the maximum conducted output power over the frequency band of operation shall not exceed 1 W provided the maximum antenna gain does not exceed 6 dBi. In addition, the maximum power spectral density shall not exceed 17 dBm in any 1 megahertz band. If transmitting antennas of directional gain greater than 6 dBi are used, both the maximum conducted output power and the maximum power spectral density shall be reduced by the amount in dB that the directional gain of the antenna exceeds 6 dBi.

### 7.2 TEST PROCEDURE

- a. The EUT was directly connected to the peak power analyzer and antenna output port as show in the block diagram below.
- b. The test was performed in accordance with method of FCC KDB 789033 D02 General UNII Test Procedures New Rules v02r01.

### 7.3 DEVIATION FROM STANDARD

No deviation.

### 7.4 TEST SETUP

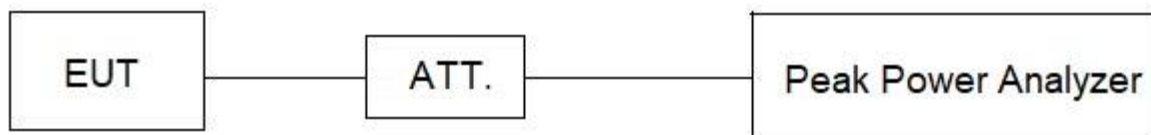

### 7.5 EUT OPERATION CONDITIONS

The EUT was programmed to be in continuously transmitting mode.

### 7.6 TEST RESULTS

Please refer to the APPENDIX F.

## 8. POWER SPECTRAL DENSITY

### 8.1 LIMIT

Section	Test Item	Limit	Frequency Range (MHz)
FCC 15.407(a)	Power Spectral Density	AP device: 17 dBm/MHz Client device: 11 dBm/MHz	5150-5250
		30 dBm/500 kHz	5725-5850

### 8.2 TEST PROCEDURE

- The EUT was directly connected to the spectrum analyzer and antenna output port as show in the block diagram below.
- Spectrum Setting:

For UNII-1:

Spectrum Parameter	Setting
Span Frequency	Encompass the entire emissions bandwidth (EBW) of the signal
RBW	1 MHz.
VBW	3 MHz.
Detector	RMS
Trace average	100 trace
Sweep Time	Auto

For UNII-3:

Spectrum Parameter	Setting
Span Frequency	Encompass the entire emissions bandwidth (EBW) of the signal
RBW	100 kHz.
VBW	300 kHz.
Detector	RMS
Trace average	100 trace
Sweep Time	Auto

Note:

- For UNII-3, according to KDB publication 789033 D02 General UNII Test Procedures New Rules v02r01, section II.F.5., it is acceptable to set RBW at 100kHz and VBW at 300kHz if the spectrum analyzer does not have 500 kHz RBW. Then, add  $10 \log (500 \text{ kHz}/100 \text{ kHz})$  to the measured result, i.e. 7 dB.
- During the test of U-NII 3 PSD, the measurement result with RBW=100kHz has been added 7 dB by compensating offset. For example, the cable loss is 25.5 dB, and the final offset is  $18.5 + 7 = 25.5$  dB when RBW=100kHz is used.

### 8.3 DEVIATION FROM STANDARD

No deviation.

#### 8.4 TEST SETUP



#### 8.5 EUT OPERATION CONDITIONS

The EUT was programmed to be in continuously transmitting mode.

#### 8.6 TEST RESULTS

Please refer to the APPENDIX G.



## 9. FREQUENCY STABILITY

### 9.1 LIMIT

Section	Test Item	Limit	Frequency Range (MHz)
FCC 15.407(g)	Frequency Stability	An emission is maintained within the band of operation under all conditions of normal operation as specified in the users manual.	5150-5250
			5725-5850

### 9.2 TEST PROCEDURE

- a. The EUT was directly connected to the spectrum analyzer and antenna output port as show in the block diagram below.
- b. Spectrum Setting:

Spectrum Parameter	Setting
Span Frequency	Entire absence of modulation emissions bandwidth
RBW	10 kHz
VBW	10 kHz
Detector	Peak
Trace	Max Hold
Sweep Time	Auto

- c. The test extreme voltage is to change the primary supply voltage from 85 to 115 percent of the nominal value.
- d. User manual temperature is 0°C~40°C.

### 9.3 DEVIATION FROM STANDARD

No deviation.

### 9.4 TEST SETUP

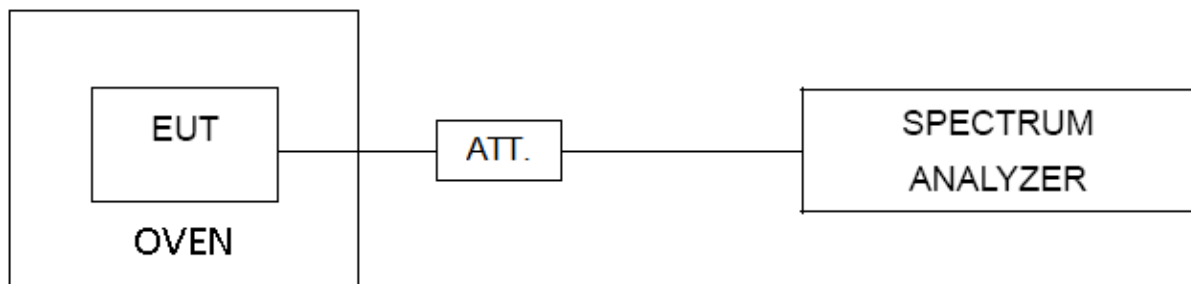

### 9.5 EUT OPERATION CONDITIONS

The EUT was programmed to be in continuously transmitting mode.

### 9.6 TEST RESULTS

Please refer to the APPENDIX H.

**10. MEASUREMENT INSTRUMENTS LIST**

AC Power Line Conducted Emissions					
Item	Kind of Equipment	Manufacturer	Type No.	Serial No.	Calibrated until
1	EMI Test Receiver	R&S	ESR3	103027	Jun. 16, 2024
2	TWO-LINE V-NETWORK	R&S	ENV216	101447	Dec. 22, 2024
3	Measurement Software	Farad	EZ-EMC Ver.NB-03A1-01	N/A	N/A
4	Cable	N/A	RG223	12m	Sep. 13, 2024
5	643 Shield Room	ETS	6*4*3	N/A	N/A

Radiated Emissions - 9 kHz to 30 MHz					
Item	Kind of Equipment	Manufacturer	Type No.	Serial No.	Calibrated until
1	Active Loop Antenna	Schwarzbeck	FMZB 1513-60B	1513-60 B-034	Apr. 01, 2024
2	MXE EMI Receiver	Keysight	N9038A	MY56400091	Dec. 22, 2024
3	Cable	N/A	RW2350-3.8A-NMB M-1.5M	N/A	Jun. 10, 2024
4	Measurement Software	Farad	EZ-EMC Ver.NB-03A1-01	N/A	N/A
5	966 Chamber room	ETS	9*6*6	N/A	Jul. 11, 2024

Radiated Emissions - 30 MHz to 1 GHz					
Item	Kind of Equipment	Manufacturer	Type No.	Serial No.	Calibrated until
1	Trilog-Broadband Antenna	Schwarzbeck	VULB 9168	1461	Nov. 28, 2024
2	Attenuator	EMC INSTRUMENT	EMCI-N-6-06	AT-06010	Nov. 28, 2024
3	Preamplifier	EMC INSTRUMENT	EMC001330	980863	Nov.17,2024
4	Cable	RegalWay	LMR400-NMNM-12 .5m	N/A	Jul. 04, 2024
5	Cable	RegalWay	LMR400-NMNM-3 m	N/A	Jul. 04, 2024
6	Cable	RegalWay	LMR400-NMNM-0. 5m	N/A	Jul. 04, 2024
7	Receiver	Agilent	N9038A	MY52130039	Jan. 07, 2024
8	Positioning Controller	MF	MF-7802	N/A	N/A
9	Measurement Software	Farad	EZ-EMC Ver.NB-03A1-01	N/A	N/A
10	966 Chamber room	CM	9*6*6	N/A	May 17, 2024

Radiated Emissions - Above 1 GHz					
Item	Kind of Equipment	Manufacturer	Type No.	Serial No.	Calibrated until
1	Receiver	Agilent	N9038A	MY52130039	Jan. 07, 2024
2	Preamplifier	EMC INSTRUMENT	EMC118A45SE	980888	Nov. 17, 2024
3	EXA Spectrum Analyzer	Keysight	N9010A	MY55150209	Jun. 16, 2024
4	Double Ridged Guide Antenna	ETS	3115	75789	May 31,2024
5	Cable	RegalWay	A81-SMAMSMAM-12.5M	N/A	Aug. 08, 2024
6	Cable	RegalWay	RWLP50-4.0A-NM RASM-2.5M	N/A	Aug. 08, 2024
7	Cable	RegalWay	RWLP50-4.0A-NM RASMRA-0.8M	N/A	Aug. 08, 2024
8	Low Noise Amplifier	CONNPHY	CLN-18G40G-4330-K	619413	Jul. 06, 2024
9	Cable	RegalWay	RWLP50-2.6A-2.92 M2.92M-1.1M	N/A	Jul. 26, 2024
10	Cable	Tonscend	HF160-KMKM-3M	N/A	Jul. 26, 2024
11	Broad-Band Horn Antenna	Schwarzbeck	BBHA9170(3m)	9170-319	Jun. 20, 2024
12	966 Chamber room	CM	9*6*6	N/A	May 17,2024
13	Positioning Controller	MF	MF-7802	N/A	N/A

Bandwidth & Power Spectral Density					
Item	Kind of Equipment	Manufacturer	Type No.	Serial No.	Calibrated until
1	Spectrum Analyzer	R&S	FSP40	100185	Jun. 16, 2024
2	Attenuator	Talent Microwave	TA10A0-S-26.5	N/A	N/A
3	Attenuator	Talent Microwave	TA10A0-S-26.5	N/A	N/A
4	DC Block	N/A	N/A	N/A	N/A
5	Measurement Software	BTL	BTL Conducted Test	N/A	N/A

Maximum Output Power					
Item	Kind of Equipment	Manufacturer	Type No.	Serial No.	Calibrated until
1	Peak Power Analyzer	Keysight	8990B	MY51000506	Jun. 17, 2024
2	Wideband power sensor	Keysight	N1923A	MY58310004	Jun. 17, 2024
3	Attenuator	Talent Microwave	TA10A2-S-18	N/A	N/A

Frequency Stability					
Item	Kind of Equipment	Manufacturer	Type No.	Serial No.	Calibrated until
1	Spectrum Analyzer	R&S	FSP40	100185	Jun. 16, 2024
2	Attenuator	Talent Microwave	TA10A0-S-26.5	N/A	N/A
3	Attenuator	Talent Microwave	TA10A0-S-26.5	N/A	N/A
4	DC Block	N/A	N/A	N/A	N/A
5	Measurement Software	BTL	BTL Conducted Test	N/A	N/A
6	Table top type high and low temperature test chamber	CEPREI	CEEC-M64T-40	15-008	Dec. 22, 2024
7	Multi-output DC Power Supply	GW Instek	GPC-3030DN	EK880675	Jul. 07, 2024

Remark: "N/A" denotes no model name, serial no. or calibration specified.

All calibration period of equipment list is one year.

**11. EUT TEST PHOTOS****AC Power Line Conducted Emissions Test Photos**

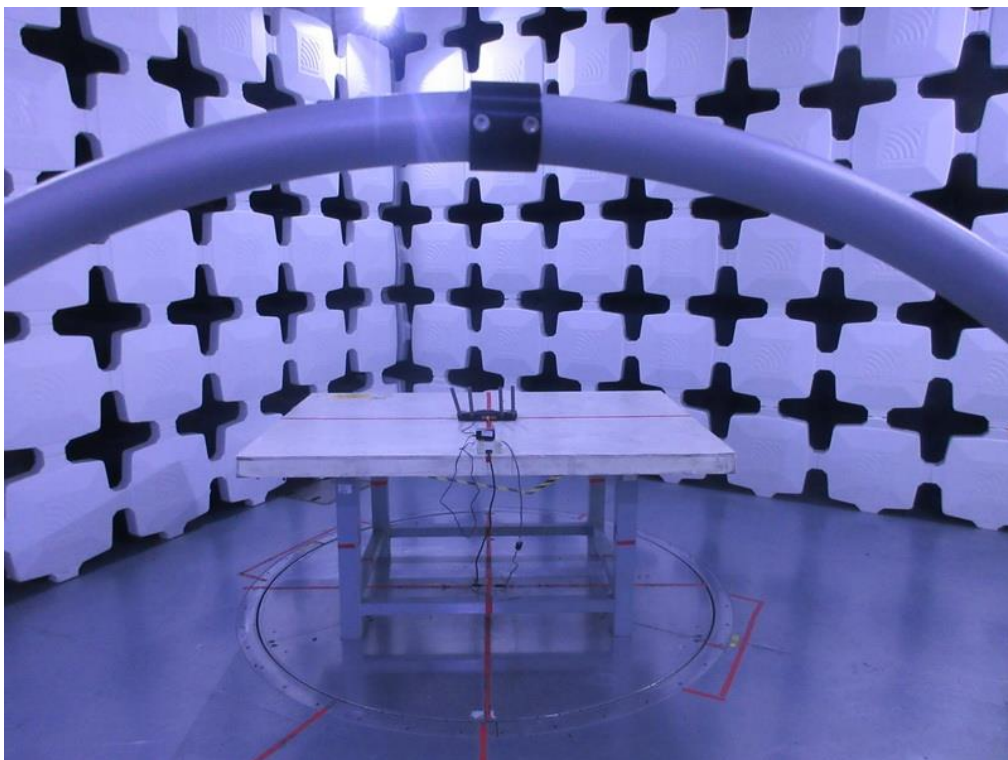
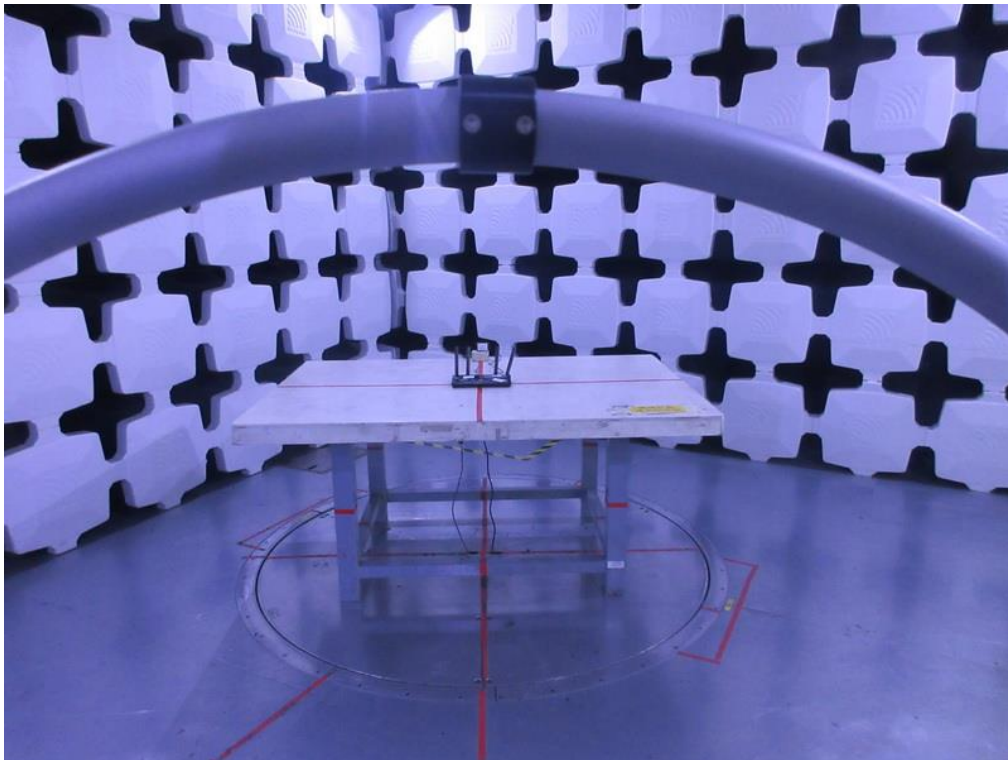
**Radiated Emissions Test Photos****9 kHz to 30 MHz**

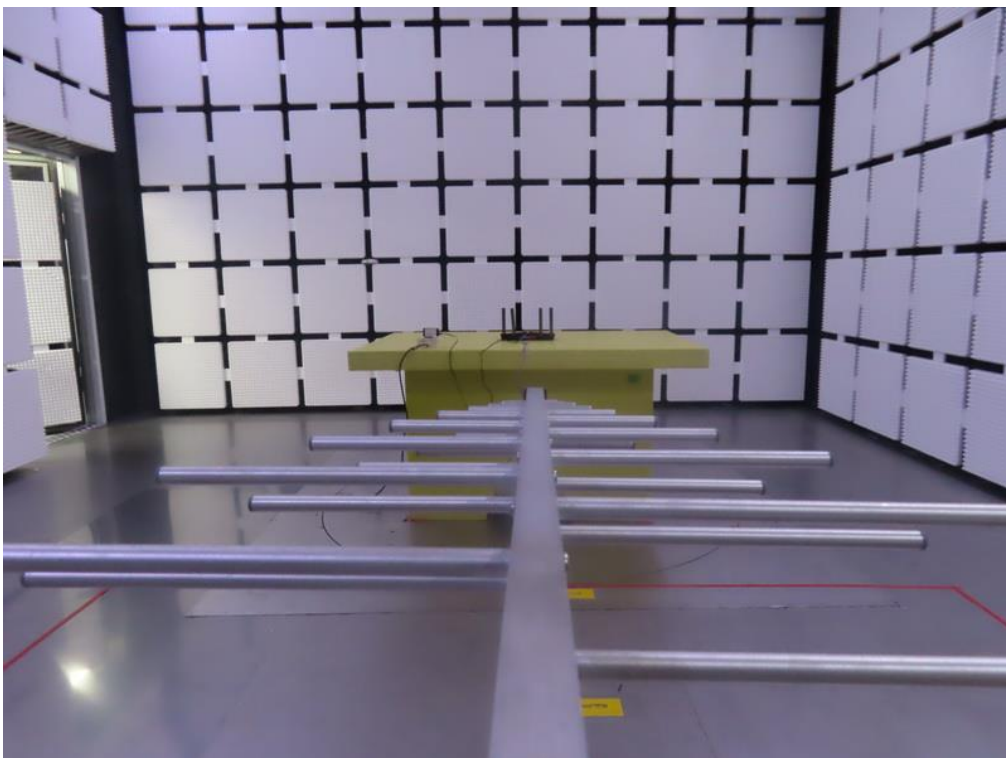
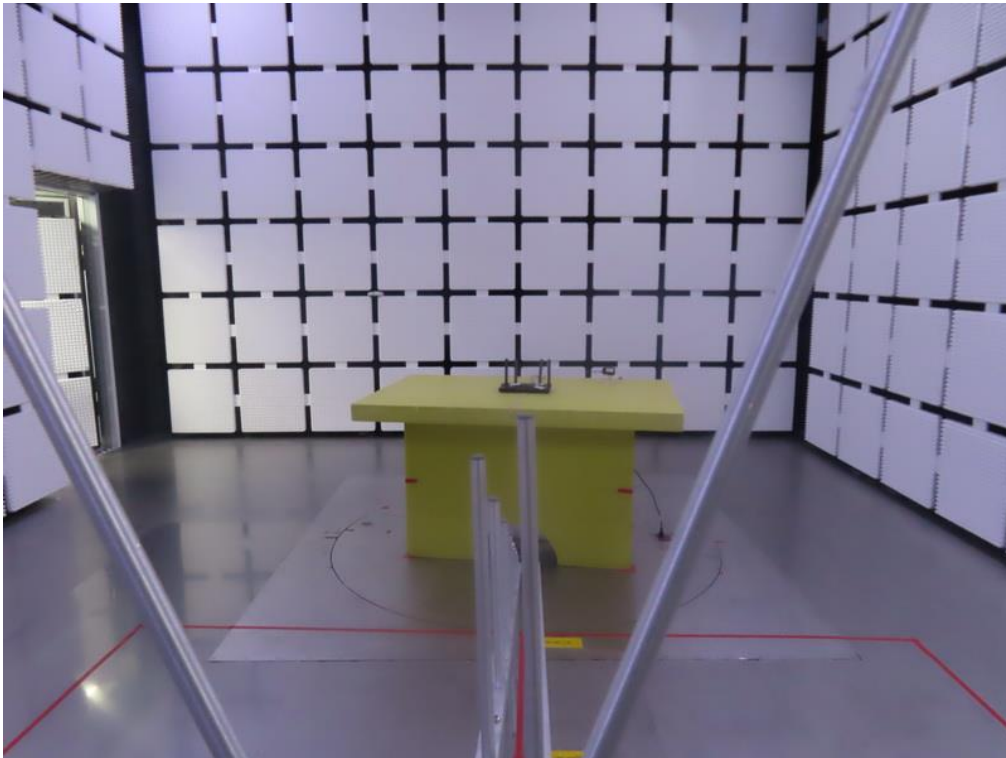
**Radiated Emissions Test Photos****30 MHz to 1 GHz**

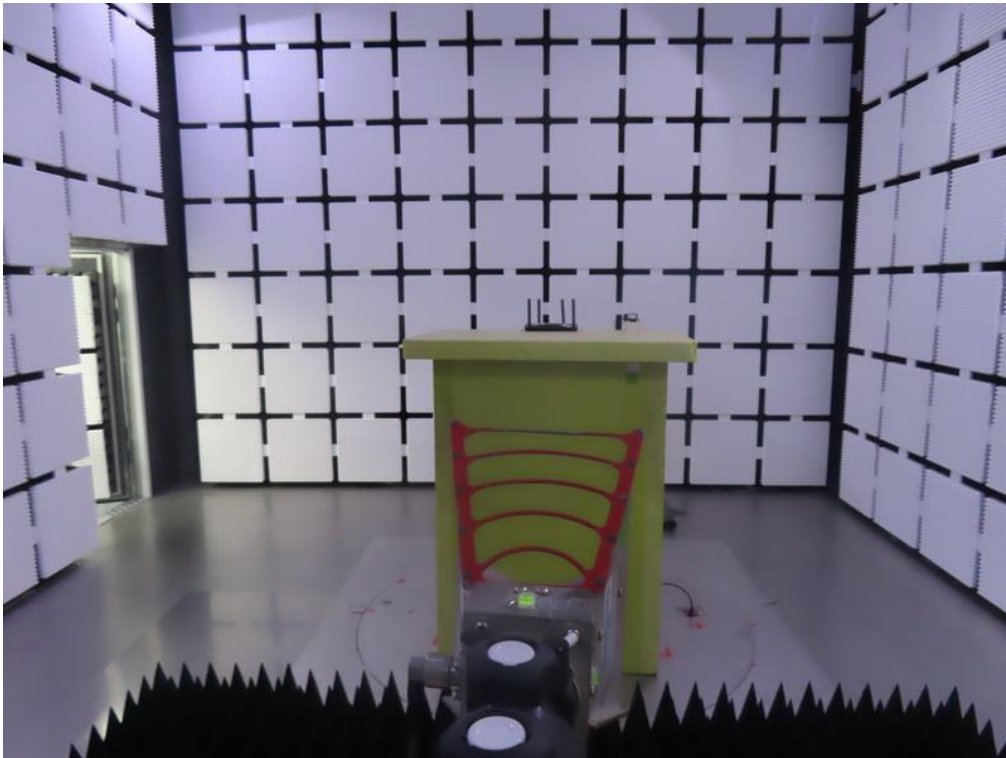
**Radiated Emissions Test Photos****Above 1 GHz**



**Conducted Test Photos**

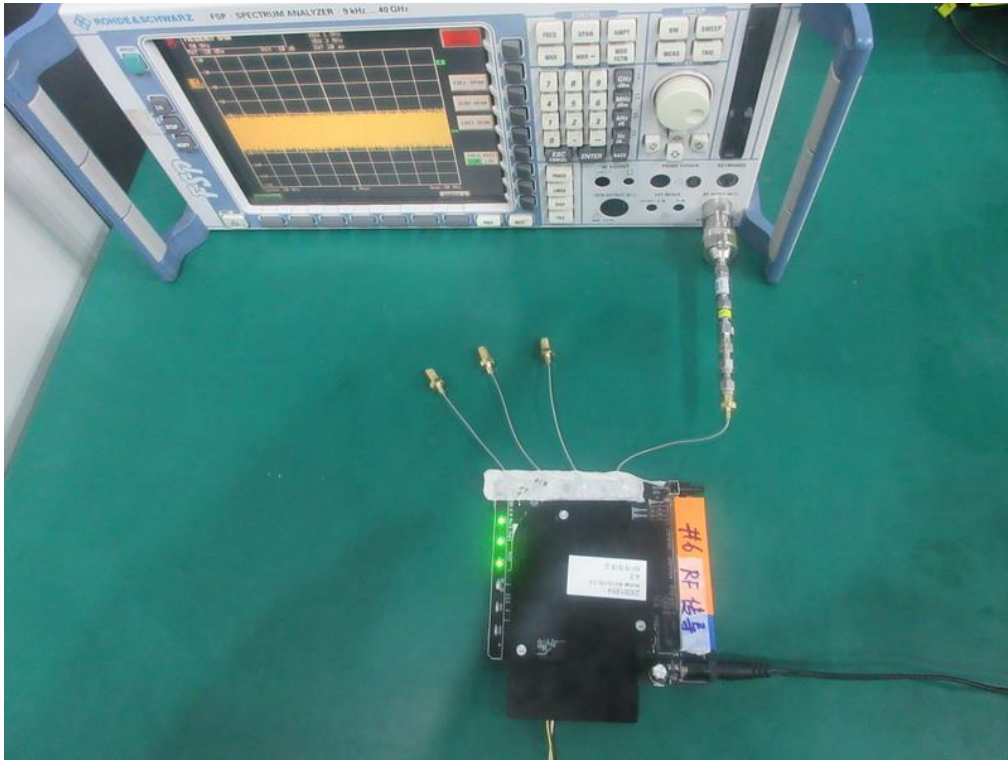

## **APPENDIX A - AC POWER LINE CONDUCTED EMISSIONS**

Test Mode	TX A Mode Channel 48 (UNII-1)	Phase	Line
-----------	-------------------------------	-------	------

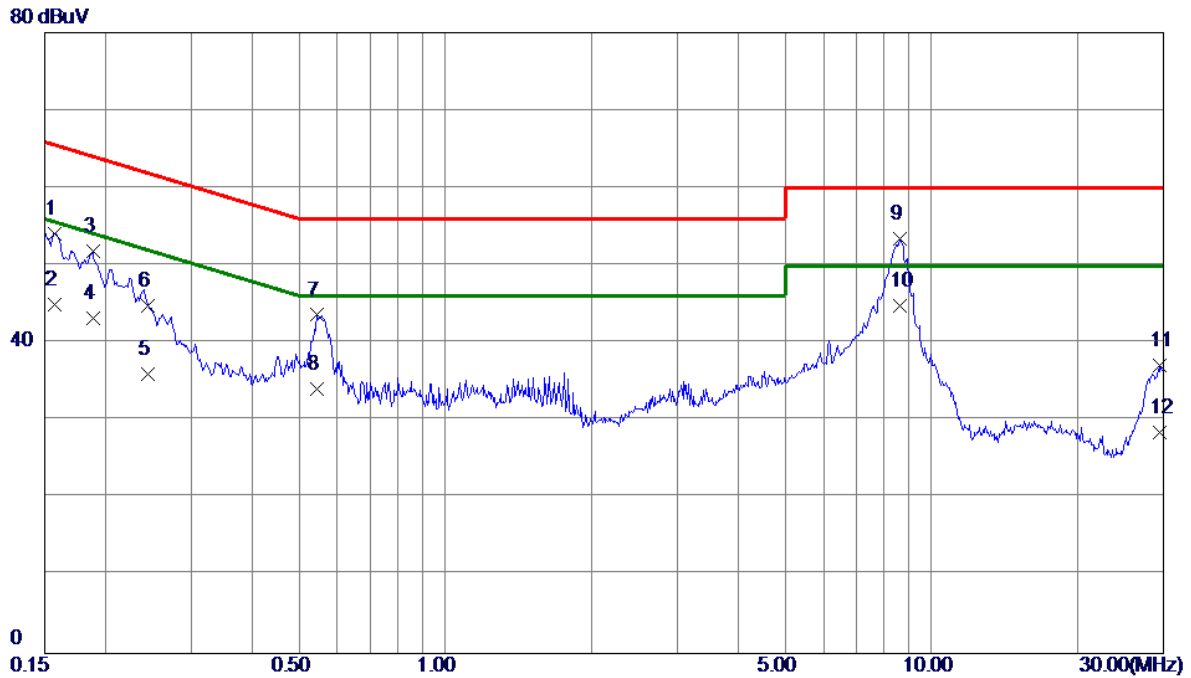

No.	Freq. MHz	Reading Level dBuV	Correct Factor dB	Measure ment dBuV	Limit dBuV	Margin dB	Detector	Comment
1	0.1568	44.44	9.71	54.15	65.63	-11.48	QP	
2	0.1568	35.20	9.71	44.91	55.63	-10.72	AVG	
3	0.1883	42.06	9.71	51.77	64.11	-12.34	QP	
4	0.1883	33.50	9.71	43.21	54.11	-10.90	AVG	
5	0.2445	26.29	9.71	36.00	61.94	-25.94	QP	
6	0.2445	35.13	9.71	44.84	51.94	-7.10	AVG	
7	0.5437	33.86	9.74	43.60	56.00	-12.40	QP	
8	0.5437	24.30	9.74	34.04	46.00	-11.96	AVG	
9	8.6235	43.29	10.19	53.48	60.00	-6.52	QP	
10 *	8.6235	34.60	10.19	44.79	50.00	-5.21	AVG	
11	29.5395	26.12	11.03	37.15	60.00	-22.85	QP	
12	29.5395	17.50	11.03	28.53	50.00	-21.47	AVG	

REMARKS:

- (1) Measurement Value = Reading Level + Correct Factor.
- (2) Margin Level = Measurement Value - Limit Value.
- (3) The test result has included the cable loss.

Test Mode	TX A Mode Channel 48 (UNII-1)	Phase	Neutral
-----------	-------------------------------	-------	---------

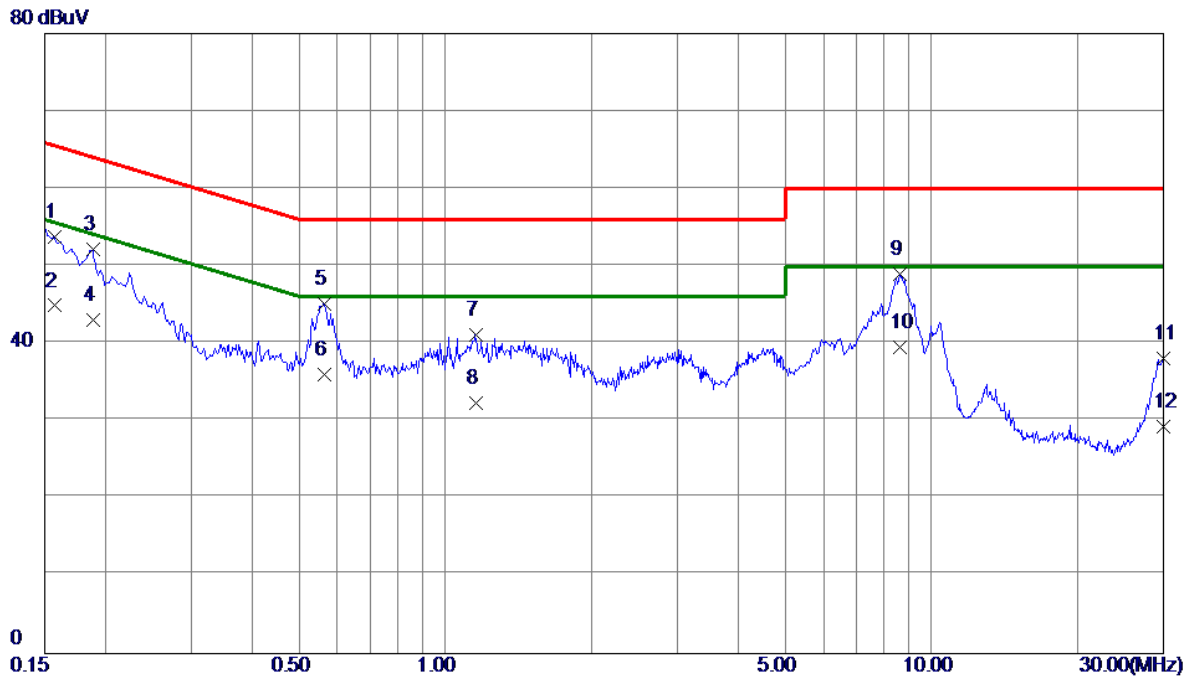

No.	Freq. MHz	Reading Level dBuV	Correct Factor dB	Measurement dBuV	Limit dBuV	Margin dB	Detector	Comment
1	0.1568	44.08	9.68	53.76	65.63	-11.87	QP	
2	0.1568	35.20	9.68	44.88	55.63	-10.75	AVG	
3	0.1883	42.52	9.68	52.20	64.11	-11.91	QP	
4	0.1883	33.40	9.68	43.08	54.11	-11.03	AVG	
5	0.5639	35.46	9.71	45.17	56.00	-10.83	QP	
6 *	0.5639	26.30	9.71	36.01	46.00	-9.99	AVG	
7	1.1535	31.28	9.77	41.05	56.00	-14.95	QP	
8	1.1535	22.50	9.77	32.27	46.00	-13.73	AVG	
9	8.5897	38.77	10.17	48.94	60.00	-11.06	QP	
10	8.5897	29.41	10.17	39.58	50.00	-10.42	AVG	
11	29.9175	27.05	11.03	38.08	60.00	-21.92	QP	
12	29.9175	18.30	11.03	29.33	50.00	-20.67	AVG	

**REMARKS:**

- (1) Measurement Value = Reading Level + Correct Factor.
- (2) Margin Level = Measurement Value - Limit Value.
- (3) The test result has included the cable loss.

**APPENDIX B - RADIATED EMISSION - 9 KHZ TO 30 MHZ**

Test Mode	TX A Mode Channel 48 (UNII-1)	Polarization	Ant 0°
-----------	-------------------------------	--------------	--------

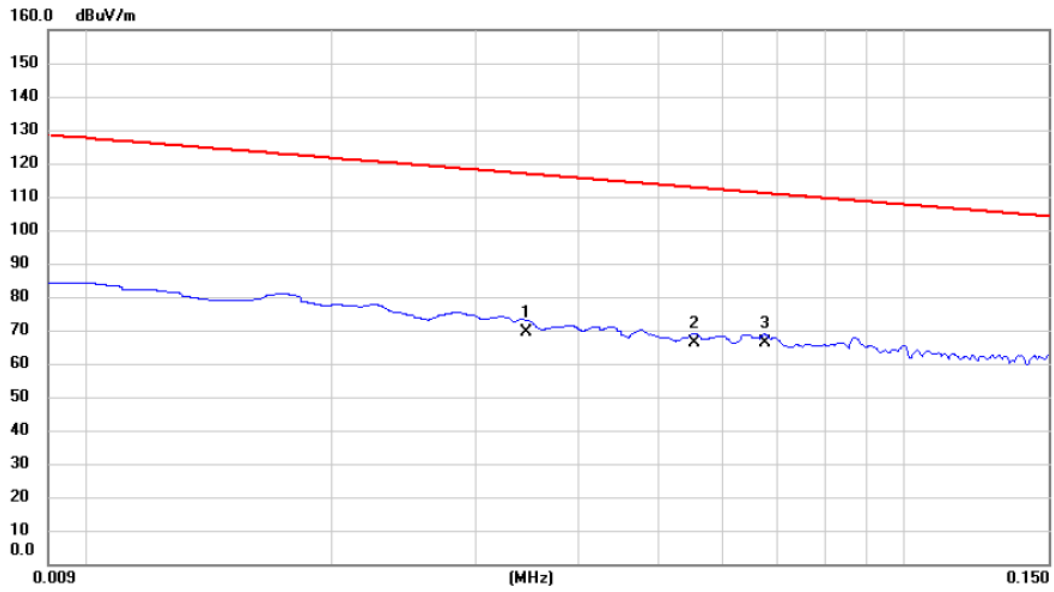

No. Mk.	Freq. MHz	Reading Level dBuV	Correct Factor dB	Measure- ment dBuV/m	Limit dBuV/m	Margin dB	Detector	Comment
1	0.035	49.63	19.80	69.43	116.85	-47.42	AVG	
2	0.055	46.51	19.82	66.33	112.73	-46.40	AVG	
3 *	0.068	46.22	19.86	66.08	111.02	-44.94	AVG	

**REMARKS:**

(1) Measurement Value = Reading Level + Correct Factor.

(2) Margin Level = Measurement Value - Limit Value.

Test Mode	TX A Mode Channel 48 (UNII-1)	Polarization	Ant 0°
-----------	-------------------------------	--------------	--------

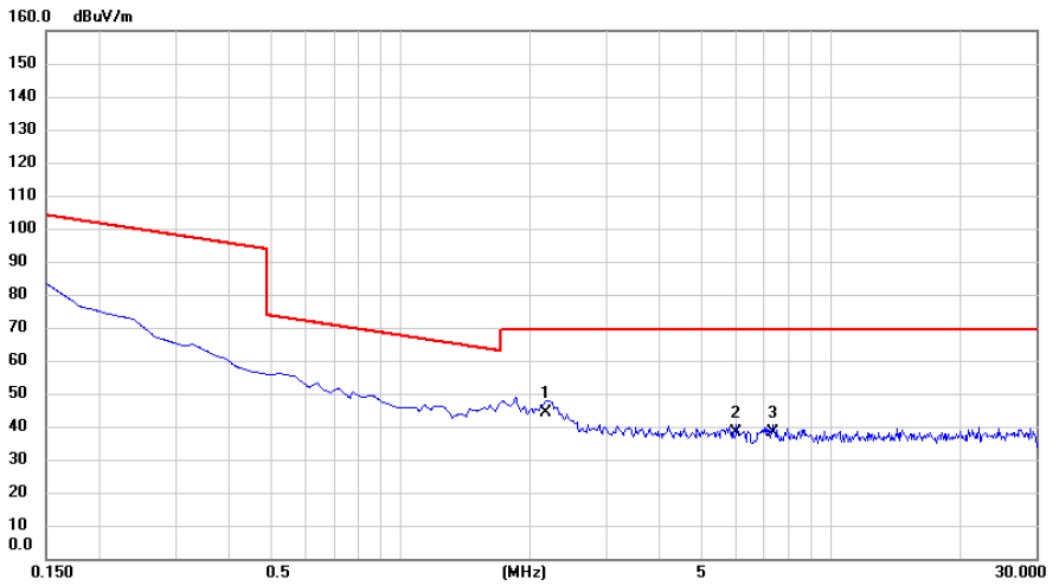

No. Mk.	Freq. MHz	Reading Level dBuV	Correct Factor dB	Measure- ment dBuV/m	Limit dBuV/m	Margin dB	Detector	Comment
1 *	2.180	24.32	19.81	44.13	69.54	-25.41	QP	
2	6.030	18.11	19.96	38.07	69.54	-31.47	QP	
3	7.314	18.23	20.04	38.27	69.54	-31.27	QP	

**REMARKS:**

- (1) Measurement Value = Reading Level + Correct Factor.
- (2) Margin Level = Measurement Value - Limit Value.

Test Mode	TX A Mode Channel 48 (UNII-1)	Polarization	Ant 90°
-----------	-------------------------------	--------------	---------

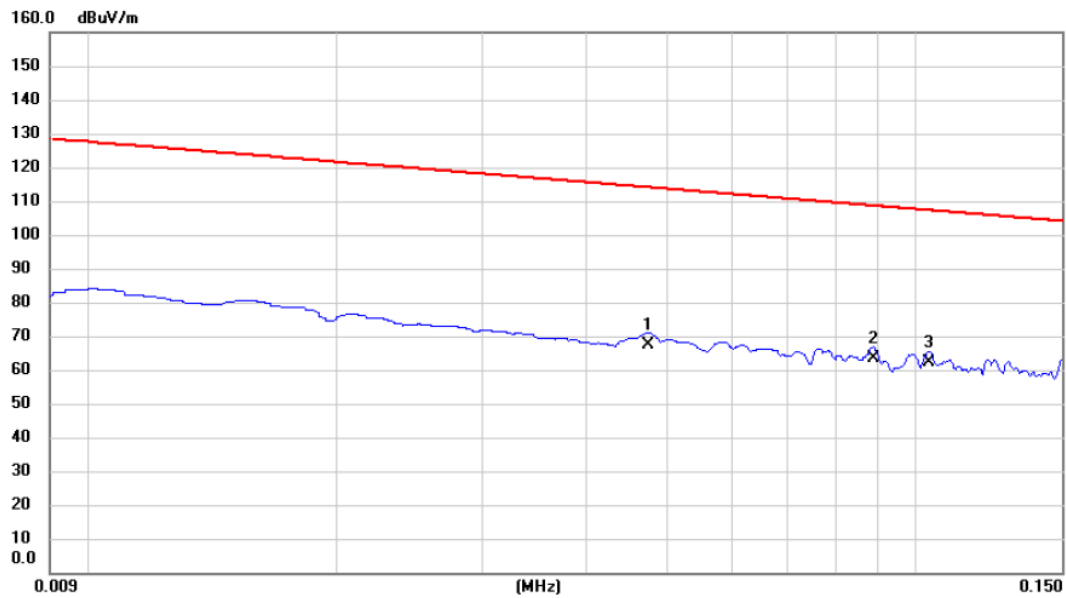

No.	Mk.	Freq. MHz	Reading Level dBuV	Correct Factor dB	Measure- ment dBuV/m	Limit dBuV/m	Margin dB	Detector	Comment
1		0.048	47.63	19.80	67.43	114.07	-46.64	AVG	
2		0.089	43.62	19.86	63.48	108.64	-45.16	AVG	
3	*	0.104	42.51	19.83	62.34	107.28	-44.94	QP	

**REMARKS:**

- (1) Measurement Value = Reading Level + Correct Factor.
- (2) Margin Level = Measurement Value - Limit Value.



Test Mode	TX A Mode Channel 48 (UNII-1)	Polarization	Ant 90°
-----------	-------------------------------	--------------	---------

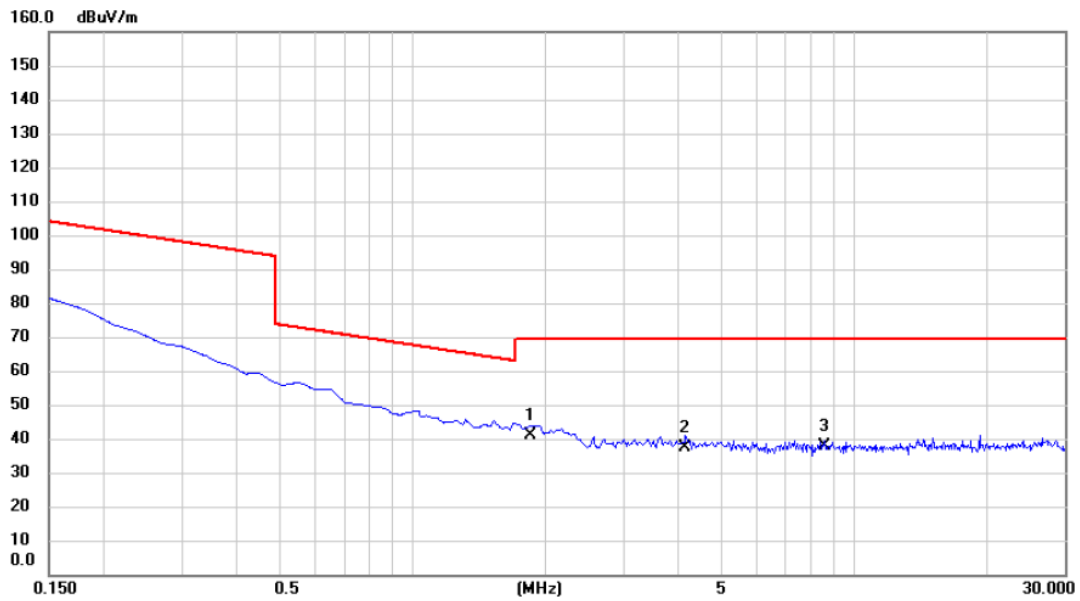

No.	Mk.	Freq. MHz	Reading Level dBuV	Correct Factor dB	Measure- ment dBuV/m	Limit dBuV/m	Margin dB	Detector	Comment
1	*	1.851	21.36	19.80	41.16	69.54	-28.38	QP	
2		4.150	17.65	19.93	37.58	69.54	-31.96	QP	
3		8.568	17.52	20.12	37.64	69.54	-31.90	QP	

**REMARKS:**

- (1) Measurement Value = Reading Level + Correct Factor.
- (2) Margin Level = Measurement Value - Limit Value.

**APPENDIX C - RADIATED EMISSION - 30 MHZ TO 1000 MHZ**

Test Mode	TX A Mode Channel 48 (UNII-1)	Polarization	Vertical
-----------	-------------------------------	--------------	----------

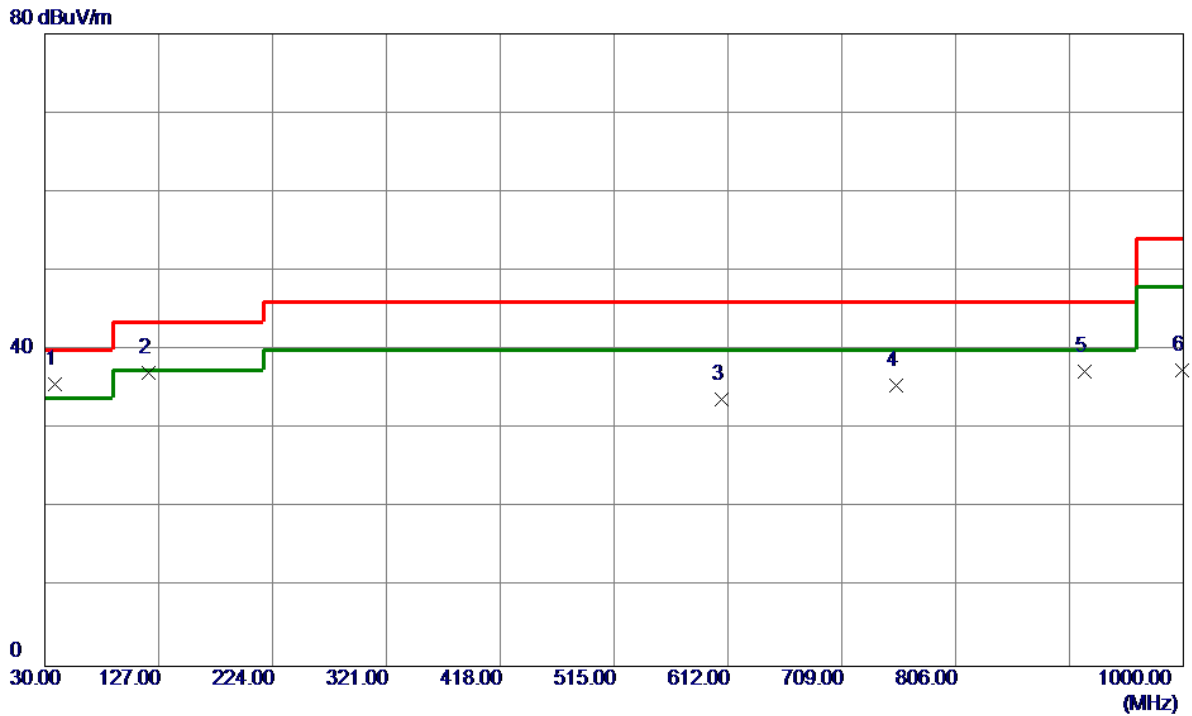

No.	Freq. MHz	Reading Level dBuV/m	Correct Factor dB	Measure ment dBuV/m	Limit dBuV/m	Margin dB	Detector	Comment
1 *	38.2450	47.39	-11.65	35.74	40.00	-4.26	QP	
2	118.2700	50.61	-13.49	37.12	43.50	-6.38	Peak	
3	606.6650	37.15	-3.43	33.72	46.00	-12.28	Peak	
4	755.0750	37.17	-1.61	35.56	46.00	-10.44	Peak	
5	916.0950	37.28	-0.02	37.26	46.00	-8.74	Peak	
6	998.5450	36.48	1.03	37.51	54.00	-16.49	Peak	

**REMARKS:**

- (1) Measurement Value = Reading Level + Correct Factor.
- (2) Margin Level = Measurement Value - Limit Value.

Test Mode	TX A Mode Channel 48 (UNII-1)	Polarization	Horizontal
-----------	-------------------------------	--------------	------------

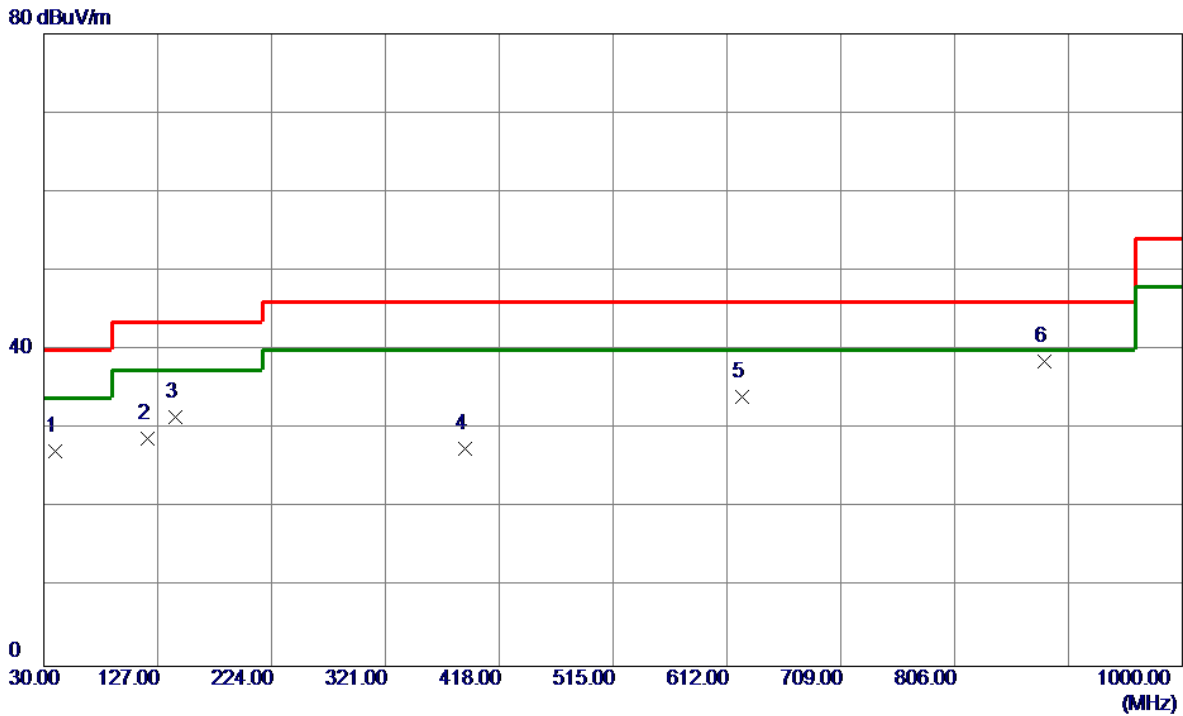

No.	Freq. MHz	Reading Level dBuV/m	Correct Factor dB	Measure ment dBuV/m	Limit dBuV/m	Margin dB	Detector	Comment
1	40.1850	38.60	-11.45	27.15	40.00	-12.85	Peak	
2	118.7550	42.22	-13.43	28.79	43.50	-14.71	Peak	
3	142.0350	42.96	-11.50	31.46	43.50	-12.04	Peak	
4	388.9000	35.85	-8.38	27.47	46.00	-18.53	Peak	
5	625.0949	37.38	-3.35	34.03	46.00	-11.97	Peak	
6 *	882.1450	38.72	-0.17	38.55	46.00	-7.45	Peak	

**REMARKS:**

- (1) Measurement Value = Reading Level + Correct Factor.
- (2) Margin Level = Measurement Value - Limit Value.

**APPENDIX D - RADIATED EMISSION - ABOVE 1000 MHZ**

Test Mode	UNII-1_TX A Mode 5180 MHz	Polarization	Vertical
-----------	---------------------------	--------------	----------

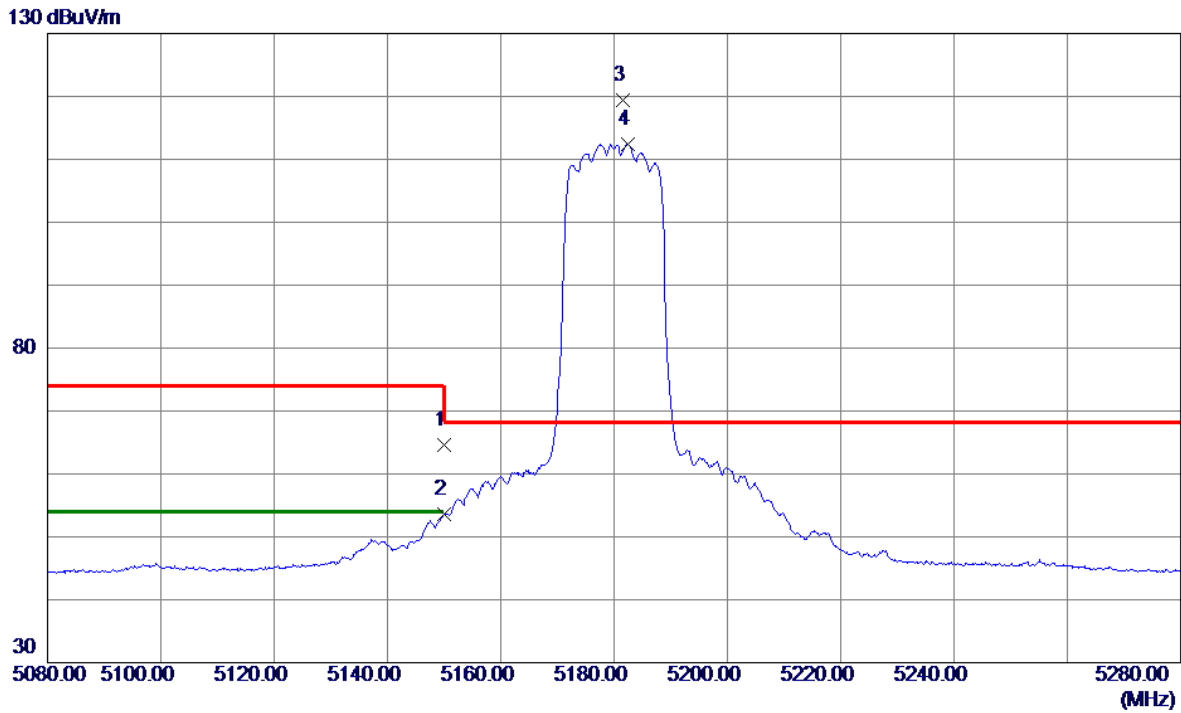

No.	Freq. MHz	Reading Level dBuV/m	Correct Factor dB	Measure ment dBuV/m	Limit dBuV/m	Margin dB	Detector	Comment
1	5150.0000	52.81	11.75	64.56	74.00	-9.44	Peak	
2	5150.0000	41.92	11.75	53.67	54.00	-0.33	AVG	
3 *	5181.5000	107.66	11.82	119.48	68.20	51.28	Peak	No Limit
4	5182.4000	100.64	11.82	112.46	999.00	-886.54	AVG	No Limit

**REMARKS:**

- (1) Measurement Value = Reading Level + Correct Factor.
- (2) Margin Level = Measurement Value - Limit Value.

Test Mode	UNII-1_TX A Mode 5180 MHz	Polarization	Vertical
-----------	---------------------------	--------------	----------

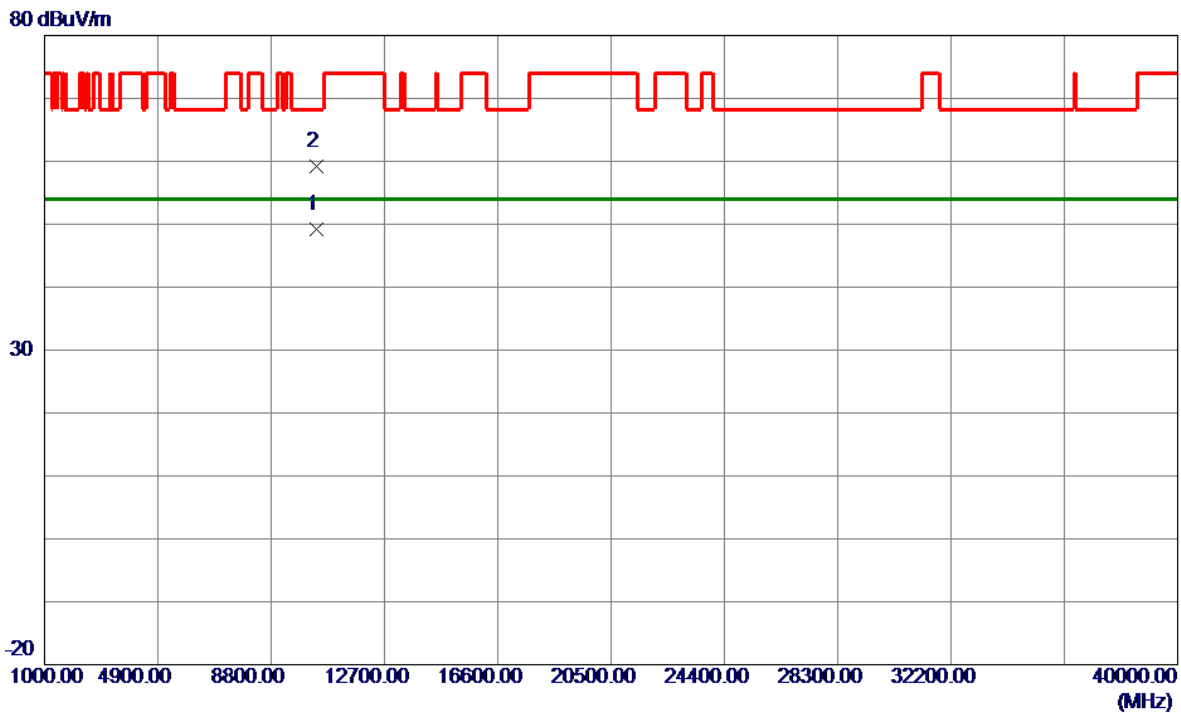

No.	Freq. MHz	Reading Level dBuV/m	Correct Factor dB	Measure ment dBuV/m	Limit dBuV/m	Margin dB	Detector	Comment
1 *	10360.2300	43.07	6.06	49.13	54.00	-4.87	AVG	
2	10360.3000	53.12	6.06	59.18	68.20	-9.02	Peak	

**REMARKS:**

- (1) Measurement Value = Reading Level + Correct Factor.
- (2) Margin Level = Measurement Value - Limit Value.

Test Mode	UNII-1_TX A Mode 5200 MHz	Polarization	Vertical
-----------	---------------------------	--------------	----------

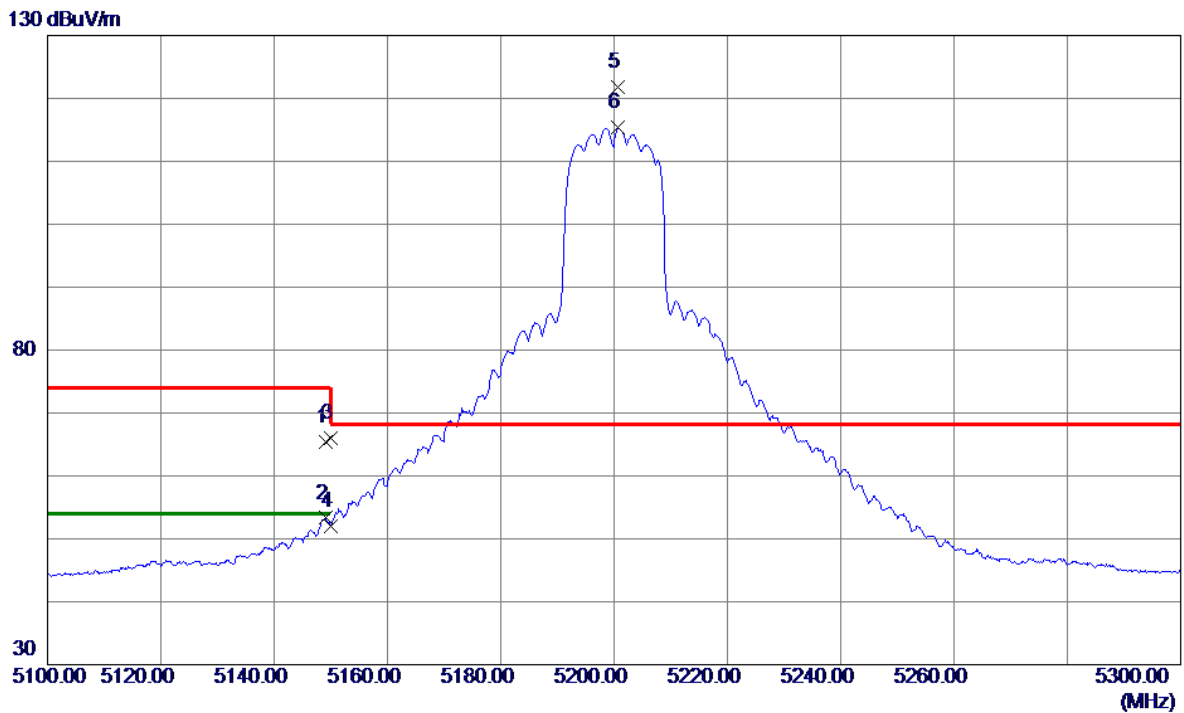

No.	Freq. MHz	Reading Level dBuV/m	Correct Factor dB	Measure ment dBuV/m	Limit dBuV/m	Margin dB	Detector	Comment
1	5149.2000	53.73	11.74	65.47	74.00	-8.53	Peak	
2	5149.2000	41.56	11.74	53.30	54.00	-0.70	AVG	
3	5150.0000	54.30	11.75	66.05	74.00	-7.95	Peak	
4	5150.0000	40.19	11.75	51.94	54.00	-2.06	AVG	
5 *	5200.7000	110.02	11.86	121.88	68.20	53.68	Peak	No Limit
6	5200.7000	103.45	11.86	115.31	999.00	-883.69	AVG	No Limit

REMARKS:

- (1) Measurement Value = Reading Level + Correct Factor.
- (2) Margin Level = Measurement Value - Limit Value.



Test Mode	UNII-1_TX A Mode 5200 MHz	Polarization	Vertical
-----------	---------------------------	--------------	----------

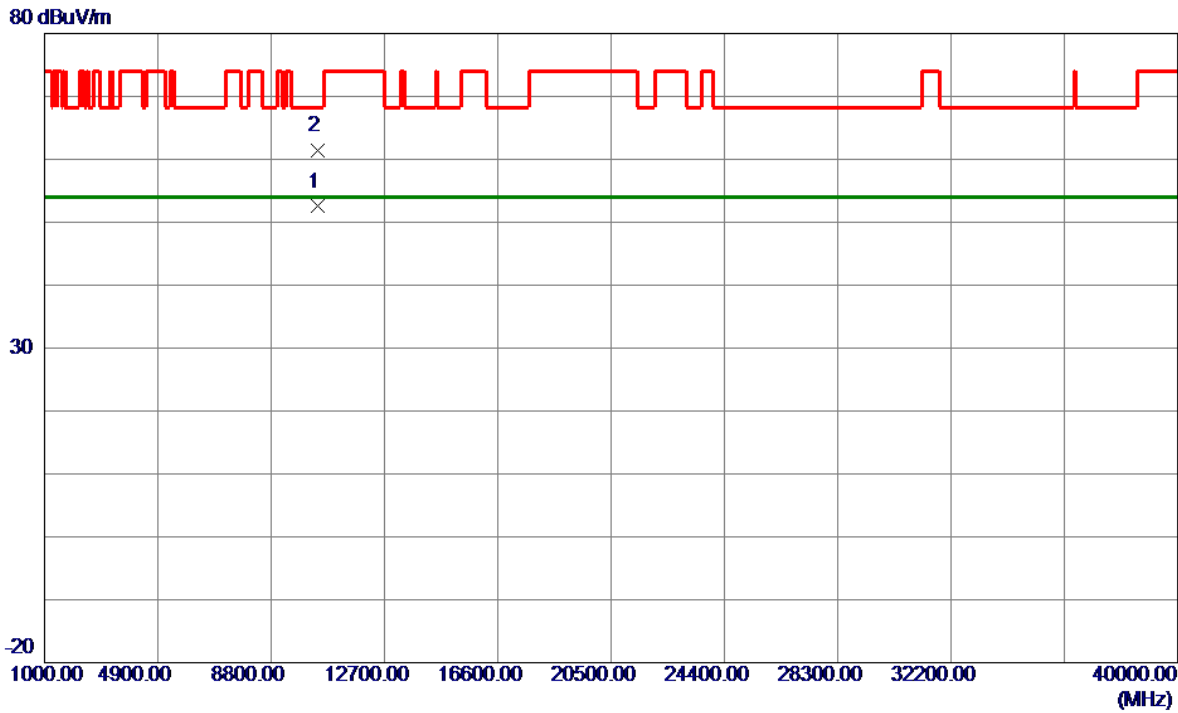

No.	Freq. MHz	Reading Level dBuV/m	Correct Factor dB	Measure ment dBuV/m	Limit dBuV/m	Margin dB	Detector	Comment
1 *	10399.9900	46.41	6.09	52.50	54.00	-1.50	AVG	
2	10400.2300	55.26	6.09	61.35	68.20	-6.85	Peak	

**REMARKS:**

- (1) Measurement Value = Reading Level + Correct Factor.
- (2) Margin Level = Measurement Value - Limit Value.

Test Mode	UNII-1_TX A Mode 5240 MHz	Polarization	Vertical
-----------	---------------------------	--------------	----------

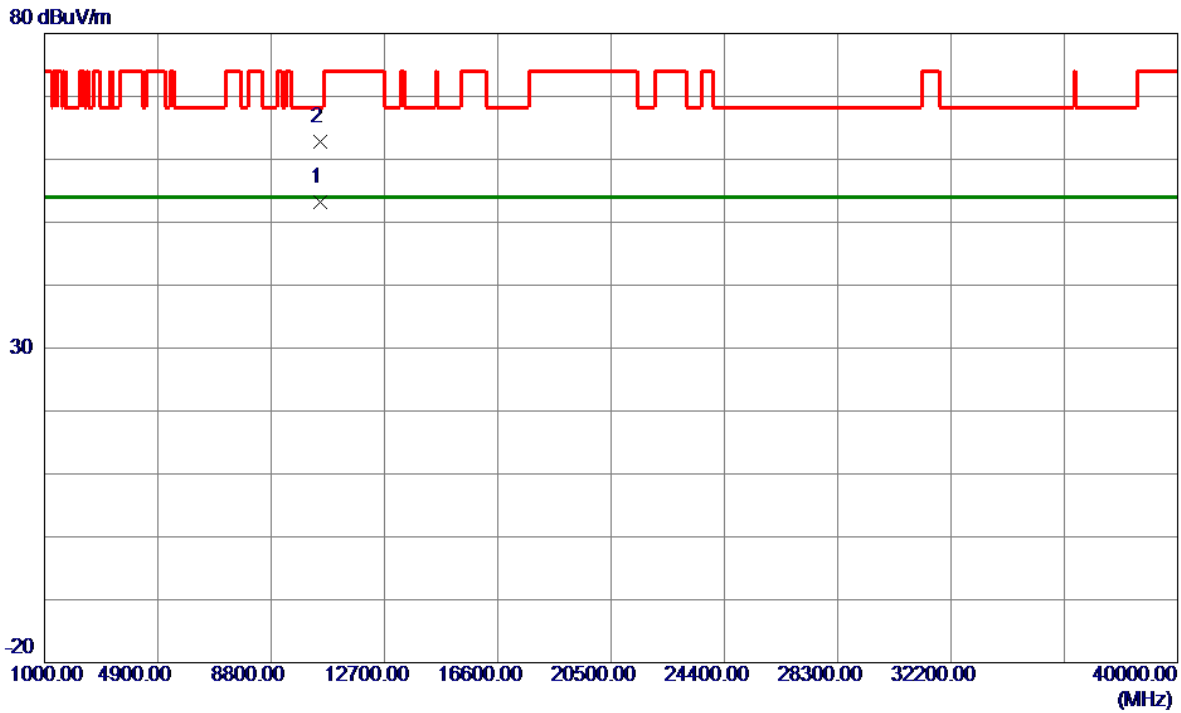

No.	Freq. MHz	Reading Level dBuV/m	Correct Factor dB	Measure ment dBuV/m	Limit dBuV/m	Margin dB	Detector	Comment
1 *	10480.2300	47.08	6.15	53.23	54.00	-0.77	AVG	
2	10480.3800	56.64	6.15	62.79	68.20	-5.41	Peak	

**REMARKS:**

- (1) Measurement Value = Reading Level + Correct Factor.
- (2) Margin Level = Measurement Value - Limit Value.

Test Mode	UNII-1_TX AC(VHT20) Mode 5180 MHz	Polarization	Vertical
-----------	-----------------------------------	--------------	----------

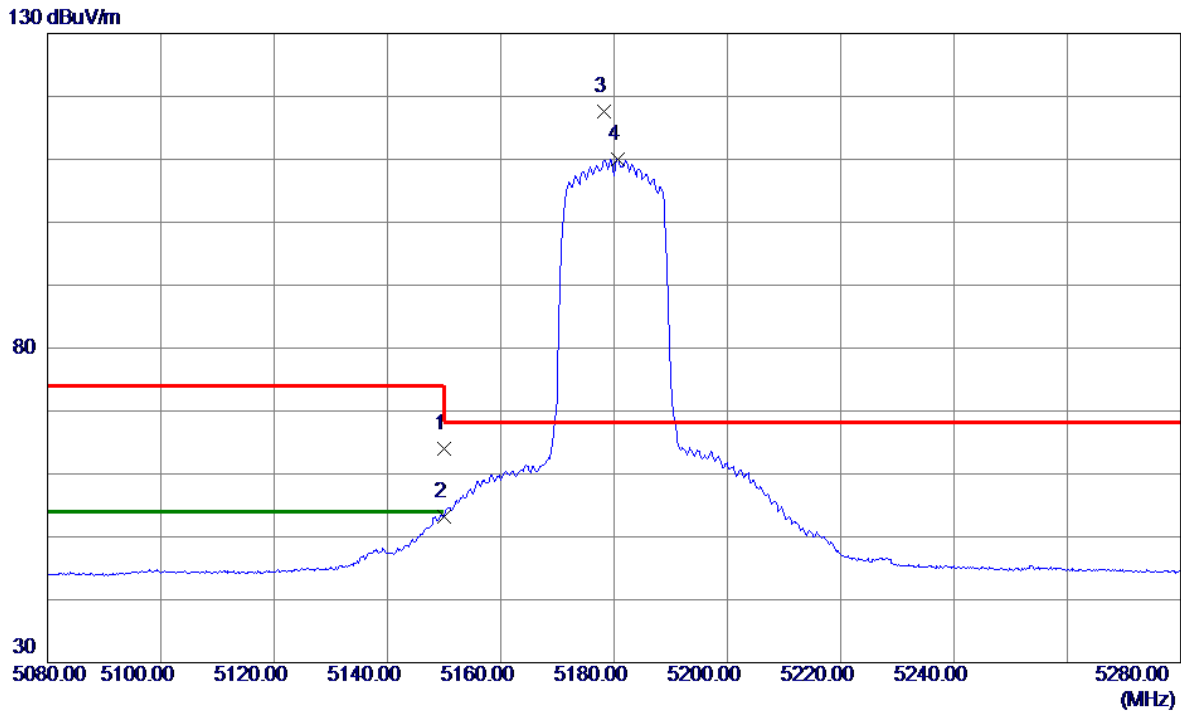

No.	Freq. MHz	Reading Level dBuV/m	Correct Factor dB	Measure ment dBuV/m	Limit dBuV/m	Margin dB	Detector	Comment
1	5150.0000	52.24	11.75	63.99	74.00	-10.01	Peak	
2	5150.0000	41.46	11.75	53.21	54.00	-0.79	AVG	
3 *	5178.3000	105.82	11.81	117.63	68.20	49.43	Peak	No Limit
4	5180.6000	98.20	11.82	110.02	999.00	-888.98	AVG	No Limit

REMARKS:

- (1) Measurement Value = Reading Level + Correct Factor.
- (2) Margin Level = Measurement Value - Limit Value.

Test Mode	UNII-1_TX AC(VHT20) Mode 5180 MHz	Polarization	Vertical
-----------	-----------------------------------	--------------	----------

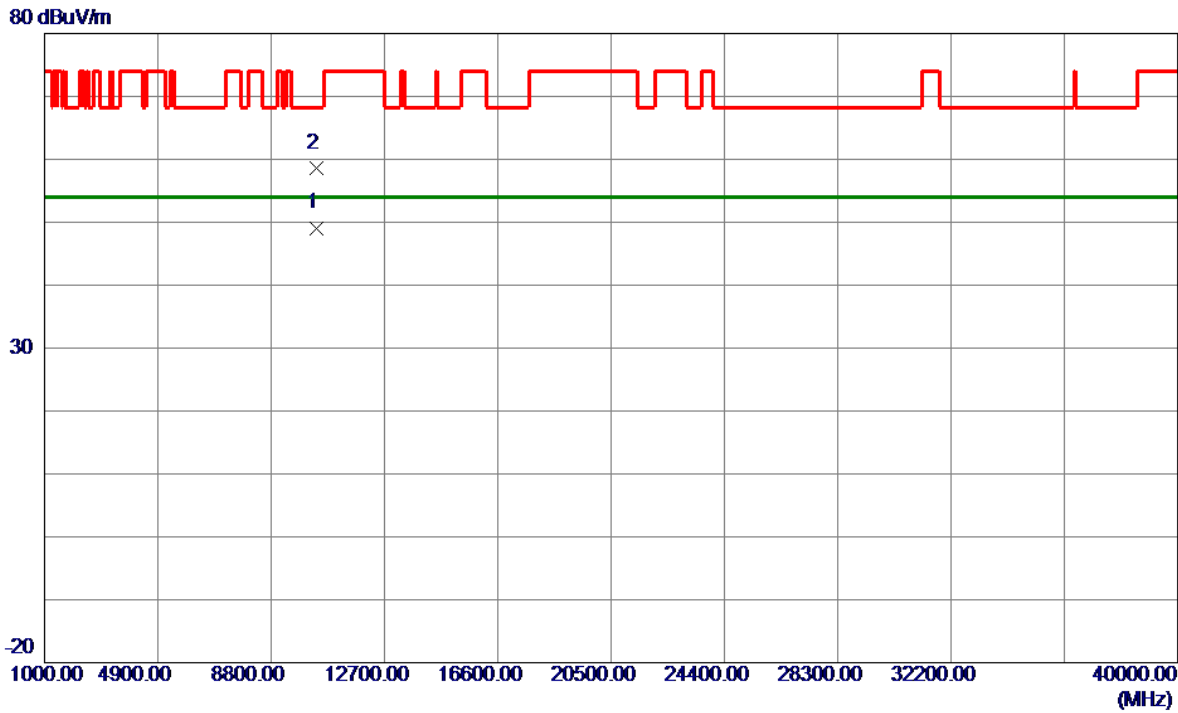

No.	Freq. MHz	Reading Level dBuV/m	Correct Factor dB	Measure ment dBuV/m	Limit dBuV/m	Margin dB	Detector	Comment
1 *	10360.0300	43.04	6.06	49.10	54.00	-4.90	AVG	
2	10360.1000	52.52	6.06	58.58	68.20	-9.62	Peak	

REMARKS:

- (1) Measurement Value = Reading Level + Correct Factor.
- (2) Margin Level = Measurement Value - Limit Value.

Test Mode	UNII-1_TX AC(VHT20) Mode 5200 MHz	Polarization	Vertical
-----------	-----------------------------------	--------------	----------

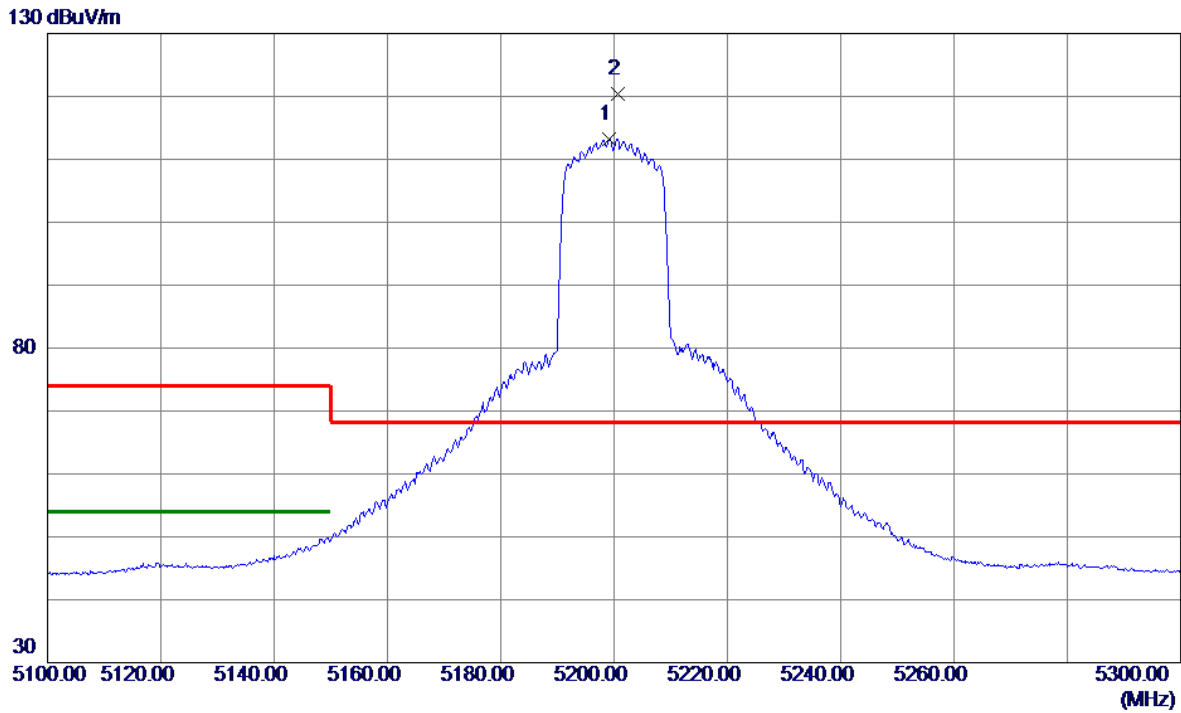

No.	Freq. MHz	Reading Level dBuV/m	Correct Factor dB	Measure ment dBuV/m	Limit dBuV/m	Margin dB	Detector	Comment
1	5199.2000	101.43	11.86	113.29	999.00	-885.71	AVG	No Limit
2 *	5200.6000	108.61	11.86	120.47	68.20	52.27	Peak	No Limit

**REMARKS:**

- (1) Measurement Value = Reading Level + Correct Factor.
- (2) Margin Level = Measurement Value - Limit Value.

Test Mode	UNII-1_TX AC(VHT20) Mode 5200 MHz	Polarization	Vertical
-----------	-----------------------------------	--------------	----------

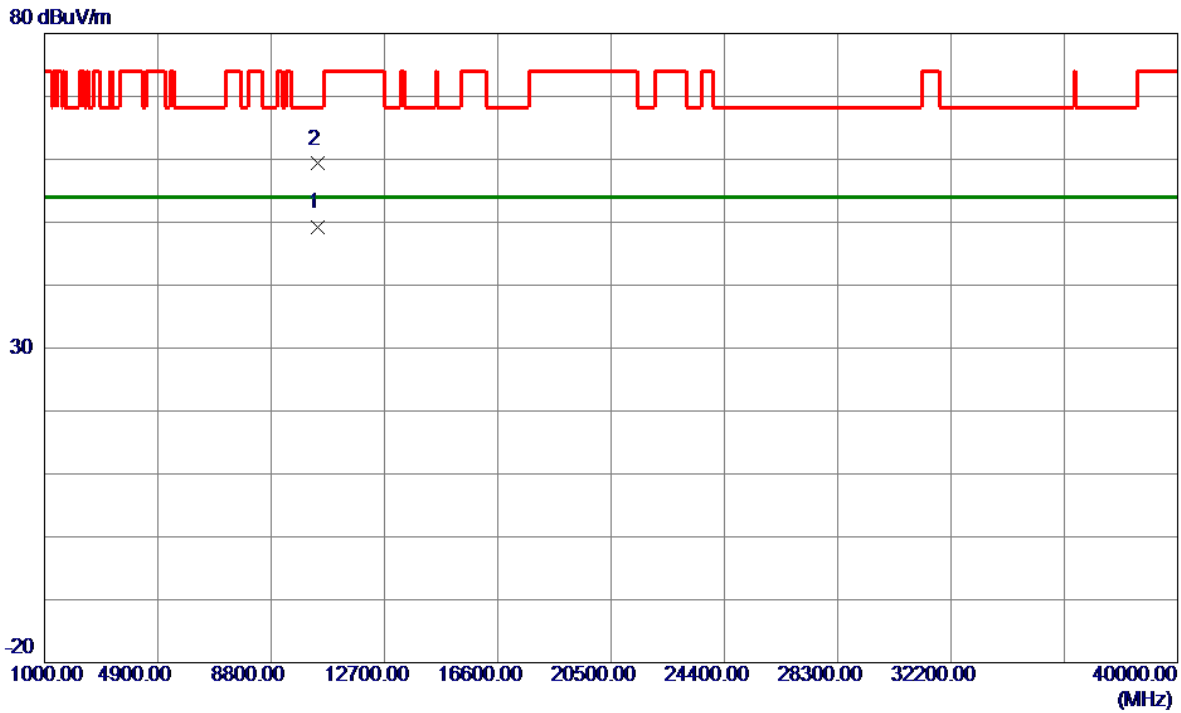

No.	Freq. MHz	Reading Level dBuV/m	Correct Factor dB	Measure ment dBuV/m	Limit dBuV/m	Margin dB	Detector	Comment
1 *	10400.1800	43.06	6.09	49.15	54.00	-4.85	AVG	
2	10400.3200	53.21	6.09	59.30	68.20	-8.90	Peak	

**REMARKS:**

- (1) Measurement Value = Reading Level + Correct Factor.
- (2) Margin Level = Measurement Value - Limit Value.

Test Mode	UNII-1_TX AC(VHT20) Mode 5240 MHz	Polarization	Vertical
-----------	-----------------------------------	--------------	----------

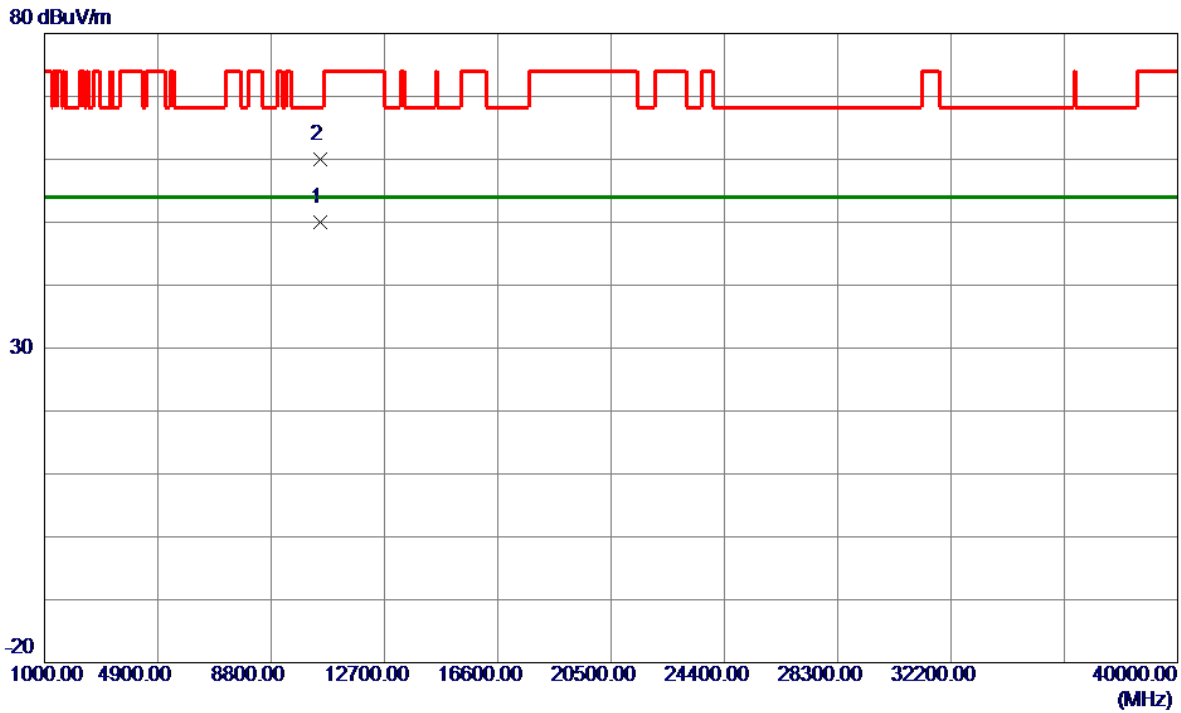

No.	Freq. MHz	Reading Level dBuV/m	Correct Factor dB	Measure ment dBuV/m	Limit dBuV/m	Margin dB	Detector	Comment
1 *	10480.1500	43.89	6.15	50.04	54.00	-3.96	AVG	
2	10480.3000	53.87	6.15	60.02	68.20	-8.18	Peak	

**REMARKS:**

- (1) Measurement Value = Reading Level + Correct Factor.
- (2) Margin Level = Measurement Value - Limit Value.

Test Mode	UNII-1_TX AC(VHT40) Mode 5190 MHz	Polarization	Vertical
-----------	-----------------------------------	--------------	----------

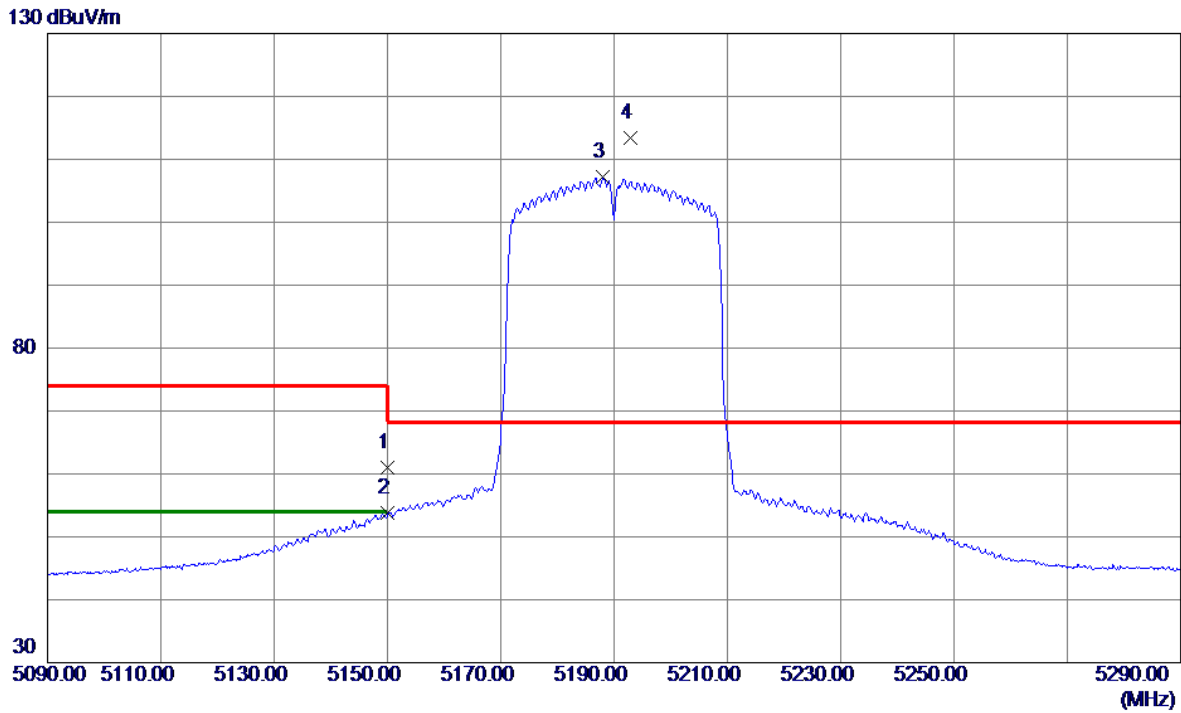

No.	Freq. MHz	Reading Level dBuV/m	Correct Factor dB	Measure ment dBuV/m	Limit dBuV/m	Margin dB	Detector	Comment
1	5150.0000	49.25	11.75	61.00	74.00	-13.00	Peak	
2	5150.0000	41.97	11.75	53.72	54.00	-0.28	AVG	
3	5188.0000	95.36	11.83	107.19	999.00	-891.81	AVG	No Limit
4 *	5192.9000	101.60	11.85	113.45	68.20	45.25	Peak	No Limit

**REMARKS:**

- (1) Measurement Value = Reading Level + Correct Factor.
- (2) Margin Level = Measurement Value - Limit Value.



Test Mode	UNII-1_TX AC(VHT40) Mode 5190 MHz	Polarization	Vertical
-----------	-----------------------------------	--------------	----------

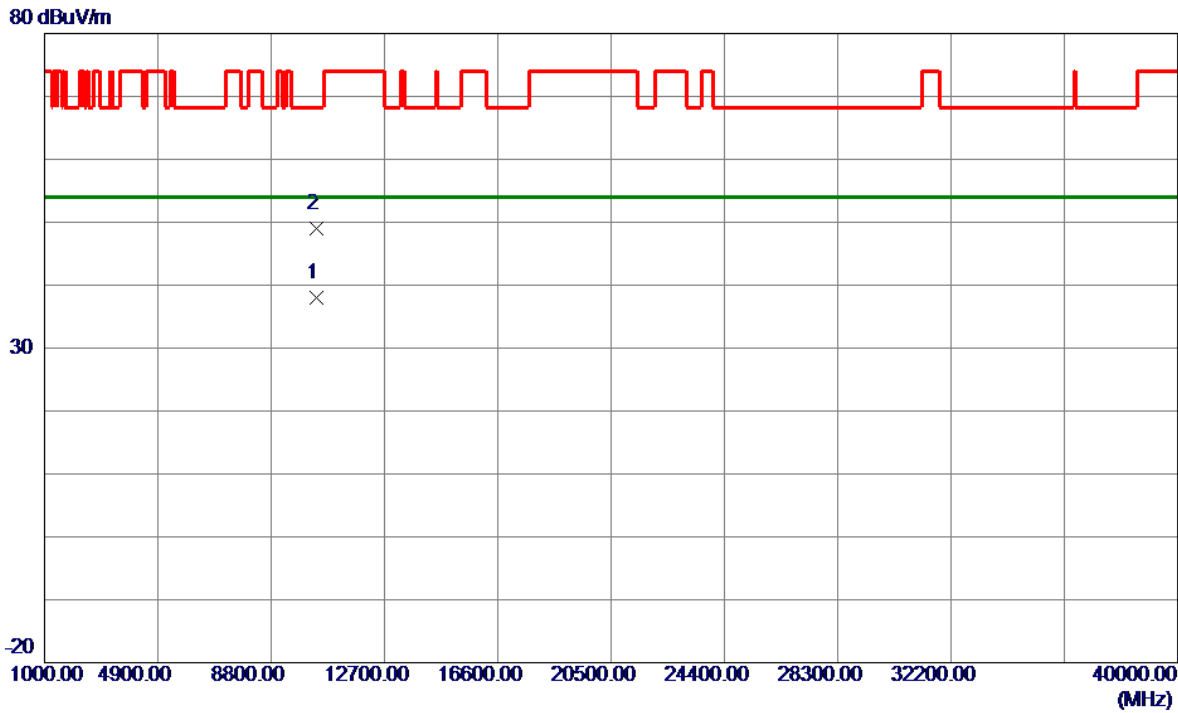

No.	Freq. MHz	Reading Level dBuV/m	Correct Factor dB	Measure ment dBuV/m	Limit dBuV/m	Margin dB	Detector	Comment
1 *	10375.4700	31.98	6.07	38.05	54.00	-15.95	AVG	
2	10376.3900	42.94	6.07	49.01	68.20	-19.19	Peak	

**REMARKS:**

- (1) Measurement Value = Reading Level + Correct Factor.
- (2) Margin Level = Measurement Value - Limit Value.

Test Mode	UNII-1_TX AC(VHT40) Mode 5230 MHz	Polarization	Vertical
-----------	-----------------------------------	--------------	----------

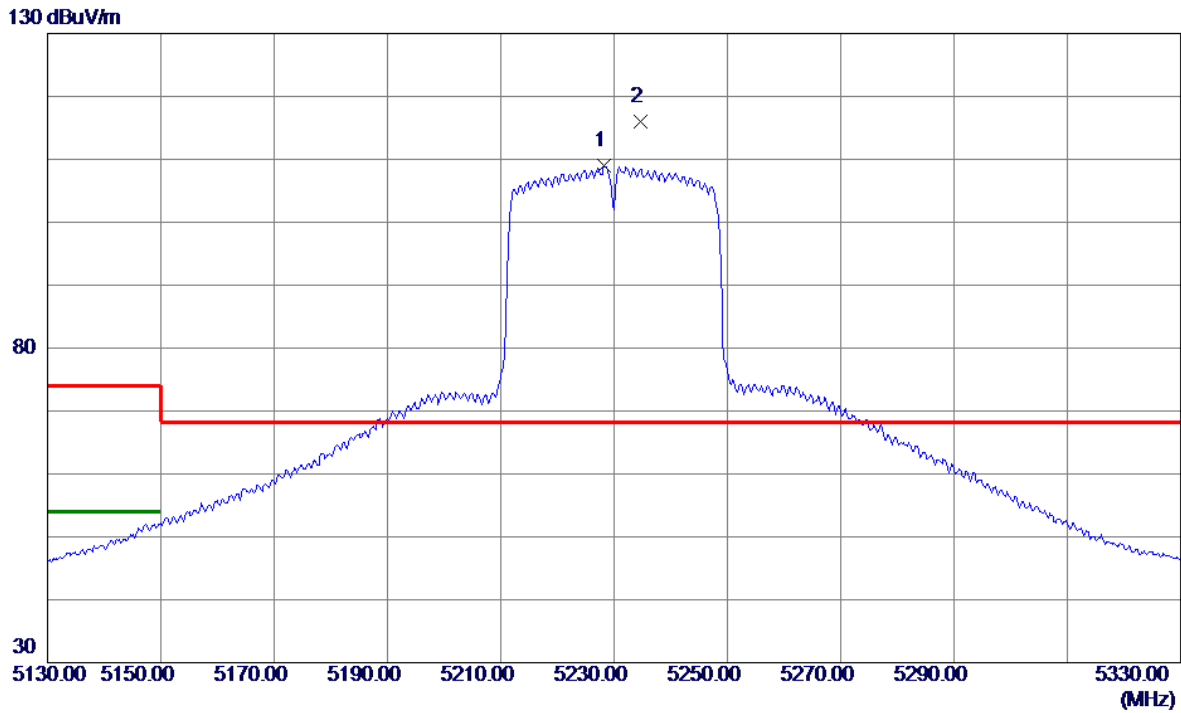

No.	Freq. MHz	Reading Level dBuV/m	Correct Factor dB	Measure ment dBuV/m	Limit dBuV/m	Margin dB	Detector	Comment
1	5228.3000	96.98	11.93	108.91	999.00	-890.09	AVG	No Limit
2 *	5234.6000	104.07	11.94	116.01	68.20	47.81	Peak	No Limit

**REMARKS:**

- (1) Measurement Value = Reading Level + Correct Factor.
- (2) Margin Level = Measurement Value - Limit Value.

Test Mode	UNII-1_TX AC(VHT40) Mode 5230 MHz	Polarization	Vertical
-----------	-----------------------------------	--------------	----------

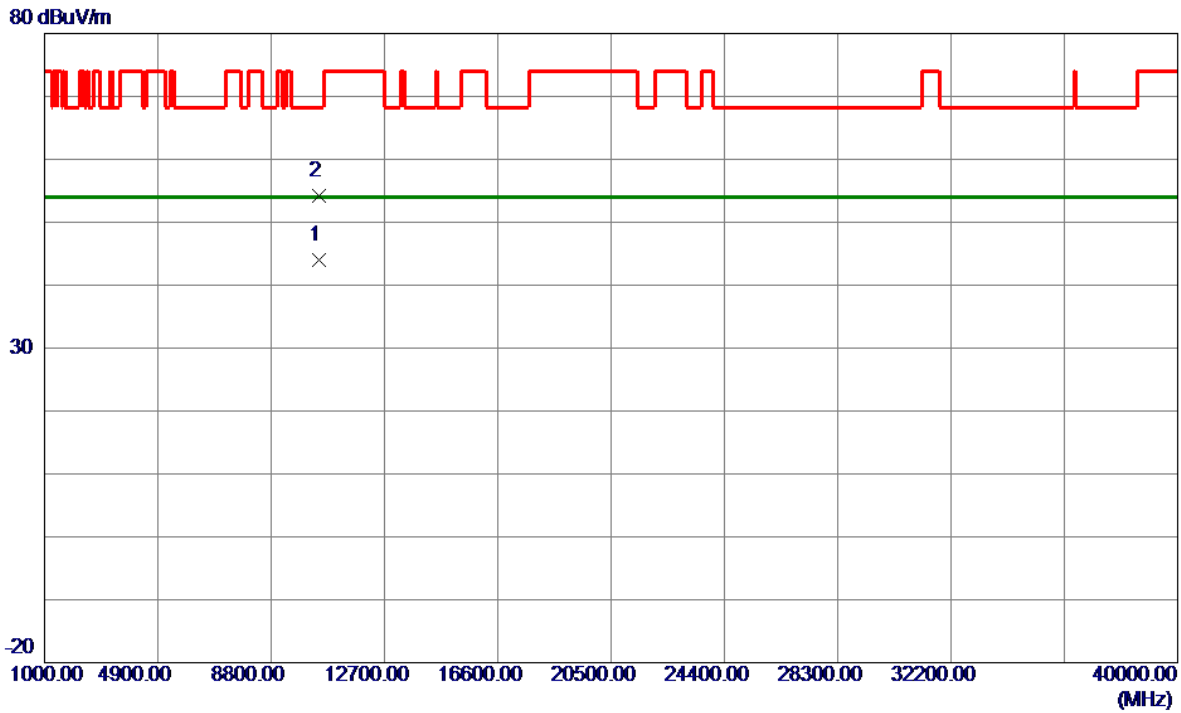

No.	Freq. MHz	Reading Level dBuV/m	Correct Factor dB	Measure ment dBuV/m	Limit dBuV/m	Margin dB	Detector	Comment
1 *	10457.8800	37.87	6.13	44.00	54.00	-10.00	AVG	
2	10462.7699	48.08	6.13	54.21	68.20	-13.99	Peak	

REMARKS:

- (1) Measurement Value = Reading Level + Correct Factor.
- (2) Margin Level = Measurement Value - Limit Value.

Test Mode	UNII-1_TX AC(VHT80) Mode 5210 MHz	Polarization	Vertical
-----------	-----------------------------------	--------------	----------

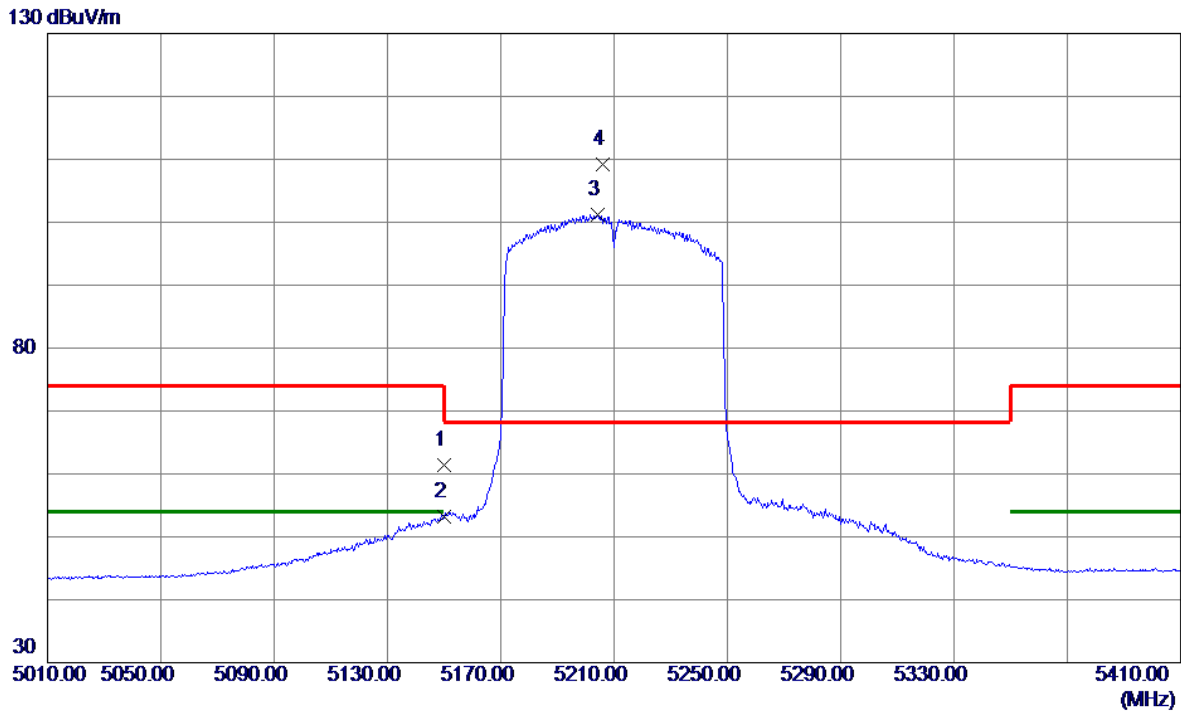

No.	Freq. MHz	Reading Level dBuV/m	Correct Factor dB	Measure ment dBuV/m	Limit dBuV/m	Margin dB	Detector	Comment
1	5150.0000	49.62	11.75	61.37	74.00	-12.63	Peak	
2	5150.0000	41.49	11.75	53.24	54.00	-0.76	AVG	
3	5204.2000	89.42	11.87	101.29	999.00	-897.71	AVG	No Limit
4 *	5206.2000	97.36	11.88	109.24	68.20	41.04	Peak	No Limit

**REMARKS:**

- (1) Measurement Value = Reading Level + Correct Factor.
- (2) Margin Level = Measurement Value - Limit Value.

Test Mode	UNII-1_TX AC(VHT80) Mode 5210 MHz	Polarization	Vertical
-----------	-----------------------------------	--------------	----------

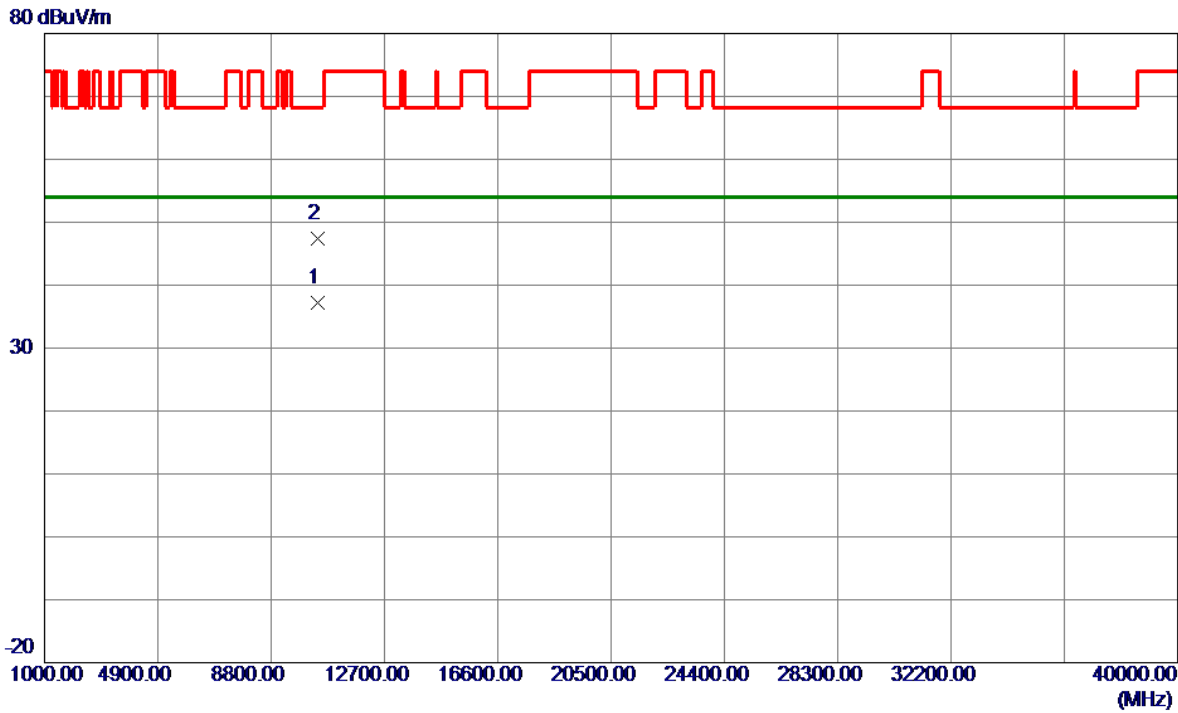

No.	Freq. MHz	Reading Level dBuV/m	Correct Factor dB	Measure ment dBuV/m	Limit dBuV/m	Margin dB	Detector	Comment
1 *	10420.1200	31.16	6.10	37.26	54.00	-16.74	AVG	
2	10420.6700	41.31	6.10	47.41	68.20	-20.79	Peak	

**REMARKS:**

- (1) Measurement Value = Reading Level + Correct Factor.
- (2) Margin Level = Measurement Value - Limit Value.

Test Mode	UNII-1_TX AX(HE20) Mode 5180 MHz	Polarization	Vertical
-----------	----------------------------------	--------------	----------

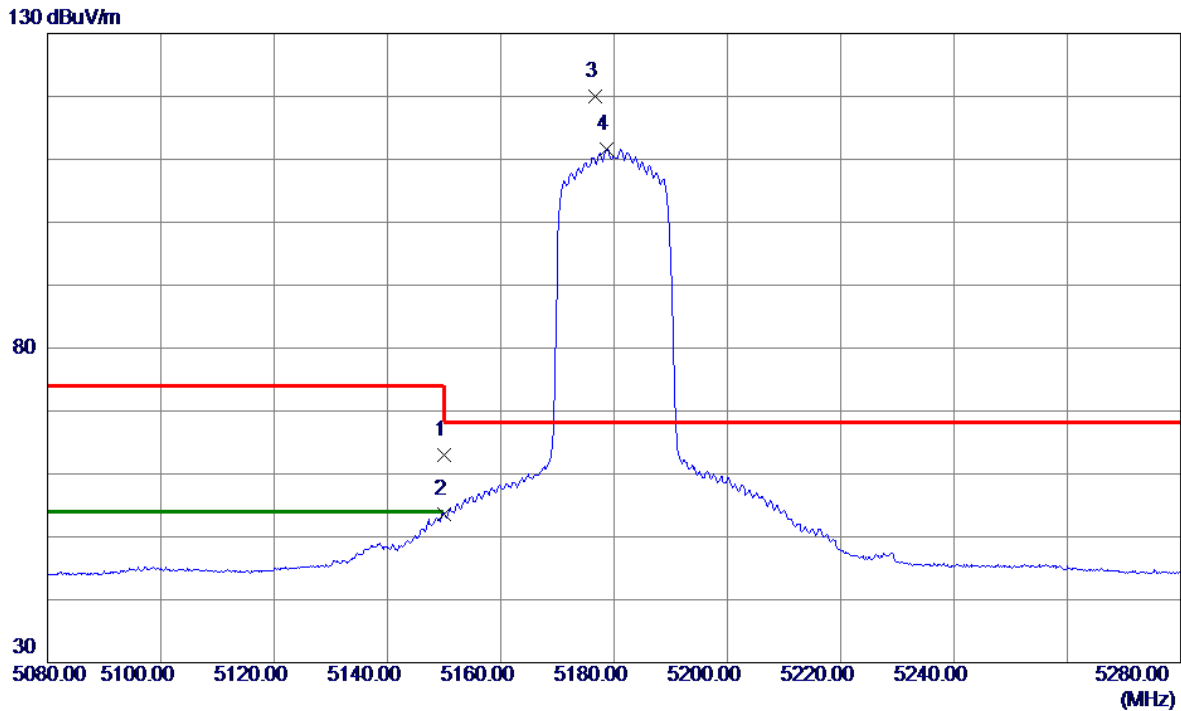

No.	Freq. MHz	Reading Level dBuV/m	Correct Factor dB	Measure ment dBuV/m	Limit dBuV/m	Margin dB	Detector	Comment
1	5150.0000	51.32	11.75	63.07	74.00	-10.93	Peak	
2	5150.0000	41.78	11.75	53.53	54.00	-0.47	AVG	
3 *	5176.7000	108.21	11.81	120.02	68.20	51.82	Peak	No Limit
4	5178.7000	99.78	11.81	111.59	999.00	-887.41	AVG	No Limit

**REMARKS:**

- (1) Measurement Value = Reading Level + Correct Factor.
- (2) Margin Level = Measurement Value - Limit Value.

Test Mode	UNII-1_TX AX(HE20) Mode 5180 MHz	Polarization	Vertical
-----------	----------------------------------	--------------	----------

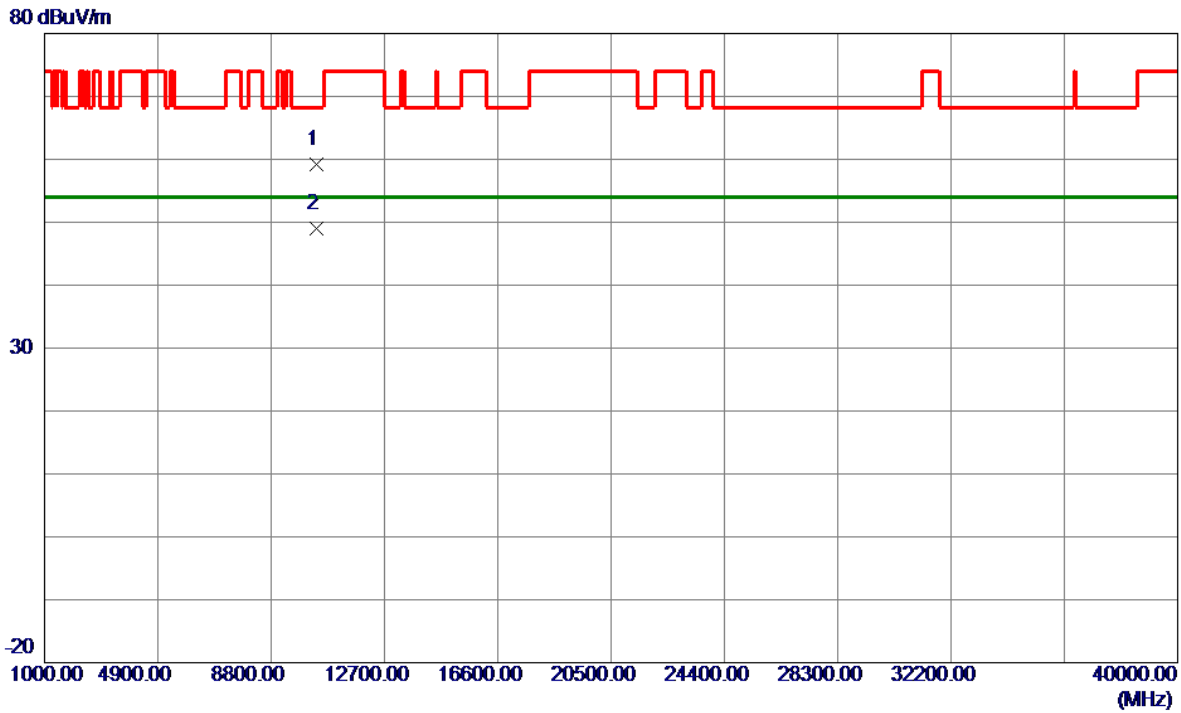

No.	Freq. MHz	Reading Level dBuV/m	Correct Factor dB	Measure ment dBuV/m	Limit dBuV/m	Margin dB	Detector	Comment
1	10359.6300	53.05	6.06	59.11	68.20	-9.09	Peak	
2 *	10360.0800	43.00	6.06	49.06	54.00	-4.94	AVG	

REMARKS:

- (1) Measurement Value = Reading Level + Correct Factor.
- (2) Margin Level = Measurement Value - Limit Value.

Test Mode	UNII-1_TX AX(HE20) Mode 5200 MHz	Polarization	Vertical
-----------	----------------------------------	--------------	----------

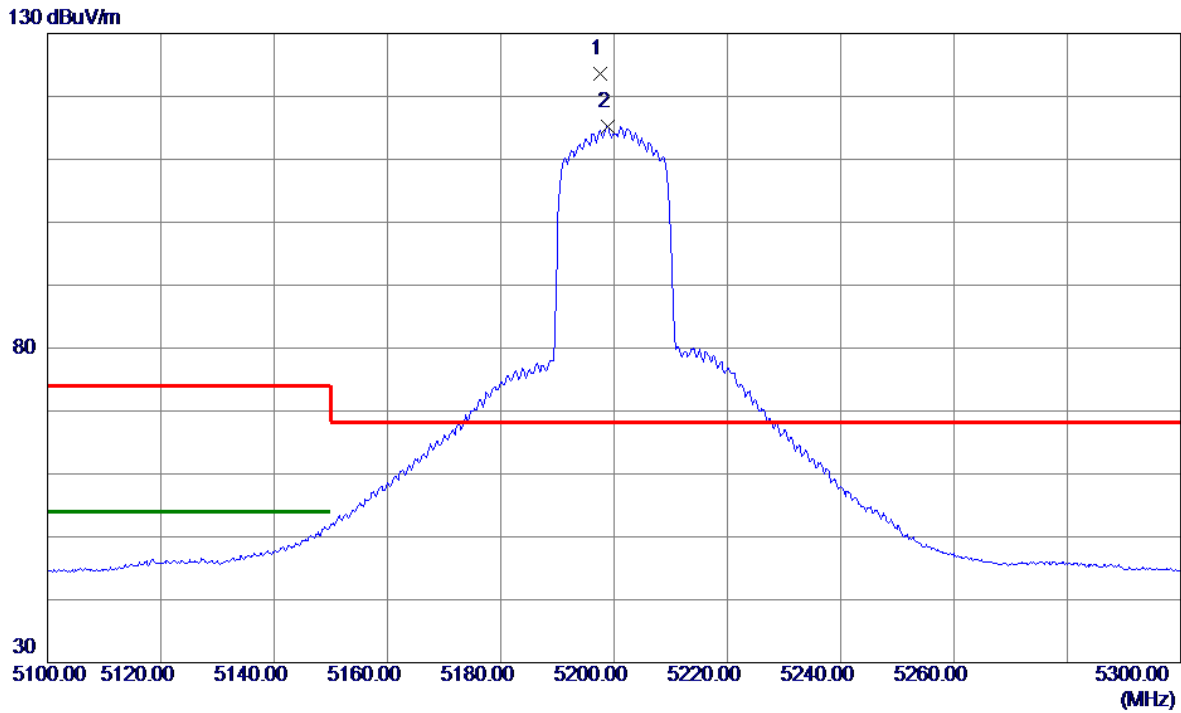

No.	Freq. MHz	Reading Level dBuV/m	Correct Factor dB	Measure ment dBuV/m	Limit dBuV/m	Margin dB	Detector	Comment
1 *	5197.6000	111.70	11.86	123.56	68.20	55.36	Peak	No Limit
2	5198.8000	103.41	11.86	115.27	999.00	-883.73	AVG	No Limit

**REMARKS:**

- (1) Measurement Value = Reading Level + Correct Factor.
- (2) Margin Level = Measurement Value - Limit Value.



Test Mode	UNII-1_TX AX(HE20) Mode 5200 MHz	Polarization	Vertical
-----------	----------------------------------	--------------	----------

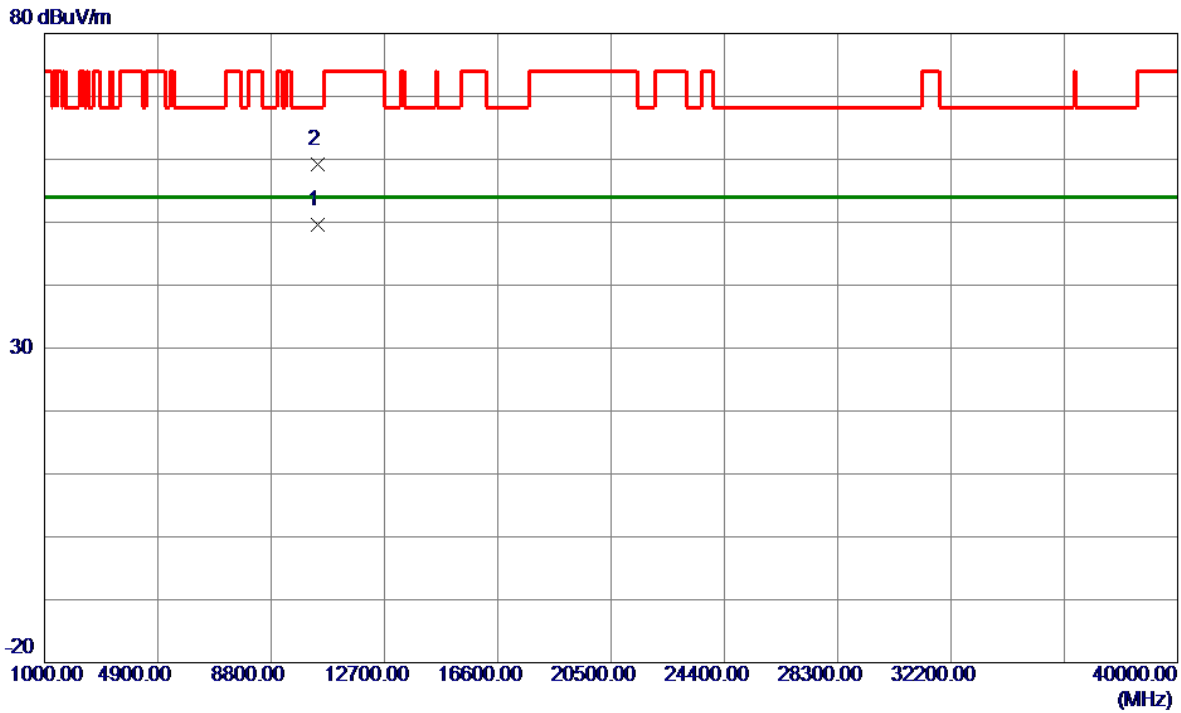

No.	Freq. MHz	Reading Level dBuV/m	Correct Factor dB	Measure ment dBuV/m	Limit dBuV/m	Margin dB	Detector	Comment
1 *	10400.4800	43.59	6.09	49.68	54.00	-4.32	AVG	
2	10401.5000	53.19	6.09	59.28	68.20	-8.92	Peak	

**REMARKS:**

- (1) Measurement Value = Reading Level + Correct Factor.
- (2) Margin Level = Measurement Value - Limit Value.

Test Mode	UNII-1_TX AX(HE20) Mode 5240 MHz	Polarization	Vertical
-----------	----------------------------------	--------------	----------

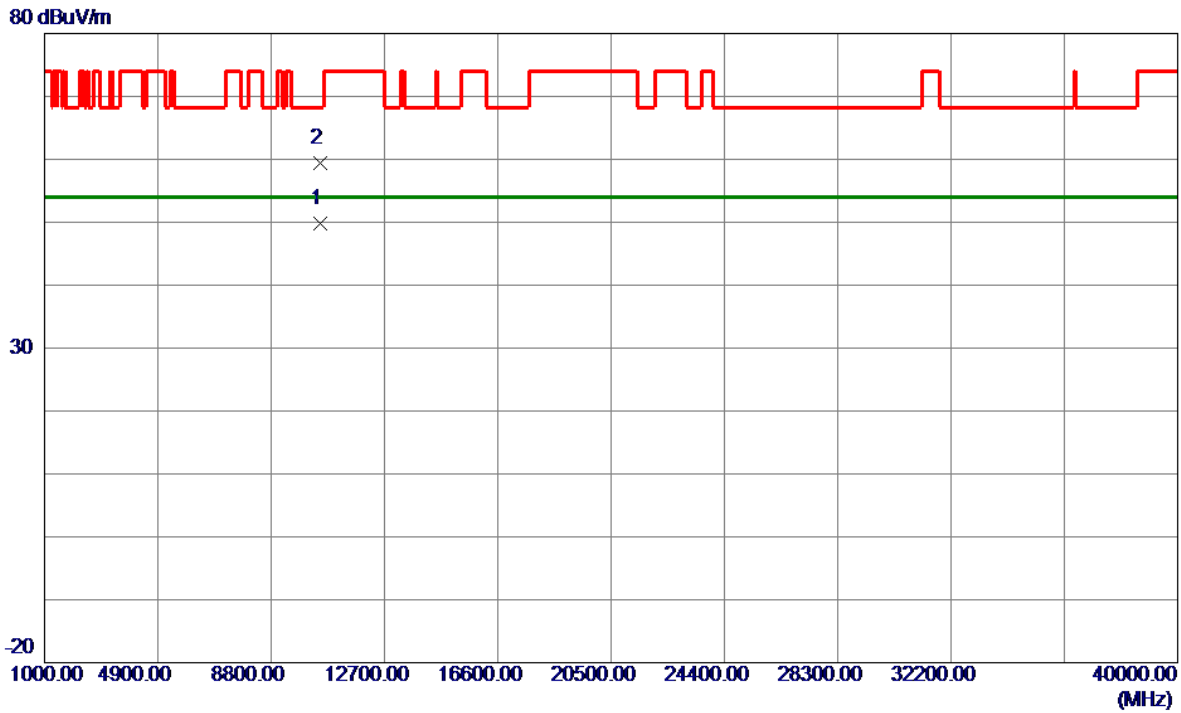

No.	Freq. MHz	Reading Level dBuV/m	Correct Factor dB	Measure ment dBuV/m	Limit dBuV/m	Margin dB	Detector	Comment
1 *	10480.3400	43.62	6.15	49.77	54.00	-4.23	AVG	
2	10480.4400	53.34	6.15	59.49	68.20	-8.71	Peak	

**REMARKS:**

- (1) Measurement Value = Reading Level + Correct Factor.
- (2) Margin Level = Measurement Value - Limit Value.

Test Mode	UNII-1_TX AX(HE40) Mode 5190 MHz	Polarization	Vertical
-----------	----------------------------------	--------------	----------

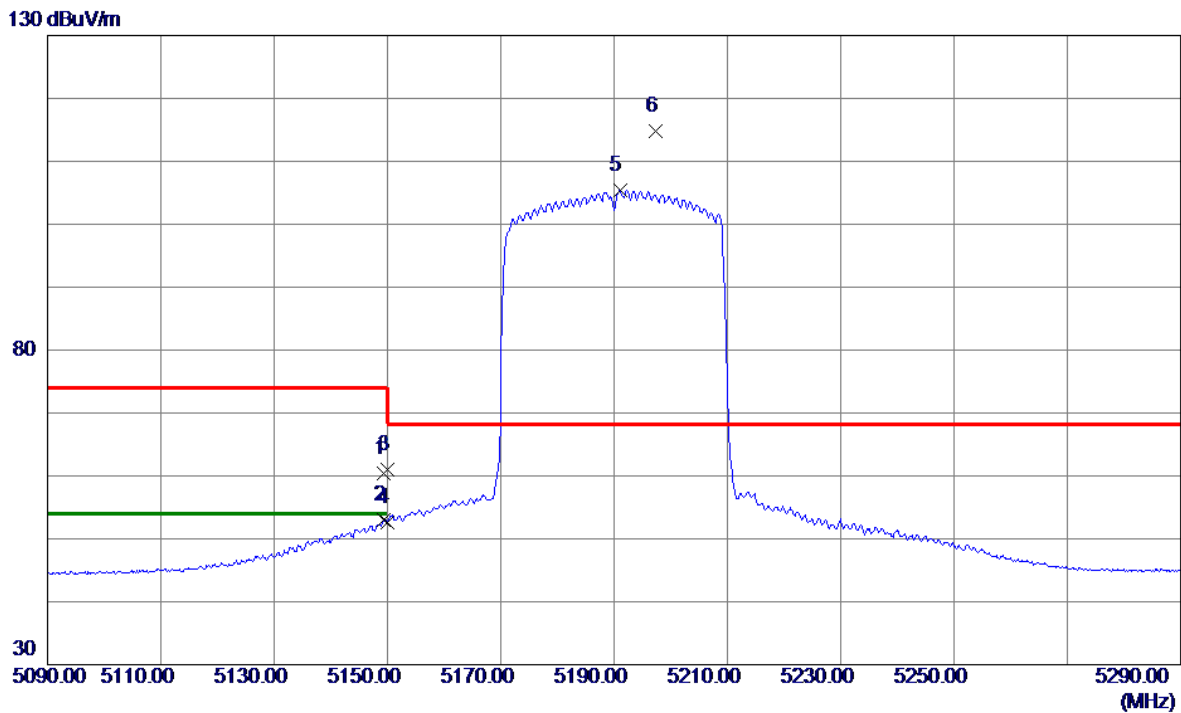

No.	Freq. MHz	Reading Level dBuV/m	Correct Factor dB	Measure ment dBuV/m	Limit dBuV/m	Margin dB	Detector	Comment
1	5149.3000	48.69	11.74	60.43	74.00	-13.57	Peak	
2	5149.3000	41.31	11.74	53.05	54.00	-0.95	AVG	
3	5150.0000	49.19	11.75	60.94	74.00	-13.06	Peak	
4	5150.0000	40.90	11.75	52.65	54.00	-1.35	AVG	
5	5191.0000	93.57	11.84	105.41	999.00	-893.59	AVG	No Limit
6 *	5197.3000	103.00	11.86	114.86	68.20	46.66	Peak	No Limit

REMARKS:

- (1) Measurement Value = Reading Level + Correct Factor.
- (2) Margin Level = Measurement Value - Limit Value.

Test Mode	UNII-1_TX AX(HE40) Mode 5190 MHz	Polarization	Vertical
-----------	----------------------------------	--------------	----------

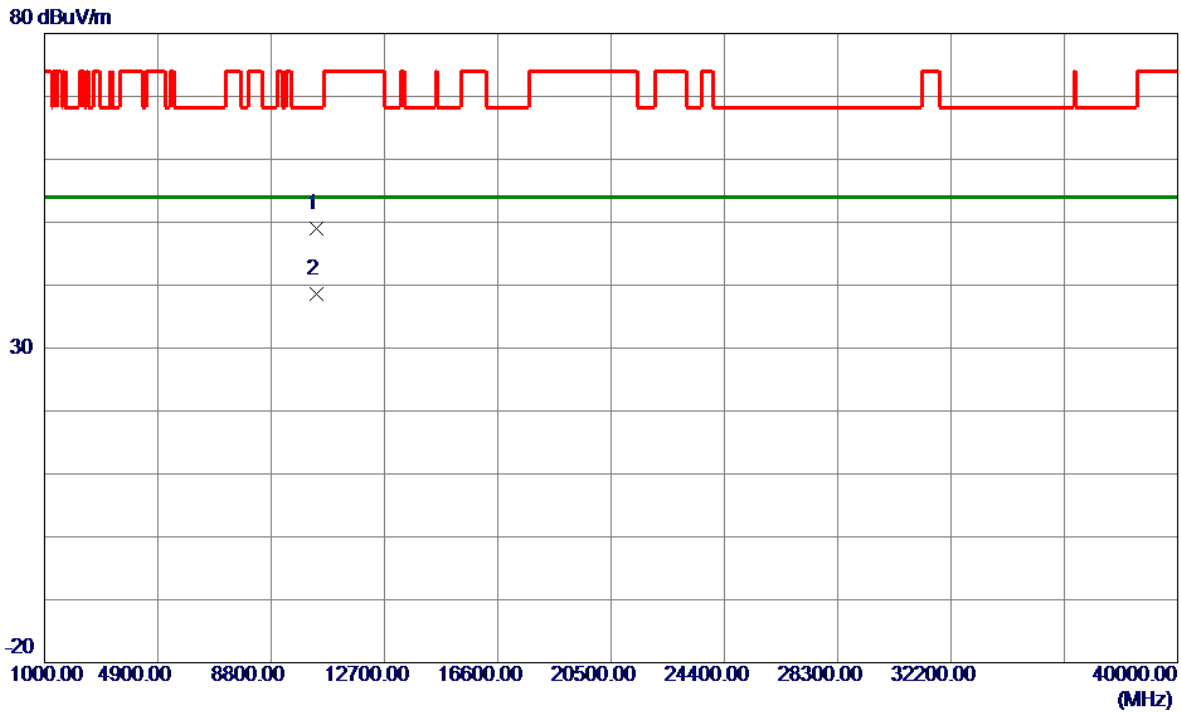

No.	Freq. MHz	Reading Level dBuV/m	Correct Factor dB	Measure ment dBuV/m	Limit dBuV/m	Margin dB	Detector	Comment
1	10375.0700	42.94	6.07	49.01	68.20	-19.19	Peak	
2 *	10377.9100	32.52	6.07	38.59	54.00	-15.41	AVG	

**REMARKS:**

- (1) Measurement Value = Reading Level + Correct Factor.
- (2) Margin Level = Measurement Value - Limit Value.

Test Mode	UNII-1_TX AX(HE40) Mode 5230 MHz	Polarization	Vertical
-----------	----------------------------------	--------------	----------

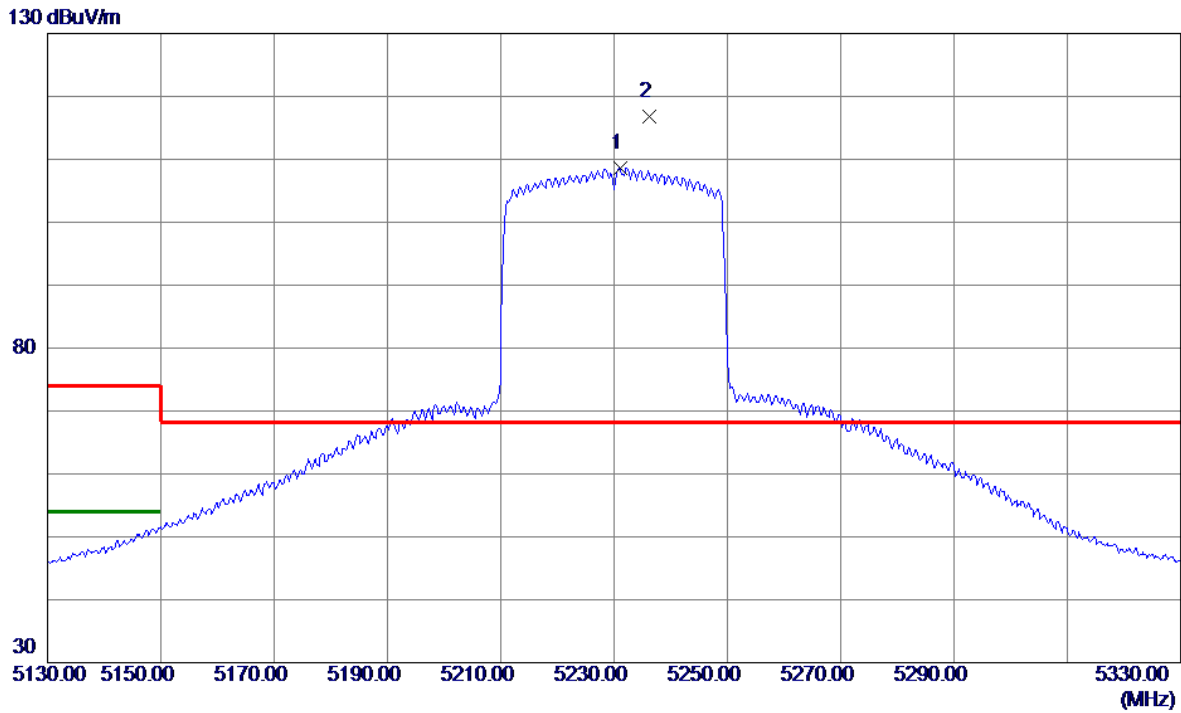

No.	Freq. MHz	Reading Level dBuV/m	Correct Factor dB	Measure ment dBuV/m	Limit dBuV/m	Margin dB	Detector	Comment
1	5231.1000	96.73	11.93	108.66	999.00	-890.34	AVG	No Limit
2 *	5236.2000	104.83	11.95	116.78	68.20	48.58	Peak	No Limit

**REMARKS:**

- (1) Measurement Value = Reading Level + Correct Factor.
- (2) Margin Level = Measurement Value - Limit Value.

Test Mode	UNII-1_TX AX(HE40) Mode 5230 MHz	Polarization	Vertical
-----------	----------------------------------	--------------	----------

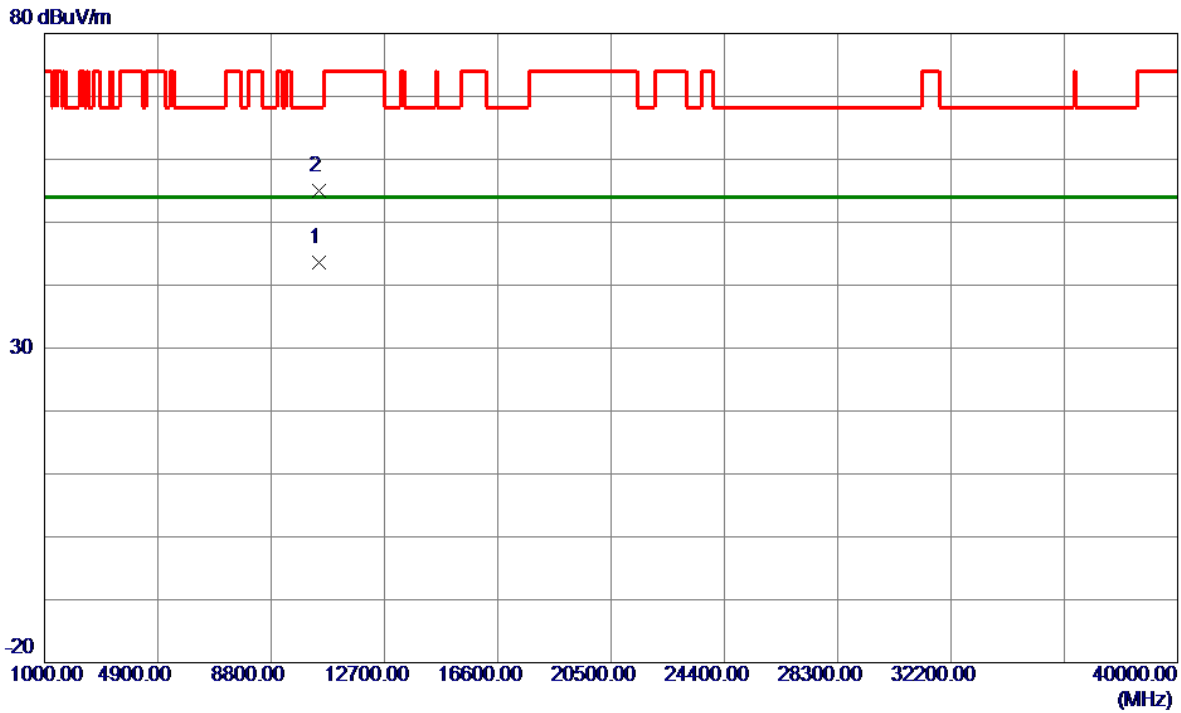

No.	Freq. MHz	Reading Level dBuV/m	Correct Factor dB	Measure ment dBuV/m	Limit dBuV/m	Margin dB	Detector	Comment
1 *	10458.0100	37.42	6.13	43.55	54.00	-10.45	AVG	
2	10462.6600	48.96	6.13	55.09	68.20	-13.11	Peak	

**REMARKS:**

- (1) Measurement Value = Reading Level + Correct Factor.
- (2) Margin Level = Measurement Value - Limit Value.

Test Mode	UNII-1_TX AX(HE80) Mode 5210 MHz	Polarization	Vertical
-----------	----------------------------------	--------------	----------

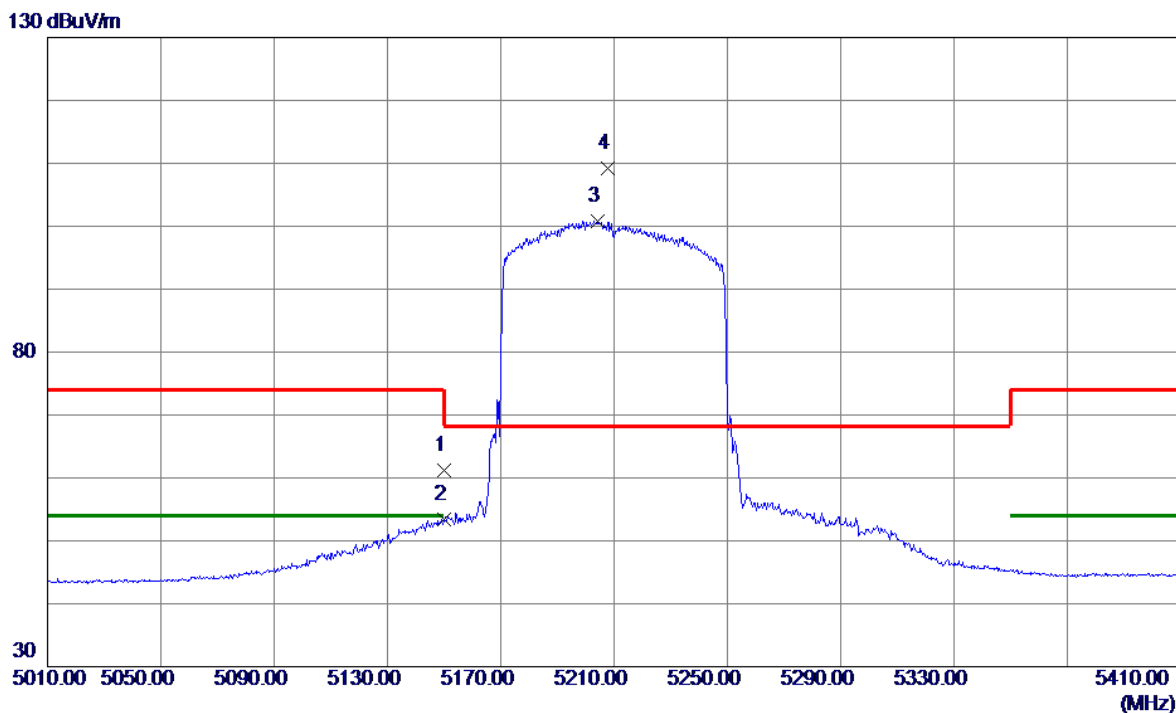

No.	Freq. MHz	Reading Level dBuV/m	Correct Factor dB	Measure ment dBuV/m	Limit dBuV/m	Margin dB	Detector	Comment
1	5150.0000	49.38	11.75	61.13	74.00	-12.87	Peak	
2	5150.0000	41.69	11.75	53.44	54.00	-0.56	AVG	
3	5204.2000	89.02	11.87	100.89	999.00	-898.11	AVG	No Limit
4 *	5207.8000	97.41	11.88	109.29	68.20	41.09	Peak	No Limit

**REMARKS:**

- (1) Measurement Value = Reading Level + Correct Factor.
- (2) Margin Level = Measurement Value - Limit Value.

Test Mode	UNII-1_TX AX(HE80) Mode 5210 MHz	Polarization	Vertical
-----------	----------------------------------	--------------	----------

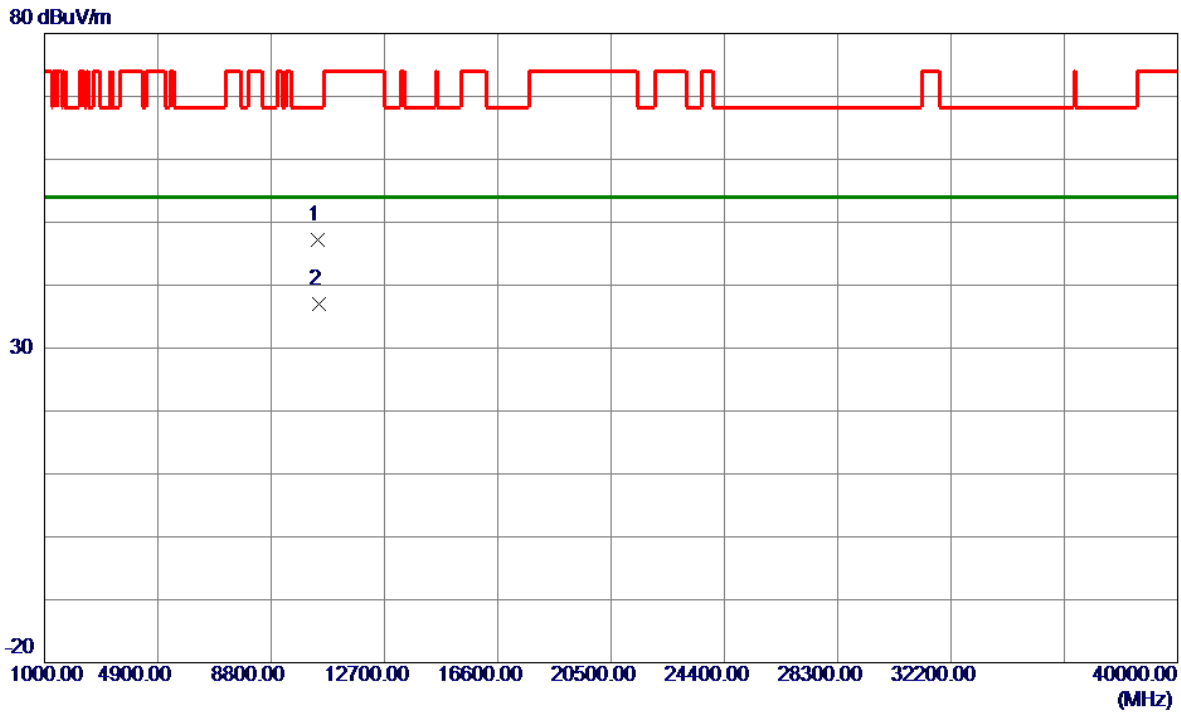

No.	Freq. MHz	Reading Level dBuV/m	Correct Factor dB	Measure ment dBuV/m	Limit dBuV/m	Margin dB	Detector	Comment
1	10420.8000	41.02	6.10	47.12	68.20	-21.08	Peak	
2 *	10427.7000	30.84	6.11	36.95	54.00	-17.05	AVG	

**REMARKS:**

- (1) Measurement Value = Reading Level + Correct Factor.
- (2) Margin Level = Measurement Value - Limit Value.



Test Mode	UNII-3_TX A Mode 5745 MHz	Polarization	Vertical
-----------	---------------------------	--------------	----------

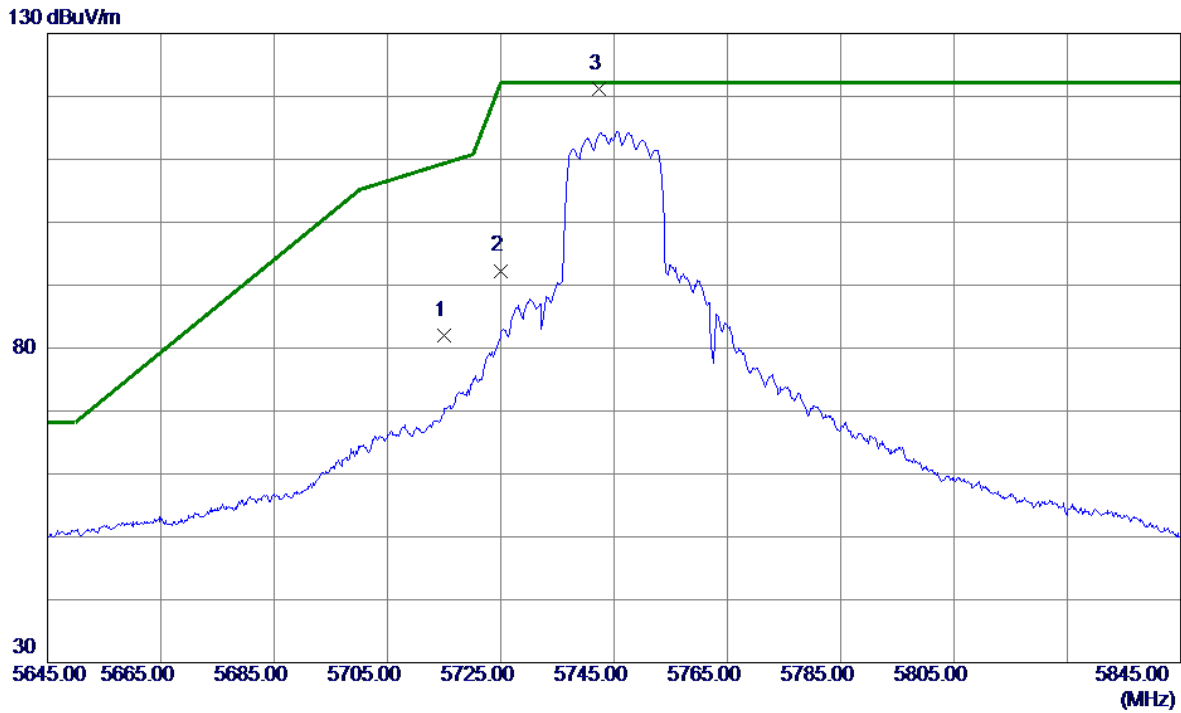

No.	Freq. MHz	Reading Level dBuV/m	Correct Factor dB	Measure ment dBuV/m	Limit dBuV/m	Margin dB	Detector	Comment
1	5715.0000	68.81	13.21	82.02	109.40	-27.38	Peak	
2	5725.0000	79.06	13.24	92.30	122.20	-29.90	Peak	
3 *	5742.4000	107.94	13.29	121.23	122.20	-0.97	Peak	No Limit

REMARKS:

- (1) Measurement Value = Reading Level + Correct Factor.
- (2) Margin Level = Measurement Value - Limit Value.

Test Mode	UNII-3_TX A Mode 5745 MHz	Polarization	Vertical
-----------	---------------------------	--------------	----------

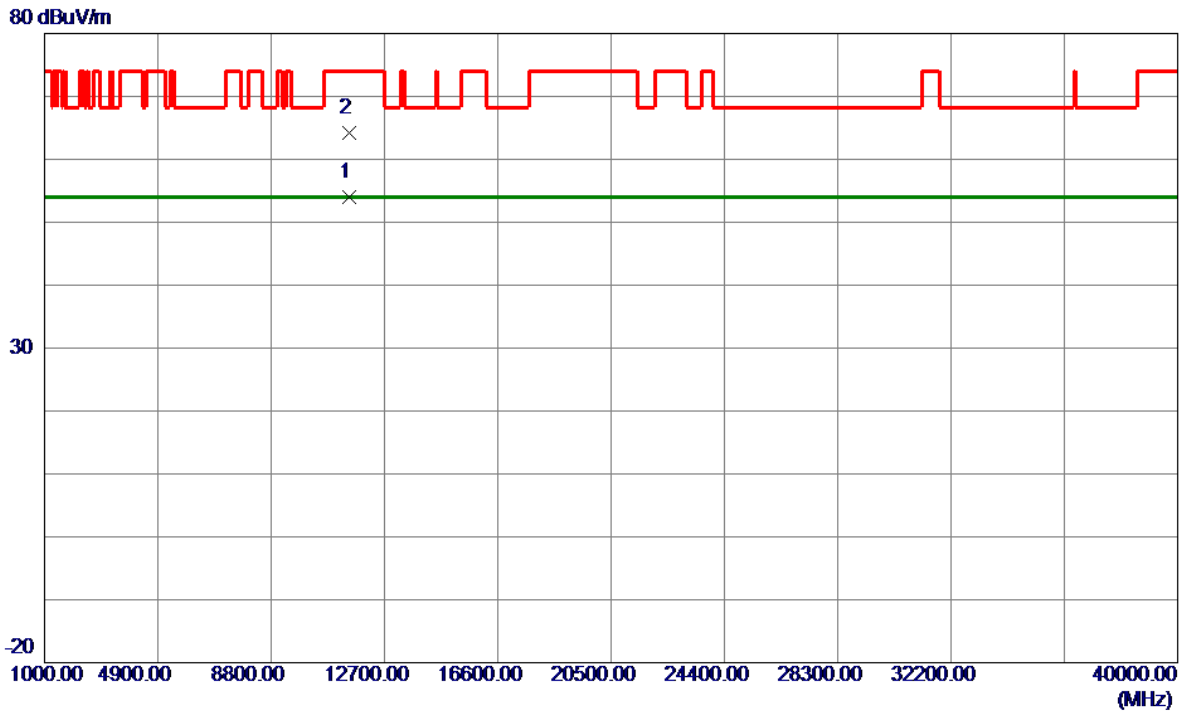

No.	Freq. MHz	Reading Level dBuV/m	Correct Factor dB	Measure ment dBuV/m	Limit dBuV/m	Margin dB	Detector	Comment
1 *	11490.4200	47.20	6.75	53.95	54.00	-0.05	AVG	
2	11491.4700	57.39	6.75	64.14	74.00	-9.86	Peak	

REMARKS:

- (1) Measurement Value = Reading Level + Correct Factor.
- (2) Margin Level = Measurement Value - Limit Value.

Test Mode	UNII-3_TX A Mode 5785 MHz	Polarization	Vertical
-----------	---------------------------	--------------	----------

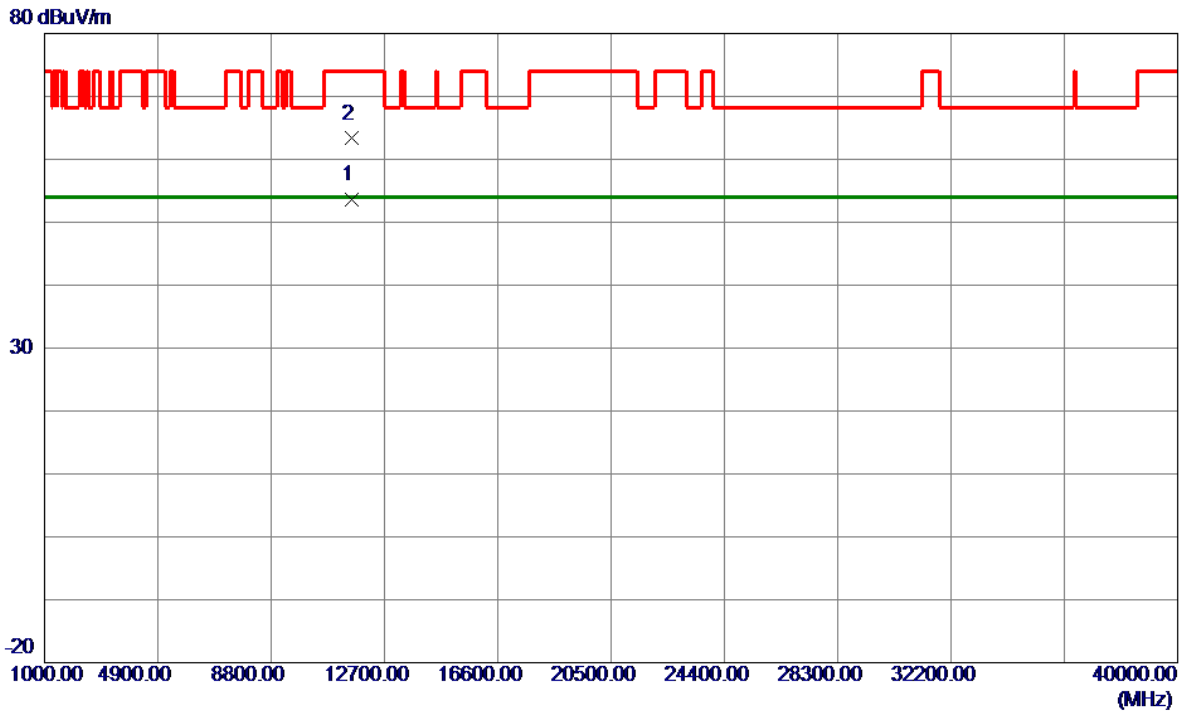

No.	Freq. MHz	Reading Level dBuV/m	Correct Factor dB	Measure ment dBuV/m	Limit dBuV/m	Margin dB	Detector	Comment
1 *	11570.3200	46.85	6.74	53.59	54.00	-0.41	AVG	
2	11570.4600	56.56	6.74	63.30	74.00	-10.70	Peak	

**REMARKS:**

- (1) Measurement Value = Reading Level + Correct Factor.
- (2) Margin Level = Measurement Value - Limit Value.

Test Mode	UNII-3_TX A Mode 5825 MHz	Polarization	Vertical
-----------	---------------------------	--------------	----------

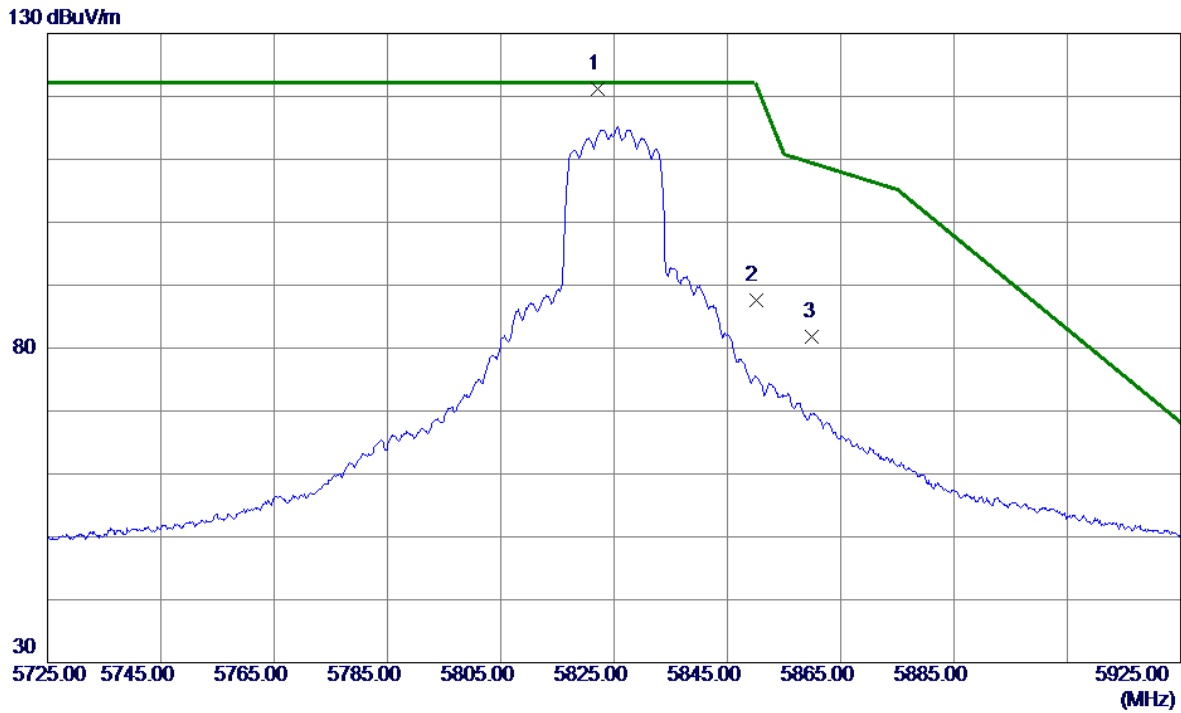

No.	Freq. MHz	Reading Level dBuV/m	Correct Factor dB	Measure ment dBuV/m	Limit dBuV/m	Margin dB	Detector	Comment
1 *	5822.2000	107.59	13.53	121.12	122.20	-1.08	Peak	No Limit
2	5850.0000	74.02	13.62	87.64	122.20	-34.56	Peak	
3	5860.0000	68.13	13.65	81.78	109.40	-27.62	Peak	

**REMARKS:**

- (1) Measurement Value = Reading Level + Correct Factor.
- (2) Margin Level = Measurement Value - Limit Value.

Test Mode	UNII-3_TX A Mode 5825 MHz	Polarization	Vertical
-----------	---------------------------	--------------	----------

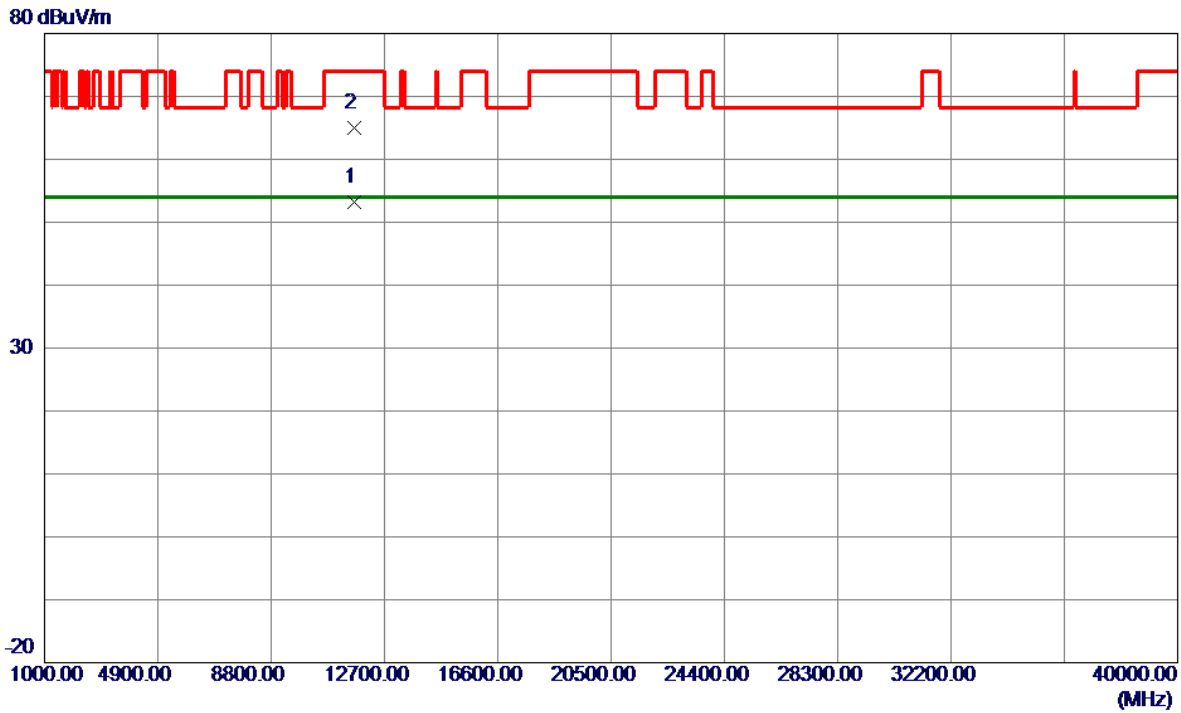

No.	Freq. MHz	Reading Level dBuV/m	Correct Factor dB	Measure ment dBuV/m	Limit dBuV/m	Margin dB	Detector	Comment
1 *	11650.6200	46.40	6.71	53.11	54.00	-0.89	AVG	
2	11651.3300	58.34	6.71	65.05	74.00	-8.95	Peak	

**REMARKS:**

- (1) Measurement Value = Reading Level + Correct Factor.
- (2) Margin Level = Measurement Value - Limit Value.

Test Mode	UNII-3_TX AC(VHT20) Mode 5745 MHz	Polarization	Vertical
-----------	-----------------------------------	--------------	----------

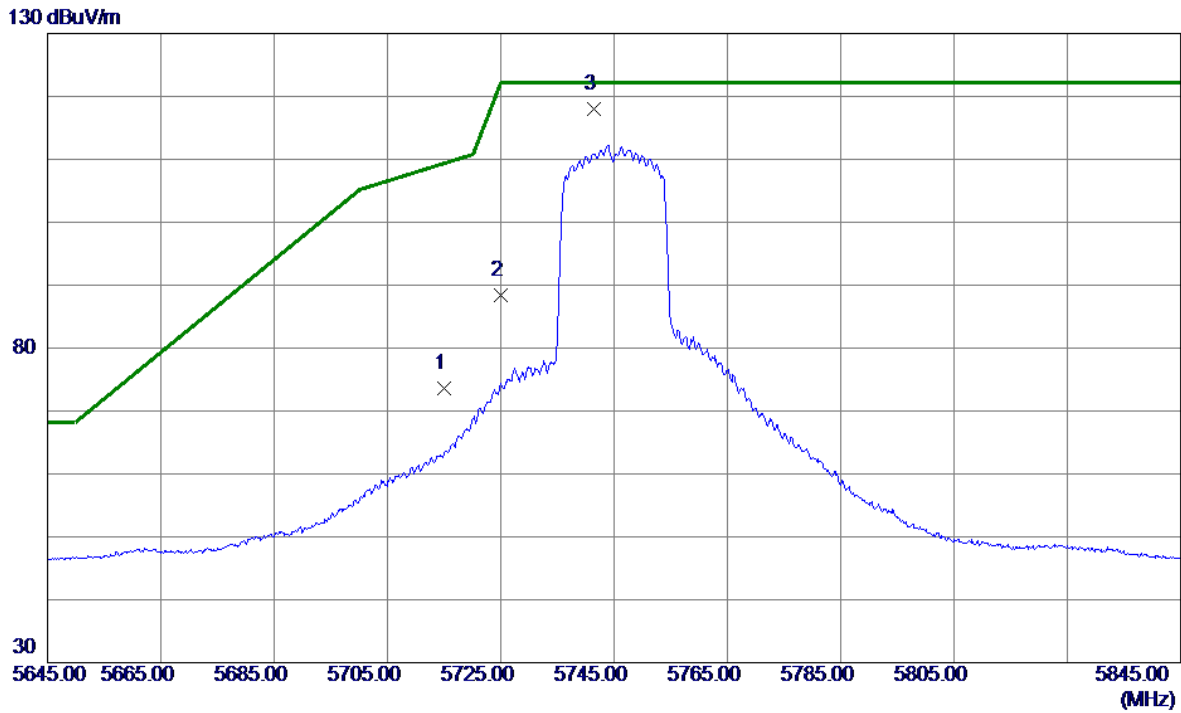

No.	Freq. MHz	Reading Level dBuV/m	Correct Factor dB	Measure ment dBuV/m	Limit dBuV/m	Margin dB	Detector	Comment
1	5715.0000	60.31	13.21	73.52	109.40	-35.88	Peak	
2	5725.0000	75.08	13.24	88.32	122.20	-33.88	Peak	
3 *	5741.4000	104.71	13.29	118.00	122.20	-4.20	Peak	No Limit

**REMARKS:**

- (1) Measurement Value = Reading Level + Correct Factor.
- (2) Margin Level = Measurement Value - Limit Value.

Test Mode	UNII-3_TX AC(VHT20) Mode 5745 MHz	Polarization	Vertical
-----------	-----------------------------------	--------------	----------

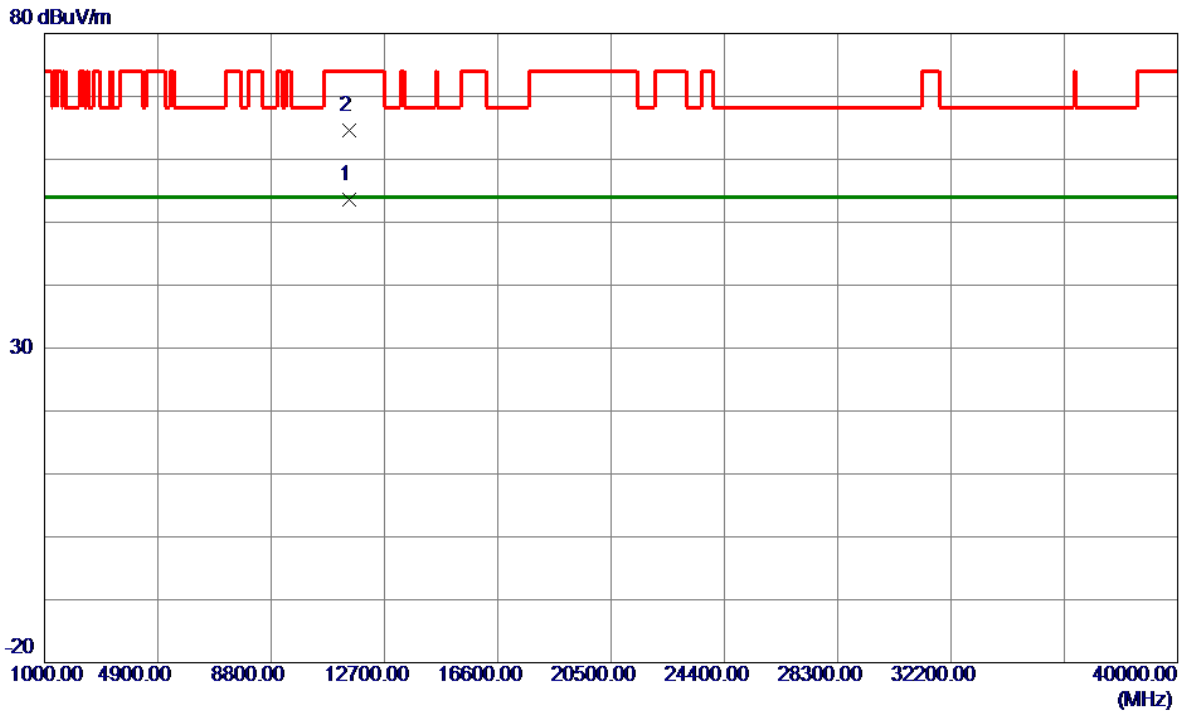

No.	Freq. MHz	Reading Level dBuV/m	Correct Factor dB	Measure ment dBuV/m	Limit dBuV/m	Margin dB	Detector	Comment
1 *	11487.7500	46.85	6.74	53.59	54.00	-0.41	AVG	
2	11488.0100	57.93	6.74	64.67	74.00	-9.33	Peak	

**REMARKS:**

- (1) Measurement Value = Reading Level + Correct Factor.
- (2) Margin Level = Measurement Value - Limit Value.

Test Mode	UNII-3_TX AC(VHT20) Mode 5785 MHz	Polarization	Vertical
-----------	-----------------------------------	--------------	----------

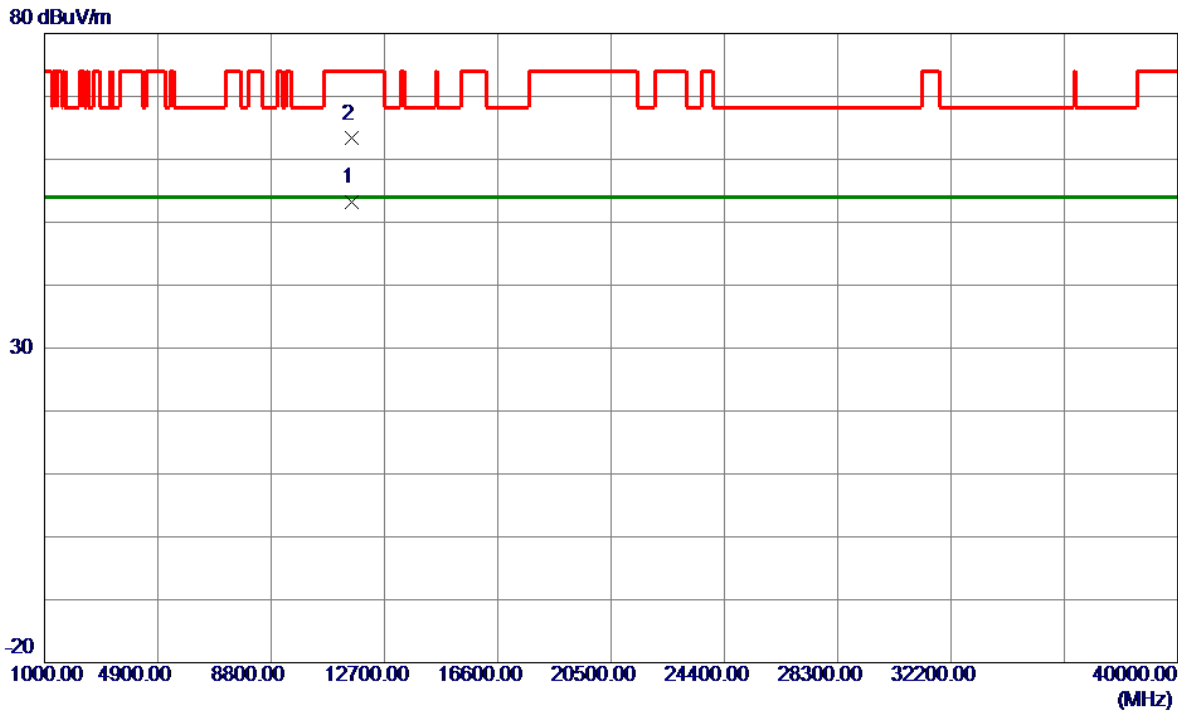

No.	Freq. MHz	Reading Level dBuV/m	Correct Factor dB	Measure ment dBuV/m	Limit dBuV/m	Margin dB	Detector	Comment
1 *	11570.4500	46.53	6.74	53.27	54.00	-0.73	AVG	
2	11575.8900	56.57	6.73	63.30	74.00	-10.70	Peak	

**REMARKS:**

- (1) Measurement Value = Reading Level + Correct Factor.
- (2) Margin Level = Measurement Value - Limit Value.



Test Mode	UNII-3_TX AC(VHT20) Mode 5825 MHz	Polarization	Vertical
-----------	-----------------------------------	--------------	----------

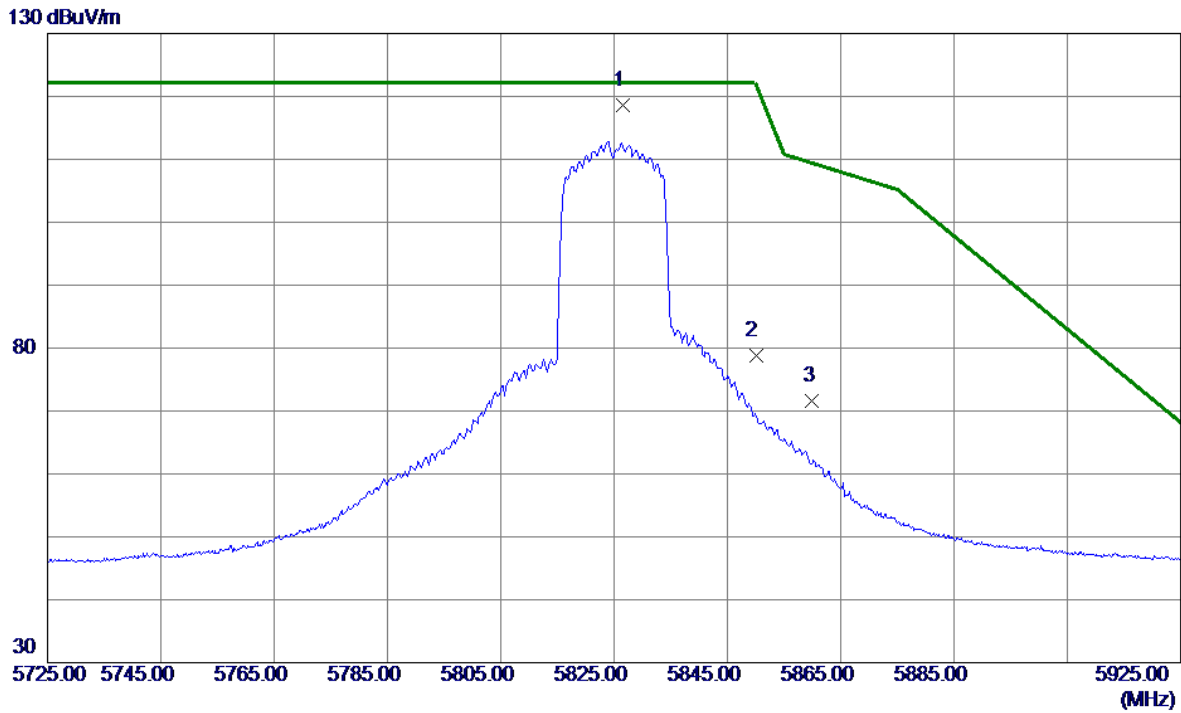

No.	Freq. MHz	Reading Level dBuV/m	Correct Factor dB	Measure ment dBuV/m	Limit dBuV/m	Margin dB	Detector	Comment
1 *	5826.5000	105.13	13.54	118.67	122.20	-3.53	Peak	No Limit
2	5850.0000	65.16	13.62	78.78	122.20	-43.42	Peak	
3	5860.0000	57.88	13.65	71.53	109.40	-37.87	Peak	

**REMARKS:**

- (1) Measurement Value = Reading Level + Correct Factor.
- (2) Margin Level = Measurement Value - Limit Value.

Test Mode	UNII-3_TX AC(VHT20) Mode 5825 MHz	Polarization	Vertical
-----------	-----------------------------------	--------------	----------

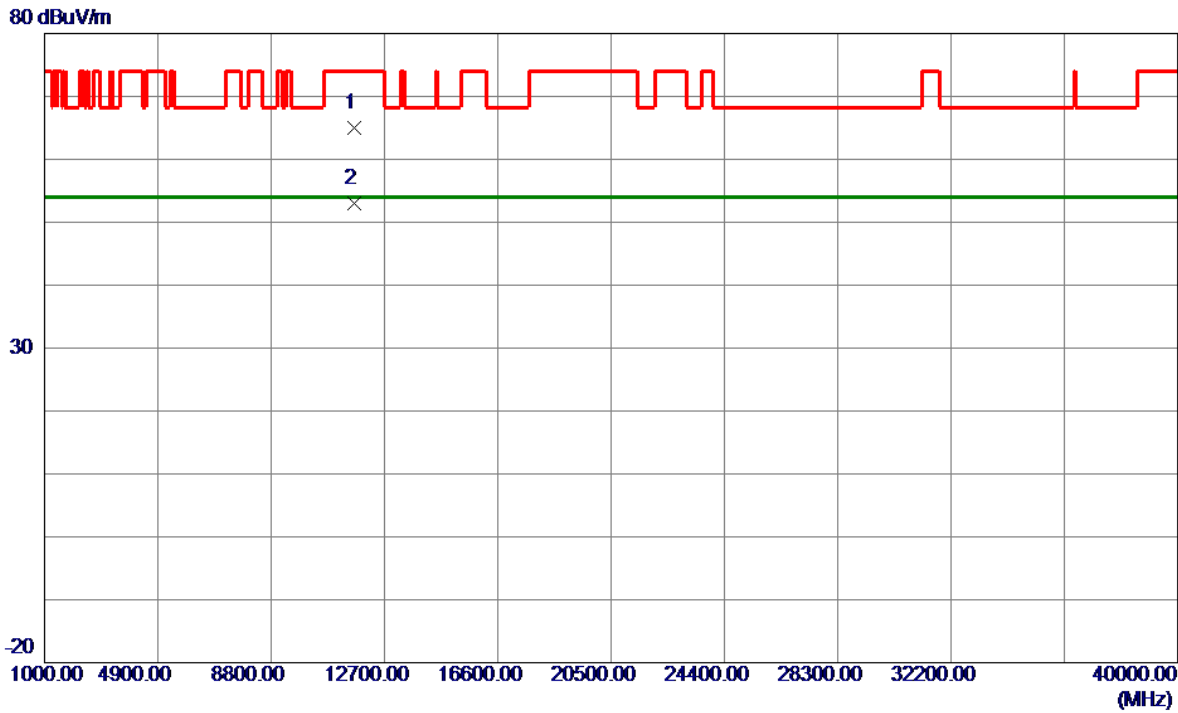

No.	Freq. MHz	Reading Level dBuV/m	Correct Factor dB	Measure ment dBuV/m	Limit dBuV/m	Margin dB	Detector	Comment
1	11647.8900	58.20	6.71	64.91	74.00	-9.09	Peak	
2 *	11650.5100	46.23	6.71	52.94	54.00	-1.06	AVG	

**REMARKS:**

- (1) Measurement Value = Reading Level + Correct Factor.
- (2) Margin Level = Measurement Value - Limit Value.

Test Mode	UNII-3_TX AC(VHT40) Mode 5755 MHz	Polarization	Vertical
-----------	-----------------------------------	--------------	----------

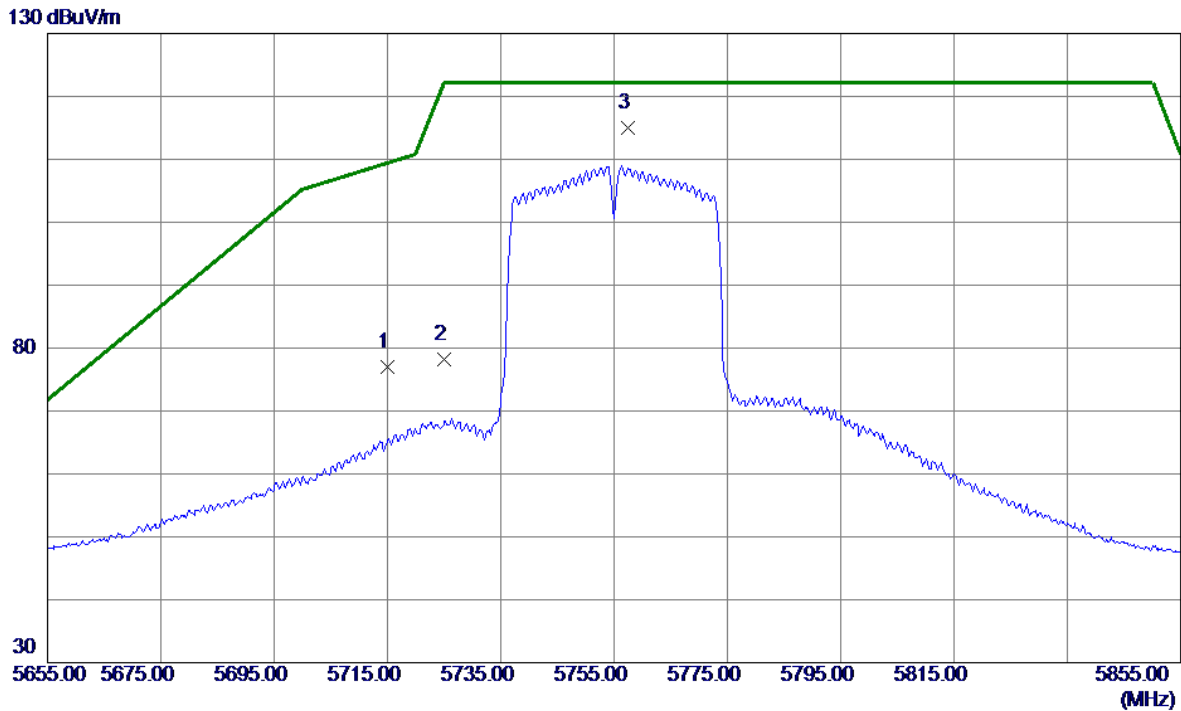

No.	Freq. MHz	Reading Level dBuV/m	Correct Factor dB	Measure ment dBuV/m	Limit dBuV/m	Margin dB	Detector	Comment
1	5715.0000	63.74	13.21	76.95	109.40	-32.45	Peak	
2	5725.0000	65.02	13.24	78.26	122.20	-43.94	Peak	
3 *	5757.5000	101.70	13.34	115.04	122.20	-7.16	Peak	No Limit

**REMARKS:**

- (1) Measurement Value = Reading Level + Correct Factor.
- (2) Margin Level = Measurement Value - Limit Value.

Test Mode	UNII-3_TX AC(VHT40) Mode 5755 MHz	Polarization	Vertical
-----------	-----------------------------------	--------------	----------

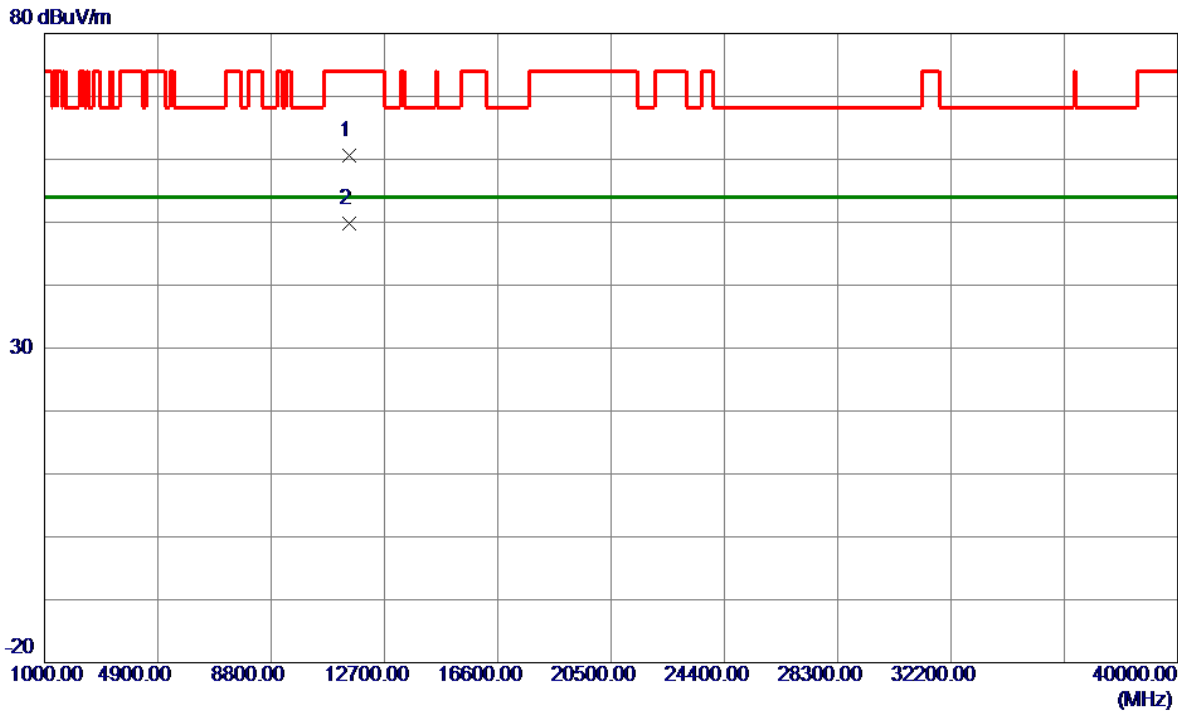

No.	Freq. MHz	Reading Level dBuV/m	Correct Factor dB	Measure ment dBuV/m	Limit dBuV/m	Margin dB	Detector	Comment
1	11507.3200	53.76	6.75	60.51	74.00	-13.49	Peak	
2 *	11507.5400	43.13	6.75	49.88	54.00	-4.12	AVG	

**REMARKS:**

- (1) Measurement Value = Reading Level + Correct Factor.
- (2) Margin Level = Measurement Value - Limit Value.

Test Mode	UNII-3_TX AC(VHT40) Mode 5795 MHz	Polarization	Vertical
-----------	-----------------------------------	--------------	----------

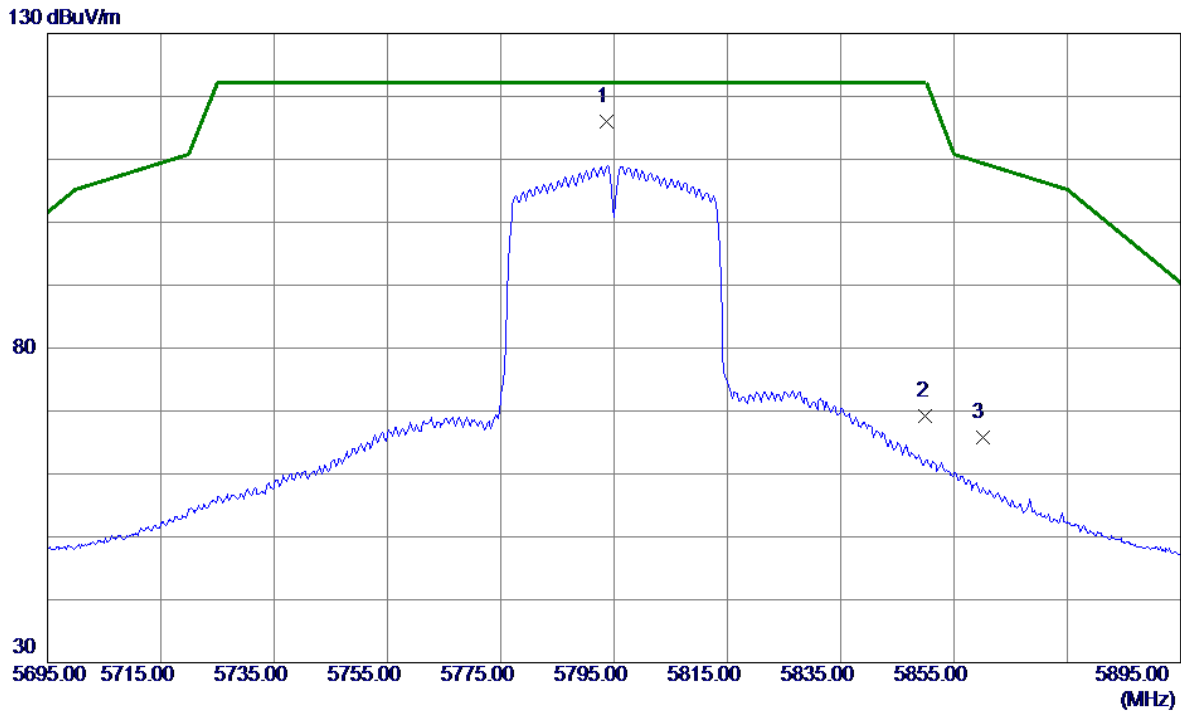

No.	Freq. MHz	Reading Level dBuV/m	Correct Factor dB	Measure ment dBuV/m	Limit dBuV/m	Margin dB	Detector	Comment
1 *	5793.7000	102.48	13.44	115.92	122.20	-6.28	Peak	No Limit
2	5850.0000	55.51	13.62	69.13	122.20	-53.07	Peak	
3	5860.0000	52.11	13.65	65.76	109.40	-43.64	Peak	

**REMARKS:**

- (1) Measurement Value = Reading Level + Correct Factor.
- (2) Margin Level = Measurement Value - Limit Value.

Test Mode	UNII-3_TX AC(VHT40) Mode 5795 MHz	Polarization	Vertical
-----------	-----------------------------------	--------------	----------

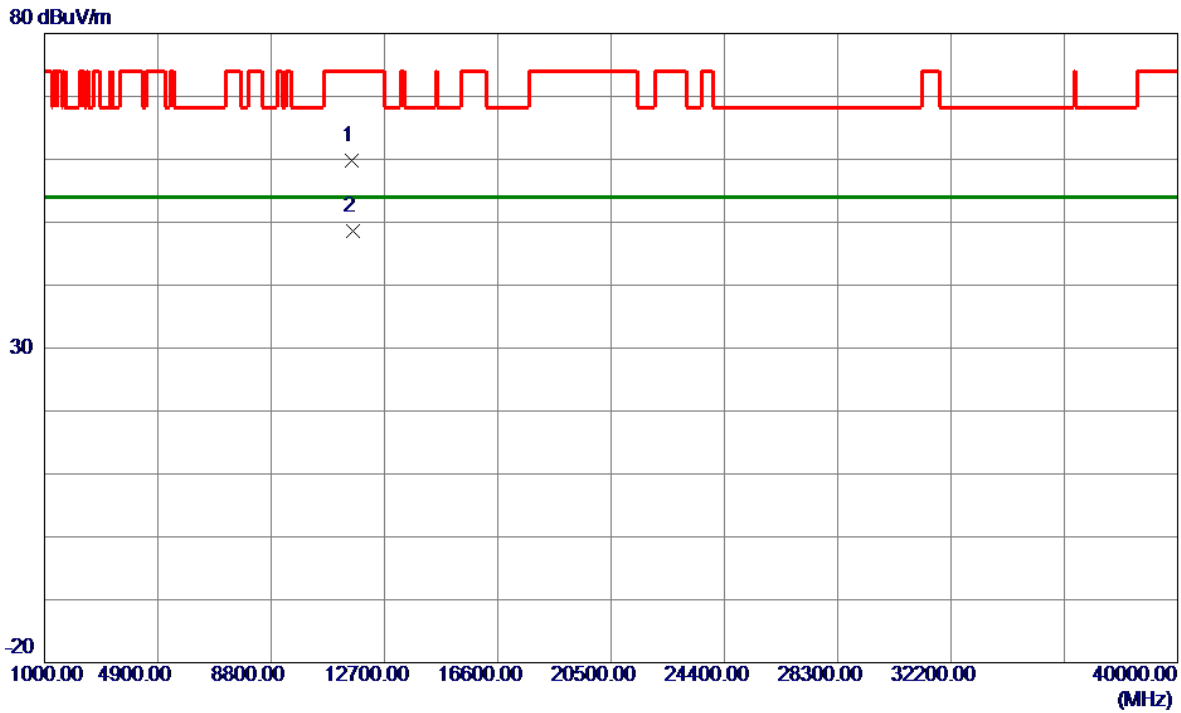

No.	Freq. MHz	Reading Level dBuV/m	Correct Factor dB	Measure ment dBuV/m	Limit dBuV/m	Margin dB	Detector	Comment
1	11592.4100	53.02	6.73	59.75	74.00	-14.25	Peak	
2 *	11595.3200	41.93	6.73	48.66	54.00	-5.34	AVG	

**REMARKS:**

- (1) Measurement Value = Reading Level + Correct Factor.
- (2) Margin Level = Measurement Value - Limit Value.

Test Mode	UNII-3_TX AC(VHT80) Mode 5775 MHz	Polarization	Vertical
-----------	-----------------------------------	--------------	----------

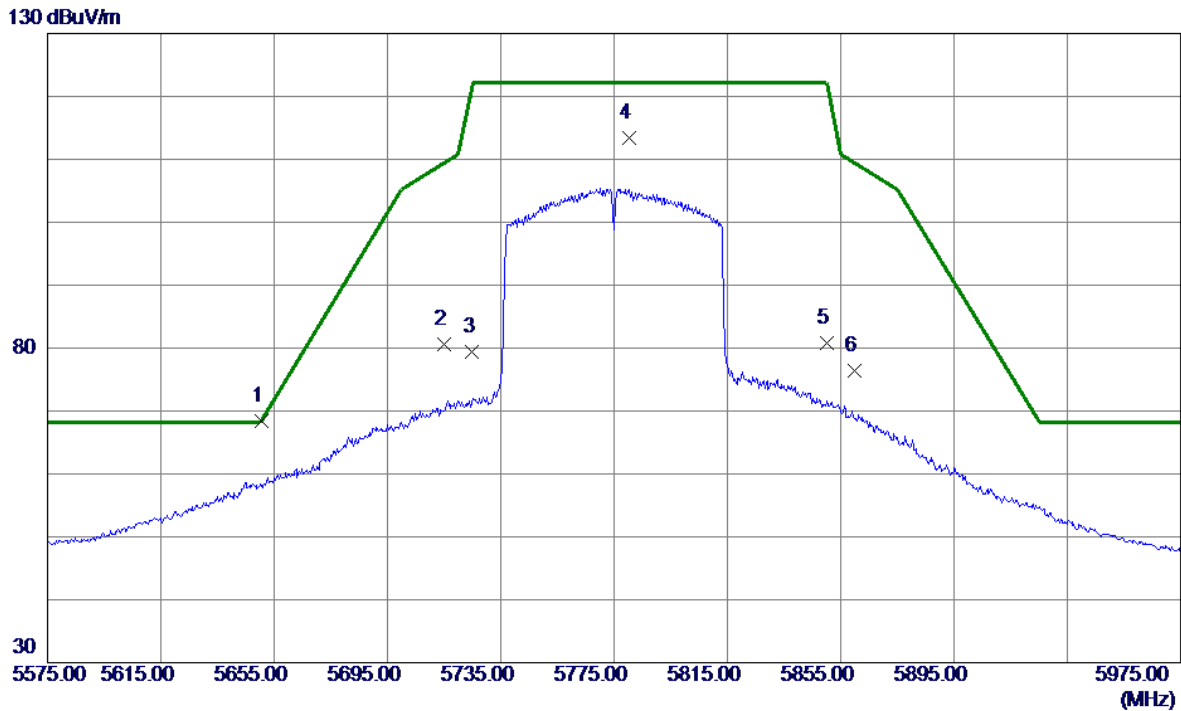

No.	Freq. MHz	Reading Level dBuV/m	Correct Factor dB	Measure ment dBuV/m	Limit dBuV/m	Margin dB	Detector	Comment
1 *	5650.6000	55.35	13.01	68.36	68.64	-0.28	Peak	
2	5715.0000	67.39	13.21	80.60	109.40	-28.80	Peak	
3	5725.0000	66.18	13.24	79.42	122.20	-42.78	Peak	
4	5780.2000	100.05	13.40	113.45	122.20	-8.75	Peak	No Limit
5	5850.0000	67.10	13.62	80.72	122.20	-41.48	Peak	
6	5860.0000	62.81	13.65	76.46	109.40	-32.94	Peak	

**REMARKS:**

- (1) Measurement Value = Reading Level + Correct Factor.
- (2) Margin Level = Measurement Value - Limit Value.

Test Mode	UNII-3_TX AC(VHT80) Mode 5775 MHz	Polarization	Vertical
-----------	-----------------------------------	--------------	----------

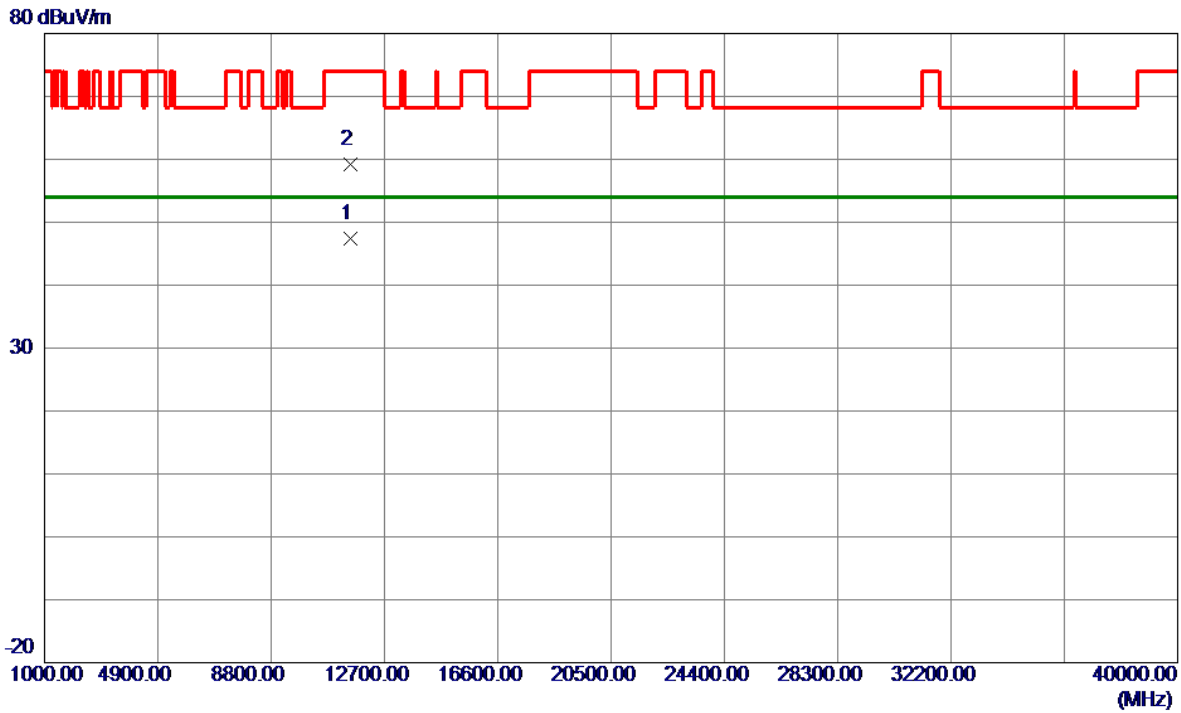

No.	Freq. MHz	Reading Level dBuV/m	Correct Factor dB	Measure ment dBuV/m	Limit dBuV/m	Margin dB	Detector	Comment
1 *	11550.1400	40.74	6.74	47.48	54.00	-6.52	AVG	
2	11550.2500	52.53	6.74	59.27	74.00	-14.73	Peak	

**REMARKS:**

- (1) Measurement Value = Reading Level + Correct Factor.
- (2) Margin Level = Measurement Value - Limit Value.



Test Mode	UNII-3_TX AX(HE20) Mode 5745 MHz	Polarization	Vertical
-----------	----------------------------------	--------------	----------

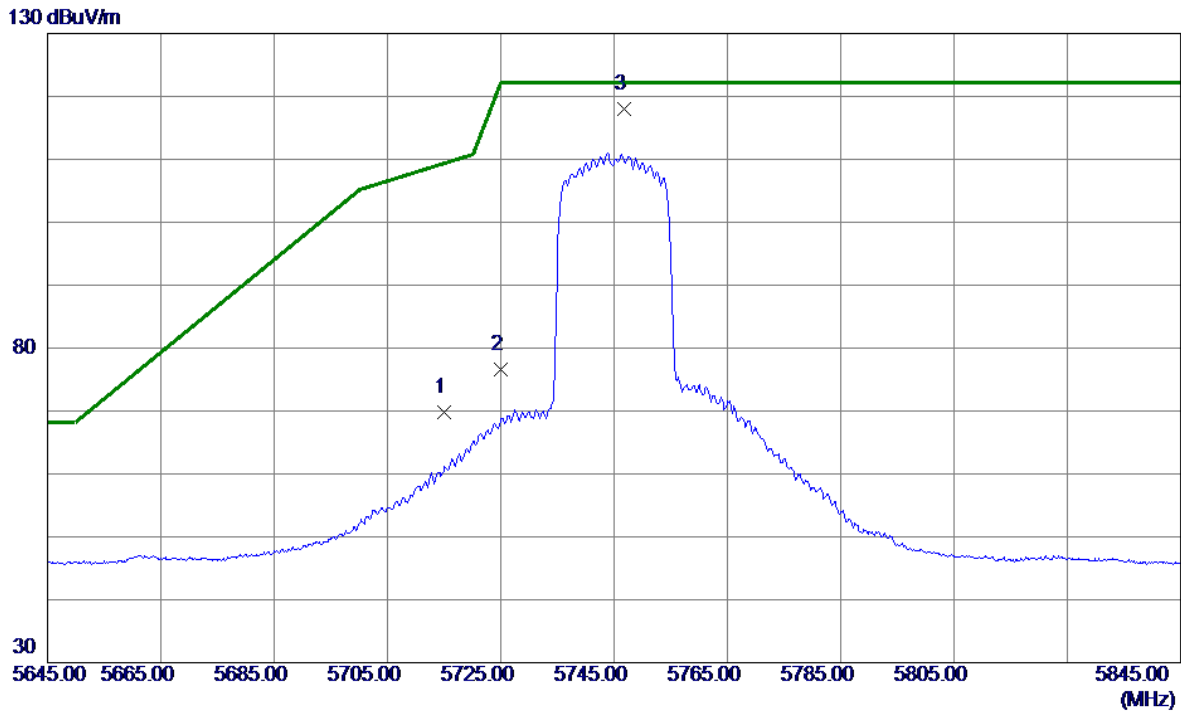

No.	Freq. MHz	Reading Level dBuV/m	Correct Factor dB	Measure ment dBuV/m	Limit dBuV/m	Margin dB	Detector	Comment
1	5715.0000	56.62	13.21	69.83	109.40	-39.57	Peak	
2	5725.0000	63.32	13.24	76.56	122.20	-45.64	Peak	
3 *	5746.8000	104.60	13.30	117.90	122.20	-4.30	Peak	No Limit

**REMARKS:**

- (1) Measurement Value = Reading Level + Correct Factor.
- (2) Margin Level = Measurement Value - Limit Value.

Test Mode	UNII-3_TX AX(HE20) Mode 5745 MHz	Polarization	Vertical
-----------	----------------------------------	--------------	----------

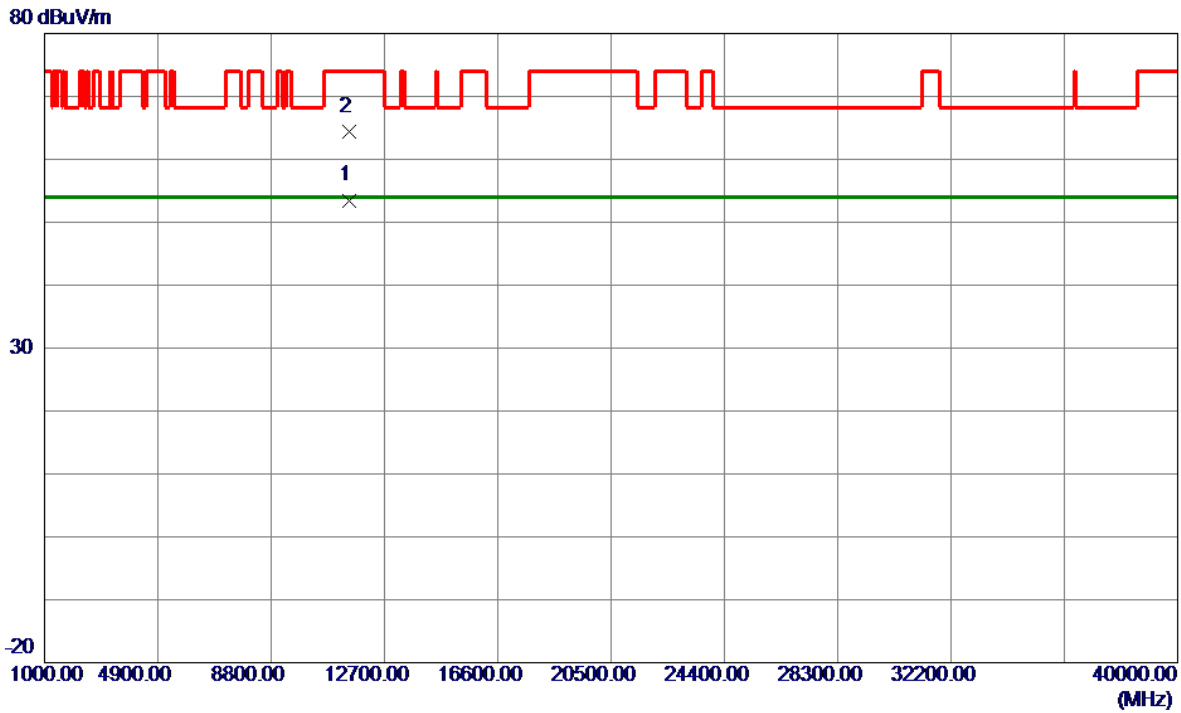

No.	Freq. MHz	Reading Level dBuV/m	Correct Factor dB	Measure ment dBuV/m	Limit dBuV/m	Margin dB	Detector	Comment
1 *	11487.7100	46.76	6.74	53.50	54.00	-0.50	AVG	
2	11488.1000	57.74	6.74	64.48	74.00	-9.52	Peak	

**REMARKS:**

- (1) Measurement Value = Reading Level + Correct Factor.
- (2) Margin Level = Measurement Value - Limit Value.

Test Mode	UNII-3_TX AX(HE20) Mode 5785 MHz	Polarization	Vertical
-----------	----------------------------------	--------------	----------

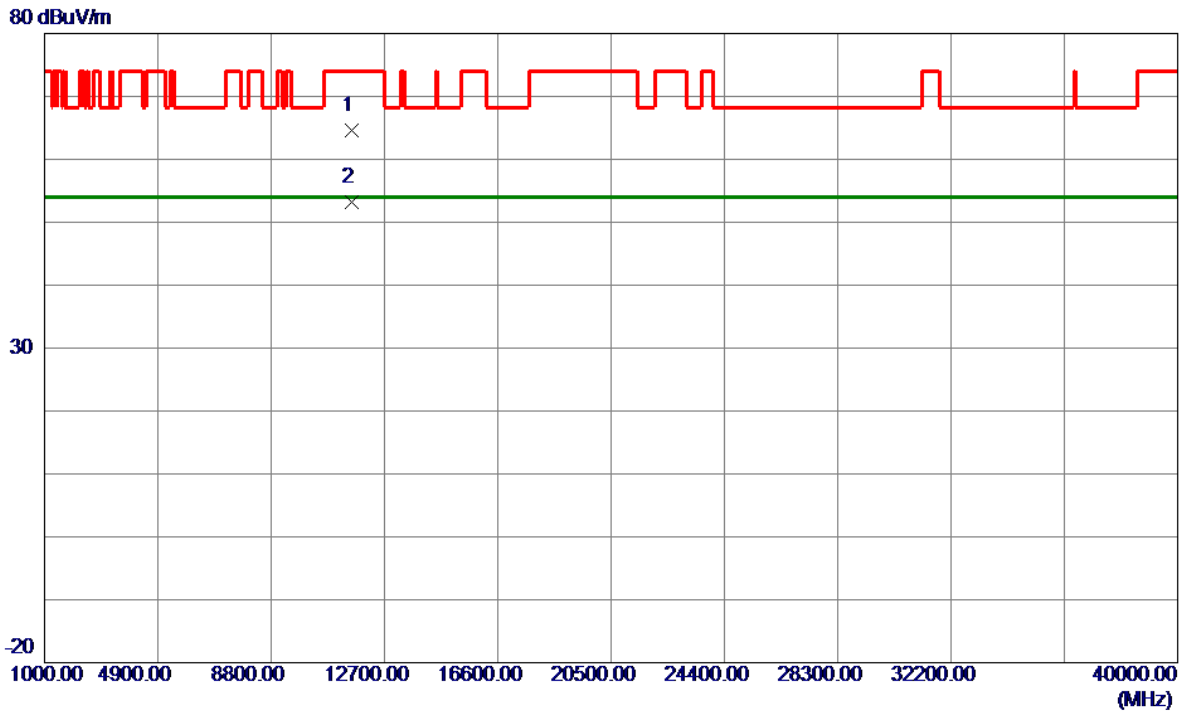

No.	Freq. MHz	Reading Level dBuV/m	Correct Factor dB	Measure ment dBuV/m	Limit dBuV/m	Margin dB	Detector	Comment
1	11567.7500	57.83	6.74	64.57	74.00	-9.43	Peak	
2 *	11570.4600	46.51	6.74	53.25	54.00	-0.75	AVG	

**REMARKS:**

- (1) Measurement Value = Reading Level + Correct Factor.
- (2) Margin Level = Measurement Value - Limit Value.

Test Mode	UNII-3_TX AX(HE20) Mode 5825 MHz	Polarization	Vertical
-----------	----------------------------------	--------------	----------

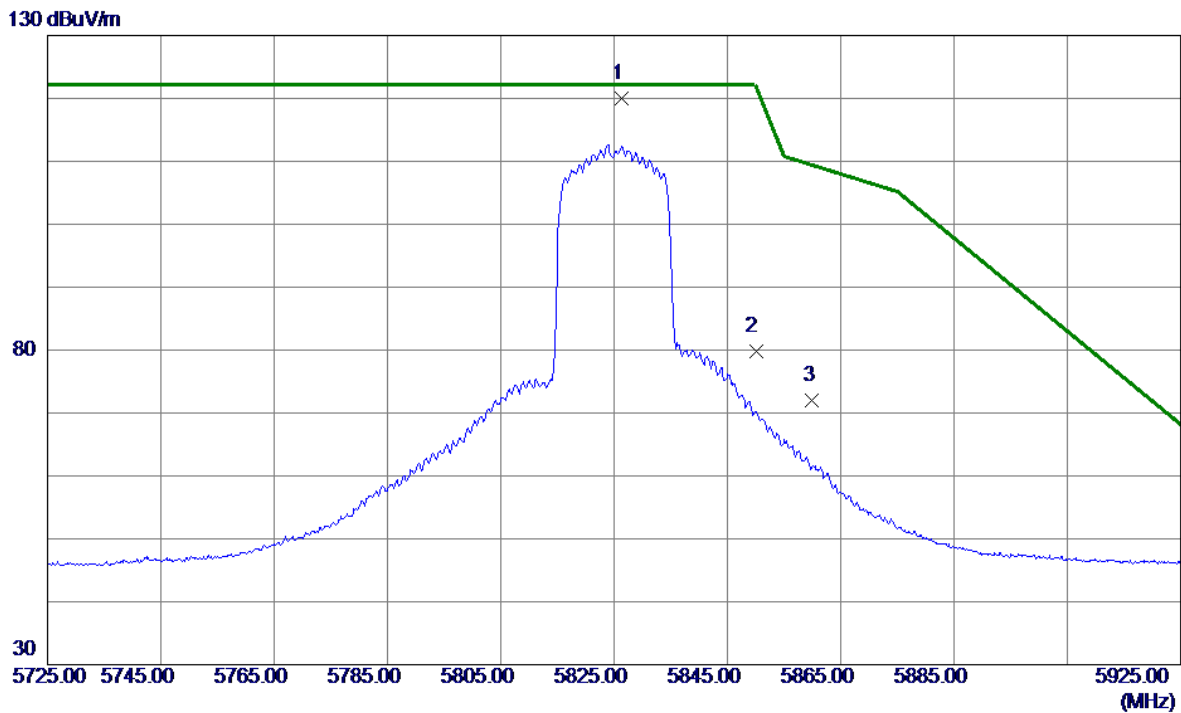

No.	Freq. MHz	Reading Level dBuV/m	Correct Factor dB	Measure ment dBuV/m	Limit dBuV/m	Margin dB	Detector	Comment
1 *	5826.4000	106.54	13.54	120.08	122.20	-2.12	Peak	No Limit
2	5850.0000	66.17	13.62	79.79	122.20	-42.41	Peak	
3	5860.0000	58.28	13.65	71.93	109.40	-37.47	Peak	

REMARKS:

- (1) Measurement Value = Reading Level + Correct Factor.
- (2) Margin Level = Measurement Value - Limit Value.

Test Mode	UNII-3_TX AX(HE20) Mode 5825 MHz	Polarization	Vertical
-----------	----------------------------------	--------------	----------

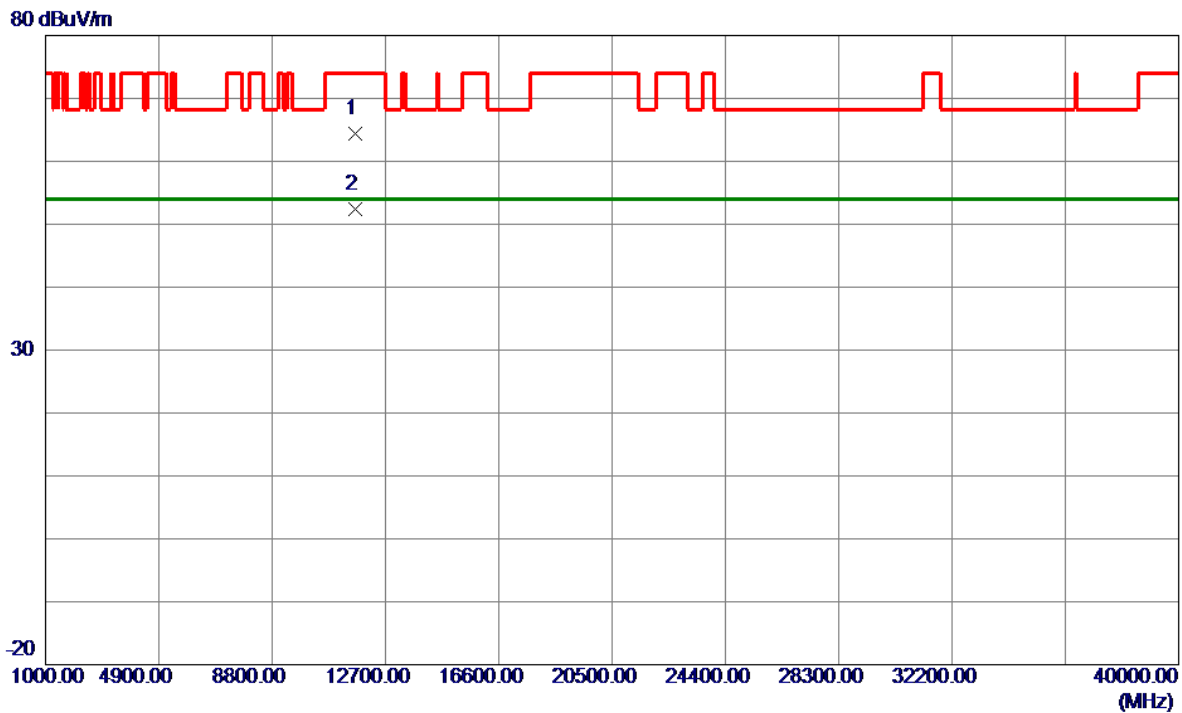

No.	Freq. MHz	Reading Level dBuV/m	Correct Factor dB	Measure ment dBuV/m	Limit dBuV/m	Margin dB	Detector	Comment
1	11645.3900	57.68	6.72	64.40	74.00	-9.60	Peak	
2 *	11650.4900	45.75	6.71	52.46	54.00	-1.54	AVG	

**REMARKS:**

- (1) Measurement Value = Reading Level + Correct Factor.
- (2) Margin Level = Measurement Value - Limit Value.

Test Mode	UNII-3_TX AX(HE40) Mode 5755 MHz	Polarization	Vertical
-----------	----------------------------------	--------------	----------

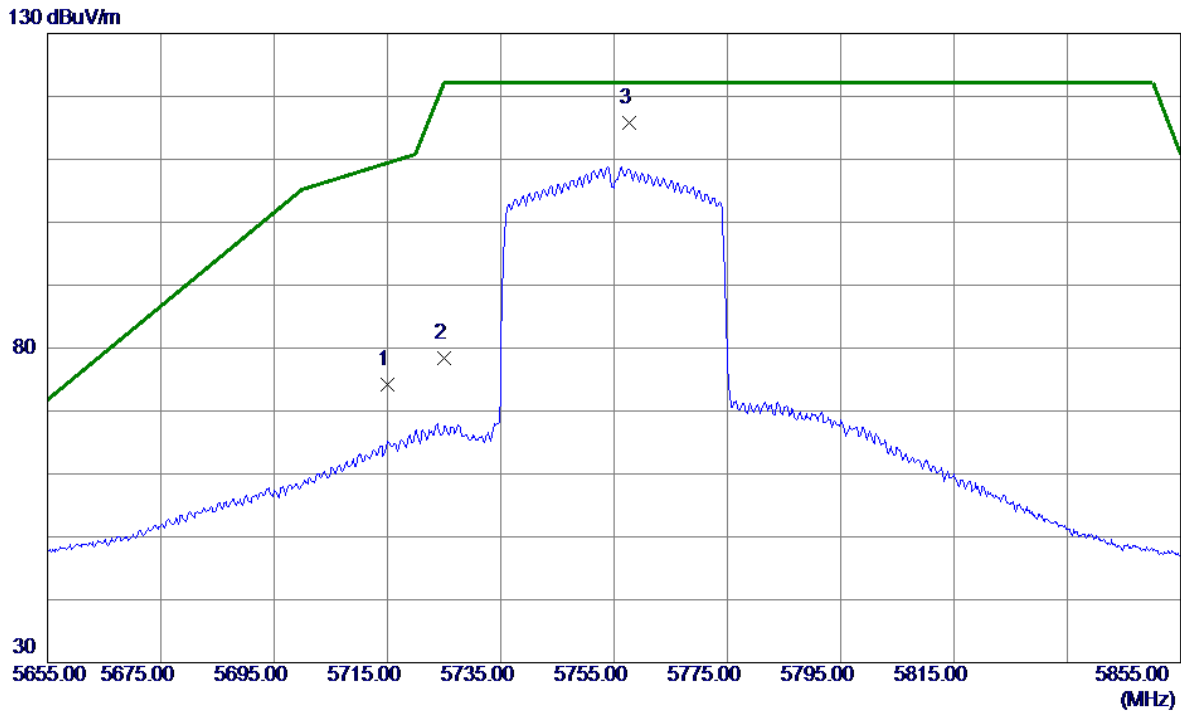

No.	Freq. MHz	Reading Level dBuV/m	Correct Factor dB	Measure ment dBuV/m	Limit dBuV/m	Margin dB	Detector	Comment
1	5715.0000	60.99	13.21	74.20	109.40	-35.20	Peak	
2	5725.0000	65.17	13.24	78.41	122.20	-43.79	Peak	
3 *	5757.7000	102.41	13.34	115.75	122.20	-6.45	Peak	No Limit

REMARKS:

- (1) Measurement Value = Reading Level + Correct Factor.
- (2) Margin Level = Measurement Value - Limit Value.

Test Mode	UNII-3_TX AX(HE40) Mode 5755 MHz	Polarization	Vertical
-----------	----------------------------------	--------------	----------

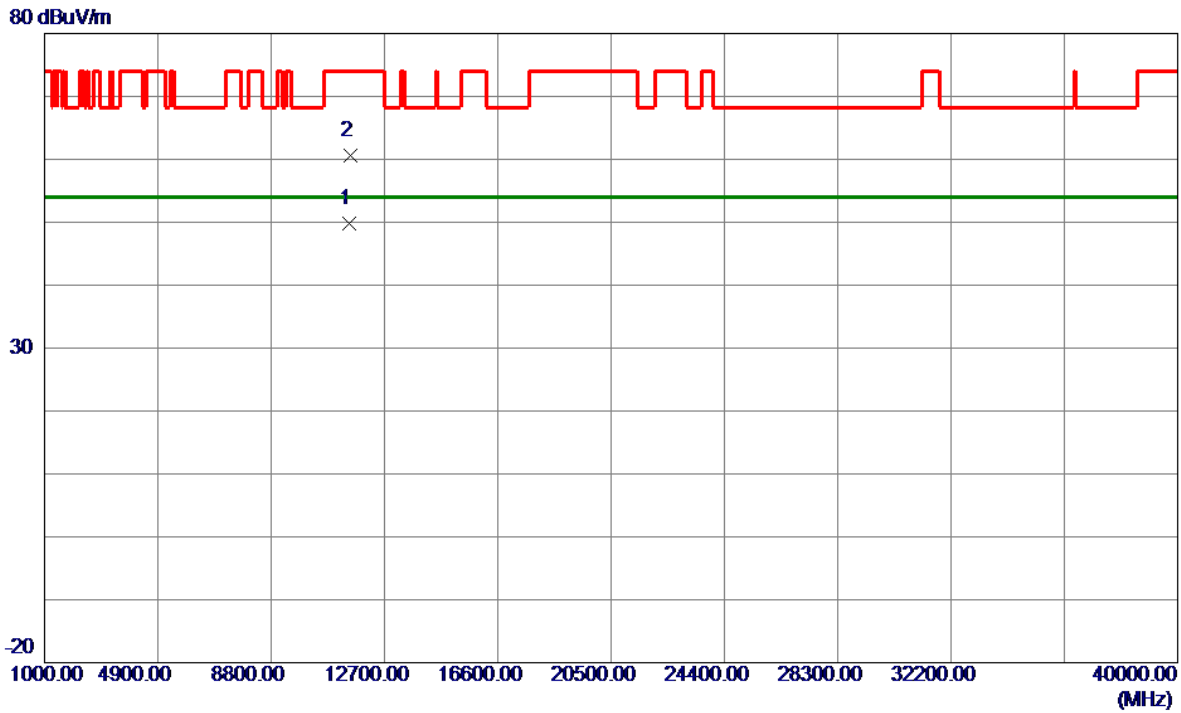

No.	Freq. MHz	Reading Level dBuV/m	Correct Factor dB	Measure ment dBuV/m	Limit dBuV/m	Margin dB	Detector	Comment
1 *	11507.6300	43.13	6.75	49.88	54.00	-4.12	AVG	
2	11512.6700	53.94	6.75	60.69	74.00	-13.31	Peak	

**REMARKS:**

- (1) Measurement Value = Reading Level + Correct Factor.
- (2) Margin Level = Measurement Value - Limit Value.

Test Mode	UNII-3_TX AX(HE40) Mode 5795 MHz	Polarization	Vertical
-----------	----------------------------------	--------------	----------

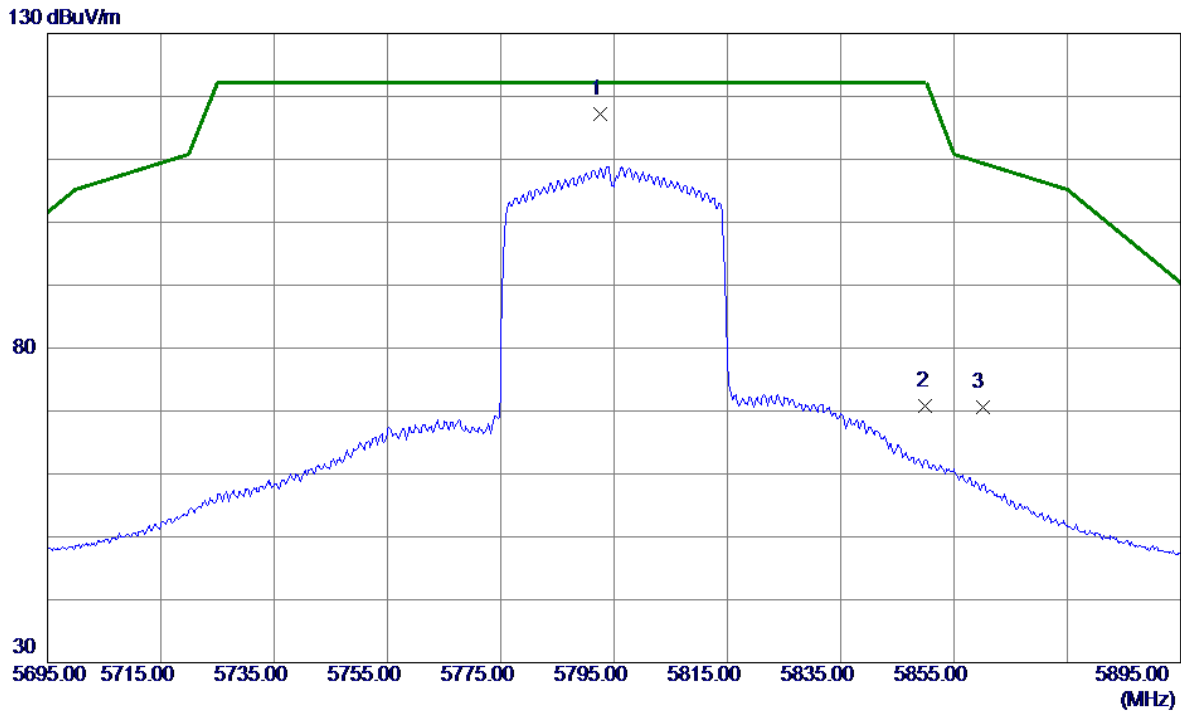

No.	Freq. MHz	Reading Level dBuV/m	Correct Factor dB	Measure ment dBuV/m	Limit dBuV/m	Margin dB	Detector	Comment
1 *	5792.6000	103.84	13.44	117.28	122.20	-4.92	Peak	No Limit
2	5850.0000	57.22	13.62	70.84	122.20	-51.36	Peak	
3	5860.0000	57.02	13.65	70.67	109.40	-38.73	Peak	

REMARKS:

- (1) Measurement Value = Reading Level + Correct Factor.
- (2) Margin Level = Measurement Value - Limit Value.



Test Mode	UNII-3_TX AX(HE40) Mode 5795 MHz	Polarization	Vertical
-----------	----------------------------------	--------------	----------

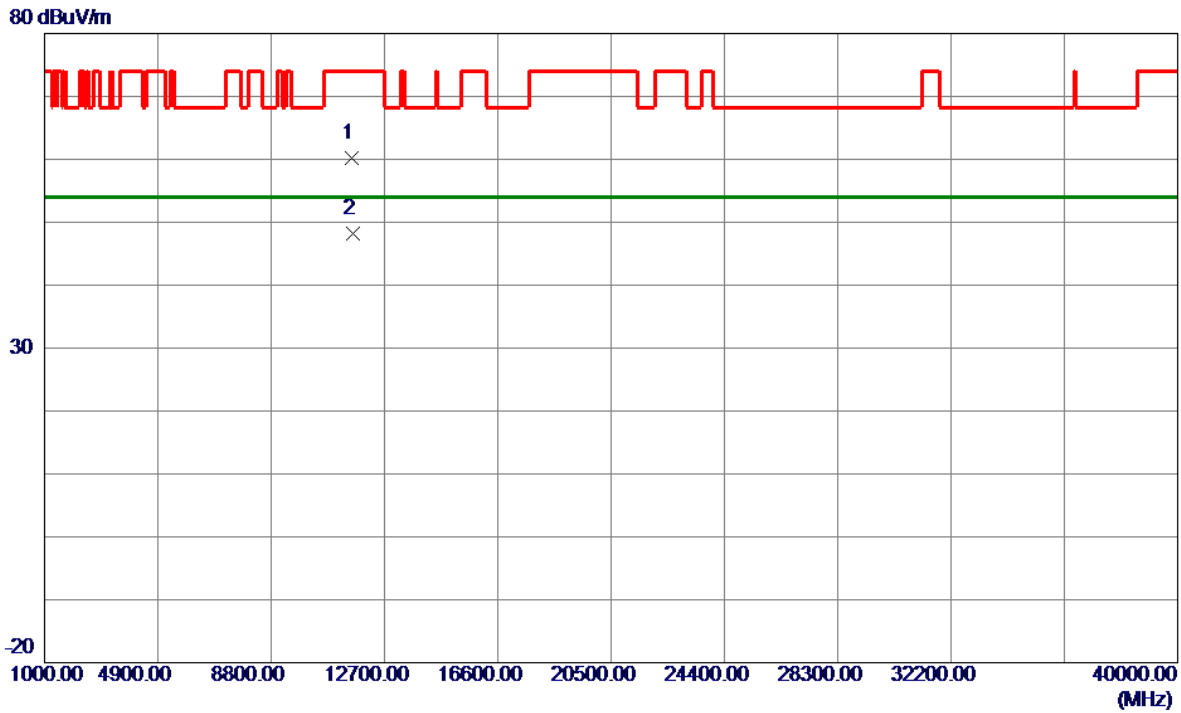

No.	Freq. MHz	Reading Level dBuV/m	Correct Factor dB	Measure ment dBuV/m	Limit dBuV/m	Margin dB	Detector	Comment
1	11592.5599	53.48	6.73	60.21	74.00	-13.79	Peak	
2 *	11595.1800	41.53	6.73	48.26	54.00	-5.74	AVG	

**REMARKS:**

- (1) Measurement Value = Reading Level + Correct Factor.
- (2) Margin Level = Measurement Value - Limit Value.

Test Mode	UNII-3_TX AX(HE80) Mode 5775 MHz	Polarization	Vertical
-----------	----------------------------------	--------------	----------

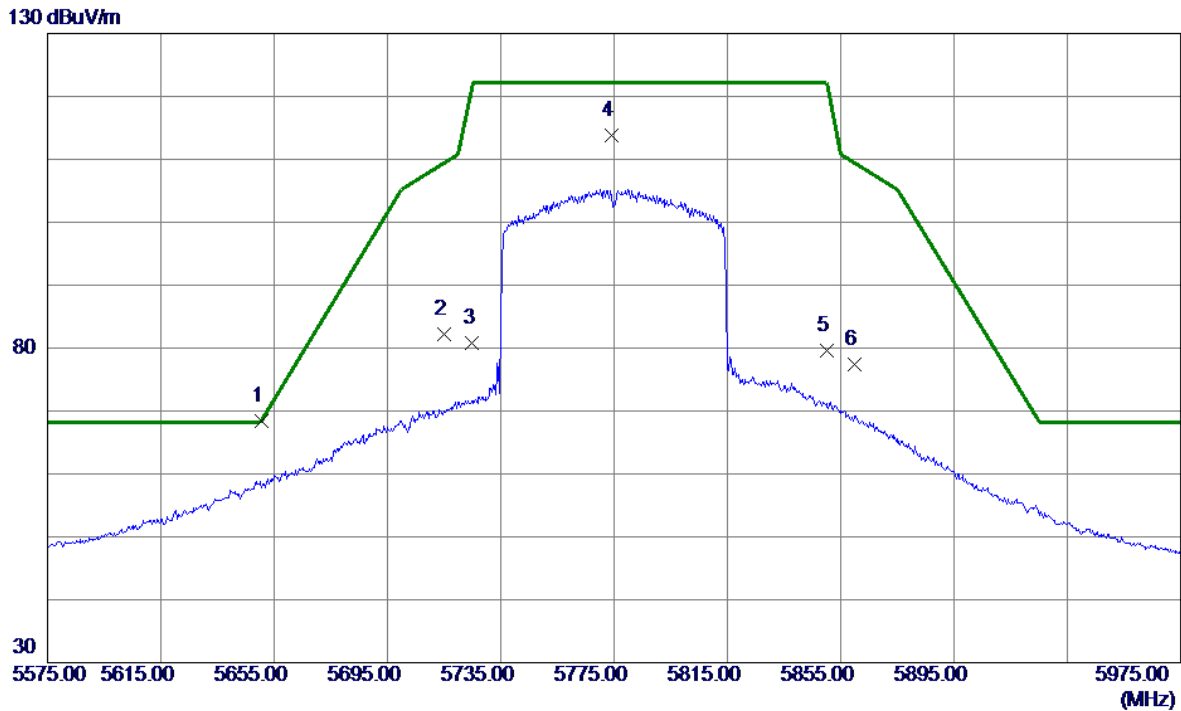

No.	Freq. MHz	Reading Level dBuV/m	Correct Factor dB	Measure ment dBuV/m	Limit dBuV/m	Margin dB	Detector	Comment
1 *	5650.6000	55.44	13.01	68.45	68.64	-0.19	Peak	
2	5715.0000	68.98	13.21	82.19	109.40	-27.21	Peak	
3	5725.0000	67.64	13.24	80.88	122.20	-41.32	Peak	
4	5774.2000	100.43	13.39	113.82	122.20	-8.38	Peak	No Limit
5	5850.0000	66.03	13.62	79.65	122.20	-42.55	Peak	
6	5860.0000	63.79	13.65	77.44	109.40	-31.96	Peak	

REMARKS:

- (1) Measurement Value = Reading Level + Correct Factor.
- (2) Margin Level = Measurement Value - Limit Value.

Test Mode	UNII-3_TX AX(HE80) Mode 5775 MHz	Polarization	Vertical
-----------	----------------------------------	--------------	----------

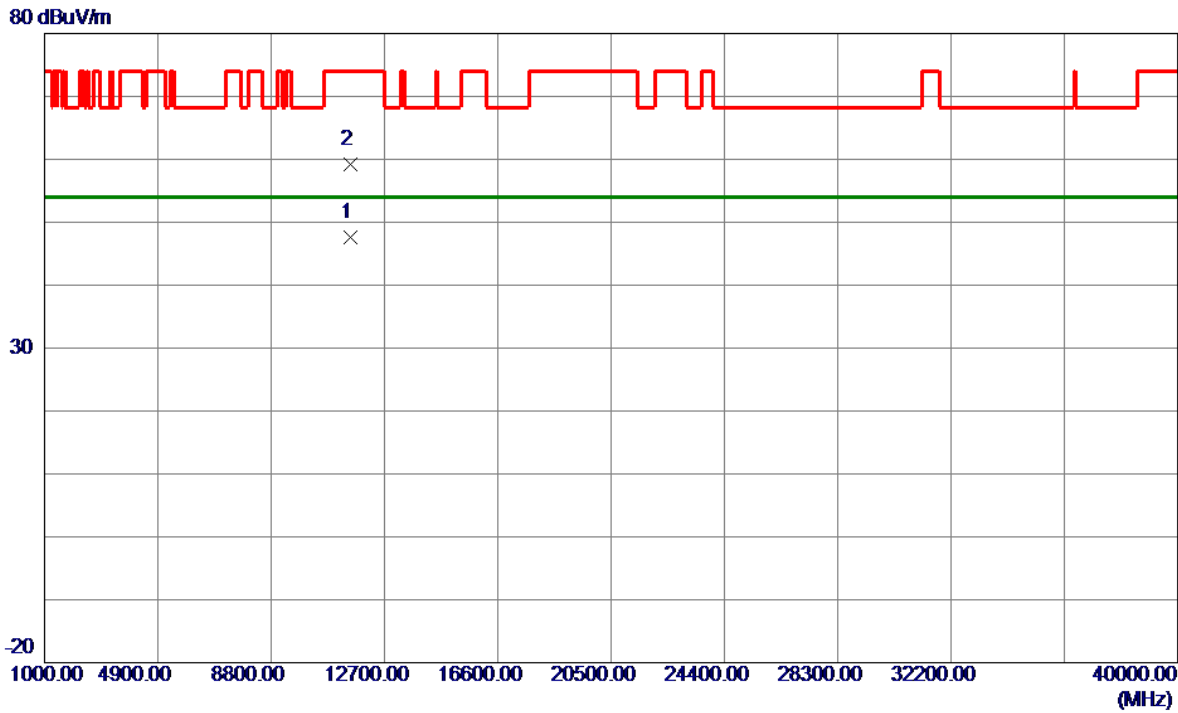

No.	Freq. MHz	Reading Level dBuV/m	Correct Factor dB	Measure ment dBuV/m	Limit dBuV/m	Margin dB	Detector	Comment
1 *	11550.1800	40.77	6.74	47.51	54.00	-6.49	AVG	
2	11550.3099	52.54	6.74	59.28	74.00	-14.72	Peak	

**REMARKS:**

- (1) Measurement Value = Reading Level + Correct Factor.
- (2) Margin Level = Measurement Value - Limit Value.

## APPENDIX E - BANDWIDTH

Test Mode	UNII-1_TX A Mode
-----------	------------------

Channel	Frequency (MHz)	26 dB Bandwidth (MHz)	99 % Occupied Bandwidth (MHz)
36	5180	35.488	19.000
40	5200	35.790	19.500
48	5240	37.490	22.000

### CH36

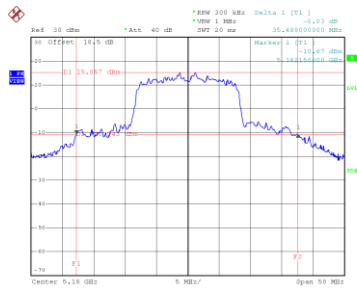

Date: 21.DEC.2023 17:24:37

### CH40

26 dB Bandwidth

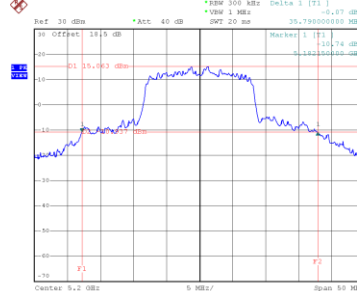

Date: 21.DEC.2023 17:26:21

### CH48

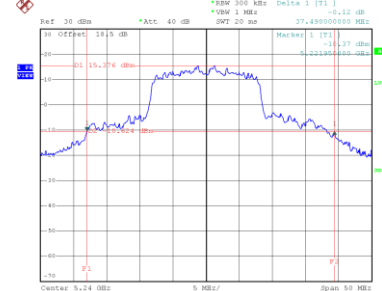

Date: 21.DEC.2023 17:27:37

### 99 % Occupied Bandwidth

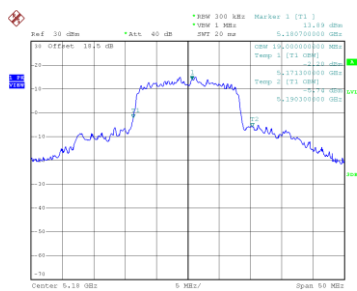

Date: 21.DEC.2023 17:24:05

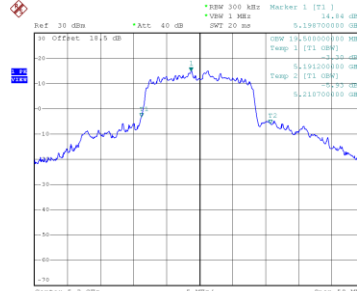

Date: 21.DEC.2023 17:25:14

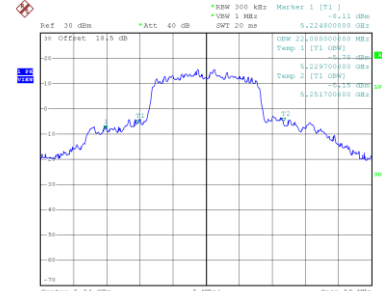

Date: 21.DEC.2023 17:27:15

Test Mode	UNII-1_TX AC(VHT20) Mode
-----------	--------------------------

Channel	Frequency (MHz)	26 dB Bandwidth (MHz)	99 % Occupied Bandwidth (MHz)
36	5180	19.309	17.400
40	5200	19.450	17.400
48	5240	19.350	17.400

### CH36

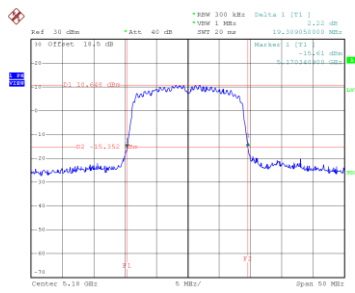

Date: 21.DEC.2023 17:32:35

### CH40 26 dB Bandwidth

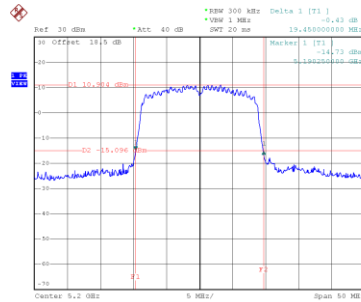

Date: 21.DEC.2023 17:33:36

### CH48

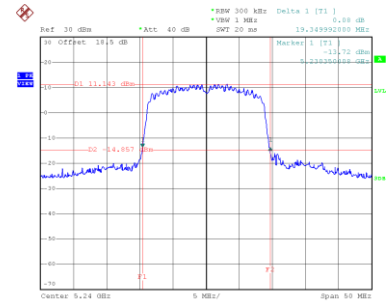

Date: 21.DEC.2023 17:34:41

### 99 % Occupied Bandwidth

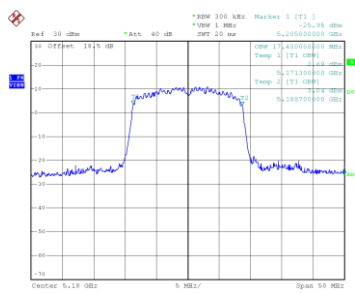

Date: 21.DEC.2023 17:31:52

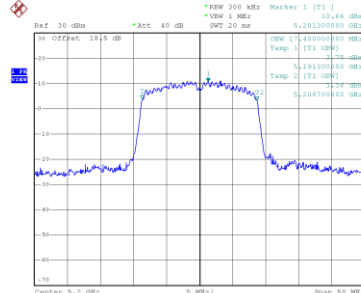

Date: 21.DEC.2023 17:32:54

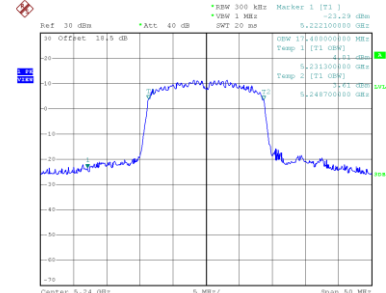

Date: 21.DEC.2023 17:33:59